

Sterling Warehouse Management System: Configuration Guide

Release 9.0

Last updated in HF 20

March 2011



Copyright Notice

Copyright © 1999 - 2010

Sterling Commerce, Inc.

ALL RIGHTS RESERVED

STERLING COMMERCE SOFTWARE

TRADE SECRET NOTICE

THE STERLING COMMERCE SOFTWARE DESCRIBED BY THIS DOCUMENTATION ("STERLING COMMERCE SOFTWARE") IS THE CONFIDENTIAL AND TRADE SECRET PROPERTY OF STERLING COMMERCE, INC., ITS AFFILIATED COMPANIES OR ITS OR THEIR LICENSORS, AND IS PROVIDED UNDER THE TERMS OF A LICENSE AGREEMENT. NO DUPLICATION OR DISCLOSURE WITHOUT PRIOR WRITTEN PERMISSION. RESTRICTED RIGHTS.

This documentation, the Sterling Commerce Software it describes, and the information and know-how they contain constitute the proprietary, confidential and valuable trade secret information of Sterling Commerce, Inc., its affiliated companies or its or their licensors, and may not be used for any unauthorized purpose, or disclosed to others without the prior written permission of the applicable Sterling Commerce entity. This documentation and the Sterling Commerce Software that it describes have been provided pursuant to a license agreement that contains prohibitions against and/or restrictions on their copying, modification and use. Duplication, in whole or in part, if and when permitted, shall bear this notice and the Sterling Commerce, Inc. copyright notice.

U.S. GOVERNMENT RESTRICTED RIGHTS. This documentation and the Sterling Commerce Software it describes are "commercial items" as defined in 48 C.F.R. 2.101. As and when provided to any agency or instrumentality of the U.S. Government or to a U.S. Government prime contractor or a subcontractor at any tier ("Government Licensee"), the terms and conditions of the customary Sterling Commerce commercial license agreement are imposed on Government Licensees per 48 C.F.R. 12.212 or 227.7202 through 227.7202-4, as applicable, or through 48 C.F.R. § 52.244-6.

This Trade Secret Notice, including the terms of use herein is governed by the laws of the State of Ohio, USA, without regard to its conflict of laws provisions. If you are accessing the Sterling Commerce Software under an executed agreement, then nothing in these terms and conditions supersedes or modifies the executed agreement.

Sterling Commerce, Inc.
4600 Lakehurst Court
Dublin, Ohio 43016-2000

Copyright © 1999 - 2010

Third-Party Software

Portions of the Sterling Commerce Software may include products, or may be distributed on the same storage media with products, ("Third Party Software") offered by third parties ("Third Party Licensors"). Sterling Commerce Software may include Third Party Software covered by the following copyrights: Copyright © 2006-2008 Andres Almiray. Copyright © 1999-2005 The Apache Software Foundation. Erik Arvidsson. Copyright © 2008 Azer Koçulu <http://azer.kodfabrik.com>. Copyright © Einar Lielmanis, einars@gmail.com. Copyright © 2006 John Reilly (www.inconspicuous.org) and Copyright © 2002 Douglas Crockford (www.crockford.com). Copyright © 2009 John Resig, <http://jquery.com/>. Copyright © 2006-2008 Json-lib. Copyright © 2001 LOOX Software, Inc. Copyright © 2003-2008 Luck Consulting Pty. Ltd. Copyright 2002-2004 © MetaStuff, Ltd. Copyright © 2009 Michael Mathews micmath@gmail.com. Copyright © 1999-2005 Northwoods Software Corporation. Copyright © Microsoft Corp. 1981-1998. Purple Technology, Inc. Copyright © 2004-2008 QOS.ch. Copyright © 2005 Sabre Airline Solutions. Copyright © 2004 SoftComplex, Inc. Copyright © 2000-2007 Sun Microsystems, Inc. Copyright © 2001 VisualSoft Technologies Limited. Copyright © 2001 Zero G Software, Inc. All rights reserved by all listed parties.

The Sterling Commerce Software is distributed on the same storage media as certain Third Party Software covered by the following copyrights: Copyright © 1999-2006 The Apache Software Foundation. Copyright © 2001-2003 Ant-Contrib project. Copyright © 1998-2007 Bela Ban. Copyright © 2005 Eclipse Foundation. Copyright © 2002-2006 Julian Hyde and others. Copyright © 2006-2009 Ext JS, Inc. Copyright © 1997 ICE Engineering, Inc./Timothy Gerard Endres. Copyright 2000, 2006 IBM Corporation and others. Copyright © 1987-2006 ILOG, Inc. Copyright © 2000-2006 Infragistics. Copyright © 2002-2005 JBoss, Inc. Copyright LuMriX.net GmbH, Switzerland. Copyright © 1998-2009 Mozilla.org. Copyright © 2003-2009 Mozdev Group, Inc. Copyright © 1999-2002 JBoss.org. Copyright © 2007, the OWASP Foundation. Copyright Raghu K, 2003. Copyright © 2004 David Schweinsberg. Copyright © 2005-2006 Darren L. Spurgeon. Copyright © 2005-2008 Sam Stephenson. Copyright © S.E. Morris (FISH) 2003-04. Copyright © 1998 Regents of the University of California. Copyright © 2006 VisualSoft Technologies. Copyright © 2002-2009 Zipwise Software. All rights reserved by all listed parties.

Third Party Software which is included, or are distributed on the same storage media with, the Sterling Commerce Software where use, duplication, or disclosure by the United States government or a government contractor or subcontractor, are provided with RESTRICTED RIGHTS under Title 48 CFR 2.101, 12.212, 52.227-19, 227.7201 through 227.7202-4, DFAR 252.227-7013(c) (1) (ii) and (2), DFAR 252.227-7015(b)(6/95), DFAR 227.7202-3(a), FAR 52.227-14(g)(2)(6/87), and FAR 52.227-19(c)(2) and (6/87) as applicable.

Additional information regarding certain Third Party Software is located at `installdir/SCI_License.txt`.

Some Third Party Licensors also provide license information and/or source code for their software via their respective links set forth below:

<http://danadler.com/jacob/>

<http://www.dom4j.org>

This product includes software developed by the Apache Software Foundation (<http://www.apache.org>). This product includes software developed by the Ant-Contrib project (<http://sourceforge.net/projects/ant-contrib>). This product includes software developed by the JDOM Project (<http://www.jdom.org/>). This product includes code licensed from RSA Data Security (via Sun Microsystems, Inc.). Sun, Sun Microsystems, the Sun Logo, Java, JDK, the Java Coffee Cup logo, JavaBeans, JDBC, JMX and all JMX based trademarks and logos are trademarks or registered trademarks of Sun Microsystems, Inc. All other trademarks and logos are trademarks of their respective owners.

THE APACHE SOFTWARE FOUNDATION SOFTWARE

The Sterling Commerce Software is distributed with or on the same storage media as the following software products (or components thereof) and java source code files: Xalan version 2.5.2, Cookie.java, Header.java, HeaderElement.java, HttpException.java, HttpState.java, NameValuePair.java, CronTimeTrigger.java, DefaultTimeScheduler.java, PeriodicTimeTrigger.java, Target.java, TimeScheduledEntry.java, TimeScheduler.java, TimeTrigger.java, Trigger.java, BinaryHeap.java,

PriorityQueue.java, SynchronizedPriorityQueue.java, GetOpt.java, GetOptsException.java, IllegalArgumentException.java, MissingOptArgException.java (collectively, "Apache 1.1 Software"). Apache 1.1 Software is free software which is distributed under the terms of the following license:

License Version 1.1

Copyright 1999-2003 The Apache Software Foundation. All rights reserved.

Redistribution and use in source and binary forms, with or without modification, are permitted provided that the following conditions are met:

1. Redistributions of source code must retain the above copyright notice, this list of conditions and the following disclaimer.
2. Redistribution in binary form must reproduce the above copyright notice, this list of conditions and the following disclaimer in the documentation and/or other materials provided with the distribution.
3. The end-user documentation included with the redistribution, if any, must include the following acknowledgement: "This product includes software developed by the Apache Software Foundation (<http://www.apache.org>)." Alternatively, this acknowledgement may appear in the software itself, if and whenever such third-party acknowledgements normally appear.
4. The names "Commons", "Jakarta", "The Jakarta Project", "HttpClient", "log4j", "Xerces "Xalan", "Avalon", "Apache Avalon", "Avalon Cornerstone", "Avalon Framework", "Apache" and "Apache Software Foundation" must not be used to endorse or promote products derived from this software without specific prior written permission. For written permission, please contact apache@apache.org.
5. Products derived from this software may not be called "Apache", nor may "Apache" appear in their name, without the prior written permission of the Apache Software Foundation.

THIS SOFTWARE IS PROVIDED "AS IS" AND ANY EXPRESS OR IMPLIED WARRANTIES, INCLUDING ANY IMPLIED WARRANTY OF MERCHANTABILITY, AND FITNESS FOR A PARTICULAR PURPOSE ARE DISCLAIMED. IN NO EVENT SHALL APACHE SOFTWARE FOUNDATION OR ITS CONTRIBUTORS BE LIABLE FOR ANY DIRECT, INDIRECT, INCIDENTAL, SPECIAL, EXEMPLARY, OR CONSEQUENTIAL DAMAGES (INCLUDING BUT NOT LIMITED TO, PROCUREMENT OF SUBSTITUTE GOODS OR SERVICES; LOSS OF USE, DATA, OR PROFITS; OR BUSINESS INTERRUPTION) HOWEVER CAUSED AND ON ANY THEORY OF LIABILITY, WHETHER IN CONTRACT, STRICT LIABILITY, OR TORT (INCLUDING NEGLIGENCE OR OTHERWISE) ARISING IN ANY WAY OUT OF THE USE OF THIS SOFTWARE, EVEN IF ADVISED OF THE POSSIBILITY OF SUCH DAMAGE.

This software consists of voluntary contributions made by many individuals on behalf of the Apache Software Foundation. The GetOpt.java, GetOptsException.java, IllegalArgumentException.java and MissingOptArgException.java software was originally based on software copyright © 2001, Sun Microsystems, <http://www.sun.com>. For more information on the Apache Software Foundation, please see <http://www.apache.org/>.

The preceding license only applies to the Apache 1.1 Software and does not apply to the Sterling Commerce Software or to any other Third Party Software.

The Sterling Commerce Software is also distributed with or on the same storage media as the following software products (or components thereof): Ant, Antinstaller, Apache File Upload Package, Apache Commons Beans, Apache Commons BetWixt, Apache Commons Collection, Apache Commons Digester, Apache Commons IO, Apache Commons Lang., Apache Commons Logging, Apache Commons Net, Apache Jakarta Commons Pool, Apache Jakarta ORO, Lucene, Xerces version 2.7, Apache Log4J, Apache SOAP, Apache Struts and Apache Xalan 2.7.0, (collectively, "Apache 2.0 Software"). Apache 2.0 Software is free software which is distributed under the terms of the Apache License Version 2.0. A copy of License Version 2.0 is found in the following directory files for the individual pieces of the Apache 2.0 Software: `installdir/jar/commons_upload/1_0/ CommonsFileUpload_License.txt`, `installdir/jar/jetspeed/1_4/RegExp_License.txt`, `installdir/ant/Ant_License.txt`
<install>/jar/antInstaller/0_8/antinstaller_License.txt
<install>/jar/commons_beanutils/1_7_0/commons-beanutils.jar (/META-INF/LICENSE.txt)
<install>/jar/commons_betwixt/0_8/commons-betwixt-0.8.jar (/META-INF/LICENSE.txt)
<install>/jar/commons_collections/3_2/LICENSE.txt

```
<install>/jar/commons_digester/1_8/commons-digester-1.8.jar (/META-INF/LICENSE.txt)
<install>/jar/commons_io/1_4/LICENSE.txt
<install>/jar/commons_lang/2_1/Commons_Lang_License.txt
<install>/jar/commons_logging/1_0_4/commons-logging-1.0.4.jar (/META-INF/LICENSE.txt)
<install>/jar/commons_net/1_4_1/commons-net-1.4.1.jar (/META-INF/LICENSE.txt)
<install>/jar/smcfs/9.0/lucene-core-2.4.0.jar (/META-INF/LICENSE.txt)
<install>/jar/struts/2_0_11/struts2-core-2.0.11.jar (./LICENSE.txt)
<install>/jar/commons_pool/1_4/Commons_License.txt
<install>/jar/jakarta_oro/2_0_8/JakartaOro_License.txt
<install>/jar/log4j/1_2_15/LOG4J_License.txt
<install>/jar/xalan/2_7/Xalan_License.txt
<install>/jar/soap/2_3_1/Apache_SOAP_License.txt
```

Unless otherwise stated in a specific directory, the Apache 2.0 Software was not modified. Neither the Sterling Commerce Software, modifications, if any, to Apache 2.0 Software, nor other Third Party Code is a Derivative Work or a Contribution as defined in License Version 2.0. License Version 2.0 applies only to the Apache 2.0 Software which is the subject of the specific directory file and does not apply to the Sterling Commerce Software or to any other Third Party Software. License Version 2.0 includes the following provision:

"Unless required by applicable law or agreed to in writing, Licensor provides the Work (and each Contributor provides its Contributions) on an "AS IS" BASIS, WITHOUT WARRANTIES OR CONDITIONS OF ANY KIND, either express or implied, including, without limitation, any warranties or conditions of TITLE, NON-INFRINGEMENT, MERCHANTABILITY, or FITNESS FOR A PARTICULAR PURPOSE. You are solely responsible for determining the appropriateness of using or redistributing the Work and assume any risks associated with Your exercise of permissions under this License."

NOTICE file corresponding to the section 4 d of the Apache License, Version 2.0, in this case for the Apache Ant distribution. Apache Ant Copyright 1999-2008 The Apache Software Foundation. This product includes software developed by The Apache Software Foundation (<http://www.apache.org/>). This product includes also software developed by:

- the W3C consortium (<http://www.w3c.org>)
- the SAX project (<http://www.saxproject.org>)

The <sync> task is based on code Copyright © 2002, Landmark Graphics Corp that has been kindly donated to the Apache Software Foundation.

Portions of this software were originally based on the following:

- software copyright © 1999, IBM Corporation., <http://www.ibm.com>.
- software copyright © 1999, Sun Microsystems., <http://www.sun.com>.
- voluntary contributions made by Paul Eng on behalf of the Apache Software Foundation that were originally developed at iClick, Inc., software copyright © 1999.

NOTICE file corresponding to the section 4 d of the Apache License, Version 2.0, in this case for the Apache Lucene distribution. Apache Lucene Copyright 2006 The Apache Software Foundation. This product includes software developed by The Apache Software Foundation (<http://www.apache.org/>). The snowball stemmers in contrib/snowball/src/java/net/sf/snowball were developed by Martin Porter and Richard Boulton. The full snowball package is available from <http://snowball.tartarus.org/>

Ant-Contrib Software

The Sterling Commerce Software is distributed with or on the same storage media as the Anti-Contrib software (Copyright © 2001-2003 Ant-Contrib project. All rights reserved.) (the "Ant-Contrib Software"). The Ant-Contrib Software is free software which is distributed under the terms of the following license:

The Apache Software License, Version 1.1

Copyright © 2001-2003 Ant-Contrib project. All rights reserved.

Redistribution and use in source and binary forms, with or without modification, are permitted provided that the following conditions are met:

1. Redistributions of source code must retain the above copyright notice, this list of conditions and the following disclaimer.

2. Redistributions in binary form must reproduce the above copyright notice, this list of conditions and the following disclaimer in the documentation and/or other materials provided with the distribution.

3. The end-user documentation included with the redistribution, if any, must include the following acknowledgement:

"This product includes software developed by the Ant-Contrib project (<http://sourceforge.net/projects/ant-contrib>)."

Alternately, this acknowledgement may appear in the software itself, if and wherever such third-party acknowledgements normally appear.

4. The name Ant-Contrib must not be used to endorse or promote products derived from this software without prior written permission. For written permission, please contact ant-contrib-developers@lists.sourceforge.net.

5. Products derived from this software may not be called "Ant-Contrib" nor may "Ant-Contrib" appear in their names without prior written permission of the Ant-Contrib project.

THIS SOFTWARE IS PROVIDED ``AS IS'' AND ANY EXPRESSED OR IMPLIED WARRANTIES, INCLUDING, BUT NOT LIMITED TO, THE IMPLIED WARRANTIES OF MERCHANTABILITY AND FITNESS FOR A PARTICULAR PURPOSE ARE DISCLAIMED. IN NO EVENT SHALL THE ANT-CONTRIB PROJECT OR ITS CONTRIBUTORS BE LIABLE FOR ANY DIRECT, INDIRECT, INCIDENTAL, SPECIAL, EXEMPLARY, OR CONSEQUENTIAL DAMAGES (INCLUDING, BUT NOT LIMITED TO, PROCUREMENT OF SUBSTITUTE GOODS OR SERVICES; LOSS OF USE, DATA, OR PROFITS; OR BUSINESS INTERRUPTION) HOWEVER CAUSED AND ON ANY THEORY OF LIABILITY, WHETHER IN CONTRACT, STRICT LIABILITY, OR TORT (INCLUDING NEGLIGENCE OR OTHERWISE) ARISING IN ANY WAY OUT OF THE USE OF THIS SOFTWARE, EVEN IF ADVISED OF THE POSSIBILITY OF SUCH DAMAGE.

The preceding license only applies to the Ant-Contrib Software and does not apply to the Sterling Commerce Software or to any other Third Party Software.

ANTISAMY SOFTWARE

The Sterling Commerce Software is distributed with or on the same storage media as the AntiSamy software (Copyright © 1998 Regents of the University of California. All rights reserved.) (the "AntiSamy Software"). The AntiSamy Software is free software which is distributed under the terms of the following license:

Copyright © 1998, Regents of the University of California

All rights reserved.

Redistribution and use in source and binary forms, with or without modification, are permitted provided that the following conditions are met:

Redistributions of source code must retain the above copyright notice, this list of conditions and the following disclaimer.

Redistributions in binary form must reproduce the above copyright notice, this list of conditions and the following disclaimer in the documentation and/or other materials provided with the distribution.

Neither the name of the <ORGANIZATION> nor the names of its contributors may be used to endorse or promote products derived from this software without specific prior written permission.

THIS SOFTWARE IS PROVIDED BY THE COPYRIGHT HOLDERS AND CONTRIBUTORS "AS IS" AND ANY EXPRESS OR IMPLIED WARRANTIES, INCLUDING, BUT NOT LIMITED TO, THE IMPLIED WARRANTIES OF MERCHANTABILITY AND FITNESS FOR A PARTICULAR PURPOSE ARE DISCLAIMED. IN NO EVENT SHALL THE COPYRIGHT HOLDER OR CONTRIBUTORS BE LIABLE FOR ANY DIRECT, INDIRECT, INCIDENTAL, SPECIAL, EXEMPLARY, OR CONSEQUENTIAL DAMAGES (INCLUDING, BUT NOT LIMITED TO,

PROCUREMENT OF SUBSTITUTE GOODS OR SERVICES; LOSS OF USE, DATA, OR PROFITS; OR BUSINESS INTERRUPTION) HOWEVER CAUSED AND ON ANY THEORY OF LIABILITY, WHETHER IN CONTRACT, STRICT LIABILITY, OR TORT (INCLUDING NEGLIGENCE OR OTHERWISE) ARISING IN ANY WAY OUT OF THE USE OF THIS SOFTWARE, EVEN IF ADVISED OF THE POSSIBILITY OF SUCH DAMAGE.

COOLBUTTONS SOFTWARE

The Sterling Commerce Software is also distributed with or on the same storage media as Coolbuttons.js ("Coolbuttons Software"), which is subject to the following license:

This Button Script was designed by Erik Arvidsson for WebFX. For more info and examples see: <http://webfx.eae.net> or send email to erik@eae.net. Feel free to use this code as long as this disclaimer is intact.

The preceding license only applies to the Coolbuttons Software and does not apply to the Sterling Commerce Software, or any other Third Party Software.

DOM4J Software

The Sterling Commerce Software is distributed with or on the same storage media as the Dom4h Software which is free software distributed under the terms of the following license:

Redistribution and use of this software and associated documentation ("Software"), with or without modification, are permitted provided that the following conditions are met:

- 1.Redistributions of source code must retain copyright statements and notices. Redistributions must also contain a copy of this document.
- 2.Redistributions in binary form must reproduce the above copyright notice, this list of conditions and the following disclaimer in the documentation and/or other materials provided with the distribution.
- 3.The name "DOM4J" must not be used to endorse or promote products derived from this Software without prior written permission of MetaStuff, Ltd. For written permission, please contact dom4j-info@metastuff.com.
- 4.Products derived from this Software may not be called "DOM4J" nor may "DOM4J" appear in their names without prior written permission of MetaStuff, Ltd. DOM4J is a registered trademark of MetaStuff, Ltd.
- 5.Due credit should be given to the DOM4J Project - <http://www.dom4j.org>

THIS SOFTWARE IS PROVIDED BY METASTUFF, LTD. AND CONTRIBUTORS ``AS IS'' AND ANY EXPRESSED OR IMPLIED WARRANTIES, INCLUDING, BUT NOT LIMITED TO, THE IMPLIED WARRANTIES OF MERCHANTABILITY AND FITNESS FOR A PARTICULAR PURPOSE ARE DISCLAIMED. IN NO EVENT SHALL METASTUFF, LTD. OR ITS CONTRIBUTORS BE LIABLE FOR ANY DIRECT, INDIRECT, INCIDENTAL, SPECIAL, EXEMPLARY, OR CONSEQUENTIAL DAMAGES (INCLUDING, BUT NOT LIMITED TO, PROCUREMENT OF SUBSTITUTE GOODS OR SERVICES; LOSS OF USE, DATA, OR PROFITS; OR BUSINESS INTERRUPTION) HOWEVER CAUSED AND ON ANY THEORY OF LIABILITY, WHETHER IN CONTRACT, STRICT LIABILITY, OR TORT (INCLUDING NEGLIGENCE OR OTHERWISE) ARISING IN ANY WAY OUT OF THE USE OF THIS SOFTWARE, EVEN IF ADVISED OF THE POSSIBILITY OF SUCH DAMAGE.

Copyright 2001-2004 © MetaStuff, Ltd. All Rights Reserved.

The preceding license only applies to the Dom4j Software and does not apply to the Sterling Commerce Software, or any other Third Party Software.

THE ECLIPSE SOFTWARE FOUNDATION

The Sterling Commerce Software is also distributed with or on the same storage media as the following

software:

com.ibm.icu.nl1_3.4.4.v200606220026.jar, org.eclipse.ant.core.nl1_3.1.100.v200606220026.jar,
org.eclipse.ant.ui.nl1_3.2.0.v200606220026.jar, org.eclipse.compare.nl1_3.2.0.v200606220026.jar,
org.eclipse.core.boot.nl1_3.1.100.v200606220026.jar,
org.eclipse.core.commands.nl1_3.2.0.v200606220026.jar,
org.eclipse.core.contenttype.nl1_3.2.0.v200606220026.jar,
org.eclipse.core.expressions.nl1_3.2.0.v200606220026.jar,
org.eclipse.core.filebuffers.nl1_3.2.0.v200606220026.jar,
org.eclipse.core.filesystem.nl1_1.0.0.v200606220026.jar,
org.eclipse.core.jobs.nl1_3.2.0.v200606220026.jar,
org.eclipse.core.resources.nl1_3.2.0.v200606220026.jar,
org.eclipse.core.runtime.compatibility.auth.nl1_3.2.0.v200606220026.jar,
org.eclipse.core.runtime.compatibility.nl1_3.1.100.v200606220026.jar,
org.eclipse.core.runtime.nl1_3.2.0.v200606220026.jar,
org.eclipse.core.variables.nl1_3.1.100.v200606220026.jar,
org.eclipse.debug.core.nl1_3.2.0.v200606220026.jar,
org.eclipse.debug.ui.nl1_3.2.0.v200606220026.jar,
org.eclipse.equinox.common.nl1_3.2.0.v200606220026.jar,
org.eclipse.equinox.preferences.nl1_3.2.0.v200606220026.jar,
org.eclipse.equinox.registry.nl1_3.2.0.v200606220026.jar,
org.eclipse.help.appserver.nl1_3.1.100.v200606220026.jar,
org.eclipse.help.base.nl1_3.2.0.v200606220026.jar, org.eclipse.help.nl1_3.2.0.v200606220026.jar,
org.eclipse.help.ui.nl1_3.2.0.v200606220026.jar, org.eclipse.jdt.apt.core.nl1_3.2.0.v200606220026.jar,
org.eclipse.jdt.apt.ui.nl1_3.2.0.v200606220026.jar,
org.eclipse.jdt.core.manipulation.nl1_1.0.0.v200606220026.jar,
org.eclipse.jdt.core.nl1_3.2.0.v200606220026.jar,
org.eclipse.jdt.debug.ui.nl1_3.2.0.v200606220026.jar,
org.eclipse.jdt.doc.isv.nl1_3.2.0.v200606220026.jar,
org.eclipse.jdt.doc.user.nl1_3.2.0.v200606220026.jar,
org.eclipse.jdt.junit4.runtime.nl1_1.0.0.v200606220026.jar,
org.eclipse.jdt.launching.nl1_3.2.0.v200606220026.jar, org.eclipse.jdt.nl1_3.2.0.v200606220026.jar,
org.eclipse.jdt.ui.nl1_3.2.0.v200606220026.jar,
org.eclipse.jface.databinding.nl1_1.0.0.v200606220026.jar,
org.eclipse.jface.nl1_3.2.0.v200606220026.jar, org.eclipse.jface.text.nl1_3.2.0.v200606220026.jar,
org.eclipse.ltk.core.refactoring.nl1_3.2.0.v200606220026.jar,
org.eclipse.ltk.ui.refactoring.nl1_3.2.0.v200606220026.jar,
org.eclipse.osgi.nl1_3.2.0.v200606220026.jar, org.eclipse.osgi.services.nl1_3.1.100.v200606220026.jar,
org.eclipse.osgi.util.nl1_3.1.100.v200606220026.jar, org.eclipse.pde.core.nl1_3.2.0.v200606220026.jar,
org.eclipse.pde.doc.user.nl1_3.2.0.v200606220026.jar,
org.eclipse.pde.junit.runtime.nl1_3.2.0.v200606220026.jar,
org.eclipse.pde.nl1_3.2.0.v200606220026.jar, org.eclipse.pde.runtime.nl1_3.2.0.v200606220026.jar,
org.eclipse.pde.ui.nl1_3.2.0.v200606220026.jar,
org.eclipse.platform.doc.isv.nl1_3.2.0.v200606220026.jar,
org.eclipse.platform.doc.user.nl1_3.2.0.v200606220026.jar,
org.eclipse.rcp.nl1_3.2.0.v200606220026.jar, org.eclipse.search.nl1_3.2.0.v200606220026.jar,
org.eclipse.swt.nl1_3.2.0.v200606220026.jar, org.eclipse.team.core.nl1_3.2.0.v200606220026.jar,
org.eclipse.team.cvs.core.nl1_3.2.0.v200606220026.jar,
org.eclipse.team.cvs.ssh.nl1_3.2.0.v200606220026.jar,
org.eclipse.team.cvs.ssh2.nl1_3.2.0.v200606220026.jar,
org.eclipse.team.cvs.ui.nl1_3.2.0.v200606220026.jar, org.eclipse.team.ui.nl1_3.2.0.v200606220026.jar,
org.eclipse.text.nl1_3.2.0.v200606220026.jar, org.eclipse.ui.browser.nl1_3.2.0.v200606220026.jar,
org.eclipse.ui.cheatsheets.nl1_3.2.0.v200606220026.jar,
org.eclipse.ui.console.nl1_3.1.100.v200606220026.jar,
org.eclipse.ui.editors.nl1_3.2.0.v200606220026.jar,
org.eclipse.ui.externaltools.nl1_3.1.100.v200606220026.jar,
org.eclipse.ui.forms.nl1_3.2.0.v200606220026.jar, org.eclipse.ui.ide.nl1_3.2.0.v200606220026.jar,
org.eclipse.ui.intro.nl1_3.2.0.v200606220026.jar, org.eclipse.ui.navigator.nl1_3.2.0.v200606220026.jar,
org.eclipse.ui.navigator.resources.nl1_3.2.0.v200606220026.jar,
org.eclipse.ui.nl1_3.2.0.v200606220026.jar,
org.eclipse.ui.presentations.r21.nl1_3.2.0.v200606220026.jar,
org.eclipse.ui.views.nl1_3.2.0.v200606220026.jar,

org.eclipse.ui.views.properties.tabbed.nl1_3.2.0.v200606220026.jar,
org.eclipse.ui.workbench.nl1_3.2.0.v200606220026.jar,
org.eclipse.ui.workbench.texteditor.nl1_3.2.0.v200606220026.jar,
org.eclipse.update.configurator.nl1_3.2.0.v200606220026.jar,
org.eclipse.update.core.nl1_3.2.0.v200606220026.jar,
org.eclipse.update.scheduler.nl1_3.2.0.v200606220026.jar,
org.eclipse.update.ui.nl1_3.2.0.v200606220026.jar,
com.ibm.icu_3.4.4.1.jar,
org.eclipse.core.commands_3.2.0.I20060605-1400.jar,
org.eclipse.core.contenttype_3.2.0.v20060603.jar,
org.eclipse.core.expressions_3.2.0.v20060605-1400.jar,
org.eclipse.core.filesystem.linux.x86_1.0.0.v20060603.jar,
org.eclipse.core.filesystem_1.0.0.v20060603.jar, org.eclipse.core.jobs_3.2.0.v20060603.jar,
org.eclipse.core.runtime.compatibility.auth_3.2.0.v20060601.jar,
org.eclipse.core.runtime_3.2.0.v20060603.jar, org.eclipse.equinox.common_3.2.0.v20060603.jar,
org.eclipse.equinox.preferences_3.2.0.v20060601.jar, org.eclipse.equinox.registry_3.2.0.v20060601.jar,
org.eclipse.help_3.2.0.v20060602.jar, org.eclipse.jface.text_3.2.0.v20060605-1400.jar,
org.eclipse.jface_3.2.0.I20060605-1400.jar, org.eclipse.osgi_3.2.0.v20060601.jar,
org.eclipse.swt.gtk.linux.x86_3.2.0.v3232m.jar, org.eclipse.swt_3.2.0.v3232o.jar,
org.eclipse.text_3.2.0.v20060605-1400.jar,
org.eclipse.ui.workbench.texteditor_3.2.0.v20060605-1400.jar,
org.eclipse.ui.workbench_3.2.0.I20060605-1400.jar, org.eclipse.ui_3.2.0.I20060605-1400.jar,
runtime_registry_compatibility.jar, eclipse.exe, eclipse.ini, and startup.jar
(collectively, "Eclipse Software").

All Eclipse Software is distributed under the terms and conditions of the Eclipse Foundation Software User Agreement (EFSUA) and/or terms and conditions of the Eclipse Public License Version 1.0 (EPL) or other license agreements, notices or terms and conditions referenced for the individual pieces of the Eclipse Software, including without limitation "Abouts", "Feature Licenses", and "Feature Update Licenses" as defined in the EFSUA.

A copy of the Eclipse Foundation Software User Agreement is found at
<install_dir>/platformrcp/5_5/rcpdependencies/windows/eclipse/plugins/notice.html,
<install_dir>/platformrcp/5_5/rcpdependencies/windows/eclipse/plugins/notice.html,
<install_dir>/platformrcp/5_5/rcpdependencies/gtk.linux.x86/eclipse/plugins/notice.html, and
<install_dir>/platformrcp/5_5/rcpdependencies/gtk.linux.x86/eclipse/plugins/notice.html.

A copy of the EPL is found at
<install_dir>/platformrcp/5_5/rcpdependencies/windows/eclipse/plugins/epl-v10.htm,
<install_dir>/platformrcp/5_5/rcpdependencies/windows/eclipse/plugins/eclipse/epl-v10.htm,
<install_dir>/platformrcp/5_5/rcpdependencies/gtk.linux.x86/eclipse/plugins/epl-v10.html, and
<install_dir>/platformrcp/5_5/rcpdependencies/gtk.linux.x86/eclipse/plugins/epl-v10.html.

The reference to the license agreements, notices or terms and conditions governing each individual piece of the Eclipse Software is found in the directory files for the individual pieces of the Eclipse Software as described in the file identified as installdir/SCI_License.txt.

These licenses only apply to the Eclipse Software and do not apply to the Sterling Commerce Software, or any other Third Party Software.

The Language Pack (NL Pack) piece of the Eclipse Software, is distributed in object code form. Source code is available at http://archive.eclipse.org/eclipse/downloads/drops/L-3.2_Language_Packs-200607121700/index.php. In the event the source code is no longer available from the website referenced above, contact Sterling Commerce at 978-513-6000 and ask for the Release Manager. A copy of this license is located at <install_dir>/SI/repository/rcp/rcpdependencies/windows/eclipse/plugins/epl-v10.htm and <install_dir>/SI/repository/rcp/rcpdependencies/gtk.linux.x86/eclipse/plugins/epl-v10.html.

The org.eclipse.core.runtime_3.2.0.v20060603.jar piece of the Eclipse Software was modified slightly in order to remove classes containing encryption items. The org.eclipse.core.runtime_3.2.0.v20060603.jar was modified to remove the Cipher, CipherInputStream and CipherOutputStream classes and rebuild the org.eclipse.core.runtime_3.2.0.v20060603.jar.

Ehcache Software

The Sterling Commerce Software is also distributed with or on the same storage media as the Ehcache v.1.5 software (Copyright © 2003-2008 Luck Consulting Pty. Ltd.) ("Ehcache Software"). Ehcache Software is free software which is distributed under the terms of the Apache License Version 2.0. A copy of License Version 2.0 is found in <install>/jar/smcfcs/9.0/ehcache-1.5.0.jar (./LICENSE.txt).

The Ehcache Software was not modified. Neither the Sterling Commerce Software, modifications, if any, to the Ehcache Software, nor other Third Party Code is a Derivative Work or a Contribution as defined in License Version 2.0. License Version 2.0 applies only to the Ehcache Software which is the subject of the specific directory file and does not apply to the Sterling Commerce Software or to any other Third Party Software. License Version 2.0 includes the following provision:

"Unless required by applicable law or agreed to in writing, Licensor provides the Work (and each Contributor provides its Contributions) on an "AS IS" BASIS, WITHOUT WARRANTIES OR CONDITIONS OF ANY KIND, either express or implied, including, without limitation, any warranties or conditions of TITLE, NON-INFRINGEMENT, MERCHANTABILITY, or FITNESS FOR A PARTICULAR PURPOSE. You are solely responsible for determining the appropriateness of using or redistributing the Work and assume any risks associated with Your exercise of permissions under this License."

ESAPI SOFTWARE

The Sterling Commerce Software is also distributed with or on the same storage media as the ESAPI software (Copyright © 2007, the OWASP Foundation) ("ESAPI Software"). ESAPI Software is free software which is distributed under the terms of the following license:

Copyright © 2007, The OWASP Foundation

All rights reserved.

Redistribution and use in source and binary forms, with or without modification, are permitted provided that the following conditions are met:

Redistributions of source code must retain the above copyright notice, this list of conditions and the following disclaimer.

Redistributions in binary form must reproduce the above copyright notice, this list of conditions and the following disclaimer in the documentation and/or other materials provided with the distribution.

Neither the name of the OWASP Foundation nor the names of its contributors may be used to endorse or promote products derived from this software without specific prior written permission.

THIS SOFTWARE IS PROVIDED BY THE COPYRIGHT HOLDERS AND CONTRIBUTORS "AS IS" AND ANY EXPRESS OR IMPLIED WARRANTIES, INCLUDING, BUT NOT LIMITED TO, THE IMPLIED WARRANTIES OF MERCHANTABILITY AND FITNESS FOR A PARTICULAR PURPOSE ARE DISCLAIMED. IN NO EVENT SHALL THE COPYRIGHT OWNER OR CONTRIBUTORS BE LIABLE FOR ANY DIRECT, INDIRECT, INCIDENTAL, SPECIAL, EXEMPLARY, OR CONSEQUENTIAL DAMAGES (INCLUDING, BUT NOT LIMITED TO, PROCUREMENT OF SUBSTITUTE GOODS OR SERVICES; LOSS OF USE, DATA, OR PROFITS; OR BUSINESS INTERRUPTION) HOWEVER CAUSED AND ON ANY THEORY OF LIABILITY, WHETHER IN CONTRACT, STRICT LIABILITY, OR TORT (INCLUDING NEGLIGENCE OR OTHERWISE) ARISING IN ANY WAY OUT OF THE USE OF THIS SOFTWARE, EVEN IF ADVISED OF THE POSSIBILITY OF SUCH DAMAGE.

EZMorph Software

The Sterling Commerce Software is also distributed with or on the same storage media as the EZMorph v. 1.0.4 software (Copyright © 2006-2008 Andres Almiray) ("EZMorph Software"). EZMorph Software is free software which is distributed under the terms of the Apache License Version 2.0. A copy of License

Version 2.0 is found in <install>/jar/ezmorph/1_0_4/ezmorph-1.0.4.jar (./LICENSE.txt).

The EZMorph Software was not modified. Neither the Sterling Commerce Software, modifications, if any, to the EZMorph Software, nor other Third Party Code is a Derivative Work or a Contribution as defined in License Version 2.0. License Version 2.0 applies only to the EZMorph Software which is the subject of the specific directory file and does not apply to the Sterling Commerce Software or to any other Third Party Software. License Version 2.0 includes the following provision:

"Unless required by applicable law or agreed to in writing, Licensor provides the Work (and each Contributor provides its Contributions) on an "AS IS" BASIS, WITHOUT WARRANTIES OR CONDITIONS OF ANY KIND, either express or implied, including, without limitation, any warranties or conditions of TITLE, NON-INFRINGEMENT, MERCHANTABILITY, or FITNESS FOR A PARTICULAR PURPOSE. You are solely responsible for determining the appropriateness of using or redistributing the Work and assume any risks associated with Your exercise of permissions under this License."

Firebug Lite Software

The Sterling Commerce Software is distributed with or on the same storage media as the Firebug Lite Software which is free software distributed under the terms of the following license:

Copyright © 2008 Azer Koçulu <http://azer.kodfabrik.com>. All rights reserved.

Redistribution and use of this software in source and binary forms, with or without modification, are permitted provided that the following conditions are met:

* Redistributions of source code must retain the above copyright notice, this list of conditions and the following disclaimer.

* Redistributions in binary form must reproduce the above copyright notice, this list of conditions and the following disclaimer in the documentation and/or other materials provided with the distribution.

* Neither the name of Azer Koçulu, nor the names of any other contributors may be used to endorse or promote products derived from this software without specific prior written permission of Parakey Inc.

THIS SOFTWARE IS PROVIDED BY THE COPYRIGHT HOLDERS AND CONTRIBUTORS "AS IS" AND ANY EXPRESS OR IMPLIED WARRANTIES, INCLUDING, BUT NOT LIMITED TO, THE IMPLIED WARRANTIES OF MERCHANTABILITY AND FITNESS FOR A PARTICULAR PURPOSE ARE DISCLAIMED. IN NO EVENT SHALL THE COPYRIGHT OWNER OR CONTRIBUTORS BE LIABLE FOR ANY DIRECT, INDIRECT, INCIDENTAL, SPECIAL, EXEMPLARY, OR CONSEQUENTIAL DAMAGES (INCLUDING, BUT NOT LIMITED TO, PROCUREMENT OF SUBSTITUTE GOODS OR SERVICES; LOSS OF USE, DATA, OR PROFITS; OR BUSINESS INTERRUPTION) HOWEVER CAUSED AND ON ANY THEORY OF LIABILITY, WHETHER IN CONTRACT, STRICT LIABILITY, OR TORT (INCLUDING NEGLIGENCE OR OTHERWISE) ARISING IN ANY WAY OUT OF THE USE OF THIS SOFTWARE, EVEN IF ADVISED OF THE POSSIBILITY OF SUCH DAMAGE.

JAVASCRIPT MINIFIER

The Sterling Commerce Software is distributed with or on the same storage media as the JSMin Software which is free software distributed under the terms of the following license:

JSMin.java 2006-02-13; Updated 2007-08-20 with updates from jsmin.c (2007-05-22)

Copyright © 2006 John Reilly (www.inconspicuous.org)

This work is a translation from C to Java of jsmin.c published by Douglas Crockford. Permission is hereby granted to use the Java version under the same conditions as the jsmin.c on which it is based.

jsmin.c 2003-04-21

Copyright © 2002 Douglas Crockford (www.crockford.com)

Permission is hereby granted, free of charge, to any person obtaining a copy of this software and associated documentation files (the "Software"), to deal in the Software without restriction, including

without limitation the rights to use, copy, modify, merge, publish, distribute, sublicense, and/or sell copies of the Software, and to permit persons to whom the Software is furnished to do so, subject to the following conditions:

The above copyright notice and this permission notice shall be included in all copies or substantial portions of the Software.

The Software shall be used for Good, not Evil.

THE SOFTWARE IS PROVIDED "AS IS", WITHOUT WARRANTY OF ANY KIND, EXPRESS OR IMPLIED, INCLUDING BUT NOT LIMITED TO THE WARRANTIES OF MERCHANTABILITY, FITNESS FOR A PARTICULAR PURPOSE AND NONINFRINGEMENT. IN NO EVENT SHALL THE AUTHORS OR COPYRIGHT HOLDERS BE LIABLE FOR ANY CLAIM, DAMAGES OR OTHER LIABILITY, WHETHER IN AN ACTION OF CONTRACT, TORT OR OTHERWISE, ARISING FROM, OUT OF OR IN CONNECTION WITH THE SOFTWARE OR THE USE OR OTHER DEALINGS IN THE SOFTWARE.

ICE SOFTWARE

The Sterling Commerce Software is distributed on the same storage media as the ICE Software (Copyright © 1997 ICE Engineering, Inc./Timothy Gerard Endres.) ("ICE Software"). The ICE Software is independent from and not linked or compiled with the Sterling Commerce Software. The ICE Software is a free software product which can be distributed and/or modified under the terms of the GNU General Public License as published by the Free Software Foundation; either version 2 of the License or any later version.

A copy of the GNU General Public License is provided at `install_dir/jar/jniregistry/1_2/ICE_License.txt`. This license only applies to the ICE Software and does not apply to the Sterling Commerce Software, or any other Third Party Software.

The ICE Software was modified slightly in order to fix a problem discovered by Sterling Commerce involving the RegistryKey class in the RegistryKey.java in the JNIRegistry.jar. The class was modified to comment out the finalize () method and rebuild of the JNIRegistry.jar file.

Source code for the bug fix completed by Sterling Commerce on January 8, 2003 is located at: `install_dir/jar/jniregistry/1_2/RegistryKey.java`. Source code for all other components of the ICE Software is located at <http://www.trustice.com/java/jnireg/index.shtml>.

The ICE Software is distributed WITHOUT ANY WARRANTY; without even the implied warranty of MERCHANTABILITY or FITNESS FOR A PARTICULAR PURPOSE.

JBoss SOFTWARE

The Sterling Commerce Software is distributed on the same storage media as the JBoss Software (Copyright © 1999-2002 JBoss.org) ("JBoss Software"). The JBoss Software is independent from and not linked or compiled with the Sterling Commerce Software. The JBoss Software is a free software product which can be distributed and/or modified under the terms of the GNU Lesser General Public License as published by the Free Software Foundation; either version 2.1 of the License or any later version.

A copy of the GNU Lesser General Public License is provided at:
<install_dir>\jar\jboss\4_2_0\LICENSE.html

This license only applies to the JBoss Software and does not apply to the Sterling Commerce Software, or any other Third Party Software.

The JBoss Software is not distributed by Sterling Commerce in its entirety. Rather, the distribution is limited to the following jar files: `el-api.jar`, `jasper-compiler-5.5.15.jar`, `jasper-el.jar`, `jasper.jar`, `jboss-common-client.jar`, `jboss-j2ee.jar`, `jboss-jmx.jar`, `jboss-jsr77-client.jar`, `jbossmq-client.jar`, `jnpserver.jar`, `jsp-api.jar`, `servlet-api.jar`, `tomcat-juli.jar`.

The JBoss Software was modified slightly in order to allow the ClientSocketFactory to return a socket connected to a particular host in order to control the host interfaces, regardless of whether the

ClientSocket Factory specified was custom or note. Changes were made to org.jnp.server.Main. Details concerning this change can be found at http://sourceforge.net/tracker/?func=detail&aid=1008902&group_id=22866&atid=376687.

Source code for the modifications completed by Sterling Commerce on August 13, 2004 is located at: http://sourceforge.net/tracker/?func=detail&aid=1008902&group_id=22866&atid=376687. Source code for all other components of the JBoss Software is located at <http://www.jboss.org>.

JGO SOFTWARE

The Sterling Commerce Software is distributed with, or on the same storage media, as certain redistributable portions of the JGo Software provided by Northwoods Software Corporation under a commercial license agreement (the "JGo Software"). The JGo Software is provided subject to the disclaimers set forth above and the following notice:

U.S. Government Restricted Rights

The JGo Software and documentation are provided with RESTRICTED RIGHTS. Use, duplication, or disclosure by the Government is subject to restrictions as set forth in subparagraph (C)(1)(ii) of the Rights in Technical Data and Computer Software clause at DFARS 252.227-7013 or subparagraphs (C)(1) and (2) of the Commercial Computer Software - Restricted Rights at 48 CFR 52.227-19, as applicable. Contractor / manufacturer of the JGo Software is Northwoods Software Corporation, 142 Main St., Nashua, NH 03060.

JSDoc Toolkit Software

The Sterling Commerce Software is distributed with or on the same storage media as the JSDoc Toolkit software (Copyright © 2008 Michael Mathews) ("JSDoc Toolkit Software"), which is subject to the following license:

All code specific to JsDoc Toolkit are free, open source and licensed for use under the X11/MIT License.

JsDoc Toolkit is Copyright © 2008 Michael Mathews <micmath@gmail.com>

This program is free software; you can redistribute it and/or modify it under the terms below.

Permission is hereby granted, free of charge, to any person obtaining a copy of this software and associated documentation files (the "Software"), to deal in the Software without restriction, including without limitation the rights to use, copy, modify, merge, publish, distribute, sublicense, and/or sell copies of the Software, and to permit persons to whom the Software is furnished to do so, subject to the following conditions: The above copyright notice and this permission notice must be included in all copies or substantial portions of the Software.

THE SOFTWARE IS PROVIDED "AS IS", WITHOUT WARRANTY OF ANY KIND, EXPRESS OR IMPLIED, INCLUDING BUT NOT LIMITED TO THE WARRANTIES OF MERCHANTABILITY, FITNESS FOR A PARTICULAR PURPOSE AND NONINFRINGEMENT. IN NO EVENT SHALL THE AUTHORS OR COPYRIGHT HOLDERS BE LIABLE FOR ANY CLAIM, DAMAGES OR OTHER LIABILITY, WHETHER IN AN ACTION OF CONTRACT, TORT OR OTHERWISE, ARISING FROM, OUT OF OR IN CONNECTION WITH THE SOFTWARE OR THE USE OR OTHER DEALINGS IN THE SOFTWARE.

JSLib Software

The Sterling Commerce Software is distributed with or on the same storage media as the JSLib software product (Copyright © 2003-2009 Mozdev Group, Inc.) ("JSLib Software"). The JSLib Software is distributed under the terms of the MOZILLA PUBLIC LICENSE Version 1.1. A copy of this license is located at <install>/repository/eardata/platform_uifwk_ide/war/designer/MPL-1.1.txt. The JSLib Software code is distributed in source form and is located at <http://jslib.mozdev.org/installation.html>. Neither the Sterling Commerce Software nor any other Third Party Code is a Modification or Contribution subject to the Mozilla Public License. Pursuant to the terms of the Mozilla Public License, the following

notice applies only to the JSLib Software (and not to the Sterling Commerce Software or any other Third Party Software):

"The contents of the file located at <http://www.mozdev.org/source/browse/jslib/> are subject to the Mozilla Public License Version 1.1 (the "License"); you may not use this file except in compliance with the License. You may obtain a copy of the License at <http://www.mozilla.org/MPL/>

Software distributed under the License is distributed on an "AS IS" basis, WITHOUT WARRANTY OF ANY KIND, either express or implied. See the License for the specific language governing rights and limitations under the License.

The Original Code is Mozdev Group, Inc. code. The Initial Developer of the Original Code is Mozdev Group, Inc. Portions created by Mozdev Group, Inc. are Copyright © 2003 Mozdev Group, Inc. All Rights Reserved. Original Author: Pete Collins <pete@mozdev.org>one Contributor(s): _____ none listed_____.

Alternatively, the contents of this file may be used under the terms of the _____ license (the "[_____] License"), in which case the provisions of [_____] License are applicable instead of those above. If you wish to allow use of your version of this file only under the terms of the [_____] License and not allow others to use your version of this file under the MPL, indicate your decision by deleting the provisions above and replace them with the notice and other provisions required by the [_____] License. If you do not delete the provisions above, a recipient may use your version of this file under either the MPL or the [_____] License."

The preceding license only applies to the JSLib Software and does not apply to the Sterling Commerce Software, or any other Third Party Software.

Json Software

The Sterling Commerce Software is also distributed with or on the same storage media as the Json 2.2.2 software (Copyright © 2006-2008 Json-lib) ("Json Software"). Json Software is free software which is distributed under the terms of the Apache License Version 2.0. A copy of License Version 2.0 is found in <install>/jar/jsonlib/2_2_2/json-lib-2.2.2-jdk13.jar.

This product includes software developed by Douglas Crockford (<http://www.crockford.com>).

The Json Software was not modified. Neither the Sterling Commerce Software, modifications, if any, to the Json Software, nor other Third Party Code is a Derivative Work or a Contribution as defined in License Version 2.0. License Version 2.0 applies only to the Json Software which is the subject of the specific directory file and does not apply to the Sterling Commerce Software or to any other Third Party Software. License Version 2.0 includes the following provision:

"Unless required by applicable law or agreed to in writing, Licensor provides the Work (and each Contributor provides its Contributions) on an "AS IS" BASIS, WITHOUT WARRANTIES OR CONDITIONS OF ANY KIND, either express or implied, including, without limitation, any warranties or conditions of TITLE, NON-INFRINGEMENT, MERCHANTABILITY, or FITNESS FOR A PARTICULAR PURPOSE. You are solely responsible for determining the appropriateness of using or redistributing the Work and assume any risks associated with Your exercise of permissions under this License."

Prototype Software

The Sterling Commerce Software is distributed with or on the same storage media as the Prototype software (Copyright © 2005-2008 Sam Stephenson) ("Prototype Software"), which is subject to the following license:

Copyright © 2005-2008 Sam Stephenson

Permission is hereby granted, free of charge, to any person obtaining a copy of this software and associated documentation files (the "Software"), to deal in the Software without restriction, including without limitation the rights to use, copy, modify, merge, publish, distribute, sublicense, and/or sell copies of the Software, and to permit persons to whom the Software is furnished to do so, subject to the

following conditions:

THE SOFTWARE IS PROVIDED "AS IS", WITHOUT WARRANTY OF ANY KIND, EXPRESS OR IMPLIED, INCLUDING BUT NOT LIMITED TO THE WARRANTIES OF MERCHANTABILITY, FITNESS FOR A PARTICULAR PURPOSE AND NONINFRINGEMENT. IN NO EVENT SHALL THE AUTHORS OR COPYRIGHT HOLDERS BE LIABLE FOR ANY CLAIM, DAMAGES OR OTHER LIABILITY, WHETHER IN AN ACTION OF CONTRACT, TORT OR OTHERWISE, ARISING FROM, OUT OF OR IN CONNECTION WITH THE SOFTWARE OR THE USE OR OTHER DEALINGS IN THE SOFTWARE.

Purple Technology

The Sterling Commerce Software is distributed with or on the same storage media as the Purple Technology Software (Copyright © 1995-1999 Purple Technology, Inc.) ("Purple Technology Software"), which is subject to the following license:

Copyright © 1995-1999 Purple Technology, Inc. All rights reserved.

PLAIN LANGUAGE LICENSE: Do whatever you like with this code, free of charge, just give credit where credit is due. If you improve it, please send your improvements to alex@purpletech.com. Check <http://www.purpletech.com/code/> for the latest version and news.

LEGAL LANGUAGE LICENSE: Redistribution and use in source and binary forms, with or without modification, are permitted provided that the following conditions are met:

1. Redistributions of source code must retain the above copyright notice, this list of conditions and the following disclaimer.
2. Redistributions in binary form must reproduce the above copyright notice, this list of conditions and the following disclaimer in the documentation and/or other materials provided with the distribution.
3. The names of the authors and the names "Purple Technology," "Purple Server" and "Purple Chat" must not be used to endorse or promote products derived from this software without prior written permission. For written permission, please contact server@purpletech.com.

THIS SOFTWARE IS PROVIDED BY THE AUTHORS AND PURPLE TECHNOLOGY "AS IS" AND ANY EXPRESSED OR IMPLIED WARRANTIES, INCLUDING, BUT NOT LIMITED TO, THE IMPLIED WARRANTIES OF MERCHANTABILITY AND FITNESS FOR A PARTICULAR PURPOSE ARE DISCLAIMED. IN NO EVENT SHALL THE AUTHORS OR PURPLE TECHNOLOGY BE LIABLE FOR ANY DIRECT, INDIRECT, INCIDENTAL, SPECIAL, EXEMPLARY, OR CONSEQUENTIAL DAMAGES (INCLUDING, BUT NOT LIMITED TO, PROCUREMENT OF SUBSTITUTE GOODS OR SERVICES; LOSS OF USE, DATA, OR PROFITS; OR BUSINESS INTERRUPTION) HOWEVER CAUSED AND ON ANY THEORY OF LIABILITY, WHETHER IN CONTRACT, STRICT LIABILITY, OR TORT (INCLUDING NEGLIGENCE OR OTHERWISE) ARISING IN ANY WAY OUT OF THE USE OF THIS SOFTWARE, EVEN IF ADVISED OF THE POSSIBILITY OF SUCH DAMAGE.

The preceding license only applies to the Purple Technology Software and does not apply to the Sterling Commerce Software, or any other Third Party Software.

Rico Software

The Sterling Commerce Software is also distributed with or on the same storage media as the Rico.js software (Copyright © 2005 Sabre Airline Solutions) ("Rico Software"). Rico Software is free software which is distributed under the terms of the Apache License Version 2.0. A copy of License Version 2.0 is found in <install>/repository/eardata/platform/war/ajax/scripts/Rico_License.txt.

The Rico Software was not modified. Neither the Sterling Commerce Software, modifications, if any, to the Rico Software, nor other Third Party Code is a Derivative Work or a Contribution as defined in License Version 2.0. License Version 2.0 applies only to the Rico Software which is the subject of the specific directory file and does not apply to the Sterling Commerce Software or to any other Third Party Software. License Version 2.0 includes the following provision:

"Unless required by applicable law or agreed to in writing, Licensor provides the Work (and each

Contributor provides its Contributions) on an "AS IS" BASIS, WITHOUT WARRANTIES OR CONDITIONS OF ANY KIND, either express or implied, including, without limitation, any warranties or conditions of TITLE, NON-INFRINGEMENT, MERCHANTABILITY, or FITNESS FOR A PARTICULAR PURPOSE. You are solely responsible for determining the appropriateness of using or redistributing the Work and assume any risks associated with Your exercise of permissions under this License."

Rhino Software

The Sterling Commerce Software is distributed with or on the same storage media as the Rhino.js.jar (Copyright © 1998-2009 Mozilla.org.) ("Rhino Software"). A majority of the source code for the Rhino Software is dual licensed under the terms of the MOZILLA PUBLIC LICENSE Version 1.1. or the GPL v. 2.0. Additionally, some files (at a minimum the contents of toolsrc/org/Mozilla/javascript/toolsdebugger/treetable) are available under another license as set forth in the directory file for the Rhino Software.

Sterling Commerce's use and distribution of the Rhino Software is under the Mozilla Public License. A copy of this license is located at <install>/jar/rhino/1_7R1/License.txt. The Rhino Software code is distributed in source form and is located at <http://mxr.mozilla.org/mozilla/source/js/rhino/src/>. Neither the Sterling Commerce Software nor any other Third Party Code is a Modification or Contribution subject to the Mozilla Public License. Pursuant to the terms of the Mozilla Public License, the following notice applies only to the Rhino Software (and not to the Sterling Commerce Software or any other Third Party Software):

"The contents of the file located at <install>/jar/rhino/1_7R1/js.jar are subject to the Mozilla Public License Version 1.1 (the "License"); you may not use this file except in compliance with the License. You may obtain a copy of the License at <http://www.mozilla.org/MPL/>

Software distributed under the License is distributed on an "AS IS" basis, WITHOUT WARRANTY OF ANY KIND, either express or implied. See the License for the specific language governing rights and limitations under the License.

The Original Code is Rhino code, released May 6, 1999. The Initial Developer is Netscape Communications Corporation. Portions created by the Initial Developer are Copyright © 1997-1999. All Rights Reserved. Contributor(s): _____none listed.

The preceding license only applies to the Rico Software and does not apply to the Sterling Commerce Software, or any other Third Party Software

SLF4J Software

The Sterling Commerce Software is also distributed with or on the same storage media as the SLF4J software (Copyright © 2004-2008) ("SLF4J Software"), which is subject to the following license:

Copyright © 2004-2008 QOS.ch All rights reserved.

Permission is hereby granted, free of charge, to any person obtaining a copy of this software and associated documentation files (the "Software"), to deal in the Software without restriction, including without limitation the rights to use, copy, modify, merge, publish, distribute, sublicense, and/or sell copies of the Software, and to permit persons to whom the Software is furnished to do so, subject to the following conditions:

The above copyright notice and this permission notice shall be included in all copies or substantial portions of the Software.

THE SOFTWARE IS PROVIDED "AS IS", WITHOUT WARRANTY OF ANY KIND, EXPRESS OR IMPLIED, INCLUDING BUT NOT LIMITED TO THE WARRANTIES OF MERCHANTABILITY, FITNESS FOR A PARTICULAR PURPOSE AND NONINFRINGEMENT. IN NO EVENT SHALL THE AUTHORS OR COPYRIGHT HOLDERS BE LIABLE FOR ANY CLAIM, DAMAGES OR OTHER LIABILITY, WHETHER IN AN ACTION OF CONTRACT, TORT OR OTHERWISE, ARISING FROM, OUT OF OR IN CONNECTION WITH THE SOFTWARE OR THE USE OR OTHER DEALINGS IN THE SOFTWARE.

Sun Microsystems

The Sterling Commerce Software is distributed with or on the same storage media

as the following software products (or components thereof): Sun JMX, and Sun JavaMail (collectively, "Sun Software"). Sun Software is free software which is distributed under the terms of the licenses issued by Sun which are included in the directory files located at:

```
SUN COMM JAR -installdir/jar/comm/2_0
SUN ACTIVATION JAR -installdir/jar/jaf/1_0_2
SUN JavaMail -installdir/jar/javamail/1_4
```

The Sterling Commerce Software is also distributed with or on the same storage media as the Web-app_2_3.dtd software (Copyright © 2007 Sun Microsystems, Inc.) ("Web-App Software"). Web-App Software is free software which is distributed under the terms of the Common Development and Distribution License ("CDDL"). A copy of
<install>/repository/eardata/platform/war/WEB-INF/web_app_License.txt.

The source code for the Web-App Software may be found at: <http://java.sun.com/dtd/>.

Such licenses only apply to the Sun product which is the subject of such directory and does not apply to the Sterling Commerce Software or to any other Third Party Software.

The Sterling Commerce Software is also distributed with or on the same storage media as the Sun Microsystems, Inc. Java (TM) look and feel Graphics Repository ("Sun Graphics Artwork"), subject to the following terms and conditions:

Copyright 2000 by Sun Microsystems, Inc. All Rights Reserved.

Sun grants you ("Licensee") a non-exclusive, royalty free, license to use, and redistribute this software graphics artwork, as individual graphics or as a collection, as part of software code or programs that you develop, provided that i) this copyright notice and license accompany the software graphics artwork; and ii) you do not utilize the software graphics artwork in a manner which is disparaging to Sun. Unless enforcement is prohibited by applicable law, you may not modify the graphics, and must use them true to color and unmodified in every way.

This software graphics artwork is provided "AS IS," without a warranty of any kind. ALL EXPRESS OR IMPLIED CONDITIONS, REPRESENTATIONS AND WARRANTIES, INCLUDING ANY IMPLIED WARRANTY OF MERCHANTABILITY, FITNESS FOR A PARTICULAR PURPOSE OR NON-INFRINGEMENT, ARE HEREBY EXCLUDED. SUN AND ITS LICENSORS SHALL NOT BE LIABLE FOR ANY DAMAGES SUFFERED BY LICENSEE AS A RESULT OF USING, MODIFYING OR DISTRIBUTING THE SOFTWARE GRAPHICS ARTWORK.

IN NO EVENT WILL SUN OR ITS LICENSORS BE LIABLE FOR ANY LOST REVENUE, PROFIT OR DATA, OR FOR DIRECT, INDIRECT, SPECIAL, CONSEQUENTIAL, INCIDENTAL OR PUNITIVE DAMAGES, HOWEVER CAUSED AND REGARDLESS OF THE THEORY OF LIABILITY, ARISING OUT OF THE USE OF OR INABILITY TO USE SOFTWARE GRAPHICS ARTWORK, EVEN IF SUN HAS BEEN ADVISED OF THE POSSIBILITY OF SUCH DAMAGES.

If any of the above provisions are held to be in violation of applicable law, void, or unenforceable in any jurisdiction, then such provisions are waived to the extent necessary for this Disclaimer to be otherwise enforceable in such jurisdiction.

The preceding license only applies to the Sun Graphics Artwork and does not apply to the Sterling Commerce Software, or any other Third Party Software.

WARRANTY DISCLAIMER

This documentation and the Sterling Commerce Software which it describes are licensed either "AS IS" or with a limited warranty, as set forth in the Sterling Commerce license agreement. Other than any limited warranties provided, NO OTHER WARRANTY IS EXPRESSED AND NONE SHALL BE IMPLIED,

INCLUDING THE WARRANTIES OF MERCHANTABILITY AND FITNESS FOR USE OR FOR A PARTICULAR PURPOSE. The applicable Sterling Commerce entity reserves the right to revise this publication from time to time and to make changes in the content hereof without the obligation to notify any person or entity of such revisions or changes.

The Third Party Software is provided "AS IS" WITHOUT ANY WARRANTY AND ANY EXPRESSED OR IMPLIED WARRANTIES, INCLUDING BUT NOT LIMITED TO, THE IMPLIED WARRANTIES OF MERCHANTABILITY, AND FITNESS FOR A PARTICULAR PURPOSE ARE DISCLAIMED. FURTHER, IF YOU ARE LOCATED OR ACCESSING THIS SOFTWARE IN THE UNITED STATES, ANY EXPRESS OR IMPLIED WARRANTY REGARDING TITLE OR NON-INFRINGEMENT ARE DISCLAIMED.

Without limiting the foregoing, the ICE Software and JBoss Software are distributed WITHOUT ANY WARRANTY; without even the implied warranty of MERCHANTABILITY or FITNESS FOR A PARTICULAR PURPOSE.

Contents

Preface

Intended Audience	xlvii
Structure	xlvii
Selling and Fulfillment Foundation Documentation	I
Conventions	lii

1 Introduction

1.1 Business Models.....	2
1.1.1 Multi-Divisional Corporation.....	2
1.1.2 Third-Party Logistics	2
1.1.3 Marketplace.....	3
1.2 Warehouse Management System Configuration	3
1.2.1 Warehouse Layout.....	4
1.2.2 Inventory	4
1.2.3 Receiving	4
1.2.4 Quality Control.....	5
1.2.5 Picking.....	5
1.2.6 Value Added Services	5
1.2.7 Packing.....	5
1.2.8 Shipping	5
1.2.9 Task Management	6
1.2.10 System Administration	6

2 Navigating in the Applications Manager

2.1	Starting the Selling and Fulfillment Foundation Applications Manager	7
2.2	The Selling and Fulfillment Foundation Applications Manager Layout.....	7
2.2.1	Application Rules Side Panel	10
2.2.1.1	Accessing Configuration Screens.....	11
2.2.1.2	Determining Inheritance.....	11
2.2.1.3	Loading Another Node's Rules	16
2.2.1.4	Filtering Application Rules.....	17
2.2.1.5	Copying an Existing Node to a New Node.....	18
2.2.1.6	Onboarding an Enterprise to a Node.....	19
2.2.1.7	Offboarding an Enterprise from a Node.....	20
2.2.1.8	Deleting the Current Node	21
2.2.2	Work Area	22
2.2.2.1	Search Window	22
2.2.2.2	List Window	23
2.2.2.3	Details Window	24
2.2.2.4	Drag and Drop Window	25
2.3	Actions Available the Selling and Fulfillment Foundation Applications Manager	27
2.3.1	Using Applications Manager's Lookup Functionality.....	27
2.3.2	Viewing the User Logged into the Applications Manager	28
2.3.3	Using Lists and List Filtering.....	28
2.3.4	Using On-Line Help	29
2.3.5	Troubleshooting Errors	29
2.3.6	Using Special Characters	30

3 Configuring Warehouse Layout

3.1	Defining Nodes	31
3.1.1	Configuring a Node	32
3.2	Defining Location Size Codes	35
3.2.1	Creating a Location Size Code	35
3.2.2	Modifying a Location Size Code	39
3.2.3	Deleting a Location Size Code	39
3.3	Defining Location Storage Codes	40

3.3.1	Creating a Location Storage Code	40
3.3.2	Modifying a Location Storage Code	42
3.3.3	Deleting a Location Storage Code	42
3.4	Defining Velocity Codes.....	43
3.4.1	Creating a Velocity Code	43
3.4.2	Creating a New Velocity Code from an Existing Velocity Code	45
3.4.3	Modifying a Velocity Code.....	46
3.4.4	Deleting a Velocity Code.....	46
3.5	Defining Zones	46
3.5.1	Creating a Zone	47
3.5.2	Modifying a Zone	55
3.5.3	Deleting a Zone	55
3.6	Defining Zone Constraints	55
3.7	Defining Locations.....	56
3.7.1	Setting Up a Location.....	57
3.7.1.1	Setting Up a Location's Primary Information.....	59
3.7.1.2	Setting Up a Location's Dedication	65
3.7.2	Creating a New Location From an Existing Location	67
3.7.3	Modifying a Location	70
3.7.4	Deleting a Location	71
3.8	Defining Dedicate Locations.....	72
3.8.1	Setting Up a Dedicate Location.....	72
3.8.2	Deleting a Dedicate Location.....	74
3.9	Defining Dock Scheduling Rule	75
3.10	Defining Equipment	75
3.10.1	Setting Up an Equipment Type	76
3.10.1.1	Creating an Equipment Type	77
3.10.1.2	Modifying an Equipment Type	79
3.10.1.3	Deleting an Equipment Type	80
3.10.2	Setting Up a Task Type Association.....	80
3.10.3	Setting Up a Print Format Preference	82
3.10.4	Setting Up an Equipment ID	83
3.10.4.1	Creating an Equipment ID	84
3.10.4.2	Creating a New Equipment ID From an Existing Equipment ID	86
3.10.4.3	Modifying an Equipment ID.....	86

3.10.4.4	Deleting an Equipment ID.....	87
3.10.5	Setting Up an Equipment Device Association	87
3.11	Defining Stations.....	89
3.11.1	Setting Up a Station Type.....	89
3.11.1.1	Creating a Station Type.....	89
3.11.1.2	Modifying a Station Type	92
3.11.1.3	Deleting a Station Type.....	92
3.11.2	Setting Up a Task Type Association.....	93
3.11.3	Setting Up a Print Format Preference	95
3.11.4	Setting Up a Station ID	96
3.11.4.1	Creating a Station ID	96
3.11.4.2	Creating a New Station ID from a Station ID	98
3.11.4.3	Modifying a Station ID	98
3.11.4.4	Deleting a Station ID	99
3.11.5	Setting Up a Station Device Association.....	99
3.12	Defining Transaction Repository	101
3.12.1	Transactions	101
3.12.2	Conditions	103
3.12.3	Actions	104
3.12.4	Service Definitions.....	108

4 Configuring Inventory

4.1	Defining Product Class	112
4.1.1	Creating a Product Class.....	112
4.1.2	Creating a New Product Class From an Existing Product Class.....	114
4.1.3	Modifying a Product Class.....	114
4.1.4	Deleting a Product Class.....	115
4.2	Defining Inventory Status.....	115
4.2.1	Creating an Inventory Status	115
4.2.2	Modifying an Inventory Status.....	117
4.2.3	Deleting an Inventory Status	117
4.3	Defining Inventory Adjustment Reasons	118
4.3.1	Creating an Inventory Adjustment Reason	118
4.3.1.1	Defining Adjustment Sequence.....	122
4.3.1.1.1	Creating an Adjustment Sequence	123

4.3.1.1.2	Modifying an Adjustment Sequence	124
4.3.1.1.3	Deleting an Adjustment Sequence	125
4.3.2	Creating a New Inventory Adjustment Reason from an Existing Inventory Adjustment Reason	125
4.3.3	Modifying an Inventory Adjustment Reason	125
4.3.4	Deleting an Inventory Adjustment Reason	126
4.4	Defining Inventory Transition Rules	126
4.4.1	Creating an Inventory Transition Rule	127
4.4.2	Modifying an Inventory Transition Rule.....	130
4.4.3	Deleting an Inventory Transition Rule	130
4.5	Defining Storage Preferences	130
4.5.1	Selecting Storage Preferences.....	131
4.5.2	Setting Up Storage Preferences for Single SKU.....	132
4.5.2.1	Creating a Storage Preference for Single SKU.....	132
4.5.2.2	Creating a New Storage Preference for Single SKU from an Existing Storage Preference	140
4.5.2.3	Modifying a Storage Preference for Single SKU	140
4.5.2.4	Deleting a Storage Preference for Single SKU.....	141
4.5.3	Setting Up Storage Preferences for Multi-SKU/Multi-Level Container ..	141
4.5.3.1	Creating a Storage Preference for Multi-SKU/Multi-Level Container	141
4.5.3.1.1	Setting Up Storage Preferences for Multi-Level Pallets	142
4.5.3.1.2	Setting Up Storage Preferences for Multi-Level Cases	148
4.5.3.2	Modifying a Storage Preference for Multi-SKU/Multi-Level Container	155
4.5.3.3	Deleting a Storage Preference for Multi-SKU/Multi-Level Container	155
4.5.4	Setting Up Storage Preferences for Container with Unknown Contents	156
4.5.4.1	Creating a Storage Preference for Container with Unknown Contents	156
4.5.4.1.1	Setting Up Storage Preferences for Container with Unknown Contents - Pallets.....	157
4.5.4.1.2	Setting Up Storage Preferences for Container with Unknown Contents - Cases.....	163
4.5.4.2	Modifying a Storage Preference for Container with Unknown Contents	170

4.5.4.3	Deleting a Storage Preference for Container with Unknown Contents	170
4.6	Defining a Replenishment Strategy	171
4.7	Defining Replenishment Algorithm	172
4.7.1	Rounding Up Inventory	172
4.7.2	Replenishing By Using the Least Number of Trips Process	173
4.7.2.1	Examples With Round Up.....	173
4.7.2.2	Examples Without Round Up	174
4.7.3	Replenishing By Using the Pick to Clean Process	176
4.7.3.1	Examples With Round Up.....	176
4.7.3.2	Examples Without Round Up	177
4.7.4	Creating a Replenishment Strategy.....	178
4.7.5	Modifying a Replenishment Strategy	185
4.7.6	Deleting a Replenishment Strategy	185
4.8	Defining Monitoring Rules	186
4.8.1	Creating a Monitoring Rule.....	186
4.8.2	Creating a New Monitoring Rule from an Existing Monitoring Rule	192
4.8.3	Modifying a Monitoring Rule	193
4.8.4	Deleting a Monitoring Rule	193
4.9	Defining Transaction Repository	193
4.9.1	Transactions	194
4.9.2	Conditions	196
4.9.3	Actions	197
4.9.4	Service Definitions.....	201
4.10	Defining Purge Criteria	203
4.10.1	Setting Up Purge Criteria.....	203
4.11	Defining Node Item Attributes	206
4.11.1	Creating a Node Item Attribute	206
4.11.2	Modifying a Node Item Attribute	208
4.11.3	Deleting a Node Item Attribute.....	208
4.12	Defining Move Request Parameters.....	209
4.12.1	Defining Move Request Transaction Repository	209
4.12.1.1	Transactions	209
4.12.1.2	Conditions	212
4.12.1.3	Actions	213

4.12.1.4	Service Definitions.....	217
4.12.2	Defining Purge Criteria for Move Request.....	219
4.12.2.1	Setting Up Purge Criteria.....	219
4.12.3	Defining Move Request Cancellation Reasons	222
4.12.3.1	Creating a Move Request Cancellation Reason.....	222
4.12.3.2	Creating a New Move Request Cancellation Reason from an Existing Move Request Cancellation Reason	224
4.12.3.3	Modifying a Move Request Cancellation Reason	225
4.12.3.4	Deleting a Move Request Cancellation Reason	225
4.13	Defining Count.....	225
4.13.1	Defining Variance Hold Setup.....	226
4.13.2	Defining Request Type	228
4.13.2.1	Creating a Request Type	228
4.13.2.2	Creating a New Request Type From an Existing Request Type	229
4.13.2.3	Modifying a Request Type.....	229
4.13.2.4	Deleting a Request Type.....	230
4.13.2.5	Setting a Request Type for Create Count Request	230
4.13.3	Defining Count Request Cancellation Reasons	231
4.13.3.1	Creating a Count Request Cancellation Reason	231
4.13.3.2	Creating a New Count Request Cancellation Reason from an Existing Count Request Cancellation Reason	233
4.13.3.3	Modifying a Count Request Cancellation Reason	234
4.13.3.4	Deleting a Count Request Cancellation Reason	234
4.13.4	Defining Count Program	234
4.13.4.1	Creating a Count Program	235
4.13.4.2	Modifying a Count Program.....	239
4.13.4.3	Deleting a Count Program	239
4.13.5	Defining Count Modification Rules.....	239
4.13.5.1	Setting Up Count Modification Rules.....	240
4.13.6	Defining Count Process Type Details	242
4.13.6.1	Viewing Count Process Type Details	243
4.13.7	Defining Count Process Model	245
4.13.7.1	Pipeline Determination	245
4.13.7.2	Hub Rule.....	245
4.13.7.3	Condition Variables for Pipeline Determination.....	246
4.13.7.4	Pipelines	247

4.13.7.5	Transactions	248
4.13.7.6	Statuses	252
4.13.7.7	Conditions	256
4.13.7.8	Actions	258
4.13.7.9	Service Definitions.....	262
4.13.8	Defining Count Strategy	264
4.13.8.1	Setting Up a Count Strategy	264
4.13.8.2	Modifying a Count Strategy.....	267
4.13.8.3	Deleting a Count Strategy	268
4.13.9	Defining Purge Criteria	268
4.13.9.1	Setting Up Purge Criteria	268
4.13.10	Defining Corporate Count Request Purge Criteria	271
4.13.10.1	Setting Up Corporate Count Request Purge Criteria	271

5 Configuring Receiving

5.1	Defining Activities.....	274
5.1.1	Creating an Activity Code	274
5.1.2	Modifying an Activity Code.....	276
5.1.3	Deleting an Activity Code	276
5.2	Defining Putaway Preferences	276
5.2.1	Selecting Putaway Preferences	277
5.2.2	Setting Up Putaway Preference for Single SKU.....	278
5.2.2.1	Creating a Putaway Preference for Single SKU.....	278
5.2.2.2	Creating a New Putaway Preference for Single SKU from an Existing Putaway Preference	286
5.2.2.3	Modifying a Putaway Preference for Single SKU	286
5.2.2.4	Deleting a Putaway Preference for Single SKU	287
5.2.3	Setting Up Putaway Preference for Multi-SKU/Multi-Level Container ..	287
5.2.3.1	Creating a Putaway Preference for Multi-SKU/Multi-Level Container	288
5.2.3.1.1	Setting Up Putaway Preference for a Multi-Level Pallet.....	289
5.2.3.1.2	Setting Up Putaway Preference for a Multi-Level Case.....	295
5.2.3.2	Creating a New Putaway Preference for Multi-SKU/Multi-Level Container from an Existing Putaway Preference	302

5.2.3.3	Modifying a Putaway Preference for Multi-SKU/Multi-Level Container	303
5.2.3.4	Deleting a Putaway Preference for Multi-SKU/Multi-Level Container	303
5.2.4	Setting Up Putaway Preference for Container with Unknown Contents	304
5.2.4.1	Creating a Putaway Preference for Container with Unknown Contents	304
5.2.4.1.1	Setting Up Putaway Preference for a Pallet.....	305
5.2.4.1.2	Setting Up Putaway Preference for a Case.....	311
5.2.4.2	Creating a New Putaway Preference for Container with Unknown Contents from an Existing Putaway Preference	318
5.2.4.3	Modifying a Putaway Preference for Container with Unknown Contents	319
5.2.4.4	Deleting a Putaway Preference for Container with Unknown Contents	319
5.3	Defining Purchase Order.....	320
5.3.1	Defining Receipt Modification Rules.....	320
5.3.2	Setting Up Receipt Modification Rules.....	321
5.3.3	Defining Receipt Process Type Details	323
5.3.4	Defining Receipt Process Model	326
5.3.4.1	Pipeline Determination	326
5.3.4.2	Hub Rule.....	326
5.3.4.3	Condition Variables for Pipeline Determination.....	327
5.3.4.4	Pipelines	328
5.3.4.5	Transactions.....	330
5.3.4.6	Statuses	333
5.3.4.7	Conditions.....	335
5.3.4.8	Actions	337
5.3.4.9	Service Definitions.....	341
5.3.5	Defining Receiving Preferences.....	343
5.3.5.1	Creating a Receiving Preference	343
5.3.5.2	Modifying a Receiving Preference.....	347
5.3.6	Defining Receiving Disposition.....	347
5.3.6.1	Creating a Receiving Disposition.....	348
5.3.6.2	Creating a New Receiving Disposition From an Existing Receiving Disposition	351

5.3.6.3	Modifying a Receiving Disposition	351
5.3.6.4	Deleting a Receiving Disposition	352
5.3.7	Defining Disposition Codes.....	352
5.3.7.1	Creating a Receiving Disposition Code	352
5.3.7.2	Modifying a Receiving Disposition Code	354
5.4	Defining Transfer Order.....	354
5.4.1	Defining Receipt Modification Rules.....	355
5.4.2	Setting Up Receipt Modification Rules.....	355
5.4.3	Defining Receipt Process Type Details	357
5.4.3.1	Viewing Receipt Process Type Details	358
5.4.4	Defining Receipt Process Model	360
5.4.4.1	Pipeline Determination	360
5.4.4.2	Hub Rule	360
5.4.4.3	Condition Variables for Pipeline Determination.....	361
5.4.4.4	Pipelines	362
5.4.4.5	Transactions	364
5.4.4.6	Statuses	368
5.4.4.7	Conditions	370
5.4.4.8	Actions	372
5.4.4.9	Service Definitions.....	376
5.4.5	Defining Receiving Preference	378
5.4.5.1	Creating a Receiving Preferences	378
5.4.5.2	Modifying a Receiving Preference.....	382
5.4.6	Defining Receiving Disposition.....	382
5.4.6.1	Creating a Receiving Disposition	383
5.4.6.2	Creating a New Receiving Disposition From an Existing Receiving Disposition	386
5.4.6.3	Modifying a Receiving Disposition	386
5.4.6.4	Deleting a Receiving Disposition	387
5.4.7	Defining Disposition Codes.....	387
5.4.7.1	Creating a Receiving Disposition Code	387
5.4.7.2	Modifying a Receiving Disposition Code	389
5.5	Defining Return Order	389
5.5.1	Defining Receipt Modification Rules.....	390
5.5.2	Setting Up Receipt Modification Rules.....	390

5.5.3	Defining Receipt Process Type Details	392
5.5.3.1	Viewing Receipt Process Type Details	393
5.5.4	Defining Receipt Process Model	395
5.5.4.1	Pipeline Determination	395
5.5.4.2	Hub Rule	395
5.5.4.3	Condition Variables for Pipeline Determination	396
5.5.4.4	Pipelines	396
5.5.4.5	Transactions	398
5.5.4.6	Statuses	401
5.5.4.7	Conditions	403
5.5.4.8	Actions	405
5.5.4.9	Service Definitions	409
5.5.5	Defining Receiving Preferences	411
5.5.5.1	Creating a Receiving Preference	411
5.5.5.2	Modifying a Receiving Preference	415
5.5.6	Defining Receiving Disposition	415
5.5.6.1	Creating a Receiving Disposition	416
5.5.6.2	Creating a New Receiving Disposition From an Existing Receiving Disposition	419
5.5.6.3	Modifying a Receiving Disposition	419
5.5.6.4	Deleting a Receiving Disposition	420
5.5.7	Defining Disposition Codes	420
5.5.7.1	Creating a Receiving Disposition Code	420
5.5.7.2	Modifying a Receiving Disposition Code	422
5.6	Defining Vendors	422
5.6.1	Defining Vendor Classifications	423
5.6.1.1	Creating a Vendor Classification	423
5.6.1.2	Modifying a Vendor Classification	425
5.6.1.3	Deleting a Vendor Classification	425
5.6.2	Defining Vendor Definition	426
5.6.2.1	Creating a Vendor Definition	426
5.6.2.2	Modifying a Vendor Definition	429
5.6.2.3	Deleting a Vendor Definition	429
5.7	Defining Location Storage Codes	430
5.8	Defining Zone Constraints	430

6 Configuring Quality Control

6.1	Defining Activities.....	431
6.1.1	Creating an Activity Code	432
6.1.2	Modifying an Activity Code.....	434
6.1.3	Deleting an Activity Code	434
6.2	Defining Activity Constraints	434
6.2.1	Setting Up Activity Constraints for Single SKU	435
6.2.1.1	Creating an Activity Constraint for Single SKU	435
6.2.1.2	Creating a New Activity Constraint for Single SKU from an Existing Activity Constraint.....	442
6.2.1.3	Modifying an Activity Constraint for Single SKU	442
6.2.1.4	Deleting an Activity Constraint for Single SKU	443
6.2.2	Setting Up Activity Constraints for Multi-SKU/Multi-Level Container ...	443
6.2.2.1	Creating an Activity Constraint for Multi-SKU/Multi-Level Container	444
6.2.2.1.1	Setting Up Activity Constraints for Multi-Level Pallets	445
6.2.2.1.2	Setting Up Activity Constraints for Multi-Level Cases	451
6.2.2.2	Modifying an Activity Constraint for Multi-SKU/multi-level Container	458
6.2.2.3	Deleting an Activity Constraint for Multi-SKU/Multi-Level Container	458
6.2.3	Setting Up Activity Constraints for Container with Unknown Contents	459
6.2.3.1	Creating an Activity Constraint for Container with Unknown Contents	459
6.2.3.1.1	Setting Up Activity Constraints for Container Pallets.....	460
6.2.3.1.2	Setting Up Activity Constraints for Container Cases.....	466
6.2.3.2	Modifying an Activity Constraint for Container with Unknown Contents	473
6.2.3.3	Deleting an Activity Constraint for Container with Unknown Contents	473
6.3	Defining Retrieval Strategy.....	474
6.3.1	Creating a Retrieval Strategy	474
6.3.1.1	Defining Target Location for Retrieval Strategy.....	477
6.3.1.2	Defining Target Zone for Retrieval Strategy	478
6.3.1.2.1	Defining Pick Location Assignment	479

6.3.2	Modifying a Retrieval Strategy	487
6.3.3	Deleting a Retrieval Strategy	488
6.4	Defining Putaway Preferences	488
6.4.1	Selecting Putaway Preferences	488
6.4.2	Setting Up Putaway Preference for Single SKU	489
6.4.2.1	Creating a Putaway Preferences for Single SKU	490
6.4.2.2	Creating a New Putaway Preference for Single SKU from an existing Putaway Preference	498
6.4.2.3	Modifying a Putaway Preference for Single SKU	498
6.4.2.4	Deleting a Putaway Preference for Single SKU	499
6.4.3	Setting Up Putaway Preference for Multi-SKU/Multi-Level Container ..	500
6.4.3.1	Creating a Putaway Preference for Multi-SKU/Multi-Level Container	500
6.4.3.1.1	Setting Up Putaway Preferences for a Multi-Level Pallet	501
6.4.3.1.2	Setting Up Putaway Preference for a Multi-Level Case	507
6.4.3.2	Creating a New Putaway Preference for a Multi-SKU/Multi-Level Container from an Existing Putaway Preference	514
6.4.3.3	Modifying a Putaway Preference for Multi-SKU/Multi-Level Container	515
6.4.3.4	Deleting a Putaway Preference for Multi-SKU/Multi-Level Container	515
6.4.4	Setting Up Putaway Preferences for Container with Unknown Contents	516
6.4.4.1	Creating a Putaway Preference for Container with Unknown Contents	516
6.4.4.1.1	Setting Up Putaway Preference for a Pallet.....	517
6.4.4.1.2	Setting Up Putaway Preference for a Case.....	523
6.4.4.2	Creating a New Putaway Preference for Container with Unknown Contents from an Existing Putaway Preference	530
6.4.4.3	Modifying a Putaway Preference for Container with Unknown Contents	530
6.4.4.4	Deleting a Putaway Preference for Container with Unknown Contents	531

7 Configuring Picking

7.1	Defining the Outbound Pick Process Model	533
-----	--	-----

7.1.1	Pipeline Determination	534
7.1.1.1	Condition Variables for Pipeline Determination	534
7.1.2	Pipelines	534
7.1.3	Transactions	536
7.1.4	Statuses	539
7.1.5	Conditions	541
7.1.6	Actions	543
7.1.7	Service Definitions.....	547
7.2	Defining Pick Planning Parameters	549
7.2.1	Defining Shipment Groups	549
7.2.1.1	Defining Shipment Selectors	552
7.2.1.2	Defining Wave Size Constraints	557
7.2.1.3	Defining a Shipment Group's Pick Strategy	560
7.2.1.4	Algorithms Used to Determine Pick Locations	562
7.2.1.4.1	Specifying Item Pick Rules	564
7.2.1.4.2	Specifying Item Pick Location Configuration	567
7.2.1.4.3	Specifying Order Pick Rules.....	576
7.2.1.4.4	Specifying Order Pick Location Configuration	577
7.2.1.4.5	Specifying Batch Pick Rules.....	586
7.2.1.4.6	Specifying Batch Pick Location Configuration	586
7.2.1.5	Defining a Shipment Group's Sort Strategy	595
7.2.1.5.1	Defining Carrier Sorting Parameters	595
7.2.1.5.2	Defining Shipment Sorting Parameters	597
7.2.1.6	Defining a Shipment Group's Advanced Parameters.....	599
7.2.2	Defining Wave Size Constraints	601
7.2.2.1	Creating Wave Size Constraints.....	601
7.2.2.2	Modifying Wave Size Constraints	604
7.2.2.3	Deleting Wave Size Constraints	604
7.2.3	Defining a Wave Release Schedule.....	605
7.2.3.1	Creating a Wave Release Schedule	605
7.2.3.2	Modifying a Wave Release Timeframe.....	608
7.2.3.3	Deleting a Wave Release Timeframe	608
7.3	Defining Wave Cancellation Reasons	608
7.3.1	Creating a Wave Cancellation Reason.....	609
7.3.2	Modifying a Wave Cancellation Reason Code	609

7.3.3	Deleting a Wave Cancellation Reason	610
7.4	Defining Purge Criteria	610
7.4.1	Setting Up Purge Criteria	610

8 Configuring Value Added Services

8.1	Defining Activities	616
8.1.1	Creating an Activity Code	616
8.1.2	Modifying an Activity Code	618
8.1.3	Deleting an Activity Code	618
8.2	Defining Activity Constraints	619
8.2.1	Setting Up Activity Constraints for Single SKU	619
8.2.1.1	Creating an Activity Constraint for Single SKU	619
8.2.1.2	Creating a New Activity Constraint for Single SKU from an Existing Activity Constraint	626
8.2.1.3	Modifying an Activity Constraint for Single SKU	626
8.2.1.4	Deleting an Activity Constraint for Single SKU	627
8.2.2	Setting Up Activity Constraints for Containers	627
8.2.2.1	Creating an Activity Constraint for Containers	628
8.2.2.1.1	Setting Up Activity Constraints for Pallets	629
8.2.2.1.2	Setting Up Activity Constraints for Cases	635
8.2.2.2	Modifying an Activity Constraint for Containers	642
8.2.2.3	Deleting an Activity Constraint for Containers	642
8.3	Defining Retrieval Strategy	643
8.3.1	Creating a Retrieval Strategy	643
8.3.1.1	Defining Target Location for Retrieval Strategy	646
8.3.1.2	Defining Target Zone for Retrieval Strategy	647
8.3.1.2.1	Defining Pick Location Assignment	648
8.3.2	Modifying a Retrieval Strategy	658
8.3.3	Deleting a Retrieval Strategy	658
8.4	Defining Putaway Preferences	659
8.4.1	Selecting Putaway Preferences	659
8.4.2	Setting Up Putaway Preference for Single SKU	660
8.4.2.1	Creating a Putaway Preference for Single SKU	660
8.4.2.2	Creating a New Putaway Preference for Single SKU from an Existing Putaway Preference	668

8.4.2.3	Modifying a Putaway Preference for Single SKU	668
8.4.2.4	Deleting a Putaway Preference for Single SKU	669
8.4.3	Setting Up Putaway Preferences for Multiple SKU	670
8.4.3.1	Creating a Putaway Preference for Multiple SKU	670
8.4.3.1.1	Setting Up Putaway Preference for a Pallet	671
8.4.3.1.2	Setting Up Putaway Preference for a Case	677
8.4.3.2	Creating a New Putaway Preference for Multiple SKU from an Existing Putaway Preference	684
8.4.3.3	Modifying a Putaway Preference for Multiple SKU	684
8.4.3.4	Deleting a Putaway Preference for Multiple SKU	685
8.4.4	Setting Up Putaway Preferences for Container with Unknown Contents	686
8.4.4.1	Creating a Putaway Preference for Container with Unknown Contents	686
8.4.4.1.1	Setting Up Putaway Preference for a Pallet	687
8.4.4.1.2	Setting Up Putaway Preference for a Case	693
8.4.4.2	Creating a New Putaway Preference for Container with Unknown Contents from an Existing Putaway Preference	700
8.4.4.3	Modifying a Putaway Preference for Container with Unknown Contents	700
8.4.4.4	Deleting a Putaway Preference for Container with Unknown Contents	701
8.5	Defining Work Order Cancellation Reasons	702
8.5.1	Creating a Work Order Cancellation Reason	702
8.5.2	Creating a New Work Order Cancellation Reason from an Existing Work Order Cancellation Reason	704
8.5.3	Modifying a Work Order Cancellation Reason	705
8.5.4	Deleting a Work Order Cancellation Reason	705
8.6	Defining Allocation Considerations	705
8.6.1	Creating a Work Order Allocation Consideration	706
8.6.2	Modifying a Work Order Allocation Consideration	708
8.6.3	Deleting a Work Order Allocation Consideration	709
8.7	Defining Value Added Services Modification Rules	709
8.7.1	Setting Up Value Added Services Modification Rules	710
8.8	Defining Value-Added Services Hold Types	713
8.8.1	Creating a Hold Type	713

8.8.2	Modifying a Hold Type.....	718
8.8.3	Deleting a Hold Type	718
8.9	Defining Value Added Services Process Type Details.....	718
8.9.1	Viewing Value Added Services Process Type Details	719
8.10	Defining Value Added Services Process Model.....	721
8.10.1	Pipeline Determination	721
8.10.2	Hub Rule.....	721
8.10.2.1	Condition Variables for Pipeline Determination.....	722
8.10.3	Pipelines	723
8.10.4	Transactions.....	724
8.10.5	Statuses	726
8.10.6	Conditions.....	728
8.10.7	Actions	730
8.10.8	Service Definitions.....	734
8.11	Defining Purge Criteria.....	735
8.11.1	Setting Up Purge Criteria.....	736

9 Configuring Packing

9.1	Defining Activities	741
9.1.1	Creating an Activity Code	742
9.1.2	Modifying an Activity Code.....	744
9.1.3	Deleting an Activity Code	744
9.2	Defining Activity Constraints	744
9.2.1	Setting Up Activity Constraints for Single SKU.....	745
9.2.1.1	Creating an Activity Constraint for Single SKU.....	745
9.2.1.2	Creating a New Activity Constraint for Single SKU from an Existing Activity Constraint	752
9.2.1.3	Modifying an Activity Constraint for Single SKU	752
9.2.1.4	Deleting an Activity Constraint for Single SKU	753
9.2.2	Setting Up Activity Constraints for Multi-SKU/Multi-Level Container ...	753
9.2.2.1	Creating an Activity Constraint for Multi-SKU/Multi-Level Container	754
9.2.2.1.1	Setting Up Activity Constraints for Multi-Level Pallets	755
9.2.2.1.2	Setting Up Activity Constraints for Multi-Level Cases	761

9.2.2.2	Modifying an Activity Constraint for Multi-SKU/Multi-Level Container	768
9.2.2.3	Deleting an Activity Constraint for Multi-SKU/Multi-Level Container	768
9.2.3	Setting Up Activity Constraints for Container	769
9.2.3.1	Creating an Activity Constraint for Container	769
9.2.3.1.1	Setting Up Activity Constraints for Pallets	770
9.2.3.1.2	Setting Up Activity Constraints for Cases	776
9.2.3.2	Modifying an Activity Constraint for Container	783
9.2.3.3	Deleting an Activity Constraint for Container	783
9.3	Defining Putaway Preferences	784
9.4	Defining Retrieval Strategy	784
9.5	Defining Pack Planning	784
9.6	Defining Container Build	793
9.7	Defining Inventory Containers	793
9.7.1	Creating an Inventory Container	794
9.7.2	Modifying an Inventory Container	795
9.7.3	Deleting an Inventory Container	795
9.7.4	Setting Up Activity Constraints for Inventory Containers	796
9.7.5	Defining Putaway Strategy	798
9.7.6	Defining Retrieval Strategy	798
9.8	Defining Shipping Containers	799
9.8.1	Creating a Shipping Container	799
9.8.2	Modifying a Shipping Container	801
9.8.3	Deleting a Shipping Container	801
9.8.4	Setting Up Activity Constraints for Shipping Containers	802
9.8.5	Defining Putaway Strategy	804
9.8.6	Defining Retrieval Strategy	804
9.9	Defining Pack Modification Rules	805
9.9.1	Setting Up Pack Modification Rules	805
9.10	Defining Pack Process Type Details	808
9.10.1	Viewing Pack Process Type Details	808
9.11	Defining Pack Process Model	810
9.11.1	Pipeline Determination	810
9.11.2	Hub Rule	810

9.11.2.1	Condition Variables for Pipeline Determination.....	811
9.11.3	Pipelines	813
9.11.4	Transactions	815
9.11.5	Statuses	818
9.11.6	Conditions.....	820
9.11.7	Actions	821
9.11.8	Service Definitions.....	826

10 Configuring Shipping

10.1	Defining Customers	829
10.1.1	Defining Customer Classifications	830
10.1.1.1	Creating a Customer Classification.....	830
10.1.1.2	Modifying a Customer Classification	832
10.1.1.3	Deleting a Customer Classification	832
10.1.2	Defining Customer Definitions	833
10.1.2.1	Creating a Customer Definition.....	833
10.1.2.2	Modifying a Customer Definition	836
10.1.2.3	Deleting a Customer Definition.....	837
10.2	Defining Activities	837
10.2.1	Creating an Activity Code	838
10.2.2	Modifying an Activity Code.....	840
10.2.3	Deleting an Activity Code	840
10.3	Activity Constraints	840
10.3.1	Setting Up Activity Constraints for Container.....	840
10.3.1.1	Creating an Activity Constraint for Container	841
10.3.1.1.1	Setting Up Activity Constraints for Container Pallets.....	842
10.3.1.1.2	Setting Up Activity Constraints for Container Cases.....	848
10.3.1.2	Modifying an Activity Constraint for Container	855
10.3.1.3	Deleting an Activity Constraint for Container	855
10.4	Defining Parcel Carrier Preferences	856
10.4.1	Creating a Parcel Carrier Preference.....	856
10.4.2	Creating a New Parcel Carrier Preference from an Existing Parcel Carrier Preference	859
10.4.3	Modifying a Parcel Carrier Preference	860
10.4.4	Deleting a Parcel Carrier Preference	860

10.5	Defining LTL Carrier Preferences.....	860
10.5.1	Creating an LTL Carrier Preference.....	861
10.5.1.1	Setting Up a Check Digit Determination Algorithm	865
10.5.1.1.1	Creating a Check Digit Determination Algorithm	865
10.5.1.1.2	Creating a New Check Digit Determination Algorithm from an Existing Check Digit Determination Algorithm.....	867
10.5.1.1.3	Modifying a Check Digit Determination Algorithm.....	868
10.5.1.1.4	Deleting a Check Digit Determination Algorithm.....	868
10.5.2	Creating a New LTL Carrier Preference from an Existing LTL Carrier Preference.....	869
10.5.3	Modifying an LTL Carrier Preference	869
10.5.4	Deleting an LTL Carrier Preference.....	869
10.6	Defining Shipping Modification Rules	870
10.7	Defining Shipping Hold Types.....	870
10.8	Defining Shipping Process Type Details.....	870
10.9	Defining Shipping Process Model	871
10.10	Defining Load Modification Rules	871
10.11	Defining Load Hold Types	871
10.12	Defining Load Process Type Details.....	871
10.13	Defining Load Process Model.....	872

11 Configuring Transportation

11.1	Creating an Activity Code	873
11.2	Modifying an Activity Code.....	874
11.3	Deleting an Activity Code	875

12 Configuring Task Management

12.1	Defining Installation Rules	877
12.1.1	Defining Task Statuses.....	878
12.1.2	Modifying Batch Status Descriptions.....	879
12.1.3	Viewing Task References	881
12.2	Defining Reason Codes.....	883
12.2.1	Setting Up Task Modification Reasons.....	883
12.2.2	Modifying Reason Codes.....	884
12.2.3	Deleting Reason Codes.....	884

12.3	Defining Task Types	885
12.3.1	Understanding Task Type Logic Flows	885
12.3.2	Creating a Task Type	893
12.3.3	Modifying a Task Type	894
12.3.4	Deleting a Task Type	894
12.4	Defining User Skills	895
12.4.1	Adding a User Task Type	896
12.4.1.1	Modifying a User Task Type Definition	897
12.4.1.2	Deleting a User Task Type Definition	897
12.4.2	Adding Zone Constraints	898
12.4.2.1	Modifying a Zone Constraint	898
12.4.2.2	Deleting a User Zone Definition	899
12.5	Defining Productivity Types	899
12.5.1	Setting Up Productivity Types	899
12.5.1.1	Creating a Productivity Type	900
12.5.1.1.1	Setting Up a Productivity Type's SAM Definition	902
12.5.1.1.2	Setting Up a Productivity Type's Productivity References	906
12.5.1.1.3	Setting Up a Productivity Type's Task Types	908
12.5.1.1.4	Setting Up a Productivity Type's Equipment Types	910
12.5.1.2	Modifying a Productivity Type	915
12.5.1.3	Deleting a Productivity Type	915
12.5.2	Setting Up Purge Criteria	916
12.5.2.1	Setting Up Purge Criteria	916
12.6	Defining Execution Exceptions	918
12.6.1	Creating a Pick Execution Exception	919
12.6.2	Modifying a Pick Execution Exception	922
12.6.3	Deleting a Pick Execution Exception	922
12.6.4	Creating a Deposit Execution Exception	923
12.6.5	Modifying a Deposit Execution Exception	926
12.6.6	Deleting a Deposit Execution Exception	927
12.6.7	Creating a Skip Execution Exception	927
12.6.8	Modifying a Skip Execution Exception	930
12.6.9	Deleting a Skip Execution Exception	930
12.7	Defining Transaction Repository	931
12.7.1	Transactions	931

12.7.2	Conditions	933
12.7.3	Actions	934
12.7.4	Service Definitions.....	939
12.8	Defining Purge Criteria	940
12.8.1	Setting Up Purge Criteria	941
12.9	Defining Aisle-Level User Constraints	944

13 Configuring Consigned Inventory

13.1	Defining Consumption Share.....	947
13.1.1	Defining Percentage Share at the Item Classification Level for an Inventory Organization	947
13.1.2	Defining Percentage Share at the Item Level for an Inventory Organization	951

14 Configuring System Administration

14.1	Defining Devices	955
14.1.1	Defining a Device Type.....	955
14.1.1.1	Creating a Device Type	956
14.1.1.2	Modifying a Device Type.....	958
14.1.1.3	Deleting a Device Type.....	959
14.1.2	Defining a Device Sub Type	959
14.1.2.1	Creating a Device Sub Type	959
14.1.2.2	Modifying a Device Sub Type	961
14.1.2.3	Deleting a Device Sub Type	961
14.1.3	Defining a Device	962
14.1.3.1	Creating a Device	962
14.1.3.1.1	Setting Up a Device Attribute	966
14.1.3.2	Creating a New Device from a Device	967
14.1.3.3	Modifying a Device	970
14.1.3.4	Deleting a Device	970
14.2	Defining Bar Codes	971
14.2.1	Defining Bar Code Types	971
14.2.1.1	Creating a Bar Code Type	973
14.2.1.2	Deleting a Bar Code Type	975
14.2.2	Defining Bar Code Translation	975

14.2.2.1	Creating a New Bar Code Translation Association.....	976
14.2.2.2	Creating a New Bar Code Translation Association from an Existing Bar Code Translation Association	980
14.2.2.3	Modifying a Bar Code Translation Association	981
14.2.2.4	Moving a Bar Code Translation Association.....	981
14.2.2.5	Deleting a Bar Code Translation Association	982
14.3	Defining Prints	983
14.3.1	Defining Print Documents	984
14.3.1.1	Creating a Print Document.....	984
14.3.1.2	Modifying a Print Document	986
14.3.1.3	Deleting a Print Document	986
14.3.2	Defining Label Formats	987
14.3.3	Defining User Printer Preferences	987
14.3.3.1	Setting Up Printer Preferences for a Group.....	988
14.3.3.2	Setting Up Printer Preferences for a User	991
14.3.4	Defining Participant Print Preferences.....	993
14.3.4.1	Setting Up Print Format Preferences	994

15 Configuring Permissions to Access Multiple Nodes

15.1	Configuring Data Access Policy Rule	999
15.2	Configuring Team Definition.....	1000
15.2.1	Enterprise Access	1001
15.2.2	Ship Node Access	1002
15.3	Configuring Users.....	1006
15.4	Configuring the User Interface for Select Node	1009

16 Resource Planning

16.1	Enabling Resource Planning for a Node.....	1012
16.2	Configuring a Node for Planning	1015
16.3	Defining Resource Pools	1017
16.3.1	Creating Resource Pools.....	1018
16.3.2	Associating Resources to Resource Pools	1019
16.3.2.1	Assigning Shifts to Resources.....	1019
16.3.2.2	Setting Resource Efficiency	1021
16.3.3	Modifying Resource Pools	1022

16.3.4	Deleting Resource Pools	1023
16.4	Defining Task Type Associations	1023
16.4.1	Creating Task Type Resource Pool Associations.....	1023
16.4.2	Modifying Task Type Resource Pool Associations.....	1025
16.4.3	Deleting Task Type Resource Pool Associations.....	1026
16.4.4	Creating Condition Sets.....	1026
16.4.5	Creating Planned Task Conditions	1027
16.4.5.1	Creating Condition Names	1029
16.4.5.1.1	Creating Condition Values.....	1031
16.5	Wave Planning.....	1032
16.5.1	Wave Size Constraints	1032
16.5.2	Shipment Selectors	1033
16.6	Defining a Transaction Repository.....	1033
16.6.1	Transactions	1033
16.6.2	Conditions	1036
16.6.3	Actions	1037
16.6.4	Service Definitions.....	1042

A Time-Triggered Transaction Reference

A.1	Running Time-Triggered Transactions	1046
A.2	Business Process Time-Triggered Transactions	1046
A.2.1	Accept Wave.....	1047
A.2.2	Allocate Task	1049
A.2.3	Assign Lane	1052
A.2.4	Auto Accept Variance	1055
A.2.5	Containerize Wave.....	1057
A.2.6	Create Batch.....	1059
A.2.7	Create Count Task.....	1062
A.2.8	Create Count Request For Location Range.....	1065
A.2.9	Create Third Count Task.....	1067
A.2.10	Create Variance Task	1068
A.2.11	Create Wave.....	1068
A.2.12	Create Wave For a Shipment Group	1072
A.2.13	Execute Count Program.....	1075
A.2.14	Location Inventory Monitor	1080

A.2.15	Mine Productivity.....	1082
A.2.16	Print Wave	1084
A.2.17	Release Task	1087
A.2.18	Release Wave	1089
A.2.19	Reopen Task.....	1091
A.2.20	Request Batch Completion.....	1093
A.2.21	Cancel Wave.....	1096
A.2.22	Cancel Move	1098
A.2.23	Re-Calculate Location Dimensions	1100
A.2.24	PopulateOwnershipTransferSummary	1103
A.3	Purge Time-Triggered Transactions.....	1104
A.3.1	Purge Strategy.....	1104
A.3.2	Configuring Purge Transaction Log Files.....	1105
A.3.3	Available Purges.....	1105
A.3.3.1	Activity Demand Purge.....	1106
A.3.3.2	Count Request Purge	1108
A.3.3.3	Corporate Count Request Purge.....	1110
A.3.3.4	Dock Appointment Purge	1113
A.3.3.5	Location Inventory Audit Purge	1115
A.3.3.6	Manifest Purge.....	1117
A.3.3.7	Move Request Purge	1120
A.3.3.8	Productivity Purge	1122
A.3.3.9	Task History Purge	1124
A.3.3.10	Task Purge	1127
A.3.3.11	Planned Task Purge	1130
A.3.3.12	User Activity Purge	1132
A.3.3.13	Wave Purge.....	1134
A.3.3.14	Execution Exception Audit Purge.....	1137
A.3.3.15	Global Serial Number Purge.....	1139

B Externally Triggered Transaction Reference

B.1	ZeroOut Location Inventory.....	1143
-----	---------------------------------	------

C Factory Setup for High-Volume Pick Pack Warehouse

C.1	Warehouse Layout.....	1147
-----	-----------------------	------

C.1.1	Zone Definition	1148
C.1.2	Location Size Codes	1149
C.1.3	Location Storage Code	1150
C.1.4	Location Definition.....	1150
C.1.5	Dedicated Locations.....	1151
C.1.6	Equipments	1151
C.1.7	Stations	1153
C.2	Requirements - Inbound.....	1154
C.2.1	Default Activity Codes	1154
C.2.2	Disposition Code Mapping.....	1154
C.2.3	Receiving Strategy	1155
C.3	Requirements - Inventory Control.....	1155
C.3.1	Inventory Status Codes.....	1155
C.3.2	Inventory Adjustment Reason Codes.....	1156
C.3.3	Inventory Transition Rules	1156
C.3.4	Storage Preference	1156
C.3.5	Putaway Strategy	1158
C.3.6	Replenishment Strategy	1158
C.3.7	Move Request Cancellation Reason Codes	1159
C.4	Counts.....	1159
C.4.1	Variance Hold Setup	1159
C.4.2	Count Request Cancellation Reason Code	1160
C.4.3	Count Strategy	1160
C.5	Task Management	1160
C.5.1	Modification Reason Codes.....	1161
C.5.2	Task Type - Receipt	1161
C.5.3	Task Type - QC	1162
C.5.4	Task Type - Count	1162
C.5.5	Task Type - Replenishment.....	1163
C.5.6	Task Type - Retrieval.....	1165
C.5.7	Task Type - Putaway	1166
C.5.8	Task Type - VAS.....	1168
C.5.9	Task Type - Pack.....	1169
C.5.10	Task Type - Shipping	1169
C.5.11	Task Type - Picking	1170

C.5.12	Task Execution Exceptions.....	1177
C.6	Requirements - VAS	1178
C.7	Requirements - Outbound	1178
C.7.1	Catch All Shipment Group.....	1179
C.7.2	Wave Cancellation Reason Codes.....	1181
C.7.3	Pack Planning	1182

D Copy Node Functionality

E Onboarding Enterprise to Node Functionality

F Setting Up a Weighing Scale

Index

Preface

This manual describes how to use the Warehouse Management System business application module in the Selling and Fulfillment Foundation Applications Manager.

Intended Audience

This manual is intended for use by system administrators and managers who need to configure the rules and business processes of Selling and Fulfillment Foundation as they pertain to their distributed order management business practices.

Structure

This manual contains the following sections:

Chapter 1, "Introduction"

This chapter briefly describes the contents of this guide.

Chapter 2, "Navigating in the Applications Manager"

This chapter explains the layout of the Applications Manager, actions you can perform throughout the application, and important concepts you should be aware of before using the application.

Chapter 3, "Configuring Warehouse Layout"

This chapter explains how you can configure Warehouse Layout. Warehouse Layout defines the physical layout and related attributes of a warehouse.

Chapter 4, "Configuring Inventory"

This chapter explains how you can configure inventory that defines the comprehensive functionality of the Sterling WMS to track, monitor, and maintain inventory in a warehouse.

Chapter 5, "Configuring Receiving"

This chapter explains how you can configure the rules and activities expected to be performed for inventory being received.

Chapter 6, "Configuring Quality Control"

This chapter explains how you can configure the quality control process that defines the system for ensuring the maintenance of proper standards in manufacturing goods, especially by random inspection of the product.

Chapter 7, "Configuring Picking"

This chapter explains how you can configure the parameters and common codes used for determining algorithms and pipelines used for picking.

Chapter 8, "Configuring Value Added Services"

This chapter explains how you can configure value added services in Selling and Fulfillment Foundation.

Chapter 9, "Configuring Packing"

This chapter explains how you can configure packing. Packing activities in a warehouse are determined based on the strategies used in outbound planning.

Chapter 10, "Configuring Shipping"

This chapter explains how you can configure shipping. Shipping defines the process to be followed after the completion of the Packing and VAS processes.

Chapter 11, "Configuring Transportation"

This chapter explains how you can record transportation or in-transit updates for a container. These updates are recorded against activities defined in Selling and Fulfillment Foundation as transportation activities.

Chapter 12, "Configuring Task Management"

This chapter explains how you can configure task management that enables you to set up your warehouse to optimize node throughput and maximize worker efficiency.

Chapter 13, "Configuring Consigned Inventory"

This chapter how vendor to own inventory for enterprises.

Chapter 14, "Configuring System Administration"

This chapter explains how you can configure common codes for, and set up the Devices, Bar Codes, and Prints.

Chapter 15, "Configuring Permissions to Access Multiple Nodes"

This chapter explains how you can configure the data access policy rule, teams and users to allow a user to access multiple nodes.

Chapter 16, "Resource Planning"

This chapter explains how you can configure resources and their resource pools using the Resource Planning tool.

Appendix A, "Time-Triggered Transaction Reference"

This chapter explains time-triggered transactions that are utilities that perform a variety of individual functions, automatically and at specific time intervals.

Appendix B, "Externally Triggered Transaction Reference"

This chapter explains about the transaction that are triggered externally by the Sterling WMS. Unlike time-triggered transactions, these transactions may or may not be scheduled.

Appendix C, "Factory Setup for High-Volume Pick Pack Warehouse"

The Sterling WMS provides a set of factory defaults for the reference implementation of a high-volume pick pack warehouse.

Appendix D, "Copy Node Functionality"

The Sterling WMS provides a list of all configurations that get copied when copying a node.

Appendix E, "Onboarding Enterprise to Node Functionality"

This chapter provides the list of configurations that get copied during onboarding of an enterprise to a node.

Appendix F, "Setting Up a Weighing Scale"

This chapter provides the steps required to configure and setup a weighing scale.

Selling and Fulfillment Foundation Documentation

For more information about Selling and Fulfillment Foundation components, see the following manuals:

- *Selling and Fulfillment Foundation: Release Notes*
- *Selling and Fulfillment Foundation: Installation Guide*
- *Selling and Fulfillment Foundation: Upgrade Guide*
- *Selling and Fulfillment Foundation: Configuration Deployment Tool Guide*
- *Selling and Fulfillment Foundation: Performance Management Guide*
- *Selling and Fulfillment Foundation: High Availability Guide*
- *Selling and Fulfillment Foundation: System Management Guide*
- *Selling and Fulfillment Foundation: Localization Guide*
- *Selling and Fulfillment Foundation: Customization Basics Guide*
- *Selling and Fulfillment Foundation: Customizing APIs Guide*
- *Selling and Fulfillment Foundation: Customizing Console JSP Interface for End User Guide*
- *Selling and Fulfillment Foundation: Customizing the RCP Interface Guide*
- *Selling and Fulfillment Foundation: Customizing User Interfaces for Mobile Devices Guide*
- *Selling and Fulfillment Foundation: Customizing Web UI Framework Guide*

- *Selling and Fulfillment Foundation: Customizing Swing Interface Guide*
- *Selling and Fulfillment Foundation: Extending the Condition Builder Guide*
- *Selling and Fulfillment Foundation: Extending the Database Guide*
- *Selling and Fulfillment Foundation: Extending Transactions Guide*
- *Selling and Fulfillment Foundation: Using Sterling RCP Extensibility Tool Guide*
- *Selling and Fulfillment Foundation: Integration Guide*
- *Selling and Fulfillment Foundation: Product Concepts Guide*
- *Sterling Warehouse Management™ System: Concepts Guide*
- *Selling and Fulfillment Foundation: Application Platform Configuration Guide*
- *Sterling Distributed Order Management™: Configuration Guide*
- *Sterling Supply Collaboration: Configuration Guide*
- *Sterling Global Inventory Visibility™: Configuration Guide*
- *Catalog Management™: Configuration Guide*
- *Sterling Logistics Management: Configuration Guide*
- *Sterling Reverse Logistics™: Configuration Guide*
- *Sterling Warehouse Management System: Configuration Guide*
- *Selling and Fulfillment Foundation: Application Platform User Guide*
- *Sterling Distributed Order Management: User Guide*
- *Sterling Supply Collaboration: User Guide*
- *Sterling Global Inventory Visibility: User Guide*
- *Sterling Logistics Management: User Guide*
- *Sterling Reverse Logistics: User Guide*
- *Sterling Warehouse Management System: User Guide*
- *Selling and Fulfillment Foundation: Mobile Application User Guide*
- *Selling and Fulfillment Foundation: Business Intelligence Guide*

- *Selling and Fulfillment Foundation: Javadocs*
- *Sterling Selling and Fulfillment Suite™: Glossary*
- *Parcel Carrier: Adapter Guide*
- *Visual Modeler™: Application Guide*
- *Selling and Fulfillment Foundation: Multitenant Enterprise Guide*
- *Selling and Fulfillment Foundation: Password Policy Management Guide*
- *Selling and Fulfillment Foundation: Properties Guide*
- *Catalog Management: Concepts Guide*
- *Selling and Fulfillment Foundation: Pricing Concepts Guide*
- *Selling and Fulfillment Foundation: Setting Up Quotes*
- *Sterling Sensitive Data Capture Server, Release 1.0: Configuration Guide*
- *Sterling Sensitive Data Capture Server, Release 1.0: PA-DSS Implementation Guide*
- *Selling and Fulfillment Foundation: Secure Deployment Guide*
- *Business Center: Item Administration Guide*
- *Business Center: Pricing Administration Guide*
- *Business Center: Customization Guide*
- *Business Center: Localization Guide*

Conventions

The following conventions may be used in this manual:

Convention	Meaning
...	Ellipsis represents information that has been omitted.
< >	Angle brackets indicate user-supplied input.
mono-spaced text	Mono-spaced text indicates a file name, directory path, attribute name, or an inline code example or command.

Convention	Meaning
/ or \	Slashes and backslashes are file separators for Windows, UNIX, and Linux operating systems. The file separator for the Windows operating system is "\" and the file separator for UNIX and Linux systems is "/". The UNIX convention is used unless otherwise mentioned.
<INSTALL_DIR>	User-supplied location of the Selling and Fulfillment Foundation installation directory. This is only applicable for Release 8.0 and later.
<INSTALL_DIR_OLD>	User-supplied location of the Selling and Fulfillment Foundation installation directory (for Release 8.0 and later). Note: This is applicable only for users upgrading from Release 8.0 and later.
<SSDCS_DIR>	User-supplied location of the Sterling Sensitive Data Capture Server installation directory. This is applicable for Selling and Fulfillment Foundation, Release 9.0 and later.
<YANTRA_HOME>	User-supplied location of the Sterling Supply Chain Applications installation directory. This is only applicable for Releases 7.7, 7.9, and 7.11.
<YANTRA_HOME_OLD>	User-supplied location of the Sterling Supply Chain Applications installation directory (for Releases 7.7, 7.9, or 7.11). Note: This is applicable only for users upgrading from Releases 7.7, 7.9, or 7.11.
<YFS_HOME>	For Releases 7.3, 7.5, and 7.5 SP1, this is the user-supplied location of the Sterling Supply Chain Applications installation directory. For Releases 7.7, 7.9, and 7.11, this is the user-supplied location of the <YANTRA_HOME>/Runtime directory. For Release 8.0 and later, the <YANTRA_HOME>/Runtime directory is no longer used and has been substituted with the location <INSTALL_DIR>.
<YFS_HOME_OLD>	This is the <YANTRA_HOME>/Runtime directory for Releases 7.7, 7.9, or 7.11. Note: This is only applicable for users upgrading from Releases 7.7, 7.9, or 7.11.

Convention	Meaning
<ANALYTICS_HOME>	User-supplied location of the Sterling Analytics installation directory. Note: This convention is used only in the <i>Selling and Fulfillment Foundation: Business Intelligence Guide</i> .
<COGNOS_HOME>	User-supplied location of the IBM Cognos 8 Business Intelligence installation directory. Note: This convention is used only in the <i>Selling and Fulfillment Foundation: Business Intelligence Guide</i> .
<MQ_JAVA_INSTALL_PATH>	User-supplied location of the IBM WebSphere® MQ Java components installation directory. Note: This convention is used only in the <i>Selling and Fulfillment Foundation: System Management and Administration Guide</i> .
<DB>	Refers to Oracle®, IBM DB2®, or Microsoft SQL Server® depending on the database server.
<DB_TYPE>	Depending on the database used, considers the value oracle, db2, or sqlserver.

Note: The Selling and Fulfillment Foundation documentation set uses the following conventions in the context of the product name:

- Yantra is used for Release 7.7 and earlier.
- Sterling Supply Chain Applications is used for Releases 7.9 and 7.11.
- Sterling Multi-Channel Fulfillment Solution is used for Releases 8.0 and 8.2.
- Selling and Fulfillment Foundation is used for Releases 8.5 and 9.0.

Introduction

This book concentrates on the rules and the Sterling Warehouse Management System setup configurations that make up the Sterling WMS business application in the Applications Manager. This book is intended for both Hub and Enterprise administrators using the Applications Manager to set up the Selling and Fulfillment Foundation environment. Business analysts should also use this book to plan appropriate business practices as they pertain to Selling and Fulfillment Foundation. Programmers should refer to the *Selling and Fulfillment Foundation: Customization Basics Guide* for information about extending Selling and Fulfillment Foundation. System Integrators should refer to the *Selling and Fulfillment Foundation: Integration Guide* for information about extending or integrating external applications with Selling and Fulfillment Foundation.

Important: This book assumes that you have read and are familiar with the concepts and business functionalities detailed in the *Selling and Fulfillment Foundation: Product Concepts Guide*.

The Applications Manager is a collection of all the rules and setup configurations necessary to implement Selling and Fulfillment Foundation organized in such a way that configuration can be done for each business application separately. The following business applications can be configured within the Applications Manager:

- Distributed Order Management
- Global Inventory Visibility
- Catalog Management

- Logistics Management
- Supply Collaboration
- Reverse Logistics
- Warehouse Management
- Application Platform

1.1 Business Models

There is no single business model that encompasses the environment in which all the Sterling Commerce applications can be used. Therefore, there is no single way to configure your Selling and Fulfillment Foundation environment.

For example, your company might be considered a multi-divisional corporation, a third-party logistics company, or a marketplace business. Each of these business models require a different conceptual approach to the Selling and Fulfillment Foundation configuration.

1.1.1 Multi-Divisional Corporation

The **multi-divisional corporation model** is a business corporation whose primary focus is managing purchase and sales activities. A typical multi-divisional corporation can be a buyer, a seller, or both. It could also be a retailer, a manufacturer, or both. Whatever form the multi-divisional corporation takes, it normally has multiple channels with different types of customers, such as, consumers, retailers, dealers, and original equipment manufacturers.

In the multi-divisional corporation model, each division might be set up as an Enterprise in Sterling Commerce. This setup allows both segregation of transaction by division and global visibility at the corporate level. Each Enterprise configures its own business rules, workflow, and transaction processing.

1.1.2 Third-Party Logistics

Traditional **third-party logistics** companies provide a range of outsourced services such as warehousing, transportation, and contract manufacturing.

Large companies can gain the competitive advantage through the real-time management of their supply chains. These advantages include lower costs and improved customer service. Additionally, new sales channels such as web stores, hand-held devices, and in-store kiosks provide companies new methods of reaching their customers. All of these issues have increased the complexity of the fulfillment process.

Sterling Commerce provides the engine needed to run the operations of a contract fulfillment provider as well as a centralized system for real-time order execution and event driven problem solving for an entire fulfillment network. It enables fulfillment providers to configure the fulfillment process to meet the needs of their clients.

In the third-party logistics model, each client might be set up as an Enterprise. This setup allows the third-party logistics Hub to have visibility of all transactions in the network, while the clients that are set up as Enterprises only have visibility to their own transactions. This allows the third-party logistics business to provide unique transaction processing to its clients.

1.1.3 Marketplace

A **marketplace** is an online intermediary that connects Buyers and Sellers. Marketplaces eliminate inefficiencies by aggregating offerings from many Sellers or by matching Buyers and Sellers in an exchange or auction. For Buyers, they lower purchasing costs and help them reach new Sellers. For Sellers, they lower sales costs and give them access to new customers. It is a central location, or Hub, where a trusted intermediary integrates both procedures and technology to lower the costs and enhance the effectiveness of Buyer and Seller transactions.

In the marketplace model, each market might be set up as an Enterprise. This setup allows each market to be unique with their own product or service handling.

1.2 Warehouse Management System Configuration

The Sterling Warehouse Management System provides a comprehensive end-to-end solution that helps businesses manage inventory and processes through a networked warehouse management system.

The Sterling WMS is built using a robust architectural framework that provides enough flexibility to adapt to changing business needs. It is a web-based application providing comprehensive visibility to each warehouse in the network.

You can use the Sterling WMS configuration grouping to configure the following aspects of Selling and Fulfillment Foundation for your business application modules:

- Warehouse Layout
- Inventory
- Receiving
- Quality Control
- Picking
- VAS
- Packing
- Shipping
- Task Management
- System Administration

1.2.1 Warehouse Layout

Warehouse Layout defines the physical layout and related attributes of a warehouse.

For more information, see [Chapter 3, "Configuring Warehouse Layout"](#).

1.2.2 Inventory

Inventory defines the comprehensive functionality of Sterling WMS to track, monitor, and maintain inventory in a warehouse.

For more information, see [Chapter 4, "Configuring Inventory"](#).

1.2.3 Receiving

The process of receiving a product in the warehouse is based on the attributes of the shipment. The rules and activities expected to be performed for inventory being received is configured here.

For more information, see [Chapter 5, "Configuring Receiving"](#).

1.2.4 Quality Control

Quality Control process is integral to a warehouse to ascertain the standards of the inventory received, stored, and shipped. The parameters and common codes used in the Quality Control process is determined here.

For more information, see [Chapter 6, "Configuring Quality Control"](#).

1.2.5 Picking

The parameters and common codes used for determining algorithms and pipelines used for picking can be configured here.

For more information, see [Chapter 7, "Configuring Picking"](#).

1.2.6 Value Added Services

Use Value Added Services (VAS) to define the common codes and set-up for the Value Added Services.

For more information, see [Chapter 8, "Configuring Value Added Services"](#).

1.2.7 Packing

Packing activities in a warehouse are determined based on the strategies used in outbound planning. Use Packing to define the common codes for packing of inventory in the warehouse.

For more information, see [Chapter 9, "Configuring Packing"](#).

1.2.8 Shipping

Shipping defines the process to be followed after the completion of the Packing and VAS processes. Use Shipping to configure the common codes related to the shipping process.

For more information, see [Chapter 10, "Configuring Shipping"](#).

1.2.9 Task Management

Use Task Management to define the common codes and set up Task Types, Installation Rules, Reason Codes, User Constraints, Productivity Types, and Execution Exception.

For more information, see [Chapter 12, "Configuring Task Management"](#).

1.2.10 System Administration

Use System Administration to define common codes and set up Devices, Bar Codes, and Prints.

For more information, see [Chapter 14, "Configuring System Administration"](#).

Note: The Sterling WMS provides a set of factory defaults for the reference implementation of high-volume pick pack warehouse. This configuration data is explained in [Appendix C, "Factory Setup for High-Volume Pick Pack Warehouse"](#).

Navigating in the Applications Manager

This chapter discusses the layout of the Selling and Fulfillment Foundation Applications Manager, actions you can perform throughout the application, and important concepts you should be aware of before using the application.

2.1 Starting the Selling and Fulfillment Foundation Applications Manager

To access the Selling and Fulfillment Foundation Applications Manager:

1. Point your browser to:

```
http://<Server where Selling and Fulfillment Foundation are  
installed>/smcfs/console/start.jsp
```

The browser now displays the Sign In window.

2. Enter your login ID and password and choose the Sign In button. The Console Home Page displays.
3. From the menu bar, choose Configuration > Launch Applications Manager. The Applications Manager opens in a new window.

2.2 The Selling and Fulfillment Foundation Applications Manager Layout

The Selling and Fulfillment Foundation Applications Manager is a graphical user interface that can be used to configure different aspects of Selling and Fulfillment Foundation. The different configurations are defined by logical groupings called applications that can be accessed from the Applications Manager menu bar.

Figure 2–1 Applications Menu

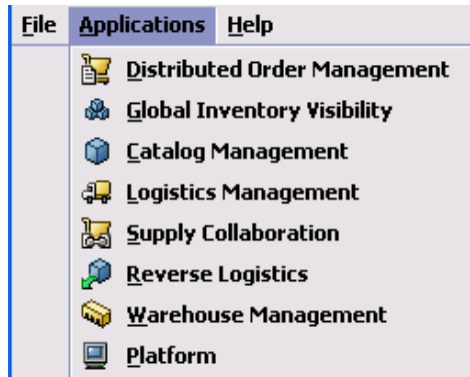

Each application focuses on a particular aspect of Selling and Fulfillment Foundation and contains all of the rules, common codes, and settings necessary for Selling and Fulfillment Foundation to work in a real-world business setting.

The following applications can be configured in this version of Selling and Fulfillment Foundation:

- Sterling Distributed Order Management
- Sterling Global Inventory Visibility
- Catalog Management
- Sterling Logistics Management
- Sterling Supply Collaboration
- Sterling Reverse Logistics
- Sterling Warehouse Management System
- Application Platform

When you select the application that you want to configure, the Applications Manager displays a side panel containing all of the available configuration rules for the selected application and a work area in which these rules can be configured.

If you select the Warehouse Management application, the system prompts you to select the node and enterprise you need to configure.

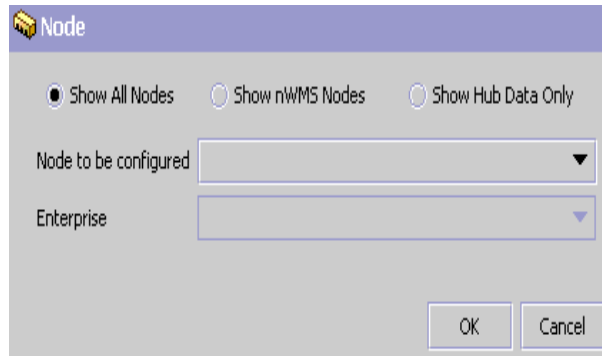

Note: On selecting the Show Hub Data Only option, the option to select the Node and Enterprise gets disabled, and the Application Rules Side Panel loads all the HUB-level data.

Once you select the node, the Standard Application Interface displays as illustrated in [Figure 2–2](#).

Figure 2–2 The Standard Application Interface

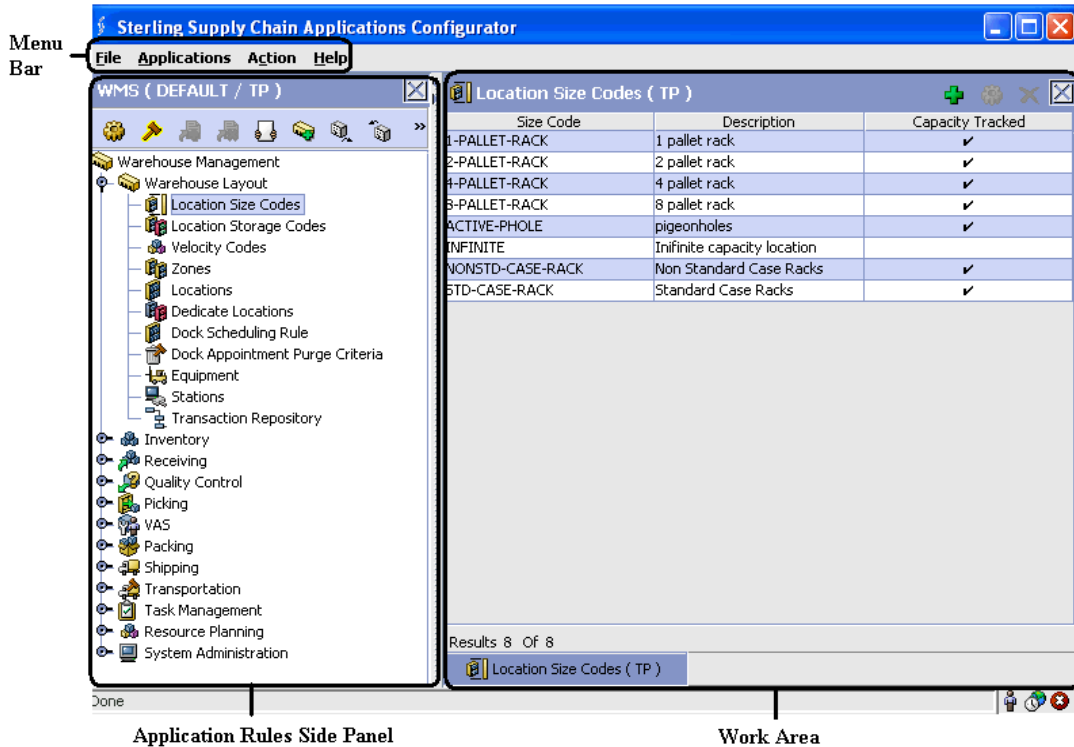

2.2.1 Application Rules Side Panel

The application rules side panel displays a hierarchical tree of elements specific to processes used within the application.

The application rules side panel also identifies the organization you are configuring rules for and what, if any, rules are inherited from another organization.

You can use the application rules side panel for:

- [Accessing Configuration Screens](#)
- [Determining Inheritance](#)
- [Loading Another Node's Rules](#)

- [Filtering Application Rules](#)
- [Copying an Existing Node to a New Node](#)
- [Onboarding an Enterprise to a Node](#)
- [Offboarding an Enterprise from a Node](#)
- [Deleting the Current Node](#)

2.2.1.1 Accessing Configuration Screens

The main purpose of the application rules side panel is to provide an interface to access the application's individual configuration screens. To access a configuration screen, browse through the application tree and double-click on the applicable configuration element, the element's configuration screen then displays in the work area.

Alternatively, select applicable configuration element, and choose  to access relevant configuration screen.

2.2.1.2 Determining Inheritance

In Selling and Fulfillment Foundation, when an Enterprise is created it can inherit all or part of an existing Enterprise's configuration rules. This inheritance is done at the configuration group level. A configuration group is a classification of similar configuration elements. For example, all of the rules and configurations dealing with items are grouped together into one configuration group and all of the rules and configurations dealing with organizations are grouped into another.

An administrator organization is set for every organization defined within the system. Only the administrator organization can modify the rules defined for a particular organization. If a particular organization administers multiple organizations, then they can load the rules of organization that it administers within the application tree. For more information about loading another organization's rules, see [Section 2.2.1.3, "Loading Another Node's Rules"](#) on page 16.

Configuration groups are associated with organization levels. Organization levels determine how configuration groups are inherited and which organizations can maintain them. The organization levels defined in Selling and Fulfillment Foundation are:

- Hub Level - Configuration groups that are associated with the Hub organization

- Enterprise Level - Configuration groups that are associated with the individual Enterprise organizations within the Hub environment
- Catalog Organization - Configuration groups that are associated with the organization(s) that maintains the catalog(s) within the Hub environment
- Inventory Organization - Configuration groups that are associated with the organization(s) that maintains the inventory within the Hub environment
- Organization - Configuration groups that are associated with any organization within the Hub environment.

The following table details the rules used to determine which organizations can maintain a configuration group as defined by the organization level. The table also describes the rules that determine how configuration groups are inherited when an organization is created.

Table 2–1 Organization Level Rules

Organization Level	Organizations That Can Modify at this Level...	Inheritance Details
Hub Level	Only the Hub organization can modify configuration groups at the Hub level. All other organizations have read-only access.	All organizations share this information.
Enterprise Level	Only Enterprise organizations can modify configuration groups at the Enterprise level. Any business transaction requiring Enterprise configuration is picked up from the Enterprise established by the transactional context. For example, order documents have a specific Enterprise.	An Enterprise can inherit this configuration from another Enterprise. Additionally, this configuration can be overridden at a configuration group level. When an Enterprise is created, it inherits Enterprise level rules from its primary Enterprise.
Catalog Organization	Organizations that are designated as catalog organizations can modify configuration groups at the catalog organization level.	None.

Table 2–1 Organization Level Rules

Organization Level	Organizations That Can Modify at this Level...	Inheritance Details
Inventory Organization	Organizations that are designated as inventory organizations can modify configuration groups at the inventory organization level.	None.
Organization	Any organization assigned a role (Seller, Buyer, etc.) can modify configuration groups at the organization level.	None.

Important: You cannot inherit from an Enterprise that does not have the same inventory, capacity, and catalog organizations as the organization you are configuring.

The application rules side panel displays rules that have been inherited as grayed out.

Figure 2–3 Inherited Rules in the Application Rules Side Panel

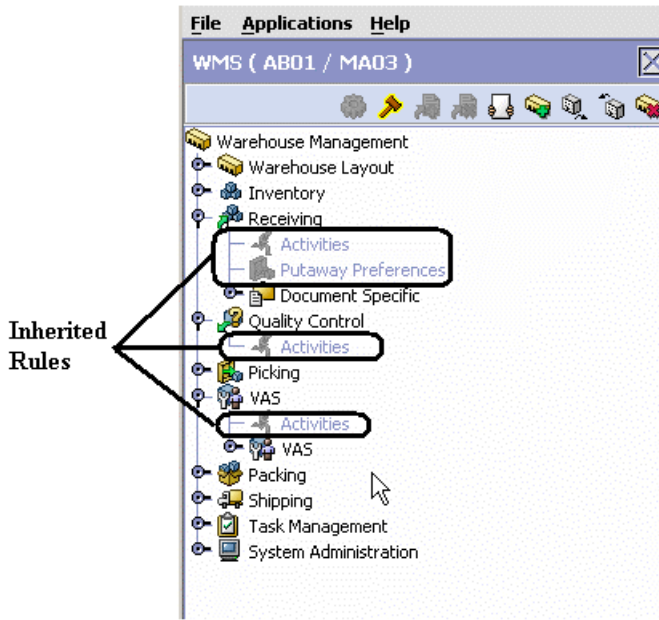

As stated in the table above, depending on the organization you are logged in as, you may be able to override some inherited rules. If a rule can be overridden, the Override Configuration icon becomes available in the application rule side panel when you highlight the rule.

Figure 2–4 Override Configuration Icon
Load Override Configuration Icon is Available

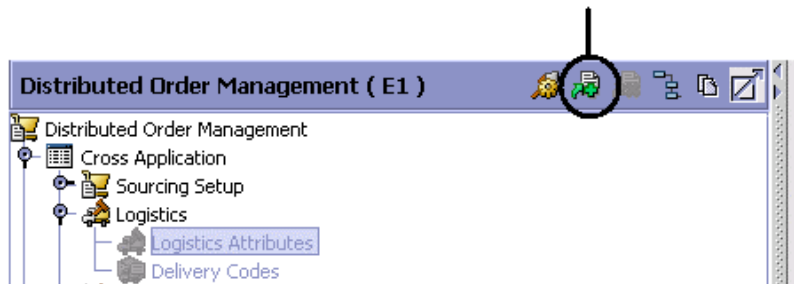

When you choose to override a rule you also override any other rules in the configuration group the rule you are overriding is associated with.

When you choose the Override Configuration icon the Configuration Override Details pop-up window displays. This window provides the list of rules that are overridden.

Figure 2–5 Example of Configuration Override Details Pop-Up Window

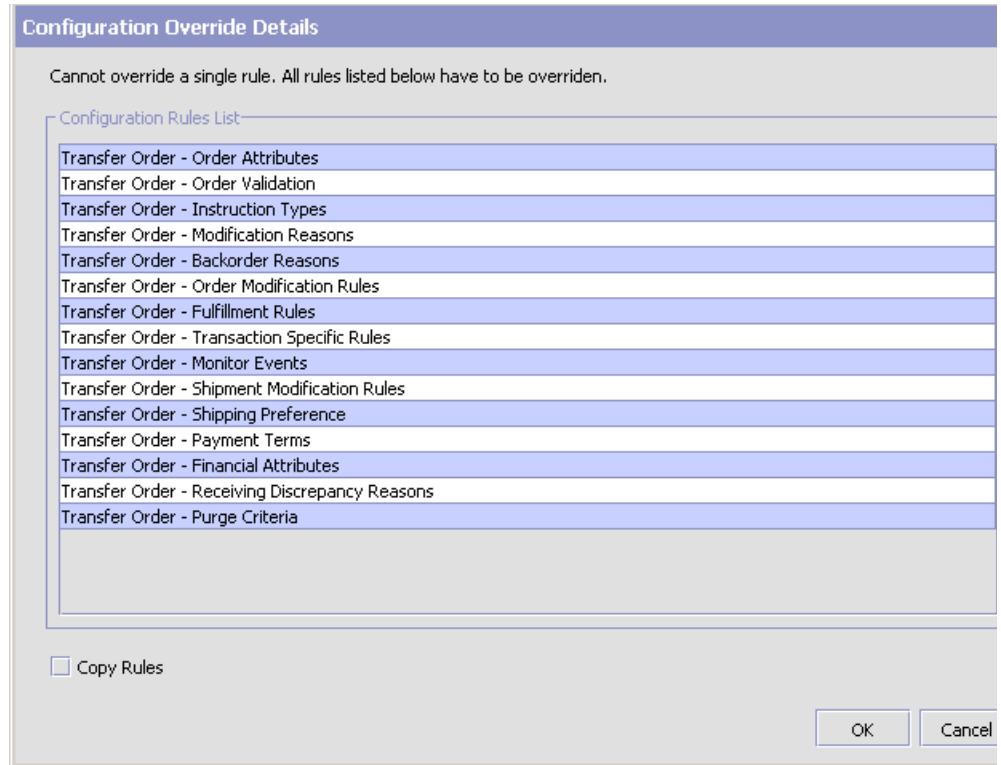

If you override a configuration group and then decide to "re-inherit" the original rules, you can choose the Give Back Configuration Ownership icon. This icon becomes available in the application rules side panel for rules that have been overridden.

Figure 2–6 Give Back Configuration Ownership Icon is Available

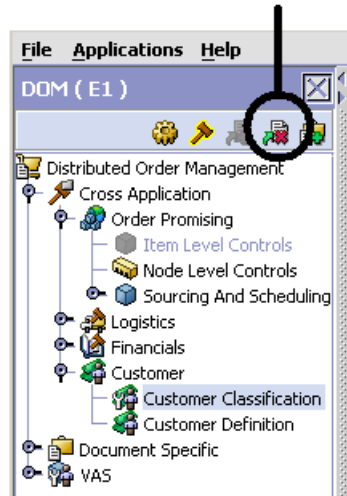

2.2.1.3 Loading Another Node's Rules

An administrator organization is set for every enterprise (organization) defined within the system. Only the administrator organization can modify the rules defined for a particular enterprise or node.

If a particular organization administers multiple nodes, then it can load the rules of the nodes that it administers within the application tree.

See [Table 2–1](#) for the rules that determine which organizations you can administer.

Note: The rules that are available from the tree in the application rules side panel vary depending on the type of organization you select and the roles it has been assigned.

To load another node's rules in Warehouse Management System:

1. From the application rules side panel, choose . The Node pop-up window displays.

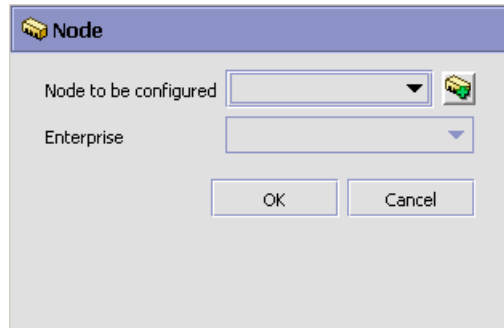

2. From Node to be configured, select the Ship Node that you want to work with.
3. From Enterprise, select the Node's Enterprise that you want to configure.
4. Choose OK. The node's rules display in the application rules side panel.

Note: The application rules side panel displays the node and enterprise you are working with in parentheses.

2.2.1.4 Filtering Application Rules

The application rules side panel by default displays all the rules available for a user. The application rules may be filtered to display specific rules, grouped by CatalogOrg, Enterprise, Hub, InventoryOrg, Node or Organization level, using the Filter Rules functionality.

To filter application rules in the application rules side panel:

1. From the application rules side panel, choose . The Filter Rules pop-up window displays.

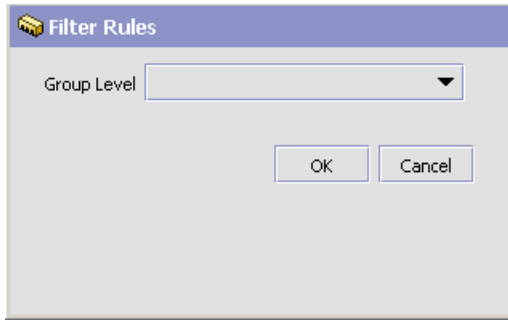

2. From Group Level, select the level you want to filter rules in the application side panel. The application rules can be filtered by CatalogOrg, Enterprise, Hub, InventoryOrg, Node and Organization.
3. Choose OK. The applicable rules display in the application rules side panel.

2.2.1.5 Copying an Existing Node to a New Node

The Sterling WMS provides a Rapid Deployment Tool (RDT) feature to copy the configuration of one WMS node to another new WMS node. For more information about RDT features see the *Selling and Fulfillment Foundation: Integration Guide*.

The Copy Node feature is useful in implementations having multiple nodes with similar, if not identical, configurations. If there are many thousands of locations, rollback errors may be thrown, in which case the rollback segment needs to be increased.

For more information about the configurations that are copied when copying a node, see [Appendix D, "Copy Node Functionality"](#).

Important: When you copy a node, the system automatically copies the Fill Code data from the source node to the newly copied node, irrespective of the inventory status. For details about fill code, see [Table 3–7](#).

It is recommended that the Copy Node be used at a time of the day when there are no competing updates to the Configuration.

To copy an existing node to a new node:

1. From the application rules side panel, choose . The Copy Node pop-up window displays.

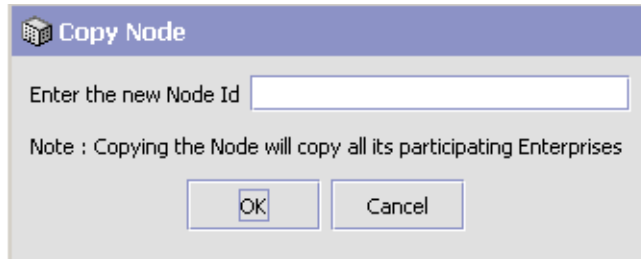

The image shows a dialog box titled "Copy Node". It has a blue header bar with a cube icon and the text "Copy Node". Below the header, there is a text input field with the label "Enter the new Node Id". Underneath the input field, there is a note: "Note : Copying the Node will copy all its participating Enterprises". At the bottom of the dialog, there are two buttons: "OK" and "Cancel".

2. Enter the ID for the new node being created by copying the existing node. You can enter the ID of a node you want to create or the ID of an existing node that is not configured.

Note: Sterling Commerce recommends that you do not enter the ID of an existing node that is configured. This is because when the system copies the source node configuration, there may be conflicts with the existing configuration which may result in an exception.

3. Choose OK. The new node is created with all configuration data of the existing node, including all the participating enterprises.

Note: You can copy a WMS node to an existing DOM node.

2.2.1.6 Onboarding an Enterprise to a Node

A new participation between an enterprise and a node can be created using the Sterling WMS RDT feature. The creation of this participation

between the enterprise and an existing node is called onboarding an enterprise to a node.

For more information on the configurations that are copied when onboarding an enterprise to a node, see [Appendix E, "Onboarding Enterprise to Node Functionality"](#)

To onboard an enterprise to the current node:

1. From the application rules side panel, choose . The Onboard New Enterprise pop-up window displays.



The image shows a dialog box titled "Onboard New Enterprise". It has a header bar with a small icon and the title. Below the header, the text "Select the Enterprise" is followed by a dropdown menu. Underneath the dropdown is a checkbox labeled "Model the Enterprise on existing relationship". Below the checkbox is another dropdown menu. At the bottom of the dialog are two buttons: "OK" and "Cancel".

2. Select the Enterprise to be onboarded to the node from the drop down menu. This lists all the enterprises existing in the Application Platform but not participating with the current node.
3. If the relationship shared with the new onboarded Enterprise is same as any other existing Enterprise, select the 'Model the Enterprise on existing relationship' and choose relevant Enterprise from the drop down.
4. Choose OK. The new enterprise is onboarded to the current node, and where applicable modeled on an existing relationship.

2.2.1.7 Offboarding an Enterprise from a Node

The participation between an enterprise and a node can be removed using the Sterling WMS RDT feature. The deletion of the participation between the onboarded enterprise and the node is called offboarding an enterprise from a node.

To offboard an enterprise from the current node:

1. From the application rules side panel, choose . The Offboard an Enterprise pop-up window displays.

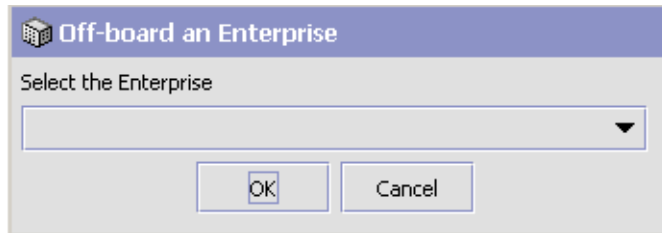

2. Select the Enterprise to be offboarded from the drop down menu. This lists all the enterprises currently participating (onboarded) with the current node.
3. Choose OK. The selected enterprise is offboarded from the current node.

Note: If the Node contains inventory for this Enterprise in any location, then the Enterprise is not offboarded.

2.2.1.8 Deleting the Current Node

The Sterling WMS RDT feature can be used to delete the current WMS Node. This action deletes the current node, and all existing participations with Enterprises onboarded to the node.

To delete the current node:

1. From the application rules side panel, choose . A warning message 'Are you sure you want to delete the current node?' displays.
2. Click 'OK' to delete the node. Alternatively, click 'Cancel' to cancel the deletion.

Note: If any of the participating Enterprises in the Node contain inventory, then the Node is not deleted.

2.2.2 Work Area

The work area is the main area in which different configuration screens appear. The following are the main types of screens that can be seen:

- [Search Window](#)
- [List Window](#)
- [Details Window](#)
- [Drag and Drop Window](#)

2.2.2.1 Search Window

A search window provides you with a means to perform a filtered search. The upper panel of a search window offers criteria applicable to the entity you are searching through which you can narrow your search. The lower panel lists the results of a search once it has been performed.

Figure 2–7 Search Window Example

Search Criteria

Location: [Dropdown] [Text Box] Zone: [Dropdown] [Text Box]

Aisle #: [Text Box] Location Type: [Dropdown] [Green Plus]

Empty Location Size Code: [Dropdown] [Green Plus]

No In Staging Location In Staging Location: [Dropdown] [Green Plus]

No Out Staging Location Out Staging Location: [Dropdown] [Green Plus]

Freeze for Putaway Velocity Code: [Dropdown] [Green Plus]

Freeze for Picking Storage Code: [Dropdown] [Green Plus]

Max Records: [Text Box] (200)

Search Results

Location	Zone	Location Type	Storage Code	Putaway Sequenc...	Picking Sequence #	Velocity Code
01010101	CASE1	REGULAR	REGULAR	1,010,101	1,010,101	A
01010102	CASE1	REGULAR	REGULAR	1,010,102	1,010,102	A
02010101	CASE1	REGULAR	REGULAR	2,010,101	2,010,101	A
50010101	CASE2	REGULAR	REGULAR	50,010,101	50,010,101	B
50010102	CASE2	REGULAR	REGULAR	50,010,102	50,010,102	B
75010101	PALLETRACK	REGULAR	REGULAR	75,010,101	75,010,101	C
75010102	PALLETRACK	REGULAR	REGULAR	75,010,102	75,010,102	C
99999991	INFINITE	STAGING		99,999,999	99,999,999	C
99999992	INFINITE	STAGING		99,999,999	99,999,999	C
A1010101	ACTIVE	REGULAR		11,010,101	51,010,101	C
A1010102	ACTIVE	REGULAR		11,010,102	51,010,102	C
DOCK	DOCK	DOCK		1	1	C
FL01	INFINITE	STAGING		1	1	C
MNFST1	SHIP	STAGING		9,999,999	9,999,999	C
PACK1	PACK	STAGING		9,999,999	9,999,999	C

Results 19 Of 19

2.2.2.2 List Window

When you choose to configure a specific rule or code that does not require a search, the Applications Manager may display a basic list window of the rules and codes that have previously been configured.

Figure 2–8 List Window Example

Inventory Status	Description	Supply Type
D	dd	ONHAND
N	Normal	ONHAND
Q	Quality	HELD
*		

Results 3 Of 3

Inventory Status List

2.2.2.3 Details Window

A details window is the main interface through which a bulk of the configuration is done. A details window can contain editable fields and tables, tabs to configure different aspects of an entity, and additional actions that can be performed on an entity.

Figure 2–9 Details Window Example

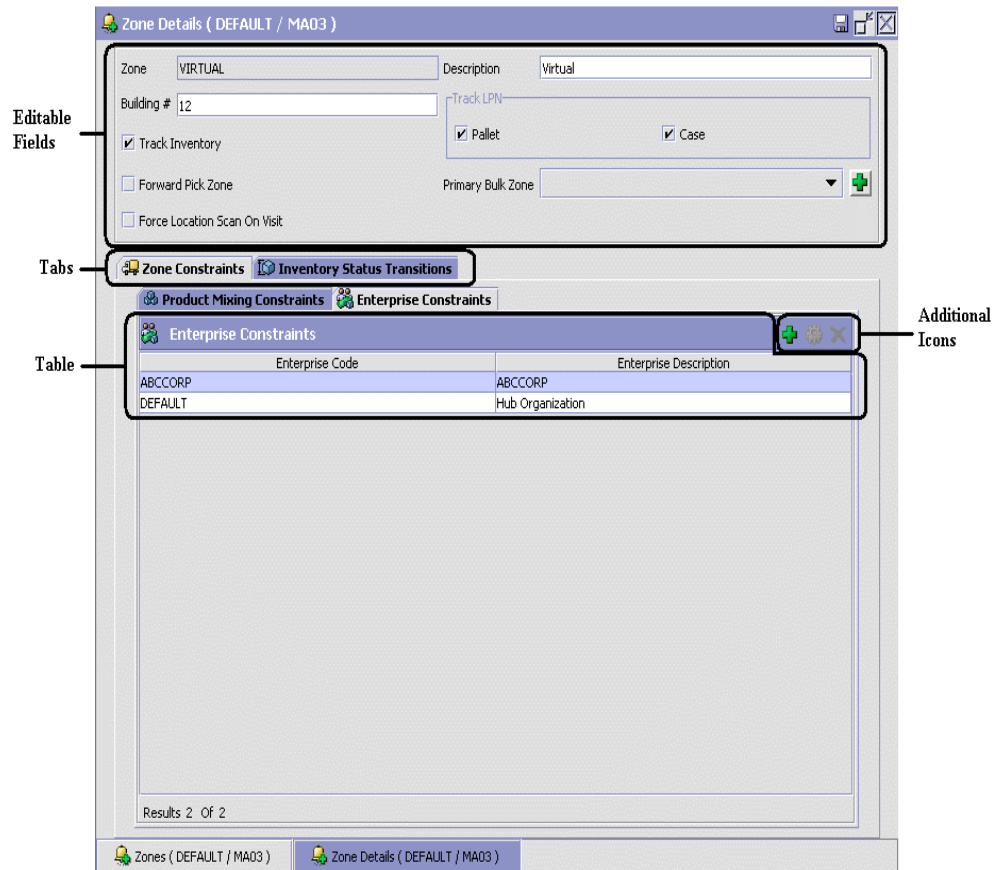

2.2.2.4 Drag and Drop Window

You can use a graphical drag and drop window to ease the construction of pipelines, pipeline determination, event handlers, status monitoring rules, and services. A drag and drop window consists of a pallet and a graphical work area.

Figure 2–10 Drag and Drop Window Example

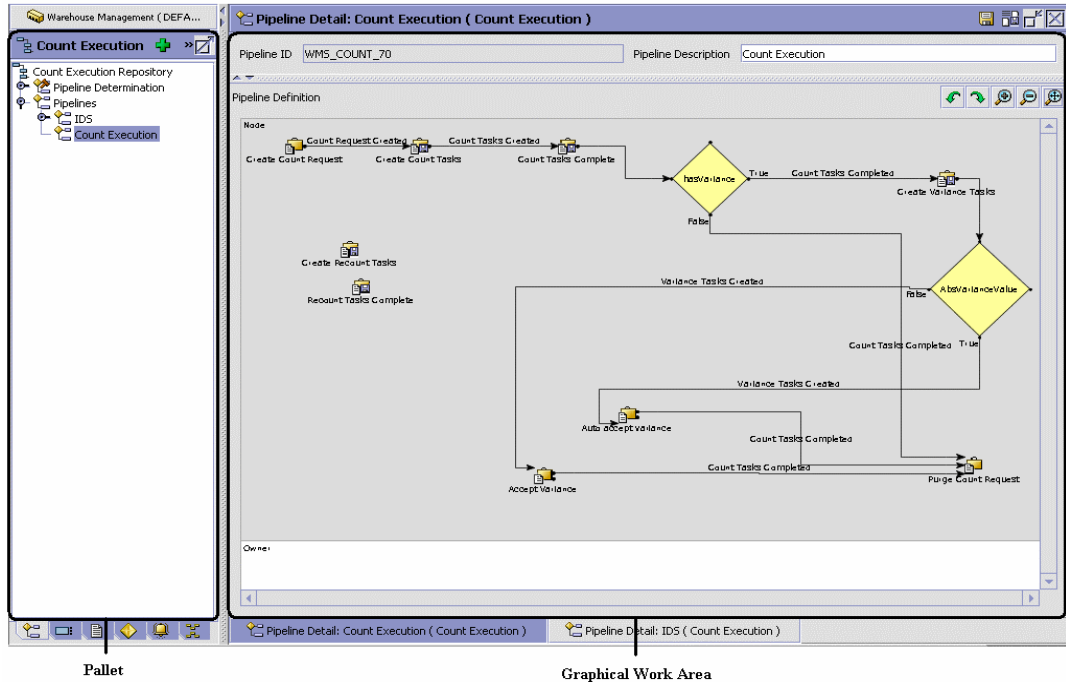

To begin building any of these entities, choose a component, such as a transaction, from the pallet. Drag the component into the graphical work area. The transaction displays as a graphical representation of itself.

Many components have one or more branches. To connect the next component to the originating component, you must drag the graphical component until it forms a connecting line with one of the other component's sides, links can be set up horizontally or vertically. To delete any components or links, right-click the component and choose Delete. Once components and links have been established you can move them around by dragging them, the links redraw themselves according to the new position. If you hold CTRL while dragging a component, the component is copied within the graphical work area.

2.3 Actions Available the Selling and Fulfillment Foundation Applications Manager

The following actions can be performed throughout the Selling and Fulfillment Foundation Console:

- [Using Applications Manager's Lookup Functionality](#)
- [Viewing the User Logged into the Applications Manager](#)
- [Using Lists and List Filtering](#)
- [Using On-Line Help](#)
- [Troubleshooting Errors](#)
- [Using Special Characters](#)

2.3.1 Using Applications Manager's Lookup Functionality

Throughout the Selling and Fulfillment Foundation Applications Manager there are many fields that have a lookup functionality to find or create additional records as they pertain to that field. For example, on the Primary Info tab of the Organization Details screen, the Locale field has a lookup functionality to create a new locale from that screen. When you choose the Create New lookup button the Locale Details information displays in a pop-up screen for you to modify.

Figure 2–11 Lookup Icon Example



The information that displays in a lookup field varies depending on how many records you have pertaining to that particular field. When there are 20 or less records, the lookup displays as a drop-down list with a Create New button. When there are between 21 and 75 records, the lookup displays as a drop-down list with a Search button.

When there are more than 75 records, the lookup displays as a text box with a Search button. You can type the value in the text box or search for the value using the Search button. If you enter a value, it is validated when it is saved. You should always type the value as it would appear if it

was displayed as a drop-down list. For example, for a currency lookup, you should type the currency description in the text box even though the currency code is saved in the table. An error displays on save if the user has entered an invalid value.

When you use a lookup for a particular field in the Applications Manager, you should refer to the corresponding section in this guide to set up the particular information.

2.3.2 Viewing the User Logged into the Applications Manager

You can view the user logged into the Applications Manager and their locale at any time. To view this information, move your mouse over the User icon and Locale icons in the bottom right-hand corner of the application to display the tool tips.

2.3.3 Using Lists and List Filtering

When you perform a search in the Applications Manager, a list of entities is returned in a search results list based on the criteria you searched on. You can filter and arrange any information that displays in a list by right-clicking anywhere on the list's column headings and using the Table Filter Editor associated with the list.

Figure 2–12 Table List Editor Window Example

The screenshot shows a dialog box titled "Table List Editor". At the top left, there is a checkbox labeled "Apply To Existing Records" which is currently unchecked. To its right is a text field labeled "Max Records" containing the value "100". Below these are two rows of controls. The first row is labeled "Hold Type" and contains a dropdown menu with a downward arrow and an adjacent empty text input field. The second row is labeled "Hold Type Description" and also contains a dropdown menu with a downward arrow and an adjacent empty text input field. At the bottom of the dialog, there are three buttons: "OK", "Cancel", and "Reset".

Important: When you perform a search, only 100 records are listed by default. Use the list's Table Filter Editor to increase the maximum amount of records returned by a search.



2.3.4 Using On-Line Help

You can access the Selling and Fulfillment Foundation Online Help through Help > Online Help.

2.3.5 Troubleshooting Errors

You can view the description and cause of any error raised in Selling and Fulfillment Foundation, as well as actions to take to troubleshoot it.

To view the Selling and Fulfillment Foundation system error descriptions:

1. From the menu bar, choose Help > Troubleshooting. The Error Search window displays.
2. Enter the applicable search criteria and choose . A list of error codes and its description displays.
3. Choose  to view the cause of the error and action to take to troubleshoot it.

2.3.6 Using Special Characters

Throughout the Applications Manager, there may be instances where you need to use special characters during data entry. For information about the use of special characters in the Selling and Fulfillment Foundation, see the *Selling and Fulfillment Foundation: Customization Basics Guide*.

3

Configuring Warehouse Layout

Warehouse Layout defines the physical layout and related attributes of a warehouse.

Use Warehouse Layout for:

- [Defining Location Size Codes](#)
- [Defining Location Storage Codes](#)
- [Defining Velocity Codes](#)
- [Defining Zones](#)
- [Defining Zone Constraints](#)
- [Defining Locations](#)
- [Defining Dedicate Locations](#)
- [Defining Dock Scheduling Rule](#)
- [Defining Equipment](#)
- [Defining Stations](#)
- [Defining Transaction Repository](#)

3.1 Defining Nodes

A *Node* (also called a warehouse) is an entity that receives or ships inventory. A node in Sterling Warehouse Management System belongs to an organization or enterprise, and may be shared across all enterprises.

For example, nodes are used by buyer organizations for receiving inventory, and by seller organizations for shipping inventory. A carrier

organization, on the other hand, uses nodes both for shipping and delivering inventory.

A node in the Sterling WMS is defined for all types of warehouses including, distribution centers, flow-through centers, returns or VAS centers, and third-party distribution locations. For more information about defining a node, see the *Selling and Fulfillment Foundation: Application Platform Configuration Guide*.

3.1.1 Configuring a Node

The Sterling Warehouse Management System has been designed to support a Level 2 or Level 3 warehouse. This ensures that the Sterling WMS automatically supports the Level 1 warehouse.

See [Table 3–1](#) for a list of the standard capabilities of different Warehouse Levels and their adoption rate (Source: AMR Research).

Table 3–1 Warehouse Levels and Capability

WMS Level	Capability	Adoption
Level 1	Manual picking & receiving operation No location level inventory	35%
Level 2	Order release with pre-sequencing, sorting and grouping Real time stock updates Limited storage capabilities/location level inventory	45%

Table 3–1 Warehouse Levels and Capability

WMS Level	Capability	Adoption
Level 3	Task management Real time optimization Cross dock and flow through processing Radio frequency integration Material handling equipment	20%
Level 4	Advanced labor planning 3D co-ordinates Cost optimization of pick path and slotting Facility and equipment design integration Advanced scenario simulations	Less than 2%

A warehouse may be configured using either the “Application Consoles” interface or “Networked WMS” interface, depending on the kind of functionality that the node requires.

A node that uses the “Networked WMS” interface has all the WMS features available, irrespective of it being Level 1 or Level 3. On the other hand, a node using the “Application Consoles” interface has lesser features available. For a list of the functionalities available to a node using the “Application Consoles” interface, see [Table 3–2](#).

The need for “Application Consoles” interface is explained in these use-cases:

- Drop Ship Suppliers need visibility to the orders that they have to pick, pack, and ship. The “Application Consoles” interface provides a real time view to all their orders, and ability to print pick/pack lists, record packing information, print shipping labels/carrier compliant labels, print BOLs, and confirm shipment of these orders through parcel/LTL carriers. Drop Ship Supplier may or may not track inventory on the Sterling WMS.
- Vendors of a buyer enterprise need visibility to POs placed by the enterprise, to create ASNs for the products shipped by them. These vendors may not track inventory on the Sterling WMS.

For more information about these interfaces and how to configure them, see the *Selling and Fulfillment Foundation: Application Platform Configuration Guide*.

Table 3–2 Application Consoles Functionalities

Functionality	Availability in Interface
Warehouse layout: Location, Zone definition	No
Inventory: Location level inventory/LPN inventory	No
Count	No
Task Management	No
Receipt	No
Inspection	Yes
Putaway	No
Kitting: Made to Stock & Made to Order	Yes
Shipment creation and confirmation	Yes
ESP Check	No
Shipment Routing	No
Pick List Print	Yes
Wave planning	No
Containerization	Yes
Batching	No
Replenishment	No
Picking	No
Packing	Yes
Shipping Labels	Yes
Pack List	Yes
Post pick VAS	No
Build Pallet containing Cases	No
BOL Print	Yes

Note: For more information about defining node attributes, see the *Selling and Fulfillment Foundation: Application Platform Configuration Guide*.

3.2 Defining Location Size Codes

A *Location Size Code* defines the capacity of a location. The capacity of a location is specified by its length, width and height. The additional attributes are explained in [Table 3–3](#).

Use Location Size Codes for:

- [Creating a Location Size Code](#)
- [Modifying a Location Size Code](#)
- [Deleting a Location Size Code](#)

3.2.1 Creating a Location Size Code

To create a location size code:

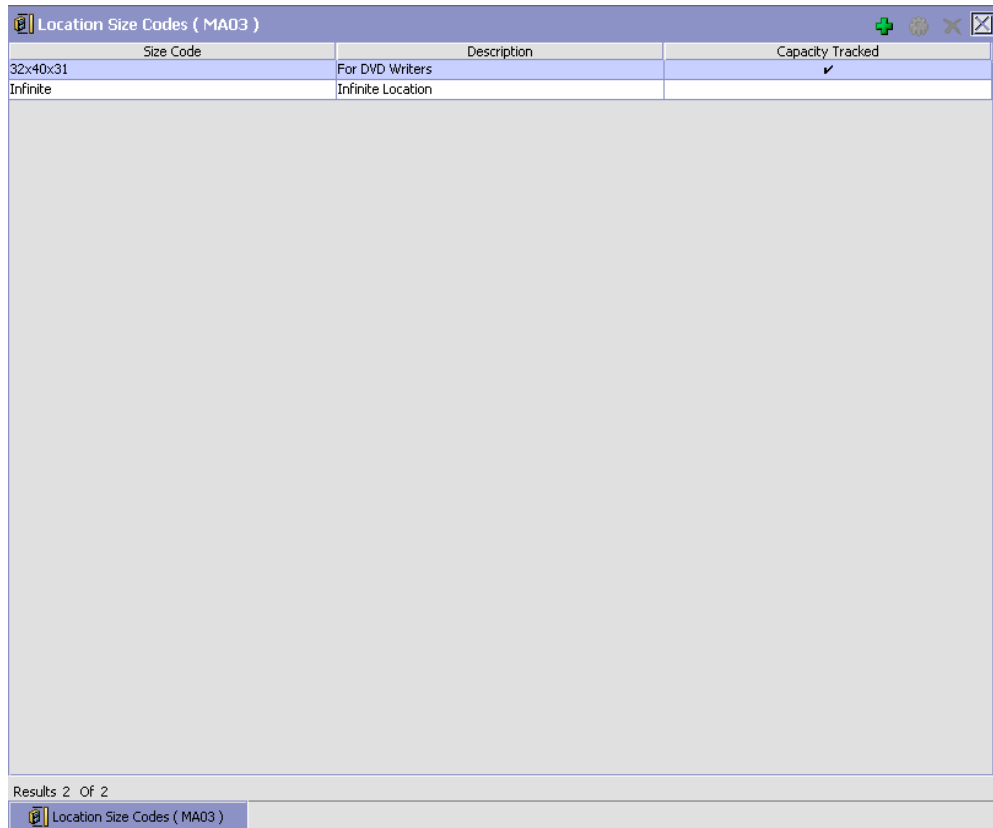

1. From the tree in the application rules side panel, choose Warehouse Layout > Location Size Codes. The Location Size Codes window displays.



Size Code	Description	Capacity Tracked
32x40x31	For DVD Writers	<input checked="" type="checkbox"/>
Infinite	Infinite Location	<input type="checkbox"/>

Results 2 Of 2

Location Size Codes (MA03)

2. In the Location Size Codes window, choose . The Location Size Code Details window displays.
3. Enter information in the applicable fields. See [Table 3–3](#) for field value descriptions.
4. Choose .

Location Size Code Details (MA03)

Location Size Code: 32x40x31 Description: For DVD Writers

Capacity Tracked Single Deep

Length: 20 IN Width: 30 IN Height: 20 IN

Volume: 12,000 CIN Max Weight: 22,222,222 LBS

Capacity Constraints			
Enterprise Code	Item Size Classification	UOM	No. of Packages
*			

Results 0 Of 0

Location Size Codes (MA03) Location Size Code Details (MA03)

Table 3–3 Location Size Code Details Window

Field	Description
Location Size Code	Enter the location size code. The list of location size codes is reflective of the different types of storage in the warehouse. Typically only large variances in the capacity are broken up into different size codes.
Description	Enter a brief description for the location size code.
Capacity Tracked	Select only if the location size tracks the capacity.

Table 3–3 Location Size Code Details Window

Field	Description
Single Deep	Select only if the location is single deep. A location is single deep if the depth of the location is such that it can only hold one LPN.
Length	Enter the length of the location. The length UOM is populated automatically from the node's locale.
Width	Enter the width of the location. The width UOM is populated automatically from the node's locale.
Height	Enter the height of the location. The height UOM is populated automatically from the node's locale.
Volume	Indicates the volume of the location. The volume UOM is populated automatically from the node's locale.
Max Weight	Enter the maximum weight that the location can hold. The weight UOM is populated automatically from the node's locale.
Capacity Constraints	
Specifying Capacity Constraints is optional. For example, capacity constraints would not be set up for a location size marked as INFINITE.	
Enterprise Code	Select the enterprise that is placing capacity constraints for the size code. Enterprise code is a mandatory field, to specify the other attributes.
Item Size Classification	Enter the item classification that is placing capacity constraints for the size code.

Table 3–3 Location Size Code Details Window



Field	Description
UOM	Select the unit of measure that is placing capacity constraints for the size code. The list of valid UOMs for the enterprise is automatically populated.
No of Packages	Enter the maximum number of packages that the size code can hold for the capacity constraints specified. For example, a size code for a single pallet location can hold one package of UOM type SINGLE-PALLET. A size code of multi-case location can hold two packages of UOM type CASE.

Note: It is recommended that the most frequently used locations/docks/stations are set up with a size code that does not track capacity (i.e. infinite capacity locations). Performance of operations like receiving, putaway, shipping, and packing are greatly enhanced if the locations/station locations are modelled as infinite.

3.2.2 Modifying a Location Size Code

Once a location size code has been created, it can be modified.

To modify a location size code:

1. From the tree in the application rules side panel, choose Warehouse Layout > Location Size Codes. The Location Size Codes window displays with the list of Location Size Codes.
2. Choose the Location Size Code to be modified. Choose .
3. The Location Size Code Details window displays.
4. Enter information in the applicable fields. See [Table 3–3](#) for field value descriptions.
5. Choose .

3.2.3 Deleting a Location Size Code

To delete a location size code:

1. From the tree in the application rules side panel, choose Warehouse Layout > Location Size Codes. The Location Size Codes window displays with the list of Location Size Codes.
2. Choose the Location Size Code to be deleted.
3. Choose .

A location size code cannot be deleted if there are locations using the size code.

3.3 Defining Location Storage Codes

A *Location Storage Code* indicates the storage classification for a location. Location storage code allows a warehouse to store all items of a given storage profile at the same location.

For example, inflammable items are stored in locations equipped to handle fire hazards. Marking all suitable locations with a certain storage code ensures that inflammable items are stored safely at these fireproof locations.

Use Location Storage Codes for:

- [Creating a Location Storage Code](#)
- [Modifying a Location Storage Code](#)
- [Deleting a Location Storage Code](#)

3.3.1 Creating a Location Storage Code

To create a location storage code:

1. From the tree in the application rules side panel, choose Warehouse Layout > Location Storage Codes. The Location Storage Codes window displays.
2. Enter information in the applicable fields. See [Table 3–4](#) for field value descriptions.
3. Choose .

The screenshot shows a software window titled "Location Storage Codes (DEFAULT / MA03)". The window contains a table with two columns: "Storage Code" and "Description". The table is currently empty, with only a header row and a single row containing an asterisk (*) in the "Storage Code" column. Below the table, the text "Results 0 Of 0" is displayed. The window title bar includes standard icons for close, save, and maximize.

Storage Code	Description
*	

Results 0 Of 0

Table 3–4 Location Storage Codes Window

Field	Description
Storage Code	<p>Enter the storage code.</p> <p>A storage code reflects the different types of locations in the warehouse. For example, locations to store inflammable items, locations to store SKU that require refrigeration, or locations that store regular SKU.</p> <p>The storage code is assigned to a location, and used by the putaway and retrieval algorithms. Enterprise specific SKU classifications are mapped to a storage code in Putaway Preferences and Retrieval Preferences.</p> <p>For more information about Putaway Preferences, see Section 5.2, "Defining Putaway Preferences" on page 276.</p>
Description	Enter a brief description for the storage code.

3.3.2 Modifying a Location Storage Code

Once a location storage code has been created, it can be modified.

To modify a location storage code:

1. From the tree in the application rules side panel, choose Warehouse Layout > Location Storage Codes. The Location Storage Codes window displays with the list of location storage codes.
2. Enter information in the applicable fields. See [Table 3–4](#) for field value descriptions.
3. Choose .

3.3.3 Deleting a Location Storage Code

To delete a location storage code:

1. From the tree in the application rules side panel, choose Warehouse Layout > Location Storage Codes. The Location Storage Codes window displays with the list of location storage codes.
2. Choose the Location Storage Code to be deleted.
3. Choose .

A location storage code cannot be deleted if there are locations using the storage code.

3.4 Defining Velocity Codes

Velocity Codes are attributed to a location. A velocity code associates the location to a SKU's throughput.

For example, fast moving items are stored in the lower level locations, or locations reachable by hand, in the bulk zone.

Use Velocity Codes for:

- [Creating a Velocity Code](#)
- [Creating a New Velocity Code from an Existing Velocity Code](#)
- [Modifying a Velocity Code](#)
- [Deleting a Velocity Code](#)

3.4.1 Creating a Velocity Code

To create a velocity code:

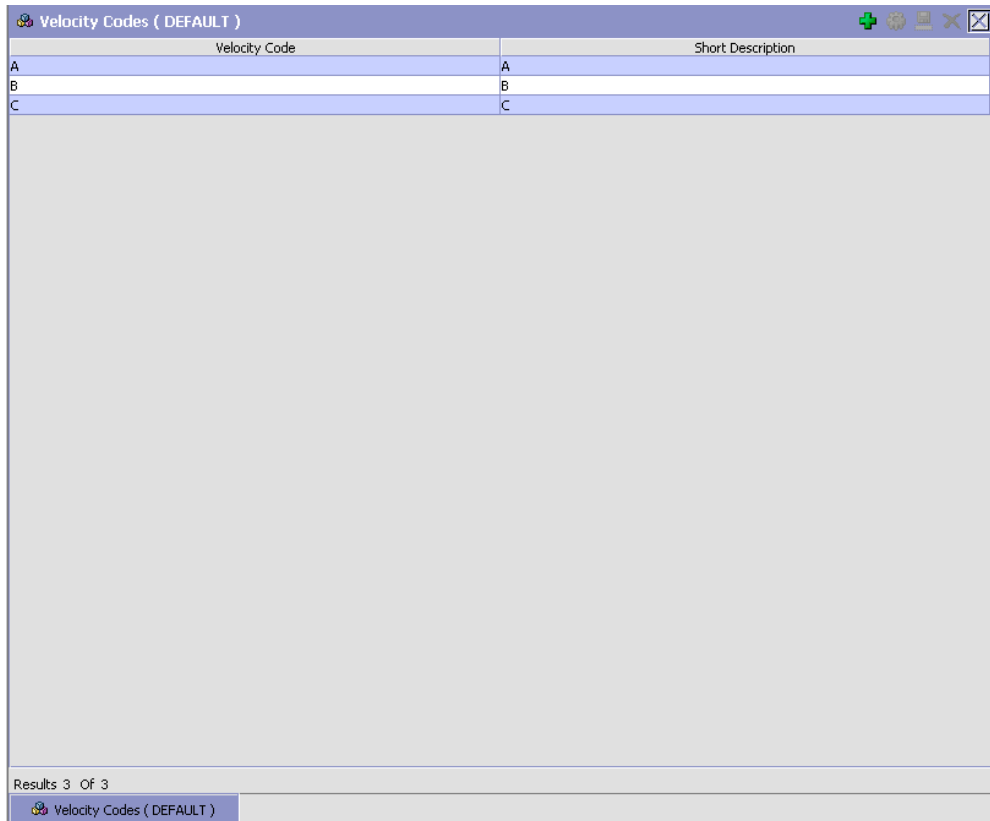

1. From the tree in the application rules side panel, choose Warehouse Layout > Velocity Codes. The Velocity Codes window displays.



Velocity Code	Short Description
A	A
B	B
C	C

Results 3 Of 3

Velocity Codes (DEFAULT)

2. In the Velocity Codes window, choose . The Velocity Code Details pop-up window displays.
3. Enter information in the applicable fields. See [Table 3–5](#) for field value descriptions.
4. Choose .



The screenshot shows a pop-up window titled "Velocity Code Details". It features a title bar with a save icon. The main area contains three text input fields: "Velocity Code", "Short Description", and "Long Description".

Table 3–5 *Velocity Code Details Pop-up Window*

Field	Description
Velocity Code	Enter a name for the velocity code being created. A velocity code associates the location to a SKU's throughput. Typically, fast moving items are stored in the lower level locations, or locations reachable by hand, in the bulk zone.
Short Description	Enter a short description for the velocity code being created.
Long Description	Enter a detailed description for the velocity code being created.

3.4.2 Creating a New Velocity Code from an Existing Velocity Code



To create a new velocity code from an existing velocity code:

1. From the tree in the application rules side panel, choose Warehouse Layout > Velocity Codes. The Velocity Codes window displays with the list of Velocity Codes.
2. Select the Velocity Code to be copied from. Choose .
3. The Velocity Code Details pop-up window displays.
4. Enter information in the applicable fields. See [Table 3–5](#) for field value descriptions.
5. Choose .

3.4.3 Modifying a Velocity Code

Once a velocity code has been created, it may be modified.

To modify an existing velocity code:

1. From the tree in the application rules side panel, choose Warehouse Layout > Velocity Codes. The Velocity Codes window displays with the list of Velocity Codes.
2. Select the Velocity Code to be modified. Choose .
3. The Velocity Code Details pop-up window displays.
4. Enter information in the applicable fields. See [Table 3-5](#) for field value descriptions.
5. Choose .

3.4.4 Deleting a Velocity Code

To delete an existing velocity code:

1. From the tree in the application rules side panel, choose Warehouse Layout > Velocity Codes.
2. The Velocity Codes window displays with the list of Velocity Codes.
3. Select the Velocity Code to be deleted.
4. Choose .

Note: You cannot delete the factory-shipped Velocity Codes of Selling and Fulfillment Foundation.

3.5 Defining Zones

A *Zone* classifies a set of locations that share common properties. A warehouse is divided into multiple zones based on its attributes, like package type and velocity codes. Inventory for an SKU in the Sterling Warehouse Management System is either stocked in a specific zone or in multiple zones and locations.

For example, case storage and unit storage make separate zones. Camcorders are stored in the lock and key zone, while television sets are stored in the bulk storage zone.

A zone in the Sterling Warehouse Management System allows the definition of constraints for putaway, retrieval, and pick of SKUs in the warehouse. Zone level constraints can also be applied on a user through Task Management.

For example, a user can be dedicated to pick only in the refrigeration zone or a loose pick zone.

If a Zone contains a Location of VIRTUAL type, it is recommended that locations of other types be avoided in the same zone.

Note: Zone level storage constraints are auto-propagated to locations through membership in a zone. The "mix" and "do not mix" constraints at the zone level apply to every single location in the zone.

Use the Zones window for:

- [Creating a Zone](#)
- [Modifying a Zone](#)
- [Deleting a Zone](#)

3.5.1 Creating a Zone

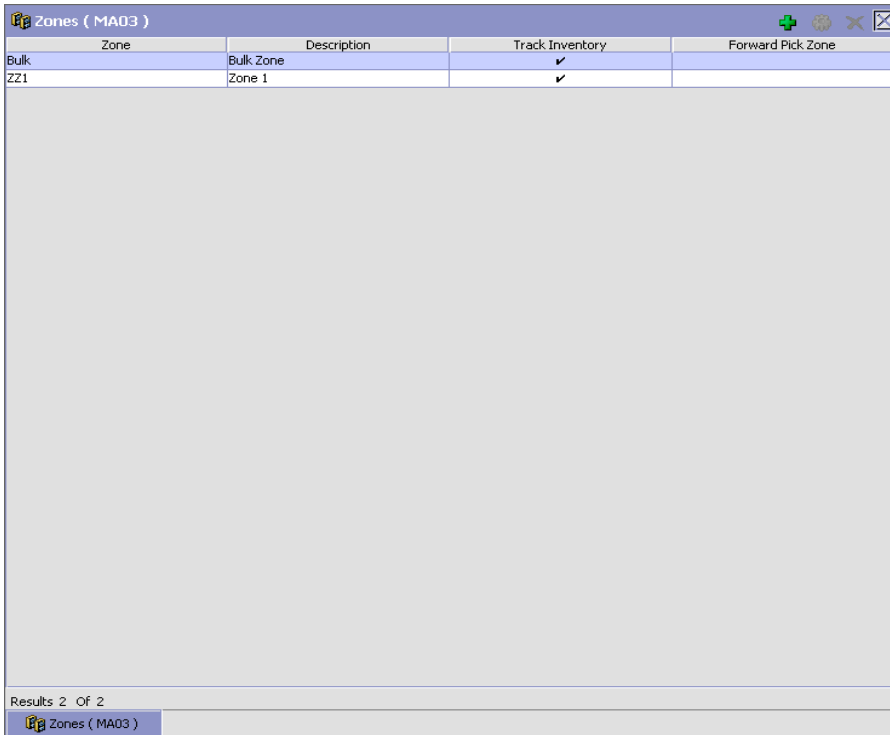

To create a zone:

1. From the tree in the application rules side panel, choose Warehouse Layout > Zones. The Zones window displays.



Zone	Description	Track Inventory	Forward Pick Zone
Bulk	Bulk Zone	✓	
ZZ1	Zone 1	✓	

Results 2 Of 2

2. In the Zones window, choose . The Zone Details window displays.
3. Enter information in the applicable fields. See [Table 3-6](#) for field value descriptions.
4. Choose .

The screenshot shows the 'Zone Details (TP)' window with the following fields and options:

- Zone:** VIRTUAL-ZONE
- Description:** Zone with virtual locations
- Building #:** 1
- Primary Bulk Zone:** (Dropdown menu)
- Track Inventory:**
- Forward Pick Zone:**
- Transfer Inventory Ownership:**
- Minimize No of Locations Per SKU:**
- Track LPN:**
 - Pallet:**
 - Case:**
- Max No of Locations Per SKU:** 25
- Locations in this Zone store product in multiples of:** (Dropdown menu)

Below the main configuration are three tabs: **Zone Constraints** (active), **Inventory Status Transitions**, and **Task Execution Preferences**.

Zone Constraints:

- Force Location Scan On Visit
- Put On Variance Hold
- Confirm Location Empty After Pick
- Count entire location when item in location is put on count

Inventory Status Transitions:

- Consider Capacity when Replenishing Locations in this Zone
- Consider replenishing locations when inventory goes below 0 % of Location Capacity
- Replenish Locations 0 % more than maximum capacity when demand exceeds maximum capacity of Locations

Task Execution Preferences:

- Can multiple users work simultaneously in a location: Yes

Table 3–6 Zone Details Window

Field	Description
Zone	Enter a name for the zone. The name characterizes the type of zone.
Description	Enter a brief description of the zone.

Table 3–6 Zone Details Window

Field	Description
Building #	Enter building number for the zone. The building number is used to represent a satellite building for a warehouse.
Primary Bulk Zone	Choose the primary bulk zone for the forward pick zone. Primary bulk zone identifies the zone in which bulk stock is available for replenishment. Putaway algorithm utilizes this to determine the bulk zone nearest to the forward pick location.
Track Inventory	Select if the zone tracks inventory. NOTE: Zones containing virtual locations should not track inventory at LPN level. If inventory in a virtual location is tracked at LPN level, then associated LPNs cannot be deleted.
Transfer Inventory Ownership	Select if inventory ownership is to be transferred to consuming inventory organization when moved to this zone. Note: This transfer will happen only if the consuming inventory organization is known upfront. In situations such as putaway or adhoc moves, the consuming inventory organization may not be known upfront, as a result of which, transfer of ownership will not occur.
Forward Pick Zone	Select only if the zone is a forward pick zone. Forward pick zone identifies the zone where individual units of a SKU are picked.
Minimize No. of Locations per SKU	Select if SKU being put away could be consolidated into a location already containing the SKU. The capacity constraints of a location are considered when minimizing the locations through consolidation.
Max No. of Locations per SKU	Enter the maximum number of locations that an item can occupy in this zone. This attribute is of relevance in zones closest to the docks (high velocity zones), where the number of locations per item should not exceed a fixed number.

Table 3–6 Zone Details Window

Field	Description
Locations in this Zone store product in multiples of	Choose the unit of measure utilized for the storage of products. Typical values are: 'Case,' 'Each,' 'Half Pallet,' 'Inner Pack,' and 'Pallet'.
Track LPN	
Pallet	Select only if pallet license plates are tracked in this zone. For example, this flag is checked in all the zones of a warehouse that store pallet LPN, while it is unchecked for the forward pick zone to pick loose units. NOTE: Zones containing virtual locations should not track inventory at LPN level. If inventory in a virtual location is tracked at LPN level, then associated LPNs cannot be deleted.
Case	Select only if case license plates are tracked in this zone. For example, this flag is checked in all the zones of a warehouse that store case LPN, while it is unchecked for the forward pick zone to pick loose units. NOTE: Zones containing virtual locations should not track inventory at LPN level. If inventory in a virtual location is tracked at LPN level, then associated LPNs cannot be deleted.
Zone Constraints Tab	For more information about setting up Zone Constraints, see Section 5.8, "Defining Zone Constraints" on page 430.
Inventory Status Transitions Tab	
Inventory Status	Enter the inventory status of the product being moved into the zone, if applicable. This defines the inventory status that needs to be modified when moved into this zone. This field can be left blank to indicate all inventory statuses. For more information, see Section 4.2.1, "Creating an Inventory Status" on page 115.

Table 3–6 Zone Details Window

Field	Description
Supply Type	<p>This indicates the supply type associated with the inventory status.</p> <p>Supply type indicates classification of the inventory. This value is populated automatically by the Sterling WMS from the inventory status configuration.</p> <p>For more information about Inventory Supply Types, see the <i>Sterling Global Inventory Visibility: Configuration Guide</i>.</p>
New Inventory Status	<p>Enter the inventory status applicable to the zone. This is mandatory if a translation is to be defined.</p> <p>This defines the new inventory status that replaces the current inventory status. This is used for the automatic conversion of the inventory status.</p> <p>For example, a warehouse with QC zone having 'Quality Held' inventory status and bulk storage zones having 'Normal' inventory status. All product putaway into QC zone has status converted to 'Quality Held' automatically. Inventory putaway into bulk storage has status converted to 'Normal' automatically.</p>
New Supply Type	<p>Indicates the supply type associated with the inventory status.</p> <p>The supply type indicates classification of the inventory. This value is populated automatically by the Sterling WMS from the inventory status configuration.</p> <p>For more information about Inventory Supply Types, see the <i>Sterling Global Inventory Visibility: Configuration Guide</i>.</p>
Task Execution Preferences Tab	
Force Location Scan On Visit	<p>Select if you want to force location scan on visit, when the user uses a mobile interface for task execution.</p> <p>This ensures that the location is scanned every time it is visited.</p> <p>Note: This flag is applicable only when the tasks are executed using the Radio Frequency (RF) device.</p>

Table 3–6 Zone Details Window

Field	Description
Put On Variance Hold	<p>Select if you want the zone to be put on variance hold.</p> <p>This configures the freeze on variance feature for locations belonging to a zone. Only locations belonging to a zone with this flag checked are put on variance hold if negative variance is found during a Count operation.</p> <p>Note: This flag is applicable only when the tasks are executed using the RF device.</p>
Confirm Location Empty After Pick	<p>Select if you want the user to confirm that a location is empty after picking, when the user uses a mobile interface for task execution.</p> <p>This displays a dialog box to the user, whenever the system detects that a location is empty after picking. The user can confirm that the picked location is empty, and continue picking.</p> <p>Note: This flag is applicable only when the tasks are executed using the RF device.</p>
Count Entire Location when Item in Location is put on Count	<p>Check this box if you want the user to count the entire location when counting an item at the location.</p>

Table 3–6 Zone Details Window

Field	Description				
<p>Consider Capacity when Replenishing Locations in this Zone</p>	<p>Check this box to take the capacity of all locations in the zone into consideration when performing demand-based replenishment. This enables the following options:</p> <table border="1" data-bbox="648 444 1250 1112"> <tr> <td data-bbox="648 444 929 647"> <p>Consider replenishing locations when inventory goes below <percentage value> % of Location Capacity</p> </td> <td data-bbox="936 444 1250 647"> <p>If the inventory in the location goes below the specified percentage of the location capacity, the Sterling WMS considers replenishing inventory in the location.</p> </td> </tr> <tr> <td data-bbox="648 656 929 847"> <p>Replenish Locations <percentage value> % more than maximum capacity when demand exceeds maximum capacity of Locations</p> </td> <td data-bbox="936 656 1250 1112"> <p>If demand exceeds the maximum capacity of the location, the Sterling WMS replenishes the inventory beyond the maximum capacity as specified here.</p> <p>For example, if the location can hold only 100 units, and if the demand is for 120 units, you can specify to replenish inventory in the location by 20% more to meet the demand.</p> </td> </tr> </table> <p>Note: If the value is configured for a forward pick zone and the zone is configured under putaway preference, then the system will honor the % capacity constraint for all the locations of this zone during putaway.</p>	<p>Consider replenishing locations when inventory goes below <percentage value> % of Location Capacity</p>	<p>If the inventory in the location goes below the specified percentage of the location capacity, the Sterling WMS considers replenishing inventory in the location.</p>	<p>Replenish Locations <percentage value> % more than maximum capacity when demand exceeds maximum capacity of Locations</p>	<p>If demand exceeds the maximum capacity of the location, the Sterling WMS replenishes the inventory beyond the maximum capacity as specified here.</p> <p>For example, if the location can hold only 100 units, and if the demand is for 120 units, you can specify to replenish inventory in the location by 20% more to meet the demand.</p>
<p>Consider replenishing locations when inventory goes below <percentage value> % of Location Capacity</p>	<p>If the inventory in the location goes below the specified percentage of the location capacity, the Sterling WMS considers replenishing inventory in the location.</p>				
<p>Replenish Locations <percentage value> % more than maximum capacity when demand exceeds maximum capacity of Locations</p>	<p>If demand exceeds the maximum capacity of the location, the Sterling WMS replenishes the inventory beyond the maximum capacity as specified here.</p> <p>For example, if the location can hold only 100 units, and if the demand is for 120 units, you can specify to replenish inventory in the location by 20% more to meet the demand.</p>				



Table 3–6 Zone Details Window

Field	Description
Can multiple users work simultaneously in a location	<p>Choose one of the following options from the drop down list:</p> <p>Yes - If multiple users can work simultaneously in a location</p> <p>No - If multiple users cannot work simultaneously in a location.</p> <p>Note: The default value for Can multiple users work simultaneously in a location is set to No.</p>

3.5.2 Modifying a Zone

Once a zone has been set up, it can be modified.

To modify a zone:

1. From the tree in the application rules side panel, choose Warehouse Layout > Zones. The Zones window displays with the list of Zones.
2. Choose the Zone to be modified. Choose .
3. The Zone Details window displays. Enter information in the applicable fields. See [Table 3–6](#) for field value descriptions.
4. Choose .

A primary bulk zone containing inventory cannot be modified as an active zone. Any modifications to the inventory status transitions are applicable only to those transactions run after the modification.

3.5.3 Deleting a Zone

To delete a zone:

1. From the tree in the application rules side panel, choose Warehouse Management > Warehouse Layout > Zones. The Zones window displays with the list of Zones.
2. Choose the Zone to be deleted.
3. Choose .

Zones containing locations cannot be deleted. To delete a zone containing locations, reassign all the locations assigned to the zone to another zone.

3.6 Defining Zone Constraints

A zone in a warehouse is created to represent a group of locations. Zones may also be dedicated to specific inventory attributes or item attributes.

The constraints are specified at a item attribute, classification and enterprise level. The constraints specified applies to each individual location.

For example, a zone is restricted to a particular enterprise.

3.7 Defining Locations

A *Location* is the physical place where inventory is stored. Locations store inventory of different sizes and classifications.

A location includes attributes like aisle number, bay number, and level number. A location is classified as in-transit location, regular location, virtual location, staging location, and dock location.

A location is always associated with a zone and a node. A location number uniquely identifies a location in the warehouse. Typically, a location number is a combination of the zone, aisle, bay, level and the slot it belongs to.

A location is classified as:

- **DOCK** - when it belongs to a dock zone.
- **INTRANSIT** - when it is a mobile location like that of the location associated to a forklift.
- **VIRTUAL** - when it is associated to inventory that is deemed as, not in the warehouse, like a bin location for variance quantities.
- **STAGING** - when it is an intermediate location for a task like drop-off or floor locations.
- **REGULAR** - all other permanent and static storage locations.

Note: If a location of type VIRTUAL is part of a Zone, it is recommended that locations of other types be avoided in the same zone.

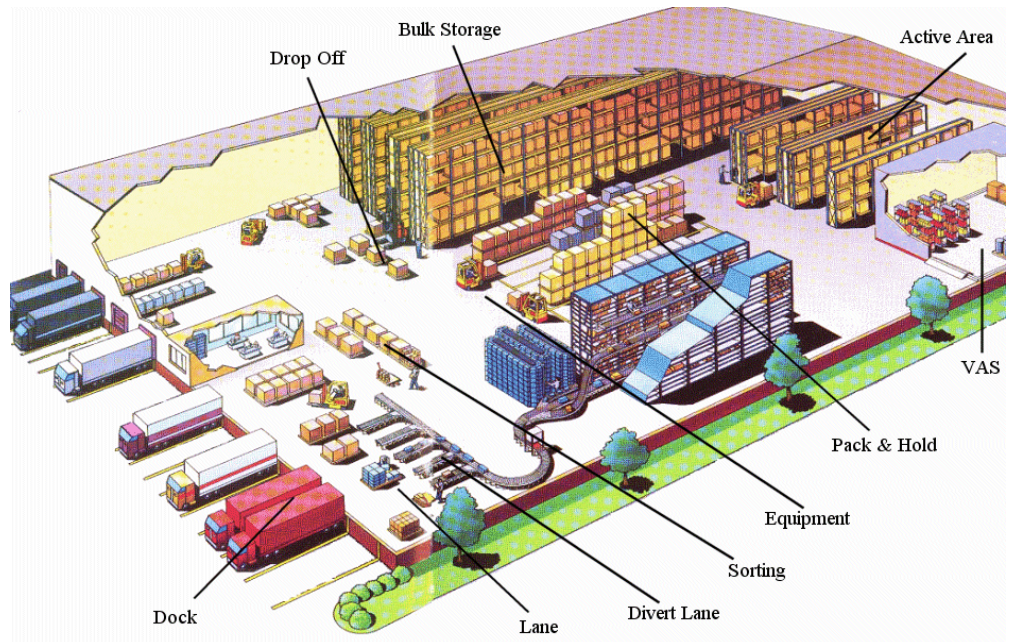

Use Locations for:

- [Setting Up a Location](#)
- [Creating a New Location From an Existing Location](#)
- [Modifying a Location](#)
- [Deleting a Location](#)

3.7.1 Setting Up a Location

To set up a Location:

1. From the tree in the application rules side panel, choose Warehouse Layout > Locations. The Location Search window displays.

The screenshot shows two panels from a software application. The top panel is titled "Location Search (DEFAULT / MA03)". It contains several input fields and checkboxes:

- Location: dropdown menu and text input field
- Zone: dropdown menu and text input field
- Aisle #: text input field
- Location Type: dropdown menu
- Empty Location:
- No In Staging Location:
- No Out Staging Location:
- Freeze for Putaway:
- Freeze for Picking:
- Max Records: text input field with value "200"
- Size Code: dropdown menu with a green plus icon
- In Staging Location: dropdown menu
- Out Staging Location: dropdown menu
- Velocity Code: dropdown menu
- Storage Code: dropdown menu with a green plus icon

The bottom panel is titled "Locations" and displays a table with the following columns: Location, Zone, Location Type, Storage Code, Putaway Sequence #, Picking Sequence #, and Velocity Code. The table is currently empty, and the text "Results 0" is displayed below it. The bottom panel also has a toolbar with a green plus icon, a gear icon, and a close icon.

2. In the Locations panel, choose . The Location Details window displays.

Location Details (TP)

Location: VAS-LOCATION-2 Zone: VAS-ZONE

Location Type: Regular Aisle #: 0 -

Level #: 1 Bay #: 1

Size Code: Infinite capacity location Bar Code: VAS-LOCATION-2

Primary Info **Dedication**

Picking

Freeze for Picking

Sequence #: 0

Staging Location:

Putaway

Freeze for Putaway

Sequence #: 0 Staging Location:

Velocity Code: A Storage Code:

Physical Co-ordinates

X Co-ordinate: 0

Y Co-ordinate: 0

Z Co-ordinate: 0

Dock Scheduling Attributes

Dock Scheduling Required

Choose Calendar:

Dock Type

Inbound Outbound

Transaction Attributes

Freeze On Variance

Fill Code: EMPTY Last Counted On:

Available Volume: 0.00 CIN Available Weight: 0.00 LBS

Pending Volume: 0.00 CIN Pending Weight: 0.00 LBS

Note: To create a new location from an existing location, see [Section 3.7.3, "Modifying a Location"](#) on page 71.

When creating a Location you must understand the following concepts:

- [Setting Up a Location's Primary Information](#)
- [Setting Up a Location's Dedication](#)

3.7.1.1 Setting Up a Location's Primary Information

To set up a Location's Primary Information:

1. In the Location Details window, choose the Primary Info tab.
2. Enter information in the applicable fields. See [Table 3–7](#) for field value descriptions.

Table 3–7 Location Details Window

Field	Description
Location	Enter the location number.
Zone	Choose the zone that the location belongs to.
Location Type	Choose the location type of the location. Valid values for location type are INTRANSIT (Mobile locations), STAGING (floor, drop-off), VIRTUAL, REGULAR, and DOCK.
Aisle #	Enter the aisle number and aisle section of the location. An aisle is a row of locations.
Level #	Enter the level number of the location. A level number indicates the height of the location, in terms of levels.
Bay #	Enter the bay number of the location. A bay number indicates the horizontal slot in which the location exists.
Size Code	Choose the size code to identify size of the location. Location size code defines the capacity of a location. It is recommended that the most frequently used locations/docks/stations are set up with a size code that does not track capacity (i.e. infinite capacity locations). Performance of operations like receiving, putaway, shipping, and packing are greatly enhanced if the locations/station locations are modelled as infinite. For more information about size codes, see Section 3.2.1, "Creating a Location Size Code" on page 35.
Bar Code	Enter the value of barcode associated with the location. In some warehouses, for security purposes, the barcode associated with the location is different from the location number.

Table 3–7 Location Details Window

Field	Description
Primary Information Tab	
Putaway	
Freeze for Putaway	Select only if the putaway of inventory to the location is to be frozen.
Sequence #	Enter the putaway sequence number of the location. The putaway sequence attributed to each location in the warehouse determines the optimal method to navigate in the warehouse. The optimal path is evaluated in the numerical order of sequence numbers.
Staging Location	Choose the staging location for putaway to the location. Staging location is the drop off location for inventory to be putaway into a location. Typically this is situated at the end of an aisle. Note: A location should not be associated with a staging location that belongs to a different zone having inventory status transition.
Velocity Code	Choose the velocity code attributed to the location. The velocity code associates the location to a SKU's throughput. Typically, fast moving items are stored in the lower level locations, or locations reachable by hand, in the bulk zone.
Storage Code	Choose the storage code attributed to the location. Location storage code allows the warehouse to store items that match the storage profile of a location. For example, hazardous inflammable items need locations close to fire extinguishers. For more information about Location Storage Code, see Section 3.3, "Defining Location Storage Codes" on page 40.
Picking	
Freeze for Picking	Select only if the picking of inventory from the location is to be frozen.

Table 3–7 Location Details Window

Field	Description
Sequence #	Enter the picking sequence number of the location. The picking sequence attributed to each location in the warehouse determines the optimal method to navigate in the warehouse. The optimal path is evaluated in the numerical order of sequence numbers.
Staging Location	Choose the staging location for pick from the location. Staging location is the drop off location where inventory that is picked or retrieved is dropped. Typically, this is situated at the end of an aisle that is close to the packing or shipping department. Note: A location should not be associated with a staging location that belongs to a different zone having inventory status transition.
Physical Co-ordinates	
X Co-ordinate	X Co-ordinate for a location in the warehouse.
Y Co-ordinate	Y Co-ordinate for a location in the warehouse.
Z Co-ordinate	Z Co-ordinate for a location in the warehouse.
Dock Scheduling Attributes	These attributes display only if you choose the location type of a location as "DOCK".
Dock Scheduling Required	Check this box if appointments should be taken for the dock location.
Choose Calendar	Select the appropriate calendar for the dock. The working hours specified in this calendar are used when scheduling a dock. Choose  to create a new calendar. For more information about creating a calendar, refer to the <i>Selling and Fulfillment Foundation: Application Platform Configuration Guide</i> .
Dock Type	
Inbound	Check this box if you want to use this dock location for scheduling inbound shipments.
Outbound	Check this box if you want to use this dock location for scheduling outbound shipments.

Table 3–7 Location Details Window

Field	Description
Transaction Attributes	These attributes are automatically populated by the Sterling WMS.
Last Counted On	Displays the date on which a count was last performed at this location.
Freeze for Variance	This indicates if the location is frozen when a variance is detected during counting. For more information about variance hold, see Section 4.13.1, "Defining Variance Hold Setup" on page 226.
Fill Code	This indicates if the location is Empty, Partially Full or Full. These values are automatically updated during inventory updates at the location.
Available Volume	This indicates unoccupied physical volume of the location.
Available Weight	This indicates the additional physical weight the location can hold.
Pending Volume	This indicates the volume of the stock expected to move into the location. The pending volume is determined from tasks that are not completed at the location.
Pending Weight	This indicates the weight of the stock expected to move into the location. The pending weight is determined from tasks that are not completed at the location.

Note: Aisle #, Level #, and Bay # are numeric fields, and are used in computing distances between locations. Putaway Algorithm is capable of suggesting nearest bulk location in the same aisle as a dedicated location if these parameters are configured appropriately. These are not mandatory if this feature is not used.

Note: The Available Volume and Pending Volume values are automatically computed on each inventory adjustment performed on the location.

The size of a master pack of certain items may be significantly different from the sum of the size of each unit. In such situations, these automatic computations of capacity availability may be inaccurate. Therefore, ensure to run the `WMSRecalculateLocationDimensionsAgent` agent periodically to correct the capacities that are incorrect based on the inventory lying at the location and the complete location size.

This agent recalculates the Available Volume and Pending Volume for all locations including locations that have zero inventory.

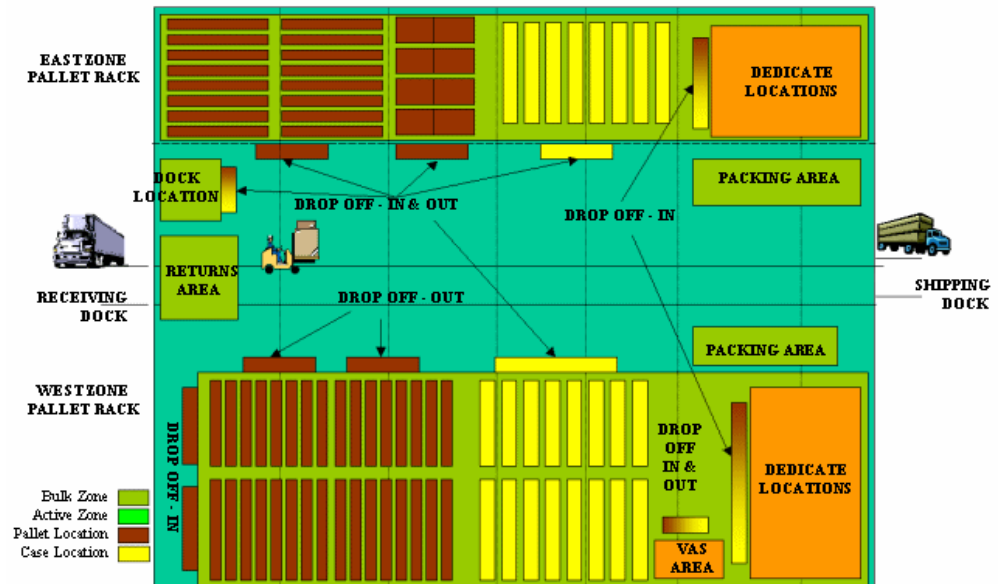

The locations in the warehouse that are temporarily not available, due to structural or procedural issues, are marked as frozen. The unavailable locations are marked frozen to stop any more tasks being run at the location.

The picking sequence number of a location can be different from that of the putaway sequence number. For example, in a flow-rack, putaway is carried out to the back of a location, while picking is done from the front of the location.

3.7.1.2 Setting Up a Location's Dedication

A *Dedicate Location* refers to a location that is reserved for a specific item. A location may be dedicated to a single SKU or multiple SKUs, or multiple locations may be dedicated to a single SKU.

Note: Only regular locations can be dedicated. Thus, the 'Dedication' panel appears in the Location Details screen only when the Location Type selected is 'Regular'.

For more information about Dedicate Locations, see [Section 3.8, "Defining Dedicate Locations"](#) on page 72.

To set up a Location's Dedication:

1. In the Location Details window, choose the Dedication tab.
2. Enter information in the applicable fields. See [Table 3–8](#) for field value descriptions.
3. Choose .

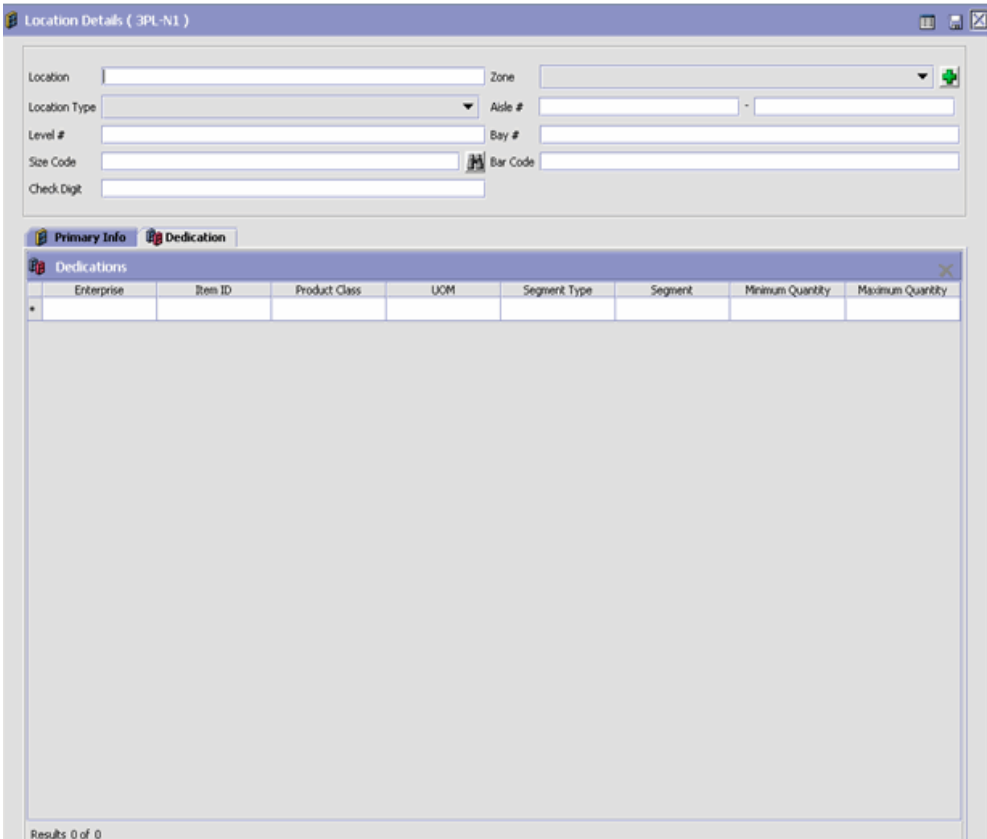

Location Details (3PL-N1)

Location Zone

Location Type Aisle # -

Level # Bay #

Size Code Bar Code

Check Digit

Primary Info **Dedication**

Dedications

Enterprise	Item ID	Product Class	UOM	Segment Type	Segment	Minimum Quantity	Maximum Quantity
*							

Results: 0 of 0

Table 3–8 Dedication Tab Window

Field	Description
Enterprise	Choose the enterprise to which the location is dedicated. This is used only if there are multiple enterprises in the warehouse and this location requires dedication to specific enterprises.
Item ID	Choose the item to which the location is to be dedicated. This identifies the SKU to which the location is to be dedicated. If an enterprise is chosen, the list of valid items is populated automatically from the enterprise's catalog.
Product Class	Choose the product class to which the location is to be dedicated. This is mandatory for dedicating a location to a SKU.
UOM	Choose the unit of measure of the SKU to which the location is to be dedicated. This is mandatory for dedicating a location to a SKU.
Segment Type	Enter the segment type to which the location is to be dedicated. This indicates an inventory category. Typical values are MTC – Made to Customer, and MTO – Made to Order.
Segment	Enter the specific segment value to which the location is to be dedicated. A segment holds either the specific buyer or specific order number that requires dedication.
Minimum Quantity	Enter the minimum quantity of the item that can be stored in the dedicated location.
Maximum Quantity	Enter the maximum quantity of the item that can be stored in the dedicated location.



A location may be dedicated to multiple SKUs. Typically, a location is dedicated only to one SKU. A location being dedicated is either empty or already has inventory of the same SKU.

3.7.2 Creating a New Location From an Existing Location

To create a new location from an existing location:

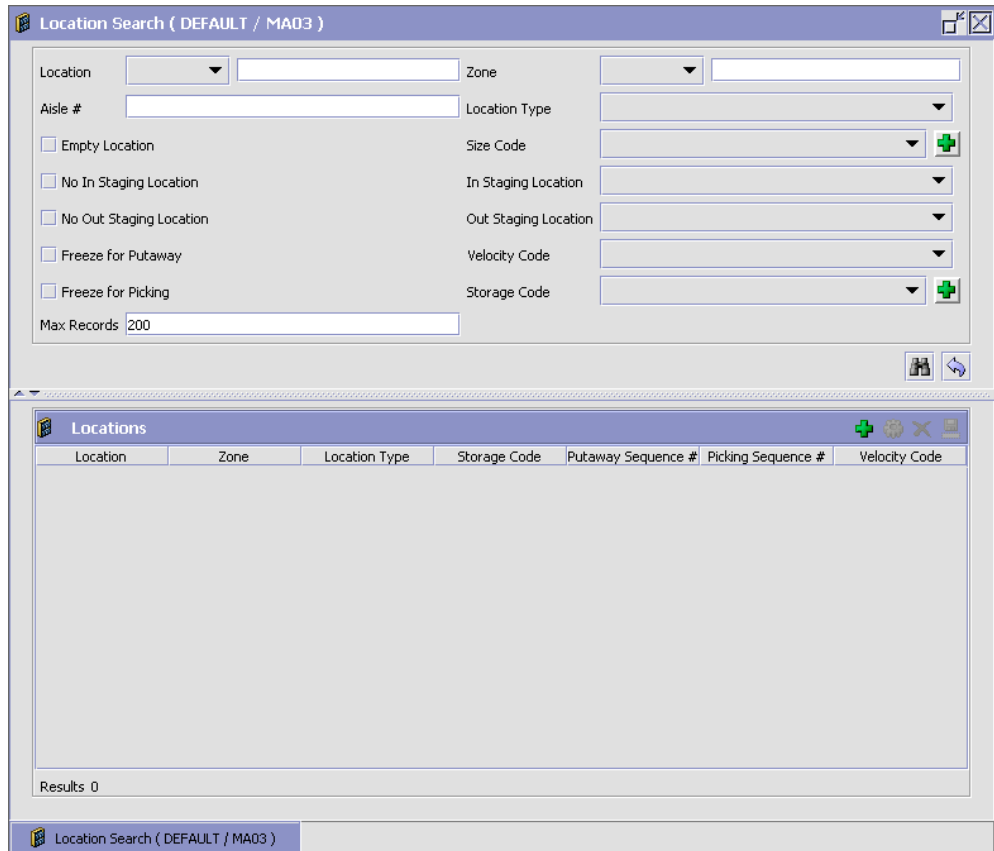
1. From the tree in the application rules side panel, choose Warehouse Layout > Locations. The Location Search window displays.



2. Enter the applicable search criteria, and choose . See [Table 3–9](#) for field value descriptions.
3. A list of Locations displays in the Locations panel. Select the Location to be copied from.
4. To create a new location from the selected Location, choose .

5. The Location Details window displays.
6. Enter information in the applicable fields.
7. Choose .

For more information about modifying fields in the Location Details window, see [Section 3.7.1.1, "Setting Up a Location's Primary Information"](#) on page 59 and [Section 3.7.1.2, "Setting Up a Location's Dedication"](#) on page 65.

Table 3–9 Location Search Window

Field	Description
Location	Enter the location number of location to be searched.
Zone	Choose the zone that the location to be searched belongs to.
Aisle	Enter the aisle number of location to be searched. An aisle is a row of locations. A location belongs to only one aisle.
Location Type	Choose the location type of location to be searched. Valid values for location type are INTRANSIT (Mobile locations), STAGING (floor, drop-off), VIRTUAL, REGULAR, and DOCK.
Empty Location	Select if the location to be searched is an empty location. Note: Infinite locations are treated as partially full locations, irrespective of the locations being empty or partly full.
Size Code	Choose the location size code of location to be searched. Location size code defines the capacity of a location. It is recommended that the most frequently used locations/docks/stations are set up with a size code that does not track capacity (i.e. infinite capacity locations). Performance of operations like receiving, putaway, shipping, and packing are greatly enhanced if the locations/station locations are modelled as infinite.





Table 3–9 Location Search Window

Field	Description
No In Staging Location	Select if the location to be searched is not an in staging location. In staging location is the drop off location for inventory to be putaway into a location. Typically this is situated at the end of an aisle.
In Staging Location	Choose the in staging location to be searched. In staging location is the drop off location for inventory to be putaway into a location. Typically this is situated at the end of an aisle.
No Out Staging Location	Select if the location to be searched is not an out staging location. Staging location is the drop off location where inventory that is picked or retrieved is dropped. Typically this is situated at the end of an aisle that is close to the packing or shipping department.
Out Staging Location	Choose the out staging location to be searched. Staging location is the drop off location where inventory that is picked or retrieved is dropped. Typically this is situated at the end of an aisle that is close to the packing or shipping department.
Freeze for Putaway	Select if putaway of inventory to the location on search is frozen.
Velocity Code	Choose the velocity code of location to be searched. The velocity code associates the location to a SKU's throughput. Typically, fast moving items are stored in the lower level locations, or locations reachable by hand, in the bulk zone.
Freeze for Picking	Select if picking of inventory from the location on search is frozen.
Storage Code	Choose storage code of location to be searched. Location storage code allows the warehouse to store items that match the storage profile of a location. For example, hazardous inflammable items need locations close to fire extinguishers.
Max Records	Enter maximum number of search results to display at a time.

3.7.3 Modifying a Location

Once a Location has been set up, it can be modified.

To modify a location:

1. From the tree in the application rules side panel, choose Warehouse Layout > Locations. The Location Search window displays.
2. Enter the applicable search criteria. and choose . See [Table 3–9](#) for field value descriptions.
3. A list of Locations displays in the Locations panel. Select the Location to be modified.
4. To modify the selected Location, choose .
5. To create and modify a copy of the selected Location, choose .
6. The Location Details window displays.
7. Enter information in the applicable fields.
8. Choose .

For more information about modifying fields in the Location Details window, see [Section 3.7.1.1, "Setting Up a Location's Primary Information"](#) on page 59 and [Section 3.7.1.2, "Setting Up a Location's Dedication"](#) on page 65.

The zone of a location containing inventory cannot be modified. Also, the size code of a location containing inventory cannot be modified from INFINITE to a FINITE location size.

Location defined with location type STAGING is not modifiable to any other location type, if there is a corresponding REGULAR location that is using it as a staging location for putaway or retrieval.

3.7.4 Deleting a Location

To delete a location:

1. From the tree in the application rules side panel, choose Warehouse Layout > Locations. The Location Search window displays.
2. Enter the applicable search criteria. and choose . See [Table 3–9](#) for field value descriptions.

3. A list of Locations displays in the Locations panel. Select the Location to be deleted.
4. Choose .

A location containing inventory cannot be deleted. Also, a location that has equipment associated with it cannot be deleted.

3.8 Defining Dedicate Locations

A *Dedicate Location* refers to a location that is reserved for a specific item. A location is dedicated to a single SKU or multiple SKUs, while multiple locations may be dedicated to a single SKU.

You may use the dedicate location set-up to dedicate a location for an item, or to assign an item to an existing location. You may also use the dedicate location set-up to remove an existing dedication.

Use Dedicate Locations for:

- [Setting Up a Dedicate Location](#)
- [Deleting a Dedicate Location](#)

3.8.1 Setting Up a Dedicate Location

To set up a Dedicate Location:

1. From the tree in the application rules side panel, choose Warehouse Layout > Dedicate Locations. The Dedication Search window displays.

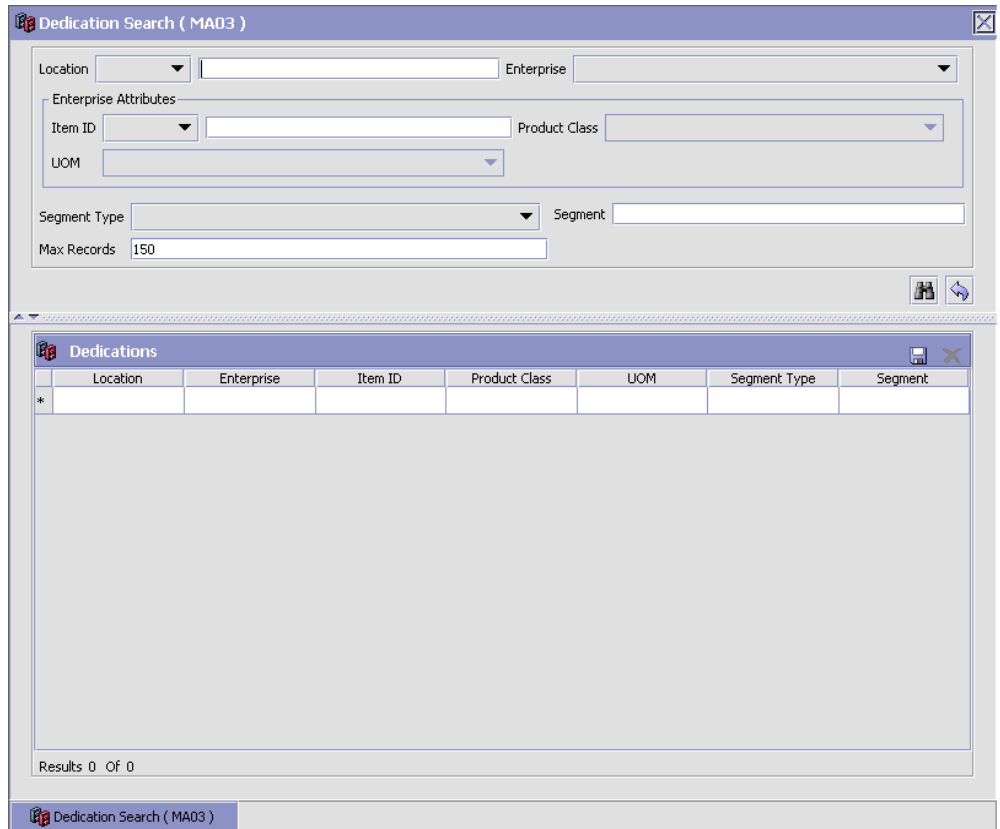

2. Enter information in the applicable fields. See [Table 3–10](#) for field value descriptions.
3. Choose .

Table 3–10 Dedications Search Window

Field	Description
Location	Choose location to be dedicated.
Enterprise	Choose the enterprise to which the location is to be dedicated. This is used only if there are multiple enterprises in the warehouse and this location requires dedication to specific enterprises.

Table 3–10 Dedications Search Window



Field	Description
Enterprise Attributes	
Item ID	Choose the item to which the location is to be dedicated. This identifies the SKU to which the location is to be dedicated. If an enterprise is chosen, the list of valid items is populated automatically from the enterprise's catalog.
Product Class	Choose the product class to which the location is to be dedicated. This is mandatory for dedicating the location to a SKU.
UOM	Choose the unit of measure of the SKU to which the location is to be dedicated. This is mandatory for dedicating the location to a SKU.
Segment Type	Enter the segment type to which the location is to be dedicated. This indicates an inventory category. Typical values are MTC – Made to Customer, and MTO – Made to Order.
Segment #	Enter the specific segment value to which the location is to be dedicated. A segment holds either the specific buyer or specific order number that requires dedication.

A location may be dedicated to multiple SKUs. Typically, a location is dedicated only to one SKU. A location being dedicated is either empty or already has inventory of the same SKU.

3.8.2 Deleting a Dedicate Location

To delete a dedicate location:

1. From the tree in the application rules side panel, choose Warehouse Layout > Dedicate Locations. The Dedication Search window displays.
2. In the Dedication Search window, enter applicable search criteria. See [Table 3–10](#) for field value descriptions.

3. Choose . A list of Dedicate Locations displays in the Dedications panel.
4. Select the Dedicate Location to be deleted.
5. Choose .

3.9 Defining Dock Scheduling Rule

You can schedule a dock in a warehouse and take appointments for loading or unloading shipments.

To define a dock scheduling rule:

1. From the tree in the application rules side panel, choose Warehouse Layout > Dock Scheduling Rule. The Dock Scheduling Rule window displays.

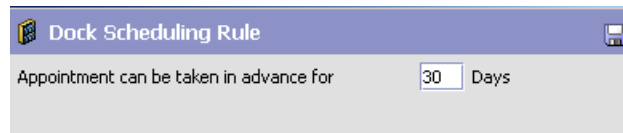

2. Enter how many days in advance you want to take a dock appointment.
3. Choose .

3.10 Defining Equipment

In a warehouse, different types of equipment are used to run various tasks. Examples of various types of equipment used in a warehouse include sorter, tote, forklift, and pallet jack.

An individual equipment is identified through an equipment ID, and categorized into one of the Equipment Types used in that warehouse.

The equipment used in a warehouse may be stationary (for example, a sorter) or mobile (for example, Pallet Jack, Fork Lift, or Cart). In Selling and Fulfillment Foundation, the equipment is modeled in one of the following ways:

1. As a Set of Locations

The equipment that are stationary are typically modeled as locations. Also certain mobile equipment that do not need to be tracked in inventory like Fork Lifts or Pallet Jacks are modeled as Locations.

2. As a License Plate

Mobile equipment that are physically moved around (between different physical locations) and are required to be tracked at their current location, are modeled as license plates. Examples of such equipment include Carts and Totes.

Equipment modeled as license plates could be modeled as a case or pallet depending on their size. For example, carts would be modeled as Pallets, while totes would typically be modeled as cases.

Equipment modeled as license plates could have slots in them of different sizes for carrying products. This information of slots is used while batching tasks that require these equipment for their execution. For example, Cart manifest batch.

Use Equipment for:

- [Setting Up an Equipment Type](#)
- [Setting Up a Task Type Association](#)
- [Setting Up a Print Format Preference](#)
- [Setting Up an Equipment ID](#)
- [Setting Up an Equipment Device Association](#)

3.10.1 Setting Up an Equipment Type

An equipment group is tracked as an equipment type. An equipment type defines the characteristics of the group. For example, if a warehouse uses a two lane inbound sorter and a sixteen lane outbound sorter, these are modeled as two distinct equipment types.

There are standard equipment types that are supplied with the Sterling WMS.

Use Equipment Types set-up for:

- [Creating an Equipment Type](#)

- [Modifying an Equipment Type](#)
- [Deleting an Equipment Type](#)

3.10.1.1 Creating an Equipment Type

To create an equipment type:

1. From the tree in the application rules side panel, choose Warehouse Layout > Equipment. The Equipment window displays.

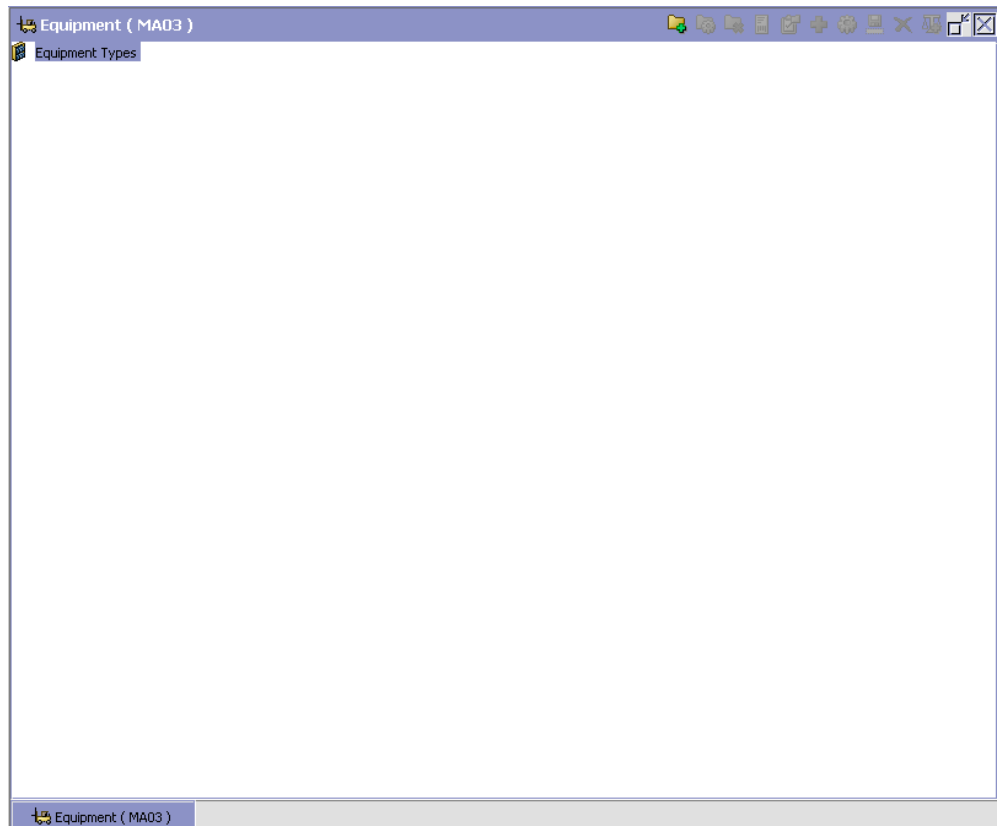

2. In the Equipment window, choose . The Equipment Type pop-up window displays.
3. Enter information in the applicable fields. See [Table 3–11](#) for field value descriptions.

4. Choose .

Table 3–11 *Equipment Type Details Window*

Field	Description
Equipment Type	Enter the name for the Equipment Type. This helps in identifying the type of equipment. For example, equipment type include Forklift, Grabtruck, Inbound Sorter.
Description	Enter a brief description for the equipment type.
Modeled as	Choose what the equipment is ideally represented by. Valid values are Case, Pallet and Location. Examples for each type are as below: 'Location' – Sorter or Forklift. 'Pallet' – Cart used for picking. 'Case' – Tote used for picking.



Table 3–11 Equipment Type Details Window

Field	Description
Equipment Location Type	Choose the location type associated with the equipment. A sorter modeled as a 'Location' is associated with 'STAGING' location type. A forklift modeled as a 'Location' is associated with 'INTRANSIT' location type.
Equipment Type Details	
Equipment Location Size Code	Choose the location size code that characterizes the equipment or a slot in the equipment. For a cart, each slot is represented by a size code. For a sorter, each chute is represented by a size code. For more information about setting up a location size code, see Section 3.2.1, "Creating a Location Size Code" on page 35.
Location Name	Enter the name of the location associated to the location size code. For a cart, each slot is named or numbered. The values of the slots are used in RF and in prints to represent where the inventory must be placed. For a sorter, each chute is given a location name.

3.10.1.2 Modifying an Equipment Type

Once an equipment type has been created, it can be modified.

To modify an equipment type:

1. From the tree in the application rules side panel, choose Warehouse Layout > Equipment. The Equipment window displays with the list of Equipment Types.
2. Choose the Equipment Type to be modified.
3. Choose . The Equipment Type pop-up window displays.
4. Enter information in the applicable fields. See [Table 3–11](#) for field value descriptions.
5. Choose .

3.10.1.3 Deleting an Equipment Type

To delete an equipment type:

1. From the tree in the application rules side panel, choose Warehouse Layout > Equipment. The Equipment window displays with the list of Equipment Types.
2. Choose the Equipment Type to be deleted.
3. Choose .





3.10.2 Setting Up a Task Type Association

Equipment is limited to the processes that it can perform. For example, a cart can only run pick tasks that are related to a cart or a forklift is used only for putaway and retrieval from bulk zones.

Each task in the system is associated with a source and target zone. The task type created using a zone, is associated with the equipment that can run the task.

For example, put away of pallets to bulk zone requires a forklift with an RF scanner for scanning data.

To set up a task type association:

1. From the tree in the application rules side panel, choose Warehouse Layout > Equipment. The Equipment window displays with the list of Equipment Types.
2. Select the Equipment Type for which Task Type is to be associated.
3. Choose . The Task Type Association pop-up window displays.
4. Choose  to add a task type to the Subscribed Task Types list, from the Available Task Types list.
5. Choose  to remove a task type from the Subscribed Task Types list, and move it back to the Available Task Types list.
6. See [Table 3–12](#) for field value descriptions.
7. Choose .

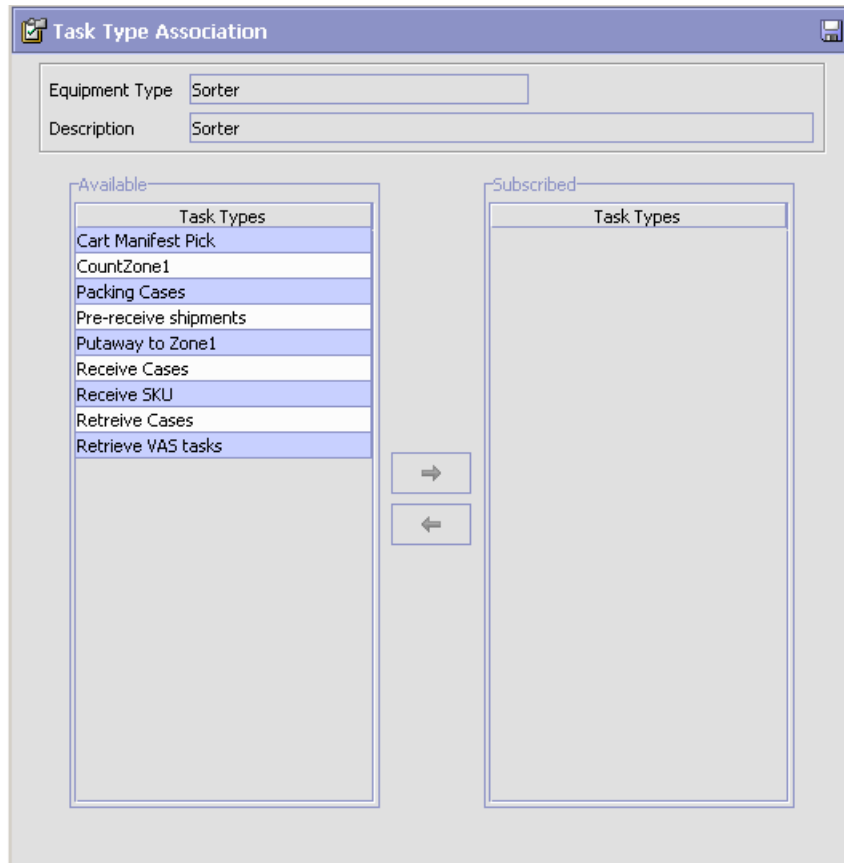

Table 3–12 *Equipment Type Task Type Association Pop-up Window*



Field	Description
Equipment Type	This indicates the equipment type.
Description	This provides a brief description for the equipment type.
Available Task Types	This indicates the list of task types that are available for the equipment type.
Subscribed Task Types	This indicates the list of task types that are subscribed for the equipment type.

3.10.3 Setting Up a Print Format Preference

Equipment like sorter or forklifts can have devices attached to them that print labels or documents. The preferences for these print labels or documents are configured here.

For example, a pack station associated to a printer can print packing slips after the last carton has been packed.

To set up a print format preference:

1. From the tree in the application rules side panel, choose Warehouse Layout > Equipment. The Equipment window displays with the list of Equipment Types.
2. Select the Equipment Type for which the Print Format Preference is to be set up.
3. Choose . The Print Format Preferences pop-up window displays.
4. Enter information in the applicable fields. See [Table 3–13](#) for field value descriptions.
5. Choose .

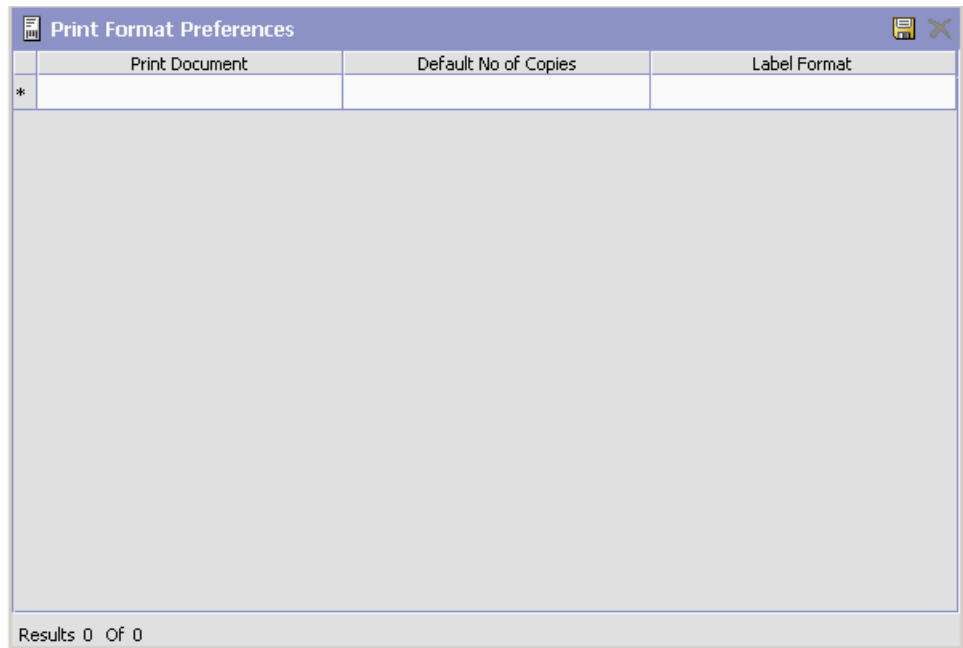



Table 3–13 *Equipment Type Print Format Preferences Pop-up Window*

Field	Description
Print Document	Choose the relevant document to be printed.
Default No. of Copies	Enter the number of copies to be printed.
Label Format	Choose the format of the label associated with the document.

Note: Choose  in the Print Format Preferences pop-up window to delete a print format preference (Print Document, Default Number of Copies, and Label Format).

3.10.4 Setting Up an Equipment ID



Individual equipment in the warehouse is represented by an ID and is associated with an equipment type. For example, inbound sorter, outbound sorter and a cart.

Use Equipment set-up for:

- [Creating an Equipment ID](#)
- [Creating a New Equipment ID From an Existing Equipment ID](#)
- [Modifying an Equipment ID](#)
- [Deleting an Equipment ID](#)

3.10.4.1 Creating an Equipment ID

To create an equipment id:

1. From the tree in the application rules side panel, choose Warehouse Layout > Equipment. The Equipment window displays with the list of Equipment Types.
2. Choose the Equipment Type for which the Equipment is to be created.
3. Choose . The Equipment pop-up window displays.
4. Enter information in the applicable fields. See [Table 3–14](#) for field value descriptions.
5. Choose .

Equipment

Equipment Type: ForkLift

Equipment ID:

Equipment Details

Equipment Location Size Code	Location Name	Location
INFINITE	ForkliftLoc	

Results 0 Of 1

Table 3–14 *Equipment Pop-up Window*



Field	Description
Equipment Type	This indicates the equipment type for which the equipment is being created.
Equipment ID	Enter the equipment ID for the equipment being created.
Equipment Details	
Equipment Location Size Code	Indicates the location size code of the equipment. The location size codes valid for the equipment type are listed here.

Table 3–14 Equipment Pop-up Window

Field	Description
Location Name	Indicates the name of the location of the equipment. The location names valid for the equipment type are listed here.
Location	Enter the name of the location corresponding to the location name. This value is required only for Equipment Types that are modeled as a 'Location'. For example, each chute of a sorter represents a location in the system.

3.10.4.2 Creating a New Equipment ID From an Existing Equipment ID

To create a new equipment ID from an existing equipment ID:



1. From the tree in the application rules side panel, choose Warehouse Layout > Equipment. The Equipment window displays with the list of Equipment Types.
2. Choose the Equipment Type for which the Equipment is to be created.
3. From the Equipment Type tree, select the Equipment to be copied to create new Equipment.
4. Choose . The Equipment pop-up window displays.
5. Enter information in the applicable fields. See [Table 3–14](#) for field value descriptions.
6. Choose .

3.10.4.3 Modifying an Equipment ID

Once an Equipment ID has been created, it can be modified.

To modify an equipment ID:

1. From the tree in the application rules side panel, choose Warehouse Layout > Equipment. The Equipment window displays with the list of Equipment Types.
2. Choose the Equipment Type whose Equipment is to be modified.
3. From the Equipment Type tree, select the Equipment to be modified.

4. Choose . The Equipment pop-up window displays.
5. Enter information in the applicable fields. See [Table 3–14](#) for field value descriptions.
6. Choose .

3.10.4.4 Deleting an Equipment ID

To delete an equipment ID:



1. From the tree in the application rules side panel, choose Warehouse Layout > Equipment. The Equipment window displays with the list of Equipment Types.
2. Choose the Equipment Type whose Equipment is to be deleted.
3. From the Equipment Type tree, select the Equipment to be deleted.
4. Choose .

3.10.5 Setting Up an Equipment Device Association

Equipment in the warehouse have devices attached to them like RF scanners or printers. These devices are associated with equipment here.

For example, a forklift has an RF scanner associated with it.

To set up an equipment device association:

1. From the tree in the application rules side panel, choose Warehouse Layout > Equipment. The Equipment window displays with the list of Equipment Types.
2. From the Equipment Type tree, select the relevant Equipment to be associated with a Device.
3. Choose . The Equipment Device Association pop-up window displays.
4. Enter information in the applicable fields. See [Table 3–15](#) for field value descriptions.
5. Choose .

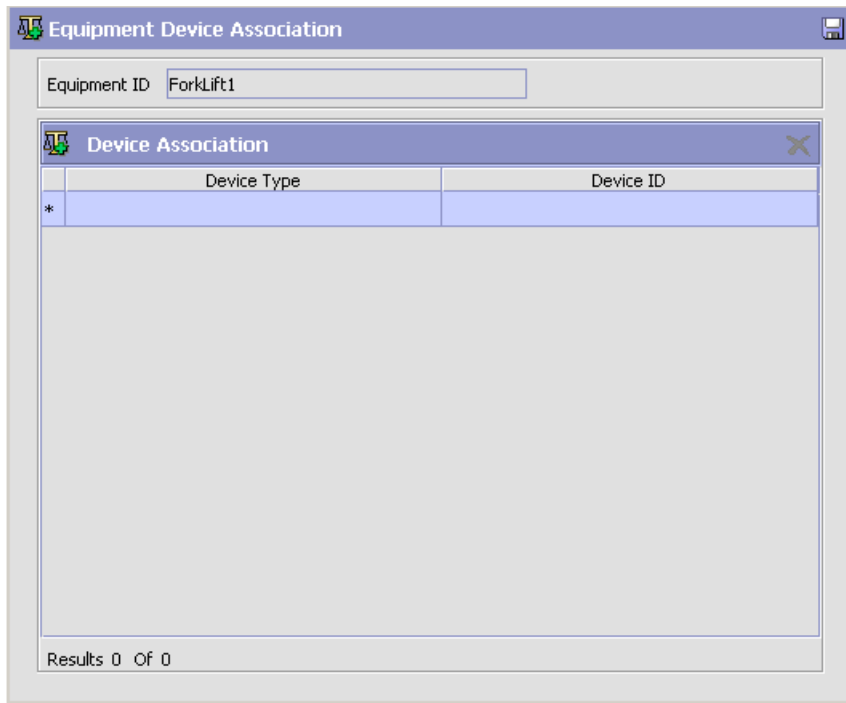



Table 3–15 *Equipment Device Association Pop-up Window*

Field	Description
Equipment ID	Indicates the equipment ID of the equipment type being associated.
Device Association	
Device Type	Choose the device type of the device to be associated to the equipment. For more information about a device type, see Section 14.1.1, "Defining a Device Type" on page 955.
Device ID	Choose the device ID of the device to be associated to the equipment.

Note: Choose  in the Equipment Device Association pop-up window to delete a device association (Device Type and Device ID).

3.11 Defining Stations

There are activities in a warehouse that are performed from stationary locations. Some examples include Packing, VAS, Receiving, Sorting, and Manifesting.

Each Station is associated with devices and labels or documents that are printed on demand or automatically.

Use station for:

- [Setting Up a Station Type](#)
- [Setting Up a Task Type Association](#)
- [Setting Up a Print Format Preference](#)
- [Setting Up a Station ID](#)
- [Setting Up a Station Device Association](#)

3.11.1 Setting Up a Station Type

Stations are grouped by their activity into Station Types. Typical station types in a warehouse include Receiving Station or Manifesting Station.

Use Station Types set-up for:



- [Creating a Station Type](#)
- [Modifying a Station Type](#)
- [Deleting a Station Type](#)

3.11.1.1 Creating a Station Type

To create a station type:

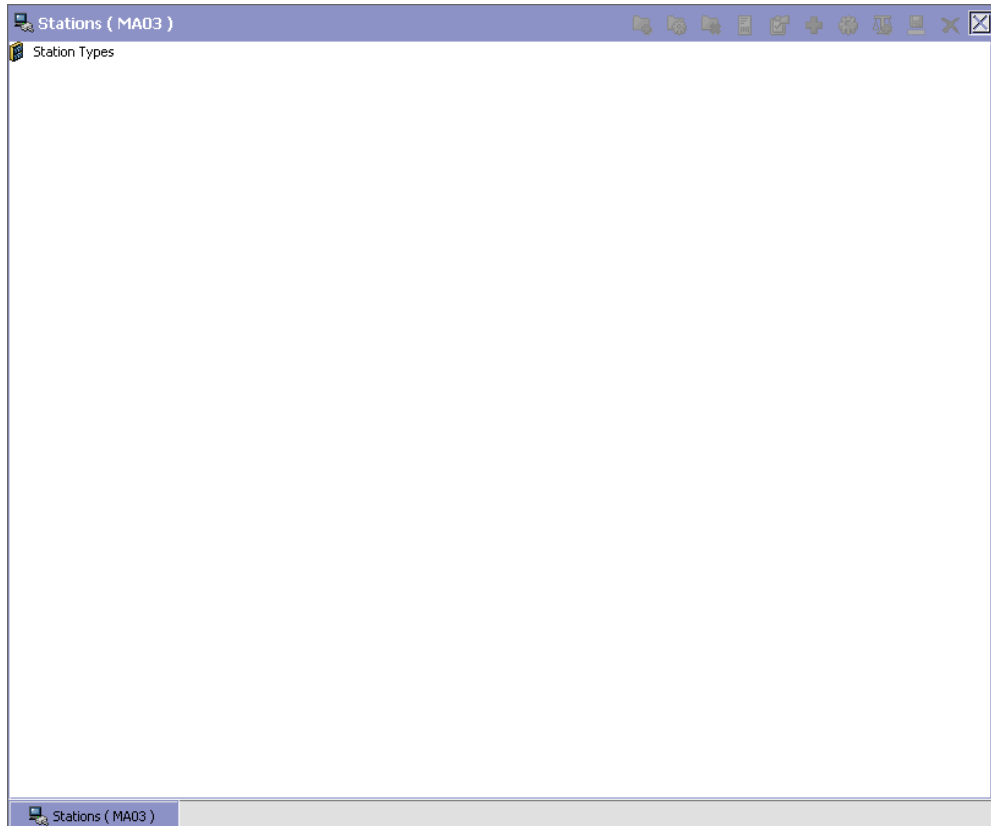
1. From the tree in the application rules side panel, choose Warehouse Layout > Stations. The Stations window displays.



2. In the Stations window, choose . The Station Type pop-up window displays.
3. Enter information in the applicable fields. See [Table 3–16](#) for field value descriptions.
4. Choose .

The screenshot shows a 'Station Type' pop-up window. At the top, there is a title bar with the text 'Station Type' and a close button. Below the title bar, there are three input fields: 'Station Type', 'Description', and 'Station Location Type' (a dropdown menu). Below these fields is a table titled 'Station Type Details'. The table has two columns: 'Station Location Size Code' and 'Location Name'. The first row of the table has an asterisk (*) in the first column. At the bottom of the window, it says 'Results 0 Of 0'.

Table 3–16 Station Type Pop-up Window

Field	Description
Station Type	Enter a name for the Station Type. This helps in identifying the type of station. For example, Receiving Station or Pack Station.
Description	Enter a brief description for the station type.
Station Location Type	Choose the location type that the station is associated with. All stations locations are typically modeled as 'STAGING'.
Station Type Details	

Table 3–16 Station Type Pop-up Window



Field	Description
Station Location Size Code	Choose the location size code that characterizes the station. Typically chosen as 'INFINITE' location size. For more information about location size codes, see Section 3.2.1, "Creating a Location Size Code" on page 35.
Location Name	Enter the name of the location associated to the location size code.

Note: Set the most frequently used locations/docks/stations with a size code that does not track capacity (i.e. infinite capacity locations). Performance of operations like receiving, putaway, shipping, and packing are greatly enhanced if the locations/station locations are modelled as infinite.

3.11.1.2 Modifying a Station Type

Once a Station Type has been created, it can be modified.

To modify a station type:

1. From the tree in the application rules side panel, choose Warehouse Layout > Stations. The Stations window displays with the list of Station Types.
2. Choose the Station Type to be modified.
3. Choose . The Station Type pop-up window displays.
4. Enter information in the applicable fields. See [Table 3–16](#) for field value descriptions.
5. Choose .

3.11.1.3 Deleting a Station Type





To delete a station type:

1. From the tree in the application rules side panel, choose Warehouse Layout > Stations. The Stations window displays with the list of Station Types.
2. Choose the Station Type to be deleted.
3. Choose .

3.11.2 Setting Up a Task Type Association

The type of work performed characterizes a station. For example, receiving station is associated with receiving task types.

To set up a task type association:

1. From the tree in the application rules side panel, choose Warehouse Layout > Stations. The Stations window displays with the list of Station Types.
2. Select the Station Type for which Task Type is to be associated.
3. Choose . The Task Type Association pop-up window displays.
4. Choose  to add a task type to the Subscribed Task Types list, from the Available Task Types list.
5. Choose  to remove a task type from the Subscribed Task Types list, and move it back to the Available Task Types list.
6. See [Table 3–17](#) for field value descriptions.
7. Choose .

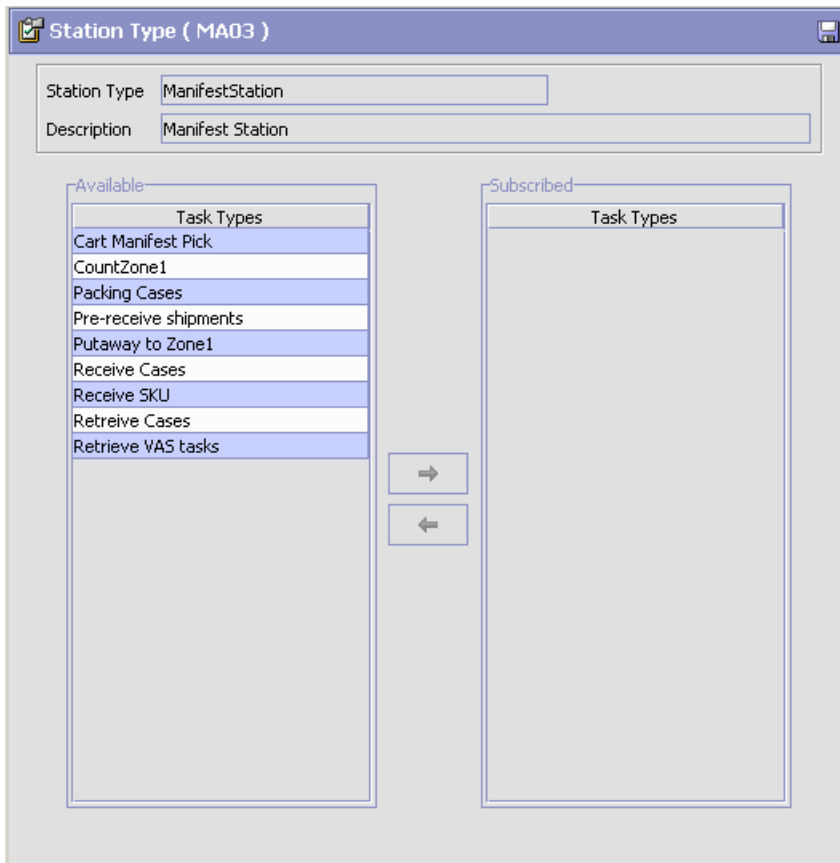

Table 3–17 Station Type Task Type Association Pop-up Window



Field	Description
Station Type	This indicates the station type being associated with the tasks.
Description	This provides a brief description for the station type.
Available Task Types	This indicates the list of task types that are available to be associated to the station type.
Subscribed Task Types	This indicates the list of task types that are subscribed to the station type.

3.11.3 Setting Up a Print Format Preference

A task being performed at a station may require labels or documentation to be printed. The labels or documents that are required are identified at each station.

For example, packing station requires packing slip to be printed.

To set up a print format preference:

1. From the tree in the application rules side panel, choose Warehouse Layout > Stations. The Stations window displays with the list of Station Types.
2. Select the Station Type for which the Print Format Preference is to be set up.
3. Choose . The Print Format Preferences pop-up window displays.
4. Enter information in the applicable fields. Refer [Table 3–18](#) for field value descriptions.
5. Choose .

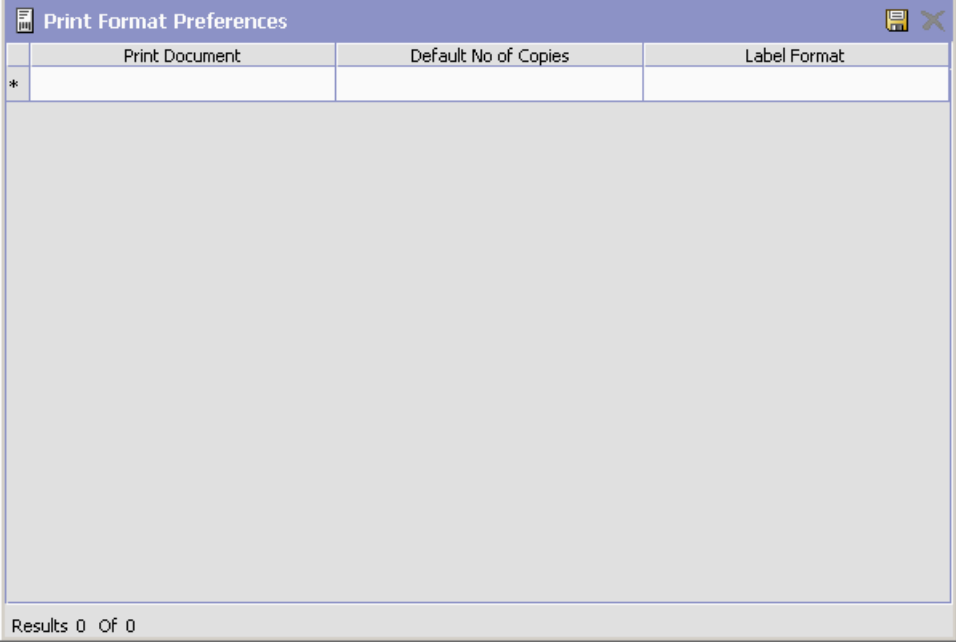

	Print Document	Default No of Copies	Label Format
*			

Results 0 Of 0

Table 3–18 Station Type Print Format Preferences Pop-up Window

Field	Description
Print Document	Choose the relevant document to be printed.
Default No. of Copies	Enter the number of copies to be printed by default.
Label Format	Choose the format of the label for the print document.

Note: Choose  in the Print Format Preferences pop-up window to delete a print format preference (Print Document, Default Number of Copies, and Label Format).

3.11.4 Setting Up a Station ID

Individual stations are represented as Station Ids associated with a Station Type.



For example, two stations used for manifesting purposes.

Use Stations set-up for:

- [Creating a Station ID](#)
- [Creating a New Station ID from a Station ID](#)
- [Modifying a Station ID](#)
- [Deleting a Station ID](#)

3.11.4.1 Creating a Station ID

To create a station ID:

1. From the tree in the application rules side panel, choose Warehouse Layout > Stations. The Stations window displays with the list of Station Types.
2. Choose the Station Type for which the Station is to be created.
3. Choose . The Station pop-up window displays.
4. Enter information in the applicable fields. See [Table 3–19](#) for field value descriptions.
5. Choose .

Station

Station Type: MANIFEST

Station Id:

Station Details		
Station Location Size Code	Location Name	Location
INFINITE	MANIFESTSTATION	

Results 0 Of 1



Table 3–19 Station Pop-up Window

Field	Description
Station Type	This indicates the station type for which the station is being created.
Station ID	Enter the station id for the station being created.
Station Details	
Station Location Size Code	Indicates the location size code applicable to the station.
Location Name	Indicates the name of the location applicable to the station.
Location	Enter the name of the location to be used for the station.

Note: The sort station modeled must have a common in-staging location. Sterling Commerce recommends that you stage the in-staging location at a dock location where inbound shipments are received and putaway.

3.11.4.2 Creating a New Station ID from a Station ID



To create a new station ID from a station ID:

1. From the tree in the application rules side panel, choose Warehouse Layout > Stations. The Stations window displays with the list of Station Types.
2. Choose the Station Type for which the Station is to be created.
3. From the Station Type tree, select the Station to be copied to create new Station.
4. Choose . The Station pop-up window displays.
5. Enter information in the applicable fields. See [Table 3–19](#) for field value descriptions.
6. Choose .

3.11.4.3 Modifying a Station ID

Once a Station ID has been created, it can be modified.

To modify a station ID:

1. From the tree in the application rules side panel, choose Warehouse Layout > Stations. The Stations window displays with the list of Station Types.
2. Choose the Station Type whose Station is to be modified.
3. From the Station Type tree, select the Station to be modified.
4. Choose . The Station pop-up window displays.
5. Enter information in the applicable fields. See [Table 3–19](#) for field value descriptions.
6. Choose .

3.11.4.4 Deleting a Station ID

To delete a station ID:



1. From the tree in the application rules side panel, choose Warehouse Layout > Stations. The Stations window displays with the list of Station Types.
2. Choose the Station Type whose Station is to be deleted.
3. From the Station Type tree, select the Station to be deleted.
4. Choose .

3.11.5 Setting Up a Station Device Association

A Station may have one or more devices associated with it. Station Device Association defines this association between a station and devices.

For example, a packing station can have a scanner and printer associated with it.

To set up a station device association:

1. From the tree in the application rules side panel, choose Warehouse Layout > Stations. The Stations window displays with the list of Station Types.
2. From the Station Type tree, select the relevant Station to be associated with a Device.
3. Choose . The Station Device Association pop-up window displays.
4. Enter information in the applicable fields. See [Table 3–20](#) for field value descriptions.
5. Choose .

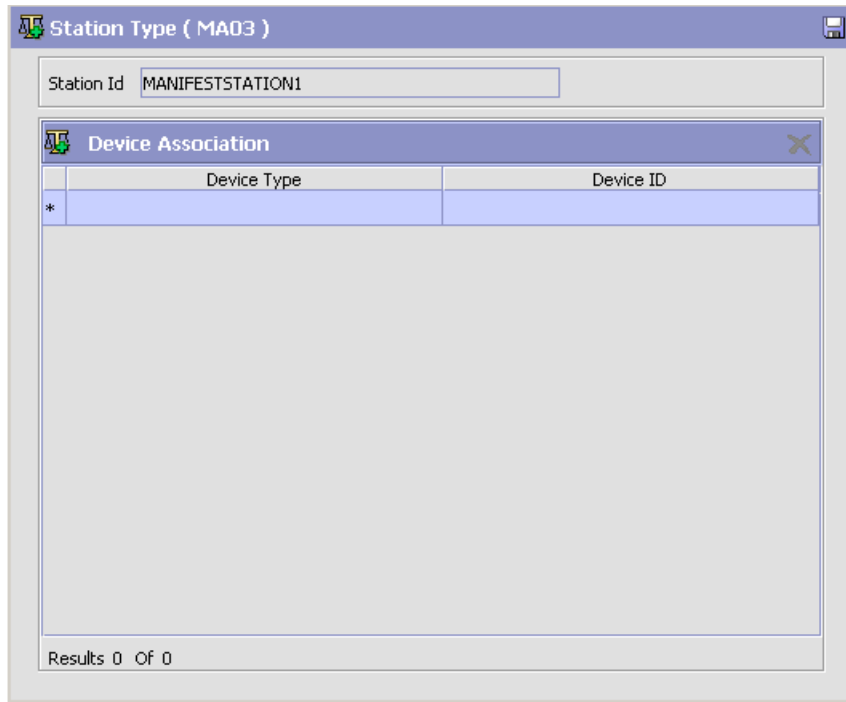



Table 3–20 Station Device Association Pop-up Window

Field	Description
Station ID	This indicates the station id of the station being associated with a device.
Device Association	
Device Type	Choose the device type of the device to be associated with the station. For more information about a device type, see Section 14.1.1, "Defining a Device Type" on page 955.
Device ID	Choose the device id of the device to be associated with the station.

Note: Choose  in the Station Device Association pop-up window to delete a device association (Device Type and Device ID).

3.12 Defining Transaction Repository

A repository is a logical collection of entities that define the business process workflow. The transaction repository includes the following entities:

- Transactions
- Conditions
- Actions
- Services

Selling and Fulfillment Foundation provides a base repository for each of the system defined process types. Some of the entities within a repository are copied when creating a new document type. For more information about creating a new document type, see the *Selling and Fulfillment Foundation: Application Platform Configuration Guide*.

3.12.1 Transactions

Every process type has a set of base transactions defined for it. A transaction is a logical unit of work that is necessary for performing an activity within Selling and Fulfillment Foundation. Base transactions are predefined transactions that contain information about how the transaction behaves, such as how many copies of a transaction can be kept in a process type and whether or not it can have configurable base pick and drop statuses. Base transactions can be used to create new transactions. These transactions can be changed within the limits defined in the base transaction.

For more information about transactions, see the *Selling and Fulfillment Foundation: Application Platform Configuration Guide*.

To view the transaction repository details for warehouse layout:

Defining Transaction Repository

1. From the tree in the application rules side panel, choose Warehouse Layout > Transaction Repository. The WMS Layout Definition window displays.
2. In the WMS Layout Definition window, choose .
3. The Transactions tab window displays.

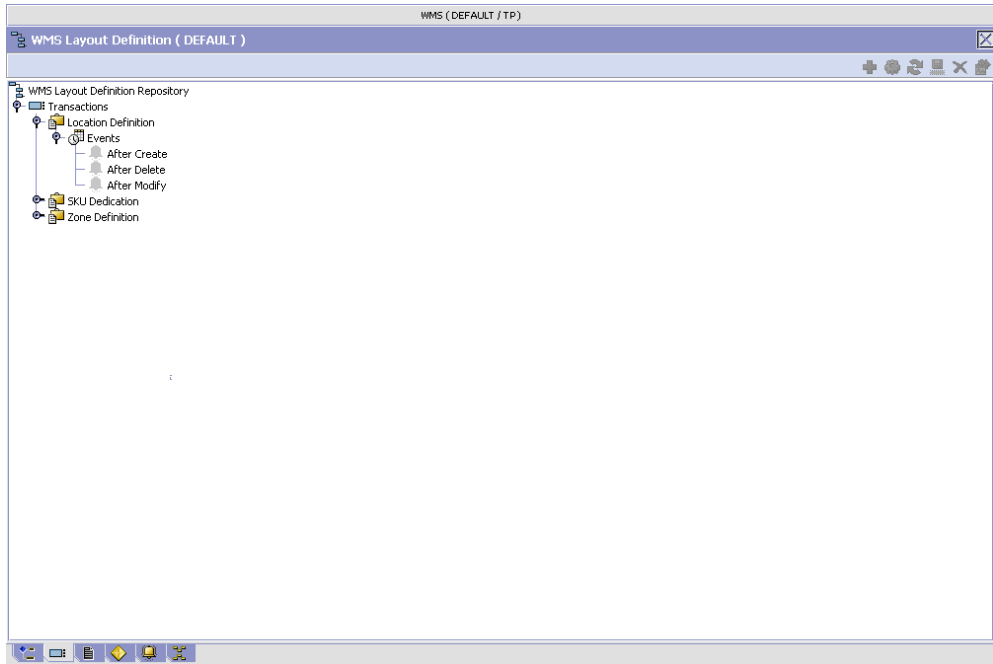



Table 3–21 WMS Layout Definition - Transactions Tab Window

Field	Description
Location Definition	This transaction represents the changes to a location definition, with specificity to the creation, modification and deletion of a location.
SKU Dedication	This transaction represents the existence of inventory for a non-dedicated item.
Zone Definition	This transaction represents the changes to a zone definition, with specificity to the creation, modification and deletion of a location.

3.12.2 Conditions

A **condition** matches document type attributes against decision points and routes the documents to different paths based on the specified attribute and value combinations. The document type attributes against which conditions can be created are predefined in Selling and Fulfillment Foundation. You can use these attributes in any combination or you can create conditions that run the appropriate application logic for specific circumstances.

To view the condition repository details for warehouse layout:

1. From the tree in the application rules side panel, choose Warehouse Layout > Transaction Repository. The WMS Layout Definition window displays.
2. In the WMS Layout Definition window, choose .
3. The Conditions tab window displays.

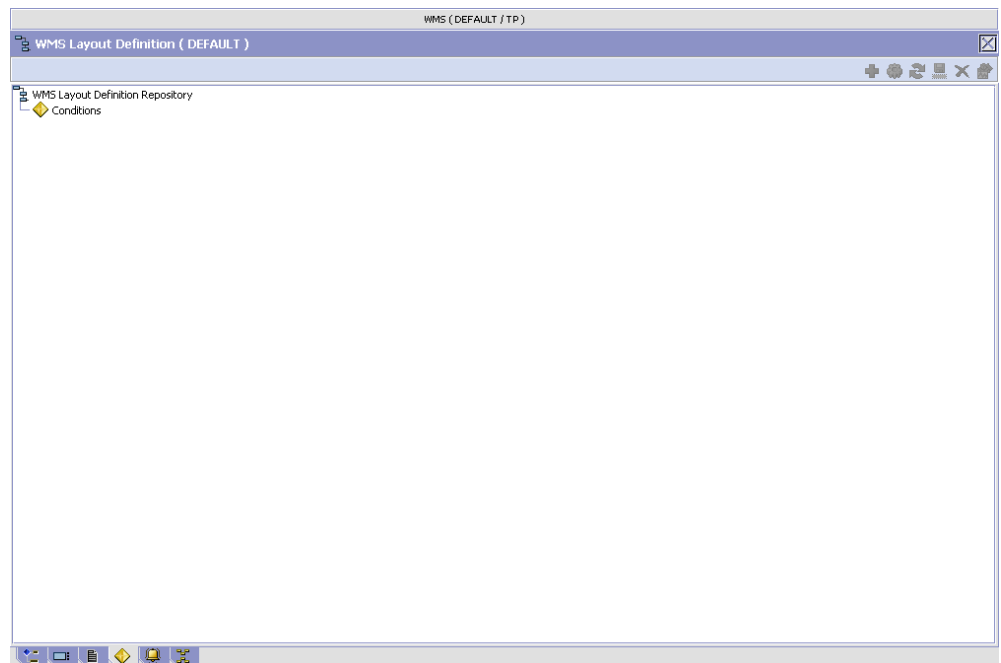

The Sterling WMS default transaction repository does not have any conditions specified.

3.12.3 Actions

An **action** is a process or program that is triggered by an event. These processes and programs send user alert notifications and automatically resolve issues.

For example, when a variance task is created (the event), you can set an action to send the enterprise user an e-mail.

For more information about creating and modifying actions, see the *Selling and Fulfillment Foundation: Application Platform Configuration Guide*.

To view the action repository details for warehouse layout:

1. From the tree in the application rules side panel, choose Warehouse Layout > Transaction Repository. The WMS Layout Definition window displays.
2. In the WMS Layout Definition window, choose .
3. The Actions tab window displays.

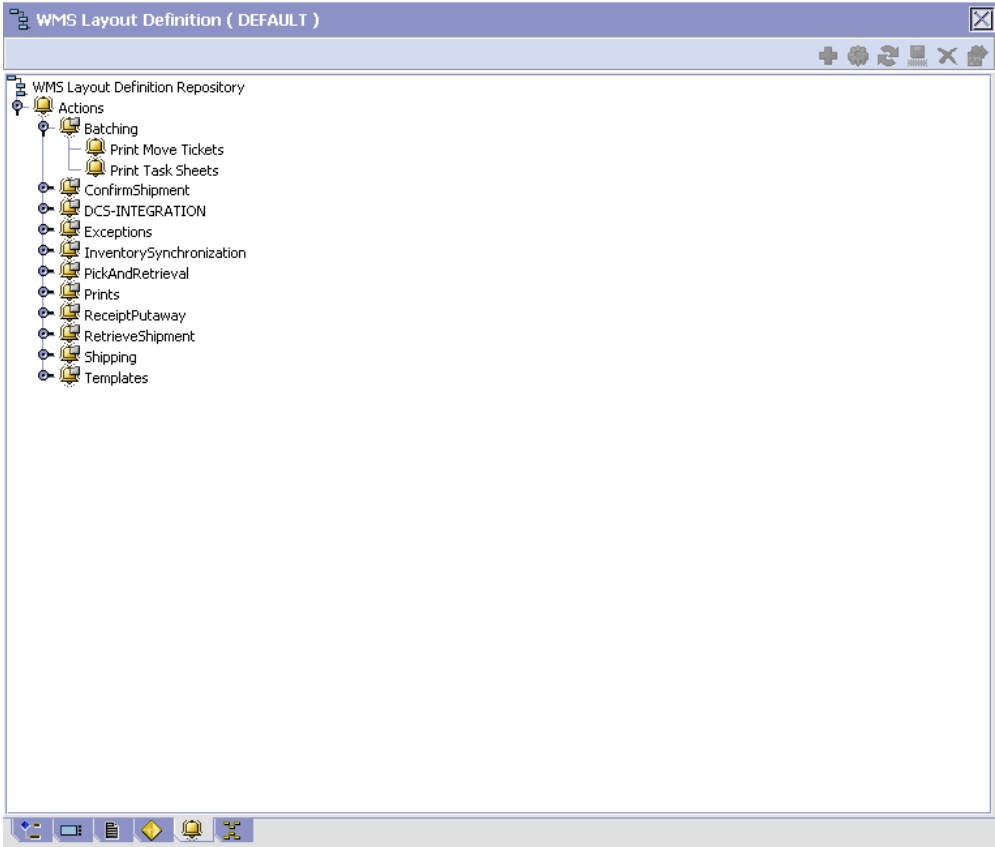

Table 3–22 WMS Layout Definition - Actions Tab Window

Field	Description
Batchings	Default settings are provided for: Print Move Tickets – Invokes the batch printing service for printing the move tickets. Print Task Sheets – Invokes the batch print service for printing the task sheets.
ConfirmShipment	Default settings are provided for: ConfirmShipment – Invokes the confirmShipment flow to confirm the shipment.

Table 3–22 WMS Layout Definition - Actions Tab Window

Field	Description
DCS-Integration	Default settings are provided for: InventoryDownload – Invokes the YantraWMSInventoryDownloadService service to download the inventory information from Selling and Fulfillment Foundation to DCS. PODownload – Invokes the YantraWMSPODownloadService service to download the Purchase Order information from Selling and Fulfillment Foundation to DCS.
Exceptions	Default settings are provided for: ShortagesDetected – Invokes the LogWavePlaFailure exception service when shortage of inventory occurs during wave release.
InventorySynchroniza tion	Default settings are provided for: CollectInventoryMismatch – This service collects the inventory mismatch information between an external system and Selling and Fulfillment Foundation. This is typically caused when some inventory updates at a node or a warehouse are not reported to Selling and Fulfillment Foundation.
PickAndRetrieval	Default settings are provided for: ConfirmEmptyLocationAfterPick – Invokes the GenerateCountRequest flow which creates a count request.

Table 3–22 WMS Layout Definition - Actions Tab Window

Field	Description
Prints	<p>Default settings are provided for:</p> <p>PickList Print – Invokes the print service for printing the Pick List.</p> <p>LTL Manifest – Invokes the print service for printing the Less-than Truck Load Manifest.</p> <p>Print Load BOL – Invokes the print service for printing the Load Bill of Lading.</p> <p>Print Pack List – Invokes the print service for printing the Pack List.</p> <p>Print Post Pick Container Labels – Invokes the print service for printing UCC-128 container labels for containers, when system defined packing process is used.</p> <p>Print Shipment BOL – Invokes the print service for printing the Shipment Bill of Lading.</p> <p>Print Shipping Label – Invokes the print service for printing the UCC-128 container labels.</p> <p>Print Wave – Invokes the Print service for printing a Wave.</p>
ReceiptPutaway	<p>Putaway products on receipt closure – Indicates the default action provided to automatically initiate putaway of purchase order receipts.</p>
RetrieveShipment	<p>Retrieve Requested Serial – This service invokes the retrieveShipment API to retrieve the requested serials to the specified location.</p>

Table 3–22 WMS Layout Definition - Actions Tab Window

Field	Description
Shipping	<p>Default settings are provided for:</p> <p>Load Left Origin – Invokes the doLoadLeftOriginUpdates service to mark that the load has left the origin.</p> <p>Stop Shipping – Invokes the RaiseStopShippingAlert service to raise an alert to stop the processing of the shipment.</p>
Templates	<p>Default settings are provided for:</p> <p>Log Exception – Logs the reasons due to which a count request could not be created for a Count Program.</p> <p>Publish Data – Sends data to external queue or internal tables.</p> <p>Raise Exception – Raises an alert using the Event Management from the published information.</p> <p>Send E-mail – Raises an e-mail action to create an e-mail in the template format from the published information.</p> <p>Send E-mail-HTML format – Raises an e-mail action to create an e-mail in HTML format from the published information.</p>

3.12.4 Service Definitions

Service definitions are a representation of the logic that regulates document workflow services. The Service Builder is a graphical interface that enables you to create a graphical representation of these *services*.

For more information about service definitions, see the *Selling and Fulfillment Foundation: Application Platform Configuration Guide*.

To view the service definition repository details for warehouse layout:

1. From the tree in the application rules side panel, choose Warehouse Layout > Transaction Repository. The WMS Layout Definition window displays.
2. In the WMS Layout Definition window, choose .
3. The Service Definitions tab window displays.

For more information about creating and modifying service definitions, see the *Selling and Fulfillment Foundation: Application Platform Configuration Guide*.

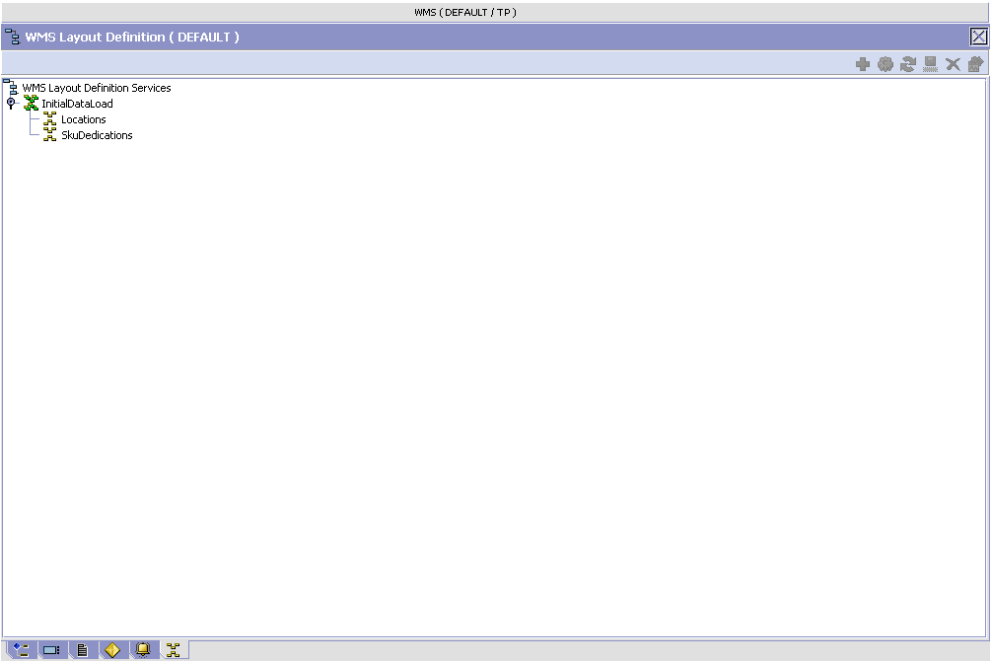

Table 3–23 Warehouse Layout - Service Definitions Tab Window

Field	Description
InitialDataLoad	
Location	This service loads location information from a flat file to the database. For more information about Initial Data Loading, see <i>Selling and Fulfillment Foundation: Integration Guide</i> .
SkuDedications	This service loads SKU dedication information from a flat file to the database. For more information about Initial Data Loading, see <i>Selling and Fulfillment Foundation: Integration Guide</i> .

4

Configuring Inventory

Inventory defines the comprehensive functionality of the Sterling WMS to track, monitor, and maintain inventory in a warehouse. Inventory visibility is provided through consoles that provide the necessary granular information.

Use Inventory for:

- [Defining Product Class](#)
- [Defining Inventory Status](#)
- [Defining Inventory Adjustment Reasons](#)
- [Defining Inventory Transition Rules](#)
- [Defining Storage Preferences](#)
- [Defining a Replenishment Strategy](#)
- [Defining Replenishment Algorithm](#)
- [Defining Monitoring Rules](#)
- [Defining Transaction Repository](#)
- [Defining Purge Criteria](#)
- [Defining Node Item Attributes](#)
- [Defining Move Request Parameters](#)
- [Defining Count](#)

4.1 Defining Product Class

You can define the common codes used to indicate a product class. This is done in the Inventory Console. The product class refers to a product's classification, such as first quality, second quality, or finished good.

Use Product Class for:



- [Creating a Product Class](#)
- [Creating a New Product Class From an Existing Product Class](#)
- [Modifying a Product Class](#)
- [Deleting a Product Class](#)

4.1.1 Creating a Product Class

To create a product class:

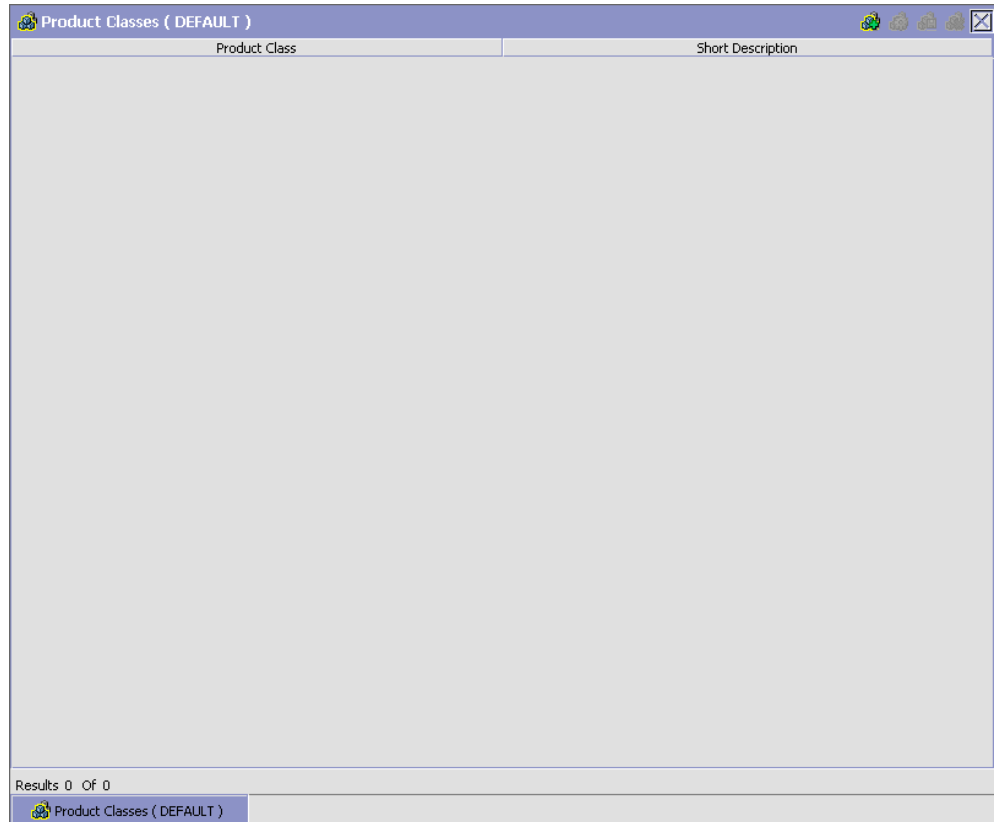
1. From the tree in the application rules side panel, choose Inventory > Product Class. The Product Classes window displays.



2. In the Product Classes window, choose . The Product Class Details pop-up window displays.
3. Enter information in the applicable fields. Refer [Table 4–1](#) for field value descriptions.
4. Choose .



The screenshot shows a dialog box titled "Product Class Details". It contains three text input fields stacked vertically, each with a label to its left: "Product Class", "Short Description", and "Long Description". A small icon is visible in the top right corner of the dialog box.

Table 4–1 *Product Class Details Pop-up Window*

Field	Description
Product Class	Enter the product class.
Short Description	Enter a brief description for the product class.
Long Description	Enter a more detailed description for the product class.

4.1.2 Creating a New Product Class From an Existing Product Class

To create a new product class from an existing product class:



1. From the tree in the application rules side panel, choose Inventory > Product Class. The Product Classes window displays with the list of product classes.
2. Choose the Product Class to be copied from. Choose . The Product Class Details pop-up window displays.
3. Enter information in the applicable fields. Refer [Table 4–1](#) for field value descriptions.
4. Choose .

4.1.3 Modifying a Product Class

Once a Product Class has been created, it may be modified.

To modify a product class:

1. From the tree in the application rules side panel, choose Inventory > Product Class. The Product Classes window displays with the list of product classes.

2. Choose the Product Class to be modified. Choose . The Product Class Details pop-up window displays.
3. Enter information in the applicable fields. Refer [Table 4–1](#) for field value descriptions.
4. Choose .

4.1.4 Deleting a Product Class

To delete a product class:

1. From the tree in the application rules side panel, choose Inventory > Product Class. The Product Classes window displays with the list of product classes.
2. Choose the Product Class to be deleted.
3. Choose .

4.2 Defining Inventory Status

Inventory Status is an additional classification of inventory in a node. An inventory status is directly connected to the availability of inventory through the association with a supply type. Inventory status is applied at the time of receiving, during packing or repair processes in a warehouse.

For example, during the packing process, a defective SKU may require a quality hold on the remaining units of the SKU, which are a part of the same shipment.

Use Inventory Status for:

- [Creating an Inventory Status](#)
- [Modifying an Inventory Status](#)
- [Deleting an Inventory Status](#)

4.2.1 Creating an Inventory Status

To create an inventory status:

1. From the tree in the application rules side panel, choose Inventory > Inventory Status. The Inventory Status List window displays.

2. Enter information in the applicable fields. Refer [Table 4–2](#) for field value descriptions.
3. Choose .

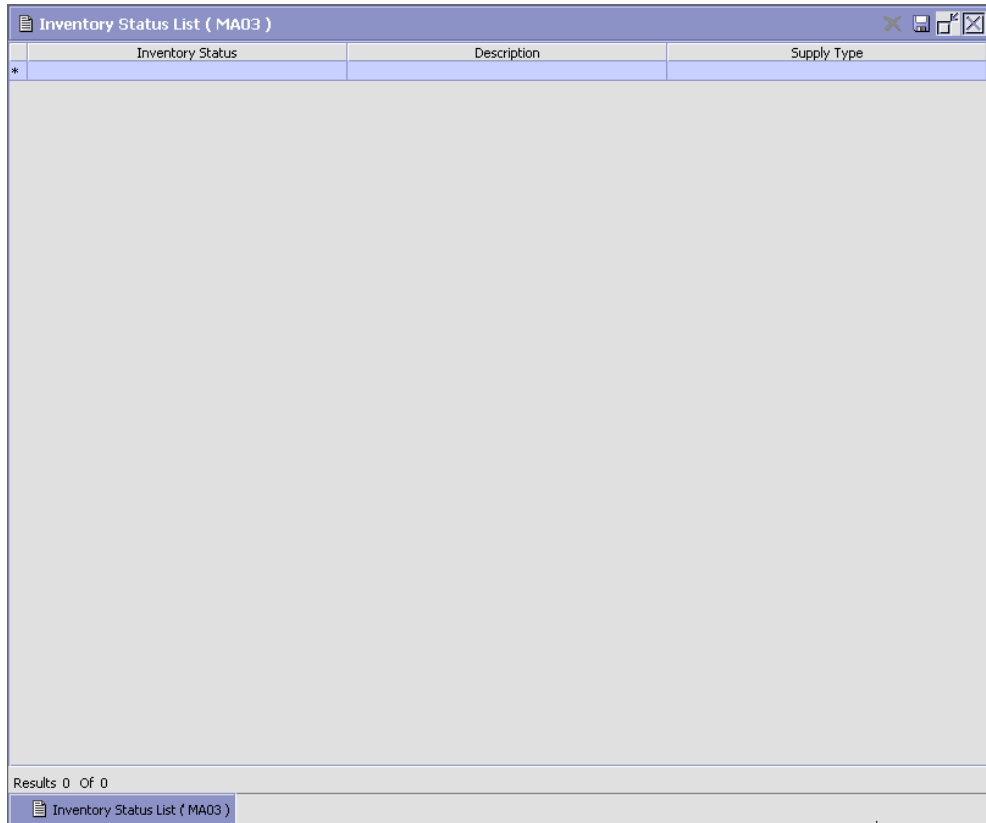

Table 4–2 *Inventory Status List Window*

Field	Inventory
Inventory Status	Enter the name of the inventory status.

Table 4–2 Inventory Status List Window

Field	Inventory
Description	Enter a brief description for the inventory status.
Supply Type	Choose the supply type associated with the inventory status. Supply type indicates classification of the inventory.

The inventory availability is visible at a product class and inventory status level for each SKU. The supply type attached with the inventory is used in Available To Promise (ATP) calculations.

4.2.2 Modifying an Inventory Status

Once an inventory status has been created, it can be modified.

To modify an inventory status:

1. From the tree in the application rules side panel, choose Inventory > Inventory Status. The Inventory Status List window displays with the list of Inventory Status.
2. Enter information in the applicable fields. Refer [Table 4–2](#) for field value descriptions.
3. Choose .

The supply type associated with an inventory status cannot be modified if there is any inventory for the inventory status.

4.2.3 Deleting an Inventory Status

To delete an inventory status:

1. From the tree in the application rules side panel, choose Inventory > Inventory Status. The Inventory Status List window displays with the list of Inventory Status.
2. Choose the Inventory Status to be deleted.
3. Choose .

An inventory status cannot be deleted if there is any inventory with that inventory status.

4.3 Defining Inventory Adjustment Reasons

An inventory adjustment in the Sterling WMS is associated with a reason. The Inventory Adjustment Reason allows tracking and reporting of all adjustments at a reason code level. Inventory adjustment reason codes provide granularity for reporting and tracking of warehouse performance.

The Sterling WMS uses pre-defined reason codes such as 'RECEIPT', 'SHIP', 'PACK' for certain operations. These codes are mandatory for a warehouse.

The 'RECEIPT' reason code is used for recording receipt of inventory for an inbound shipment (including returns). The 'PACK' reason code is used whenever you add product to an outbound container, which may happen during picking or packing process. The inventory being packed is moved into a virtual location called as the Accounting Bin. This location association is mandatory for this reason code. During the shipping process, inventory is decremented from this bin location. The bin location associated with 'PACK' reason code should not have Track Pallet or Track Case functionalities enabled. The 'SHIP' reason code is used for recording shipping of inventory for an outbound shipment.

Use Inventory Adjustment Reasons for:

- [Creating an Inventory Adjustment Reason](#)
- [Creating a New Inventory Adjustment Reason from an Existing Inventory Adjustment Reason](#)
- [Modifying an Inventory Adjustment Reason](#)
- [Deleting an Inventory Adjustment Reason](#)

The code used is interfaced with external systems including financials and data warehousing systems.

4.3.1 Creating an Inventory Adjustment Reason

To create an inventory adjustment reason:

1. From the tree in the application rules side panel, choose Inventory > Inventory Adjustment Reasons. The Inventory Adjustment Reasons window displays.

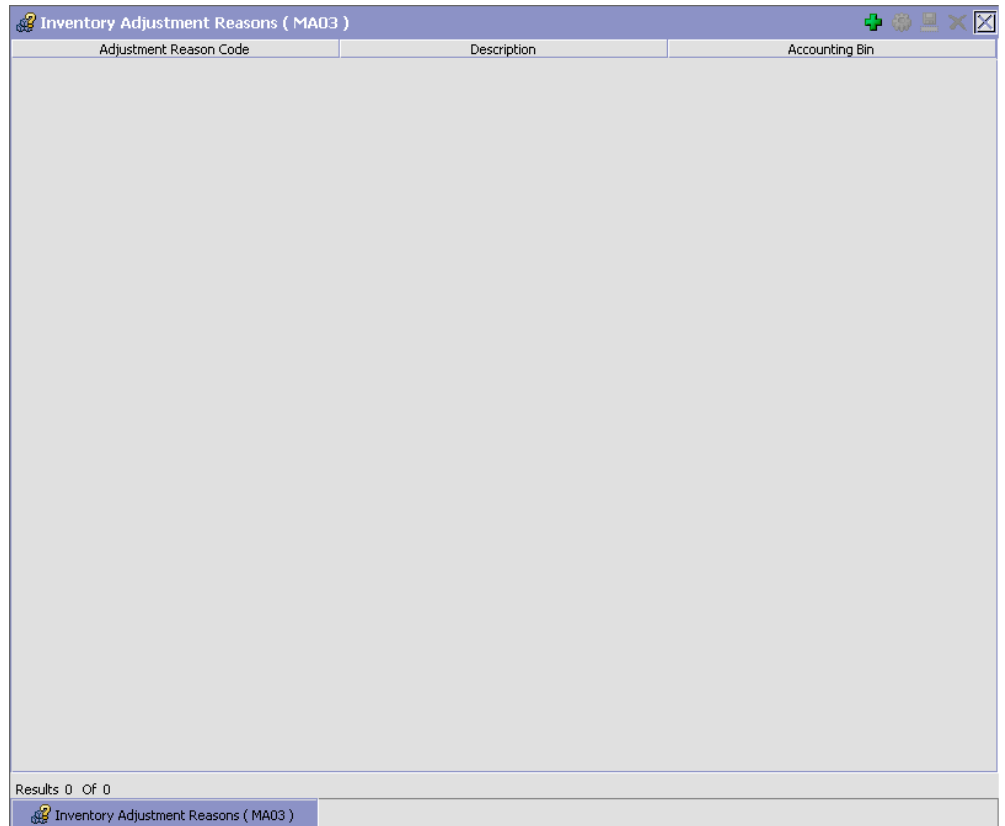



2. Choose  to create a new inventory adjustment reason. The Inventory Adjustment Reason Details window displays.
3. Enter information in the applicable fields. Refer [Table 4–3](#) for field value descriptions.
4. Choose .

Table 4–3 Inventory Adjustment Reason Details Window

Field	Description
Adjustment Reason Code	Enter the reason code for inventory adjustment. Typical values seen are 'Count Error,' 'Receipt Error,' 'Breakages,' and 'Scrap'.
Description	Enter a brief description for the adjustment reason code.

Table 4–3 Inventory Adjustment Reason Details Window



Field	Description
Accounting Bin	<p>Choose the accounting bin location for the inventory, if required. Locations in the node with location type as 'VIRTUAL' displays.</p> <p>The accounting bin represents a virtual location in the warehouse, which is used as a reconciliation mechanism for the inventory being adjusted. For example, in a 3PL warehouse, a client's representative is responsible for the inventory picture. This means that all adjustments or discrepancies found during count require an additional step for approval.</p> <p>The accounting bin also provides a location that tracks the discrepancies as they happen and also reconcile them when inventory is found elsewhere in the warehouse (usually a neighboring location).</p> <p>Choose  to create a new accounting bin location for the inventory.</p>
This Adjustment Reason Usually Implies	Choose either Increment, Decrement, or Either Increment or Decrement.
Host Reason Codes	
Enterprise Code	Choose the enterprise code.
Host Adjustment Reason Code	<p>Choose the host adjustment reason code.</p> <p>The host reason code is used to translate warehouse reason codes to a Host Reason Code.</p> <p>For example, a warehouse that has reason codes by department level requiring to translate these codes to a common Host reason code. The host reason code is part of the data published to the host system.</p> <p>Choose  to create a new Host Adjustment Reason Code, by entering Inventory Reason and its short and long descriptions.</p>

Table 4–3 Inventory Adjustment Reason Details Window

Field	Description
Adjustment Sequence	
Adjustment Sequence	Displays the sequence or priority number of the locations or zones for adjustment. Locations or zones are adjusted consecutively, based on their Adjustment Sequence number. Locations or zones with a lower Adjustment Sequence number are adjusted prior to locations or zones with a higher Adjustment Sequence number.
Location ID	Displays the location from which the inventory is deducted.
Zone ID	Displays the zone from which the inventory is deducted.

Note: When creating a new Inventory Adjustment Reason, the Adjustment Sequence panel is available only after you save the details entered.

4.3.1.1 Defining Adjustment Sequence

An inventory adjustment reason in the Sterling WMS can be associated with an adjustment sequence. Configuring an adjustment sequence for an inventory adjustment reason lets you adjust inventory from a specified sequence of locations when the pick location cannot be verified. For example, it can be used for cash and carry transactions at the point of sale in stores. An inventory adjustment reason code need not necessarily have an adjustment sequence associated with it.

The `adjustLocationInventory` API is used to adjust location inventory. This API can be called with either a Location ID and an inventory reason code associated with an adjustment sequence or with only an inventory reason code associated with an adjustment sequence, without a Location ID. The transaction does not go through when the Location ID is not passed and the inventory reason code passed does not have an adjustment sequence associated with it. For more information about the `adjustLocationInventory` API, see the *Selling and Fulfillment Foundation: Integration Guide*.

Use Adjustment Sequence for:

- [Creating an Adjustment Sequence](#)
- [Modifying an Adjustment Sequence](#)
- [Deleting an Adjustment Sequence](#)

4.3.1.1.1 Creating an Adjustment Sequence

To create an adjustment sequence:

1. In the Adjustment Sequence panel of the Inventory Adjustment Reason Details window, choose . The Adjustment Sequence Details window displays.

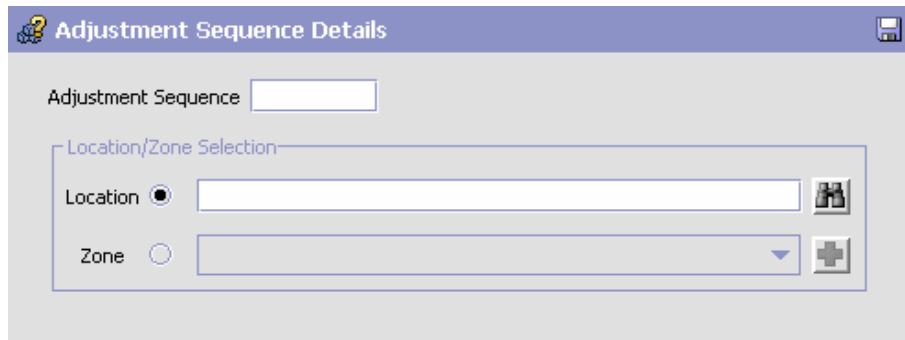

The screenshot shows a software window titled "Adjustment Sequence Details". At the top left is a help icon (question mark) and at the top right is a save icon (floppy disk). Below the title bar is a text input field labeled "Adjustment Sequence". Underneath is a section titled "Location/Zone Selection" which contains two radio buttons: "Location" (which is selected) and "Zone". The "Location" field has a search icon to its right, and the "Zone" field has a dropdown arrow and a plus icon to its right.





2. Enter information in the applicable fields. Refer [Table 4–4](#) for field value descriptions.
3. Choose .

Table 4–4 Adjustment Sequence Details Window

Field	Description
Adjustment Sequence	<p>Enter the sequence or priority number of the location or zone for adjustment.</p> <p>Locations or zones are adjusted consecutively, based on their Adjustment Sequence number. Locations or zones with a lower Adjustment Sequence number are adjusted prior to locations or zones with a higher Adjustment Sequence number.</p> <p>You can configure a virtual location to be one of the locations in the sequence. In this case, if the item is unavailable in the prior locations, it is adjusted against the virtual location.</p>
Location ID	<p>Enter the location from which the inventory is deducted.</p> <p>Choose  to create a new location for adjustment.</p> <p>Choose  to search a configured location for adjustment.</p>
Zone ID	<p>Enter the zone from which the inventory is deducted.</p> <p>Choose  to create a new zone for adjustment.</p> <p>Choose  to search a configured zone for adjustment.</p>

Note: It is recommended that the regular locations and the virtual location of the adjustment sequence are configured in separate zones.

4.3.1.1.2 Modifying an Adjustment Sequence

To modify an adjustment sequence:

1. In the Adjustment Sequence panel of the Inventory Adjustment Reason Details window, choose the Adjustment Sequence to modify.
2. Choose . The Adjustment Sequence Details window displays.

3. Enter information in the applicable fields. Refer [Table 4–4](#) for field value descriptions.
4. Choose .



4.3.1.1.3 Deleting an Adjustment Sequence

To delete an adjustment sequence:

1. In the Adjustment Sequence panel of the Inventory Adjustment Reason Details window, choose the Adjustment Sequence to delete.
2. Choose .

4.3.2 Creating a New Inventory Adjustment Reason from an Existing Inventory Adjustment Reason

To create a new inventory adjustment reason from an existing inventory adjustment reason:



1. From the tree in the application rules side panel, choose Inventory > Inventory Adjustment Reasons. The Inventory Adjustment Reasons window displays with the list of Inventory Adjustment Reasons.
2. Choose the Inventory Adjustment Reason to be copied from.
3. Choose . The Inventory Adjustment Reason Details window displays.
4. Enter information in the applicable fields. Refer [Table 4–3](#) for field value descriptions.
5. Choose .

4.3.3 Modifying an Inventory Adjustment Reason

Once an inventory adjustment reason has been created, it can be modified.

To modify an inventory adjustment reason:

1. From the tree in the application rules side panel, choose Inventory > Inventory Adjustment Reasons. The Inventory Adjustment Reasons window displays with the list of Inventory Adjustment Reasons.
2. Choose the Inventory Adjustment Reason to modify.

3. Choose . The Inventory Adjustment Reason Details window displays.
4. Enter information in the applicable fields. Refer [Table 4–3](#) for field value descriptions.
5. Choose .

4.3.4 Deleting an Inventory Adjustment Reason

To delete an inventory adjustment reason:

1. From the tree in the application rules side panel, choose Inventory > Inventory Adjustment Reasons. The Inventory Adjustment Reasons window displays with the list of Inventory Status.
2. Choose the Inventory Adjustment Reason to be deleted.
3. Choose .

4.4 Defining Inventory Transition Rules

Inventory Status Transition Rules are designed primarily to control the inventory visibility to the Order Management system. They can be used during inbound putaway and during replenishment from overflow zones to bulk / active zones to control what inventory is visible to the order management system for scheduling.

While moving product between zones that are used for outbound picking, it is not possible to limit the visibility of one versus the other, because inventory within all zones used for outbound picking must be available for scheduling. Hence, the inventory status transition rules should not be setup between bulk zone to active zone in situations where bulk picks are possible directly from bulk zones. However, they can be used in movement of product from overflow zones to bulk / active zones where product is not directly picked for the outbound process from the overflow zones.

Inventory Status Transition Rules can be specified at a zone level to convert the Inventory status associated with inventory being moved into the zone appropriately.

NOTE: To be able to confirm a Work Order you should have an Inventory Status Transition Rule setup for the Zone that the VAS location belongs. This Inventory Status Transition Rule should be defined from Blank to an Inventory Status that is associated with an ONHAND Supply Type.

For example, inventory being moved into the QC zone is converted to 'Quality Held' from all other inventory statuses.

For more information about setting up Inventory Transition Rules, while setting up a zone, see [Section 3.5.1, "Creating a Zone"](#).

Use Inventory Transition Rules for:

- [Creating an Inventory Transition Rule](#)
- [Modifying an Inventory Transition Rule](#)
- [Deleting an Inventory Transition Rule](#)

4.4.1 Creating an Inventory Transition Rule

To create an inventory transition rule:

1. From the tree in the application rules side panel, choose Inventory > Inventory Transition Rules. The Inventory Transition Rules window displays.
2. Enter information in the applicable fields. Refer [Table 4–5](#) for field value descriptions.
3. Choose .

	Zone	Inventory Status	Supply Type	New Inventory Status	New Supply Type
*					

Results 0 Of 0

Inventory Transition Rules (MA03)

Table 4–5 Inventory Transition Rules Window

Field	Description
Zone	<p>Choose the zone for which the inventory transition rule is being set up.</p> <p>For more information about Creating a Zone, see Section 3.5.1, "Creating a Zone" on page 47</p>
Inventory Status	<p>Choose the inventory status of the product being moved into the zone.</p> <p>This defines the inventory status that needs to be modified when moved into this zone.</p> <p>For more information, see Section 4.2.1, "Creating an Inventory Status" on page 115.</p>
Supply Type	<p>This indicates the supply type associated with the inventory status.</p> <p>Supply type indicates classification of the inventory. This value is populated automatically by the Sterling WMS from the inventory status configuration.</p> <p>For more information about Inventory Supply Types, see the <i>Sterling Global Inventory Visibility: Configuration Guide</i>.</p>
New Inventory Status	<p>Choose the inventory status applicable to the zone.</p> <p>This defines the new inventory status that replaces the current inventory status. This is used for the automatic conversion of the inventory status.</p> <p>For example, a warehouse with QC zone having 'Quality Held' inventory status and bulk storage zones having 'Normal' inventory status. All product putaway into QC zone has status converted to 'Quality Held' automatically. Inventory putaway into bulk storage has status converted to 'Normal' automatically.</p>
New Supply Type	<p>This indicates the supply type associated with the inventory status.</p> <p>The supply type indicates classification of the inventory. This value is populated automatically by Sterling WMS from the inventory status configuration.</p> <p>For more information about Inventory Supply Types, see the <i>Sterling Global Inventory Visibility: Configuration Guide</i>.</p>

4.4.2 Modifying an Inventory Transition Rule

Once an Inventory Transition Rule has been created, it can be modified.

To modify an inventory transition rule:

1. From the tree in the application rules side panel, choose Inventory > Inventory Transition Rules. The Inventory Transition Rules window displays with the list of Inventory Transition Rules.
2. Enter information in the applicable fields. Refer [Table 4–5](#) for field value descriptions.
3. Choose .

4.4.3 Deleting an Inventory Transition Rule

To delete an inventory transition rule:

1. From the tree in the application rules side panel, choose Inventory > Inventory Transition Rules. The Inventory Transition Rules window displays with the list of Inventory Transition Rules.
2. Choose the Inventory Transition Rule to be deleted.
3. Choose .

4.5 Defining Storage Preferences

Storage Preferences are used to define activity constraints for the putaway of inventory that is not specifically requested by any department.

For example, during receiving, profiles for a vendor or item creates putaway request to the appropriate department. The remaining quantity that is not requested by a specific department is evaluated through the storage preferences.

Note: It is recommended that zones containing locations of type VIRTUAL should not be selected, when configuring the putaway preferences and retrieval strategy.

4.5.1 Selecting Storage Preferences

The Sterling Warehouse Management System uses an algorithm to select the best storage or putaway preference for an activity from a list of preferences.

To select the best storage preference for an activity, the Sterling Warehouse Management System:

1. Determines if the inventory type is Single SKU, Multi SKU, or Unknown SKU.

If the inventory type is Single SKU, the system determines the corresponding UOM and item classification.

2. Determines the values of product class, inventory status, segment, or segment type for the inventory to match with the values configured in the storage preferences.
3. Sorts the matched values in the following order:
 - a. Enterprise Code
 - b. LPN Type
 - c. UOM
 - d. Product Class
 - e. Inventory Status
 - f. Segment Type
 - g. Segment
 - h. Item Classification 1
 - i. Item Classification 2
 - j. Item Classification 3

The best matched storage preference is used for the activity.

Use Storage Preferences for:

- [Setting Up Storage Preferences for Single SKU](#)
- [Setting Up Storage Preferences for Multi-SKU/Multi-Level Container](#)
- [Setting Up Storage Preferences for Container with Unknown Contents](#)

4.5.2 Setting Up Storage Preferences for Single SKU

The storage preferences of a single SKU are specified here.

Use Storage Preferences set-up for:

- [Creating a Storage Preference for Single SKU](#)
- [Creating a New Storage Preference for Single SKU from an Existing Storage Preference](#)
- [Modifying a Storage Preference for Single SKU](#)
- [Deleting a Storage Preference for Single SKU](#)

4.5.2.1 Creating a Storage Preference for Single SKU

To create a storage preference for single SKU:

1. From the tree in the application rules side panel, choose Inventory > Storage Preferences. The Storage Preferences window displays.
2. In the Storage Preferences window, choose the Single-SKU tab. The Single-SKU tab window for Storage Preferences displays.

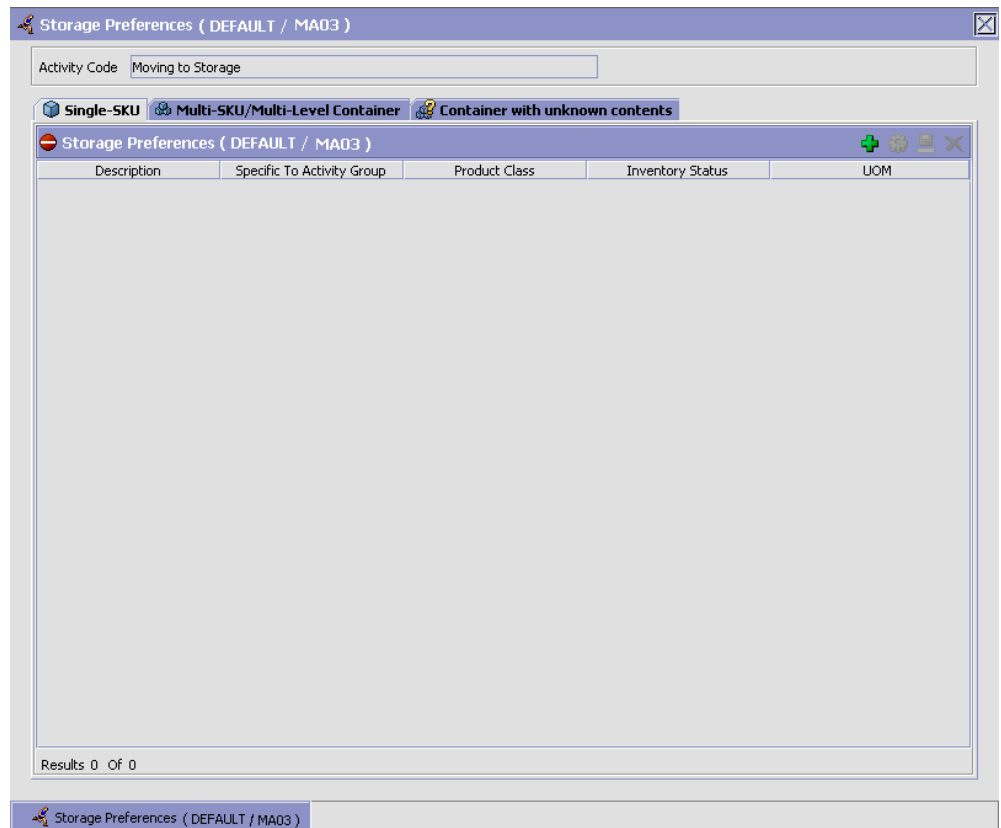



3. In the Single-SKU tab window, choose . The Storage Preference Details: Single SKU window displays.
4. Enter information in the applicable fields. Refer [Table 4–6](#) for field value descriptions.
5. Choose .

Table 4–6 Storage Preference Details - Single-SKU Window

Field	Description
Description	Enter a description for the activity constraint.
To View Strategy Click here	Choose  to view or set up Putaway Strategy. For more details on setting up a putaway strategy see Setting Up Putaway Strategy for Single-SKUs . Note: Putaway strategy may be specified for the putaway preferences after the preference is saved.
Activity Code	This indicates the activity code for the constraint.

Table 4–6 Storage Preference Details - Single-SKU Window

Field	Description
Requesting Activity Group	Choose the requesting activity group.
Product Class	Choose the product class for the preference, if applicable. Product class is the inventory classification of an item based on product's characteristics. Typical values are FQ - First Quality, SQ - Second Quality, etc.
Inventory Status	Choose the inventory status for the preference, if applicable. Inventory status refers to an inventory sub classification based on the results of the inventory control processes within the warehouse.
Segment Type	Enter the segment type for the preference, if applicable. This indicates an inventory category. Typical values are MTC – Made to Customer, and MTO - Made to Order.
Segment	Enter the segment number for the preference, if applicable. A segment holds either the specific buyer or specific order number that requires dedication.
UOM	Choose the UOM for the preference, if applicable. UOM points to the Unit of measure of the item.
Container Type	The container type associated with the UOM selected displays. Typical values are "Pallet" and "Case".
Item Classification	List of putaway item classifications for the Enterprise display. An example, Product Line is shown below.
Product Line	Choose relevant product line item classification for the putaway activity. Choose  . In the Classification Values window, select the applicable product line classification.
Zone Priorities	

Table 4–6 Storage Preference Details - Single-SKU Window

Field	Description
Priority	<p>Enter a number to represent the priority.</p> <p>The priority is used to sequence the order in which the zone priorities are evaluated. For example, all storage code level priorities are to be evaluated first before generic priorities.</p> <p>The priority needs to be a positive integer, greater than zero. This is mandatory.</p>
Zone	<p>Choose the relevant zone to be used as the target zone for putaway.</p> <p>This is a mandatory field.</p>
Storage Code	<p>Choose the storage code for the zone, if applicable.</p> <p>This limits the locations being evaluated to the storage code specified. For example, putaway of hazardous items into a zone are restricted to the locations having the appropriate storage code.</p>



Setting Up Putaway Strategy for Single-SKUs

You can set up putaway strategies to putaway applicable inventory from a source zone to a target zone, based on the strategy specified.

To set up putaway strategy for single-SKUs:

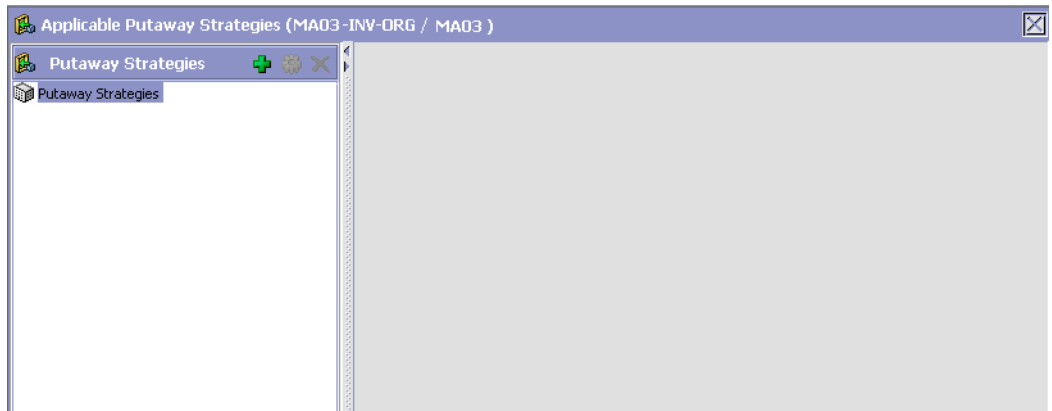
1. In the Storage Preference Details: Single SKU window, choose .
2. The Applicable Putaway Strategies window is displayed.



3. Choose  in the Putaway Strategies panel. The Putaway Strategy Details window appears in the right panel.
4. Enter information in the applicable fields. See the Putaway Strategy Details Window table for field value descriptions.
5. Choose .

Putaway Strategy Details

Description: Strategy for DVD-LockAndKey-EACH UOM: CASE

Item Classification:

Product Line: DVD

StorageType: LockAndKey

Product Line:

System Directed Putaway Task Types

	Source Zone	Target Zone	Container Type	Task Type
*				

Results: 0 Of 0

Ad Hoc Task Types

	Source Zone	Target Zone	Container Type	Task Type
*				

Results: 0 Of 0

Table 4–7 Putaway Strategy Details Window

Field	Description
Description	Enter a description for the Putaway Strategy.
UOM	Select the UOM for the Putaway Strategy, if applicable. Note: The UOM will be defaulted in instances where it has been specified in the Putaway Preference Details screen.

Table 4–7 Putaway Strategy Details Window





Field	Description
Item Classification	List of putaway item classifications for the Enterprise are displayed. An example, Product Line is shown below.
Product Line	Choose relevant product line item classification for the putaway activity. Choose  . In the Classification Values window, select the applicable product line classification.
System Directed Putaway Task Types	Displays the list of existing system directed putaway task types. You may use  to delete an existing system directed putaway task type.
Source Zone	Select the source zone from where the inventory is sourced.
Target Zone	Select the target zone to where the inventory is moved.
Container Type	Select the container type to be used to move the inventory from the source zone to the target zone. Typical values are Case and Pallet.
Task Type	Select the Putaway Task Type applicable to this putaway strategy. This field displays the list of existing system directed task types that belong to the 'PUTAWAY' activity group.
Ad hoc Task Types	Displays the list of existing ad hoc task types. You may use  to delete an existing ad hoc task type.
Source Zone	Select the source zone from where the inventory is sourced.
Target Zone	Select the target zone to where the inventory is moved.

Table 4–7 Putaway Strategy Details Window

Field	Description
Container Type	Select the container type to be used to move the inventory from the source zone to the target zone. Typical values are Case and Pallet.
Task Type	Select the Putaway Task Type applicable to this putaway strategy. This field displays the list of existing ad hoc task types that belong to the 'PUTAWAY' activity group.

4.5.2.2 Creating a New Storage Preference for Single SKU from an Existing Storage Preference

To create a new storage preference for single SKU from an existing storage preference:

1. From the tree in the application rules side panel, choose Inventory > Storage Preferences. The Storage Preferences window displays.
2. In the Storage Preferences window, choose the Single-SKU tab. The Single-SKU tab window for Storage Preferences displays.
3. In the Single-SKU tab window, choose the Storage Preference that is to be copied from.
4. Choose . The Storage Preference Details window displays.
5. Enter information in the applicable fields. Refer [Table 4–6](#) for field value descriptions.
6. Choose .

4.5.2.3 Modifying a Storage Preference for Single SKU

To modify a storage preference for single SKU:

1. From the tree in the application rules side panel, choose Inventory > Storage Preferences. The Storage Preferences window displays.
2. In the Storage Preferences window, choose the Single-SKU tab. The Single-SKU tab window for Storage Preferences displays.
3. In the Single-SKU tab window, choose the Storage Preference that is to be modified.
4. Choose . The Storage Preference Details window displays.

5. Enter information in the applicable fields. Refer [Table 4–6](#) for field value descriptions.
6. Choose .

4.5.2.4 Deleting a Storage Preference for Single SKU

To delete a Storage Preferences for single SKU:

1. From the tree in the application rules side panel, choose Inventory > Storage Preferences. The Storage Preferences window displays.
2. In the Storage Preferences window, choose the Single-SKU tab. The Single-SKU tab window for Storage Preferences displays.
3. In the Single-SKU tab window, choose the Storage Preference that is to be deleted.
4. Choose .

4.5.3 Setting Up Storage Preferences for Multi-SKU/Multi-Level Container

The storage preference details of a multi-level case or pallet are specified here. This also applies to multi-level CASE with LPN and multi-level PALLET with LPN.

Use the Storage Preferences for Multi-SKU/Multi-Level Container set-up for:

- [Creating a Storage Preference for Multi-SKU/Multi-Level Container](#)
- [Modifying a Storage Preference for Multi-SKU/Multi-Level Container](#)
- [Deleting a Storage Preference for Multi-SKU/Multi-Level Container](#)

4.5.3.1 Creating a Storage Preference for Multi-SKU/Multi-Level Container

To create a storage preference for multi-SKU/multi-level container:

1. From the tree in the application rules side panel, choose Inventory > Storage Preferences. The Storage Preferences window displays.
2. In the Storage Preferences window, choose the Multi-SKU/Multi-Level Container tab. The Multi-SKU/Multi-Level Container tab window for Storage Preferences displays.

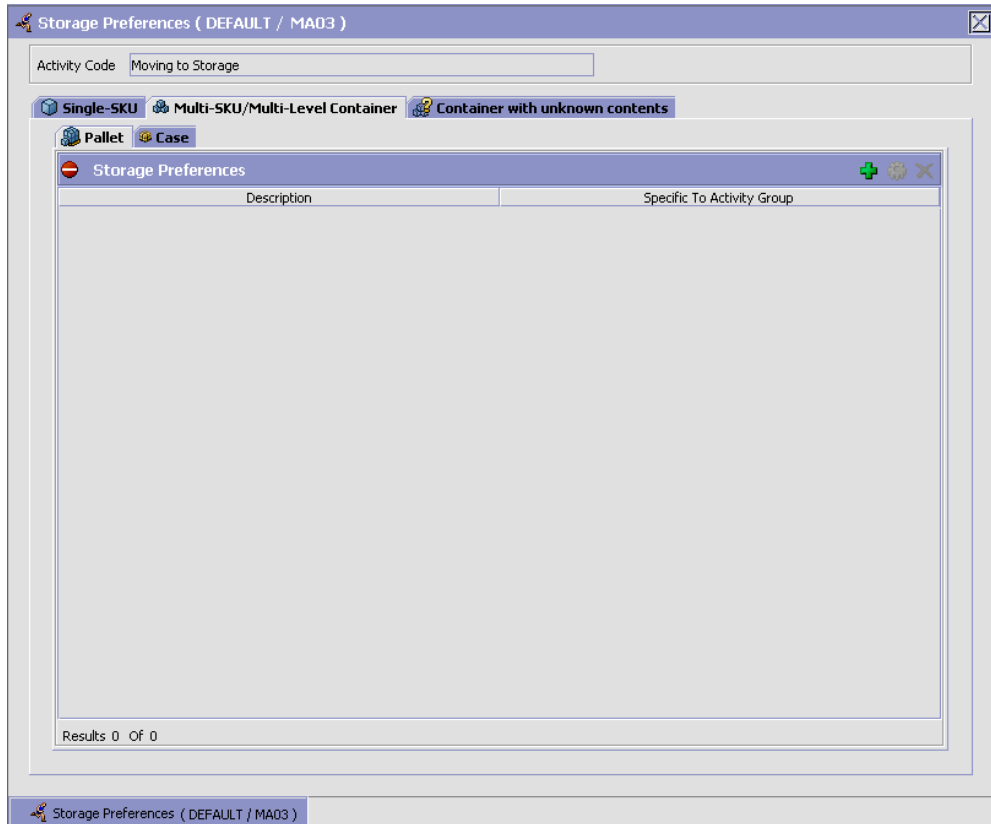



Storage Preferences for multi-level cases or pallets are specified separately:

- [Setting Up Storage Preferences for Multi-Level Pallets](#)
- [Setting Up Storage Preferences for Multi-Level Cases](#)

4.5.3.1.1 Setting Up Storage Preferences for Multi-Level Pallets

To set up Storage Preferences for multi-level pallets:

1. In the Multi-SKU/Multi-Level Container tab of Storage Preferences window, choose the Pallet tab. The Pallet tab window displays.
2. In the Pallet tab window, choose .



3. The Storage Preference Details window displays.
4. Enter information in the applicable fields. Refer [Table 4–8](#) for field value descriptions.
5. Choose .

Storage Preference Details (DEFAULT / MA03) : Multi-SKU/Multi-Level Container : Pallet

Description To View Strategy Click here 

Activity Code Requesting Activity Group

Putaway each SKU separately for Multi-SKU Pallets

 Zone Priorities 

	Priority	Zone	Storage Code
*			

Results 0 Of 0

Storage Preferences (DEFAULT / MA03) Storage Preference Details (DEFAULT / MA03) : Multi-Level Container : Pallet

Table 4–8 Storage Preference Details: Multi-SKU/Multi-Level Container - Pallet Tab

Field	Description
Description	Enter a description for the storage preference.
To View Strategy Click here	<p>Choose  to view or set up Putaway Strategy. For more details on setting up a putaway strategy see Setting Up Putaway Strategy for Multi-SKU/Multi-Level Containers - Pallets.</p> <p>Note: Putaway strategy may be specified for the putaway preferences after the preference is saved.</p>
Activity Code	This indicates the activity code for the storage preference.
Requesting Activity Group	Choose the requesting activity group.
Put away each SKU separately for Multi-SKU Pallets	<p>Select if each SKU on the multi-SKU pallet is evaluated individually.</p> <p>If selected, the putaway preferences for a single SKU are evaluated for the multi-SKU pallet. The Zone Priorities Panel is removed on this selection.</p>
Zone Priorities	
Priority	<p>Enter a number to represent the priority.</p> <p>The priority is used to sequence the order in which the zone priorities are evaluated. For example, all storage code level priorities are to be evaluated first before generic priorities.</p> <p>The priority needs to be a positive integer, greater than zero. This is mandatory.</p>
Zone	<p>Choose the relevant zone to be used as the target zone for putaway.</p> <p>This is a mandatory field.</p>
Storage Code	<p>Choose the storage code for the zone, if applicable.</p> <p>This limits the locations being evaluated to the storage code specified. For example, putaway of hazardous items into a zone are restricted to the locations having the appropriate storage code.</p>



Setting Up Putaway Strategy for Multi-SKU/Multi-Level Containers - Pallets

You can set up putaway strategies to putaway applicable inventory from a source zone to a target zone, based on the strategy specified.

To set up putaway strategy for multi-SKU/multi-level container pallets:

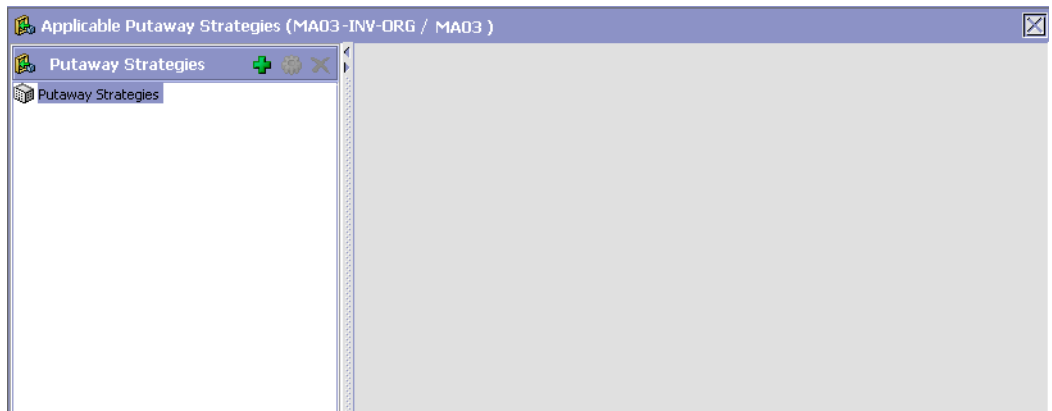
1. In the Storage Preference Details: Multi-SKU/Multi-Level Container: Pallet window, choose .
2. The Applicable Putaway Strategies window is displayed.



3. Choose  in the Putaway Strategies panel. The Putaway Strategy Details window appears in the right panel.
4. Enter information in the applicable fields. See the Putaway Strategy Details Window table for field value descriptions.
5. Choose .

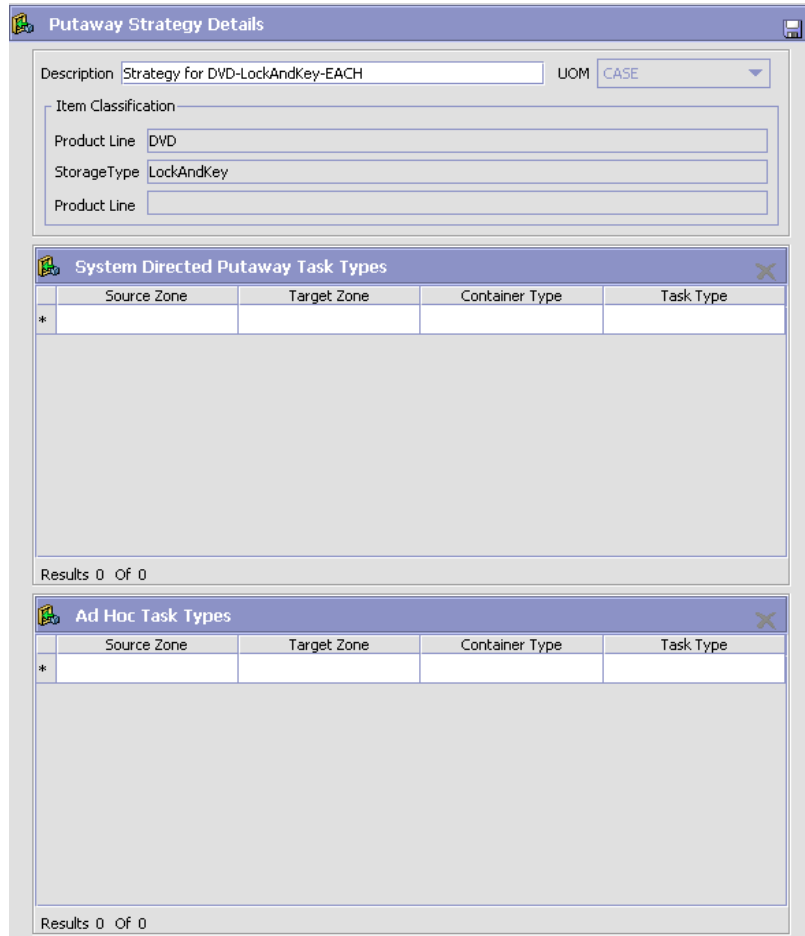

Table 4–9 Putaway Strategy Details Window

Field	Description
Description	Enter a description for the Putaway Strategy.
UOM	Select the UOM for the Putaway Strategy, if applicable. Note: The UOM will be defaulted in instances where it has been specified in the Putaway Preference Details screen.

Table 4–9 Putaway Strategy Details Window



Field	Description
Item Classification	List of putaway item classifications for the Enterprise are displayed. An example, Product Line is shown below.
Product Line	Choose relevant product line item classification for the putaway activity. Choose  . In the Classification Values window, select the applicable product line classification.
System Directed Putaway Task Types	Displays the list of existing system directed putaway task types. You may use  to delete an existing system directed putaway task type.
Source Zone	Select the source zone from where the inventory is sourced.
Target Zone	Select the target zone to where the inventory is moved.
Container Type	Select the container type to be used to move the inventory from the source zone to the target zone. Typical values are Case and Pallet.
Task Type	Select the Putaway Task Type applicable to this putaway strategy. This field displays the list of existing system directed task types that belong to the 'PUTAWAY' activity group.
Ad hoc Task Types	Displays the list of existing ad hoc task types. You may use  to delete an existing ad hoc task type.
Source Zone	Select the source zone from where the inventory is sourced.
Target Zone	Select the target zone to where the inventory is moved.

Table 4–9 Putaway Strategy Details Window



Field	Description
Container Type	Select the container type to be used to move the inventory from the source zone to the target zone. Typical values are Case and Pallet.
Task Type	Select the Putaway Task Type applicable to this putaway strategy. This field displays the list of existing ad hoc task types that belong to the 'PUTAWAY' activity group.

4.5.3.1.2 Setting Up Storage Preferences for Multi-Level Cases

To set up Storage Preferences for multi-level cases:

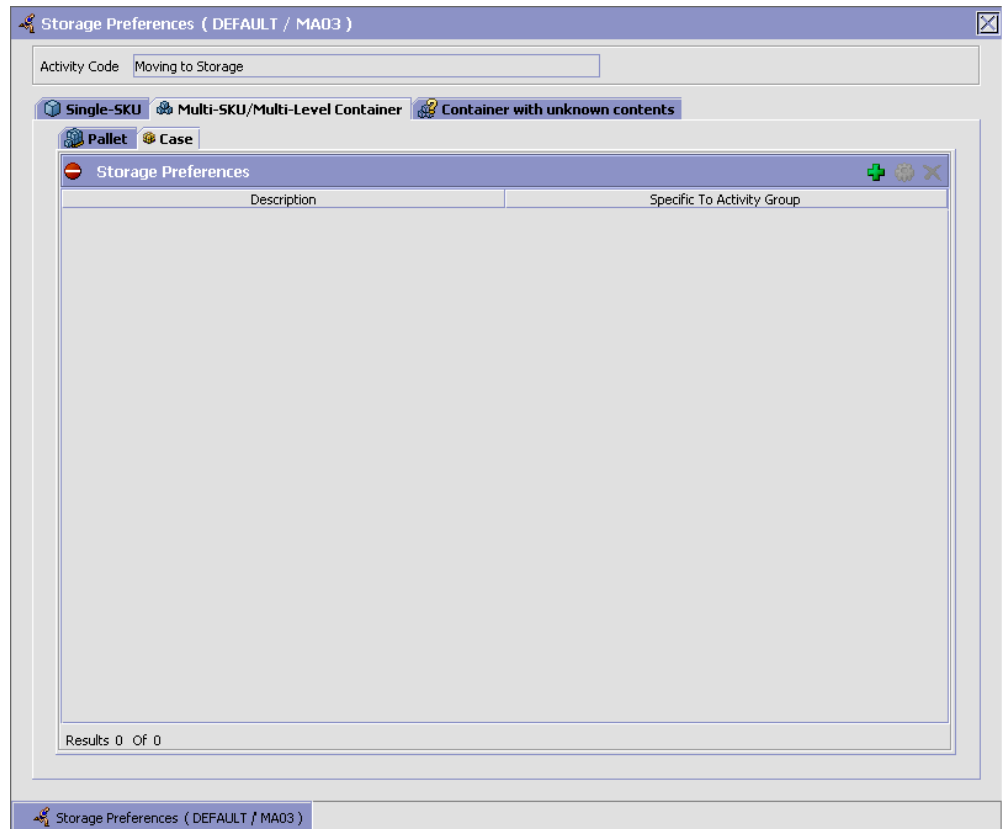
1. In the Multi-SKU/Multi-Level Container tab of Storage Preferences window, choose the Case tab. The Case tab window displays.



2. In the Case tab window, choose .
3. The Storage Preference Details window displays.
4. Enter information in the applicable fields. Refer [Table 4–10](#) for field value descriptions.
5. Choose .

Storage Preference Details (DEFAULT / MA03) : Multi-SKU/Multi-Level Container : Case

Description To View Strategy Click here

Activity Code Requesting Activity Group

Zone Priorities		
Priority	Zone	Storage Code
*		

Results 0 Of 0

Storage Preferences (DEFAULT / MA03) Storage Preference Details (DEFAULT / MA03) : Multi-Level Container : Case

Table 4–10 Storage Preference Details: Multi-SKU/Multi-Level Container - Case Tab

Field	Description
Description	Enter a description for the storage preference.
To View Strategy Click here	<p>Choose to view or set up Putaway Strategy. For more details on setting up a putaway strategy see Setting Up Putaway Strategy for Multi-SKU/Multi-Level Containers - Cases.</p> <p>Note: Putaway strategy may be specified for the putaway preferences after the preference is saved.</p>

Table 4–10 Storage Preference Details: Multi-SKU/Multi-Level Container - Case Tab

Field	Description
Activity Code	This indicates the activity code for the storage preference.
Requesting Activity Group	Choose the requesting activity group.
Zone Priorities	
Priority	Enter a number to represent the priority. The priority is used to sequence the order in which the zone priorities are evaluated. For example, all storage code level priorities are to be evaluated first before generic priorities. The priority needs to be a positive integer, greater than zero. This is mandatory.
Zone	Choose the relevant zone to be used as the target zone for putaway. This is a mandatory field.
Storage Code	Choose the storage code for the zone, if applicable. This limits the locations being evaluated to the storage code specified. For example, putaway of hazardous items into a zone are restricted to the locations having the appropriate storage code.



Setting Up Putaway Strategy for Multi-SKU/Multi-Level Containers - Cases

You can set up putaway strategies to putaway applicable inventory from a source zone to a target zone, based on the strategy specified.

To set up putaway strategy for multi-SKU/multi-level container cases:

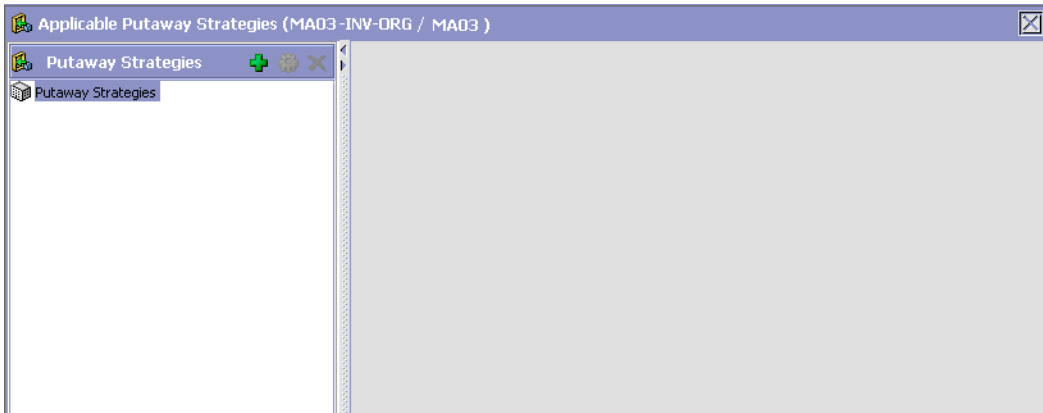
1. In the Storage Preference Details: Multi-SKU/multi-level Containers: Case window, choose .
2. The Applicable Putaway Strategies window is displayed.



3. Choose  in the Putaway Strategies panel. The Putaway Strategy Details window appears in the right panel.
4. Enter information in the applicable fields. See the Putaway Strategy Details Window table for field value descriptions.
5. Choose .

The screenshot shows a software window titled "Putaway Strategy Details". It contains the following elements:

- Description:** A text field containing "Strategy for DVD-LockAndKey-EACH".
- UOM:** A dropdown menu set to "CASE".
- Item Classification:** A section containing:
 - Product Line:** A text field containing "DVD".
 - StorageType:** A text field containing "LockAndKey".
 - Product Line:** An empty text field.
- System Directed Putaway Task Types:** A table with columns "Source Zone", "Target Zone", "Container Type", and "Task Type". It contains one row with an asterisk (*) in the first column and is otherwise empty. Below the table, it says "Results 0 Of 0".
- Ad Hoc Task Types:** A table with the same columns as the one above. It also contains one row with an asterisk (*) in the first column and is otherwise empty. Below the table, it says "Results 0 Of 0".

Table 4–11 Putaway Strategy Details Window

Field	Description
Description	Enter a description for the Putaway Strategy.
UOM	Select the UOM for the Putaway Strategy, if applicable. Note: The UOM will be defaulted in instances where it has been specified in the Putaway Preference Details screen.

Table 4–11 Putaway Strategy Details Window





Field	Description
Item Classification	List of putaway item classifications for the Enterprise are displayed. An example, Product Line is shown below.
Product Line	Choose relevant product line item classification for the putaway activity. Choose  . In the Classification Values window, select the applicable product line classification.
System Directed Putaway Task Types	Displays the list of existing system directed putaway task types. You may use  to delete an existing system directed putaway task type.
Source Zone	Select the source zone from where the inventory is sourced.
Target Zone	Select the target zone to where the inventory is moved.
Container Type	Select the container type to be used to move the inventory from the source zone to the target zone. Typical values are Case and Pallet.
Task Type	Select the Putaway Task Type applicable to this putaway strategy. This field displays the list of existing system directed task types that belong to the 'PUTAWAY' activity group.
Ad hoc Task Types	Displays the list of existing ad hoc task types. You may use  to delete an existing ad hoc task type.
Source Zone	Select the source zone from where the inventory is sourced.
Target Zone	Select the target zone to where the inventory is moved.

Table 4–11 Putaway Strategy Details Window

Field	Description
Container Type	Select the container type to be used to move the inventory from the source zone to the target zone. Typical values are Case and Pallet.
Task Type	Select the Putaway Task Type applicable to this putaway strategy. This field displays the list of existing ad hoc task types that belong to the 'PUTAWAY' activity group.

4.5.3.2 Modifying a Storage Preference for Multi-SKU/Multi-Level Container

To modify a storage preference for multi-SKU/multi-level container:

1. From the tree in the application rules side panel, choose Inventory > Storage Preferences. The Storage Preferences window displays.
2. In the Storage Preferences window, choose the Multi-SKU/Multi-Level Container tab. The Multi-SKU/Multi-Level Container tab window for Storage Preferences displays.
3. In the Multi-SKU/Multi-Level Container tab window (Pallet or Case tab), choose the Storage Preference that is to be modified.
4. Choose . The Storage Preference Details window displays.
5. Enter information in the applicable fields. For more information about modifying the fields, see [Section 4.5.3.1.1, "Setting Up Storage Preferences for Multi-Level Pallets"](#) on page 142 and [Section 4.5.3.1.2, "Setting Up Storage Preferences for Multi-Level Cases"](#) on page 148.
6. Choose .

4.5.3.3 Deleting a Storage Preference for Multi-SKU/Multi-Level Container

To delete an storage preference for multi-SKU/multi-level container:

1. From the tree in the application rules side panel, choose Inventory > Storage Preferences. The Storage Preferences window displays.

2. In the Storage Preferences window, choose the Multi-SKU/Multi-Level Container tab. The Multi-SKU/Multi-Level Container tab window for Storage Preferences displays.
3. In the Multi-SKU/Multi-Level Container tab window (Pallet or Case tab), choose the Storage Preference that is to be deleted.
4. Choose .

4.5.4 Setting Up Storage Preferences for Container with Unknown Contents

The storage preference details of a case or pallet with unknown contents are specified here.

Use the Storage Preferences for Container with Unknown Contents set-up for:

- [Creating a Storage Preference for Container with Unknown Contents](#)
- [Modifying a Storage Preference for Container with Unknown Contents](#)
- [Deleting a Storage Preference for Container with Unknown Contents](#)

4.5.4.1 Creating a Storage Preference for Container with Unknown Contents

To create a storage preference for container with unknown contents:

1. From the tree in the application rules side panel, choose Inventory > Storage Preferences. The Storage Preferences window displays.
2. In the Storage Preferences window, choose the Container with Unknown Contents tab. The Container with Unknown Contents tab window for Storage Preferences displays.

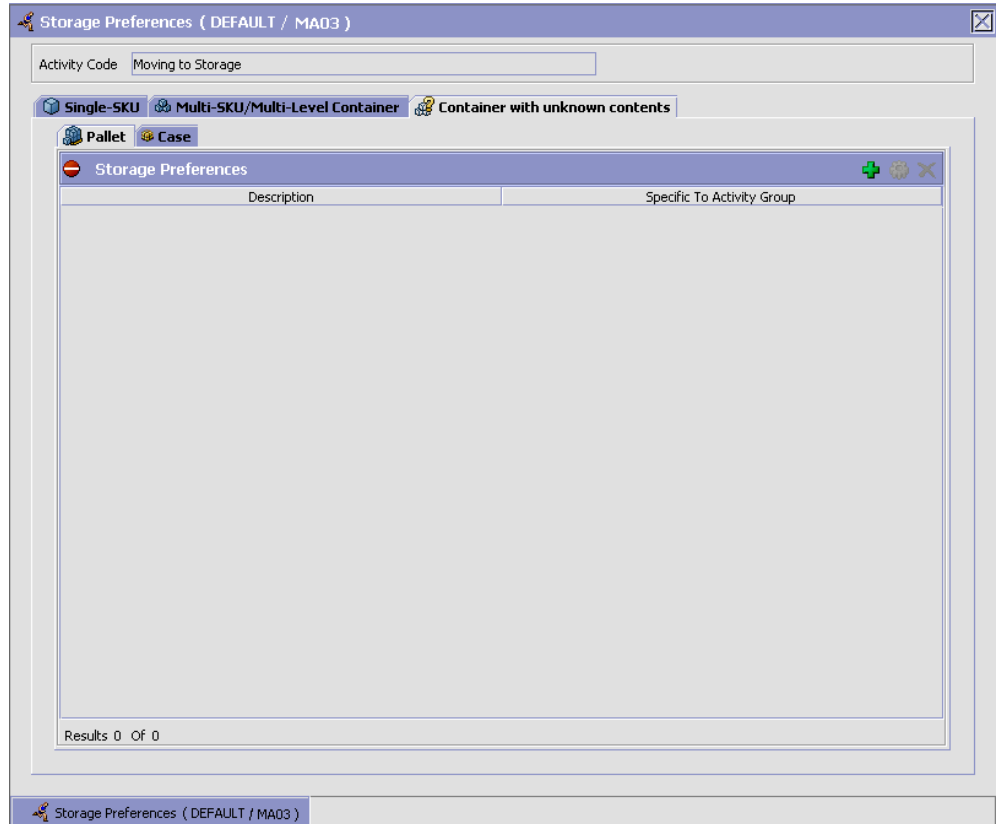



Storage Preferences for cases or pallets are specified separately:

- [Setting Up Storage Preferences for Container with Unknown Contents - Pallets](#)
- [Setting Up Storage Preferences for Container with Unknown Contents - Cases](#)

4.5.4.1.1 Setting Up Storage Preferences for Container with Unknown Contents - Pallets

To set up storage preferences for container with unknown contents - pallets:

Defining Storage Preferences

1. In the Container with Unknown Contents tab of Storage Preferences window, choose the Pallet tab. The Pallet tab window displays.
2. In the Pallet tab window, choose .
3. The Storage Preference Details window displays.
4. Enter information in the applicable fields. Refer [Table 4–12](#) for field value descriptions.
5. Choose .

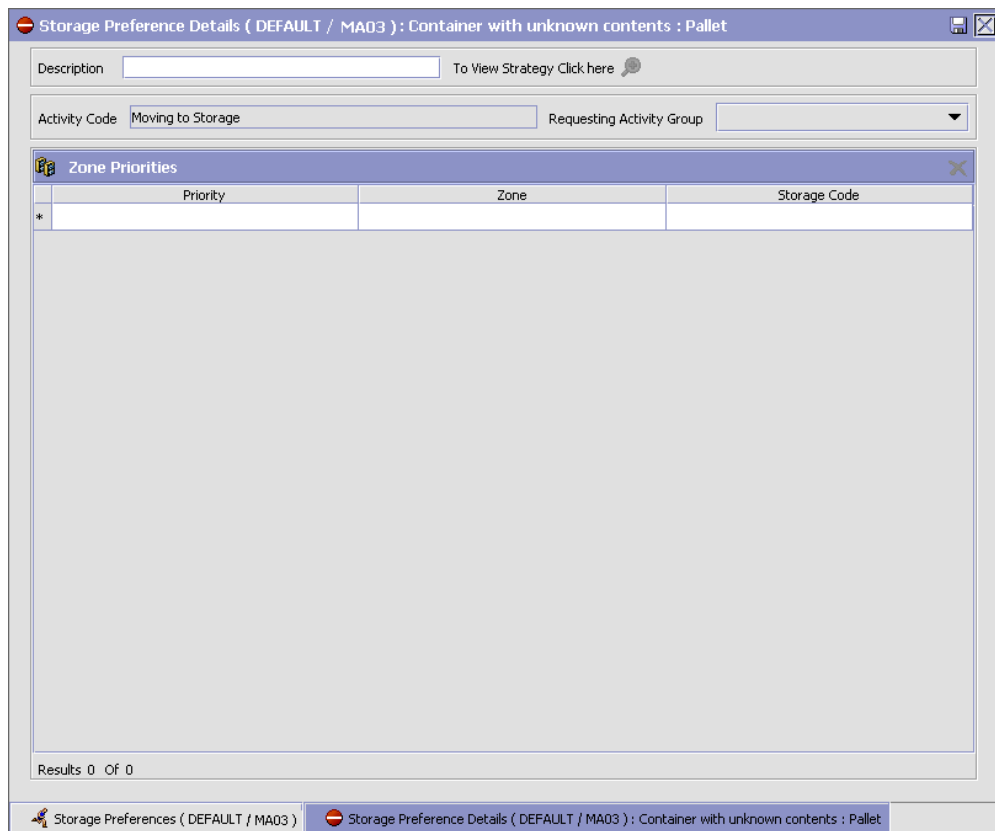



Table 4–12 Storage Preference Details: Container with Unknown Contents - Pallet Tab

Field	Description
Description	Enter a description for the storage preference.
To View Strategy Click here	<p>Choose  to view or set up Putaway Strategy. For more details on setting up a putaway strategy see Setting Up Putaway Strategy for Containers with Unknown Contents - Pallets.</p> <p>Note: Putaway strategy may be specified for the putaway preferences after the preference is saved.</p>
Activity Code	This indicates the activity code for the storage preference.
Requesting Activity Group	Choose the requesting activity group.
Zone Priorities	
Priority	<p>Enter a number to represent the priority.</p> <p>The priority is used to sequence the order in which the zone priorities are evaluated. For example, all storage code level priorities are to be evaluated first before generic priorities.</p> <p>The priority needs to be a positive integer, greater than zero. This is mandatory.</p>
Zone	<p>Choose the relevant zone to be used as the target zone for putaway.</p> <p>This is a mandatory field.</p>
Storage Code	<p>Choose the storage code for the zone, if applicable.</p> <p>This limits the locations being evaluated to the storage code specified. For example, putaway of hazardous items into a zone are restricted to the locations having the appropriate storage code.</p>



Setting Up Putaway Strategy for Containers with Unknown Contents - Pallets

You can set up putaway strategies to putaway applicable inventory from a source zone to a target zone, based on the strategy specified.

To set up putaway strategy for container with unknown content - pallets:

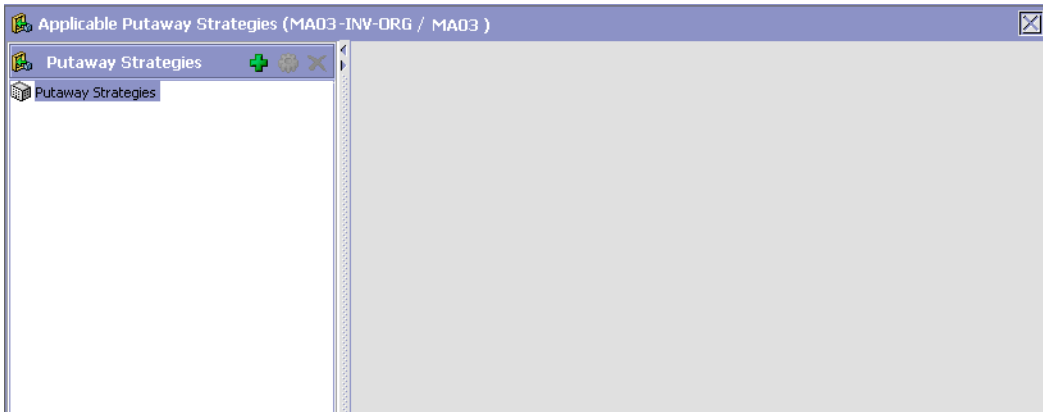
1. In the Storage Preference Details: Container with unknown contents - Pallet window, choose .
2. The Applicable Putaway Strategies window is displayed.



3. Choose  in the Putaway Strategies panel. The Putaway Strategy Details window appears in the right panel.
4. Enter information in the applicable fields. See the Putaway Strategy Details Window table for field value descriptions.
5. Choose .

The screenshot shows a software window titled "Putaway Strategy Details". It contains the following elements:

- Description:** A text field containing "Strategy for DVD-LockAndKey-EACH".
- UOM:** A dropdown menu currently set to "CASE".
- Item Classification:** A section containing three text fields:
 - Product Line: "DVD"
 - StorageType: "LockAndKey"
 - Product Line: (empty)
- System Directed Putaway Task Types:** A table with columns "Source Zone", "Target Zone", "Container Type", and "Task Type". It contains one row with an asterisk (*) in the first column and is otherwise empty.
- Ad Hoc Task Types:** A table with the same columns as the System Directed table. It also contains one row with an asterisk (*) in the first column and is otherwise empty.

Table 4–13 Putaway Strategy Details Window

Field	Description
Description	Enter a description for the Putaway Strategy.
UOM	Select the UOM for the Putaway Strategy, if applicable. Note: The UOM will be defaulted in instances where it has been specified in the Putaway Preference Details screen.

Table 4–13 Putaway Strategy Details Window



Field	Description
Item Classification	List of putaway item classifications for the Enterprise are displayed. An example, Product Line is shown below.
Product Line	Choose relevant product line item classification for the putaway activity. Choose  . In the Classification Values window, select the applicable product line classification.
System Directed Putaway Task Types	Displays the list of existing system directed putaway task types. You may use  to delete an existing system directed putaway task type.
Source Zone	Select the source zone from where the inventory is sourced.
Target Zone	Select the target zone to where the inventory is moved.
Container Type	Select the container type to be used to move the inventory from the source zone to the target zone. Typical values are Case and Pallet.
Task Type	Select the Putaway Task Type applicable to this putaway strategy. This field displays the list of existing system directed task types that belong to the 'PUTAWAY' activity group.
Ad hoc Task Types	Displays the list of existing ad hoc task types. You may use  to delete an existing ad hoc task type.
Source Zone	Select the source zone from where the inventory is sourced.
Target Zone	Select the target zone to where the inventory is moved.

Table 4–13 Putaway Strategy Details Window



Field	Description
Container Type	Select the container type to be used to move the inventory from the source zone to the target zone. Typical values are Case and Pallet.
Task Type	Select the Putaway Task Type applicable to this putaway strategy. This field displays the list of existing ad hoc task types that belong to the 'PUTAWAY' activity group.

4.5.4.1.2 Setting Up Storage Preferences for Container with Unknown Contents - Cases

To set up storage preferences for container with unknown contents - cases:

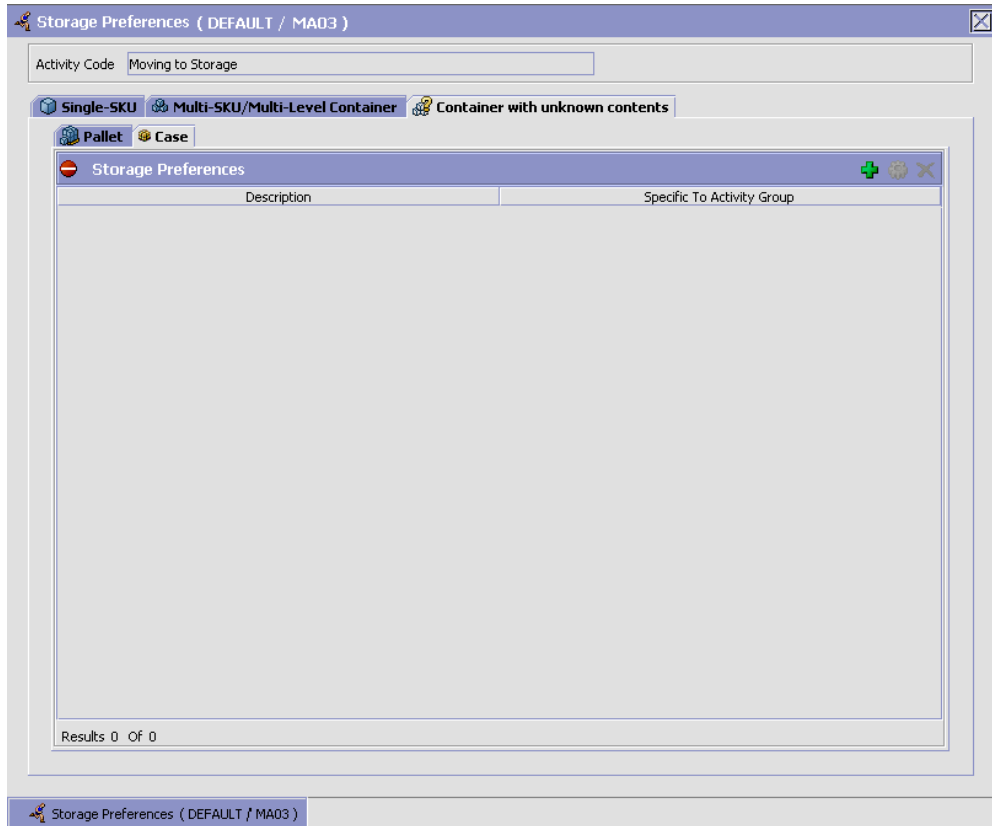
1. In the Container with Unknown Contents tab of Storage Preferences window, choose the Case tab. The Case tab window displays.



2. In the Case tab window, choose .
3. The Storage Preference Details window displays.
4. Enter information in the applicable fields. Refer [Table 4–14](#) for field value descriptions.
5. Choose .

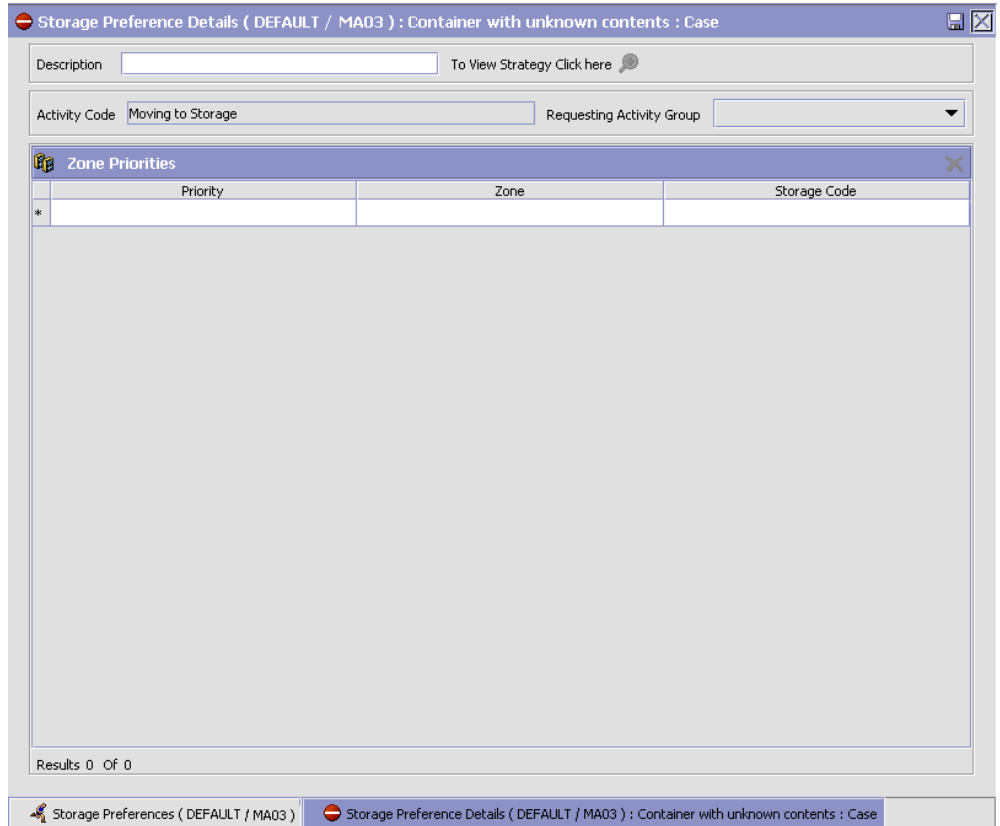

Table 4–14 Storage Preference Details : Container with Unknown Contents - Case Tab

Field	Description
Description	Enter a description for the storage preference.
To View Strategy Click here	Choose  to view or set up Putaway Strategy. For more details on setting up a putaway strategy see Setting Up Putaway Strategy for Containers with Unknown Contents - Cases . Note: Putaway strategy may be specified for the putaway preferences after the preference is saved.

Table 4–14 Storage Preference Details : Container with Unknown Contents - Case Tab

Field	Description
Activity Code	This indicates the activity code for the storage preference.
Requesting Activity Group	Choose the requesting activity group.
Zone Priorities	
Priority	Enter a number to represent the priority. The priority is used to sequence the order in which the zone priorities are evaluated. For example, all storage code level priorities are to be evaluated first before generic priorities. The priority needs to be a positive integer, greater than zero. This is mandatory.
Zone	Choose the relevant zone to be used as the target zone for putaway. This is a mandatory field.
Storage Code	Choose the storage code for the zone, if applicable. This limits the locations being evaluated to the storage code specified. For example, putaway of hazardous items into a zone are restricted to the locations having the appropriate storage code.



Setting Up Putaway Strategy for Containers with Unknown Contents - Cases

You can set up putaway strategies to putaway applicable inventory from a source zone to a target zone, based on the strategy specified.

To set up putaway strategy for container with unknown content - cases:

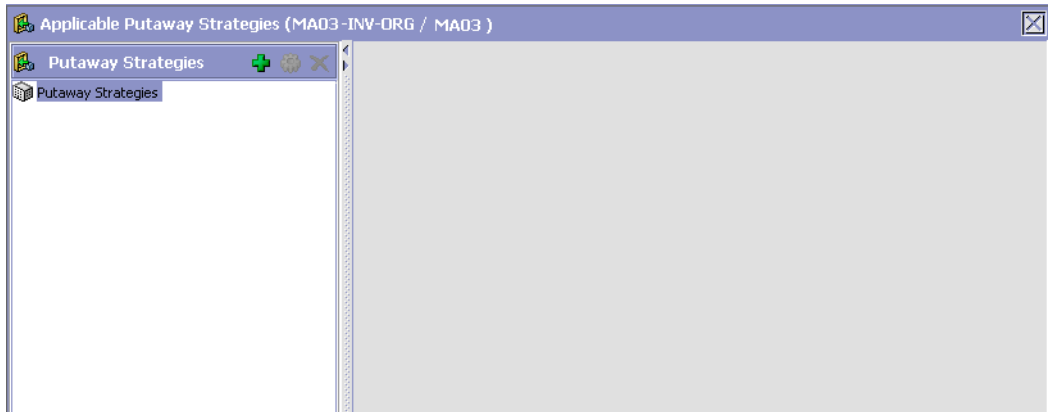
1. In the Storage Preference Details: Container with unknown contents: Case window, choose .
2. The Applicable Putaway Strategies window is displayed.



3. Choose  in the Putaway Strategies panel. The Putaway Strategy Details window appears in the right panel.
4. Enter information in the applicable fields. See the Putaway Strategy Details Window table for field value descriptions.
5. Choose .

Putaway Strategy Details

Description: Strategy for DVD-LockAndKey-EACH UOM: CASE

Item Classification

Product Line: DVD

StorageType: LockAndKey

Product Line:

System Directed Putaway Task Types

	Source Zone	Target Zone	Container Type	Task Type
*				

Results: 0 Of 0

Ad Hoc Task Types

	Source Zone	Target Zone	Container Type	Task Type
*				

Results: 0 Of 0

Table 4–15 Putaway Strategy Details Window

Field	Description
Description	Enter a description for the Putaway Strategy.
UOM	Select the UOM for the Putaway Strategy, if applicable. Note: The UOM will be defaulted in instances where it has been specified in the Putaway Preference Details screen.

Table 4–15 Putaway Strategy Details Window



Field	Description
Item Classification	List of putaway item classifications for the Enterprise are displayed. An example, Product Line is shown below.
Product Line	Choose relevant product line item classification for the putaway activity. Choose  . In the Classification Values window, select the applicable product line classification.
System Directed Putaway Task Types	Displays the list of existing system directed putaway task types. You may use  to delete an existing system directed putaway task type.
Source Zone	Select the source zone from where the inventory is sourced.
Target Zone	Select the target zone to where the inventory is moved.
Container Type	Select the container type to be used to move the inventory from the source zone to the target zone. Typical values are Case and Pallet.
Task Type	Select the Putaway Task Type applicable to this putaway strategy. This field displays the list of existing system directed task types that belong to the 'PUTAWAY' activity group.
Ad hoc Task Types	Displays the list of existing ad hoc task types. You may use  to delete an existing ad hoc task type.
Source Zone	Select the source zone from where the inventory is sourced.
Target Zone	Select the target zone to where the inventory is moved.



Table 4–15 Putaway Strategy Details Window

Field	Description
Container Type	Select the container type to be used to move the inventory from the source zone to the target zone. Typical values are Case and Pallet.
Task Type	Select the Putaway Task Type applicable to this putaway strategy. This field displays the list of existing ad hoc task types that belong to the 'PUTAWAY' activity group.

4.5.4.2 Modifying a Storage Preference for Container with Unknown Contents

Once an Storage Preference for Container with Unknown Contents has been created, it can be modified.

To modify an storage preference for container with unknown contents:

1. From the tree in the application rules side panel, choose Inventory > Storage Preferences. The Storage Preferences window displays.
2. In the Storage Preferences window, choose the Container with Unknown Contents tab. The Container with Unknown Contents tab window for Storage Preferences displays.
3. In the Container with Unknown Contents tab window (Pallet or Case tab), choose the Storage Preference that is to be modified.
4. Choose . The Storage Preference Details window displays.
5. Enter information in the applicable fields. For more information about modifying the fields, see [Section 4.5.4.1.1, "Setting Up Storage Preferences for Container with Unknown Contents - Pallets"](#) on page 157 and [Section 4.5.4.1.2, "Setting Up Storage Preferences for Container with Unknown Contents - Cases"](#) on page 163.
6. Choose .

4.5.4.3 Deleting a Storage Preference for Container with Unknown Contents

To delete a storage preference for container with unknown contents:

1. From the tree in the application rules side panel, choose Inventory > Storage Preferences. The Storage Preferences window displays.

2. In the Storage Preferences window, choose the Container with Unknown Contents tab. The Container with Unknown Contents tab window for Storage Preferences displays.
3. In the Container with Unknown Contents tab window (Pallet or Case tab), choose the Storage Preference that is to be deleted.
4. Choose .

4.6 Defining a Replenishment Strategy

When a product is removed from a location in the forward pick zones of the warehouse, the inventory in that location needs to be replenished from bulk zones. In Selling and Fulfillment Foundation, demand-based replenishment is initiated during the wave release process.

If inventory is not available in pick zones that are defined in the PLA rule, the system attempts to replenish these locations from bulk zones only if the locations are dedicated or dynamically slotted and replenishment strategy is defined to replenish these locations.

The pick tasks are suggested as and when the replenishment tasks are completed.

A replenishment strategy can be created to replenish one or more zones. The strategy also specifies the zones from which inventory is retrieved to fulfill the replenishment requests.

Example

A location L1 belonging to zone Z1 is dedicated to item I1. The item has pallet and case as its alternate UOMs. A pallet is made up of 20 cases. Each case is made up of 10 units. A replenishment request is made for 223 units.

In this example, you can use the Sterling Warehouse Management System to define a replenishment strategy for zone Z1 by specifying a case zone to be used for Case UOM and a pallet zone for Pallet UOM. The system first attempts to fulfill the entire demand from the pallet zone. If the system cannot satisfy the entire demand, it searches for inventory in the case zone. This concept is known as downgrading. For more information about downgrading, see the *Sterling Warehouse Management System: Concepts Guide*.

Note: Within replenishment strategies, you can configure only two sets of UOMs for each set of replenishment zones. You can also define two sets of retrieval zones for each set of UOM.

4.7 Defining Replenishment Algorithm

The replenishment algorithm of the Sterling Warehouse Management System is configured to replenish locations in the forward pick zones from bulk zones whenever the inventory is removed.

If bulk zones cannot satisfy the entire demand, you can configure the algorithm to search for inventory from inbound shipments that are in a particular state. The Sterling Warehouse Management System searches for inventory only from inbound shipments that are in the specified status and creates activity demands for these shipments. The activity demands are satisfied by performing putaway tasks after receiving inbound shipments.

You can define split constraints in replenishment PLA to specify whether a license plate can be split during the replenishment process. For more information about split constraints, see the *Sterling Warehouse Management System: Concepts Guide*.

You can configure the replenishment algorithm to use any one of the following optimizations:

- Pick to clean—Fulfill the demand by emptying as many LPNs or locations as possible for optimal usage of space in a zone. When the system suggests a location to replenish, it mandates to pick inventory from that location until the location is empty.
- Least number of trips—Fulfill the demand by making least number of trips when retrieving inventory. If the system determines multiple least number of trips, it follows the PickToClean optimization within the LeastNumberOfTrips optimization.

4.7.1 Rounding Up Inventory

Rounding up inventory in the Sterling Warehouse Management System is defined as picking up more inventory than the demand quantity when replenishing.

- If inventory is available as loose SKU, the Sterling Warehouse Management System rounds up the inventory to pick if you configure to round up inventory to higher UOMs in the replenishment strategy. If you configure multiple UOMs, the system rounds up the demand quantity in multiples of the lowest UOM.
- If inventory is available in LPNs, and if the LPN type matches with the LPN type of the round up UOM, the system rounds up the inventory to pick to the LPN quantity.

4.7.2 Replenishing By Using the Least Number of Trips Process

The Sterling Warehouse Management System chooses locations to optimize the number of trips you make when retrieving inventory. Minimizing the trips reduces the number of pick locations or LPN locations to visit.

4.7.2.1 Examples With Round Up

Consider a zone Z1 with locations L1, L2, L3, and L4 that stores inventory only in case UOM. An alternate case UOM is configured as 1 Case = 4 Eaches. During replenishment, the system rounds up the demand quantity to case UOM.

Inventory Picture

The inventory picture at locations L1, L2, L3, and L4 is as follows:

- L1—3 SKUs (corrupted location)
- L2—2 cases (8 units)
- L3—2 cases (8 units)
- L4—1 SKU (corrupted location)

The following examples further explain the demand-based replenishment for the least number of trips process.

Example 1

When the demand is for 9 units, the system chooses the following locations:

- L2—2 Cases

- L4—1 SKU

In this case, the system does not round up the demand quantity as there is a location that can supply the exact quantity.

Example 2

When the demand is for 10-11 units, the system chooses the following locations:

- L2—2 Cases
- L1—3 SKU

In this case, the system rounds up the demand quantity to the nearest case UOM in location L1. Since location L1 has quantity less than 1 case, it is cleaned up.

Example 3

When the demand is between 3-4 cases, the Sterling Warehouse Management System chooses the following locations:

- L2—2 Cases
- L3—1-2 Cases

In this case, the system rounds up the demand quantity to minimize the number of trips made to the pick locations.

4.7.2.2 Examples Without Round Up

Consider a zone Z1 with locations L1, L2, L3, and L4 that stores inventory only in case UOM. An alternate case UOM is configured as 1 Case = 4 Eaches. During replenishment, the system does not round up the demand quantity.

Inventory Picture

The inventory picture at locations L1, L2, L3, and L4 is as follows:

- L1—3 SKUs (corrupted location)
- L2—2 cases (8 units)
- L3—2 cases (8 units)
- L4—1 SKU (corrupted location)

The following examples further explain the demand-based replenishment for the least number of trips process.

Example 1

When the demand is for 9 units, the system chooses the following locations:

- L2—2 Cases
- L4—1 SKU

Example 2

When the demand is for 10 units, the system chooses the following locations:

- L2—2 Cases
- L4—1 SKU

The system can allocate only 9 units. Since the zone stores inventory in multiples of Case UOM, the system allocates inventory only in terms of cases. After allocating 2 cases from location L2, the system chooses the corrupted location L4 and empties it.

Location L1 has quantity less than a case (3 SKU), so only full case (3 SKU) can be allocated from this location. However, this exceeds the demand. Since round up is not configured, the system cannot allocate quantities more than the demand. Similarly, the system can allocate one full case (4 units) from location L3. However, this exceeds the demand.

Example 3

When the demand is for 3 cases, the system chooses the following locations:

- L2—2 Cases
- L3—1 Cases

In this case, the Sterling Warehouse Management System rounds up the demand quantity to minimize the number of trips made to the pick locations.

4.7.3 Replenishing By Using the Pick to Clean Process

The Sterling Warehouse Management System chooses pick locations so that the maximum numbers of LPNs or pick locations can be emptied.

4.7.3.1 Examples With Round Up

Consider a zone Z1 with locations L1, L2, L3, and L4 that stores inventory only in case UOM. An alternate case UOM is configured as 1 Case = 4 Eaches. During replenishment, the system rounds up the demand quantity to case UOM.

Inventory Picture

The inventory picture at locations L1, L2, L3, and L4 is as follows:

- L1—3 SKUs (corrupted location)
- L2—2 cases (8 units)
- L3—2 cases (8 units)
- L4—1 SKU (corrupted location)

The following examples further explain the demand-based replenishment for the least number of trips process.

Example 1

When the demand is for 9 units, the Sterling Warehouse Management System chooses the following locations:

- L4: 1 SKU
- L1: 3 SKU
- L2: 2 Cases

Note: The Sterling Warehouse Management System cleans up locations L4 and L1. For the remaining 5 units, the Sterling Warehouse Management System chooses location L2 and rounds up the demand quantity to 2 cases.

Example 2

When the demand is for 10-11 units, the Sterling Warehouse Management System chooses the following locations:

- L2: 2 Cases
- L1: 3 SKU
- L4: 1 SKU

Example 3

When the demand is between 3 and 4 cases, the Sterling Warehouse Management System chooses the following locations:

- L1: 3 SKU
- L4: 1 SKU
- L2: 2 Cases
- L3: 1 Cases

4.7.3.2 Examples Without Round Up

Consider a zone Z1 with locations L1, L2, L3, and L4 that stores inventory only in case UOM. An alternate case UOM is configured as 1 Case = 4 Eaches. During replenishment, the system does not round up the demand quantity.

Inventory Picture

The inventory picture at locations L1, L2, L3, and L4 is as follows:

- L1—3 SKUs (corrupted location)
- L2—2 cases (8 units)
- L3—2 cases (8 units)
- L4—1 SKU (corrupted location)

The following examples further explain the demand-based replenishment for the least number of trips process.

Example 1

When the demand is between 9-10 units, the system chooses the following locations:

- L4: 1 SKU
- L1: 3 SKU

- L2: 1 Case

The Sterling Warehouse Management System can allocate only 8 units. To clean up more locations, the system selects the locations in the ascending order of quantity. After selecting locations L4 and L1, the remaining demand is for 5-6 units. Since round up is not configured, the system can allocate only one case either from location L2 or L3. Also, the split constraints do not allow to allocate 5-6 units from location L2 or L3.



Example 2

When the demand is between 3 and 4 cases, the system chooses the following locations:

- L4: 1 SKU
- L1: 3 SKU
- L2: 2 Cases

4.7.4 Creating a Replenishment Strategy

To create a replenishment strategy:

1. From the tree in the application rules side panel, choose Inventory > Replenishment Strategy. The Replenishment window displays in the work area.
2. From the All Strategies tree, choose . The Replenishment Strategy Details window displays in the right frame of the Replenishment window.
3. Enter information in the applicable fields. Refer to [Table 4–16](#) for field value descriptions.
4. Choose .

Note: If you configure the replenishment strategies for the zones that have split constraints defined at the PLA rule level or zone level, the Sterling Warehouse Management System does not perform demand-based replenishment. The existing pend in quantities are also not considered for allocation. This is to avoid violating a split constraint as the exact information about the incoming inventory is not available. You can replenish such zones using the location monitoring rules.

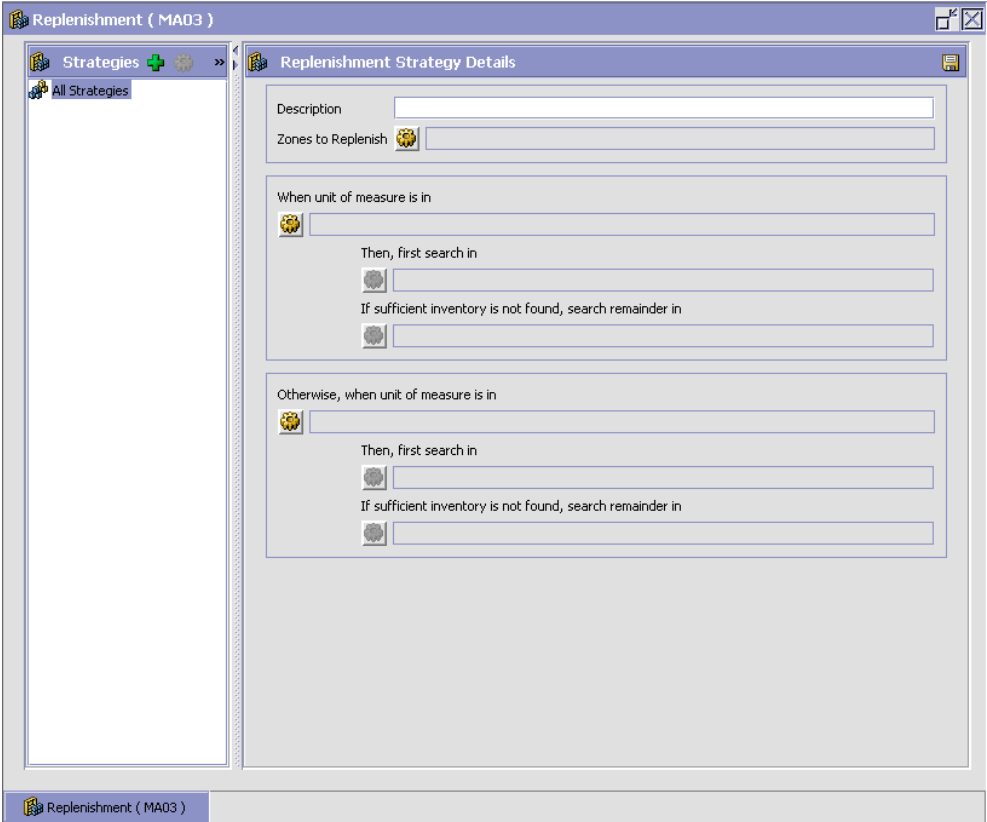

Table 4–16 Replenishment Strategy Details Window







Field	Description
Description	Enter a description of the replenishment strategy.
Zones to Replenish	<p>You must specify one or more zones that this replenishment rule applies to.</p> <p>Choose . The List of Values pop-up window displays. Select the blank line and choose a zone that you want to apply this replenishment strategy to from the drop-down menu. When you have finished adding zones, choose OK.</p>
When unit of measure is in	<p>You must specify the unit(s) of measure that you want to be replenished in the specified zones. For example, if there is a zone in which you perform loose picking for the unit of measure of EACH for a particular item, you would want to ensure that the EACH unit of measure is replenished.</p> <p>Choose . The List of Values pop-up window displays. Choose the unit of measure you want to replenish for the specified zones from the drop-down menu. When you have finished adding units of measure, choose OK.</p>
Then, first search in	<p>You must specify the retrieval algorithm to be used to retrieve inventory for replenishment. This algorithm is run first and identifies the optimal location to retrieve inventory from.</p> <p>Choose . The Replenish From window displays. Refer to Replenish From Pop-Up Window for a description of this window and field value descriptions.</p>
If sufficient inventory is not found, search remainder in	<p>If there was not enough inventory found for replenishment using the first algorithm, you can define another algorithm to be used to locate the remaining inventory.</p> <p>Choose . The Replenish From window displays. Refer to Replenish From Pop-Up Window for a description of this window and field value descriptions.</p>

Table 4–16 Replenishment Strategy Details Window

Field	Description
Otherwise, when unit of measure is in	<p>If there are other units of measure in need of replenishing in the specified zones for which you want to use different retrieval algorithms, you can specify them here.</p> <p>Choose . The List of Values pop-up window displays. Choose the unit of measure you want to replenish for the specified zones from the drop-down menu. When you have finished adding units of measure, choose OK.</p>
Then, first search in	<p>You must specify the retrieval algorithm to be used to retrieve inventory for replenishment. This algorithm is run first and identifies the optimal location to retrieve inventory from.</p> <p>Choose . The Replenish From window displays. Refer to Replenish From Pop-Up Window for a description of this window and field value descriptions.</p>
If sufficient inventory is not found, search remainder in	<p>If there was not enough inventory found for replenishment using the first algorithm, you can define another algorithm to be used to locate the remaining inventory.</p> <p>Choose . The Replenish From window displays. Refer to Replenish From Pop-Up Window for a description of this window and field value descriptions.</p>

The first step is to determine the quantity to replenish, based on the demand for an item. The Sterling WMS, replenishment strategy allows you to optimize the replenishment based on the item's unit of measure, and the capacity of the location to be replenished. The location to replenish from is determined based on the demand quantity using the strategy specified.

The next step is to determine the quantity to replenish to the location. Using round off, round up the demand quantity to the higher unit of measure specified in the strategy. Also, consider the available capacity of the destination location and the quantity available in the location to replenish.

The above steps optimize the quantity to replenish, allowing for reduced replenishment on subsequent waves.

The number of locations to replenish from are not increased due to excess capacity available at the location to replenish. This is illustrated through the following example:

Let us consider that A1 is a dedicated location with maximum capacity 100, where the current quantity is 5. The demand is 20. A CASE contains 25, while a PALLET contains 50 (2 cases). The round-up level chosen are CASE and PALLET, and the respective zones are configured not to split the appropriate UOM. The inventory in location L1 is 50, location L2 is 100, and Location L3 is 25.

In this context, Selling and Fulfillment Foundation does not select an additional location to satisfy the capacity at the location being replenished because of the following constraints:

- Consider that L1, L2, L3 are in the CASE zone. If location L1 is chosen to replenish from, 50 is replenished. If location L2 is chosen to replenish from, 75 is replenished and if location L3 is chosen, 25 is replenished.
- Now consider that Location L1 and L2 are in PALLET zone. If L1 is chosen to replenish from, 50 is replenished. If L2 is chosen, 100 is replenished overflowing the location.

Replenish From Pop-Up Window

The Replenish From pop-up window is used to define the location picking algorithm. This algorithm is then used to retrieve the applicable inventory for the specified units of measure and replenish inventory in the zones specified in the replenishment strategy.

Replenish From

Description

Select locations using following algorithm

Select locations having inventory from these zones 

Optimize retrieval using Pick to clean Least number of trips Pick Sequence

Splitting is allowed for Pallets and Cases Pallets but not Cases Neither Pallets nor Cases

Round up quantity in a trip when possible to

Case Each
 Half Pallet Inner Pack
 Pallet

When inventory is not found, select inbound shipments that are 

Task Creation

Task Type 

Table 4–17 Replenish From Pop-Up Window



Field	Description
Description	Enter a description of the algorithm.
Select locations using following algorithm	
Select locations having inventory from these zones	<p>You can specify zones to look for inventory. If inventory is available, they can be used to replenish from.</p> <p>Choose . The List of Values pop-up window displays. Select the blank line and choose a zone from the drop-down menu. When you have finished adding zones, choose OK.</p>

Table 4–17 Replenish From Pop-Up Window



Field	Description
Optimize retrieval using	<ul style="list-style-type: none"> • Choose Pick to Clean to fulfill the demand by emptying as many LPNs or locations as possible for optimal usage of space in a zone. • Choose Least Number of Trips to fulfill the demand from the least number of locations to enable users to make least number of trips when retrieving inventory. When there is more than one way to make the same least number of trips, the 'PickToClean' process is followed within the 'LeastNumberOfTrips' process. • Choose Pick Sequence to pick from locations in the order of their pick sequence. The system chooses locations having lower pick sequence numbers over locations having higher pick sequence numbers.
Splitting is allowed for	<p>The system allows the user to break open an LPN for all zones specified in the PLA based on the option specified. If split constraints are defined at the zone and PLA rule levels, the system chooses the most restrictive constraint to ensure that constraints defined are not violated.</p> <p>Choose Pallets and Cases if you want to allow users to break open both pallets and cases.</p> <p>Choose Pallets but not Cases if you want to allow users to break open only pallets.</p> <p>Choose Neither Pallets nor Cases if you do not want to allow users to break open pallets or cases.</p>
Round up quantity in a trip when possible to	<p>Select the unit of measure to round up to when retrieving inventory for replenishment. The round up occurs only in instances when there is sufficient inventory.</p> <p>For more information about rounding up inventory, see Section 4.7.1, "Rounding Up Inventory".</p>

Table 4–17 Replenish From Pop-Up Window

Field	Description
When inventory is not found, select inbound shipments that are	<p>If there is no inventory available in the defined zones, the algorithm can be configured to look for inventory in inbound shipments that are in a defined status. The system only looks for inventory in inbound shipments that are in the status(es) you specify.</p> <p>Choose . The List of Values pop-up window displays. Select the blank line and choose an inbound shipment status from the drop-down menu. When you have finished adding shipment status, choose OK.</p>
Task Creation	
Task Type	<p>Choose the applicable task type.</p> <p>Choose  to create a new task type. For more information about Task Type, see Section 12.3, "Defining Task Types" on page 885.</p>

4.7.5 Modifying a Replenishment Strategy

To modify a replenishment strategy:

1. From the tree in the application rules side panel, choose Inventory > Replenishment Strategy. The Replenishment window displays in the work area.
2. From the All Strategies tree, select the replenishment strategy you want to modify and choose . The Replenishment Strategy Details window displays in the right frame of the Replenishment window.
3. Enter information in the applicable fields. Refer to [Table 4–16](#) for field value descriptions.
4. Choose .

4.7.6 Deleting a Replenishment Strategy

To delete a replenishment strategy:

1. From the tree in the application rules side panel, choose Inventory > Replenishment Strategy. The Replenishment window displays in the work area.
2. From the All Strategies tree, select the replenishment strategy you want to delete and choose .

4.8 Defining Monitoring Rules

Locations in a warehouse need to be monitored for various reasons. For example, a location needs to be replenished based on the demand placed on it and the individual trigger levels for an item dedicated to it.

Location Monitoring Rules are set up to monitor inventory levels at zones for an Enterprise, Product Class, and Item Classification. You can monitor Inventory levels depending on the size of locations and raise alerts based on these rules.

Use Monitoring Rules for:



- [Creating a Monitoring Rule](#)
- [Creating a New Monitoring Rule from an Existing Monitoring Rule](#)
- [Modifying a Monitoring Rule](#)
- [Deleting a Monitoring Rule](#)

4.8.1 Creating a Monitoring Rule

To create a monitoring rule:

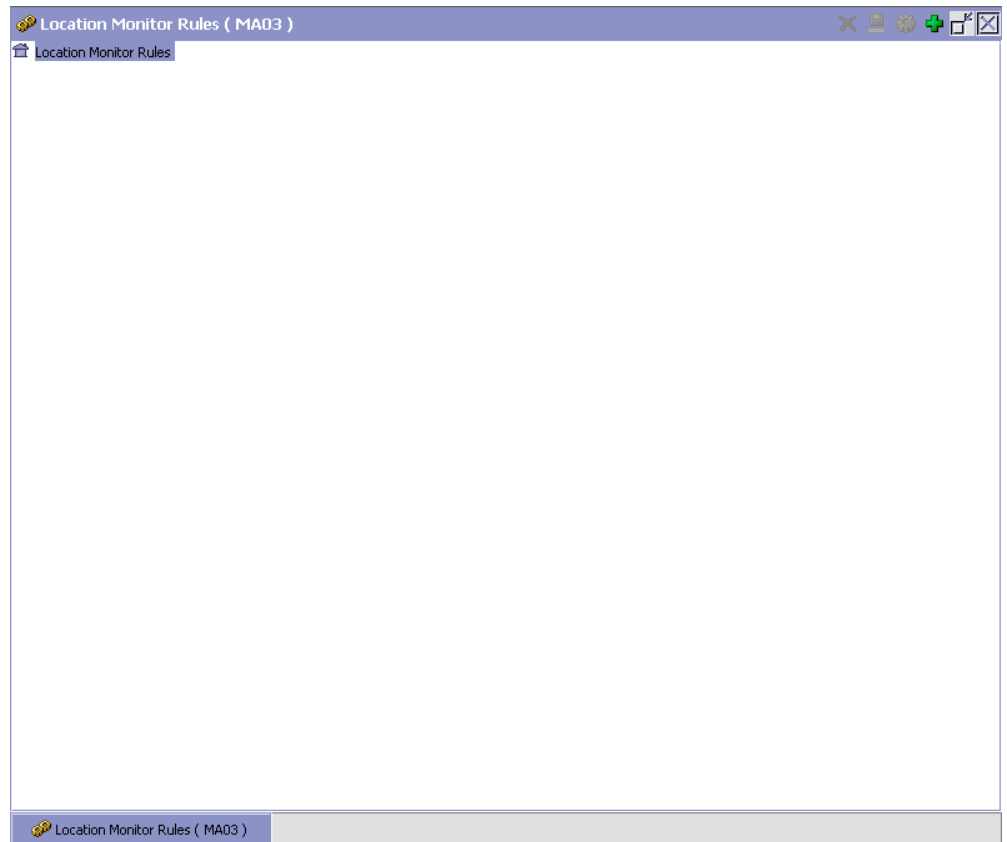
1. From the tree in the application rules side panel, choose Inventory > Monitoring Rules. The Location Monitor Rules window displays.



2. In the Location Monitor Rules window, choose .
3. The Location Monitor Rule Details pop-up window displays.
4. Enter information in the applicable fields. Refer [Table 4–18](#) for field value descriptions.
5. Choose .

The screenshot shows a software window titled "Location Monitor Rule Details". It is divided into several sections:

- Monitor Rule:** Contains two text input fields: "Rule ID" and "Description".
- Zones to Monitor:** Contains a table with the title "Zones_To_Monitor". The table has two columns: "Zone" and "Location Size Code". There is one row with an asterisk (*) in the first column. Below the table, it says "Results 0 Of 6".
- Products to Monitor:** Contains three dropdown menus: "Enterprise", "Product Class", and "Item Classification".
- Alert Details:** Contains four dropdown menus: "Event to Monitor", "Re-Alert Time Interval", "Minimum Trigger Percentage", and "Service To Perform".

Table 4–18 Location Monitor Rule Details Pop-up Window

Field	Description
Monitor Rule	
Rule ID	Enter a name for the location monitor rule being created.
Description	Enter a description for the location monitor rule being created.
Zones to Monitor	
Zone	Choose the Zones to be monitored.
Location Size Code	Choose the Location Size Codes relevant to the zones being monitored.
Products to Monitor	
Enterprise	Choose the enterprise whose products are to be monitored.

Table 4–18 Location Monitor Rule Details Pop-up Window

Field	Description
Product Class	Choose the product class relevant to the product to be monitored.
Item Classification	Choose item classifications relevant to the product to be monitored.
Alert Details	
Event to Monitor	Choose the event to be monitored. Choose a valid event from the drop-down list. Refer to Table 4–19 for assistance.
Re-Alert Time Interval	Enter the re-alert time interval. Re-alert time intervals may be set in terms of Days, Hours, Minutes, or Seconds.
Minimum Trigger Percentage	Enter the minimum trigger percentage. Minimum Trigger Percentage defines the minimum value of the inventory at which the replenishment trigger is to be launched.
Service to Perform	Choose the service to be performed.

Table 4–19 List of Valid Events

Events	Services
Location Empty	<p>GenerateCountRequest</p> <p>For example, when locations become empty, you can configure to create a count request to check whether the location is empty.</p> <p>Note: The Location Empty event is applicable only to non-dedicated locations.</p>
Inventory Below Minimum	<p>GenerateMoveRequest</p> <p>For example, when inventory at dedicated locations fall below the user defined minimum trigger percentage, you can configure to create a move request to replenish inventory for locations that use this service.</p> <p>Note: The Inventory Below Minimum event is applicable only to the dedicated locations.</p>
Inventory Below Minimum Qty	<p>GenerateMoveRequest</p> <p>For example, when inventory at dedicated locations fall below the minimum quantity, you can configure to create a move request to replenish inventory up to maximum quantity for locations that use this service.</p> <p>Note: The Inventory Below Minimum Quantity event is applicable only to the dedicated locations.</p>
Inventory Below Current Demand	<p>GenerateMoveRequest</p> <p>For example, when inventory at locations in the pick zone fall below the current demand, you can configure to create a move request to replenish inventory for locations using this service.</p>

Table 4–19 List of Valid Events

Events	Services
Inventory Above Current Demand	<p>GenerateMoveRequest</p> <p>For example, when inventory at locations in the pick zone are more than the current demand, you can configure to create a move request to putaway additional inventory from the location.</p>
Non Dedicated Item in Dedicated Locations	<p>CallCreateException</p> <p>For example, when dedicating locations to specific items, the existing inventory at the location may conflict with the dedication being made. In such cases, you can configure to create an exception and notify users. Or, you can configure to create a move request to put away items offending the dedication.</p>
Inventory Mix Constraints Violated	<p>CallCreateException</p> <p>For example, when overriding a suggested location during the deposition of inventory, due to an exception, the user may violate the do not mix preferences defined for the Zone. In such cases, you can configure to create an exception to raise an alert or create a move request to put away offending items.</p>
Inventory Below Full Capacity	<p>CallCreateException</p> <p>GenerateMoveRequest</p> <p>For example, when inventory at dedicated locations fall below the full capacity, you can configure to create a move request to replenish inventory in these locations.</p>

Table 4–19 List of Valid Events

Events	Services
Non Zero Inventory	<p>CallCreateException</p> <p>For example, by end of day, if inventory is found at the receiving dock, you can configure to raise an alert.</p>
Expired Inventory	<p>MoveExpiredInventory</p> <p>For example, you can monitor the expiration date of the time-sensitive inventory of a location and can move the expired inventory to a particular zone for inspection.</p> <p>Note: To move the expired inventory, the user must configure the corresponding activity constraints for the EXPIRED_INV_CHECK activity code in the Activities window. For information about configuring activity constraints, refer to Section 6.2, "Defining Activity Constraints".</p>

Note: When Location Inventory Monitor agent is run for Inventory Below Minimum event, move requests are created in instances where the minimum quantity is less than the sum of current quantity and pend in quantity.

4.8.2 Creating a New Monitoring Rule from an Existing Monitoring Rule



To create a new monitoring rule from an existing monitoring rule:

1. From the tree in the application rules side panel, choose Inventory > Monitoring Rules.
2. The Location Monitor Rules window displays with the list of existing Monitoring Rules.
3. Select the Monitoring Rule to be copied from. Choose .
4. The Location Monitor Rule Details pop-up window displays.

5. Enter information in the applicable fields. Refer [Table 4–18](#) for field value descriptions.
6. Choose .

4.8.3 Modifying a Monitoring Rule

To modify an existing monitoring rule:

1. From the tree in the application rules side panel, choose Inventory > Monitoring Rules.
2. The Location Monitor Rules window displays with the list of existing Monitoring Rules.
3. Select the Monitoring Rule to be modified. Choose .
4. The Location Monitor Rule Details pop-up window displays.
5. Enter information in the applicable fields. Refer [Table 4–18](#) for field value descriptions.
6. Choose .

4.8.4 Deleting a Monitoring Rule

To delete an existing monitoring rule:

1. From the tree in the application rules side panel, choose Inventory > Monitoring Rules.
2. The Location Monitor Rules window displays with the list of existing Monitoring Rules.
3. Select the Monitoring Rule to be deleted.
4. Choose .

4.9 Defining Transaction Repository

A repository is a logical collection of entities that define the business process workflow. Transaction Repository includes the following entities:

- Transactions
- Conditions
- Actions

- Services

Selling and Fulfillment Foundation provides a base repository for each of the system defined process types. Some of the entities within a repository are copied when creating a new document type. For more information about creating a new document type, see the *Selling and Fulfillment Foundation: Application Platform Configuration Guide*.

For more information about defining process type details, see the *Selling and Fulfillment Foundation: Application Platform Configuration Guide*.

4.9.1 Transactions

Every process type has a set of base transactions defined for it. A transaction is a logical unit of work that is necessary for performing an activity within Selling and Fulfillment Foundation. Base transactions are predefined transactions that contain information about how the transaction behaves, such as how many copies of a transaction can be kept in a process type and whether or not it can have configurable base pick and drop statuses. Base transactions can be used to create new transactions. These transactions can be changed within the limits defined in the base transaction.

For more information about Transactions, see the *Selling and Fulfillment Foundation: Application Platform Configuration Guide*.

To view the transaction repository details for WMS inventory:

1. From the tree in the application rules side panel, choose Inventory > Transaction Repository. The WMS Inventory window displays.
2. In the WMS Inventory window, choose .
3. The Transactions tab window displays.

For more information about creating and modifying Transactions, see the *Selling and Fulfillment Foundation: Application Platform Configuration Guide*.

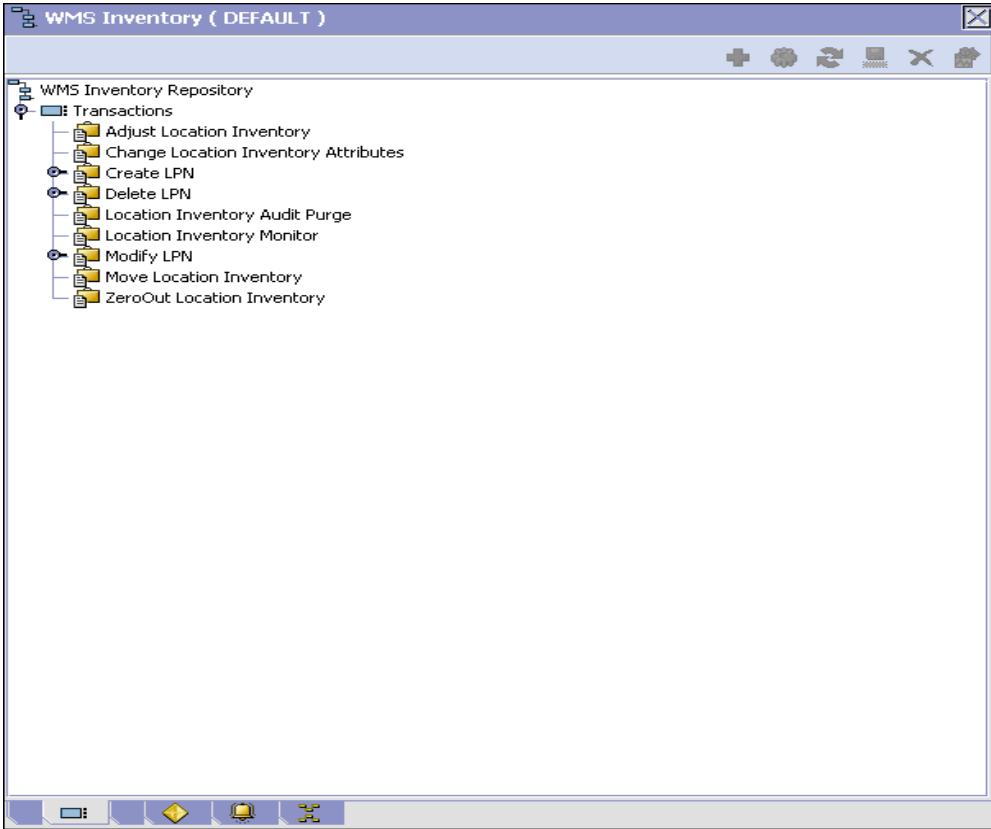

Table 4–20 WMS Inventory - Transactions Tab Window

Field	Description
Adjust Location Inventory	This transaction represents the adjustment of location inventory.
Change Location Inventory Attributes	This transaction represents the modification of location inventory attribute.
Create LPN	This transaction represents the creation of an LPN.
Delete LPN	This transaction represents the deletion of an LPN.
Location Inventory Audit Purge	This transaction represents a location inventory audit that may now be purged.

Table 4–20 WMS Inventory - Transactions Tab Window

Field	Description
Location Inventory Monitor	This transaction represents the monitoring of the location inventory.
Modify LPN	This transaction represents the modification of an LPN.
Move Location Inventory	This transaction represents the movement of the location inventory.
ZeroOut Location Inventory	This transaction represents the cleaning out of the accounting bin.

4.9.2 Conditions

A condition matches document type attributes against decision points and routes the documents to different paths based on the specified attribute and value combinations. The document type attributes against which conditions can be created are predefined in Selling and Fulfillment Foundation. You can use these attributes in any combination or you can create conditions that run the appropriate application logic for specific circumstances.

For more information about Conditions, see the *Selling and Fulfillment Foundation: Application Platform Configuration Guide*.

To view the condition repository details for WMS inventory:

1. From the tree in the application rules side panel, choose Inventory > Transaction Repository. The WMS Inventory window displays.
2. In the WMS Inventory window, choose .
3. The Conditions tab window displays.

For more information about creating and modifying Conditions, see the *Selling and Fulfillment Foundation: Application Platform Configuration Guide*.

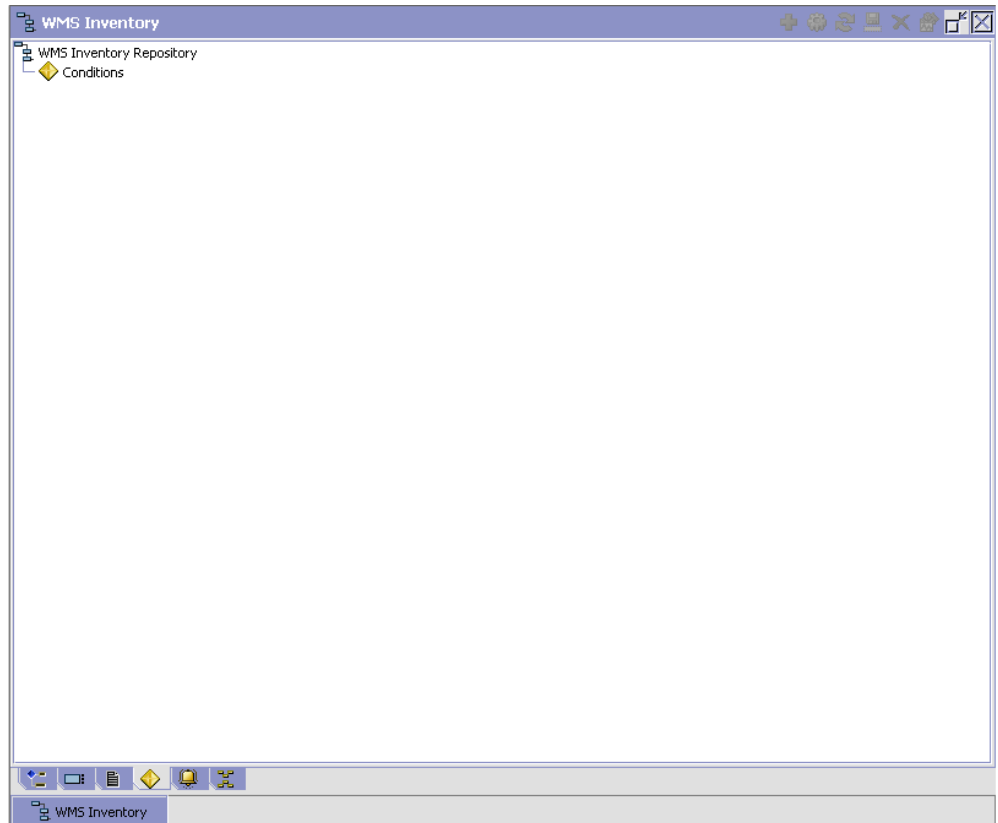

The Sterling WMS default transaction repository does not have any conditions specified.

4.9.3 Actions

An **action** is a process or program that is triggered by an event. These processes and programs send user alert notifications and automatically resolve issues.

For example, when a variance task is created (the event), you can set an action to send the enterprise user an e-mail.

For more information about Actions, see the *Selling and Fulfillment Foundation: Application Platform Configuration Guide*.

To view the action repository details for WMS inventory:

1. From the tree in the application rules side panel, choose Inventory > Transaction Repository. The WMS Inventory window displays.
2. In the WMS Inventory window, choose .
3. The Actions tab window displays.

For more information about creating and modifying Actions, see the *Selling and Fulfillment Foundation: Application Platform Configuration Guide*.

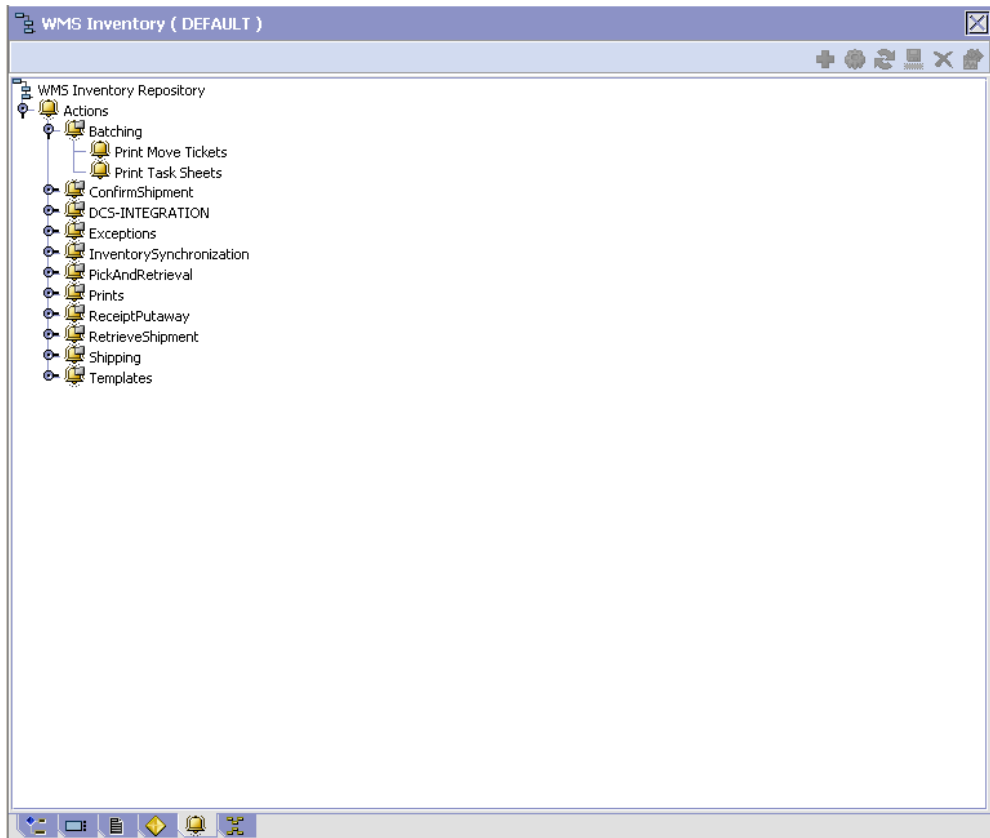

Table 4–21 WMS Inventory - Actions Tab Window

Field	Description
Batching	Default settings are provided for: Print Move Tickets – Invokes the batch printing service for printing the move tickets. Print Task Sheets – Invokes the batch print service for printing the task sheets.
ConfirmShipment	Default settings are provided for: ConfirmShipment – Invokes the confirmShipment flow to confirm the shipment.
DCS-Integration	Default settings are provided for: InventoryDownload – Invokes the YantraWMSInventoryDownloadService service to download the inventory information from Selling and Fulfillment Foundation to DCS. PODownload – Invokes the YantraWMSPODownloadService service to download the Purchase Order information from Selling and Fulfillment Foundation to DCS.
Exceptions	Default settings are provided for: ShortagesDetected – Invokes the LogWavePlaiFailure exception service when shortage of inventory occurs during wave release.
InventorySynchronization	Default settings are provided for: CollectInventoryMismatch – This service collects the inventory mismatch information between an external system and Selling and Fulfillment Foundation. This is typically caused when some inventory updates at a node or a warehouse are not reported to Selling and Fulfillment Foundation.
PickAndRetrieval	Default settings are provided for: ConfirmEmptyLocationAfterPick – Invokes the GenerateCountRequest flow which creates a count request.

Table 4–21 WMS Inventory - Actions Tab Window

Field	Description
Prints	<p>Default settings are provided for:</p> <p>PickList Print – Invokes the print service for printing the Pick List.</p> <p>LTL Manifest – Invokes the print service for printing the Less-than Truck Load Manifest.</p> <p>Print Load BOL – Invokes the print service for printing the Load Bill of Lading.</p> <p>Print PackList – Invokes the print service for printing the Pack List.</p> <p>Print Post Pick Container Labels – Invokes the print service for printing UCC-128 container labels for containers, when system defined packing process is used.</p> <p>Print Shipment BOL – Invokes the print service for printing the Shipment Bill of Lading.</p> <p>Print Shipping Label – Invokes the print service for printing the UCC-128 container labels.</p> <p>Print Wave – Invokes the Print service for printing a Wave.</p>
ReceiptPutaway	<p>Putaway products on receipt – Indicates the default action provided to automatically initiate putaway of purchase order receipts.</p> <p>Note: This action can be configured for the PurchaseOrderReceipt Pipeline in the Receive Transaction for the ON_CASE_RECEIPT, ON_PALLET_RECEIPT and ON_SKU_RECEIPT events.</p>
RetrieveShipment	<p>Retrieve Requested Serial – This service invokes the retrieveShipment API to retrieve the requested serials to the specified location.</p>

Table 4–21 WMS Inventory - Actions Tab Window

Field	Description
Shipping	<p>Default settings are provided for:</p> <p>Load Left Origin – Invokes the doLoadLeftOriginUpdates service to mark that the load has left the origin.</p> <p>Stop Shipping – Invokes the RaiseStopShippingAlert service to raise an alert to stop the processing of the shipment.</p>
Templates	<p>Default settings are provided for:</p> <p>Log Exception – Logs the reasons due to which a count request could not be created for a Count Program.</p> <p>Publish Data – Sends data to external queue or internal tables.</p> <p>Raise Exception – Raises an alert using Event Management from the published information.</p> <p>Send Email – Raises an email action to create an email in the template format from the published information.</p> <p>Send Email-HTML format – Raises an email action to create an email in HTML format from the published information.</p>

4.9.4 Service Definitions

Service definitions are a representation of the logic that regulates document workflow services. The Service Builder is a graphical user interface that enables you to create a graphical representation of these *services*.

For more information about Service Definitions, see the *Selling and Fulfillment Foundation: Application Platform Configuration Guide*.

To view the service definition repository details for WMS Inventory:

1. From the tree in the application rules side panel, choose Inventory > Transaction Repository. The WMS Inventory window displays.
2. In the WMS Inventory window, choose .
3. The Service Definitions tab window displays.

For more information about creating and modifying Service Definitions, see the *Selling and Fulfillment Foundation: Application Platform Configuration Guide*.

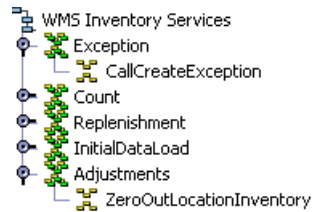

Table 4–22 WMS Inventory - Service Definitions Tab Window

Field	Description
Exception	
CallCreateException	This service is used to create exceptions or alerts for inventory.
Count	
GenerateCountRequest	This service generates the count request for the inventory.
Replenishment	
GenerateMoveRequest	This service generates the move request for the inventory.
InitialDataLoad	
Inventory	This service loads inventory information from a flat file to the database. For more information about Initial Data Loading, see the <i>Selling and Fulfillment Foundation: Integration Guide</i> .

Table 4–22 WMS Inventory - Service Definitions Tab Window

Field	Description
Adjustments	
ZeroOutLocationInventory	<p>When you click on the Save button in the Accounting Bin Adjustment screen, by default the ZEROOUT_LOC_INV_IS_INITIATED event is raised on the ZEROOUT_LOCATION_INV transaction. This event invokes the ZeroOutLocationInventory service. This service puts the message in the DefaultAgentQueue. You can copy this service and configure the following parameters, and invoke the service on the following events:</p> <ul style="list-style-type: none"> • QueueName • ProviderURL • QCFLookUp • Initial Context factory <p>This service creates the message and puts it in the JMS queue. The message contains information about the accounting bin that needs to be cleaned up. To enable this service, the JMS queue needs to be configured on the web server.</p> <p>For more information about configuring the web server, see the <i>Selling and Fulfillment Foundation: Integration Guide</i>.</p>

4.10 Defining Purge Criteria

Transactional data collected by the Sterling WMS during execution are periodically removed from the "live" transactional tables. It is common to retain order related information for extended periods of time. There are history tables provided for relevant transactional tables to move data from the day-to-day "live" tables to a historical table.

Purge is the process by which old data is removed from the system database. A purge minimizes the number of unused database records to increase search efficiency and reduces the size of the required physical disk.

4.10.1 Setting Up Purge Criteria

To set up purge criteria:

1. From the tree in the application rules side panel, choose Inventory > Purge Criteria. The Purge Criteria List window displays.

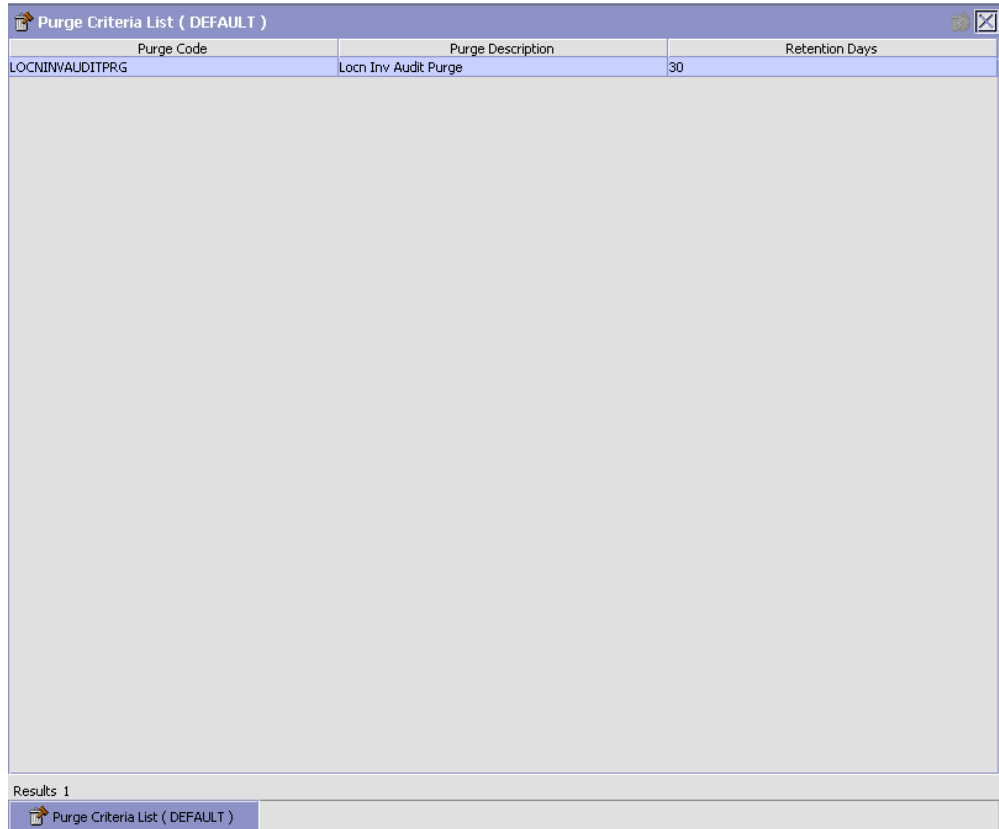

The screenshot shows a window titled "Purge Criteria List (DEFAULT)" with a table containing one row of data. The table has three columns: "Purge Code", "Purge Description", and "Retention Days".

Purge Code	Purge Description	Retention Days
LOCNINVAUDITPRG	Locn Inv Audit Purge	30

Below the table, it says "Results 1". At the bottom of the window, there is a tab labeled "Purge Criteria List (DEFAULT)" and a save icon.



2. In the Purge Criteria List window, choose . The Purge Criteria Details pop-up window displays.
3. Enter information in the applicable fields. Refer [Table 4–23](#) for field value descriptions.
4. Choose .

Table 4–23 Purge Criteria Details Pop-up Window

Field	Description
Purge Code	Identifies a purge program. This is a system defined code.
Description	Description of the purge.
Rollback Segment	Defines the rollback segment that should be explicitly used for the purge transaction qualified by the purge code. This is useful when there are huge logical data sets that have to be purged. This is optional and used for order related purges.
Retention Days	Enter the number of days of data to be retained in the database (going backwards from the time the program runs). Make sure that your table size takes into account the number of retention days entered here.

Table 4–23 Purge Criteria Details Pop-up Window

Field	Description
Write To Log File	Check this box if you want purged data written to a log. The log can be backed up and used as a journal at a later date.
Log File Name	<p>Enter a log file name. This is applicable only if 'Write To Log File' is checked. This file consists records of the specific table that is purged.</p> <p>The log file is created in the directory specified in the <code>yfs.purge.path</code> property. If this is not passed, it defaults to the value specified in the <code>yfs.properties</code> file. If a variable is introduced, then the <code>yfs.purge.path</code> is ignored. To modify this property, add an entry for it in the <code><INSTALL_DIR>/properties/customer_overrides.properties</code> file. For additional information about overriding properties using the <code>customer_overrides.properties</code> file, see the <i>Selling and Fulfillment Foundation: Properties Guide</i>.</p> <p>For information about file name limitations relating to internationalization, see the <i>Selling and Fulfillment Foundation: Localization Guide</i>.</p>

4.11 Defining Node Item Attributes

Node Item Attributes define the attributes that may be overridden at the Node level. The Item IDs and their respective UOMs that may be set up to be overridden at the node level are defined here.

Use Node Item Attributes for:



- [Creating a Node Item Attribute](#)
- [Modifying a Node Item Attribute](#)
- [Deleting a Node Item Attribute](#)

4.11.1 Creating a Node Item Attribute

To create a node item attribute:

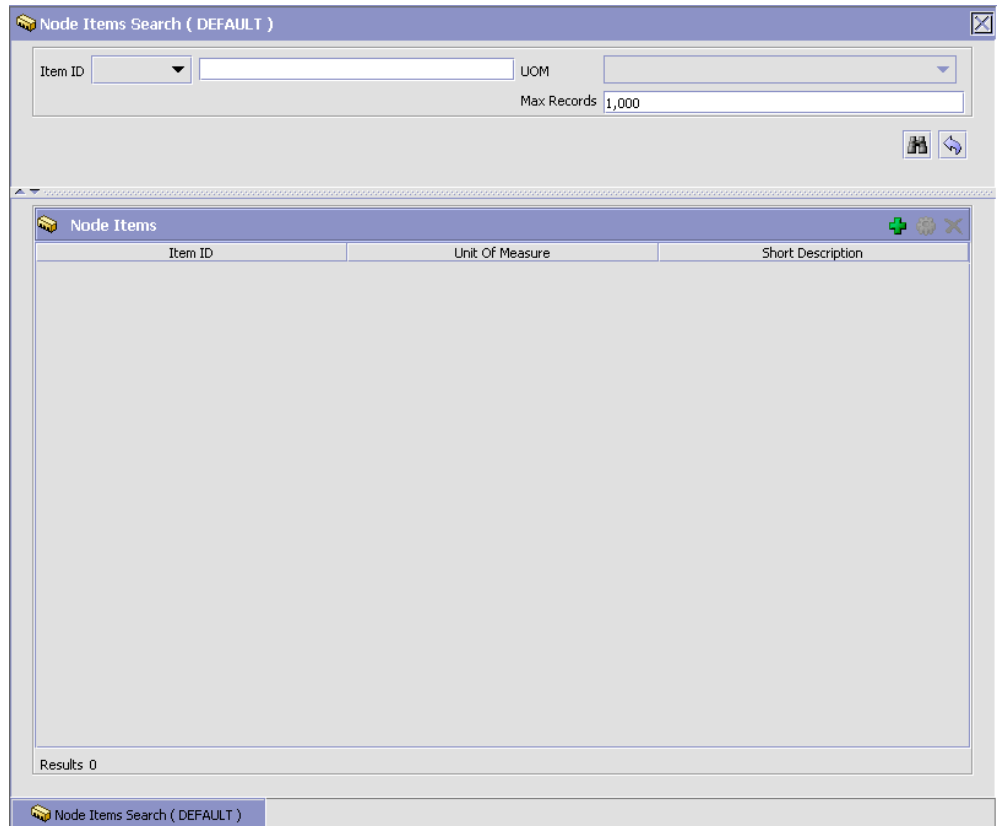
1. From the tree in the application rules side panel, choose Inventory > Node Item Attributes. The Node Items Search window displays.



2. In the Node Items panel of the Node Items Search window, choose . The Item Node Definition Details pop-up window displays.
3. Enter information in the applicable fields. Refer [Table 4–24](#) for field value descriptions.
4. Choose .

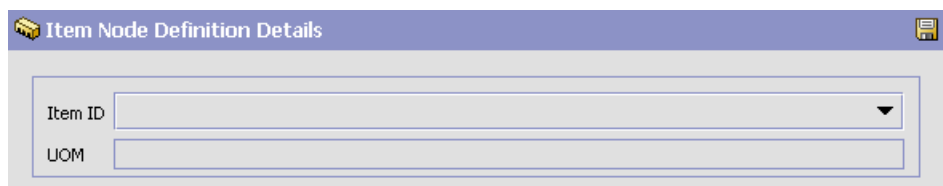





Table 4–24 Item Node Definition Details Pop-up Window

Field	Description
Item ID	Choose the Item ID for the node item definition.
UOM	This indicates the unit of measure for the Item ID selected. This is automatically populated by the system on selection of the Item ID.

4.11.2 Modifying a Node Item Attribute

Once a node item attribute has been created, it may be modified.



To modify a node item attribute:

1. From the tree in the application rules side panel, choose Inventory > Node Item Attributes. The Node Items Search window displays.
2. In the Node Items Search panel, enter the applicable search criteria.
3. Choose . The relevant Node Item Attributes display in the Node Items Panel.
4. Choosing  resets the search criteria.
5. Select the Node Item Attribute to be modified. Choose .
6. The Item Node Definition Details pop-up window displays.
7. Enter information in the applicable fields. Refer [Table 4–24](#) for field value descriptions.
8. Choose .

4.11.3 Deleting a Node Item Attribute

To delete a node item attribute:

1. From the tree in the application rules side panel, choose Inventory > Node Item Attributes. The Node Items Search window displays.
2. In the Node Items Search panel, enter the applicable search criteria.
3. Choose . The relevant Node Item Attributes display in the Node Items Panel.

4. Choosing  resets the search criteria.
5. Select the Node Item Attribute to be deleted. Choose .

4.12 Defining Move Request Parameters

Use Move Request for:

- [Defining Move Request Transaction Repository](#)
- [Defining Purge Criteria for Move Request](#)
- [Defining Move Request Cancellation Reasons](#)

4.12.1 Defining Move Request Transaction Repository

A repository is a logical collection of entities that define the business process workflow. Transaction Repository includes the following entities:

- Transactions
- Conditions
- Actions
- Services

Selling and Fulfillment Foundation provides a base repository for each of the system-defined process types. Some of the entities within a repository are copied when creating a new document type. For more information about creating a new document type, see the *Selling and Fulfillment Foundation: Application Platform Configuration Guide*.

For more information about defining process type details, see the *Selling and Fulfillment Foundation: Application Platform Configuration Guide*.

4.12.1.1 Transactions

Every process type has a set of base transactions defined for it. A transaction is a logical unit of work that is necessary for performing an activity within Selling and Fulfillment Foundation. Base transactions are predefined transactions that contain information about how the transaction behaves, such as how many copies of a transaction can be kept in a process type and whether or not it can have configurable base pick and drop statuses. Base transactions can be used to create new

transactions. These transactions can be changed within the limits defined in the base transaction.

For more information about Transactions, see *Selling and Fulfillment Foundation: Application Platform Configuration Guide*.

To view the transaction repository details for move request:

1. From the tree in the application rules side panel, choose Inventory > Move Request > Transaction Repository. The Move Request Execution window displays.
2. In the Move Request Execution window, choose .
3. The Transactions tab window displays.

For more information about creating and modifying Transactions, see *Selling and Fulfillment Foundation: Application Platform Configuration Guide*.

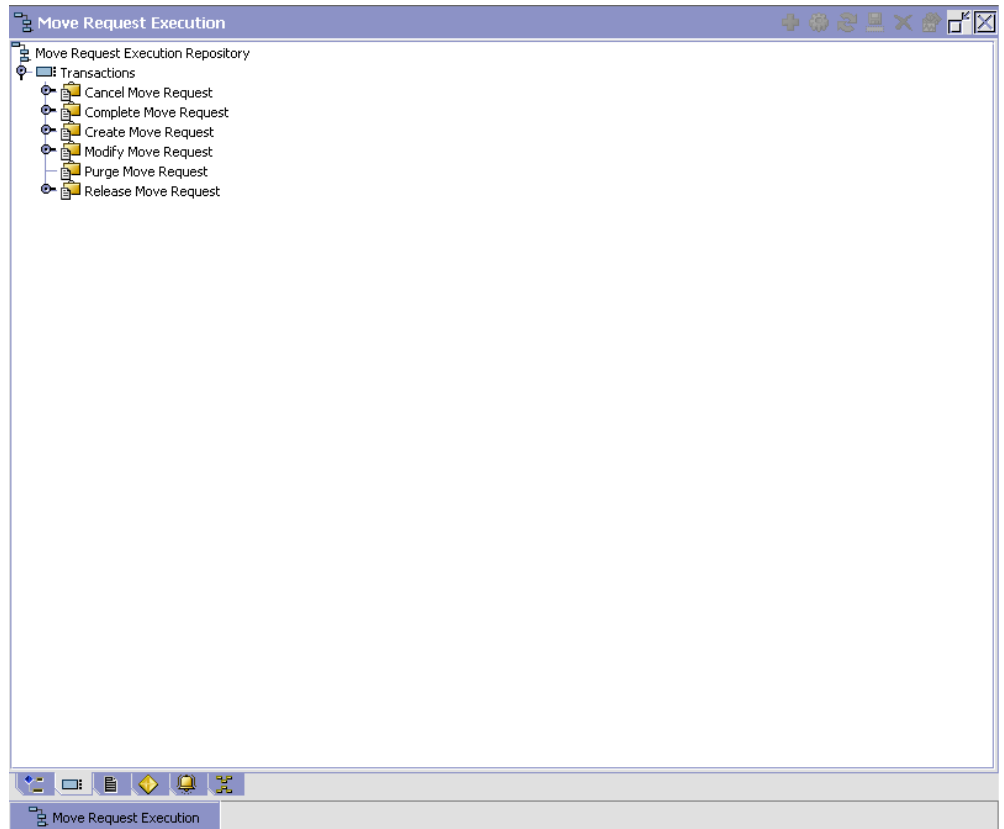

Table 4–25 *Move Request Execution - Transactions Tab Window*

Field	Description
Cancel Move Request	This transaction represents the cancellation of a move request.
Complete Move Request	This transaction represents the completion of a move request.
Create Move Request	This transaction represents the creation of a move request.
Modify Move Request	This transaction represents the modification of a move request.

Table 4–25 Move Request Execution - Transactions Tab Window

Field	Description
Purge Move Request	This transaction represents a move request that may now be purged.
Release Move Request	This transaction represents the release of a move request.

4.12.1.2 Conditions

A **condition** matches document type attributes against decision points and routes the documents to different paths based on the specified attribute and value combinations. The document type attributes against which conditions can be created are predefined in *Selling and Fulfillment Foundation*. You can use these attributes in any combination or you can create conditions that run the appropriate application logic for specific circumstances.

For more information about Conditions, see the *Selling and Fulfillment Foundation: Application Platform Configuration Guide*.

To view the condition repository details for move request:

1. From the tree in the application rules side panel, choose Inventory > Move Request > Transaction Repository. The Move Request Execution window displays.
2. In the Move Request Execution window, choose .
3. The Conditions tab window displays.

For more information about creating and modifying Conditions, see the *Selling and Fulfillment Foundation: Application Platform Configuration Guide*.

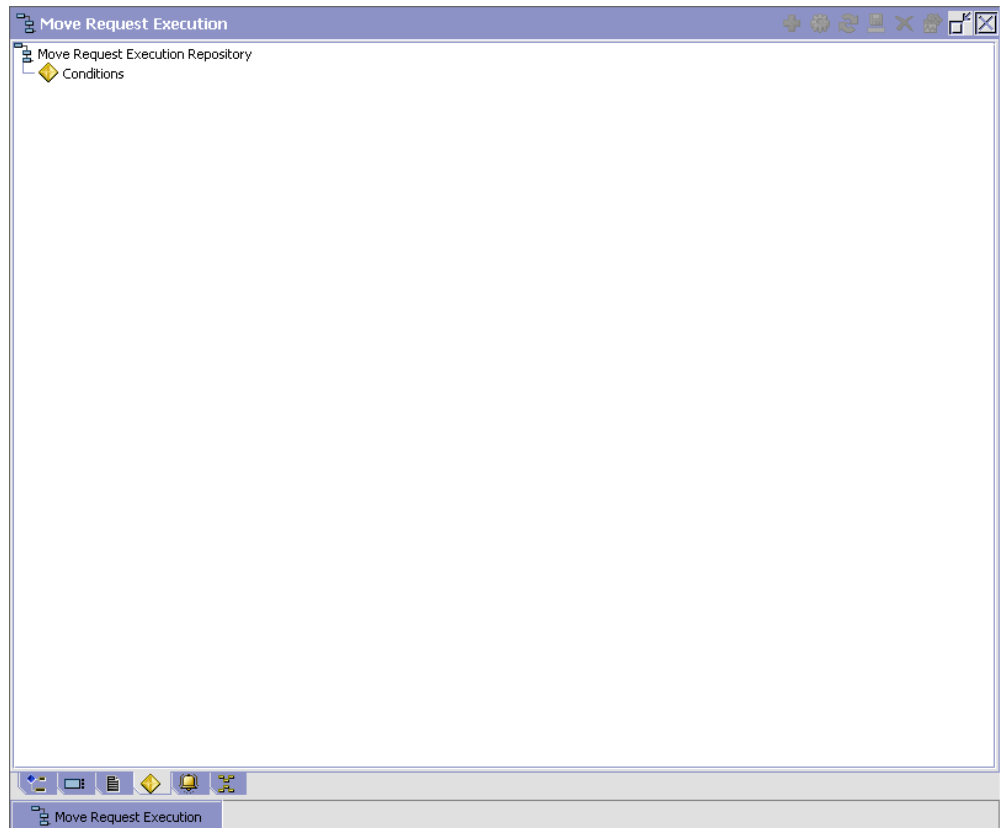

The Sterling WMS default transaction repository does not have any conditions specified.

4.12.1.3 Actions

An **action** is a process or program that is triggered by an event. These processes and programs send user alert notifications and automatically resolve issues.

For example, when a variance task is created (the event), you can set an action to send the enterprise user an e-mail.

For more information about Actions, see the *Selling and Fulfillment Foundation: Application Platform Configuration Guide*.

To view the action repository details for move request:

1. From the tree in the application rules side panel, choose Inventory > Move Request > Transaction Repository. The Move Request Execution window displays.
2. In the Move Request Execution window, choose .
3. The Actions tab window displays.

For more information about creating and modifying Actions, see the *Selling and Fulfillment Foundation: Application Platform Configuration Guide*.

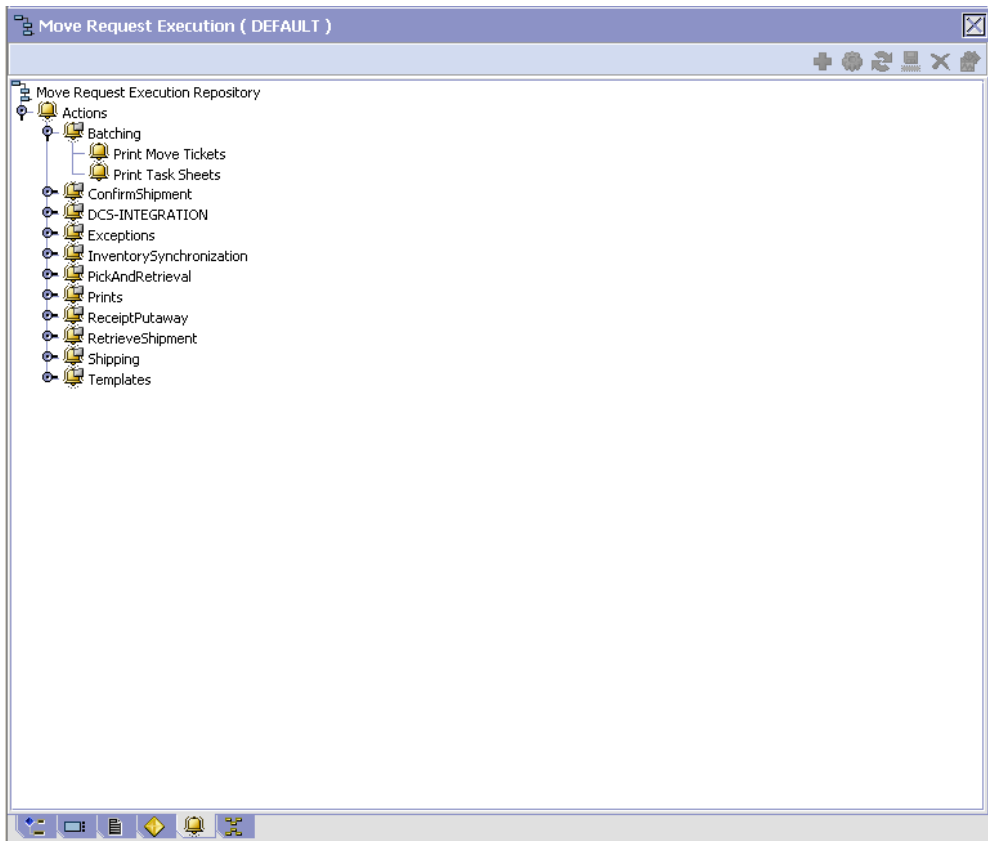

Table 4–26 Move Request Execution - Actions Tab Window

Field	Description
Batching	Default settings are provided for: Print Move Tickets – Invokes the batch printing service for printing the move tickets. Print Task Sheets – Invokes the batch print service for printing the task sheets.
ConfirmShipment	Default settings are provided for: ConfirmShipment – Invokes the confirmShipment flow to confirm the shipment.
DCS-Integration	Default settings are provided for: InventoryDownload – Invokes the YantraWMSInventoryDownloadService service to download the inventory information from Selling and Fulfillment Foundation to DCS. PODownload – Invokes the YantraWMSPODownloadService service to download the Purchase Order information from Selling and Fulfillment Foundation to DCS.
Exceptions	Default settings are provided for: ShortagesDetected – Invokes the LogWavePlaFailure exception service when shortage of inventory occurs during wave release.
InventorySynchronization	Default settings are provided for: CollectInventoryMismatch – This service collects the inventory mismatch information between an external system and Selling and Fulfillment Foundation. This is typically caused when some inventory updates at a node or a warehouse are not reported to Selling and Fulfillment Foundation.
PickAndRetrieval	Default settings are provided for: ConfirmEmptyLocationAfterPick – Invokes the GenerateCountRequest flow which creates a count request.

Table 4–26 Move Request Execution - Actions Tab Window

Field	Description
Prints	<p>Default settings are provided for:</p> <p>PickList Print – Invokes the print service for printing the Pick List.</p> <p>LTL Manifest – Invokes the print service for printing the Less-than Truck Load Manifest.</p> <p>Print Load BOL – Invokes the print service for printing the Load Bill of Lading.</p> <p>Print PackList – Invokes the print service for printing the Pack List.</p> <p>Print Post Pick Container Labels – Invokes the print service for printing UCC-128 container labels for containers, when system defined packing process is used.</p> <p>Print Shipment BOL – Invokes the print service for printing the Shipment Bill of Lading.</p> <p>Print Shipping Label – Invokes the print service for printing the UCC-128 container labels.</p> <p>Print Wave – Invokes the Print service for printing a Wave.</p>
ReceiptPutaway	<p>Putaway products on receipt closure – Indicates the default action provided to automatically initiate putaway of purchase order receipts.</p>
RetrieveShipment	<p>Retrieve Requested Serial – This service invokes the retrieveShipment API to retrieve the requested serials to the specified location.</p>

Table 4–26 Move Request Execution - Actions Tab Window

Field	Description
Shipping	<p>Default settings are provided for:</p> <p>Load Left Origin – Invokes the doLoadLeftOriginUpdates service to mark that the load has left the origin.</p> <p>Stop Shipping – Invokes the RaiseStopShippingAlert service to raise an alert to stop the processing of the shipment.</p>
Templates	<p>Default settings are provided for:</p> <p>Log Exception – Logs the reasons due to which a count request could not be created for a Count Program.</p> <p>Publish Data – Sends data to external queue or internal tables.</p> <p>Raise Exception – Raises an alert using Event Management from the published information.</p> <p>Send Email – Raises an email action to create an email in the template format from the published information.</p> <p>Send Email-HTML format – Raises an email action to create an email in HTML format from the published information.</p>

4.12.1.4 Service Definitions

Service definitions are a representation of the logic that regulates document workflow services. The Service Builder is a graphical interface that enables you to create a graphical representation of these *services*.

For more information about Service Definitions, see the *Selling and Fulfillment Foundation: Application Platform Configuration Guide*.

To view the service definition repository details for move request:

1. From the tree in the application rules side panel, choose Inventory > Move Request > Transaction Repository. The Move Request Execution window displays.
2. In the Move Request Execution window, choose .
3. The Service Definitions tab window displays.

For more information about creating and modifying Service Definitions, see the *Selling and Fulfillment Foundation: Application Platform Configuration Guide*.

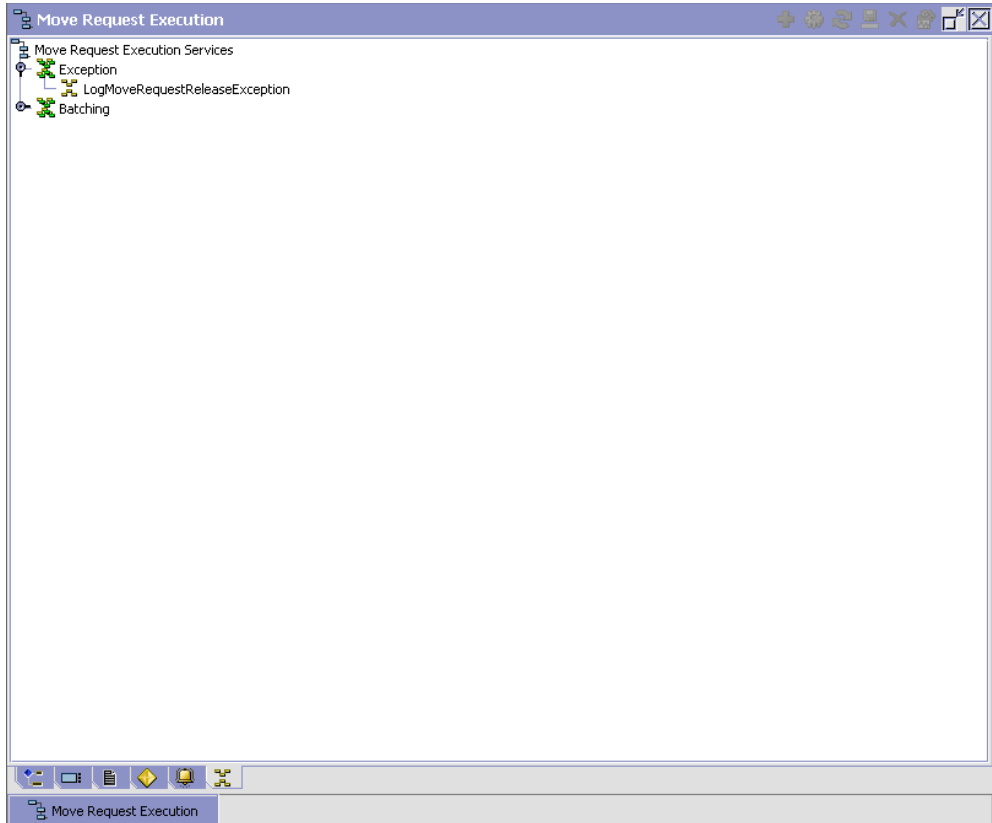

Table 4–27 *Move Request Execution - Service Definitions Tab Window*

Field	Description
Exception	
LogMoveRequestReleaseException	This service creates an exception when no request was created during a move request release.

Table 4–27 Move Request Execution - Service Definitions Tab Window

Field	Description
Batching	
PrintMoveTickets	This service prints the move request tasks belonging to the batch.

4.12.2 Defining Purge Criteria for Move Request

Transactional data collected by the Sterling WMS during execution are periodically removed from the "live" transactional tables. It is common to retain order related information for extended periods of time. There are history tables provided for relevant transactional tables to move data from the day-to-day "live" tables to a historical table.

Purge is the process by which old data is removed from the system database. A purge minimizes the number of unused database records to increase search efficiency and reduces the size of the required physical disk.

4.12.2.1 Setting Up Purge Criteria

To set up purge criteria:

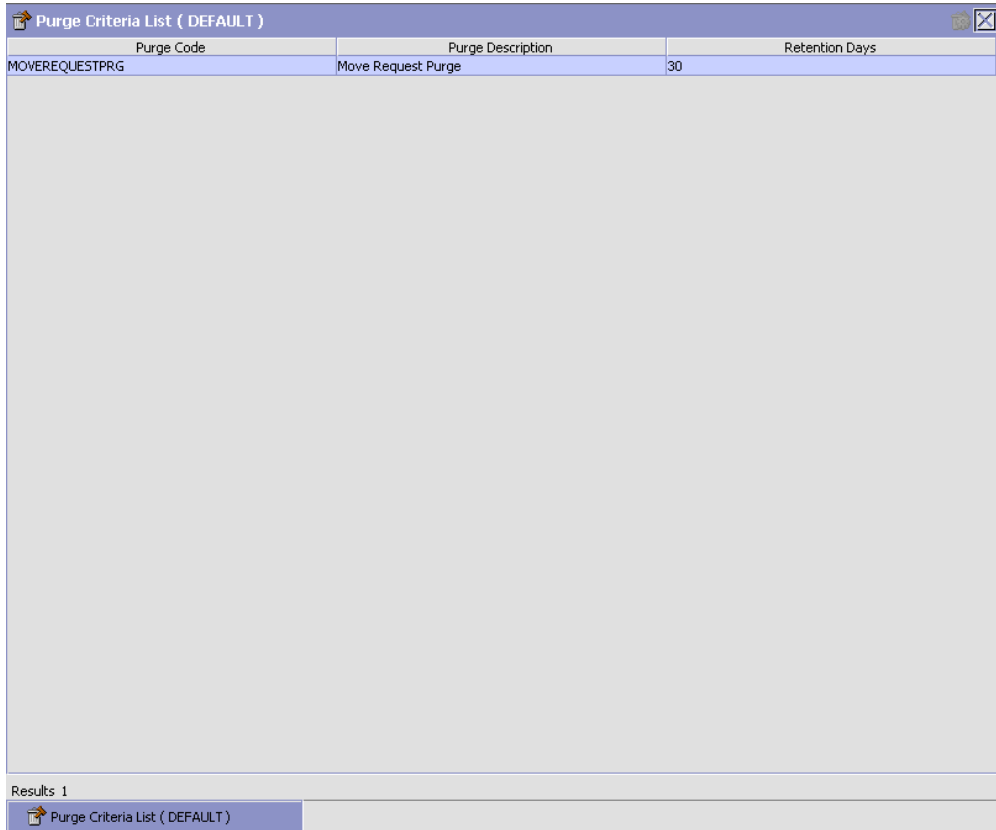

1. From the tree in the application rules side panel, choose Inventory > Move Request > Purge Criteria. The Purge Criteria List window displays.



The screenshot shows a window titled "Purge Criteria List (DEFAULT)" with a close button in the top right corner. The window contains a table with the following data:

Purge Code	Purge Description	Retention Days
MOVEREQUESTPRG	Move Request Purge	30

Below the table, it says "Results 1". At the bottom of the window, there is a status bar with the title "Purge Criteria List (DEFAULT)" and a save icon.

2. In the Purge Criteria List window, choose . The Purge Criteria Details pop-up window displays.
3. Enter information in the applicable fields. Refer [Table 4–28](#) for field value descriptions.
4. Choose .

Purge Criteria Details

Purge Code: Description:

Rollback Segment: Retention Days:

Write To Log File Log File Name:

Table 4–28 Purge Criteria Details Pop-up Window

Field	Description
Purge Code	Identifies a purge program. This is a system defined code.
Description	Description of the purge.
Rollback Segment	Defines the rollback segment that should be explicitly used for the purge transaction qualified by the purge code. This is useful when there are huge logical data sets that have to be purged. This is optional and used for order related purges.
Retention Days	Enter the number of days of data to be retained in the database (going backwards from the time the program runs). Make sure that your table size takes into account the number of retention days entered here.

Table 4–28 Purge Criteria Details Pop-up Window

Field	Description
Write To Log File	Check this box if you want purged data written to a log. The log can be backed up and used as a journal at a later date.
Log File Name	<p>Enter a log file name. This is applicable only if 'Write To Log File' is checked. This file consists records of the specific table that is purged.</p> <p>The log file is created in the directory specified in the <code>yfs.purge.path</code> property. If this is not passed, it defaults to the value specified in the <code>yfs.properties</code> file. If a variable is introduced, then the <code>yfs.purge.path</code> is ignored. To modify this property, add an entry for it in the <code><INSTALL_DIR>/properties/customer_overrides.properties</code> file. For additional information about overriding properties using the <code>customer_overrides.properties</code> file, see the <i>Selling and Fulfillment Foundation: Properties Guide</i>.</p> <p>For information about file name limitations relating to internationalization, see the <i>Selling and Fulfillment Foundation: Localization Guide</i>.</p>

4.12.3 Defining Move Request Cancellation Reasons

A *Move Request Cancellation Reason* defines the reason code to associate to the cancellation of requests. Reason codes are specific to a warehouse and its processes.

Use Move Request Cancellation Reasons for:

- [Creating a Move Request Cancellation Reason](#)
- [Creating a New Move Request Cancellation Reason from an Existing Move Request Cancellation Reason](#)
- [Modifying a Move Request Cancellation Reason](#)
- [Deleting a Move Request Cancellation Reason](#)

4.12.3.1 Creating a Move Request Cancellation Reason

To create a move request cancellation reason:

1. From the tree in the application rules side panel, choose Inventory > Move Request > Move Request Cancellation Reasons.
2. The Move Request Cancellation Reason window displays.

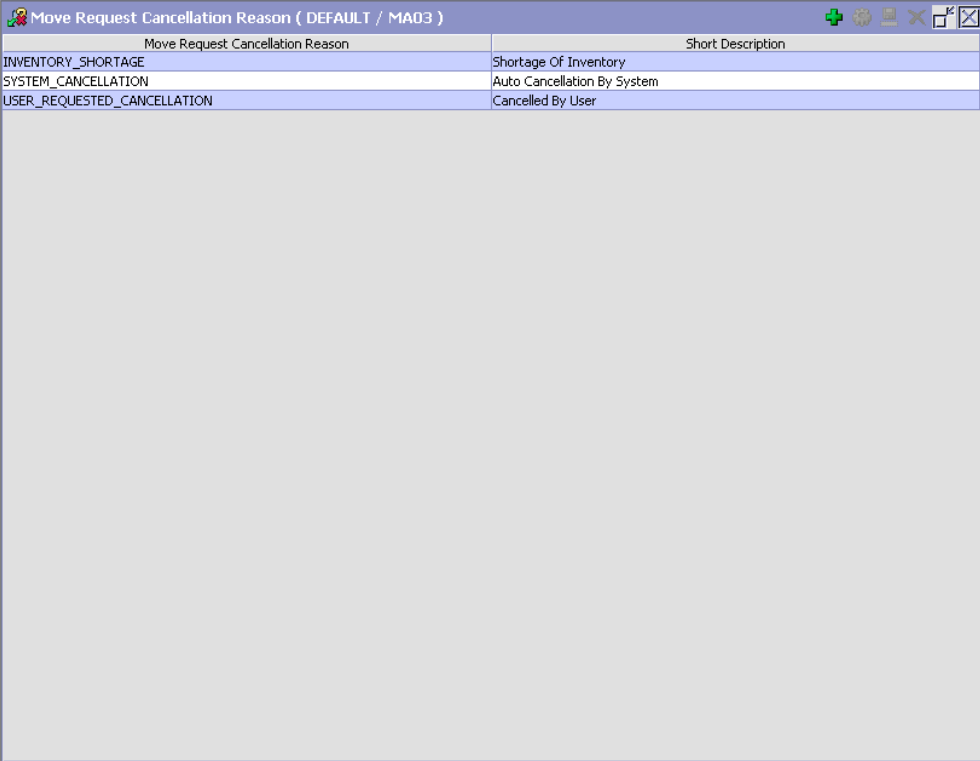

Move Request Cancellation Reason (DEFAULT / MA03)

Move Request Cancellation Reason	Short Description
INVENTORY_SHORTAGE	Shortage Of Inventory
SYSTEM_CANCELLATION	Auto Cancellation By System
USER_REQUESTED_CANCELLATION	Cancelled By User

Results 3 Of 3

Move Request Cancellation Reason (DEFAULT / MA03)



3. In the Move Request Cancellation Reason window, choose .
4. The Move Request Cancel Reason Details pop-up window displays.
5. Enter information in the applicable fields. Refer [Table 4–29](#) for field value descriptions.

Table 4–29 *Move Request Cancel Reason Details Pop-up Window*

Field	Description
Move Request Cancel Reason	Enter a name for the move request cancellation reason.
Short Description	Enter a short description for the move request cancellation reason.
Long Description	Enter a long description for the move request cancellation reason.

4.12.3.2 Creating a New Move Request Cancellation Reason from an Existing Move Request Cancellation Reason



To create a new move request cancellation reason from an existing move request cancellation reason:

1. From the tree in the application rules side panel, choose Inventory > Move Request > Move Request Cancellation Reasons.
2. The Move Request Cancellation Reason window displays with the list of Move Request Cancellation Reasons.
3. Select the Move Request Cancellation Reason to be copied.
4. Choose . The Move Request Cancel Reason Details pop-up window displays.
5. Enter information in the applicable fields. Refer [Table 4–29](#) for field value descriptions.
6. Choose .

4.12.3.3 Modifying a Move Request Cancellation Reason

Once a Move Request Cancellation Reason has been created, it can be modified.

To modify a move request cancellation reason:

1. From the tree in the application rules side panel, choose Inventory > Move Request > Move Request Cancellation Reasons.
2. The Move Request Cancellation Reason window displays with the list of Move Request Cancellation Reasons.
3. Select the Move Request Cancellation Reason to be modified.
4. Choose . The Move Request Cancel Reason Details pop-up window displays.
5. Enter information in the applicable fields. Refer [Table 4–29](#) for field value descriptions.
6. Choose .

4.12.3.4 Deleting a Move Request Cancellation Reason

To delete a move request cancellation reason:

1. From the tree in the application rules side panel, choose Inventory > Move Request > Move Request Cancellation Reasons.
2. The Move Request Cancellation Reason window displays with the list of Move Request Cancellation Reasons.
3. Select the Move Request Cancellation Reason to be deleted.
4. Choose .

4.13 Defining Count

The Sterling WMS allows count requests to be initiated through a console on an ad hoc basis. System events like exception being recorded during putaway, retrieval or pick, or location quantity dropping below minimum levels or to zero can be used to initiate a count request. A request also includes date and time parameters indicating the start and end time expected for the task.

For example, a user may request a count for a zone that has slow moving items to start the next day by assigning a low priority.

A count request is also created through the Event Management and inventory monitors either when the inventory at a location reaches zero quantity, or when the minimum or maximum inventory levels are breached.

Use Count set-up to define:

- [Defining Variance Hold Setup](#)
- [Defining Request Type](#)
- [Defining Count Request Cancellation Reasons](#)
- [Defining Count Program](#)
- [Defining Count Modification Rules](#)
- [Defining Count Process Type Details](#)
- [Defining Count Process Model](#)
- [Defining Count Strategy](#)
- [Defining Purge Criteria](#)
- [Defining Corporate Count Request Purge Criteria](#)

4.13.1 Defining Variance Hold Setup

During count, if any negative variances are encountered, the location in a zone can be put on variance hold. This automatically blocks the inventory at the location from being allocated or suggested for pick.

To set up a zone's put on variance hold:

1. From the tree in the application rules side panel, choose Inventory > Count > Variance Hold Setup. The Variance Hold Setup window displays with the list of Zones.
2. Select the appropriate action at the zone level. Refer [Table 4–30](#) for field value descriptions.
3. Choose .

Zone	Description	Put On Variance Hold
DOCK-ZONE	Dock Zone having floor locations	<input type="checkbox"/>
VAS-ZONE	VAS Zone	<input type="checkbox"/>
PACK-ZONE	Pack Zone having floor locations	<input type="checkbox"/>
ACTIVE-ZONE	Active Zone with case racks and pigeonholes	<input type="checkbox"/>
CASE-RACK-ZONE	Zone with case racks	<input type="checkbox"/>
INFINITE-ZONE	Zone having Infinite locations	<input type="checkbox"/>
VIRTUAL-ZONE	Zone with virtual locations	<input type="checkbox"/>
VIRTUAL-NoLPNTrack	Zone does not track LPN	<input type="checkbox"/>
VIRTUAL-NoTrack	Zone does not track inventory or LPN	<input type="checkbox"/>
VIRTUAL-NoPalletTrack	Zone does not track Pallet	<input type="checkbox"/>
UNTRACK-LPN-ZONE	Zone doesn't track LPNs	<input type="checkbox"/>

Results 13 Of 13

Variance Hold Setup (MA03)

Table 4–30 Variance Hold Setup Window

Field	Description
Zone	Indicates the list of existing zones for the node. This is populated automatically by the system, and cannot be modified.

Table 4–30 Variance Hold Setup Window

Field	Description
Description	Indicates the zone description. This is populated automatically by the system, and cannot be modified.
Put on Variance Hold	Select if you want the zone to be put on variance hold. This configures the freeze on variance feature for locations belonging to a zone. Only locations belonging to a zone with this flag checked are put on variance hold if negative variance is found during a Count operation.

4.13.2 Defining Request Type

You can define Request Types to be used for a count request. Request Type indicates the type of count requested.

Use Request Types for:

- [Creating a Request Type](#)
- [Creating a New Request Type From an Existing Request Type](#)
- [Modifying a Request Type](#)
- [Deleting a Request Type](#)
- [Setting a Request Type for Create Count Request](#)

4.13.2.1 Creating a Request Type

To create a request type:

1. From the tree in the application rules side panel, choose Inventory > Count > Request Types. The Request Type List window displays.

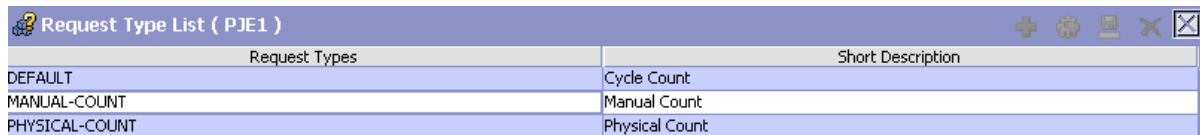

2. In the Request Type List window, choose . The Request Type Details pop-up window displays.

3. Enter information in the applicable fields. Refer [Table 4–31](#) for field value descriptions.
4. Choose .





Table 4–31 Request Type Details Pop-up Window

Field	Description
Request Type	Enter the request type.
Short Description	Enter a brief description for the request type.
Long Description	Enter a more detailed description for the request type.

4.13.2.2 Creating a New Request Type From an Existing Request Type



To create a new request type from an existing request type:

1. From the tree in the application rules side panel, choose Inventory > Count > Request Types. The Request Type List window displays with the list of request types.
2. Choose the Request Type to be copied from. Choose . The Request Type Details pop-up window displays.
3. Enter information in the applicable fields. Refer [Table 4–31](#) for field value descriptions.
4. Choose .

4.13.2.3 Modifying a Request Type

Once a Request Type has been created, it may be modified.

To modify a request type:

1. From the tree in the application rules side panel, choose Inventory > Count > Request Types. The Request Type List window displays with the list of Request Types.
2. Choose the Request Type to be modified. Choose . The Request Type Details pop-up window displays.
3. Enter information in the applicable fields. Refer [Table 4–31](#) for field value descriptions.
4. Choose .

4.13.2.4 Deleting a Request Type

To delete a request type:

1. From the tree in the application rules side panel, choose Inventory > Count > Request Types. The Request Type List window displays with the list of Request Types.
2. Choose the Request Type to be deleted.
3. Choose .

4.13.2.5 Setting a Request Type for Create Count Request

You can set the request type for create count request as cycle count or physical count. To set the request type, you must enter the resource details for create count request.

- To set cycle count as the default request type:

In the Application Consoles Detail View panel, in the Java Server Page field, enter `/extn/wms/count/detail/count_request_detail_createanchor.jsp?requestType=CYCLE-COUNT`.

- To set physical count as the default request type:

In the Application Consoles Detail View panel, in the Java Server Page field, enter `/extn/wms/count/detail/count_request_detail_createanchor.jsp?requestType=PHYSICAL-COUNT`.

- To set physical count as the default request type:

In the Application Consoles Detail View panel, in the Java Server Page field, enter `/extn/wms/count/detail/count_request_detail_createanchor.jsp?requestType=MANUAL-COUNT`.

For more information about defining resources, see the *Selling and Fulfillment Foundation: Application Platform Configuration Guide*.

4.13.3 Defining Count Request Cancellation Reasons

A reason code is associated with cancellation of count requests.

Use Count Request Cancellation Reasons for:

- [Creating a Count Request Cancellation Reason](#)
- [Creating a New Count Request Cancellation Reason from an Existing Count Request Cancellation Reason](#)
- [Modifying a Count Request Cancellation Reason](#)
- [Deleting a Count Request Cancellation Reason](#)

4.13.3.1 Creating a Count Request Cancellation Reason

To create a count request cancellation reason:

1. From the tree in the application rules side panel, choose `Inventory > Count > Count Request Cancellation Reasons`. The Count Request Cancellation Reasons window displays.

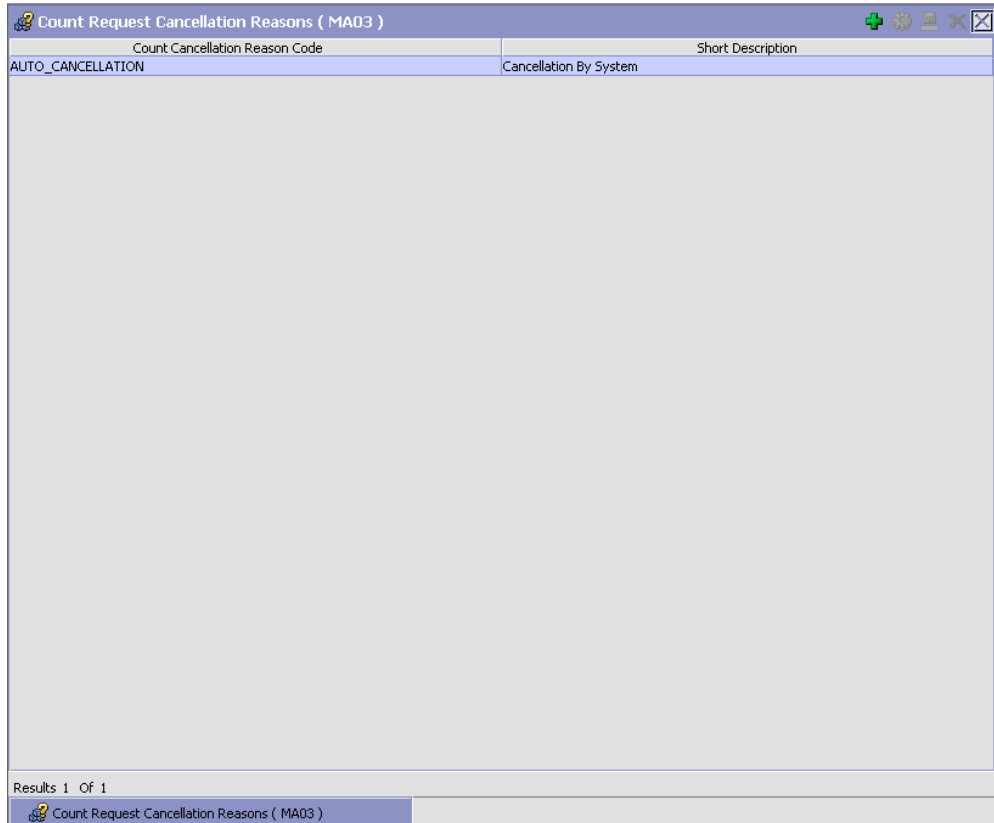

Count Cancellation Reason Code	Short Description
AUTO_CANCELLATION	Cancellation By System

Results 1 Of 1

Count Request Cancellation Reasons (MA03)



2. In the Count Request Cancellation Reasons window, choose .
3. The Count Cancellation Reason Details pop-up window displays.
4. Enter information in the applicable fields. Refer [Table 4–32](#) for field value descriptions.
5. Choose .

Table 4–32 *Count Cancellation Reason Details Pop-up Window*

Field	Description
Count Cancellation Reason	Enter a code for the count request cancellation reason.
Short Description	Enter a short description for the count request cancellation reason.
Long Description	Enter a long description for the count request cancellation reason.

Note: To cancel a released work order for which a move request exists, Selling and Fulfillment Foundation requires a move request cancellation reason called 'SYSTEM'.

4.13.3.2 Creating a New Count Request Cancellation Reason from an Existing Count Request Cancellation Reason

To create a new Count Request Cancellation Reason from an existing Count Request Cancellation Reason:



1. From the tree in the application rules side panel, choose Inventory > Count > Count Request Cancellation Reasons.
2. The Count Request Cancellation Reasons window displays with the list of Count Cancellation Reason Codes.
3. Choose the Count Request Cancellation Reason to be copied.
4. Choose . The Count Cancellation Reason Details pop-up window displays.

5. Enter information in the applicable fields. Refer [Table 4–32](#) for field value descriptions.
6. Choose .

4.13.3.3 Modifying a Count Request Cancellation Reason

Once a Count Request Cancellation Reason has been created, it can be modified.

To modify a Count Request Cancellation Reason:

1. From the tree in the application rules side panel, choose Inventory > Count > Count Request Cancellation Reasons.
2. The Count Request Cancellation Reasons window displays with the list of Count Request Cancellation Reasons.
3. Choose the Count Request Cancellation Reason to be modified.
4. Choose . The Count Cancellation Reason Details pop-up window displays.
5. Enter information in the applicable fields. Refer [Table 4–32](#) for field value descriptions.
6. Choose .

4.13.3.4 Deleting a Count Request Cancellation Reason

To delete a Count Request Cancellation Reason:

1. From the tree in the application rules side panel, choose Inventory > Count > Count Request Cancellation Reasons.
2. The Count Request Cancellation Reasons window displays with the list of Count Request Cancellation Reasons.
3. Choose the Count Request Cancellation Reason to be deleted.
4. Choose .

4.13.4 Defining Count Program

The Sterling WMS is equipped to automatically generate a count request using the Automatic Count Generation functionality at the node level.

The Automatic Count Generation is set up through Count Programs, which define the valid date range of the program, the applicable zones in the warehouse, the products that are to be counted, and the periodicity of the count requests.

The Count Program is associated with a count calendar that would provide information about the list of working days, when the node would perform count for this program.

Use Count Program for:

- [Creating a Count Program](#)
- [Modifying a Count Program](#)
- [Deleting a Count Program](#)

4.13.4.1 Creating a Count Program

To create a count program:

1. From the tree in the application rules side panel, choose Inventory > Count > Count Execution > Count Program. The Count Program List window displays.

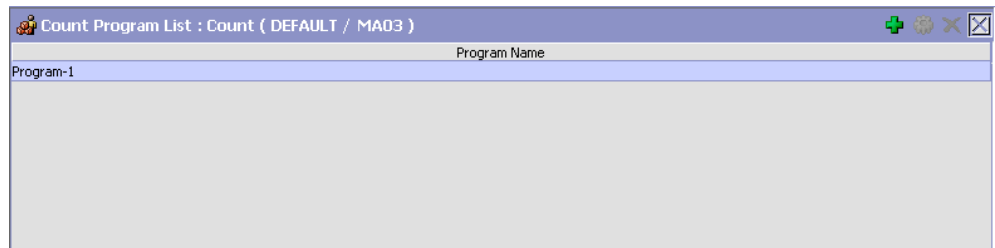

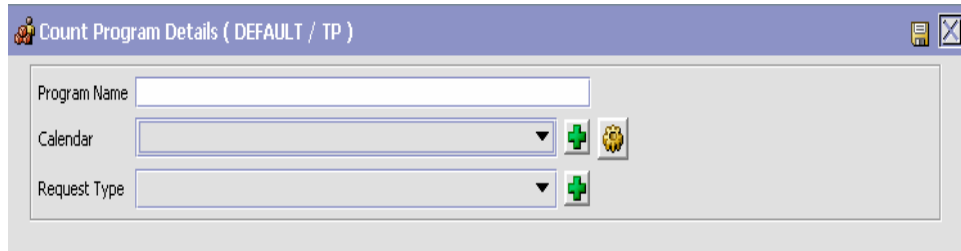

2. In the Count Program List window, choose . The Count Program Details window displays.





Count Program Details (DEFAULT / TP)

Program Name

Calendar  

Request Type 

3. Enter a valid Program Name for the Program being created.
4. Choose the relevant Calendar to be used for the Program, from the Calendar drop-down list. The calendar of the node as well as the calendars of the primary enterprise of the node display in this list. For more information about creating a new calendar, see the *Selling and Fulfillment Foundation: Application Platform Configuration Guide*.
5. Choose the relevant request type from the drop-down menu.
6. Choose . The Count Program Conditions panel is displays in the Count Program Details window.
7. In the Count Program Conditions panel, choose . The Count Program Condition Details Pop-up displays.

Note: Sterling Commerce recommends against configuring more than one location level count program to count the same zone.

Count Program Condition Details

Description

Count Program Condition

Select Locations to be counted in the following zones



Count at Location Level

Count at Classification Level

Item Classification

Count at Item Level

Select Product Classes whose inventory is to be counted



Count inventory when unit value is between and

Percentage to Count

Number of times to count From To





8. Enter information in the applicable fields. Refer [Table 4–33](#) for field value descriptions.
9. Choose . The pop-up window is closed, and you are returned to the Count Program Details window.
10. After setting up all the relevant Count Program Conditions, choose  in the Count Program Details window.

Table 4–33 Count Program Condition Details Pop-up Window

Field	Description
Description	Enter a description for the count program condition.
Count Program Condition	
Select locations to be counted in the following zones	Choose  . In the List of Values pop-up, choose the zones that are to be counted.
Count at Location Level	Select this option if the counting is to be done at the location level.
Count at Classification Level	Select this option if the counting is to be done at the item classification level.
Item Classification	Displays the item classifications that are available to be counted.
Count at Item Level	Select this option if the counting is to be done at the item level.
Select Product Classes whose inventory is to be counted	Choose  . In the List of Values popup, choose the product classes that are to be counted.
Count inventory when unit value is between	Enter the minimum unit value to be counted. This defaults to 0 if no value is provided.
and	Enter the maximum unit value to be counted. This defaults to 99,999 if no value is provided.
Percentage to Count	Enter the percentage of total locations, or items to count, depending on the location level or item level count.
Number of times to count	Enter the number of times to count.

Example for Count Program

Consider that a count program has to be set up to count a certain item classification four times during a year, where:

- The count period dictated by the auditing organization is a year,
- The number of working days is 200 days, and
- The specific item classification is ProductLine being 'HighValue'.

In this instance, the steps to configure the count program is as follows:



- Set up the Count Program with calendar that reflects the count period and the number of working days
- Specify number of times to count, zones and item classification where ProductLine='HighValue' in the count strategy.

It is recommended that the Count Program is scheduled for all working days.

The Count Program determines the number of count requests based on # of working days remaining in Program Calendar with the number of items that meet the criteria specified by the count strategy and the number of times to count the classification.

4.13.4.2 Modifying a Count Program

To modify a Count Program:

1. From the tree in the application rules side panel, choose Inventory > Count > Count Execution > Count Program. The Count Program List window displays with the list of existing programs.
2. Choose the Count Program that is to be modified. Choose .
3. The Count Program Details window displays. Modify the entries as necessary.
4. Choose .

4.13.4.3 Deleting a Count Program

To delete a count program:

1. From the tree in the application rules side panel, choose Inventory > Count > Count Execution > Count Program. The Count Program List window displays with the list of existing programs.
2. Choose the Count Program that is to be deleted.
3. Choose .

4.13.5 Defining Count Modification Rules

The Sterling WMS runs tasks based on a blind count methodology initially. This methodology does not show the user the current system quantity. This methodology is the most accurate and exhaustive method to ensure that all users perform counts accurately.

These count tasks are run through RF, which allows for online inventory updates and the ability to interleave count tasks during the process of a regular workday.

In some warehouses, inventory is tracked at a tag number or serial number level. The count at these granular levels is cumbersome and requires opening of packages. In such situations, the Sterling WMS allows for counting without specifying these granular attributes. However, variance resolution of these tasks has to be done at the granular level.

Selling and Fulfillment Foundation supports modifications through the Console and APIs. It is critical for you to decide which modifications are allowed for each modification type, modification level, and status combination.

Important: Contemplate business and system integration implications before allowing a modification that is disallowed as part of the system defaults.

For more information about modification rules, see the *Sterling Distributed Order Management: Configuration Guide*.

4.13.5.1 Setting Up Count Modification Rules

To set up count modification rules:

1. From the tree in the application rules side panel, choose Inventory > Count > Count Execution > Count Modification Rules. The Modification Rules : Count Execution window displays.
2. In the Modification Rules : Count Execution window, select the Status of the Count Request whose Count Modification Rule is to be set. Refer [Table 4–34](#) for field value descriptions.
3. Choose to allow count modification. Choose to disallow count modification. Choose to ignore count modification.

For more information about defining and changing modification rules, see the *Sterling Distributed Order Management: Configuration Guide*.

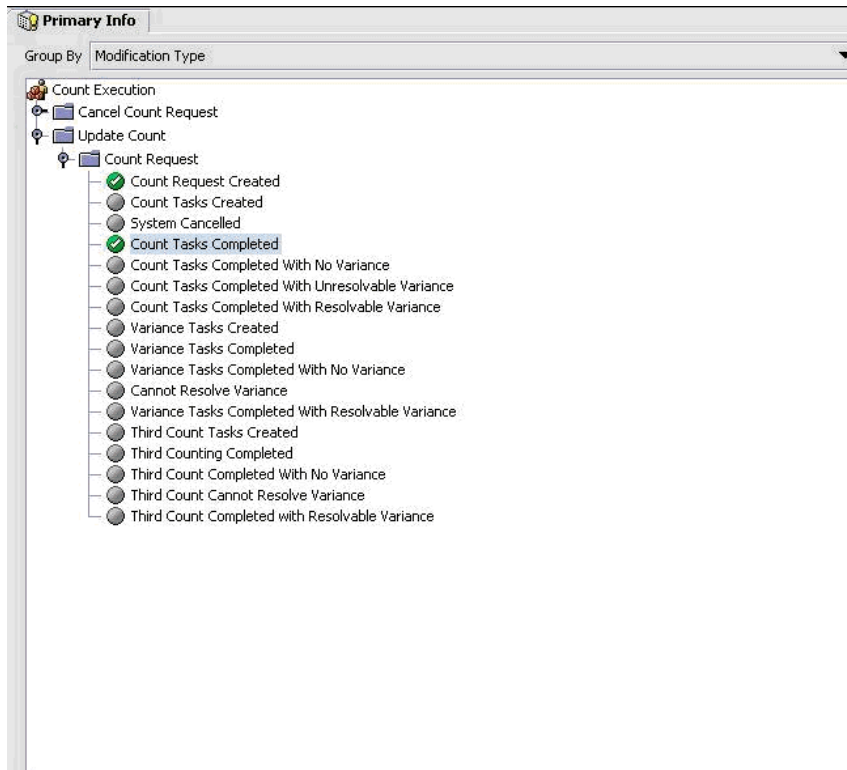

Table 4–34 Modification Rules : Count Execution Window

Field	Description
Primary Info	
Group by	View the Count Modification Rules grouped by Modification Type, Modification Level, or by Status.
Modification Type	Count Modification Rules grouped by Modification Type. Statuses display grouped by Modification Level for each Modification Type.
Cancel Count Request	Allow, Disallow, or Ignore cancellation of count request appropriately.
Update Count	Allows you to modify the count result.

Table 4–34 Modification Rules : Count Execution Window

Field	Description
Modification Level	Count Modification Rules grouped by Modification Level. Statuses display grouped by Modification Type for each Modification Level.
Count Request	Allow or Disallow or Ignore modification types at the count request level appropriately.
Update Count	Allows you to modify the count result.
Status	Count Modification Rules grouped by Status. Modification Types display grouped by Modification Level for each Status. For more information about group by status, see Section 4.13.7.6, "Statuses" on page 252.

For more information about modification rules, see the *Sterling Distributed Order Management: Configuration Guide*.

4.13.6 Defining Count Process Type Details

Count Process Type Details define parameters and templates that distinguish a process type.

A process type pipeline is a series of transactions and statuses that guide document types, such as Count, through a predefined process. A pipeline consists of the different statuses a document goes through during execution. You can also set up transactions consisting of events, actions, and conditions, as they pertain to the pipeline you are configuring.

Repositories

A repository is a logical collection of entities that define the business process workflow.

The following entities are included in a repository:

- Pipelines
- Transactions
- Statuses
- Conditions

- Actions
- Services

Selling and Fulfillment Foundation provides a base repository for each of the system-defined process types. Some of the entities within a repository are copied when creating a new document type. For more information about creating a new document type, see the *Selling and Fulfillment Foundation: Application Platform Configuration Guide*.

For more information about defining process type details, see the *Selling and Fulfillment Foundation: Application Platform Configuration Guide*.

4.13.6.1 Viewing Count Process Type Details

To view count process type details:

1. From the tree in the application rules side panel, choose Inventory > Count > Count Execution > Count Process Type Details. The Count Process Type Details : Count window displays.
2. Primary information of the Process Type displays in the applicable fields. Refer [Table 4–35](#) for field value descriptions.

For more information about defining the primary information for process type details, see the *Selling and Fulfillment Foundation: Application Platform Configuration Guide*.

Process Type Details : Count (DEFAULT)

Primary Info

Process Type: COUNT_EXECUTION Process Type Name: Count Execution

Description: Count Execution

Process Type Details : Count

Table 4–35 *Process Type Details: Count Window*

Field	Description
Primary Info	
Process Type	This is automatically populated by the system as "COUNT_EXECUTION".
Process Type Name	This indicates the name of the process type.
Description	This provides a brief description for the process type.

4.13.7 Defining Count Process Model

Process Modeling is the set up of business process workflow through a pipeline. A pipeline is a series of transactions and statuses that guide document types, such as Count, through a predefined process. A pipeline consists of different statuses a document goes through during count, variance processes. You can also setup transactions consisting of events, actions and conditions, as they pertain to the pipeline you are configuring.

4.13.7.1 Pipeline Determination

Pipeline determination is used to set up conditions that affect which pipeline is used during the start of the business process workflow. For example, a 3PL organization with multiple enterprises, one of which requires all count tasks with variance to be counted once more before variance is resolved. This organization is uniquely identified to an individual pipeline.

For more information about Pipeline Determination, see the *Selling and Fulfillment Foundation: Application Platform Configuration Guide*.

4.13.7.2 Hub Rule

When you expand the Pipeline Determination branch, the components display depends on what role you are logged in as. If you are logged in as a Hub role, the Hub Rule displays. If you are logged in as an Enterprise role, both the Hub Rule and all user created determination rules (For example, My Rule) components display. Double-click on the applicable rule to display the pipeline determination rules.

Note: If you are logged in as an Enterprise role, the Hub Rule screen is grayed out and cannot be modified.

Drag conditions and pipelines into the work area to construct pipeline determination rules. A single pipeline or condition must be the root. Conditions cannot link back to an earlier component in the chain and a pipeline cannot be linked to twice.

4.13.7.3 Condition Variables for Pipeline Determination

When using conditions for pipeline determination, the following condition variables can be used:

- Enterprise Code
- Request Type
- Count Program Name
- Node Key
- Zone ID
- Location Size Code
- Is LPN Level
- Is Case Level
- Is Pallet Level
- Is Item Level
- Is Resolvable
- Product Class
- Unit of Measure
- Item Classification 1
- Item Classification 2
- Item Classification 3
- Has Variance
- Has Absolute Variance
- Variance Quantity
- Absolute Variance Quantity
- Variance Value
- Absolute Variance Value
- Has Variance With Previous Count
- {Enter Your Own Attribute}

For more information about Pipeline Determination and Hub Rule, see the *Selling and Fulfillment Foundation: Application Platform Configuration Guide*.

4.13.7.4 Pipelines

For more information about Pipelines, see the *Selling and Fulfillment Foundation: Application Platform Configuration Guide*.

To view the count pipeline details:

1. From the tree in the application rules side panel, choose Inventory > Count > Count Execution > Count Process Model. The Count Execution window displays.

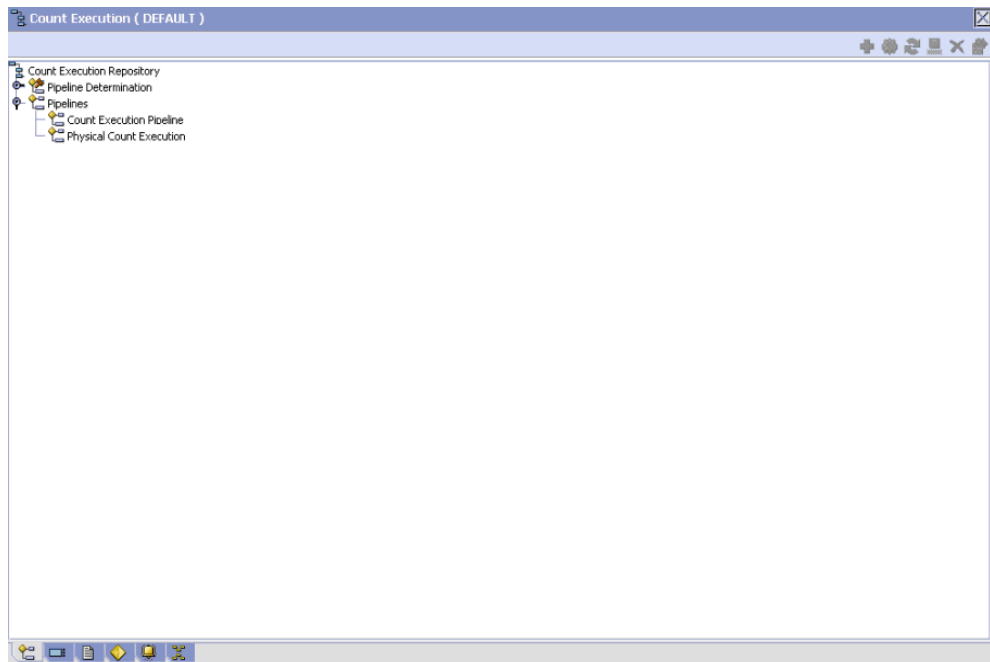

2. In the Count Execution window, choose Count Execution Repository > Pipelines > Count Execution Pipeline.
3. The Pipeline Detail: Count Execution Pipeline (Count Execution) window displays.

For more information about creating and modifying a pipeline, see the *Selling and Fulfillment Foundation: Application Platform Configuration Guide*.

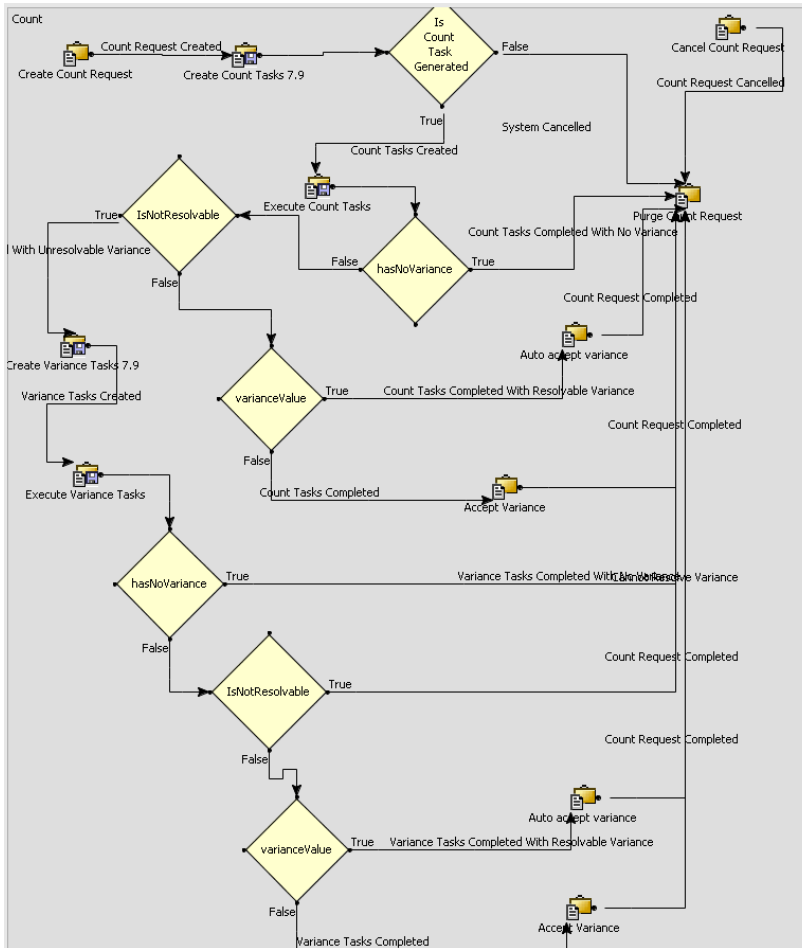

4.13.7.5 Transactions

Every process type has a set of base transactions defined for it. A transaction is a logical unit of work that is necessary for performing an activity within Selling and Fulfillment Foundation. Base transactions are predefined transactions that contain information about how the

transaction behaves, such as how many copies of a transaction can be kept in a process type and whether or not it can have configurable base pick and drop statuses. Base transactions can be used to create new transactions. These transactions can be changed within the limits defined in the base transaction.

For more information about transactions, see the *Selling and Fulfillment Foundation: Application Platform Configuration Guide*.

To view the transaction details for a count pipeline:

1. From the tree in the application rules side panel, choose Inventory > Count > Count Execution > Count Process Model. The Count Execution window displays.
2. In the Count Execution window, choose .
3. The Transactions tab window displays.

For more information about creating and modifying transactions, see the *Selling and Fulfillment Foundation: Application Platform Configuration Guide*.

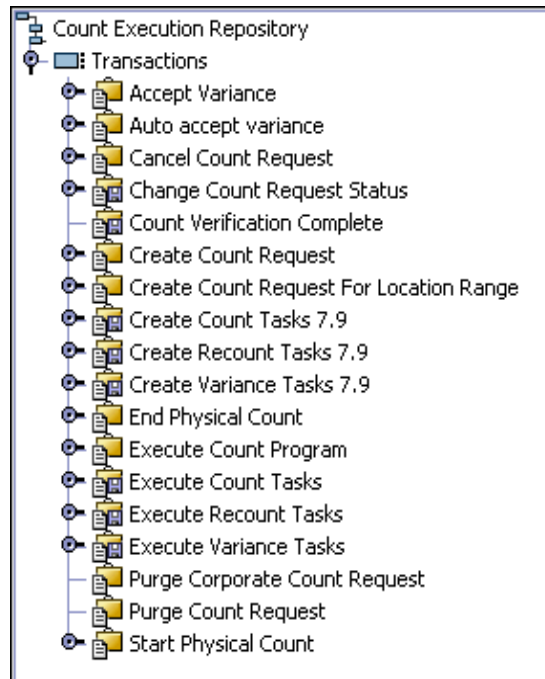

Note: The following transactions are available only if you upgrade from Sterling Supply Chain Applications:

- Create Count Tasks
- Create Third Count Tasks
- Create Variance Tasks
- Third Counting Complete
- Variance Tasks Complete

Table 4–36 *Count Execution Pipeline - Transactions Tab Window*

Field	Description
Accept Variance	This transaction represents the acceptance of the variance. Variance is accepted manually through the console.
Auto Accept Variance	This transaction represents the automatic acceptance of a variance based on attributes of the variance. For example, a warehouse allows variances to be automatically resolved when the variance value is below specific value or when variance quantity is below specific quantity for an item classification.
Cancel Count Request	This transaction represents the cancellation of a count request.
Change Count Request Status	This transaction represents the change of the count request status. The change is done either through other transactions, through console or RF.
Count Verification Complete	This transaction represents the verification of the final count results.
Count Tasks Complete	This transaction represents the completion of all count tasks for a count request.
Create Count Request	This transaction represents the creation of a count request.
Create Count Request For Location Range	This transaction represents the creation of a count request for a particular range of location.
Create Count Tasks	This transaction represents the creation of count tasks for a count request.

Table 4–36 Count Execution Pipeline - Transactions Tab Window

Field	Description
Create Count Tasks 7.9	This transaction represents the creation of count tasks for a count request.
Create Recount Tasks 7.9	This transaction represents the creation of recount tasks for a count request.
Create Third Count Tasks	This transaction represents the creation of third count tasks for a count request.
Create Variance Tasks	This transaction represents the creation of variance tasks after count has been completed at a location.
Create Variance Tasks 7.9	This transaction represents the creation of variance tasks after count has been completed at a location.
End Physical Count	This transaction represents the completion of physical count.
Execute Count Program	This transaction represents the execution of a count program.
Purge Corporate Count Request	This transaction represents the purging of one or more corporate count requests based on their status. For more information about corporate count request purge criteria, see Section 4.13.10, "Defining Corporate Count Request Purge Criteria" on page 271.
Purge Count Request	This transaction represents the purging of one or more count requests based on their status. For more information about purge criteria, see Section 4.13.9, "Defining Purge Criteria" on page 268.
Start Physical Count	This transaction represents the beginning of physical count.
Third Counting Complete	This transaction represents the completion of all third count tasks for a count request.
Variance Tasks Complete	This transaction represents the completion of all variance tasks for a count request.

4.13.7.6 Statuses

Statuses are the actual states that a document moves through in the pipeline. A transaction can contain two types of statuses, a drop status and a pickup status. A document is moved into a **drop status** when the events and conditions of a transaction have been completed. A **pickup**

status takes the document from the previous drop status and moves it through the next transaction. Created and Completed are examples of statuses.

For more information about Statuses, see the *Selling and Fulfillment Foundation: Application Platform Configuration Guide*.

To view the status details of a count pipeline:

1. From the tree in the application rules side panel, choose Inventory > Count > Count Execution > Count Process Model. The Count Execution window displays.
2. In the Count Execution window, choose .
3. The Statuses tab window displays.

For more information about creating and modifying a Status, see the *Selling and Fulfillment Foundation: Application Platform Configuration Guide*.

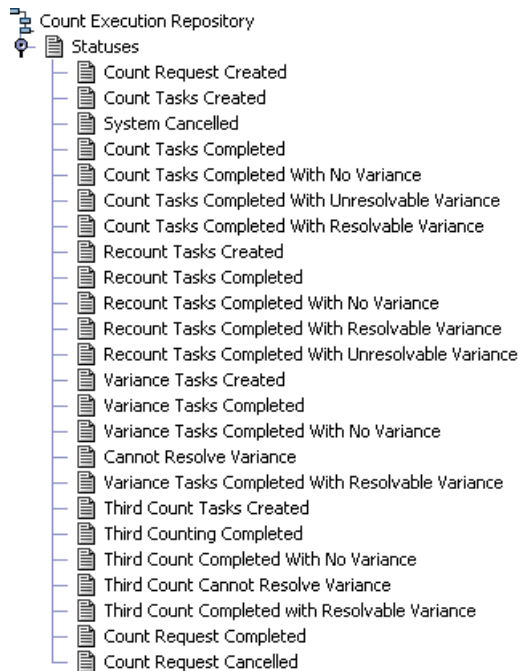

Table 4–37 Count Execution Pipeline - Statuses Tab Window

Field	Description
Count Request Created	This indicates that count request has been created. This corresponds to 'Create Count Request' transaction.
Count Tasks Created	This indicates that count tasks are created for the request. This corresponds to 'Create Count Tasks' transaction.
System Cancelled	This indicates that the count task generation has failed. This corresponds to 'Create Count Task' transaction.
Count Tasks Completed	This indicates that all count tasks for a count request are complete. This corresponds to 'Count Tasks Complete' transaction.
Count Tasks Completed With No Variance	This indicates that all count tasks for a count request are complete with no variance. This corresponds to 'Count Tasks Complete' transaction and 'HasNoVariance' condition.
Count Tasks Completed With Unresolvable Variance	This indicates that all count tasks for a count request are complete with unresolvable variance. This corresponds to 'Count Tasks Complete' transaction and 'IsNotResolvable' condition.
Count Tasks Completed With Resolvable Variance	This indicates that all count tasks for a count request are complete with resolvable variance. This corresponds to 'Count Tasks Complete' transaction and 'varianceValue' condition.
Recount Tasks Created	This indicates that recount tasks are created for the count request. This corresponds to 'Create Recount Tasks 7.9' transaction.
Recount Tasks Completed	This indicates that all recount tasks for a count request are complete. This corresponds to 'Recount Tasks Complete' transaction.

Table 4–37 Count Execution Pipeline - Statuses Tab Window

Field	Description
Recount Tasks Completed With No Variance	This indicates that all recount tasks for a count request are complete with no variance value. This corresponds to 'Recount Tasks Complete' transaction and 'HasNoVariance' condition
Recount Tasks Completed With Resolvable Variance	This indicates that all recount tasks for a recount request are complete with resolvable variance. This corresponds to 'Recount Tasks Complete' transaction and 'varianceValue' condition.
Recount Tasks Completed With Unresolvable Variance	This indicates that all recount tasks for a count request are complete with unresolvable variance. This corresponds to 'Recount Tasks Complete' transaction and 'IsNotResolvable' condition
Variance Task Created	This indicates that variance tasks are created for the count request. This corresponds to 'Create Variance Tasks' transaction.
Variance Tasks Completed	This indicates that all variance tasks for a count request are complete. This corresponds to 'Variance Tasks Complete' transaction.
Variance Tasks Completed With No Variance	This indicates that all variance tasks for a count request are complete with no variance value. This corresponds to 'Variance Tasks Complete' transaction and 'HasNoVariance' condition.
Cannot Resolve Variance	This indicates that variance tasks are marked as not resolvable. This corresponds to 'IsNotResolvable' condition being True.
Variance Tasks Completed With Resolvable Variance	This indicates that all variance tasks for a count request are complete with resolvable variance. This corresponds to 'Variance Tasks Complete' transaction and 'varianceValue' condition.
Third Count Tasks Created	This indicates that third count tasks are created for the request. This corresponds to 'Create Third Count Tasks' transaction.

Table 4–37 Count Execution Pipeline - Statuses Tab Window

Field	Description
Third Counting Completed	This indicates that all third count tasks for a count request are complete. This corresponds to 'Third Counting Complete' transaction.
Third Counting Completed With No Variance	This indicates that all third count tasks for a count request are complete with no variance. This corresponds to 'Third Counting Complete' transaction and 'HasNoVariance' condition.
Third Count Cannot Resolve Variance	This indicates that all third count tasks for a count request are complete with unresolvable variance. This corresponds to 'Third Counting Complete' transaction and 'IsNotResolvable' condition.
Third Count Completed With Resolvable Variance	This indicates that all third count tasks for a count request are complete with resolvable variance. This corresponds to 'Third Counting Complete' transaction and 'varianceValue' condition.
Count Request Completed	This indicates that all count and variance tasks for the count request are complete. This corresponds to 'Accept Variance', 'Auto Accept Variance' transactions and 'HasNoVariance' condition.
Count Request Cancelled	This indicates that count request is cancelled. This corresponds to 'Cancel Count Request' transaction.

4.13.7.7 Conditions

A **condition** matches document type attributes against decision points and routes the documents to different paths based on the specified attribute and value combinations. The document type attributes against which conditions can be created are predefined in Selling and Fulfillment Foundation. You can use these attributes in any combination or you can create conditions that run the appropriate application logic for specific circumstances.

For more information about Conditions, see the *Selling and Fulfillment Foundation: Application Platform Configuration Guide*.

To view the condition details of a count pipeline:

1. From the tree in the application rules side panel, choose Inventory > Count > Count Execution > Count Process Model. The Count Execution window displays.
2. In the Count Execution window, choose .
3. The Conditions tab window displays.

For more information about creating and modifying conditions, see the *Selling and Fulfillment Foundation: Application Platform Configuration Guide*.

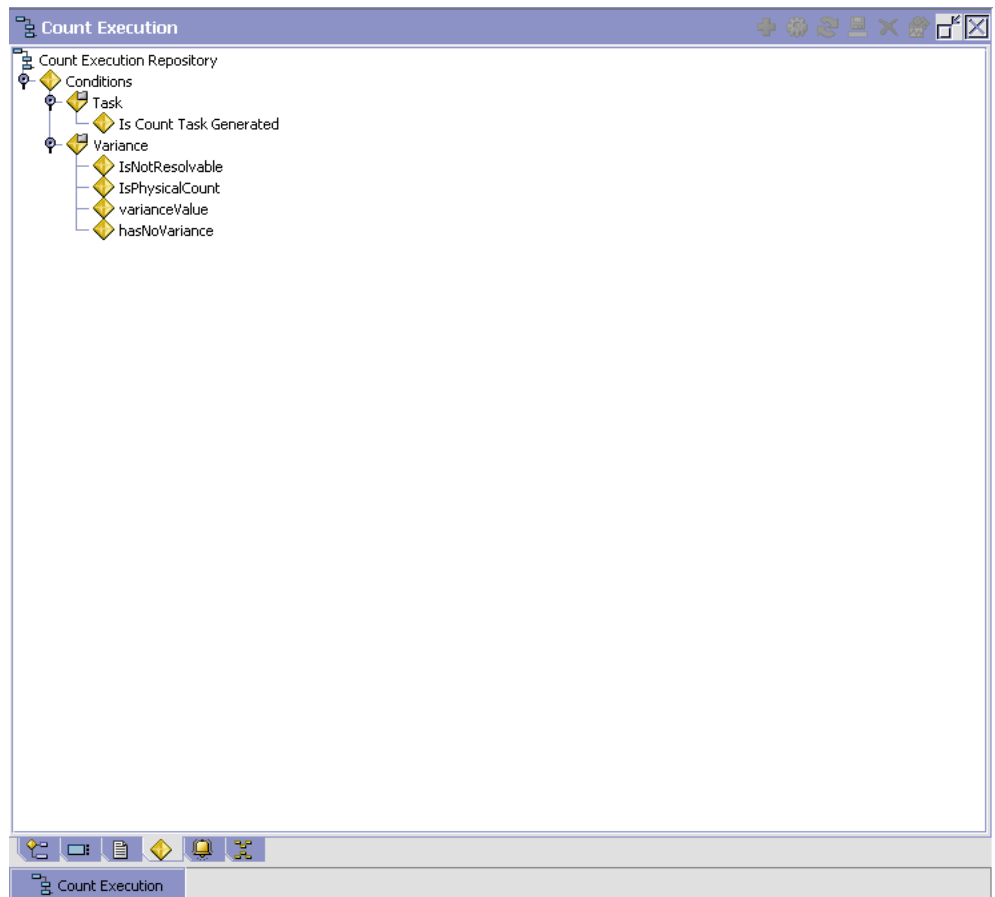

Table 4–38 Count Execution Pipeline - Conditions Tab Window

Field	Description
Task	
Is Count Task Generated	Condition that evaluates if the number of tasks for the count is greater than zero.
Variance	
IsNotResolvable	Condition that evaluates if the 'IsResolvable' field is 'N' for a count task.
IsPhysicalCount	Condition that evaluates if the Request Type is 'PHYSICAL-COUNT'.
VarianceValue	Condition that evaluates if the 'VarianceValue' field is less than 50 for the variance recorded.
HasNoVariance	Condition that evaluates if there is any variance.

4.13.7.8 Actions

An action is a process or program that is triggered by an event. These processes and programs send user alert notifications and automatically resolve issues.

For example, when a variance task is created (the event), you can set an action to send the enterprise user an e-mail.

For more information about Actions, see the *Selling and Fulfillment Foundation: Application Platform Configuration Guide*.

To view the action details of a count pipeline:

1. From the tree in the application rules side panel, choose Inventory > Count > Count Execution > Count Process Model. The Count Execution window displays.
2. In the Count Execution window, choose .
3. The Actions tab window displays.

For more information about creating and modifying Actions, see the *Selling and Fulfillment Foundation: Application Platform Configuration Guide*.

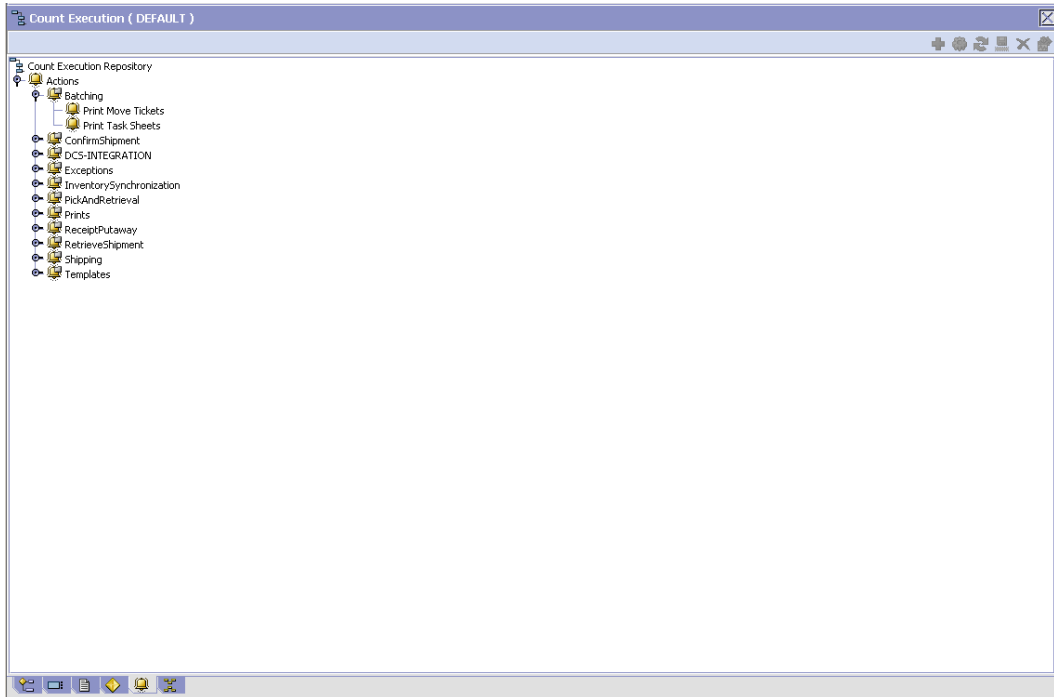

Table 4–39 *Count Execution Pipeline - Actions Tab Window*

Field	Description
Batching	Default settings are provided for: Print Move Tickets – Invokes the batch printing service for printing the move tickets. Print Task Sheets – Invokes the batch print service for printing the task sheets.
ConfirmShipment	Default settings are provided for: ConfirmShipment – Invokes the confirmShipment flow to confirm the shipment.

Table 4–39 Count Execution Pipeline - Actions Tab Window

Field	Description
DCS-Integration	<p>Default settings are provided for:</p> <p>InventoryDownload – Invokes the YantraWMSInventoryDownloadService service to download the inventory information from Selling and Fulfillment Foundation to DCS.</p> <p>PODownload – Invokes the YantraWMSPODownloadService service to download the Purchase Order information from Selling and Fulfillment Foundation to DCS.</p>
Exceptions	<p>Default settings are provided for:</p> <p>ShortagesDetected – Invokes the LogWavePlaFailure exception service when shortage of inventory occurs during wave release.</p>
InventorySynchronization	<p>Default settings are provided for:</p> <p>CollectInventoryMismatch – This service collects the inventory mismatch information between an external system and Selling and Fulfillment Foundation. This is typically caused when some inventory updates at a node or a warehouse are not reported to Selling and Fulfillment Foundation.</p>
PickAndRetrieval	<p>Default settings are provided for:</p> <p>ConfirmEmptyLocationAfterPick – Invokes the GenerateCountRequest flow which creates a count request.</p>

Table 4–39 Count Execution Pipeline - Actions Tab Window

Field	Description
Prints	<p>Default settings are provided for:</p> <p>PickList Print – Invokes the print service for printing the Pick List.</p> <p>LTL Manifest – Invokes the print service for printing the Less-than Truck Load Manifest.</p> <p>Print Load BOL – Invokes the print service for printing the Load Bill of Lading.</p> <p>Print PackList – Invokes the print service for printing the Pack List.</p> <p>Print Post Pick Container Labels – Invokes the print service for printing UCC-128 container labels for containers, when system defined packing process is used.</p> <p>Print Shipment BOL – Invokes the print service for printing the Shipment Bill of Lading.</p> <p>Print Shipping Label – Invokes the print service for printing the UCC-128 container labels.</p> <p>Print Wave – Invokes the Print service for printing a Wave.</p>
ReceiptPutaway	<p>Putaway products on receipt closure – Indicates the default action provided to automatically initiate putaway of purchase order receipts.</p>
RetrieveShipment	<p>Retrieve Requested Serial – This service invokes the retrieveShipment API to retrieve the requested serials to the specified location.</p>

Table 4–39 Count Execution Pipeline - Actions Tab Window

Field	Description
Shipping	<p>Default settings are provided for:</p> <p>Load Left Origin – Invokes the doLoadLeftOriginUpdates service to mark that the load has left the origin.</p> <p>Stop Shipping – Invokes the RaiseStopShippingAlert service to raise an alert to stop the processing of the shipment.</p>
Templates	<p>Default settings are provided for:</p> <p>Log Exception – Logs the reasons due to which a count request could not be created for a Count Program.</p> <p>Publish Data – Sends data to external queue or internal tables.</p> <p>Raise Exception – Raises an alert using Event Management from the published information.</p> <p>Send Email – Raises an email action to create an email in the template format from the published information.</p> <p>Send Email-HTML format – Raises an email action to create an email in HTML format from the published information.</p>

4.13.7.9 Service Definitions

Service definitions are a representation of the logic that regulates document workflow services. The Service Builder is a graphical interface that enables you to create a graphical representation of these *services*.

For more information about Service Definitions, see the *Selling and Fulfillment Foundation: Application Platform Configuration Guide*.

To view the service definition details of a count pipeline:

1. From the tree in the application rules side panel, choose Inventory > Count > Count Execution > Count Process Model. The Count Execution window displays.
2. In the Count Execution window, choose .
3. The Service Definitions tab window displays.

For more information about creating and modifying Service Definitions, see the *Selling and Fulfillment Foundation: Application Platform Configuration Guide*.

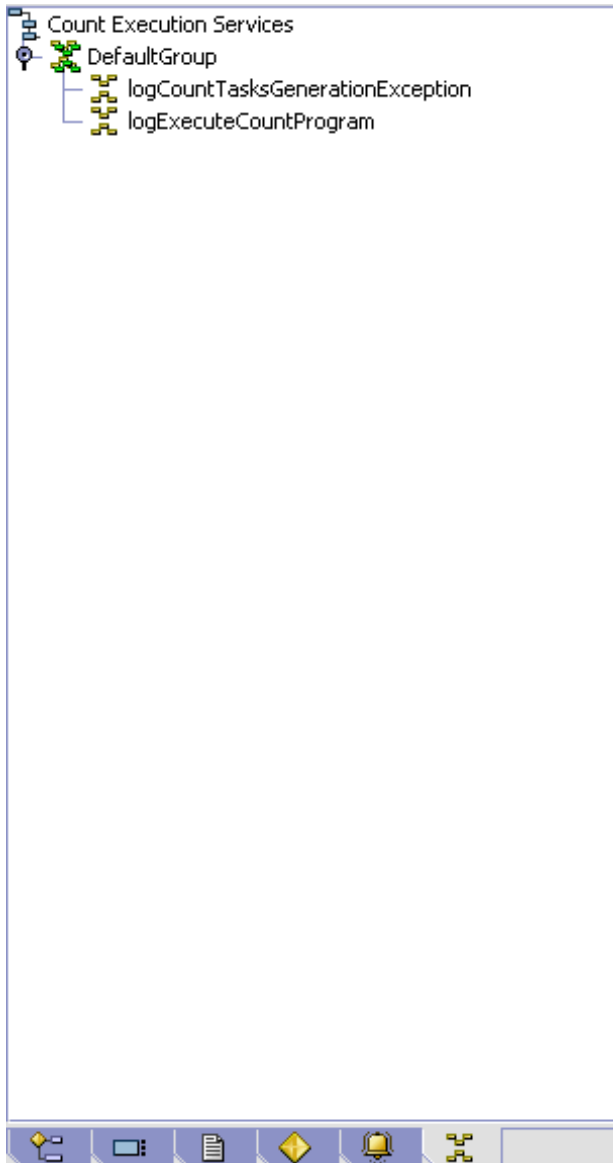

Table 4–40 Count Execution Pipeline - Service Definitions Tab Window

Field	Description
logCountTasksGeneration Exception	This service creates an exception when count task generation fails.
logExecuteCountProgram	This service creates an exception when no request is created during the execution of a count program.

4.13.8 Defining Count Strategy

Count Strategy defines the methodology to be followed while determining task type for count. The criteria used include zone, location size code, item classification, and the type of transaction requesting the task. A strategy uniquely defines each such combination.

For example, different task types can be configured to count hazardous zones and regular zones.

Use Count Strategy set-up for:

- [Setting Up a Count Strategy](#)
- [Modifying a Count Strategy](#)
- [Deleting a Count Strategy](#)

4.13.8.1 Setting Up a Count Strategy

To create a count strategy:

1. From the tree in the application rules side panel, choose Inventory > Count > Count Execution > Count Strategy. The Count Strategy Search window displays.

The screenshot shows two windows from a software application. The top window is titled "Count Strategy Search : Count (DEFAULT / MA03)". It contains several input fields: "Activity Group" (set to "COUNT"), "Location Size Code" (dropdown), "Request Type" (dropdown), "Max Records" (set to "200"), "Item Classification" (grouped box containing "NMFC Code" field), "Zone" (dropdown), "Transaction Id" (dropdown), and "Task Granularity" (dropdown). The bottom window is titled "Count Strategies" and displays a table with two columns: "Count Strategy Description" and "Task Type". The table is currently empty. Below the table, it shows "Results 0 Of 0".



2. In the Count Strategy Search window, choose . The Count Strategy Details pop-up window displays.
3. Enter information in the applicable fields. Refer [Table 4-41](#) for field value descriptions.
4. Choose .

Table 4–41 *Count Strategy Details Pop-up Window*

Field	Description
Activity Group	Activity group is populated automatically by the system. This indicates the system defined activity group that the task type belongs to. Every task type belongs to an activity group.
Count Strategy Description	Enter a description for the count strategy.
Zone	Choose the zone for the count strategy. This defines the zone for which the count request is created.
Location Size Code	Choose the location size code for the count strategy. This defines the capacity of the location for which the count strategy is created.
Transaction Id	Choose the transaction identifier for the count strategy. This defines the transaction id of the count request.



Table 4–41 Count Strategy Details Pop-up Window

Field	Description
Task Granularity	Choose the task granularity for the count strategy. This defines the task granularity for which the count strategy is created. Valid values are REQUEST and VARIANCE. Note: This drop-down field displays only when a transaction ID is selected.
Request Type	This defines the request type for the count. Typical values are Cycle Count and Physical Count.
Item Classification	This defines the item classification attributes for determining the count strategy. A maximum of three item classifications can be defined. An example, Product Line is shown below.
Task Type	Select the task type you want to use to count. Note: This field displays only when you select a transaction identifier suffixed with 7.9.
Put Location on count even if No Inventory	Select if locations in a zone are eligible for count even though the system does not have inventory in those locations. Note: This would be used for locations that are big and inventory movement from and to such locations are being done offline through paper. For example, sales floor location in a store.

4.13.8.2 Modifying a Count Strategy

Once a count strategy has been created, it can be modified.

To modify a count strategy:



1. From the tree in the application rules side panel, choose Inventory > Count > Count Execution > Count Strategy. The Count Strategy Search window displays.
2. Enter applicable search criteria, and choose . Refer [Table 4–41](#) for field value descriptions.
3. A list of Count Strategies displays in the Count Strategies panel.
4. Select the Count Strategy to be modified. Choose .

5. The Count Strategy Details pop-up window displays. Refer [Table 4–41](#) for field value descriptions.
6. Enter information in the applicable fields.
7. Choose .

All modifications are effective for future transactions only.

4.13.8.3 Deleting a Count Strategy

To delete a count strategy:

1. From the tree in the application rules side panel, choose Inventory > Count > Count Execution > Count Strategy. The Count Strategy Search window displays.
2. Enter applicable search criteria, and choose . Refer [Table 4–41](#) for field value descriptions.
3. A list of Count Strategies displays in the Count Strategies panel.
4. Select the Count Strategy to be deleted.
5. Choose .

4.13.9 Defining Purge Criteria

Transactional data collected by the Sterling WMS during execution are periodically removed from the "live" transactional tables. It is common to retain order related information for extended periods of time. There are history tables provided for relevant transactional tables to move data from the day-to-day "live" tables to a historical table.

Purge is the process by which old data is removed from the system database. A purge minimizes the number of unused database records to increase search efficiency and reduces the size of the required physical disk.

4.13.9.1 Setting Up Purge Criteria

To set up purge criteria:

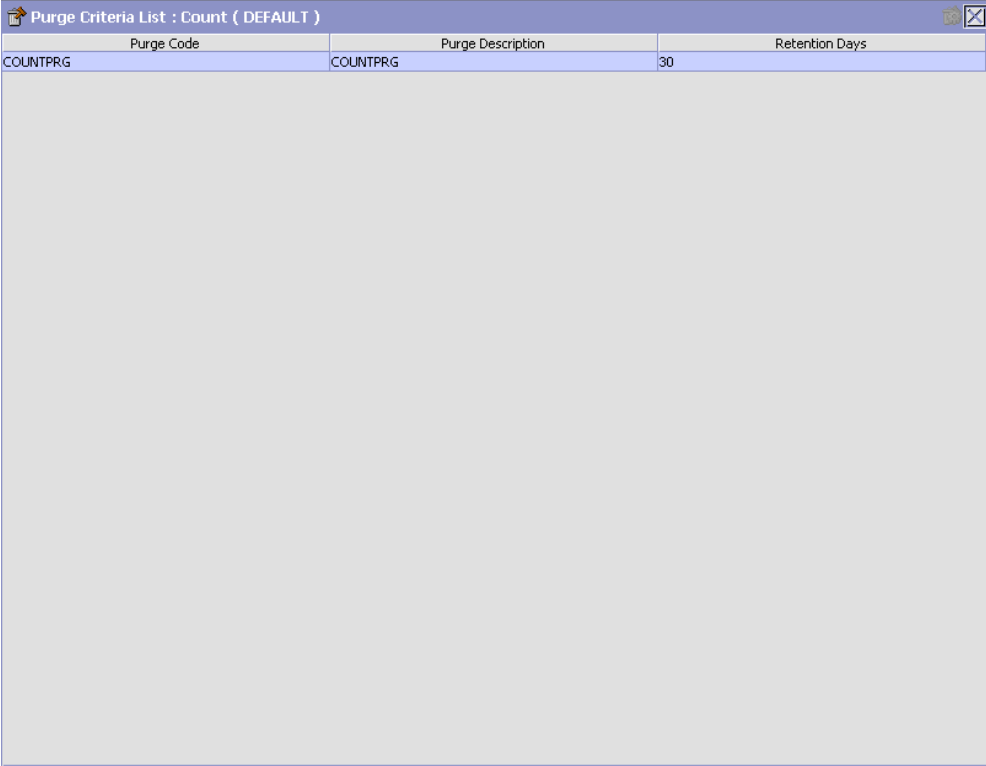

1. From the tree in the application rules side panel, choose Inventory > Count > Count Execution > Purge Criteria. The Purge Criteria List window displays.



The screenshot shows a window titled "Purge Criteria List : Count (DEFAULT)". It contains a table with three columns: "Purge Code", "Purge Description", and "Retention Days". The table has one row of data with the following values:

Purge Code	Purge Description	Retention Days
COUNTPRG	COUNTPRG	30

Below the table, there is a "Results 1" label and a status bar with the text "Purge Criteria List : Count (DEFAULT)".

2. In the Purge Criteria List window, choose . The Purge Criteria Details pop-up window displays.
3. Enter information in the applicable fields. Refer [Table 4–42](#) for field value descriptions.
4. Choose .

Purge Criteria Details

Purge Code: Description:

Rollback Segment: Retention Days:

Write To Log File Log File Name:

Table 4–42 Purge Criteria Details Pop-up Window

Field	Description
Purge Code	Identifies a purge program. This is a system defined code.
Description	Description of the purge.
Rollback Segment	Defines the rollback segment that should be explicitly used for the purge transaction qualified by the purge code. This is useful when there are huge logical data sets that have to be purged. This is optional and used for order related purges.
Retention Days	Enter the number of days of data to be retained in the database (going backwards from the time the program runs). Make sure that your table size takes into account the number of retention days entered here.

Table 4–42 Purge Criteria Details Pop-up Window

Field	Description
Write To Log File	Check this box if you want purged data written to a log. The log can be backed up and used as a journal at a later date.
Log File Name	<p>Enter a log file name. This is applicable only if 'Write To Log File' is checked. This file consists records of the specific table that is purged.</p> <p>The log file is created in the directory specified in the <code>yfs.purge.path</code> property. If this is not passed, it defaults to the value specified in the <code>yfs.properties</code> file. If a variable is introduced, then the <code>yfs.purge.path</code> is ignored. To modify this property, add an entry for it in the <code><INSTALL_DIR>/properties/customer_overrides.properties</code> file. For additional information about overriding properties using the <code>customer_overrides.properties</code> file, see the <i>Selling and Fulfillment Foundation: Properties Guide</i>.</p> <p>For information about file name limitations relating to internationalization, see the <i>Selling and Fulfillment Foundation: Localization Guide</i>.</p>

4.13.10 Defining Corporate Count Request Purge Criteria

Transactional data collected by the Sterling WMS during the execution are periodically removed from the "live" transactional tables. It is common to retain order related information for extended periods of time. There are history tables provided for relevant transactional tables to move data from the day-to-day "live" tables to a historical table.

Purge is the process by which old data is removed from the system database. A purge minimizes the number of unused database records to increase search efficiency and reduces the size of the required physical disk.

4.13.10.1 Setting Up Corporate Count Request Purge Criteria

To set up purge criteria:

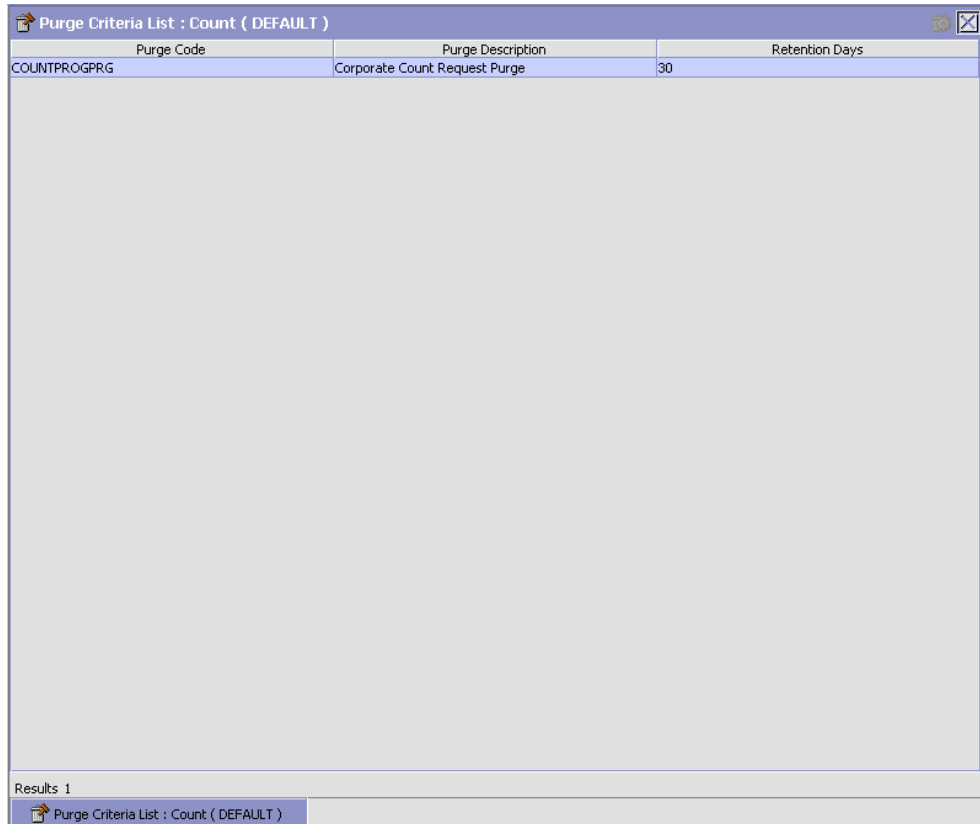

1. From the tree in the application rules side panel, choose Inventory > Count > Count Execution > Corporate Count Request Purge Criteria. The Purge Criteria List window displays.



The screenshot shows a window titled "Purge Criteria List : Count (DEFAULT)". It contains a table with the following data:

Purge Code	Purge Description	Retention Days
COUNTPROGPRG	Corporate Count Request Purge	30

Below the table, it says "Results 1". At the bottom of the window, there is a status bar with the text "Purge Criteria List : Count (DEFAULT)" and a save icon.

2. In the Purge Criteria List window, choose . The Purge Criteria Details pop-up window displays.
3. Enter information in the applicable fields. Refer [Table 4-42](#) for field value descriptions.
4. Choose .

5

Configuring Receiving

The process of receiving a product in the warehouse is based on the attributes of the shipment. The rules and activities expected to be performed for inventory being received is configured here.

Inventory is received in the warehouse either through a Purchase Order, Transfer Order or due to a Return. Typically, a transfer order is placed from another warehouse in the network, while purchase orders are received from outside vendors. The process of receiving product from diverse sources such as these differs in a warehouse.

The receiving configuration in a warehouse is broken up into the activities that are performed upon receipt, the method of putaway by utilizing warehouse, zone and item constraints.

The business processes to be followed are specified individually for Purchase Order, Transfer Order and Return Order. The process definitions include pipeline to be used, modification rules for orders and disposition codes.

Use Receiving for:

- [Defining Activities](#)
- [Defining Putaway Preferences](#)
- [Defining Purchase Order](#)
- [Defining Transfer Order](#)
- [Defining Return Order](#)
- [Defining Vendors](#)
- [Defining Location Storage Codes](#)
- [Defining Zone Constraints](#)

5.1 Defining Activities

Activities in the warehouse are grouped into Activity Groups. The Sterling WMS provides a pre defined set of activity groups for a warehouse. Examples of activity groups include Receiving, VAS, Picking and Packing.

Each activity group is associated with activity codes that define each activity that is performed. For example, receiving activity group has pre-receiving, Packing and receiving activities.

The list here is specific to the Receiving process.

Note: Activity Codes may be defined only when the WMS tree is loaded for Node / Hub combination.

Use Activities for:

- [Creating an Activity Code](#)
- [Modifying an Activity Code](#)
- [Deleting an Activity Code](#)

5.1.1 Creating an Activity Code

To create an activity code:

1. From the tree in the application rules side panel, choose Receiving > Activities. The Activities window displays.
2. Enter information in the applicable fields. Refer [Table 5–1](#) for field value descriptions.
3. Choose .

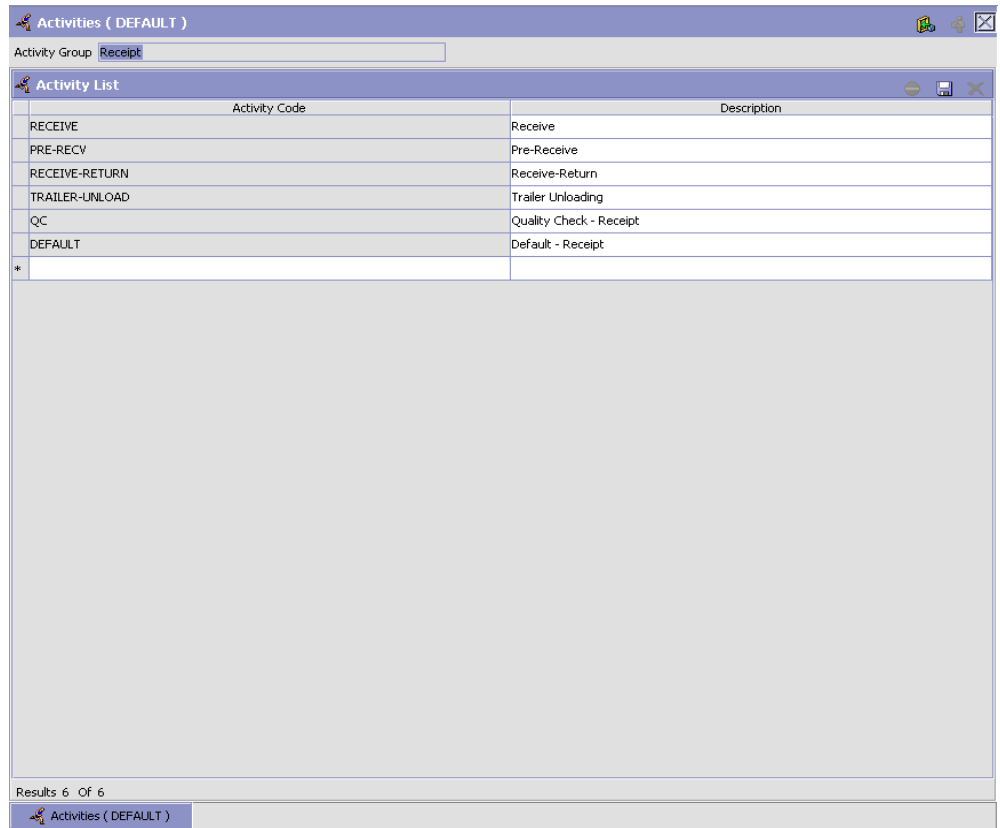



Table 5–1 Activities Window

Field	Description
Activity Group	This is automatically populated by the system as 'RECEIPT'.
Activity List	
Activity Code	Enter a name for the activity code. Activity code is the unique identity of the activity.
Description	Enter a brief description for the activity code.

5.1.2 Modifying an Activity Code

Once an activity code has been created, it can be modified.

To modify an activity code:

1. From the tree in the application rules side panel, choose Receiving > Activities. The Activities window displays, with the list of activities.
2. Enter information in the applicable fields. Refer [Table 5–1](#) for field value descriptions.
3. Choose .

It is recommended that the Sterling WMS-provided list of activity codes is not modified.

5.1.3 Deleting an Activity Code

To delete an activity code:

1. From the tree in the application rules side panel, choose Receiving > Activities. The Activities window displays, with the list of activities.
2. Choose the Activity Code to be deleted.
3. Choose .

It is recommended that the Sterling WMS-provided list of activity codes is not deleted.

5.2 Defining Putaway Preferences

Inventory being received at the dock require to be putaway to appropriate locations, based on shipment attributes, item classifications and location attributes.

The preferences for putting away of inventory is specified by zone and location storage attributes, for the SKU and container attributes.

Note: When configuring Putaway and Retrieval Preferences, do not select Zones containing "VIRTUAL" and "INTRANSIT" location type. However, you can select Zones containing "STAGING" location type only if it is associated with a station.

5.2.1 Selecting Putaway Preferences

The Sterling Warehouse Management System uses an algorithm to select the best storage or putaway preference for an activity from a list of preferences.

To select the best storage preference for an activity, the Sterling Warehouse Management System:

1. Determines if the inventory type is Single SKU, Multi SKU, or Unknown SKU.

If the inventory type is Single SKU, the system determines the corresponding UOM and item classification.

2. Determines the values of product class, inventory status, segment, or segment type for the inventory to match with the values configured in the storage preferences.
3. Sorts the matched values in the following order:
 - a. Enterprise Code
 - b. LPN Type
 - c. UOM
 - d. Product Class
 - e. Inventory Status
 - f. Segment Type
 - g. Segment
 - h. Item Classification 1
 - i. Item Classification 2
 - j. Item Classification 3

The best matched storage preference is used for the activity.

Use Putaway Preferences for:

- [Setting Up Putaway Preference for Single SKU](#)
- [Setting Up Putaway Preference for Multi-SKU/Multi-Level Container](#)
- [Setting Up Putaway Preference for Container with Unknown Contents](#)

5.2.2 Setting Up Putaway Preference for Single SKU

The preferences for the putaway of a single SKU are specified here.

For example, the putaway preference for a CASE, PALLET and loose quantity of a single SKU being putaway are specified here.

Use Putaway Preference for Single SKU set-up for:



- [Creating a Putaway Preference for Single SKU](#)
- [Creating a New Putaway Preference for Single SKU from an Existing Putaway Preference](#)
- [Modifying a Putaway Preference for Single SKU](#)
- [Deleting a Putaway Preference for Single SKU](#)

5.2.2.1 Creating a Putaway Preference for Single SKU

To create a putaway preference for single SKU:

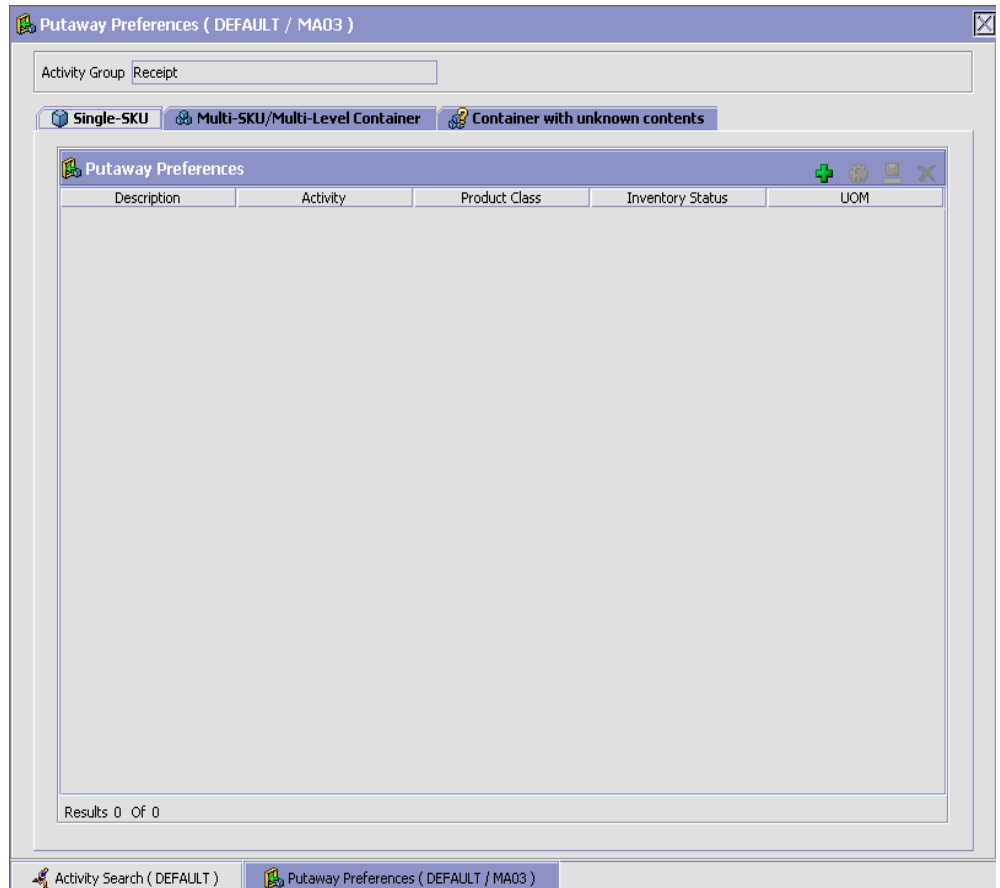
1. From the tree in the application rules side panel, choose Receiving > Putaway Preferences. The Putaway Preferences window displays.
2. Alternatively, choose  in the Activity Search window to access Putaway Preferences window.
3. In the Putaway Preferences window, choose the Single-SKU tab. The Single-SKU tab window displays.



4. In the Single-SKU tab window, choose .
5. The Putaway Preference Details window displays.
6. Enter information in the applicable fields. Refer [Table 5–2](#) for field value descriptions.
7. Choose .

Putaway Preference Details (SS-INV-ORG / FZ) : Single-SKU

Activity Group: Receipt To View Strategy Click here

Description:

Activity Code: Packing Product Class: SFC

Inventory Status: Normal Segment Type: MTO

Segment: UOM: PALLET

Container Type: Pallet Allow Split Pallet

Item Classification

Product Line:

StorageType:

Product Line:

Priority	Zone	Storage Code
*		

Results 0 Of 0

Putaway Preferences (SS-INV-ORG / FZ) Putaway Preference Details (SS-INV-ORG / FZ) : Single-SKU

Table 5–2 Putaway Preference Details Window (Single SKU)

Field	Description
Activity Group	This is automatically populated by the system as 'RECEIPT'.
To View Strategy Click here	Choose to view or set up Putaway Strategy. For more details about Setting Up Putaway Strategy, see Setting Up Putaway Strategy for Single-SKUs . Note: Putaway strategy may be specified for the putaway preferences after the preference is saved.

Table 5–2 Putaway Preference Details Window (Single SKU)

Field	Description
Description	Enter a brief description for the putaway preference.
Activity Code	Choose the Activity Code for the putaway preference. This is a mandatory field. Putaway looks for locations defined for "Moving to storage" or "On Close Receipt".
Product Class	Choose the product class for the preference, if applicable. Product class is the inventory classification of an item based on product's characteristics. Typical values are FQ - First Quality, SQ - Second Quality, etc.
Inventory Status	Choose the inventory status for the preference, if applicable. Inventory status refers to an inventory sub classification based on the results of the inventory control processes within the warehouse.
Segment Type	Enter the segment type for the preference, if applicable. This indicates an inventory category. Typical values are MTC – Made to Customer, and MTO - Made to Order.
Segment	Enter the segment number for the preference, if applicable. A segment holds either the specific buyer or specific order number that requires dedication.
UOM	Choose the UOM for the preference, if applicable. UOM points to the unit of measure of the item.
Container Type	The container type associated with the UOM selected displays. If the UOM is not selected, you can choose the container type for the preference, if applicable. Typical values are "Pallet" and "Case".

Table 5–2 Putaway Preference Details Window (Single SKU)

Field	Description
Allow Split Pallet	<p>Check this box to allow splitting of the pallet. You are allowed to configure this flag only if Container Type 'Pallet' is chosen in the putaway preference. Uncheck this flag in case you do not want Single SKU pallet to be split.</p> <p>Note: If the putaway preference for Container Type 'Pallet' is not configured, putaway algorithm will proceed with Single SKU putaway preference configured for blank container type and may split Single SKU pallet resulting in multiple putaway location suggestions.</p>
Item Classification	<p>List of putaway item classifications for the Enterprise display. An example, Product Line is shown below.</p>
Product Line	<p>Choose relevant product line item classification for the putaway activity.</p> <p>Choose . In the Classification window, select the applicable product line classification.</p>
Zone Priorities	
Priority	<p>Enter a number to represent the priority.</p> <p>The priority is used to sequence the order in which the zone priorities are evaluated. For example, all storage code level priorities are to be evaluated first before generic priorities.</p> <p>The priority needs to be a positive integer, greater than zero. This is mandatory.</p>
Zone	<p>Choose the relevant zone to be used as the target zone for putaway.</p> <p>This is a mandatory field.</p>
Storage Code	<p>Choose the storage code for the zone, if applicable.</p> <p>This limits the locations being evaluated to the storage code specified. For example, putaway of hazardous items into a zone are restricted to the locations having the appropriate storage code.</p>

Putaway strategy may be specified for the putaway preferences after the preference is saved. This is specified at an item classification and UOM level, if applicable.



Setting Up Putaway Strategy for Single-SKUs

You can set up putaway strategies to putaway applicable inventory received from a source zone to a target zone, based on the strategy specified.

To set up putaway strategy for single-SKUs:

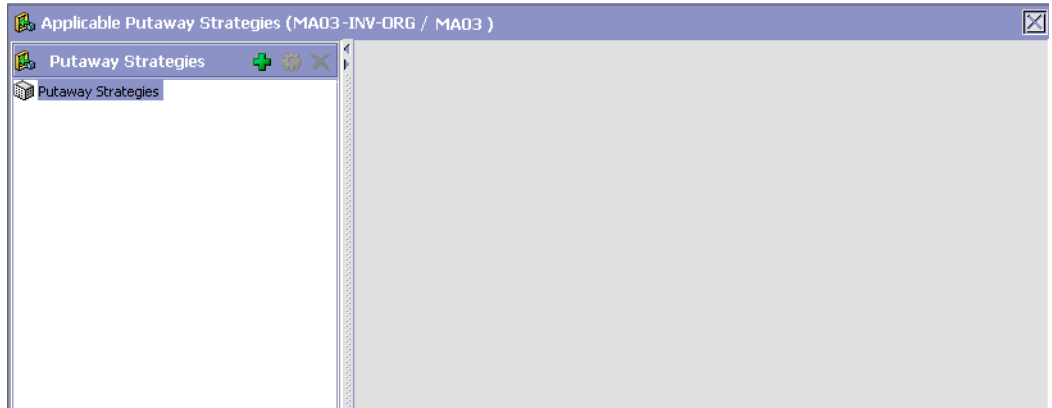
1. In the Putaway Preference Details : Single SKU window, choose .
2. The Applicable Putaway Strategies window is displayed.



3. Choose  in the Putaway Strategies panel. The Putaway Strategy Details window appears in the right panel.
4. Enter information in the applicable fields. See the Putaway Strategy Details Window table for field value descriptions.
5. Choose .

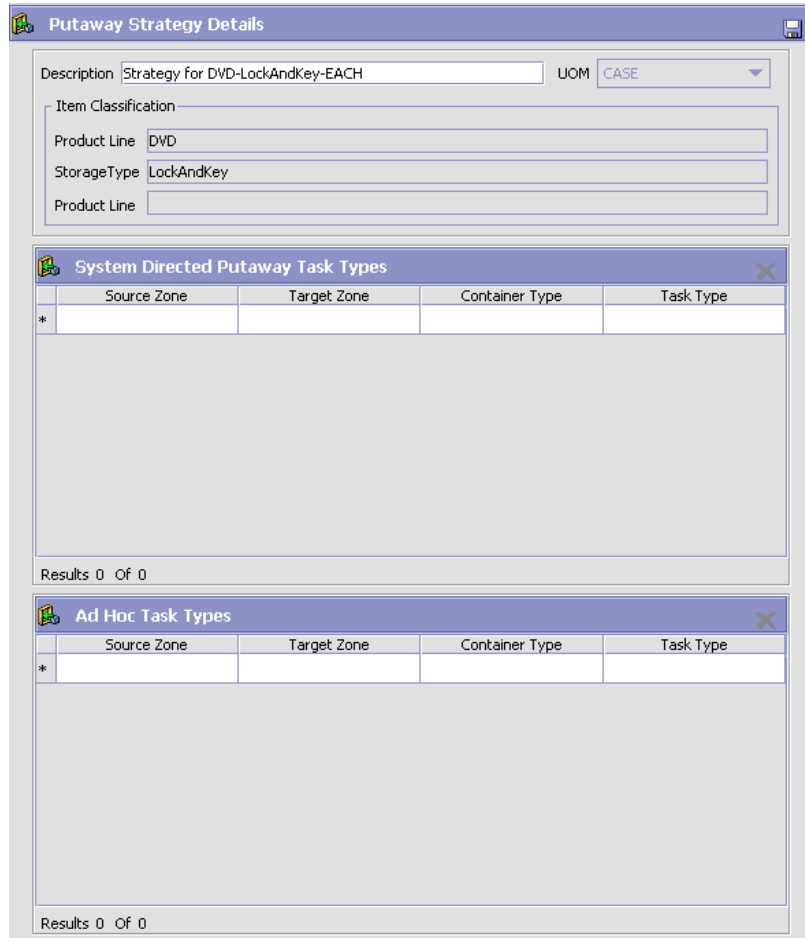

Table 5–3 Putaway Strategy Details Window

Field	Description
Description	Enter a description for the Putaway Strategy.
UOM	Select the UOM for the Putaway Strategy, if applicable. Note: The UOM will be defaulted in instances where it has been specified in the Putaway Preference Details screen.

Table 5–3 Putaway Strategy Details Window







Field	Description
Item Classification	List of putaway item classifications for the Enterprise are displayed. An example, Product Line is shown below.
Product Line	Choose relevant product line item classification for the putaway activity. Choose  . In the Classification Values window, select the applicable product line classification.
System Directed Putaway Task Types	Displays the list of existing system directed putaway task types. You may use  to delete an existing system directed putaway task type.
Source Zone	Select the source zone from where the inventory is sourced.
Target Zone	Select the target zone to where the inventory is moved.
Container Type	Select the container type to be used to move the inventory from the source zone to the target zone. Typical values are Case and Pallet.
Task Type	Select the Putaway Task Type applicable to this putaway strategy. This field displays the list of existing system directed task types that belong to the 'PUTAWAY' activity group.
Ad hoc Task Types	Displays the list of existing ad hoc task types. You may use  to delete an existing ad hoc task type.
Source Zone	Select the source zone from where the inventory is sourced.
Target Zone	Select the target zone to where the inventory is moved.

Table 5–3 Putaway Strategy Details Window

Field	Description
Container Type	Select the container type to be used to move the inventory from the source zone to the target zone. Typical values are Case and Pallet.
Task Type	Select the Putaway Task Type applicable to this putaway strategy. This field displays the list of existing ad hoc task types that belong to the 'PUTAWAY' activity group.

5.2.2.2 Creating a New Putaway Preference for Single SKU from an Existing Putaway Preference

To create a new putaway preference for single SKU from an existing putaway preference:



1. From the tree in the application rules side panel, choose Receiving > Putaway Preferences. The Putaway Preferences window displays.
2. Alternatively, choose  in the Activity Search window to access Putaway Preferences window.
3. In the Putaway Preferences window, choose the Single-SKU tab.
4. The Single-SKU tab window displays, with the list of putaway preferences.
5. Select the putaway preference to be copied from. Choose .
6. The Putaway Preference Details window displays.
7. Enter information in the applicable fields. Refer [Table 5–2](#) for field value descriptions.
8. Choose .

5.2.2.3 Modifying a Putaway Preference for Single SKU

Once a Putaway Preference for Single SKU has been created, it can be modified.

To modify a putaway preference for single SKU:



1. From the tree in the application rules side panel, choose Receiving > Putaway Preferences. The Putaway Preferences window displays.

2. Alternatively, choose  in the Activity Search window to access Putaway Preferences window.
3. In the Putaway Preferences window, choose the Single-SKU tab.
4. The Single-SKU tab window displays, with the list of putaway preferences.
5. Select the putaway preference to be modified. Choose .
6. The Putaway Preference Details window displays.
7. Enter information in the applicable fields. Refer [Table 5–2](#) for field value descriptions.
8. Choose .

Only the description and item classification values not previously used may be specified. Additional zone priorities may also be specified. For all other changes, the preference must be deleted.

5.2.2.4 Deleting a Putaway Preference for Single SKU

To delete a putaway preference for single SKU:

1. From the tree in the application rules side panel, choose Receiving > Putaway Preferences. The Putaway Preferences window displays.
2. Alternatively, choose  in the Activity Search window to access Putaway Preferences window.
3. In the Putaway Preferences window, choose the Single-SKU tab.
4. The Single-SKU tab window displays, with the list of putaway preferences.
5. Select the putaway preference to be deleted.
6. Choose .

5.2.3 Setting Up Putaway Preference for Multi-SKU/Multi-Level Container

The preferences for the putaway of a multi-level case or pallet are specified here. This also applies to multi-SKU CASE with LPN and PALLET with LPN.

Use the Putaway Preference for Multi-SKU/Multi-Level Container set-up for:

- [Creating a Putaway Preference for Multi-SKU/Multi-Level Container](#)
- [Creating a New Putaway Preference for Multi-SKU/Multi-Level Container from an Existing Putaway Preference](#)
- [Modifying a Putaway Preference for Multi-SKU/Multi-Level Container](#)
- [Deleting a Putaway Preference for Multi-SKU/Multi-Level Container](#)

5.2.3.1 Creating a Putaway Preference for Multi-SKU/Multi-Level Container

To create a putaway preference for multi-SKU/multi-level container:

1. From the tree in the application rules side panel, choose Receiving > Putaway Preferences. The Putaway Preferences window displays.
2. Alternatively, choose  in the Activity Search window to access Putaway Preferences window.
3. In the Putaway Preferences window, choose the Multi-SKU/Multi-Level Container tab. The Multi-SKU/Multi-Level Container tab window displays.

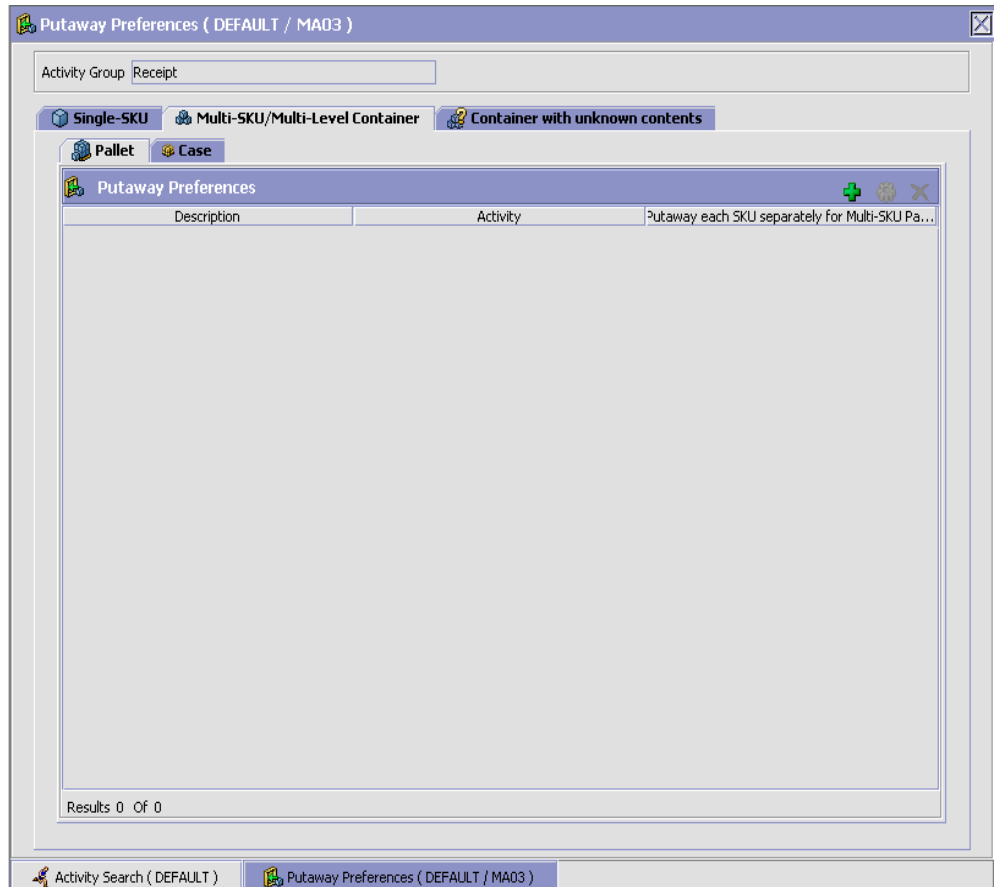



Putaway preferences for multi-level cases or pallets are specified separately:

- [Setting Up Putaway Preference for a Multi-Level Pallet](#)
- [Setting Up Putaway Preference for a Multi-Level Case](#)

5.2.3.1.1 Setting Up Putaway Preference for a Multi-Level Pallet

To set up putaway preference for a multi-level pallet:

1. In the Multi-SKU/Multi-Level Container tab of Putaway Preferences window, choose the Pallet tab. The Pallet tab window displays.

2. In the Pallet tab window, choose .
3. The Putaway Preference Details window displays.
4. Enter information in the applicable fields. Refer [Table 5–4](#) for field value descriptions.
5. Choose .

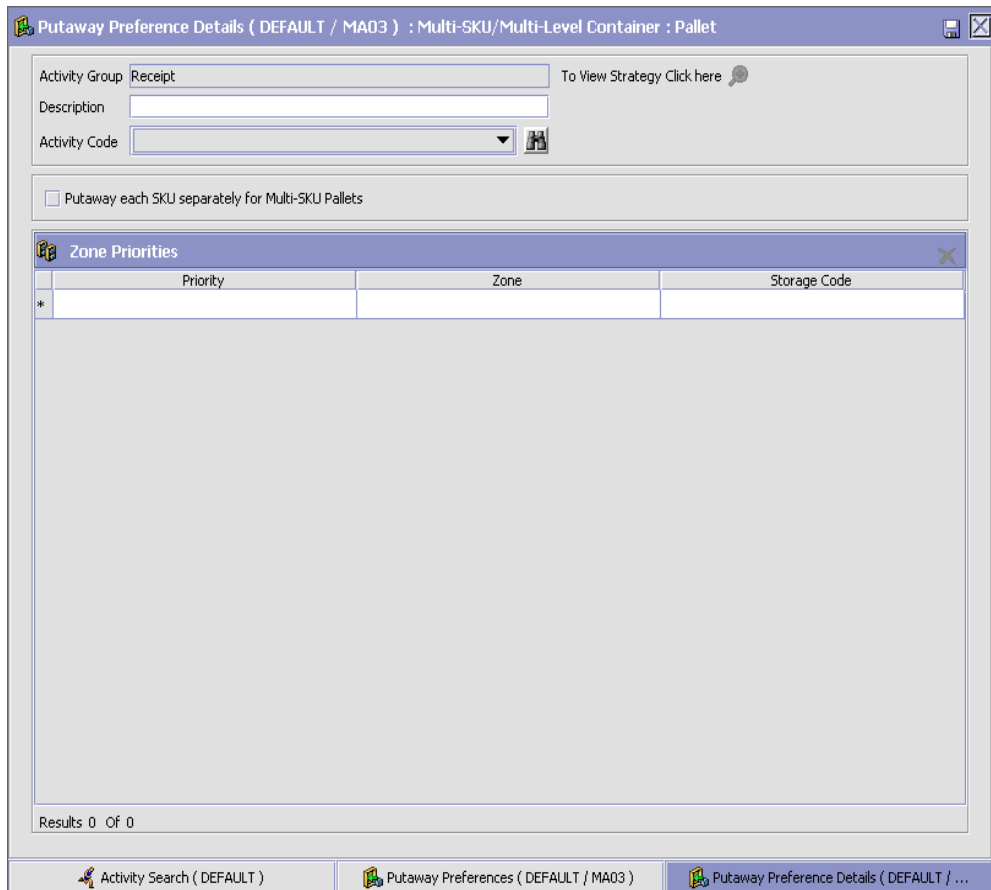

Putaway Preference Details (DEFAULT / MA03) : Multi-SKU/Multi-Level Container : Pallet

Activity Group To View Strategy Click here 

Description

Activity Code 

Putaway each SKU separately for Multi-SKU Pallets

Priority	Zone	Storage Code
*		

Results 0 Of 0

Activity Search (DEFAULT) Putaway Preferences (DEFAULT / MA03) Putaway Preference Details (DEFAULT / ...

Table 5–4 Putaway Preference Details Window (Multi-Level Pallet)

Field	Description
Activity Group	This is automatically populated by the system as 'RECEIPT'.
To View Strategy Click here	Choose  to view or set up Putaway Strategy. For more details about Setting Up Putaway Strategy, see Setting Up Putaway Strategy for Multi-SKU/Multi-Level Containers - Pallets . Note: Putaway strategy may be specified for the putaway preferences after the preference is saved.
Description	Enter a brief description for the putaway preference.
Activity Code	Choose the Activity Code for the putaway preference. This is a mandatory field.
Put away each SKU separately for Multi-SKU Pallets	Select if each SKU on the multi-SKU pallet is evaluated individually. If selected, the putaway preferences for a single SKU are evaluated for the multi-SKU pallet. The Zone Priorities Panel is removed on this selection.
Zone Priorities	
Priority	Enter a number to represent the priority. The priority is used to sequence the order in which the zone priorities are evaluated. For example, all storage code level priorities are to be evaluated first before generic priorities. The priority needs to be a positive integer, greater than zero. This is mandatory.
Zone	Choose the relevant zone for putaway. This is a mandatory field.
Storage Code	Choose the storage code for the zone, if applicable. This limits the locations being evaluated to the storage code specified. For example, putaway of hazardous items into a zone are restricted to the locations having the appropriate storage code.

Putaway strategy may be specified for the putaway preferences after the preference is saved. This is specified at an item classification and UOM level, if applicable.



Setting Up Putaway Strategy for Multi-SKU/Multi-Level Containers - Pallets

You can set up putaway strategies to putaway applicable inventory from a source zone to a target zone, based on the strategy specified.

To set up putaway strategy for multi-SKU/multi-level container pallets:

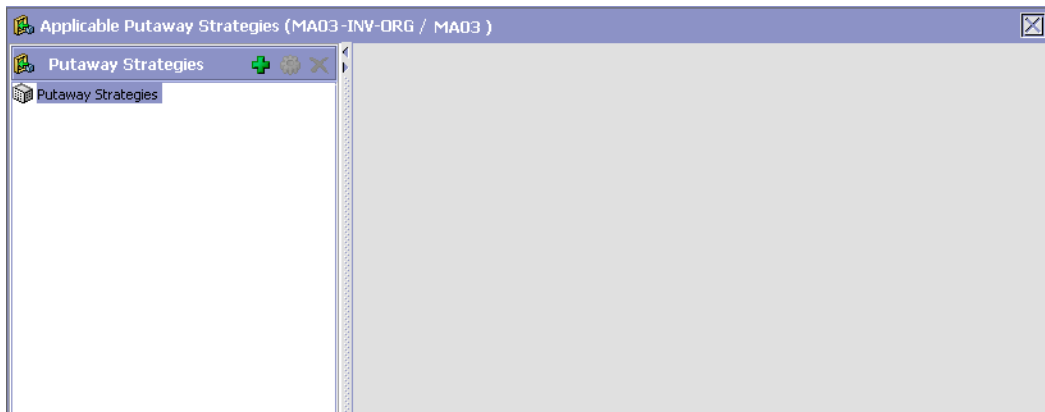
1. In the Putaway Preference Details : Multi-SKU/multi-level Containers : Pallet window, choose .
2. The Applicable Putaway Strategies window is displayed.



3. Choose  in the Putaway Strategies panel. The Putaway Strategy Details window appears in the right panel.
4. Enter information in the applicable fields. See the Putaway Strategy Details Window table for field value descriptions.
5. Choose .

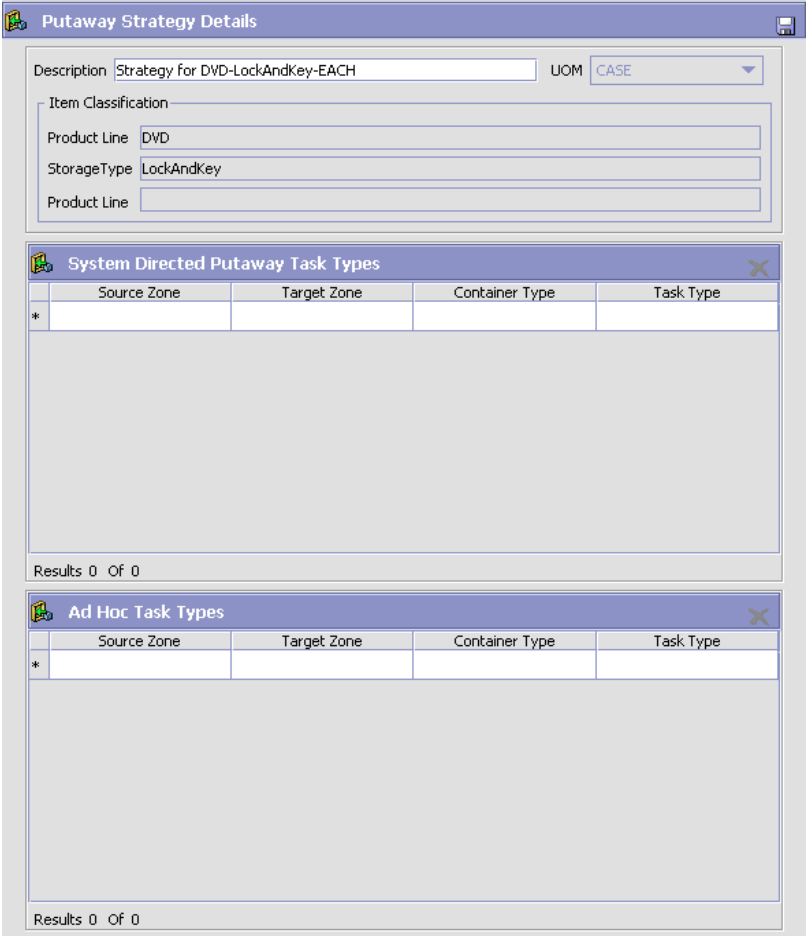

Table 5-5 Putaway Strategy Details Window

Field	Description
Description	Enter a description for the Putaway Strategy.
UOM	Select the UOM for the Putaway Strategy, if applicable. Note: The UOM will be defaulted in instances where it has been specified in the Putaway Preference Details screen.

Table 5–5 Putaway Strategy Details Window



Field	Description
Item Classification	List of putaway item classifications for the Enterprise are displayed. An example, Product Line is shown below.
Product Line	Choose relevant product line item classification for the putaway activity. Choose  . In the Classification Values window, select the applicable product line classification.
System Directed Putaway Task Types	Displays the list of existing system directed putaway task types. You may use  to delete an existing system directed putaway task type.
Source Zone	Select the source zone from where the inventory is sourced.
Target Zone	Select the target zone to where the inventory is moved.
Container Type	Select the container type to be used to move the inventory from the source zone to the target zone. Typical values are Case and Pallet.
Task Type	Select the Putaway Task Type applicable to this putaway strategy. This field displays the list of existing system directed task types that belong to the 'PUTAWAY' activity group.
Ad hoc Task Types	Displays the list of existing ad hoc task types. You may use  to delete an existing ad hoc task type.
Source Zone	Select the source zone from where the inventory is sourced.
Target Zone	Select the target zone to where the inventory is moved.

Table 5–5 Putaway Strategy Details Window



Field	Description
Container Type	Select the container type to be used to move the inventory from the source zone to the target zone. Typical values are Case and Pallet.
Task Type	Select the Putaway Task Type applicable to this putaway strategy. This field displays the list of existing ad hoc task types that belong to the 'PUTAWAY' activity group.

5.2.3.1.2 Setting Up Putaway Preference for a Multi-Level Case

To set up putaway preference for a multi-level case:

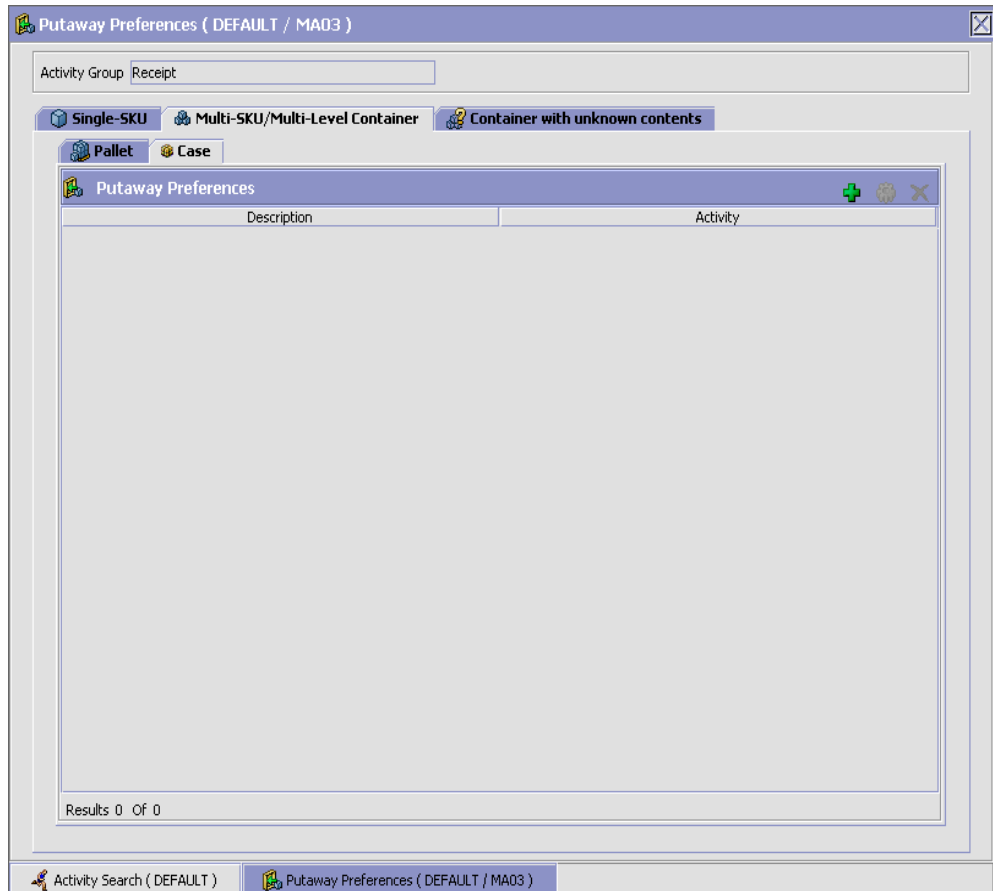
1. In the Multi-SKU/Multi-Level Container tab of Putaway Preferences window, choose the Case tab. The Case tab window displays.



2. In the Case tab window, choose .
3. The Putaway Preference Details window displays.
4. Enter information in the applicable fields. Refer [Table 5–6](#) for field value descriptions.
5. Choose .

Putaway Preference Details (DEFAULT / MA03) : Multi-SKU/Multi-Level Container : Case

Activity Group: Receipt To View Strategy Click here

Description:

Activity Code:

Zone Priorities

	Priority	Zone	Storage Code
*			

Results 0 Of 0

Activity Search (DEFAULT) Putaway Preferences (DEFAULT / MA03) Putaway Preference Details (DEFAULT / ...

Table 5–6 Putaway Preference Details Window (Multi-Level Case)

Field	Description
Activity Group	This is automatically populated by the system as 'RECEIPT'.
To View Strategy Click here	Choose  to view or set up Putaway Strategy. For more details about Setting Up Putaway Strategy, see Setting Up Putaway Strategy for Multi-SKU/Multi-Level Containers - Cases . Note: Putaway strategy may be specified for the putaway preferences after the preference is saved.
Description	Enter a brief description for the putaway preference.
Activity Code	Choose the Activity Code for the putaway preference. This is a mandatory field.
Zone Priorities	
Priority	Enter a number to represent the priority. The priority is used to sequence the order in which the zone priorities are evaluated. For example, all storage code level priorities are to be evaluated first before generic priorities. The priority needs to be a positive integer, greater than zero. This is mandatory.
Zone	Choose the relevant zone for putaway. This is a mandatory field.
Storage Code	Choose the storage code for the zone, if applicable. This limits the locations being evaluated to the storage code specified. For example, putaway of hazardous items into a zone are restricted to the locations having the appropriate storage code.

Putaway strategy may be specified for the putaway preferences after the preference is saved. This is specified at an item classification and UOM level, if applicable.



Setting Up Putaway Strategy for Multi-SKU/Multi-Level Containers - Cases

You can set up putaway strategies to putaway applicable inventory from a source zone to a target zone, based on the strategy specified.

To set up putaway strategy for multi-SKU/multi-level container cases:

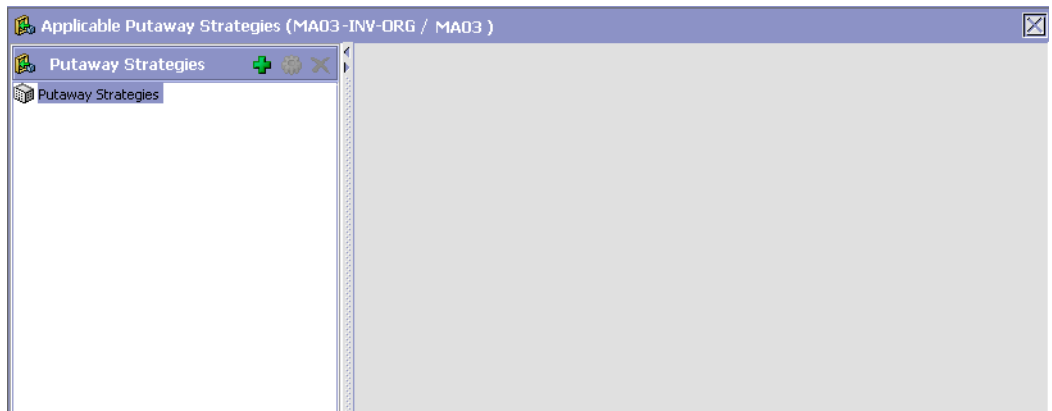
1. In the Putaway Preference Details : Multi-SKU/multi-level Containers : Case window, choose .
2. The Applicable Putaway Strategies window is displayed.



3. Choose  in the Putaway Strategies panel. The Putaway Strategy Details window appears in the right panel.
4. Enter information in the applicable fields. See the Putaway Strategy Details Window table for field value descriptions.
5. Choose .

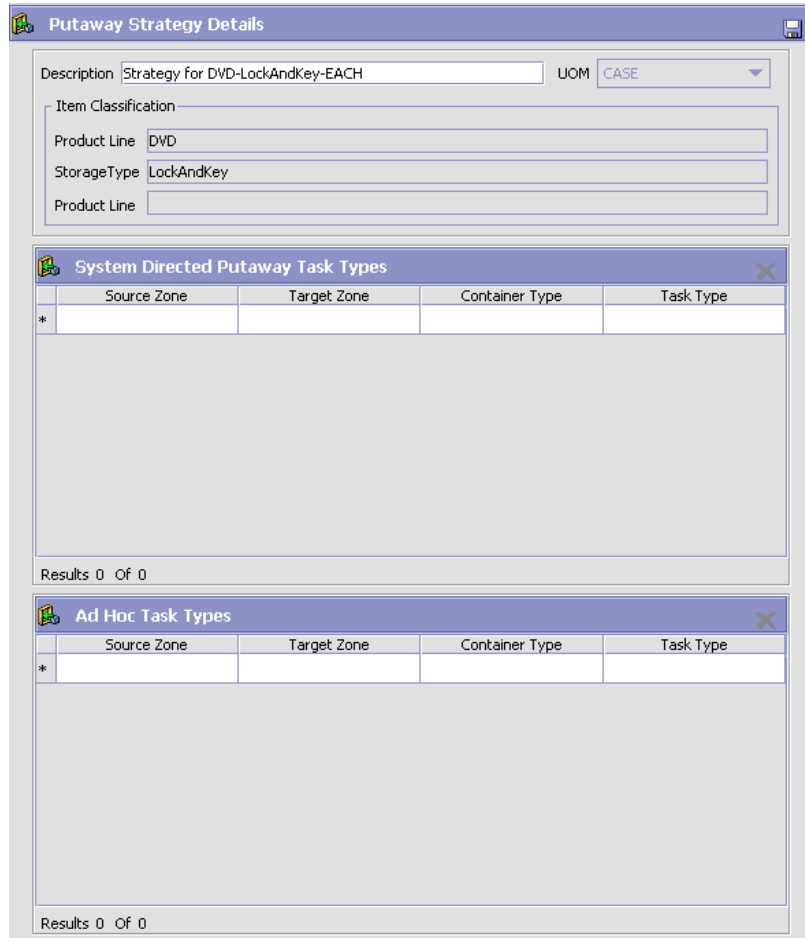

Table 5–7 Putaway Strategy Details Window

Field	Description
Description	Enter a description for the Putaway Strategy.
UOM	Select the UOM for the Putaway Strategy, if applicable. Note: The UOM will be defaulted in instances where it has been specified in the Putaway Preference Details screen.

Table 5–7 Putaway Strategy Details Window







Field	Description
Item Classification	List of putaway item classifications for the Enterprise are displayed. An example, Product Line is shown below.
Product Line	Choose relevant product line item classification for the putaway activity. Choose  . In the Classification Values window, select the applicable product line classification.
System Directed Putaway Task Types	Displays the list of existing system directed putaway task types. You may use  to delete an existing system directed putaway task type.
Source Zone	Select the source zone from where the inventory is sourced.
Target Zone	Select the target zone to where the inventory is moved.
Container Type	Select the container type to be used to move the inventory from the source zone to the target zone. Typical values are Case and Pallet.
Task Type	Select the Putaway Task Type applicable to this putaway strategy. This field displays the list of existing system directed task types that belong to the 'PUTAWAY' activity group.
Ad hoc Task Types	Displays the list of existing ad hoc task types. You may use  to delete an existing ad hoc task type.
Source Zone	Select the source zone from where the inventory is sourced.
Target Zone	Select the target zone to where the inventory is moved.

Table 5–7 Putaway Strategy Details Window

Field	Description
Container Type	Select the container type to be used to move the inventory from the source zone to the target zone. Typical values are Case and Pallet.
Task Type	Select the Putaway Task Type applicable to this putaway strategy. This field displays the list of existing ad hoc task types that belong to the 'PUTAWAY' activity group.

5.2.3.2 Creating a New Putaway Preference for Multi-SKU/Multi-Level Container from an Existing Putaway Preference



To create a new putaway preference for multi-SKU/multi-level container from an existing putaway preference:

1. From the tree in the application rules side panel, choose Receiving > Putaway Preferences. The Putaway Preferences window displays.
2. Alternatively, choose  in the Activity Search window to access Putaway Preferences window.
3. In the Putaway Preferences window, choose the Multi-SKU/Multi-Level Container tab.
4. The Multi-SKU/Multi-Level Container tab window displays, with the list of putaway preferences.
5. Select the putaway preference to be copied. Choose .
6. The Putaway Preference Details window displays.
7. Enter information in the applicable fields. For more information about modifying the fields, refer to [Section 5.2.3.1.1, "Setting Up Putaway Preference for a Multi-Level Pallet"](#) on page 289 and [Section 5.2.3.1.2, "Setting Up Putaway Preference for a Multi-Level Case"](#) on page 295.
8. Choose .

5.2.3.3 Modifying a Putaway Preference for Multi-SKU/Multi-Level Container

Once a Putaway Preference for Multi-SKU/Multi-Level Container has been created, it can be modified.

To modify a putaway preference for multi-SKU/multi-level container:

1. From the tree in the application rules side panel, choose Receiving > Putaway Preferences. The Putaway Preferences window displays.
2. Alternatively, choose  in the Activity Search window to access Putaway Preferences window.
3. In the Putaway Preferences window, choose the Multi-SKU/Multi-Level Container tab.
4. The Multi-SKU/Multi-Level Container tab window displays, with the list of putaway preferences.
5. Select the putaway preference to be modified. Choose .
6. The Putaway Preference Details window displays.
7. Enter information in the applicable fields. For more information about modifying the fields, refer to [Section 5.2.3.1.1, "Setting Up Putaway Preference for a Multi-Level Pallet"](#) on page 289 and [Section 5.2.3.1.2, "Setting Up Putaway Preference for a Multi-Level Case"](#) on page 295.
8. Choose .

The activity code corresponding to the preference cannot be modified. The preference must be deleted and recreated.

5.2.3.4 Deleting a Putaway Preference for Multi-SKU/Multi-Level Container

To delete a putaway preference for multi-SKU/multi-level container:

1. From the tree in the application rules side panel, choose Receiving > Putaway Preferences. The Putaway Preferences window displays.
2. Alternatively, choose  in the Activity Search window to access Putaway Preferences window.
3. In the Putaway Preferences window, choose the Multi-SKU/Multi-Level Container tab.

4. The Multi-SKU/Multi-Level Container tab window displays, with the list of putaway preferences.
5. Select the putaway preference to be deleted.
6. Choose .

5.2.4 Setting Up Putaway Preference for Container with Unknown Contents

The preferences for the putaway of container with unknown contents are specified here. This applies to case and pallet with LPN where contents are not known.

For example, pre-receipt steps during receiving or returns where LPN labels may be scanned. Also, this applies to containers that are cross-docked to shipping lane upon receipt in merge in-transit centers.

Use Putaway Preference for Container with Unknown Contents set-up for:

- [Creating a Putaway Preference for Container with Unknown Contents](#)
- [Creating a New Putaway Preference for Container with Unknown Contents from an Existing Putaway Preference](#)
- [Modifying a Putaway Preference for Container with Unknown Contents](#)
- [Deleting a Putaway Preference for Container with Unknown Contents](#)

5.2.4.1 Creating a Putaway Preference for Container with Unknown Contents

To create a putaway preference for container with unknown contents:

1. From the tree in the application rules side panel, choose Receiving > Putaway Preferences. The Putaway Preferences window displays.
2. Alternatively, choose  in the Activity Search window to access Putaway Preferences window.
3. In the Putaway Preferences window, choose the Container with Unknown Contents tab. The Container with Unknown Contents tab window displays.

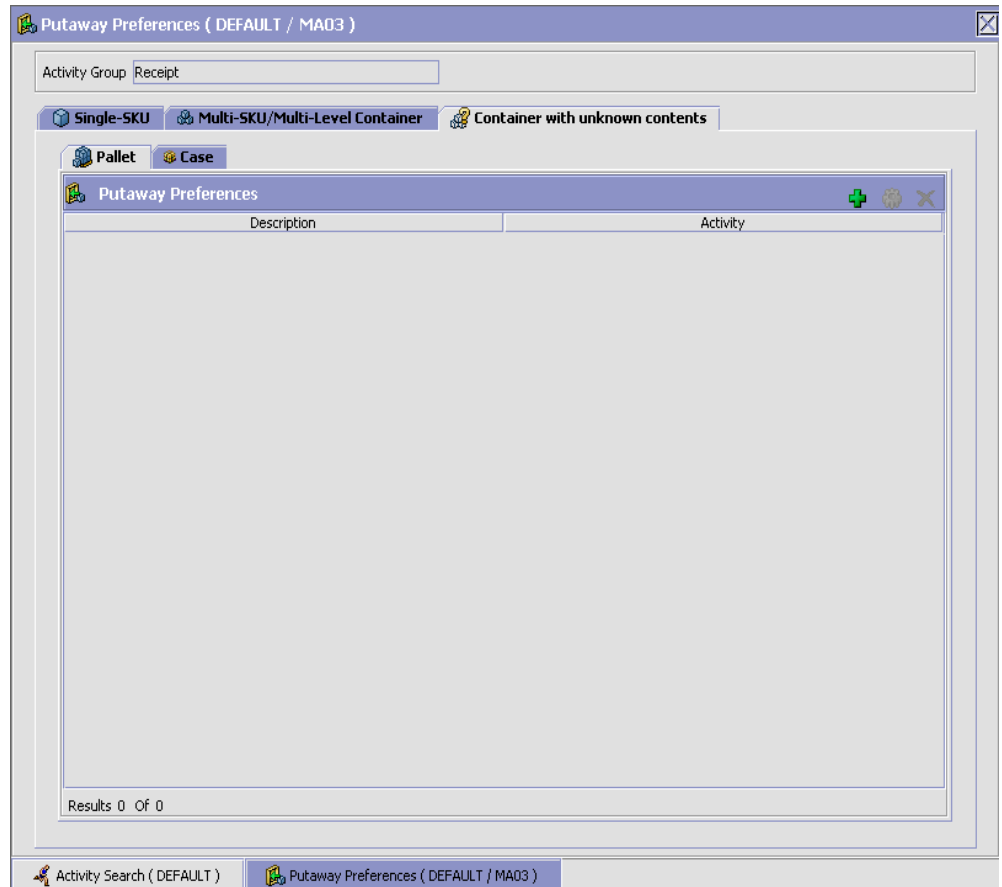



Putaway preferences are separately specified for a pallet and case:

- [Setting Up Putaway Preference for a Pallet](#)
- [Setting Up Putaway Preference for a Case](#)

5.2.4.1.1 Setting Up Putaway Preference for a Pallet

To set up putaway preference for a pallet:

1. In the Container with Unknown Contents tab of Putaway Preferences window, choose the Pallet tab. The Pallet tab window displays.
2. In the Pallet tab window, choose .

3. The Putaway Preference Details window displays.
4. Enter information in the applicable fields. Refer [Table 5–8](#) for field value descriptions.
5. Choose .

Putaway Preference Details (DEFAULT / MA03) : Container with unknown contents : Pallet

Activity Group: Receipt To View Strategy Click here

Description:

Activity Code:

Priority	Zone	Storage Code
2	ZZ1	To store DVD Writers
3	Bulk	To store DVD Writers
*		

Results 2 Of 2

Activity Search (DEFAULT) Putaway Preferences (DEFAULT / MA03) Putaway Preference Details (DEFAULT / ...)

Table 5–8 Putaway Preference Details Window - Container with Unknown Contents Pallet Tab

Field	Description
Activity Group	This is automatically populated by the system as 'RECEIPT'.
To View Strategy Click here	Choose  to view or set up Putaway Strategy. For more details about Setting Up Putaway Strategy, see Setting Up Putaway Strategy for Containers with Unknown Contents - Pallets . Note: Putaway strategy may be specified for the putaway preferences after the preference is saved.
Description	Enter a description for the activity constraint.
Activity Code	Choose the Activity Code for the putaway preference. This is a mandatory field.
Zone Priorities	
Priority	Enter a number to represent the priority. The priority is used to sequence the order in which the zone priorities are evaluated. For example, all storage code level priorities are to be evaluated first before generic priorities. The priority needs to be a positive integer, greater than zero. This is mandatory.
Zone	Choose the relevant zone for putaway. This is a mandatory field.
Storage Code	Choose the storage code for the zone, if applicable. This limits the locations being evaluated to the storage code specified. For example, putaway of hazardous items into a zone are restricted to the locations having the appropriate storage code.

For example, pre-received pallets, when putaway is automatically sorted by shipment, SCAC utilizing the above fields.



Setting Up Putaway Strategy for Containers with Unknown Contents - Pallets

You can set up putaway strategies to putaway applicable inventory from a source zone to a target zone, based on the strategy specified.

To set up putaway strategy for container with unknown content pallets:

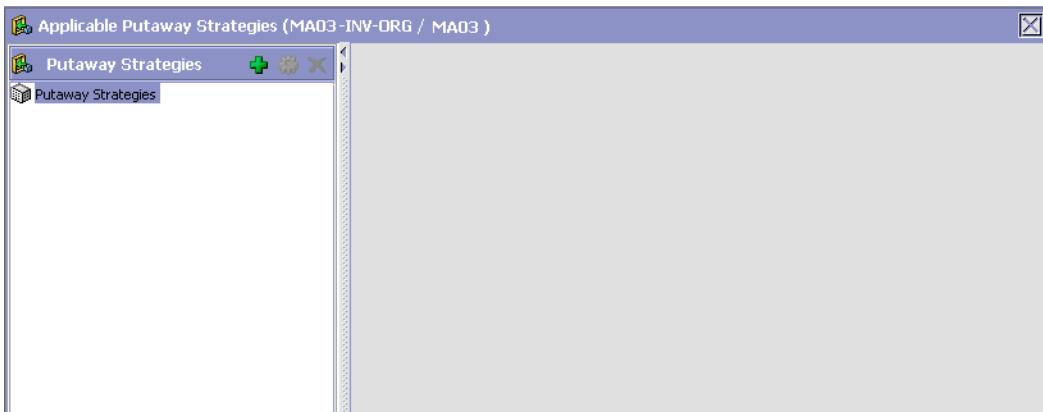
1. In the Putaway Preference Details : Container with unknown contents : Pallet window, choose .
2. The Applicable Putaway Strategies window is displayed.



3. Choose  in the Putaway Strategies panel. The Putaway Strategy Details window appears in the right panel.
4. Enter information in the applicable fields. See the Putaway Strategy Details Window table for field value descriptions.
5. Choose .

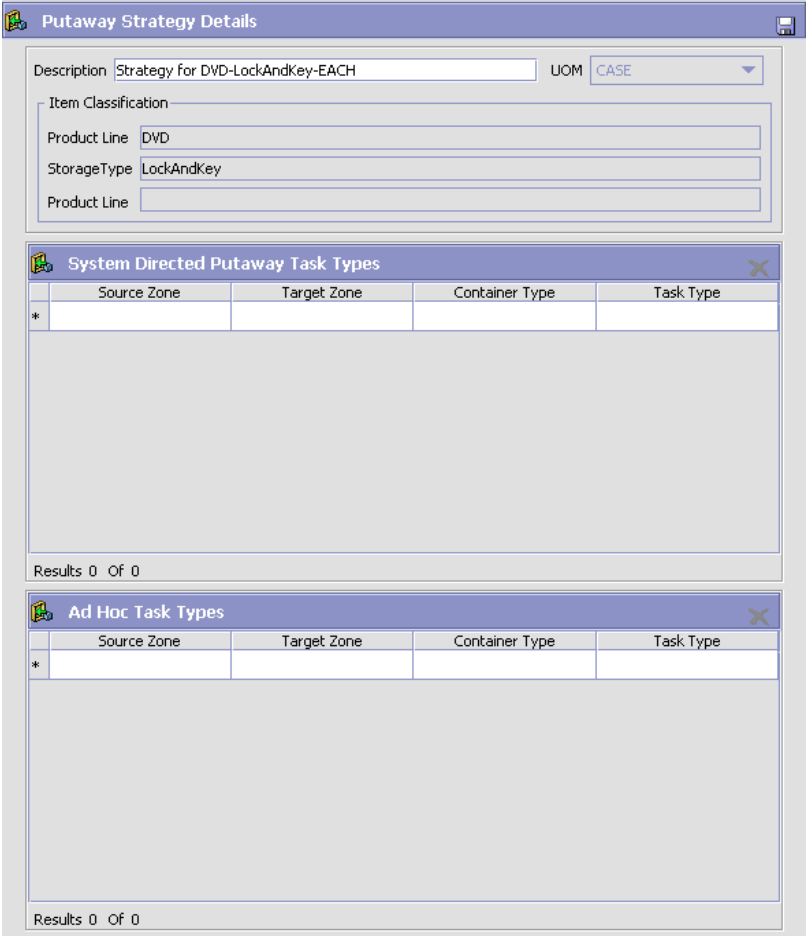

Table 5–9 Putaway Strategy Details Window

Field	Description
Description	Enter a description for the Putaway Strategy.
UOM	Select the UOM for the Putaway Strategy, if applicable. Note: The UOM will be defaulted in instances where it has been specified in the Putaway Preference Details screen.

Table 5–9 Putaway Strategy Details Window



Field	Description
Item Classification	List of putaway item classifications for the Enterprise are displayed. An example, Product Line is shown below.
Product Line	Choose relevant product line item classification for the putaway activity. Choose  . In the Classification Values window, select the applicable product line classification.
System Directed Putaway Task Types	Displays the list of existing system directed putaway task types. You may use  to delete an existing system directed putaway task type.
Source Zone	Select the source zone from where the inventory is sourced.
Target Zone	Select the target zone to where the inventory is moved.
Container Type	Select the container type to be used to move the inventory from the source zone to the target zone. Typical values are Case and Pallet.
Task Type	Select the Putaway Task Type applicable to this putaway strategy. This field displays the list of existing system directed task types that belong to the 'PUTAWAY' activity group.
Ad hoc Task Types	Displays the list of existing ad hoc task types. You may use  to delete an existing ad hoc task type.
Source Zone	Select the source zone from where the inventory is sourced.
Target Zone	Select the target zone to where the inventory is moved.

Table 5–9 Putaway Strategy Details Window



Field	Description
Container Type	Select the container type to be used to move the inventory from the source zone to the target zone. Typical values are Case and Pallet.
Task Type	Select the Putaway Task Type applicable to this putaway strategy. This field displays the list of existing ad hoc task types that belong to the 'PUTAWAY' activity group.

5.2.4.1.2 Setting Up Putaway Preference for a Case

To set up putaway preference for a case:

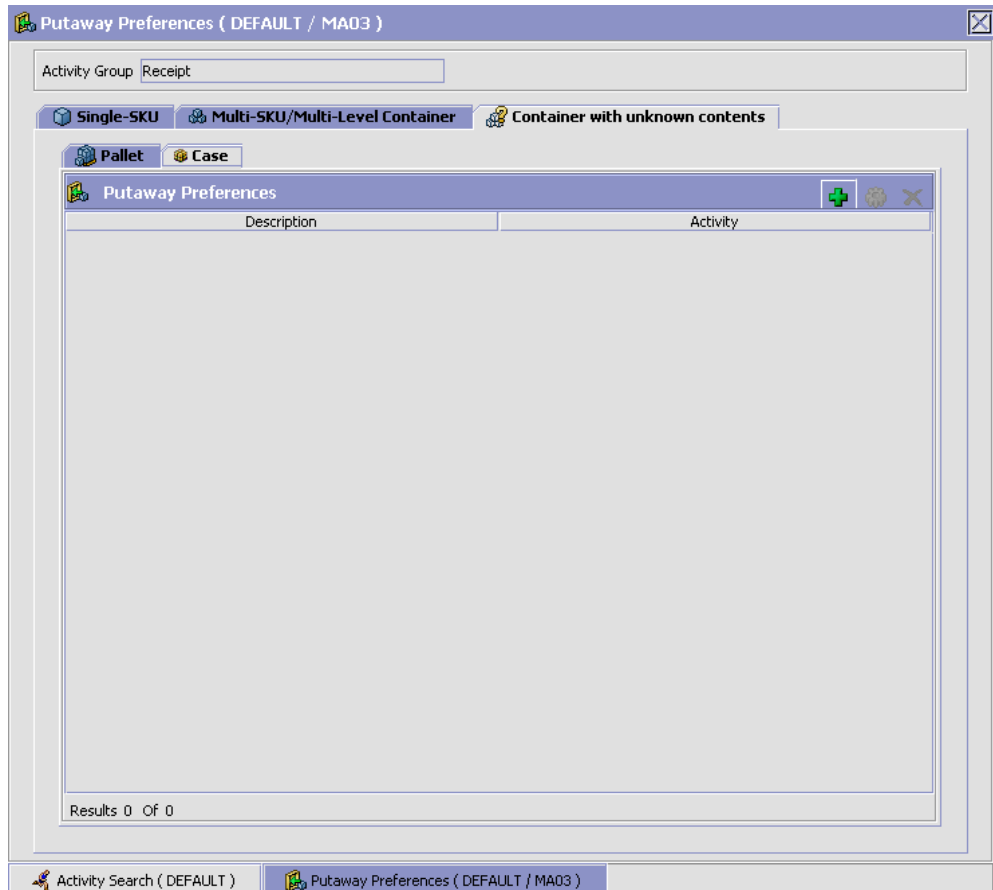
1. In the Container with Unknown Contents tab of Putaway Preferences window, choose the Case tab. The Case tab window displays.



2. In the Case tab window, choose .
3. The Putaway Preference Details window displays.
4. Enter information in the applicable fields. Refer [Table 5–10](#) for field value descriptions.
5. Choose .

Putaway Preference Details (DEFAULT / MA03) : Container with unknown contents : Case

Activity Group Receipt To View Strategy Click here

Description

Activity Code Storage - Receipt

Zone Priorities

Priority	Zone	Storage Code
1	Bulk	To store DVD Writers
*		

Results 1 Of 1

Activity Search (DEFAULT) Putaway Preferences (DEFAULT / M... Putaway Preference Details (DEFAU...

Table 5–10 Putaway Preference Details Window - Container with Unknown Contents Case Tab

Field	Description
Activity Group	This is automatically populated by the system as 'RECEIPT'.
To View Strategy Click here	Choose  to view or set up Putaway Strategy. For more details about Setting Up Putaway Strategy, see Setting Up Putaway Strategy for Containers with Unknown Contents - Cases . Note: Putaway strategy may be specified for the putaway preferences after the preference is saved.
Description	Enter a description for the activity constraint.
Activity Code	Choose the Activity Code for the putaway preference. This is a mandatory field.
Zone Priorities	
Priority	Enter a number to represent the priority. The priority is used to sequence the order in which the zone priorities are evaluated. For example, all storage code level priorities are to be evaluated first before generic priorities. The priority needs to be a positive integer, greater than zero. This is mandatory.
Zone	Choose the relevant zone for putaway. This is a mandatory field.
Storage Code	Choose the storage code for the zone, if applicable. This limits the locations being evaluated to the storage code specified. For example, putaway of hazardous items into a zone are restricted to the locations having the appropriate storage code.



Setting Up Putaway Strategy for Containers with Unknown Contents - Cases

You can set up putaway strategies to putaway applicable inventory from a source zone to a target zone, based on the strategy specified.

To set up putaway strategy for container with unknown content cases:

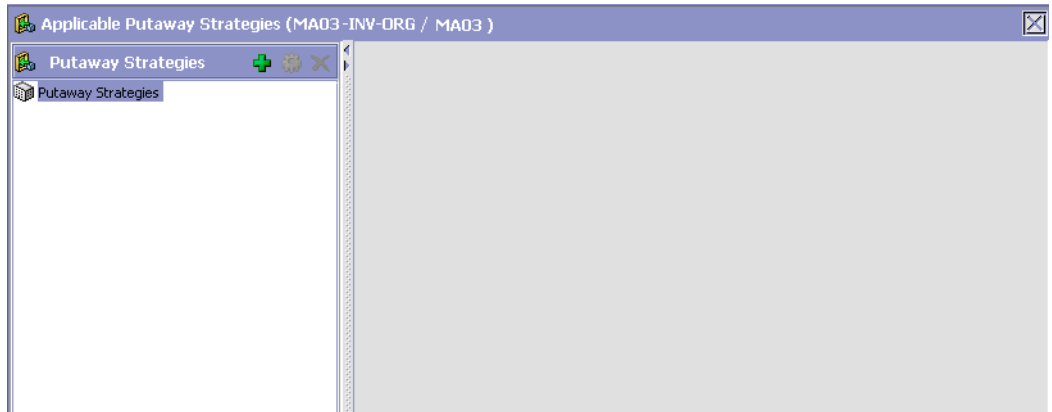
1. In the Putaway Preference Details : Container with unknown contents : Case window, choose .
2. The Applicable Putaway Strategies window is displayed.



3. Choose  in the Putaway Strategies panel. The Putaway Strategy Details window appears in the right panel.
4. Enter information in the applicable fields. See the Putaway Strategy Details Window table for field value descriptions.
5. Choose .

Putaway Strategy Details

Description: Strategy for DVD-LockAndKey-EACH UOM: CASE

Item Classification:

Product Line: DVD

StorageType: LockAndKey

Product Line:

System Directed Putaway Task Types

	Source Zone	Target Zone	Container Type	Task Type
*				

Results: 0 Of 0

Ad Hoc Task Types

	Source Zone	Target Zone	Container Type	Task Type
*				

Results: 0 Of 0

Table 5–11 Putaway Strategy Details Window

Field	Description
Description	Enter a description for the Putaway Strategy.
UOM	Select the UOM for the Putaway Strategy, if applicable. Note: The UOM will be defaulted in instances where it has been specified in the Putaway Preference Details screen.

Table 5–11 Putaway Strategy Details Window







Field	Description
Item Classification	List of putaway item classifications for the Enterprise are displayed. An example, Product Line is shown below.
Product Line	Choose relevant product line item classification for the putaway activity. Choose  . In the Classification Values window, select the applicable product line classification.
System Directed Putaway Task Types	Displays the list of existing system directed putaway task types. You may use  to delete an existing system directed putaway task type.
Source Zone	Select the source zone from where the inventory is sourced.
Target Zone	Select the target zone to where the inventory is moved.
Container Type	Select the container type to be used to move the inventory from the source zone to the target zone. Typical values are Case and Pallet.
Task Type	Select the Putaway Task Type applicable to this putaway strategy. This field displays the list of existing system directed task types that belong to the 'PUTAWAY' activity group.
Ad hoc Task Types	Displays the list of existing ad hoc task types. You may use  to delete an existing ad hoc task type.
Source Zone	Select the source zone from where the inventory is sourced.
Target Zone	Select the target zone to where the inventory is moved.

Table 5–11 Putaway Strategy Details Window

Field	Description
Container Type	Select the container type to be used to move the inventory from the source zone to the target zone. Typical values are Case and Pallet.
Task Type	Select the Putaway Task Type applicable to this putaway strategy. This field displays the list of existing ad hoc task types that belong to the 'PUTAWAY' activity group.

5.2.4.2 Creating a New Putaway Preference for Container with Unknown Contents from an Existing Putaway Preference

To create a new putaway preference for container with unknown contents from an existing putaway preference:



1. From the tree in the application rules side panel, choose Receiving > Putaway Preferences. The Putaway Preferences window displays.
2. Alternatively, choose  in the Activity Search window to access Putaway Preferences window.
3. In the Putaway Preferences window, choose the Container with Unknown Contents tab.
4. The Container with Unknown Contents tab window displays, with the list of putaway preferences.
5. Select the putaway preference to be copied. Choose .
6. The Putaway Preference Details window displays.
7. Enter information in the applicable fields. For more information about modifying the fields, refer to [Section 5.2.4.1.1, "Setting Up Putaway Preference for a Pallet"](#) on page 305 and [Section 5.2.4.1.2, "Setting Up Putaway Preference for a Case"](#) on page 311.
8. Choose .

The activity code corresponding to the preference cannot be modified. The preference must be deleted and recreated.

5.2.4.3 Modifying a Putaway Preference for Container with Unknown Contents

Once a Putaway Preference for Container with Unknown Contents has been created, it can be modified.

To modify a putaway preference for container with unknown contents:

1. From the tree in the application rules side panel, choose Receiving > Putaway Preferences. The Putaway Preferences window displays.
2. Alternatively, choose  in the Activity Search window to access Putaway Preferences window.
3. In the Putaway Preferences window, choose the Container with Unknown Contents tab.
4. The Container with Unknown Contents tab window displays, with the list of putaway preferences.
5. Select the putaway preference to be modified. Choose .
6. The Putaway Preference Details window displays.
7. Enter information in the applicable fields. For more information about modifying the fields, refer to [Section 5.2.4.1.1, "Setting Up Putaway Preference for a Pallet"](#) on page 305 and [Section 5.2.4.1.2, "Setting Up Putaway Preference for a Case"](#) on page 311.
8. Choose .

The activity code corresponding to the preference cannot be modified. The preference must be deleted and recreated.

5.2.4.4 Deleting a Putaway Preference for Container with Unknown Contents

To delete a putaway preference for container with unknown contents:

1. From the tree in the application rules side panel, choose Receiving > Putaway Preferences. The Putaway Preferences window displays.
2. Alternatively, choose  in the Activity Search window to access Putaway Preferences window.
3. In the Putaway Preferences window, choose the Container with Unknown Contents tab.

4. The Container with Unknown Contents tab window displays, with the list of putaway preferences.
5. Select the putaway preference to be deleted.
6. Choose .

5.3 Defining Purchase Order

A purchase order consists of a list of items to be purchased from a vendor. The vendor may ship a purchase order in multiple shipments. Also, a shipment may consist of multiple purchase orders from the same vendor.

The ability to configure receiving processes for a purchase order in the warehouse is detailed here.

Use Purchase Order set-up for:

- [Defining Receipt Modification Rules](#)
- [Defining Receipt Process Type Details](#)
- [Defining Receipt Process Model](#)
- [Defining Receiving Preferences](#)
- [Defining Receiving Disposition](#)
- [Defining Disposition Codes](#)

5.3.1 Defining Receipt Modification Rules



Most order document types flow through a pipeline without requiring any intervention by a customer service representative. However, there are times when modifications are required, such as changing credit card information or quantity. Selling and Fulfillment Foundation supports modifications through the Console and APIs. It is critical for you to decide which modifications are allowed for each modification type, modification level, and status combination.

Important: Contemplate business and system integration implications before allowing a modification that is disallowed as part of the system defaults. For example, adding instructions to a purchase order document type is disallowed after the release has been sent to the node.

For more information about modification rules, see the *Sterling Distributed Order Management: Configuration Guide*.

5.3.2 Setting Up Receipt Modification Rules

To set up receipt modification rules:

1. From the tree in the application rules side panel, choose Receiving > Document Specific > Purchase Order > Receipt Modification Rules. The Modification Rules window displays.
2. In the Modification Rules window, select the Purchase Order Receipt whose Modification Rule is to be set. Refer [Table 5–12](#) for field value descriptions.
3. Choose  to allow order modification.
4. Choose  to disallow order modification.
5. Choose  to ignore order modification.

For more information about defining modification rules, see the *Sterling Distributed Order Management: Configuration Guide*.

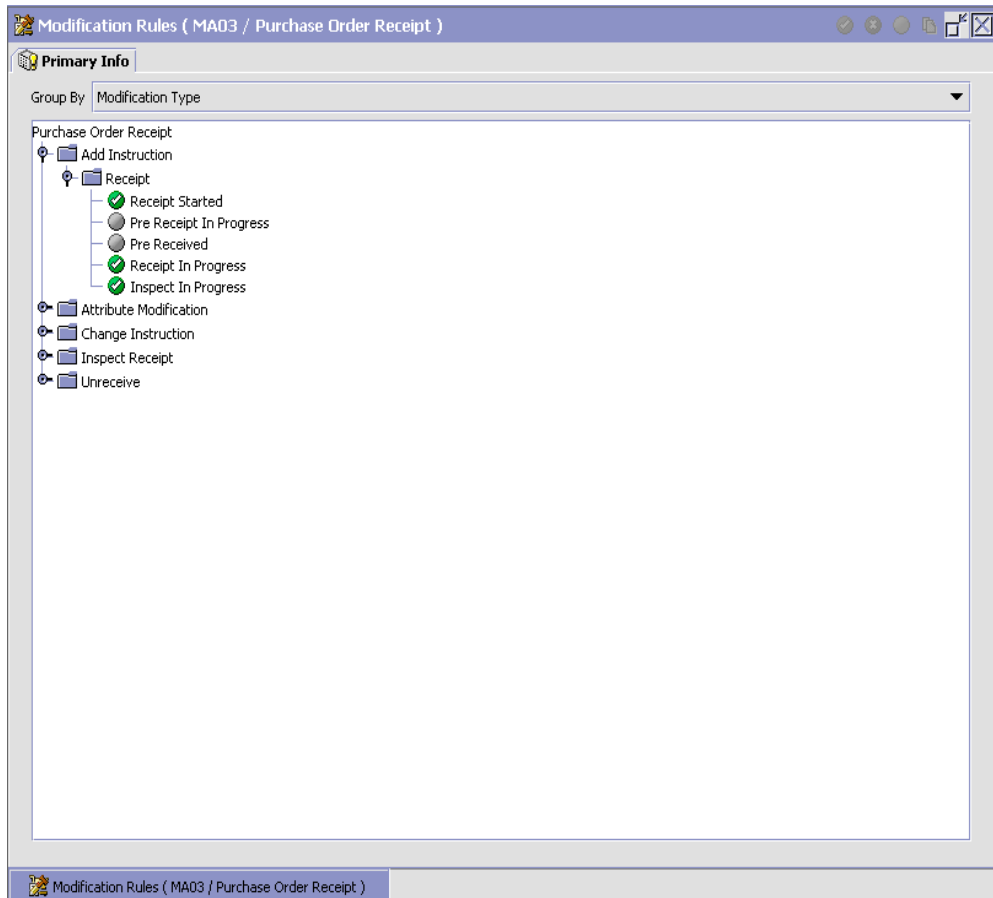

Table 5–12 Modification Rules Window

Field	Description
Primary Info	
Group by	View the Purchase Order Receipt Modification Rules grouped by Modification Type, Modification Level, or by Status.

Table 5–12 Modification Rules Window

Field	Description
Modification Type	Purchase Order Receipt Modification Rules grouped by Modification Type. Statuses display grouped by Modification Level for each Modification Type.
Add Instruction	Allow or Disallow or Ignore addition of instruction appropriately.
Attribute Modification	Allow or Disallow or Ignore modifications to an attribute appropriately.
Change Instruction	Allow or Disallow or Ignore change of instruction appropriately.
Receipt Complete	Allow or Disallow or Ignore completion of a receipt appropriately.
Unreceive	Allow or Disallow or Ignore un-receiving of a return order appropriately.
Modification Level	Purchase Order Receipt Modification Rules grouped by Modification Level. Statuses display grouped by Modification Type for each Modification Level.
Receipt	Allow or Disallow or Ignore modification types at receipt level appropriately.
Receipt Line	Allow or Disallow or Ignore modification types at receipt line level appropriately.
Status	Purchase Order Receipt Modification Rules grouped by Status. Modification Types display grouped by Modification Level for each Status. For more information about group by status, see Section 5.3.4.6, "Statuses" on page 333.

For more information about defining or changing Modification Rules, see the *Sterling Distributed Order Management: Configuration Guide*.

5.3.3 Defining Receipt Process Type Details

Receipt Process Type Details define parameters and templates that distinguish a process type.

A **process type pipeline** is a series of transactions and statuses that guide document types, such as a Return Order, through a predefined process. A pipeline consists of the different statuses a document goes through during fulfillment, negotiation, shipment, or receipt. You can also set up transactions consisting of events, actions, and conditions, as they pertain to the pipeline you are configuring.

Repositories

A repository is a logical collection of entities that define the business process workflow.

The following entities are included in a repository:

- Pipelines
- Transactions
- Statuses
- Conditions
- Actions
- Services

Selling and Fulfillment Foundation provides a base repository for each of the system-defined process types. Some of the entities within a repository are copied when creating a new document type. For more information about creating a new document type, see the *Selling and Fulfillment Foundation: Application Platform Configuration Guide*.

For more information about defining process type details, see the *Selling and Fulfillment Foundation: Application Platform Configuration Guide*.

To view purchase order receipt process type details:

1. From the tree in the application rules side panel, choose Receiving > Document Specific > Purchase Order > Receipt Process Type Details. The Process Type Details : Purchase Order window displays.
2. Primary information of the Process Type displays in the applicable fields. Refer [Table 5–13](#) for field value descriptions.
3. Choose .

For more information about defining the primary information for process type details, see the *Selling and Fulfillment Foundation: Application Platform Configuration Guide*.

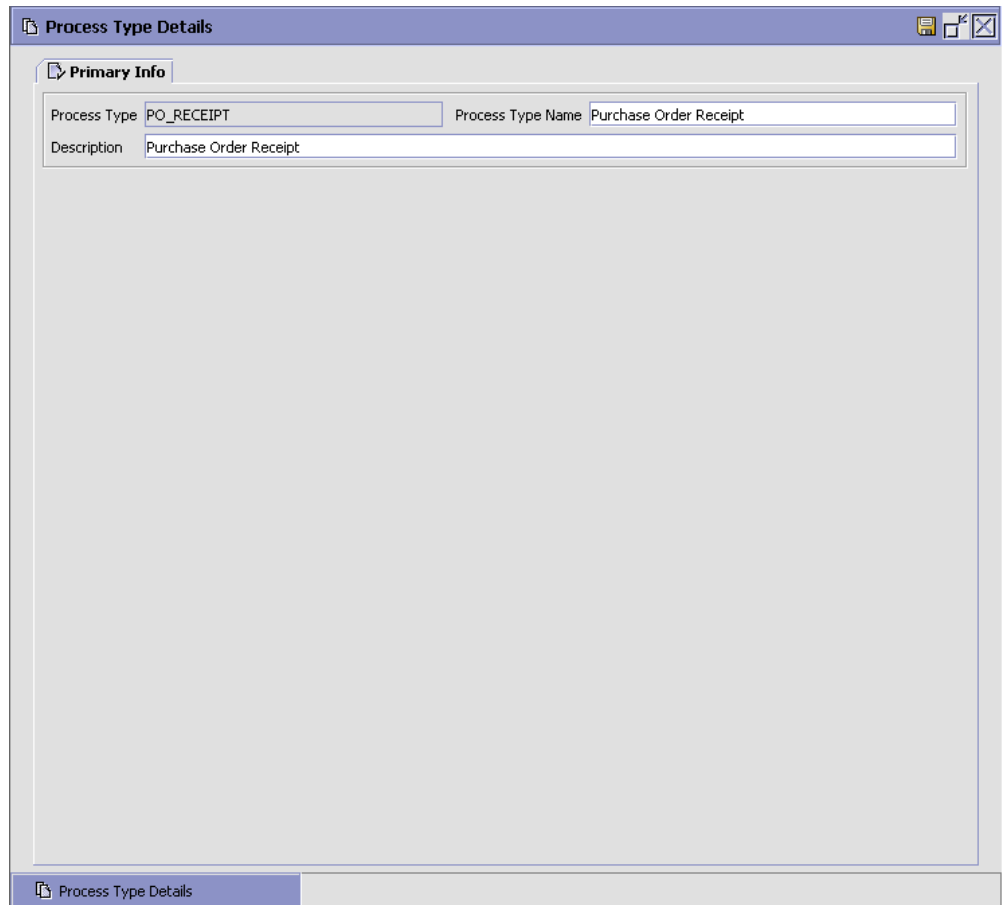

Table 5–13 *Process Type Details Window*

Field	Description
Primary Info	
Process Type	This is populated by the system, and reads "PO_RECEIPT".

Table 5–13 Process Type Details Window

Field	Description
Process Type Name	Enter a name for the process type.
Description	Enter a brief description for the process type.

5.3.4 Defining Receipt Process Model

The process of receiving is modeled through a pipeline. This represents the process configuration that is unique to a warehouse. A warehouse may also specify unique processes for each participating enterprise.

For example, a warehouse that performs re-packaging (VAS) for certain items in the warehouse or a warehouse that always palletizes all receipts before putaway to storage area.

5.3.4.1 Pipeline Determination

Pipeline determination is used to set up conditions that affect which pipeline is used during the start of the business process workflow. For example, an organization deals with sales orders that sometimes contain hazardous materials. They have two separate pipelines, one in which orders with order lines without any hazardous materials go through and one in which orders with order lines containing hazardous materials must go through for inspection before continuing through the order process. The organization uses pipeline determination to set up a condition that determines whether or not order lines contain hazardous materials and sends the order line down the correct pipeline.

For more information about Pipeline Determination, see the *Selling and Fulfillment Foundation: Application Platform Configuration Guide*.

5.3.4.2 Hub Rule

When you expand the Pipeline Determination branch, the components display depends on what role you are logged in as. If you are logged in as a Hub role, the Hub Rule displays. If you are logged in as an Enterprise role, both the Hub Rule and all user created determination rules (For example, My Rule) components display. Double-click on the applicable rule to display the pipeline determination rules.

Note: If you are logged in as an Enterprise role, the Hub Rule screen is grayed out and cannot be modified.

Drag conditions and pipelines into the work area to construct pipeline determination rules. A single pipeline or condition must be the root. Conditions cannot link back to an earlier component in the chain and a pipeline cannot be linked to twice.

Note: When configuring pipeline determination for an order document type pipeline, note that pipeline determination is only considered when adding a line or creating an order. When changes are made to draft orders pipeline determination does not occur.

5.3.4.3 Condition Variables for Pipeline Determination

When using conditions for pipeline determination, the following condition variables can be used:

- Document Type
- Enterprise Code
- Seller Organization Code
- Ship Node
- Buyer Organization Code
- Receiving Node
- Receiving Node Interface Type
- Ship Mode
- Freight Terms
- Carrier Type
- Is Hazardous Material
- Is Inspection Pending
- Is Receiving Node Integrated Real Time

For more information about Pipeline Determination and Hub Rule, see the *Selling and Fulfillment Foundation: Application Platform Configuration Guide*.

5.3.4.4 Pipelines

For more information about Pipelines, see the *Selling and Fulfillment Foundation: Application Platform Configuration Guide*.

To view the purchase order receipt pipeline details:

1. From the tree in the application rules side panel, choose Receiving > Document Specific > Purchase Order > Receipt Process Model. The Purchase Order Receipt window displays.

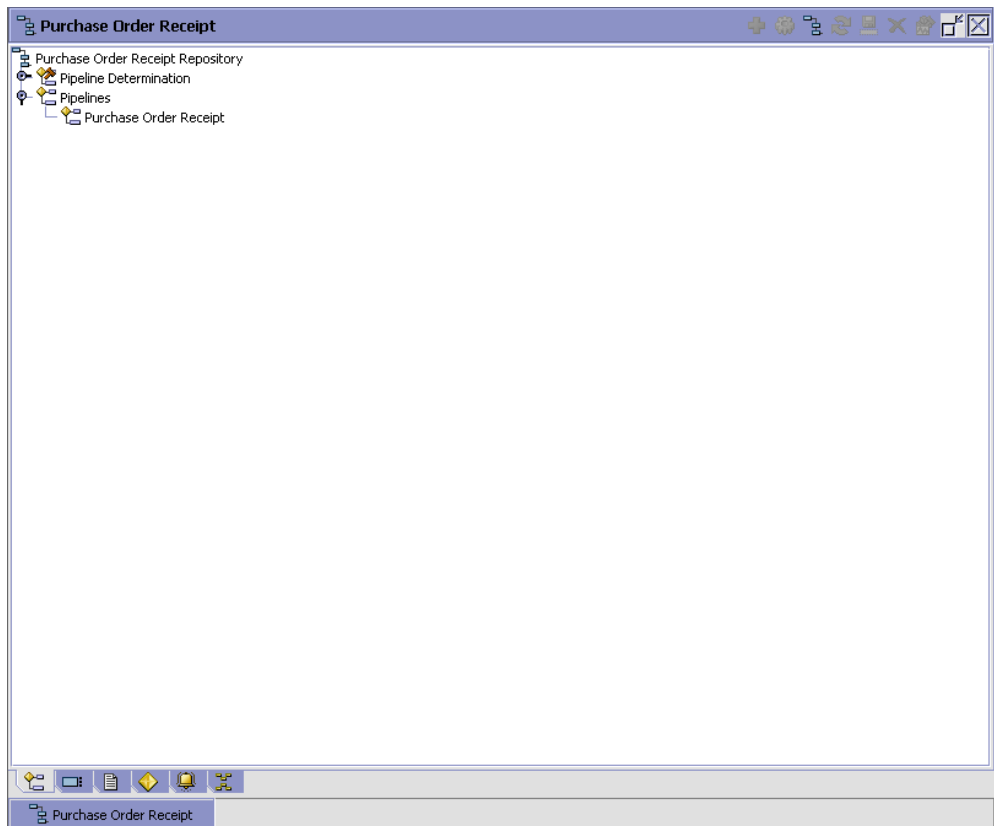

2. In the Purchase Order Receipt window, choose Purchase Order Receipt Repository > Pipelines > Purchase Order Receipt.
3. The Pipeline Detail: Purchase Order Receipt (Purchase Order Receipt) window displays.

For more information about creating and modifying a pipeline, see the *Selling and Fulfillment Foundation: Application Platform Configuration Guide*.

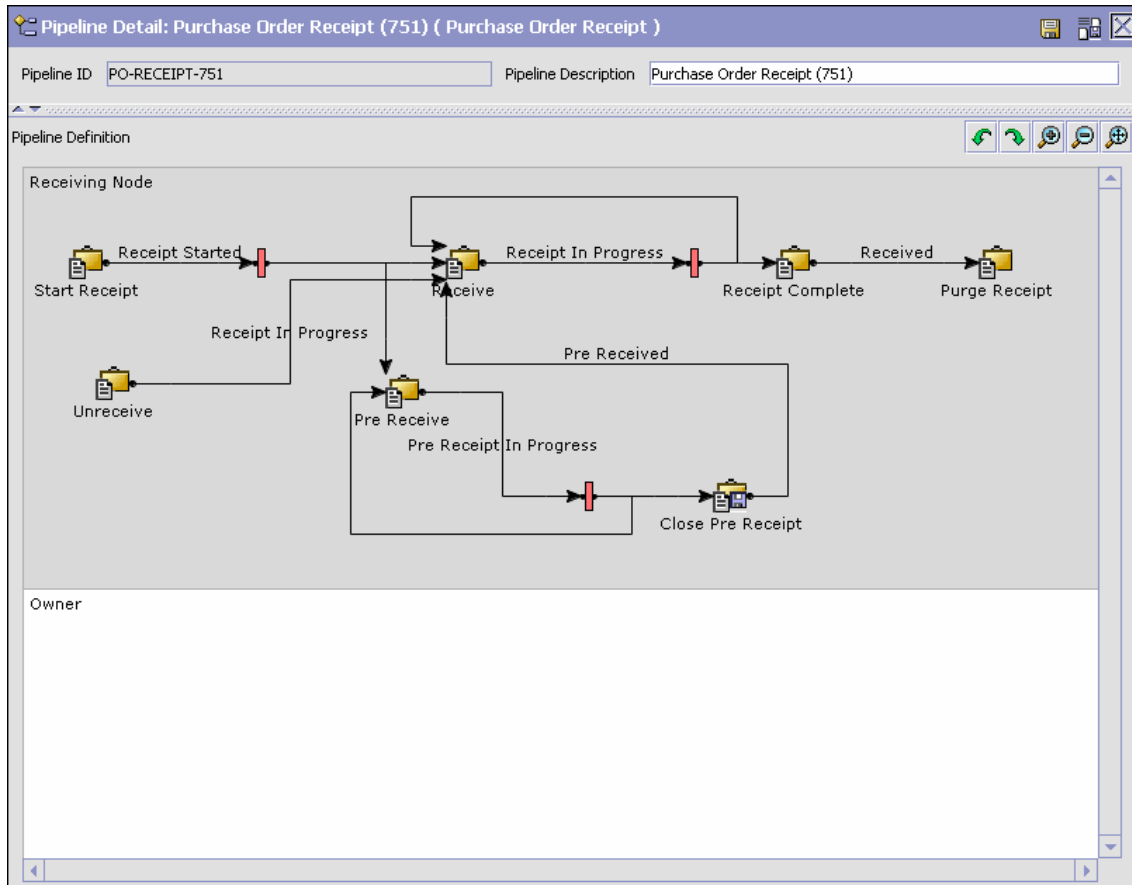

5.3.4.5 Transactions

Every process type has a set of base transactions defined for it. A transaction is a logical unit of work that is necessary for performing an activity within Selling and Fulfillment Foundation. Base transactions are predefined transactions that contain information about how the transaction behaves, such as how many copies of a transaction can be kept in a process type and whether or not it can have configurable base pick and drop statuses. Base transactions can be used to create new transactions. These transactions can be changed within the limits defined in the base transaction.

For more information about Transactions, see the *Selling and Fulfillment Foundation: Application Platform Configuration Guide*.

To view the transaction details for a purchase order receipt pipeline:

1. From the tree in the application rules side panel, choose Receiving > Document Specific > Purchase Order > Receipt Process Model. The Purchase Order Receipt window displays.
2. In the Purchase Order Receipt window, choose .
3. The Transactions tab window displays.

For more information about creating and modifying Transactions, see the *Selling and Fulfillment Foundation: Application Platform Configuration Guide*.

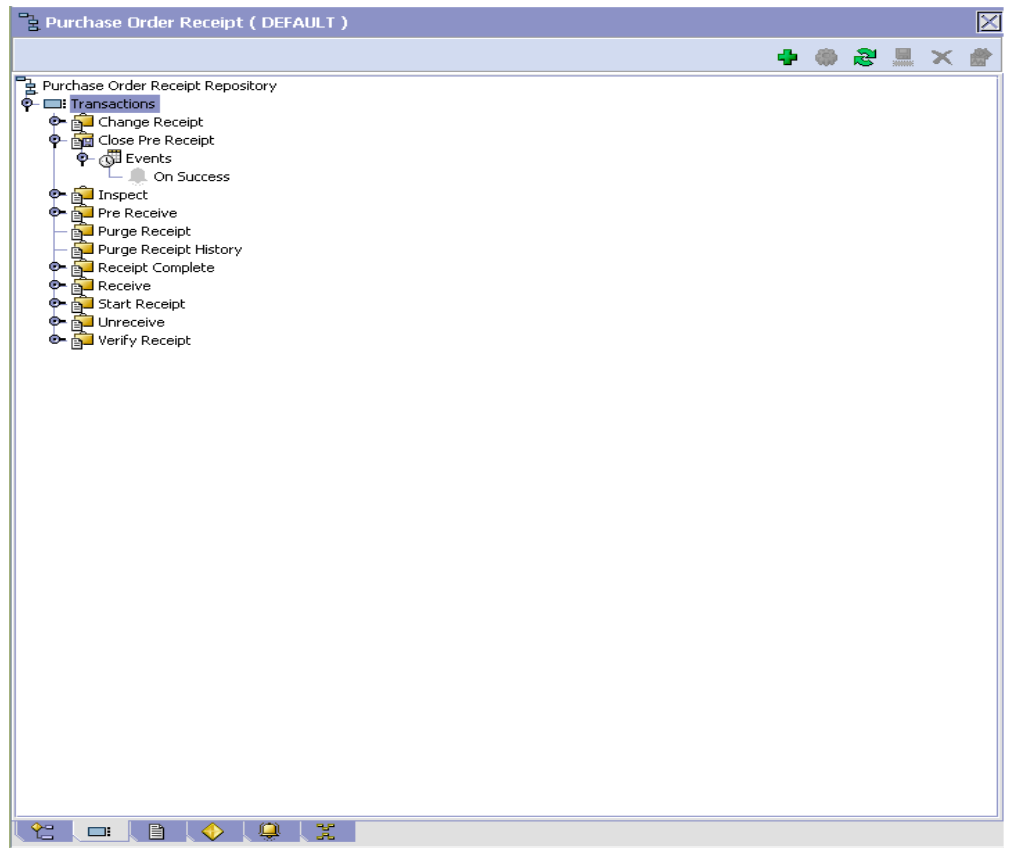

Table 5–14 Purchase Order Receipt Pipeline - Transactions Tab Window

Field	Description
Change Receipt	This transaction represents the receipt details being modified after a receipt for a shipment is recorded.
Close Pre Receipt	This transaction represents the closure of pre-receipts for a shipment. Pre-receipt allows a warehouse to indicate the receipt of containers for a shipment. The visibility provided to the other departments allows for exception handling. For example, during item shortage in the pick areas, supervisors monitor incoming shipments to request for emergency receipt of a particular shipment.
Inspect	This transaction represents the step of inspecting a shipment. This is required to complete the disposition of product received.
Pre Receive	This transaction represents a shipment that may be pre-received before it is actually received in the warehouse.
Purge Receipt	This transaction represents a receipt that may be purged (moved out of) from primary transactional tables to the history tables. For more information about the receipt purge transaction, see the <i>Sterling Supply Collaboration: Configuration Guide</i> .
Purge Receipt History	This transaction represents a receipt that may now be purged (moved out of) from the history tables. For more information about the receipt history purge transaction, see the <i>Sterling Supply Collaboration: Configuration Guide</i> .
Receipt Complete	This transaction represents the completion of receipt of a shipment. It is invoked automatically from receipt screens or manually from a console or through the close receipt agent.
Receive	This transaction represents receipt of product on a shipment.
Start Receipt	This transaction represents the opening of a receipt for shipment. This is invoked either manually from a console or automatically invoked from consoles or RF.

Table 5–14 Purchase Order Receipt Pipeline - Transactions Tab Window

Field	Description
Unreceive	This transaction represents the removal of excess container, if any, of received quantity against a shipment.
Verify Receipt	This transaction checks whether an under or over receipt discrepancy is found in the received inventory, and raises an ON_SUCCESS event.

5.3.4.6 Statuses

Statuses are the actual states that a document moves through in the pipeline. A transaction can contain two types of statuses, a drop status and a pickup status. A document is moved into a **drop status** when the events and conditions of a transaction have been completed. A **pickup status** takes the document from the previous drop status and moves it through the next transaction. Created and Scheduled are examples of statuses.

For more information about Statuses, see the *Selling and Fulfillment Foundation: Application Platform Configuration Guide*.

To view the status details of a purchase order receipt pipeline:

1. From the tree in the application rules side panel, choose Receiving > Document Specific > Purchase Order > Receipt Process Model. The Purchase Order Receipt window displays.
2. In the Purchase Order Receipt window, choose .
3. The Statuses tab window displays.

For more information about creating and modifying Statuses, see the *Selling and Fulfillment Foundation: Application Platform Configuration Guide*.

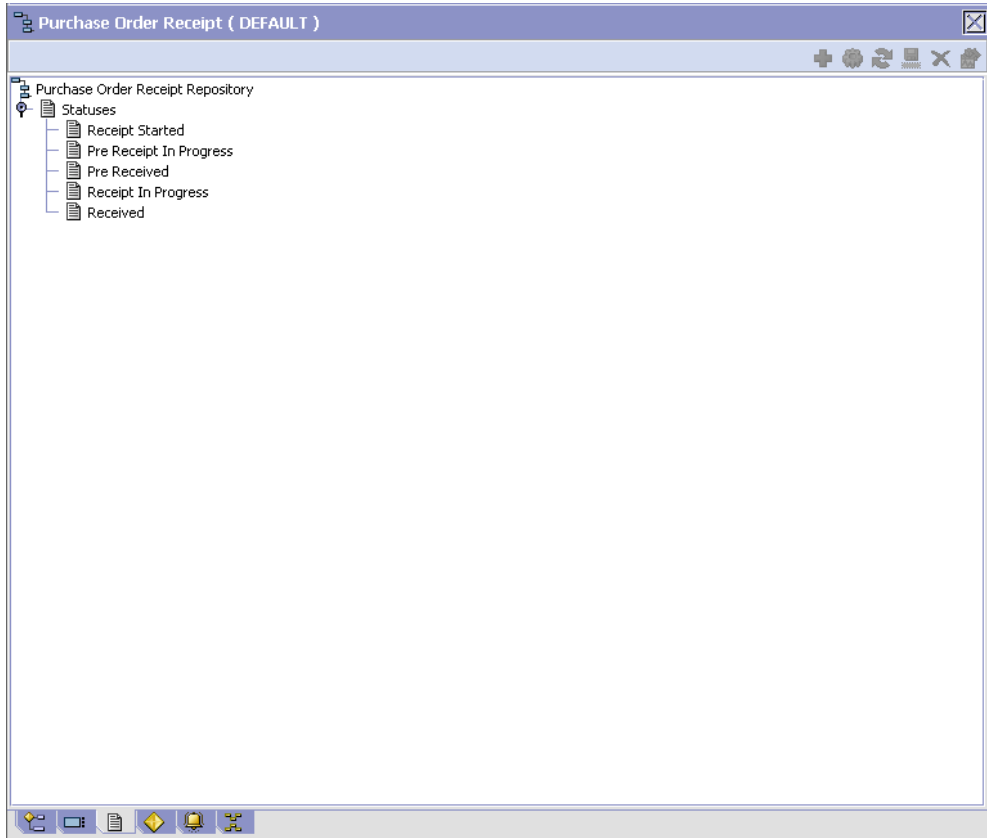

Table 5–15 Purchase Order Receipt Pipeline - Statuses Tab Window

Field	Description
Receipt Started	This indicates that the receipt is opened to receive the shipment. This corresponds to 'Start Receipt' transaction.
Pre Receipt In Progress	This indicates that pre-receipt for the shipment is in progress. This corresponds to 'Pre-receive' transaction.

Table 5–15 Purchase Order Receipt Pipeline - Statuses Tab Window

Field	Description
Pre Received	This indicates that pre-receipt process for the shipment is completed. This corresponds to 'Close Pre-receipt' transaction.
Receipt In Progress	This indicates that receiving for the shipment is in progress. This corresponds to 'Receive' or 'Un-Receive' transactions.
Received	This indicates that receiving for the shipment is complete. This corresponds to 'Receipt Complete' transaction.

5.3.4.7 Conditions

A **condition** matches document type attributes against decision points and routes the documents to different paths based on the specified attribute and value combinations. The document type attributes against which conditions can be created are predefined in Selling and Fulfillment Foundation. You can use these attributes in any combination or you can create conditions that run the appropriate application logic for specific circumstances.

For more information about Conditions, see the *Selling and Fulfillment Foundation: Application Platform Configuration Guide*.

To view the condition details of a purchase order receipt pipeline:

1. From the tree in the application rules side panel, choose Receiving > Document Specific > Purchase Order > Receipt Process Model. The Purchase Order Receipt window displays.
2. In the Purchase Order Receipt window, choose .
3. The Conditions tab window displays.

For more information about creating and modifying Conditions, see the *Selling and Fulfillment Foundation: Application Platform Configuration Guide*.

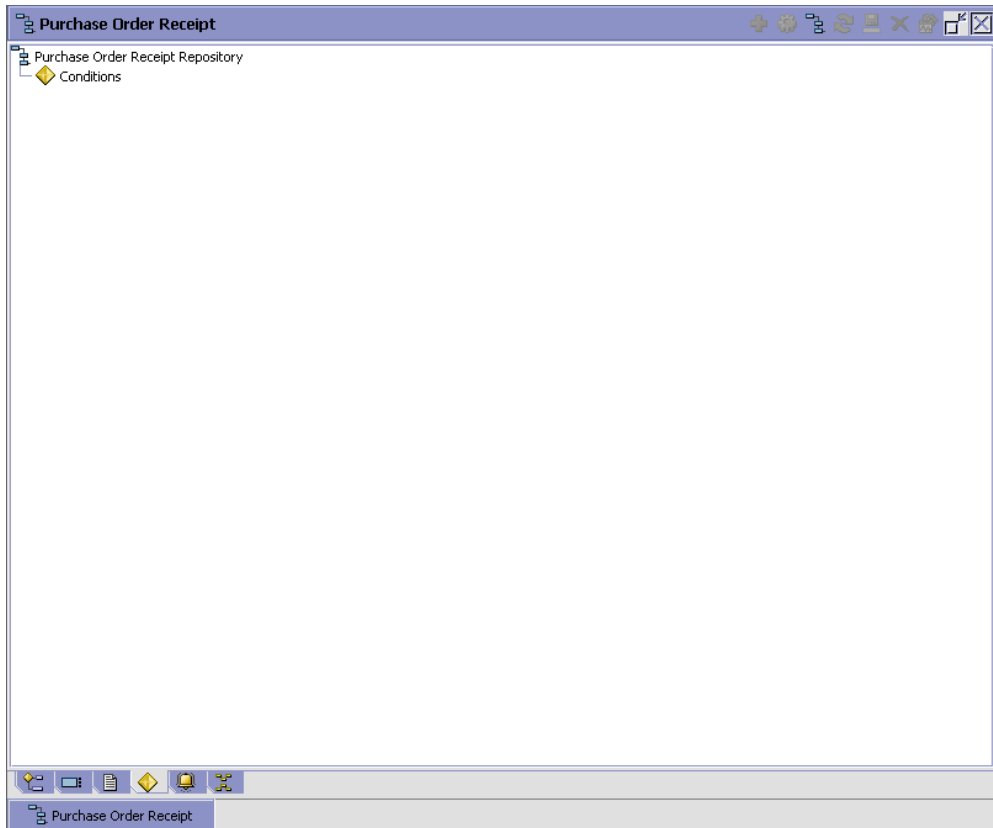

Table 5–16 Purchase Order Receipt Pipeline - Conditions Tab Window

Field	Description
Conditions	Displays conditions that are specific to the purchase order receipt pipeline, if any.

The Sterling WMS default pipeline does not have any conditions specified.

5.3.4.8 Actions

An action is a process or program that is triggered by an event. These processes and programs send user alert notifications and automatically resolve issues.

For example, when an order is released (the event), you can set an action to send the customer an e-mail.

For more information about Actions, see the *Selling and Fulfillment Foundation: Application Platform Configuration Guide*.

To view the action details of a purchase order receipt pipeline:

1. From the tree in the application rules side panel, choose Receiving > Document Specific > Purchase Order > Receipt Process Model. The Purchase Order Receipt window displays.
2. In the Purchase Order Receipt window, choose .
3. The Actions tab window displays.

For more information about creating and modifying Actions, see the *Selling and Fulfillment Foundation: Application Platform Configuration Guide*.

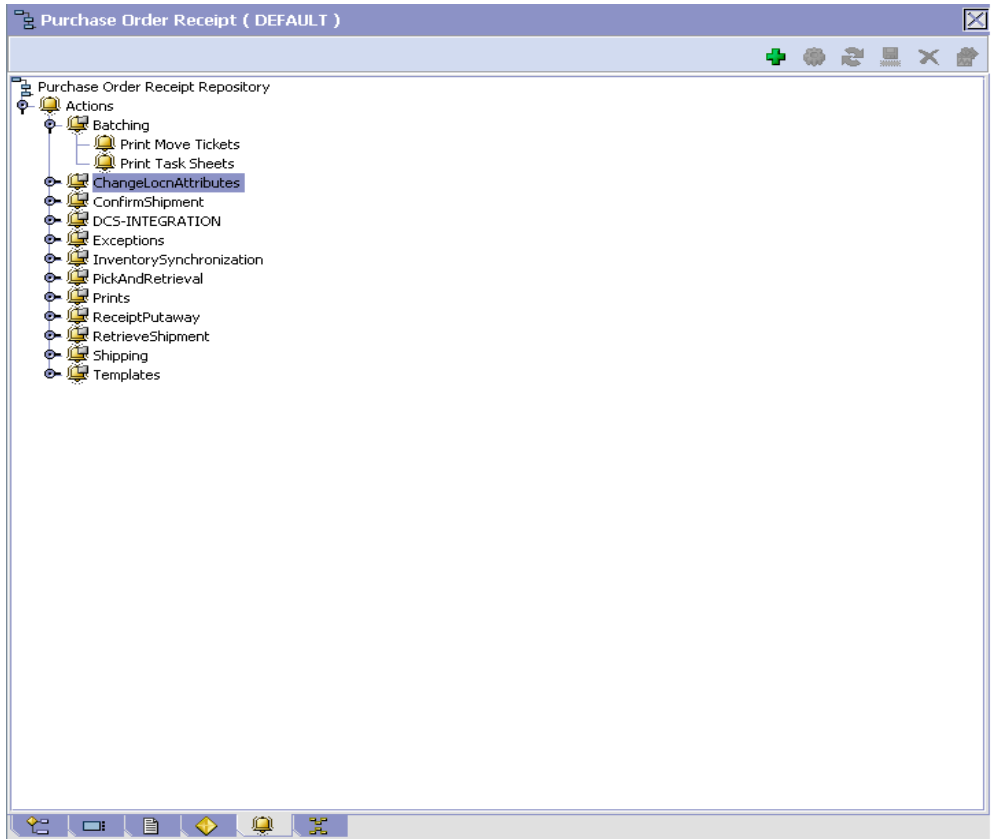

Table 5–17 WMS Layout Definition - Actions Tab Window

Field	Description
Batching	Default settings are provided for: Print Move Tickets – Invokes the batch printing service for printing the move tickets. Print Task Sheets – Invokes the batch print service for printing the task sheets.
ChangeLocnAttributes	Default settings are provided for: ChangeLocationAttributes – Initiates the change location capacity updates if item dimensions or location dimensions change.
ConfirmShipment	Default settings are provided for: ConfirmShipment – Invokes the confirmShipment flow to confirm the shipment.
DCS-Integration	Default settings are provided for: InventoryDownload – Invokes the YantraWMSInventoryDownloadService service to download the inventory information from the Selling and Fulfillment Foundation to DCS. PODownload – Invokes the YantraWMSPODownloadService service to download the Purchase Order information from the Selling and Fulfillment Foundation to DCS.
Exceptions	Default settings are provided for: ShortagesDetected – Invokes the LogWavePliaFailure exception service when shortage of inventory occurs during wave release.
InventorySynchronization	Default settings are provided for: CollectInventoryMismatch – This service collects the inventory mismatch information between an external system and the Selling and Fulfillment Foundation. This is typically caused when some inventory updates at a node or a warehouse are not reported to the Selling and Fulfillment Foundation. UploadInventoryChange - This service reads the message from the JMS queue and invokes the adjustInventory API.

Table 5–17 WMS Layout Definition - Actions Tab Window

Field	Description
PickAndRetrieval	Default settings are provided for: ConfirmEmptyLocationAfterPick – Invokes the GenerateCountRequest flow which creates a count request.
Prints	Default settings are provided for: PickList Print – Invokes the print service for printing the Pick List. LTL Manifest – Invokes the print service for printing the Less-than Truck Load Manifest. Print Load BOL – Invokes the print service for printing the Load Bill of Lading. Print PackList – Invokes the print service for printing the Pack List. Print Post Pick Container Labels – Invokes the print service for printing UCC-128 container labels for containers, when system defined packing process is used. Print Shipment BOL – Invokes the print service for printing the Shipment Bill of Lading. Print Shipping Label – Invokes the print service for printing the UCC-128 container labels. Print Wave – Invokes the Print service for printing a Wave.
ReceiptPutaway	Putaway products on receipt closure – Indicates the default action provided to automatically initiate putaway of purchase order receipts.
ReceiptUpload	UploadCaseReceipt - Reads the message from JMS queue and invokes the receiveOrder API.
RetrieveShipment	Retrieve Requested Serial – This service invokes the retrieveShipment API to retrieve the requested serials to the specified location.

Table 5–17 WMS Layout Definition - Actions Tab Window

Field	Description
Shipping	<p>Default settings are provided for:</p> <p>Load Left Origin – Invokes the doLoadLeftOriginUpdates service to mark that the load has left the origin.</p> <p>Stop Shipping – Invokes the RaiseStopShippingAlert service to raise an alert to stop the processing of the shipment.</p>
Templates	<p>Default settings are provided for:</p> <p>Log Exception – Logs the reasons due to which a count request could not be created for a Count Program.</p> <p>Publish Data – Sends data to external queue or internal tables.</p> <p>Raise Exception – Raises an alert using Event Management from the published information.</p> <p>Route Shipment Exception – Raises an exception if a Scac is not found for an outbound shipment.</p> <p>Send Email – Raises an email action to create an email in the template format from the published information.</p> <p>Send Email-HTML format – Raises an email action to create an email in HTML format from the published information.</p>

Note: Sterling Commerce provides these actions only for DEFAULT enterprises.

5.3.4.9 Service Definitions

Service definitions are a representation of the logic that regulates document workflow services. The Service Builder is a graphical interface that enables you to create a graphical representation of these *services*.

For more information about Service Definitions, see the *Selling and Fulfillment Foundation: Application Platform Configuration Guide*.

To view the service definition details of a purchase order receipt pipeline:

1. From the tree in the application rules side panel, choose Receiving > Document Specific > Purchase Order > Receipt Process Model. The Purchase Order Receipt window displays.
2. In the Purchase Order Receipt window, choose .
3. The Service Definitions tab window displays.

For more information about creating and modifying Service Definitions, see the *Selling and Fulfillment Foundation: Application Platform Configuration Guide*.

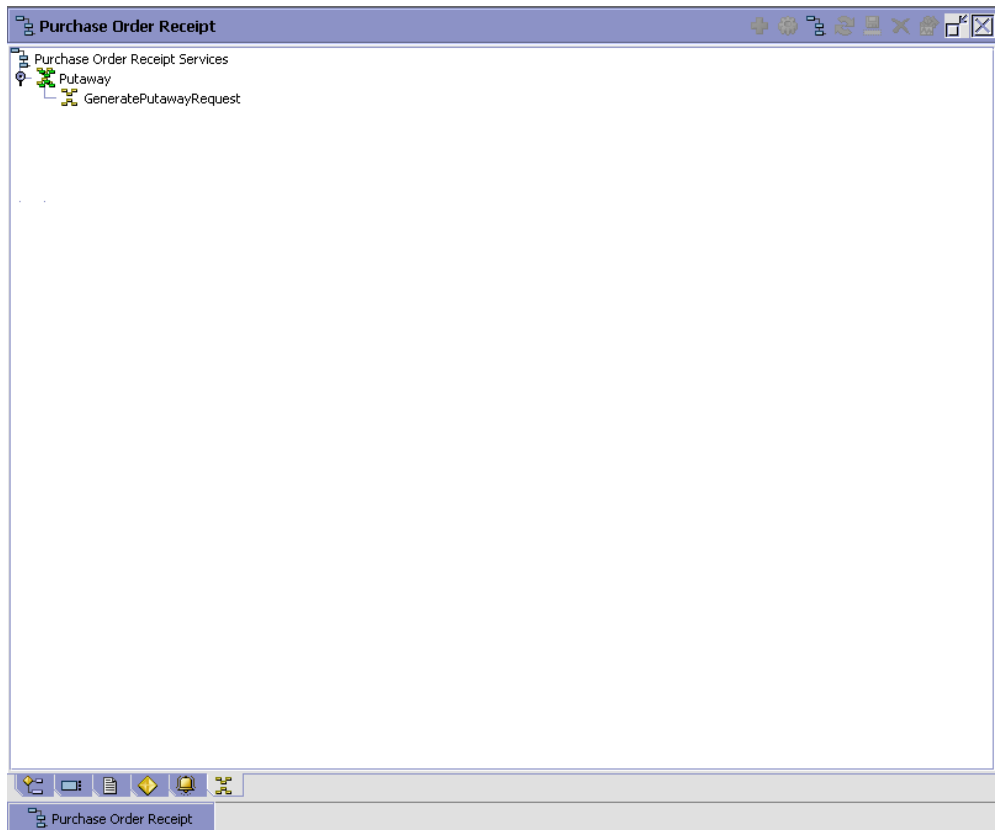

Table 5–18 Purchase Order Receipt Pipeline - Service Definition Tab Window

Field	Description
Default Group	Displays flows that are specific to the returns receipt pipeline.

The Sterling WMS default pipeline does not have any conditions specified.

5.3.5 Defining Receiving Preferences

The receiving preference configuration manages the receiving process of a warehouse.

A receiving preference identifies the characteristics of inbound shipments and provides guidelines to the execution transactions.

Use Receiving Preferences for:

- [Creating a Receiving Preference](#)
- [Modifying a Receiving Preference](#)

5.3.5.1 Creating a Receiving Preference

To create a receiving preference:

1. From the tree in the application rules side panel, choose Receiving > Document Specific > Purchase Order > Receiving Preferences.
2. The Receiving Preferences : Purchase Order window displays.
3. Enter information in the applicable fields. Refer [Table 5–19](#) for field value descriptions.
4. Choose .

Defining Purchase Order

Receiving Preferences : Purchase Order (DEFAULT / MA03)

Shipment entry allowed

Build Pallet

Always Optional
 If Item Tag or Serial tracked

Build Case

Always Optional
 If Item Tag or Serial tracked

Disposition Code Details

Disposition Code for Receipt with QC

Disposition Code for Receipt without QC

Receiving unexpected Items

Allow receiving unexpected Items on Shipment

Preference for receipt closure by agent:

Unconditionally Received quantity at least equal to expected quantity After Putaway completion

Receiving Preferences : Purchase Order (DEFAULT)

Vendor	Vendor Classification	Item ID	Receiving Item Classification	Force Case Content entry	Requires QC
--------	-----------------------	---------	-------------------------------	--------------------------	-------------

Results 0 Of 0

Receiving Preferences : Purchase Order (DEFAULT / MA03)

Table 5–19 Receiving Preferences : Purchase Order Window

Field	Description
Shipment Entry Allowed	<p>Select if shipment entry is to be created when a particular shipment is not available on the system.</p> <p>"Allow Shipment Entry" enables the system to automatically create a shipment entry in the system, if a shipment entry does not exist when a "Start Receipt" operation is performed.</p> <p>On creation and confirmation of the shipment, the "Include in Receipt" transaction is invoked, to enable the receiving process to be carried out on this receipt.</p> <p>Warehouses that receive shipment information via fax or email can manually enter the information into the system. This allows for enhanced tracking and visibility.</p>
Build Pallet	
Always	Select if building of a pallet is mandatory during the receipt process.
Optional	Select if building of a pallet is optional.
If Item Tag or Serial Tracked	Select if building of pallet is required for items that are tag or serial tracked.
Build Case	
Always	Select if building of case is mandatory during the receipt process.
Optional	Select if building of case is optional.
If Item Tag or Serial tracked	Select if building of case is required for items that are tag or serial tracked.
Disposition Code Details	
Disposition Code for Receipt with QC	Choose the disposition code to associate with receipts for vendors or shipments that require QC.
Disposition Code for Receipt without QC	Choose the disposition code to associate with receipts for vendors or shipment that do not require QC.
Receiving unexpected Items	
Allow receiving unexpected Items on Shipment	Select to allow receiving of unexpected items on the shipment.

Table 5–19 Receiving Preferences : Purchase Order Window

Field	Description
Preference for Receipt Closure by Agent	
Unconditionally	Select if receipt closure by the agent occurs every time the closure agent is run. This is typically used where receipts are closed as end-of-day process.
Received quantity at least equal to expected quantity	Select if receipt closure by the agent occurs when the received quantity is at least equal to the expected quantity.
After Putaway Completion	Select if receipt closure by the agent occurs after putaway is completed. This applies to warehouses that indicate availability only when inventory is putaway to their storage locations.
Vendor Preferences	Populated automatically from vendor preferences in the Sterling Supply Collaboration. The preferences are evaluated to determine the best preference. The preference with most matches to the order details is determined as the best preference. For more information about Defining Customer Classifications, see the <i>Sterling Supply Collaboration: Configuration Guide</i> .
Vendor	This indicates the vendor. A vendor is defined as an external company that supplies materials that you order. You receive materials from your vendors. You are, in turn, vendors to your customers.
Vendor Classification	This indicates classification of the vendor.
Item ID	This indicates item ID.
Receiving Item Classification	This indicates the custom defined item storage definition.
Force Case Content entry	This indicates whether case content entry during receipt must be forced.
Requires QC	This indicates whether QC is required or not.

The closure of a shipment triggers the upload of receipt information to external HOST systems is updated in Sterling Supply Collaboration. For example, inventory availability for the shipment is moved from an in-transit to on-hand.

Vendor-specific preferences, if any, configured as part of the Sterling Supply Collaboration display here. For more information, see the *Sterling Supply Collaboration: Configuration Guide*.

Preferences for receiving a shipment are specified as a receiving preference for the ship node and enterprise level. A supervisor, may choose to override these preferences for a specific vendor. For example, a ship node requiring case content verification for most vendors. For a particular vendor a supervisor can override this requirement while manually creating shipment.

The feature of override is only relevant when the preference has been set forcing a granular activity. For example, override is not relevant for a ship node that does not require pallet content verification at a vendor level.

5.3.5.2 Modifying a Receiving Preference

Once a Receiving Preference has been created, it can be modified.

To modify a receiving preference:

1. From the tree in the application rules side panel, choose Receiving > Document Specific > Purchase Order > Receiving Preferences.
2. The Receiving Preferences : Purchase Order window displays with the list of existing rules.
3. Enter information in the applicable fields. Refer [Table 5–19](#) for field value descriptions.
4. Choose .

Any modification to a receiving preference is applied to all future transactions.

5.3.6 Defining Receiving Disposition

You can define common codes for receiving dispositions used when handling a receipt. This common code identifies what happens to items for the document type when they are received.

Use Receiving Disposition for:

- [Creating a Receiving Disposition](#)
- [Creating a New Receiving Disposition From an Existing Receiving Disposition](#)
- [Modifying a Receiving Disposition](#)
- [Deleting a Receiving Disposition](#)



5.3.6.1 Creating a Receiving Disposition

To create a receiving disposition:

1. From the tree in the application rules side panel, choose Receiving > Document Specific > Purchase Order > Receiving Disposition.
2. The Receiving Disposition : Purchase Order window displays.

Receiving Disposition	Short Description
STOCKED	STOCKED
SENT_FOR_REPAIR	Sent For Repair

Results 2 Of 2

3. In the Receiving Disposition : Purchase Order window, choose . The Disposition Details pop-up window displays.
4. Enter information in the applicable fields. Refer [Table 5–20](#) for field value descriptions.
5. Choose .

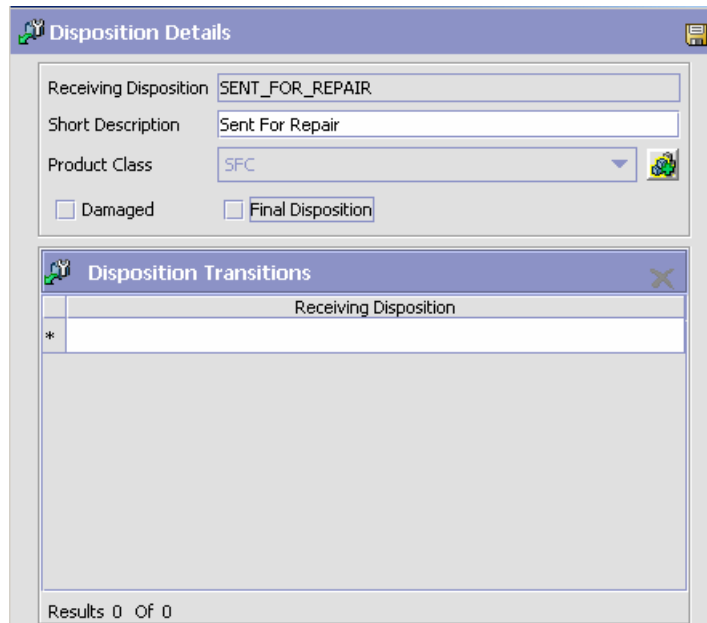

Table 5–20 *Disposition Details Pop-up Window*



Field	Description
Receiving Disposition	Enter the name of the receiving disposition.
Short Description	Enter a brief description of the receiving disposition.
Product Class	Select a product class to associate with received items, if applicable. For example, you could assign the product class of Returned to any returned items.
Damaged	Select Is Damaged if the receiving disposition is used for handling damaged items.
Final Disposition	Select Final Disposition if the receiving disposition is to be used as final disposition for the receipt. Final Disposition marks the disposition code as final, and does not allow any further disposition transitions.

Table 5–20 Disposition Details Pop-up Window

Field	Description
Disposition Transitions	This displays the existing Receiving Disposition codes that are available for associating a transition with the Receiving Disposition being created or modified.
Receiving Disposition	Existing Receiving Disposition Code available for transition association.

5.3.6.2 Creating a New Receiving Disposition From an Existing Receiving Disposition

To create a new receiving disposition from an existing receiving disposition:

1. From the tree in the application rules side panel, choose Receiving > Document Specific > Purchase Order > Receiving Disposition.
2. The Receiving Disposition : Purchase Order window displays with the list of Receiving Dispositions.
3. Choose the Receiving Disposition to be copied from. Choose . The Disposition Details pop-up window displays.
4. Enter information in the applicable fields. Refer [Table 5–20](#) for field value descriptions.
5. Choose .

5.3.6.3 Modifying a Receiving Disposition

Once a Receiving Disposition has been created, it may be modified.

To modify a receiving disposition:

1. From the tree in the application rules side panel, choose Receiving > Document Specific > Purchase Order > Receiving Disposition.
2. The Receiving Disposition : Purchase Order window displays with the list of Receiving Dispositions.
3. Select the Receiving Disposition to be modified. Choose . The Disposition Details pop-up window displays.
4. Enter information in the applicable fields. Refer [Table 5–20](#) for field value descriptions.

5. Choose .

5.3.6.4 Deleting a Receiving Disposition

To delete a receiving disposition:

1. From the tree in the application rules side panel, choose Receiving > Document Specific > Purchase Order > Receiving Disposition.
2. The Receiving Disposition : Purchase Order window displays with the list of Receiving Dispositions.
3. Select the Receiving Disposition to be deleted.
4. Choose .

5.3.7 Defining Disposition Codes

A disposition code identifies the product class and inventory status to be assigned to the inventory being received.

The valid list of disposition codes are typically managed as a central repository. The disposition code and description are automatically defaulted by the system for the appropriate type of order from the Reverse Logistics department, who typically own the disposition codes for the inventory.

Use Disposition Codes for:

- [Creating a Receiving Disposition Code](#)
- [Modifying a Receiving Disposition Code](#)

5.3.7.1 Creating a Receiving Disposition Code

To create a receiving disposition code:

1. From the tree in the application rules side panel, choose Receiving > Document Specific > Purchase Order > Disposition Codes.
2. The Disposition Code : Purchase Order window displays.
3. Enter information in the applicable fields. Refer [Table 5–21](#) for field value descriptions.
4. Choose .

Disposition Code	Description	Product Class	Inventory Status
STOCKED	STOCKED	SFC	
SENT_FOR_REPAIR	Sent For Repair	SFC	

Results 2 Of 0

Table 5–21 Receiving Disposition : Purchase Order Window

Field	Description
Disposition Code	The disposition code displays.
Description	The description associated with the disposition code displays.
Product Class	Indicates the product class for the disposition.
Inventory Status	Choose the inventory status for the disposition. This is a mandatory field, and needs to be entered.

Inventory is received with the specified product class and inventory status of the disposition code entered.

If the product class is not specified, the product class from the purchase order or the default product class from the item is used. It is mandatory to have the product class specified at one of these levels.

The disposition codes allow inspectors to utilize their terminology, instead of understanding inventory and storage implications.

5.3.7.2 Modifying a Receiving Disposition Code

Once a Receiving Disposition Code has been created, it can be modified.

To modify a receiving disposition code:

1. From the tree in the application rules side panel, choose Receiving > Document Specific > Purchase Order > Disposition Codes.
2. The Disposition Code : Purchase Order window displays with the list of existing dispositions.
3. Enter information in the applicable fields. Refer [Table 5–21](#) for field value descriptions.
4. Choose .

Only the inventory status associated with the disposition may be modified. The change of inventory status is applied to all future transactions.

5.4 Defining Transfer Order

A transfer order in the Sterling WMS indicates transfers between the network of warehouses. A transfer order is received in multiple shipments. A transfer consists of a replenishment order from a regional distribution center or a transfer of items from another distribution center.

The ability to configure receiving processes for a transfer order in the warehouse is detailed here.

Use Transfer Order set-up for:

- [Defining Receipt Modification Rules](#)
- [Defining Receipt Process Type Details](#)
- [Defining Receipt Process Model](#)

- [Defining Receiving Preference](#)
- [Defining Receiving Disposition](#)
- [Defining Disposition Codes](#)

5.4.1 Defining Receipt Modification Rules



Most order document types flow through a pipeline without requiring any intervention by a customer service representative. However, there are times when modifications are required, such as changing credit card information or quantity. Selling and Fulfillment Foundation supports modifications through the Console and APIs. It is critical for you to decide which modifications are allowed for each modification type, modification level, and status combination.

Important: Contemplate business and system integration implications before allowing a modification that is disallowed as part of the system defaults.

For more information about modification rules, see the *Sterling Distributed Order Management: Configuration Guide*.

5.4.2 Setting Up Receipt Modification Rules

To set up receipt modification rules:

1. From the tree in the application rules side panel, choose Receiving > Document Specific > Transfer Order > Receipt Modification Rules. The Modification Rules window displays.
2. In the Modification Rules window, select the Transfer Order Receipt whose Modification Rule is to be set. Refer [Table 5–22](#) for field value descriptions.
3. Choose  to allow order modification.
4. Choose  to disallow order modification.
5. Choose  to ignore order modification.

For more information about defining and changing modification rules, see the *Sterling Distributed Order Management: Configuration Guide*.

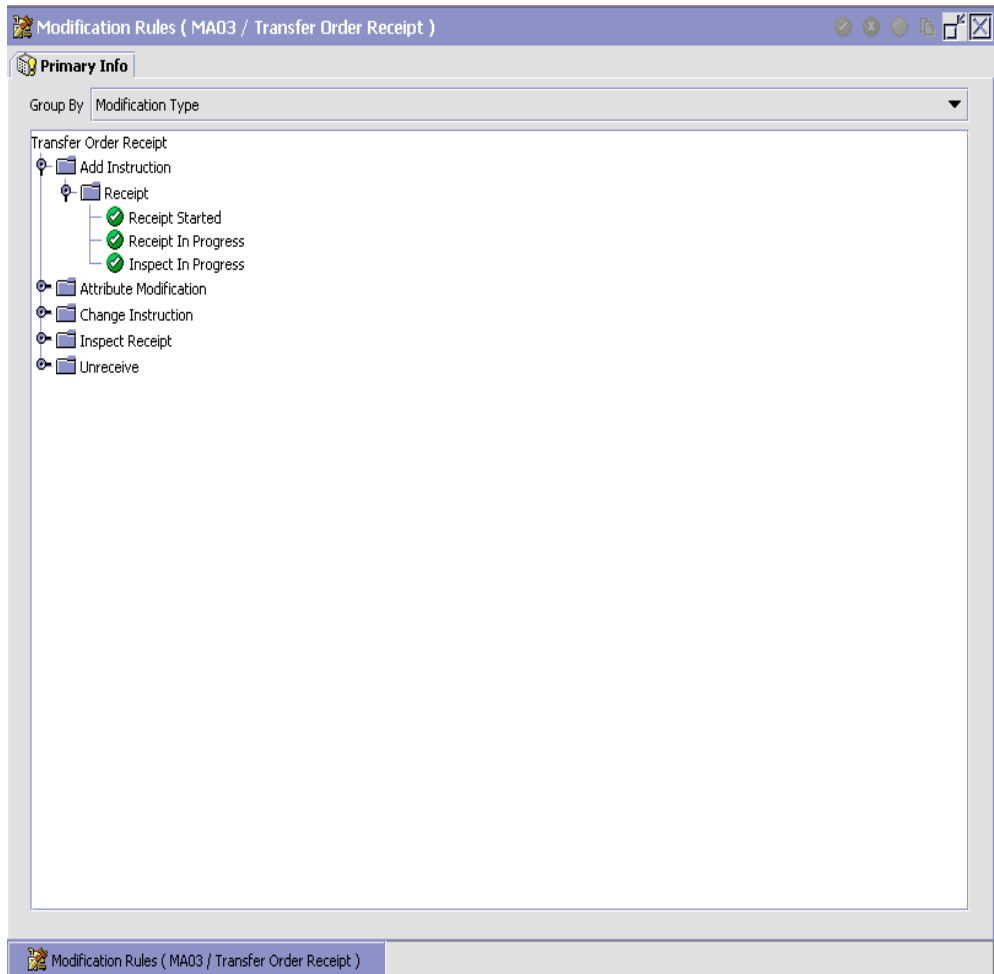

Table 5–22 Modification Rules Window

Field	Description
Primary Info	
Group by	View the Transfer Order Receipt Modification Rules grouped by Modification Type, Modification Level, or by Status.

Table 5–22 Modification Rules Window

Field	Description
Modification Type	Transfer Order Receipt Modification Rules grouped by Modification Type. Statuses display grouped by Modification Level for each Modification Type.
Add Instruction	Allow or Disallow or Ignore addition of instruction appropriately.
Attribute Modification	Allow or Disallow or Ignore modification of an attribute appropriately.
Change Instruction	Allow or Disallow or Ignore change of instruction appropriately.
Receipt Complete	Allow or Disallow or Ignore completion of receipt appropriately.
Unreceive	Allow or Disallow or Ignore un-receiving of a return order appropriately.
Modification Level	Transfer Order Modification Rules grouped by Modification Level. Statuses display grouped by Modification Type for each Modification Level.
Receipt	Allow or Disallow or Ignore modification types at receipt level appropriately.
Status	Transfer Order Receipt Modification Rules grouped by Status. Modification Types display grouped by Modification Level for each Status. For more information about group by status, see Section 5.4.4.6, "Statuses" on page 368.

For more information about Modification Rules, see the *Sterling Distributed Order Management: Configuration Guide*.

5.4.3 Defining Receipt Process Type Details

Receipt Process Type Details define parameters and templates that distinguish a process type.

A **process type pipeline** is a series of transactions and statuses that guide document types, such as a Transfer Order, through a predefined process. A pipeline consists of the different statuses a document goes through during fulfillment, negotiation, shipment, or receipt. You can also

set up transactions consisting of events, actions, and conditions, as they pertain to the pipeline you are configuring.

Repositories

A repository is a logical collection of entities that define the business process workflow.

The following entities are included in a repository:

- Pipelines
- Transactions
- Statuses
- Conditions
- Actions
- Services

Selling and Fulfillment Foundation provides a base repository for each of the system-defined process types. Some of the entities within a repository are copied when creating a new document type. For more information about creating a new document type, see the *Selling and Fulfillment Foundation: Application Platform Configuration Guide*.

For more information about defining process type details, see the *Selling and Fulfillment Foundation: Application Platform Configuration Guide*.

5.4.3.1 Viewing Receipt Process Type Details

To view transfer order receipt process type details:

1. From the tree in the application rules side panel, choose Receiving > Document Specific > Transfer Order > Receipt Process Type Details. The Process Type Details : Transfer Order window displays.
2. Primary information of the Process Type displays in the applicable fields. Refer [Table 5–23](#) for field value descriptions.

For more information about defining the primary information for process type details, see the *Selling and Fulfillment Foundation: Application Platform Configuration Guide*.

Table 5–23 *Process Type Details Window*

Field	Description
Primary Info	
Process Type	This is automatically populated by the system as "TO_RECEIPT".

Table 5–23 Process Type Details Window

Field	Description
Process Type Name	This indicates the name of the process type.
Description	This provides a brief description for the process type.

5.4.4 Defining Receipt Process Model

The process of receiving is modeled through a pipeline. This represents the process configuration that is unique to a warehouse. A warehouse may also specify unique processes for each participating enterprise.

For example, a warehouse that performs re-packaging (VAS) for certain items in the warehouse or a warehouse that always palletizes all receipts before putaway to storage area.

5.4.4.1 Pipeline Determination

Pipeline determination is used to set up conditions that affect which pipeline is used during the start of the business process workflow. For example, an organization deals with sales orders that sometimes contain hazardous materials. They have two separate pipelines, one in which orders with order lines without any hazardous materials go through and one in which orders with order lines containing hazardous materials must go through for inspection before continuing through the order process. The organization uses pipeline determination to set up a condition that determines whether or not order lines contain hazardous materials and sends the order line down the correct pipeline.

For more information about Pipeline Determination, see the *Selling and Fulfillment Foundation: Application Platform Configuration Guide*.

5.4.4.2 Hub Rule

When you expand the Pipeline Determination branch, the components display depends on what role you are logged in as. If you are logged in as a Hub role, the Hub Rule displays. If you are logged in as an Enterprise role, both the Hub Rule and all user created determination rules (For example, My Rule) components display. Double-click on the applicable rule to display the pipeline determination rules.

Note: If you are logged in as an Enterprise role, the Hub Rule screen is grayed out and cannot be modified.

Drag conditions and pipelines into the work area to construct pipeline determination rules. A single pipeline or condition must be the root. Conditions cannot link back to an earlier component in the chain and a pipeline cannot be linked to twice.

Note: When configuring pipeline determination for an order document type pipeline, note that pipeline determination is only considered when adding a line or creating an order. When changes are made to draft orders pipeline determination does not occur.

5.4.4.3 Condition Variables for Pipeline Determination

When using conditions for pipeline determination, the following condition variables can be used:

- Document Type
- Enterprise Code
- Seller Organization Code
- Ship Node
- Buyer Organization Code
- Receiving Node
- Receiving Node Interface Type
- Ship Mode
- Freight Terms
- Carrier Type
- Is Hazardous Material
- Is Inspection Pending
- Is Receiving Node Integrated Real Time

For more information about Pipeline Determination and Hub Rule, see the *Selling and Fulfillment Foundation: Application Platform Configuration Guide*.

5.4.4.4 Pipelines

For more information about pipelines, see the *Selling and Fulfillment Foundation: Application Platform Configuration Guide*.

To view the transfer order receipt pipeline details:

1. From the tree in the application rules side panel, choose Receiving > Document Specific > Transfer Order > Receipt Process Model. The Transfer Order Receipt window displays.

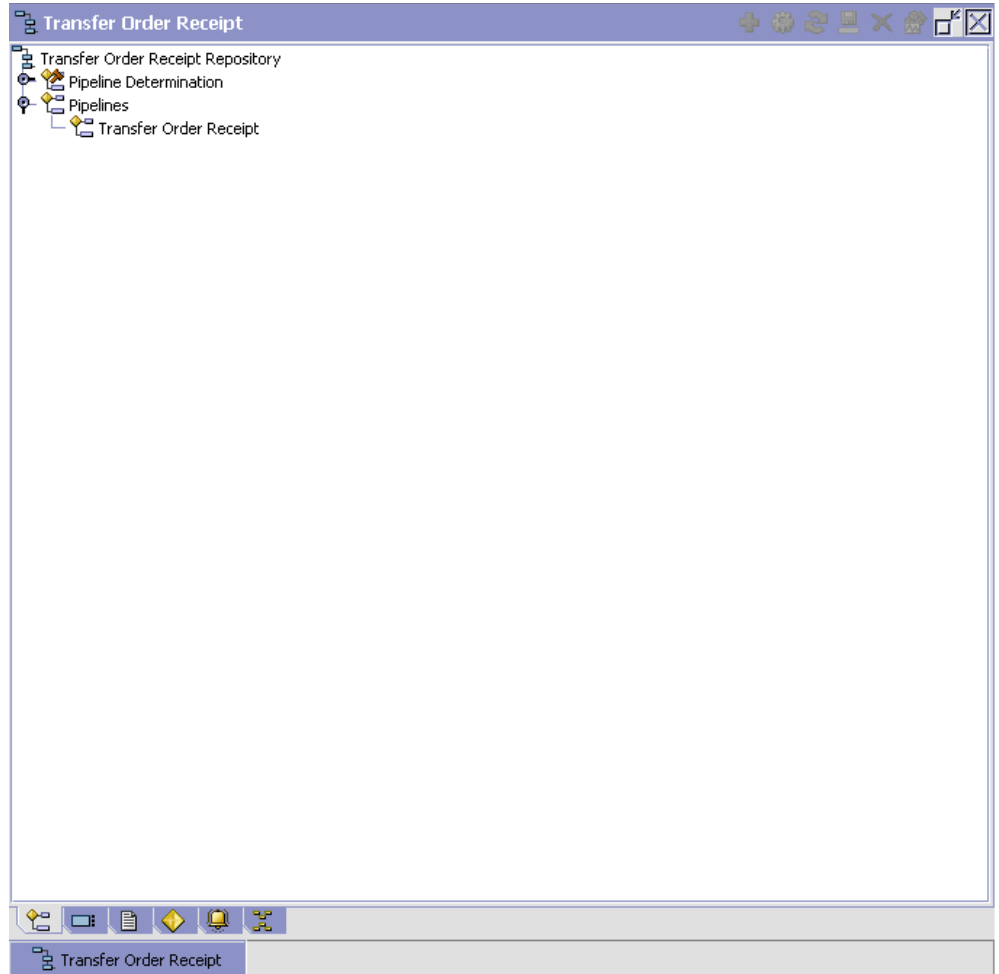

2. In the Transfer Order Receipt window, choose Transfer Order Receipt Repository > Pipelines > Transfer Order Receipt.
3. The Pipeline Detail: Transfer Order Receipt (Transfer Order Receipt) window displays.

For more information about creating and modifying a pipeline, see the *Selling and Fulfillment Foundation: Application Platform Configuration Guide*.

1. From the tree in the application rules side panel, choose Receiving > Document Specific > Transfer Order > Receipt Process Model. The Transfer Order Receipt window displays.
2. In the Transfer Order Receipt window, choose .
3. The Transactions tab window displays.

For more information about creating and modifying transactions, see the *Selling and Fulfillment Foundation: Application Platform Configuration Guide*.

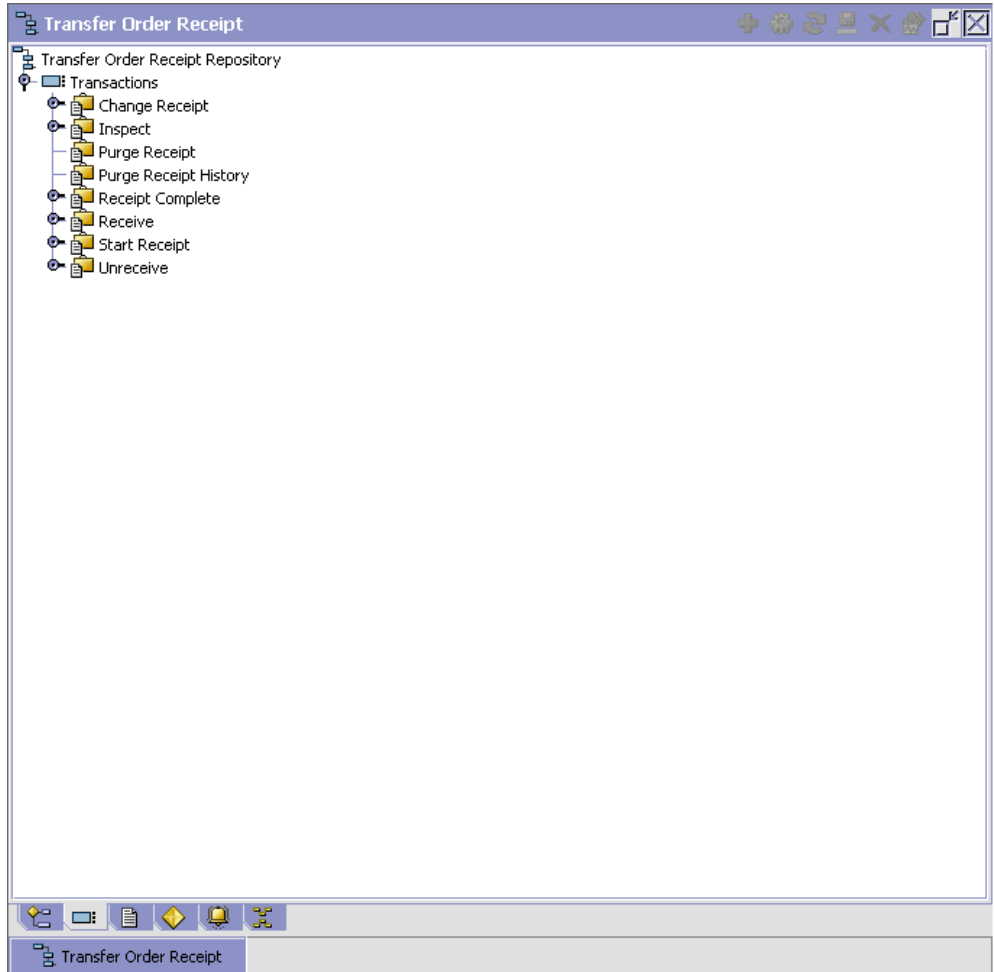

Table 5–24 Transfer Order Receipt Pipeline - Transactions Tab Window

Field	Description
Change Receipt	This transaction represents the receipt details being modified after a receipt for a shipment is recorded.
Close Pre Receipt	This transaction represents the closure of pre-receipts for a shipment. Pre-receipt allows a warehouse to indicate the receipt of containers for a shipment. The visibility provided to the other departments allows for exception handling. For example, during item shortage in the pick areas, supervisors monitor incoming shipments to request for emergency receipt of a particular shipment.
Inspect	This transaction represents the step of inspecting a shipment. This is required to complete the disposition of product received.
Pre Receive	This transaction represents a shipment may be pre-received before it is actually received in the warehouse.
Purge Receipt	This transaction represents a shipment that may be purged (moved out of) from primary transactional tables to the history tables. For more information about purge criteria, see Section 12.8, "Defining Purge Criteria" on page 940.
Purge Receipt History	This transaction represents a shipment may now be purged (moved out of) from the history tables. For more information about purge criteria, see Section 12.8, "Defining Purge Criteria" on page 940.
Receipt Complete	This transaction represents the completion of receipt of a shipment. It is invoked automatically from receipt screens or manually from a console or through the close receipt agent.
Receive	This transaction represents receipt of product on a shipment.
Start Receipt	This transaction represents the opening of a receipt for shipment. This is invoked either manually from a console or automatically invoked from consoles or RF.
Unreceive	This transaction represents the correction of received quantity against a shipment.

5.4.4.6 Statuses

Statuses are the actual states that a document moves through in the pipeline. A transaction can contain two types of statuses, a drop status and a pickup status. A document is moved into a **drop status** when the events and conditions of a transaction have been completed. A **pickup status** takes the document from the previous drop status and moves it through the next transaction. Created and Scheduled are examples of statuses.

For more information about Statuses, see the *Selling and Fulfillment Foundation: Application Platform Configuration Guide*.

To view the status details of a transfer order receipt pipeline:

1. From the tree in the application rules side panel, choose Receiving > Document Specific > Transfer Order > Receipt Process Model. The Transfer Order Receipt window displays.
2. In the Transfer Order Receipt window, choose .
3. The Statuses tab window displays.

For more information about creating and modifying statuses, see the *Selling and Fulfillment Foundation: Application Platform Configuration Guide*.

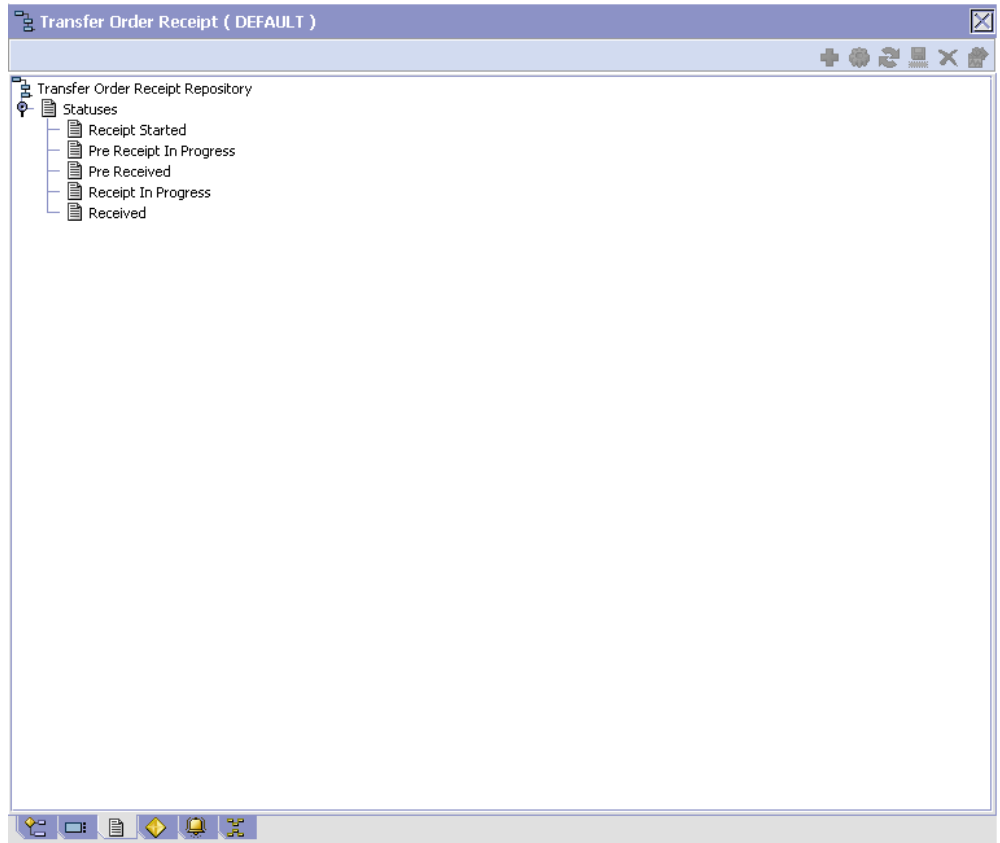

Table 5–25 Transfer Order Receipt Pipeline - Statuses Tab Window

Field	Description
Receipt Started	This indicates that the shipment is opened for receipt. This corresponds to 'Start Receipt' transaction.
Pre Receipt In Progress	This indicates that pre-receipt for the shipment is in progress. This corresponds to 'Pre-receive' transaction.

Table 5–25 Transfer Order Receipt Pipeline - Statuses Tab Window

Field	Description
Pre Received	This indicates that pre-receipt process for the shipment is completed. This corresponds to 'Close-PreReceipt' transaction.
Receipt In Progress	This indicates that receiving for the shipment is in progress. This corresponds to 'Receive' or 'Un-Receive' transactions.
Received	This indicates that receiving for the shipment is complete. This corresponds to 'Receipt Complete' transaction.

5.4.4.7 Conditions

A **condition** matches document type attributes against decision points and routes the documents to different paths based on the specified attribute and value combinations. The document type attributes against which conditions can be created are predefined in Selling and Fulfillment Foundation. You can use these attributes in any combination or you can create conditions that run the appropriate application logic for specific circumstances.

For more information about Conditions, see the *Selling and Fulfillment Foundation: Application Platform Configuration Guide*.

To view the condition details of a transfer order receipt pipeline:

1. From the tree in the application rules side panel, choose Receiving > Document Specific > Transfer Order > Receipt Process Model. The Transfer Order Receipt window displays.
2. In the Transfer Order Receipt window, choose .
3. The Conditions tab window displays.

For more information about creating and modifying conditions, see the *Selling and Fulfillment Foundation: Application Platform Configuration Guide*.

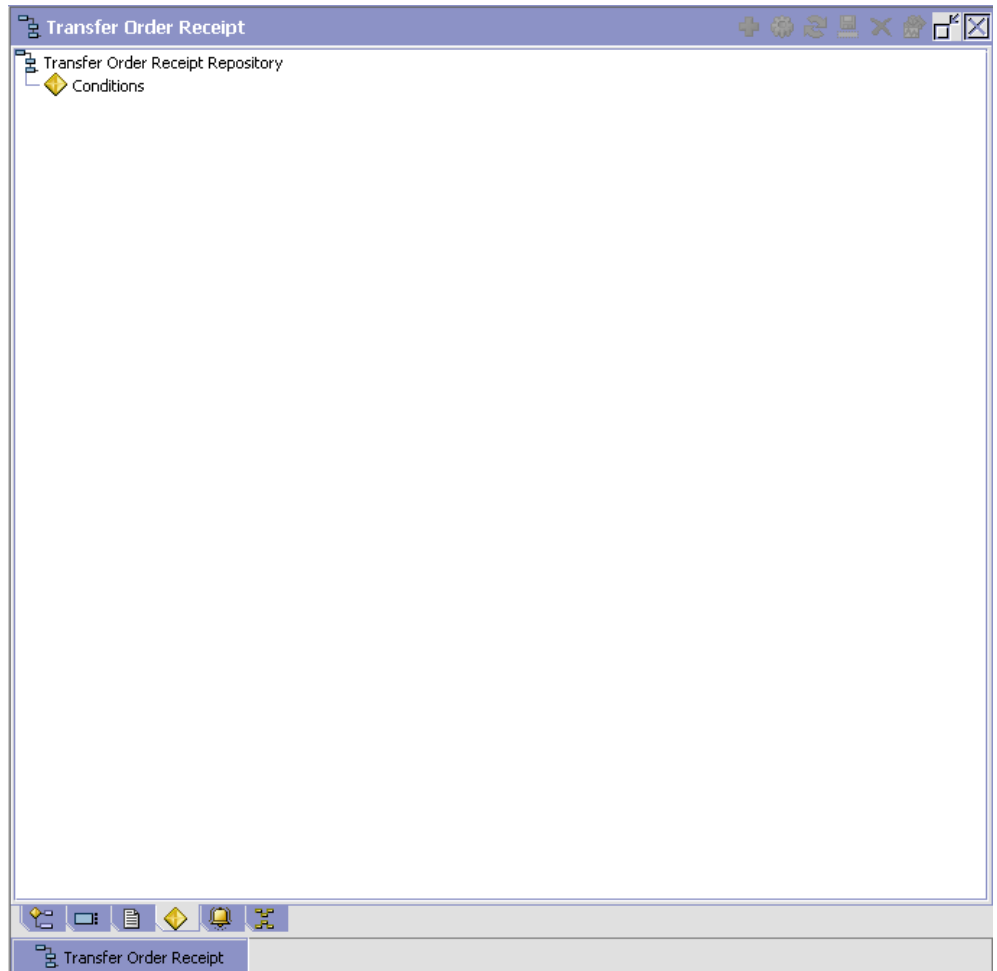

Table 5–26 *Transfer Order Receipt Pipeline - Conditions Tab Window*

Field	Description
Conditions	Displays conditions that are specific to the transfer order receipt pipeline, if any.

The Sterling WMS default pipeline does not have any conditions specified.

5.4.4.8 Actions

An **action** is a process or program that is triggered by an event. These processes and programs send user alert notifications and automatically resolve issues.

For example, when an order is released (the event), you can set an action to send the customer an e-mail.

For more information about Actions, see the *Selling and Fulfillment Foundation: Application Platform Configuration Guide*.

To view the action details of a transfer order receipt pipeline:

1. From the tree in the application rules side panel, choose Receiving > Document Specific > Transfer Order > Receipt Process Model. The Transfer Order Receipt window displays.
2. In the Transfer Order Receipt window, choose .
3. The Actions tab window displays.

For more information about creating and modifying actions, see the *Selling and Fulfillment Foundation: Application Platform Configuration Guide*.

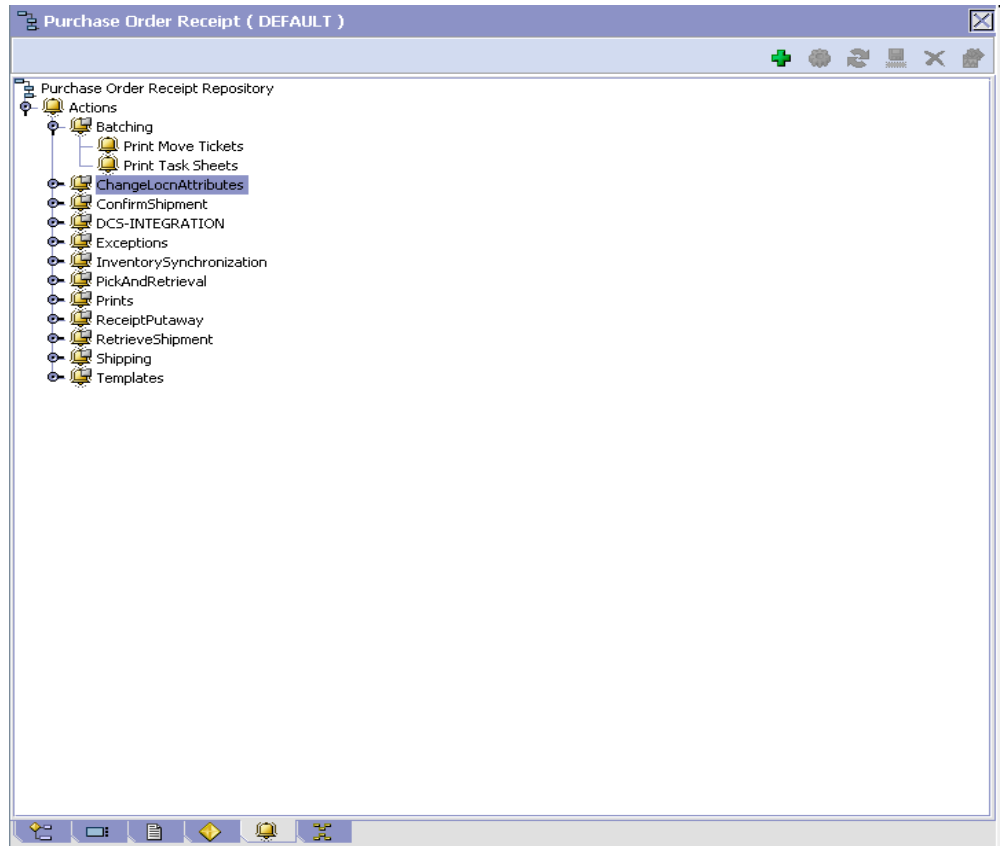

Table 5–27 *Transfer Order Receipt Pipeline - Actions Tab Window*

Field	Description
Batching	Default settings are provided for: Print Move Tickets – Invokes the batch printing service for printing the move tickets. Print Task Sheets – Invokes the batch print service for printing the task sheets.
ChangeLocnAttributes	

Table 5–27 Transfer Order Receipt Pipeline - Actions Tab Window

Field	Description
ConfirmShipment	Default settings are provided for: ConfirmShipment – Invokes the confirmShipment flow to confirm the shipment.
DCS-Integration	Default settings are provided for: InventoryDownload – Invokes the YantraWMSInventoryDownloadService service to download the inventory information from Selling and Fulfillment Foundation to DCS. PODownload – Invokes the YantraWMSPODownloadService service to download the Purchase Order information from Selling and Fulfillment Foundation to DCS.
Exceptions	Default settings are provided for: ShortagesDetected – Invokes the LogWavePlafailure exception service when shortage of inventory occurs during wave release.
InventorySynchronization	Default settings are provided for: CollectInventoryMismatch – This service collects the inventory mismatch information between an external system and Selling and Fulfillment Foundation. This is typically caused when some inventory updates at a node or a warehouse are not reported to Selling and Fulfillment Foundation.
PickAndRetrieval	Default settings are provided for: ConfirmEmptyLocationAfterPick – Invokes the GenerateCountRequest flow which creates a count request.

Table 5–27 Transfer Order Receipt Pipeline - Actions Tab Window

Field	Description
Prints	<p>Default settings are provided for:</p> <p>PickList Print – Invokes the print service for printing the Pick List.</p> <p>LTL Manifest – Invokes the print service for printing the Less-than Truck Load Manifest.</p> <p>Print Load BOL – Invokes the print service for printing the Load Bill of Lading.</p> <p>Print PackList – Invokes the print service for printing the Pack List.</p> <p>Print Post Pick Container Labels – Invokes the print service for printing UCC-128 container labels for containers, when system defined packing process is used.</p> <p>Print Shipment BOL – Invokes the print service for printing the Shipment Bill of Lading.</p> <p>Print Shipping Label – Invokes the print service for printing the UCC-128 container labels.</p> <p>Print Wave – Invokes the Print service for printing a Wave.</p>
ReceiptPutaway	<p>Putaway products on receipt closure – Indicates the default action provided to automatically initiate putaway of purchase order receipts.</p>
RetrieveShipment	<p>Retrieve Requested Serial – This service invokes the retrieveShipment API to retrieve the requested serials to the specified location.</p>

Table 5–27 Transfer Order Receipt Pipeline - Actions Tab Window

Field	Description
Shipping	<p>Default settings are provided for:</p> <p>Load Left Origin – Invokes the doLoadLeftOriginUpdates service to mark that the load has left the origin.</p> <p>Stop Shipping – Invokes the RaiseStopShippingAlert service to raise an alert to stop the processing of the shipment.</p>
Templates	<p>Default settings are provided for:</p> <p>Log Exception – Logs the reasons due to which a count request could not be created for a Count Program.</p> <p>Publish Data – Sends data to external queue or internal tables.</p> <p>Raise Exception – Raises an alert using Event Management from the published information.</p> <p>Send Email – Raises an email action to create an email in the template format from the published information.</p> <p>Send Email-HTML format – Raises an email action to create an email in HTML format from the published information.</p>

5.4.4.9 Service Definitions

Service definitions are a representation of the logic that regulates document workflow services. The Service Builder is a graphical interface that enables you to create a graphical representation of these *services*.

For more information about Service Definitions, see the *Selling and Fulfillment Foundation: Application Platform Configuration Guide*.

To view the service definition details of a transfer order receipt pipeline:

1. From the tree in the application rules side panel, choose Receiving > Document Specific > Transfer Order > Receipt Process Model. The Transfer Order Receipt window displays.
2. In the Transfer Order Receipt window, choose .
3. The Service Definitions tab window displays.

For more information about creating and modifying Service Definitions, see the *Selling and Fulfillment Foundation: Application Platform Configuration Guide*.

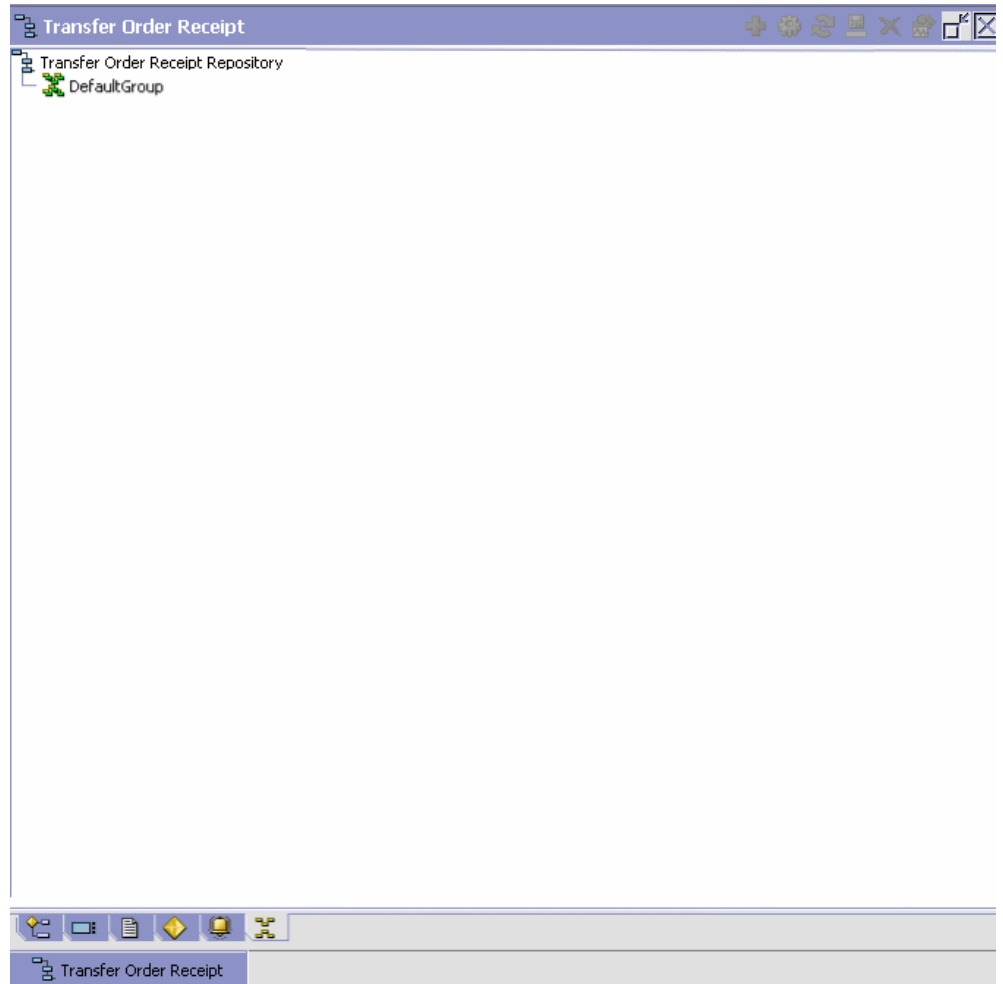

Table 5–28 Transfer Order Receipt Pipeline - Service Definition Tab Window

Field	Description
Default Group	Displays flows that are specific to the transfer order receipt pipeline.

The Sterling WMS default pipeline does not have any conditions specified.

5.4.5 Defining Receiving Preference

The receiving preference configuration manages the receiving process of a warehouse.

A receiving preference identifies the characteristics of inbound shipments and provides guidelines to the execution transactions.

Use Receiving Preferences for:

- [Creating a Receiving Preferences](#)
- [Modifying a Receiving Preference](#)

5.4.5.1 Creating a Receiving Preferences

To create a receiving preference:

1. From the tree in the application rules side panel, choose Receiving > Document Specific > Transfer Order > Receiving Preferences.
2. The Receiving Preferences : Transfer Order window displays.
3. Enter information in the applicable fields. Refer [Table 5–29](#) for field value descriptions.
4. Choose .

Receiving Rules : Transfer Order : DEFAULT (DEFAULT / MA03)

Shipment entry allowed

Build Pallet

Always Optional

If Item Tag or Serial tracked

Build Case

Always Optional

If Item Tag or Serial tracked

Disposition Code

Receipt with QC

Receipt without QC

Preference for receipt closure by agent

Unconditionally Received quantity at least equal to expected quantity After Put away completion

Vendor Preferences

Vendor	Vendor Classification	Item ID	Item Classification	Force Case Content entry	Requires QC

Results 0

Receiving Rules : Transfer Order : DEFAULT (DEFAULT / MA03)

Table 5–29 Receiving Preferences : Transfer Order Window

Field	Description
Shipment Entry Allowed	Select if shipment entry is to be created when a particular shipment is not available on the system. "Allow Shipment Entry" enables the system to automatically create a shipment entry in the system, if a shipment entry does not exist when a "Start Receipt" operation is performed. On creation and confirmation of the shipment, the "Include in Receipt" transaction is invoked, to enable the receiving process to be carried out on this receipt. Warehouses that receive shipment information in fax or email form can manually enter the information into the system. This allows for enhanced tracking and visibility.
Build Pallet	
Always	Select if building of a pallet is mandatory during the receipt process.
Optional	Select if building of a pallet is optional.
If Item Tag or Serial Tracked	Select if building of pallet is required for items that are tag or serial tracked.
Build Case	
Always	Select if building of case is mandatory during the receipt process.
Optional	Select if building of case is optional.
If Item Tag or Serial tracked	Select if building of case is required for items that are tag or serial tracked.
Disposition Code	
Receipt with QC	Choose the disposition code to associate with receipts for vendors or shipments that require QC.
Receipt without QC	Choose the disposition code to associate with receipts for vendors or shipment that do not require QC.
Preference for Receipt Closure by Agent	

Table 5–29 Receiving Preferences : Transfer Order Window

Field	Description
Unconditionally	Select if receipt closure by the agent occurs every time the closure agent is run. This is typically used where receipts are closed as end-of-day process.
Received quantity at least equal to expected quantity	Select if receipt closure by the agent occurs when the received quantity is at least equal to the expected quantity.
After Putaway Completion	Select if receipt closure by the agent occurs after putaway is completed. This applies to warehouses that indicate availability only when inventory is putaway to their storage locations.
Vendor Preferences	Populated automatically from vendor preferences in Sterling Supply Collaboration. The preferences are evaluated to determine the best preference. The preference with most matches to the order details is determined as the best preference. For more information about defining Customer Classifications, see the <i>Sterling Supply Collaboration: Configuration Guide</i> .
Vendor	This indicates the vendor. A vendor is defined as an external company that supplies materials that you order. You receive materials from your vendors. You are, in turn, vendors to your customers.
Vendor Classification	This indicates classification of the vendor.
Item ID	This indicates item ID.
Item Classification	This indicates the custom defined item storage definition.
Force Case Content entry	This indicates whether case content entry during receipt must be forced.
Requires QC	This indicates whether QC is required or not.

The closure of a shipment triggers the upload of receipt information to external HOST systems is updated in Sterling Supply Collaboration. For

example, inventory availability for the shipment is moved from an in-transit to on-hand.

Vendor-specific preferences, if any, configured as part of the Sterling Supply Collaboration displays here. For more information, see the *Sterling Supply Collaboration: Configuration Guide*.

Preferences for receiving a shipment are specified as a receiving preference for the ship node and enterprise level. A supervisor, may choose to override these preferences for a specific vendor. For example, a ship node requiring case content verification for most vendors. For a particular vendor a supervisor can override this requirement while manually creating shipment.

The feature of override is only relevant when the preference has been set forcing a granular activity. For example, override is not relevant for a ship node that does not require pallet content verification at a vendor level.

5.4.5.2 Modifying a Receiving Preference

Once a Receiving Preference has been created, it can be modified.

To modify a receiving preference:

1. From the tree in the application rules side panel, choose Receiving > Document Specific > Transfer Order > Receiving Preference.
2. The Receiving Preferences : Transfer Order window displays with the list of existing rules.
3. Enter information in the applicable fields. Refer [Table 5–29](#) for field value descriptions.
4. Choose .

Any modification to a receiving preference is applied to all future transactions.

5.4.6 Defining Receiving Disposition

You can define common codes for receiving dispositions used when handling a receipt. This common code identifies what happens to items for the document type when they are received.

Use Receiving Disposition for:



- [Creating a Receiving Disposition](#)
- [Creating a New Receiving Disposition From an Existing Receiving Disposition](#)
- [Modifying a Receiving Disposition](#)
- [Deleting a Receiving Disposition](#)

5.4.6.1 Creating a Receiving Disposition

To create a receiving disposition:

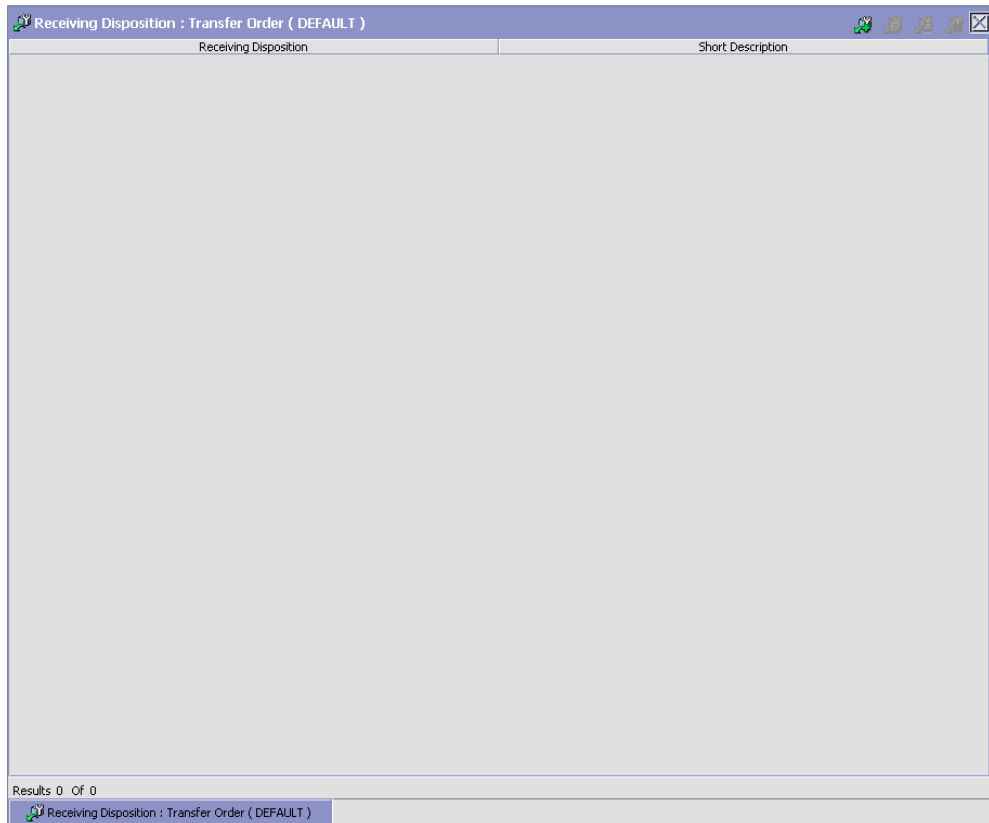
1. From the tree in the application rules side panel, choose Receiving > Document Specific > Transfer Order > Receiving Disposition.
2. The Receiving Disposition : Transfer Order window displays.



3. In the Receiving Disposition : Transfer Order window, choose . The Disposition Details pop-up window displays.
4. Enter information in the applicable fields. Refer [Table 5–30](#) for field value descriptions.
5. Choose .

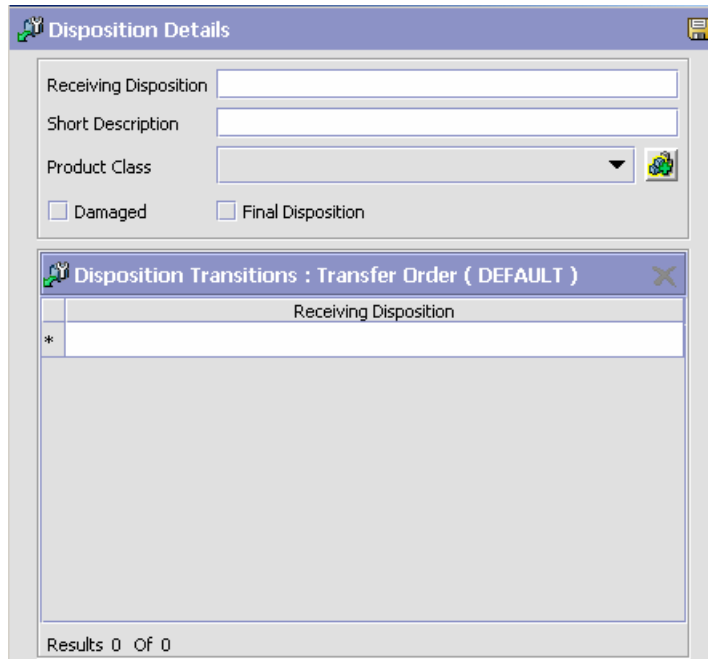

Table 5–30 *Disposition Details Pop-up Window*



Field	Description
Receiving Disposition	Enter the name of the receiving disposition.
Short Description	Enter a brief description of the receiving disposition.
Product Class	Select a product class to associate with received items, if applicable. For example, you could assign the product class of Returned to any returned items.
Damaged	Select Is Damaged if the receiving disposition is used for handling damaged items.
Final Disposition	Select Final Disposition if the receiving disposition is to be used as final disposition for the receipt. Final Disposition marks the disposition code as final, and does not allow any further disposition transitions.

Table 5–30 *Disposition Details Pop-up Window*

Field	Description
Disposition Transitions	This displays the existing Receiving Disposition codes that are available for associating a transition with the Receiving Disposition being created or modified.
Receiving Disposition	Existing Receiving Disposition Code available for transition association.

5.4.6.2 Creating a New Receiving Disposition From an Existing Receiving Disposition

To create a new receiving disposition from an existing receiving disposition:

1. From the tree in the application rules side panel, choose Receiving > Document Specific > Transfer Order > Receiving Disposition.
2. The Receiving Disposition : Transfer Order window displays with the list of Receiving Dispositions.
3. Choose the Receiving Disposition to be copied from. Choose . The Disposition Details pop-up window displays.
4. Enter information in the applicable fields. Refer [Table 5–30](#) for field value descriptions.
5. Choose .

5.4.6.3 Modifying a Receiving Disposition

Once a Receiving Disposition has been created, it may be modified.

To modify a receiving disposition:

1. From the tree in the application rules side panel, choose Receiving > Document Specific > Transfer Order > Receiving Disposition.
2. The Receiving Disposition : Transfer Order window displays with the list of Receiving Dispositions.
3. Select the Receiving Disposition to be modified. Choose . The Disposition Details pop-up window displays.
4. Enter information in the applicable fields. Refer [Table 5–30](#) for field value descriptions.

5. Choose .

5.4.6.4 Deleting a Receiving Disposition

To delete a receiving disposition:

1. From the tree in the application rules side panel, choose Receiving > Document Specific > Transfer Order > Receiving Disposition.
2. The Receiving Disposition : Transfer Order window displays with the list of Receiving Dispositions.
3. Select the Receiving Disposition to be deleted.
4. Choose .

5.4.7 Defining Disposition Codes

A disposition code identifies the product class and inventory status to be assigned to the inventory being received.

The valid list of disposition codes are typically managed as a central repository. The disposition code and description are automatically defaulted by the system for the appropriate type of order from the Reverse Logistics department, who typically own the disposition codes for the inventory.

Use Disposition Codes for:

- [Creating a Receiving Disposition Code](#)
- [Modifying a Receiving Disposition Code](#)

5.4.7.1 Creating a Receiving Disposition Code

To create a receiving disposition code:

1. From the tree in the application rules side panel, choose Receiving > Document Specific > Transfer Order > Disposition Codes.
2. The Disposition Code : Transfer Order window displays.
3. Enter information in the applicable fields. Refer [Table 5–31](#) for field value descriptions.
4. Choose .

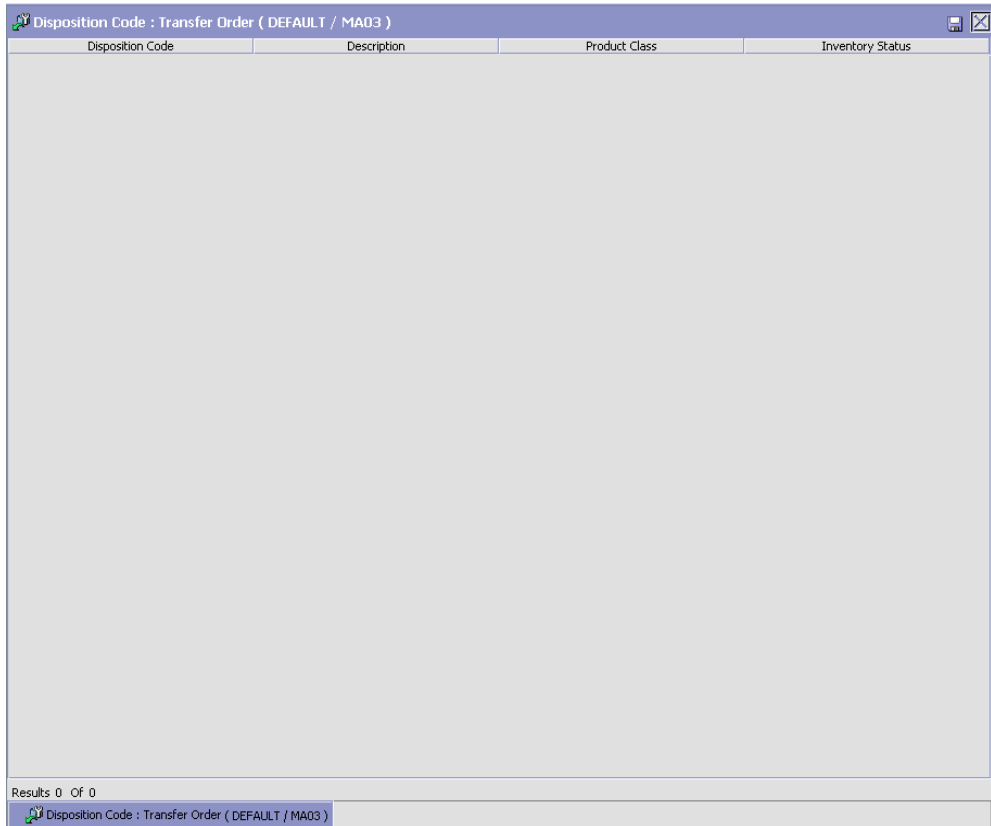

Table 5–31 Receiving Disposition Window

Field	Description
Disposition Code	The disposition code displays.
Description	The description associated with the disposition code displays.
Product Class	Indicates the product class for the disposition.
Inventory Status	Choose the inventory status for the disposition. This is a mandatory field, and needs to be entered.

Inventory is received into the specified product class and inventory status for the disposition code entered.

If the Product class is not specified, the product class from the purchase order or the default product class from the item is used. It is mandatory to have product class is specified at one of these levels.

The disposition codes allow inspectors to utilize their terminology, instead of understanding inventory and storage implications.

5.4.7.2 Modifying a Receiving Disposition Code

Once a Receiving Disposition Code has been created, it can be modified.

To modify a receiving disposition code:

1. From the tree in the application rules side panel, choose Receiving > Document Specific > Transfer Order > Disposition Codes.
2. The Disposition Code : Transfer Order window displays with the list of existing dispositions.
3. Enter information in the applicable fields. Refer [Table 5–31](#) for field value descriptions.
4. Choose .

Only the inventory status associated with the disposition may be modified. The change of inventory status is applied to all future transactions.

5.5 Defining Return Order

A return in the Sterling WMS consists of shipped items that are being returned. A return may be either authorized or arrive directly at the warehouse. The ability to implement policies governing a return is explained here.

Use Return Order set-up for:

- [Defining Receipt Modification Rules](#)
- [Defining Receipt Process Type Details](#)
- [Defining Receipt Process Model](#)
- [Defining Receiving Preferences](#)

- [Defining Receiving Disposition](#)
- [Defining Disposition Codes](#)

5.5.1 Defining Receipt Modification Rules



Most order document types flow through a pipeline without requiring any intervention by a customer service representative. However, there are times when modifications are required, such as changing credit card information or quantity. Selling and Fulfillment Foundation supports modifications through the Console and APIs. It is critical for you to decide which modifications are allowed for each modification type, modification level, and status combination.

Important: Contemplate business and system integration implications before allowing a modification that is disallowed as part of the system defaults. For example, adding instructions to a return order document type is disallowed after the release has been sent to the node.

For more information about modification rules, see the *Sterling Distributed Order Management: Configuration Guide*.

5.5.2 Setting Up Receipt Modification Rules

To set up receipt modification rules:

1. From the tree in the application rules side panel, choose Receiving > Document Specific > Return Order > Receipt Modification Rules. The Modification Rules window displays.
2. In the Modification Rules window, select the Return Receipt whose Modification Rule is to be set. Refer [Table 5–32](#) for field value descriptions.
3. Choose  to allow order modification.
4. Choose  to disallow order modification.
5. Choose  to ignore order modification.

For more information about defining and changing modification rules, see the *Sterling Distributed Order Management: Configuration Guide*.

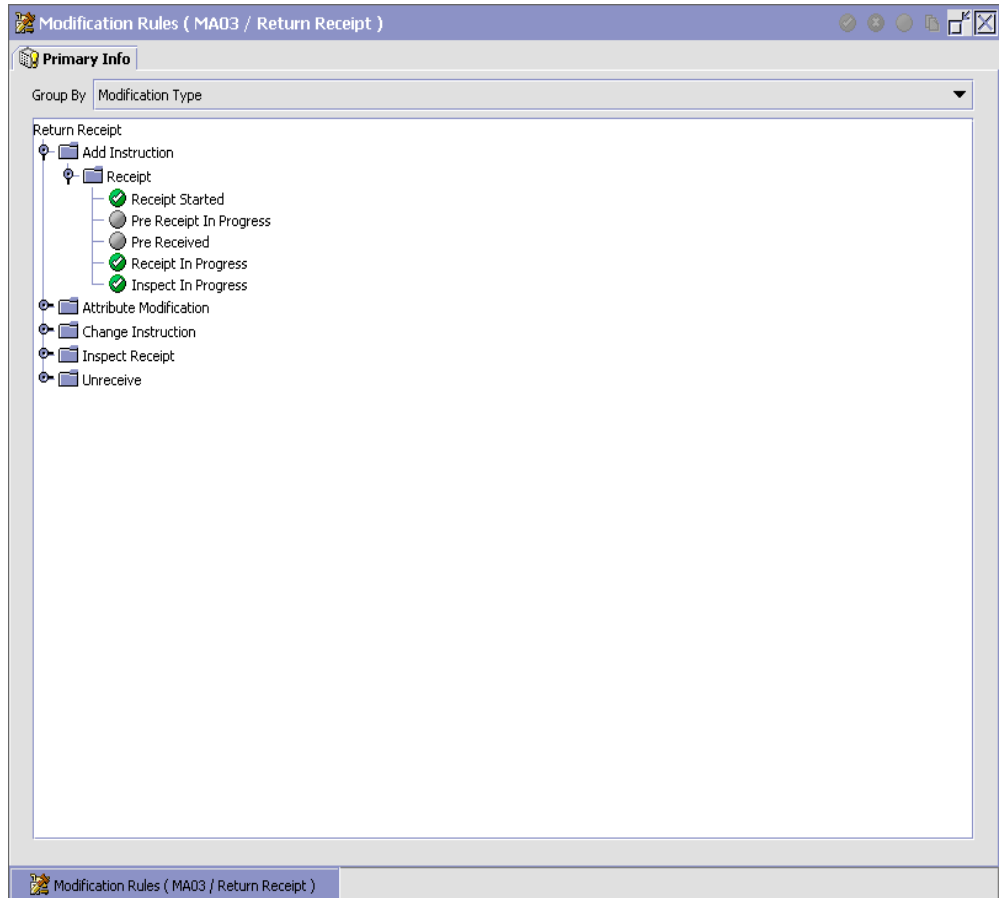

Table 5–32 *Modification Rules Window*

Field	Description
Primary Info	
Group by	View the Return Receipt Modification Rules grouped by Modification Type, Modification Level, or by Status.
Modification Type	Return Receipt Modification Rules grouped by Modification Type. Statuses display grouped by Modification Level for each Modification Type.

Table 5–32 Modification Rules Window

Field	Description
Add Instruction	Allow or Disallow or Ignore addition of instruction appropriately.
Attribute Modification	Allow or Disallow or Ignore modification of an attribute appropriately.
Change Instruction	Allow or Disallow or Ignore change of instruction appropriately.
Receipt Complete	Allow or Disallow or Ignore completion of receipt appropriately.
Unreceive	Allow or Disallow or Ignore un-receiving of a return order appropriately.
Modification Level	Return Receipt Modification Rules grouped by Modification Level. Statuses display grouped by Modification Type for each Modification Level.
Receipt	Allow or Disallow or Ignore modification types at receipt level appropriately.
Receipt Line	Allow or Disallow or Ignore modification types at receipt line level appropriately.
Status	<p>Return Receipt Modification Rules grouped by Status. Modification Types display grouped by Modification Level for each Status.</p> <p>For more information about group by status, see Section 5.5.4.6, "Statuses" on page 401.</p>

For more information about Modification Rules, see the *Sterling Distributed Order Management: Configuration Guide*.

5.5.3 Defining Receipt Process Type Details

Receipt Process Type Details define parameters and templates that distinguish a process type.

A **process type pipeline** is a series of transactions and statuses that guide document types, such as a Return Order, through a predefined process. A pipeline consists of the different statuses a document goes through during fulfillment, negotiation, shipment, or receipt. You can also set up transactions consisting of events, actions, and conditions, as they pertain to the pipeline you are configuring.

Repositories

A repository is a logical collection of entities that define the business process workflow.

The following entities are included in a repository:

- Pipelines
- Transactions
- Statuses
- Conditions
- Actions
- Services

Selling and Fulfillment Foundation provides a base repository for each of the system-defined process types. Some of the entities within a repository are copied when creating a new document type. For more information about creating a new document type, see the *Selling and Fulfillment Foundation: Application Platform Configuration Guide*.

For more information about defining process type details, see the *Selling and Fulfillment Foundation: Application Platform Configuration Guide*.

5.5.3.1 Viewing Receipt Process Type Details

To view receipt process type details:

1. From the tree in the application rules side panel, choose Receiving > Document Specific > Return Order > Receipt Process Type Details. The Process Type Details : Return Order window displays.
2. Primary information of the Process Type displays in the applicable fields. Refer [Table 5–33](#) for field value descriptions.

For more information about defining the primary information for process type details, see the *Selling and Fulfillment Foundation: Application Platform Configuration Guide*.

The screenshot shows a window titled "Process Type Details". Inside, there is a section labeled "Primary Info" containing three input fields:

- Process Type: RETURN_RECEIPT
- Process Type Name: Return Receipt
- Description: Return Receipt

Table 5–33 *Process Type Details Window*

Field	Description
Primary Info	
Process Type	This is automatically populated by the system as "RETURN_RECEIPT".
Process Type Name	This indicates the name of the process type.
Description	This provides a brief description for the process type.

5.5.4 Defining Receipt Process Model

The process of receiving is modeled through a pipeline. This represents the process configuration that is unique to a warehouse. A warehouse may also specify unique processes for each participating enterprise.

For example, a warehouse that performs re-packaging (VAS) for certain items in the warehouse or a warehouse that always palletizes all receipts before putaway to storage area.

5.5.4.1 Pipeline Determination

Pipeline determination is used to set up conditions that affect which pipeline is used during the start of the business process workflow. For example, an organization deals with sales orders that sometimes contain hazardous materials. They have two separate pipelines, one in which orders with order lines without any hazardous materials go through and one in which orders with order lines containing hazardous materials must go through for inspection before continuing through the order process. The organization uses pipeline determination to set up a condition that determines whether or not order lines contain hazardous materials and sends the order line down the correct pipeline.

For more information about Pipeline Determination, see the *Selling and Fulfillment Foundation: Application Platform Configuration Guide*.

5.5.4.2 Hub Rule

When you expand the Pipeline Determination branch, the components display depends on what role you are logged in as. If you are logged in as a Hub role, the Hub Rule displays. If you are logged in as an Enterprise role, both the Hub Rule and all user created determination rules (For example, My Rule) components display. Double-click on the applicable rule to display the pipeline determination rules.

Note: If you are logged in as an Enterprise role, the Hub Rule screen is grayed out and cannot be modified.

Drag conditions and pipelines into the work area to construct pipeline determination rules. A single pipeline or condition must be the root. Conditions cannot link back to an earlier component in the chain and a pipeline cannot be linked to twice.

Note: When configuring pipeline determination for an order document type pipeline, note that pipeline determination is only considered when adding a line or creating an order. When changes are made to draft orders pipeline determination does not occur.

5.5.4.3 Condition Variables for Pipeline Determination

When using conditions for pipeline determination, the following condition variables can be used:

- Document Type
- Enterprise Code
- Seller Organization Code
- Ship Node
- Buyer Organization Code
- Receiving Node
- Receiving Node Interface Type
- Ship Mode
- Freight Terms
- Carrier Type
- Is Hazardous Material
- Is Inspection Pending
- Is Receiving Node Integrated Real Time

For more information about Pipeline Determination and Hub Rule, see the *Selling and Fulfillment Foundation: Application Platform Configuration Guide*.

5.5.4.4 Pipelines

For more information about Pipelines, see the *Selling and Fulfillment Foundation: Application Platform Configuration Guide*.

To view the return receipt pipeline details:

1. From the tree in the application rules side panel, choose Receiving > Document Specific > Return Order > Receipt Process Model. The Return Receipt window displays.

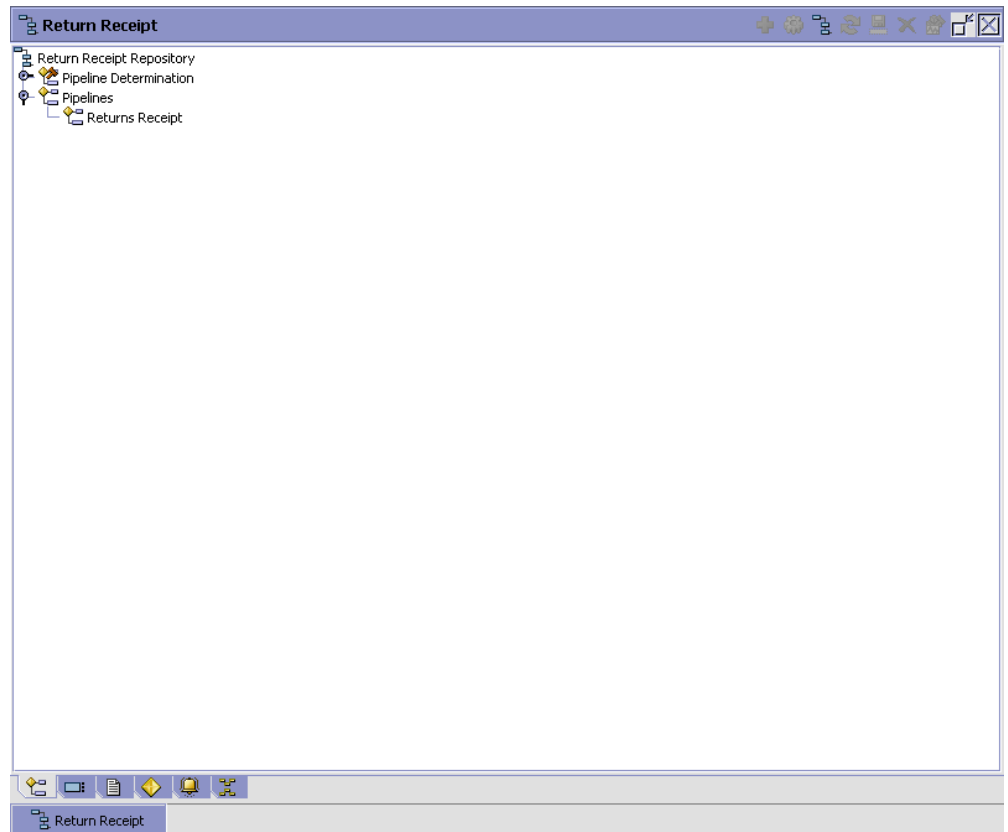

2. In the Return Receipt window, choose Return Receipt Repository > Pipelines > Returns Receipt.
3. The Pipeline Detail: Returns Receipt (Return Receipt) window displays.

For more information about creating and modifying a Pipeline, see the *Selling and Fulfillment Foundation: Application Platform Configuration Guide*.

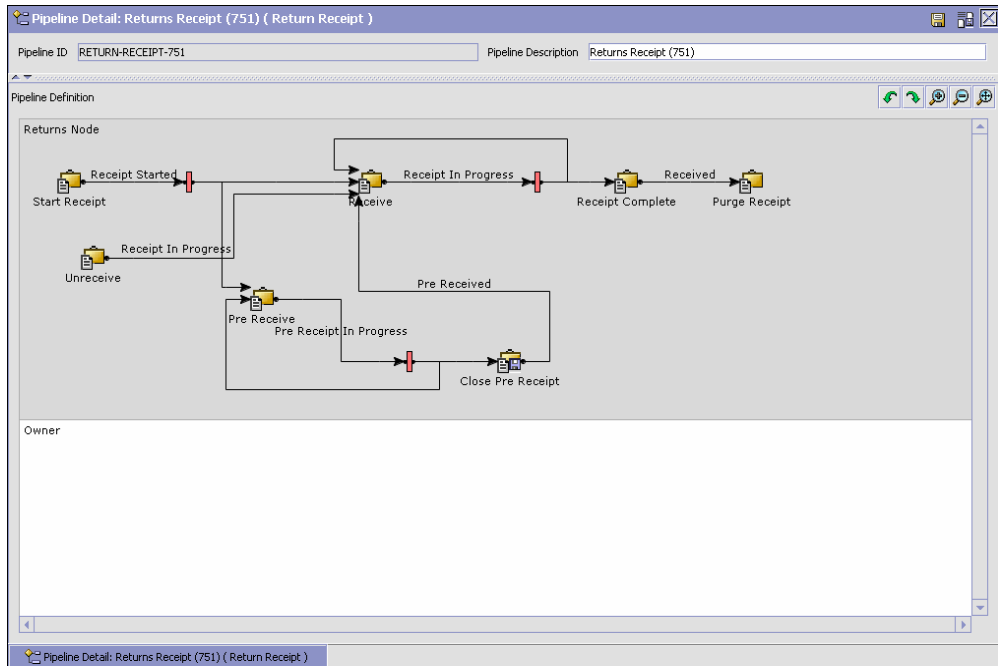

5.5.4.5 Transactions

Every process type has a set of base transactions defined for it. A transaction is a logical unit of work that is necessary for performing an activity within Selling and Fulfillment Foundation. Base transactions are predefined transactions that contain information about how the transaction behaves, such as how many copies of a transaction can be kept in a process type and whether or not it can have configurable base pick and drop statuses. Base transactions can be used to create new transactions. These transactions can be changed within the limits defined in the base transaction.

For more information about Transactions, see the *Selling and Fulfillment Foundation: Application Platform Configuration Guide*.

To view the transaction details for a return receipt pipeline:

1. From the tree in the application rules side panel, choose Receiving > Document Specific > Return Order > Receipt Process Model. The Return Receipt window displays.

2. In the Return Receipt window, choose .
3. The Transactions tab window displays.

For more information about creating and modifying Transactions, see the *Selling and Fulfillment Foundation: Application Platform Configuration Guide*.

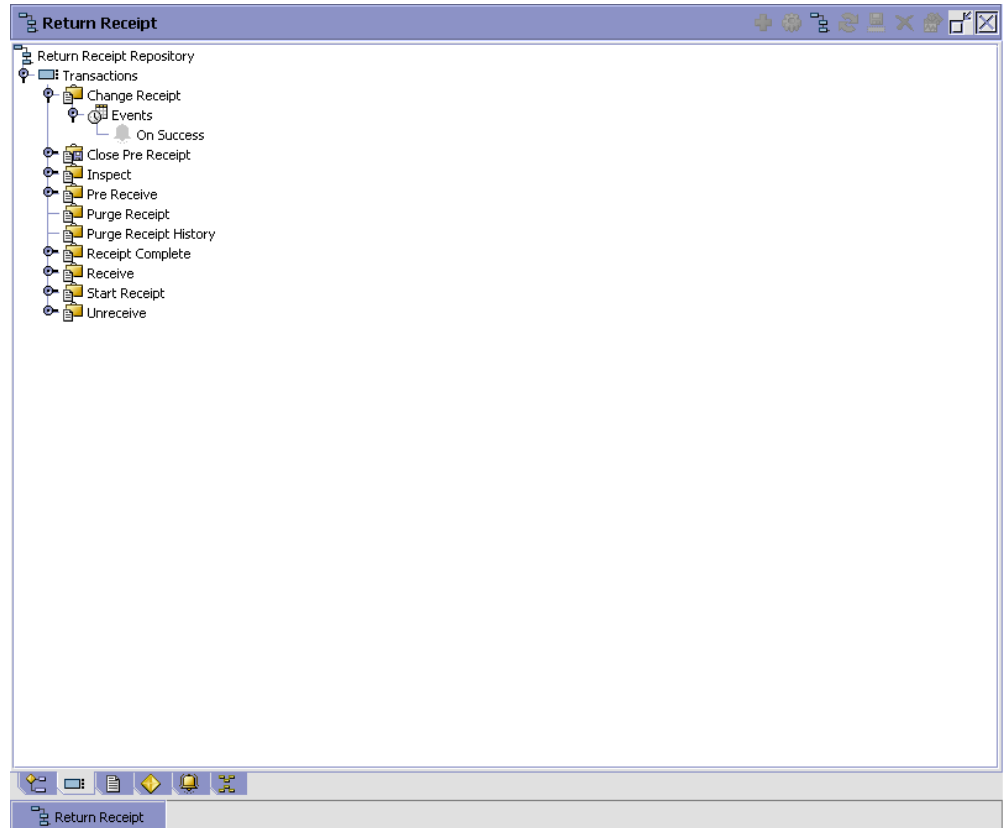

Table 5–34 Return Receipt Pipeline - Transactions Tab Window

Field	Description
Change Receipt	This transaction represents the receipt details being modified after a receipt for a shipment is recorded.
Close Pre Receipt	This transaction represents the closure of pre-receipts for a shipment. Pre-receipt allows a warehouse to indicate the receipt of containers for a shipment. The visibility provided to the other departments allows for exception handling. For example, during item shortage in the pick areas, supervisors monitor incoming shipments to request for emergency receipt of a particular shipment.
Inspect	This transaction represents the step of inspecting a shipment. This is required to complete the disposition of product received.
Pre Receive	This transaction represents a shipment may be pre-received before it is actually received in the warehouse.
Purge Receipt	This transaction represents a shipment that may be purged (moved out of) from primary transactional tables to the history tables. For more information about purge criteria, see Section 12.8, "Defining Purge Criteria" on page 940.
Purge Receipt History	This transaction represents a shipment may now be purged (moved out of) from the history tables. For more information about purge criteria, see Section 12.8, "Defining Purge Criteria" on page 940.
Receipt Complete	This transaction represents the completion of receipt of a shipment. It is invoked automatically from receipt screens or manually from a console or through the close receipt agent.
Receive	This transaction represents receipt of product on a shipment.
Start Receipt	This transaction represents the opening of a receipt for shipment. This is invoked either manually from a console or automatically invoked from consoles or RF.
Unreceive	This transaction represents the correction of received quantity against a shipment.

5.5.4.6 Statuses

Statuses are the actual states that a document moves through in the pipeline. A transaction can contain two types of statuses, a drop status and a pickup status. A document is moved into a **drop status** when the events and conditions of a transaction have been completed. A **pickup status** takes the document from the previous drop status and moves it through the next transaction. Created and Scheduled are examples of statuses.

For more information about Statuses, see the *Selling and Fulfillment Foundation: Application Platform Configuration Guide*.

To view the status details of a return receipt pipeline:

1. From the tree in the application rules side panel, choose Receiving > Document Specific > Return Order > Receipt Process Model. The Return Receipt window displays.
2. In the Return Receipt window, choose .
3. The Statuses tab window displays.

For more information about creating and modifying Statuses, see the *Selling and Fulfillment Foundation: Application Platform Configuration Guide*.

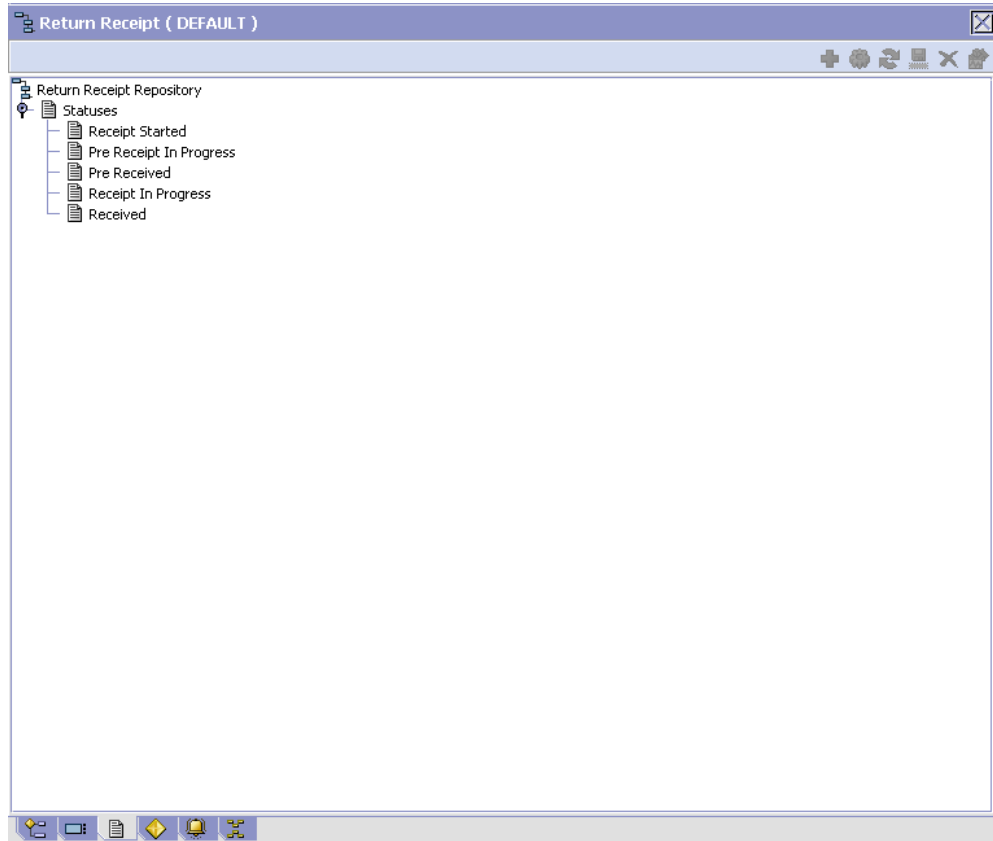

Table 5–35 *Return Receipt Pipeline - Statuses Tab Window*

Field	Description
Receipt Started	This indicates that the shipment is opened for receipt. This corresponds to 'Start Receipt' transaction.
Pre Receipt In Progress	This indicates that pre-receipt for the shipment is in progress. This corresponds to 'Pre-receive' transaction.

Table 5–35 Return Receipt Pipeline - Statuses Tab Window

Field	Description
Pre Received	This indicates that pre-receipt process for the shipment is completed. This corresponds to 'Close-PreReceipt' transaction.
Receipt In Progress	This indicates that receiving for the shipment is in progress. This corresponds to 'Receive' or 'Un-Receive' transactions.
Received	This indicates that receipt for the shipment is completed. This corresponds to 'Receipt Complete' transaction.

5.5.4.7 Conditions

A **condition** matches document type attributes against decision points and routes the documents to different paths based on the specified attribute and value combinations. The document type attributes against which conditions can be created are predefined in Selling and Fulfillment Foundation. You can use these attributes in any combination or you can create conditions that run the appropriate application logic for specific circumstances.

For more information about Conditions, see the *Selling and Fulfillment Foundation: Application Platform Configuration Guide*.

To view the condition details of a return receipt pipeline:

1. From the tree in the application rules side panel, choose Receiving > Document Specific > Return Order > Receipt Process Model. The Return Receipt window displays.
2. In the Return Receipt window, choose .
3. The Conditions tab window displays.

For more information about creating and modifying Conditions, see the *Selling and Fulfillment Foundation: Application Platform Configuration Guide*.

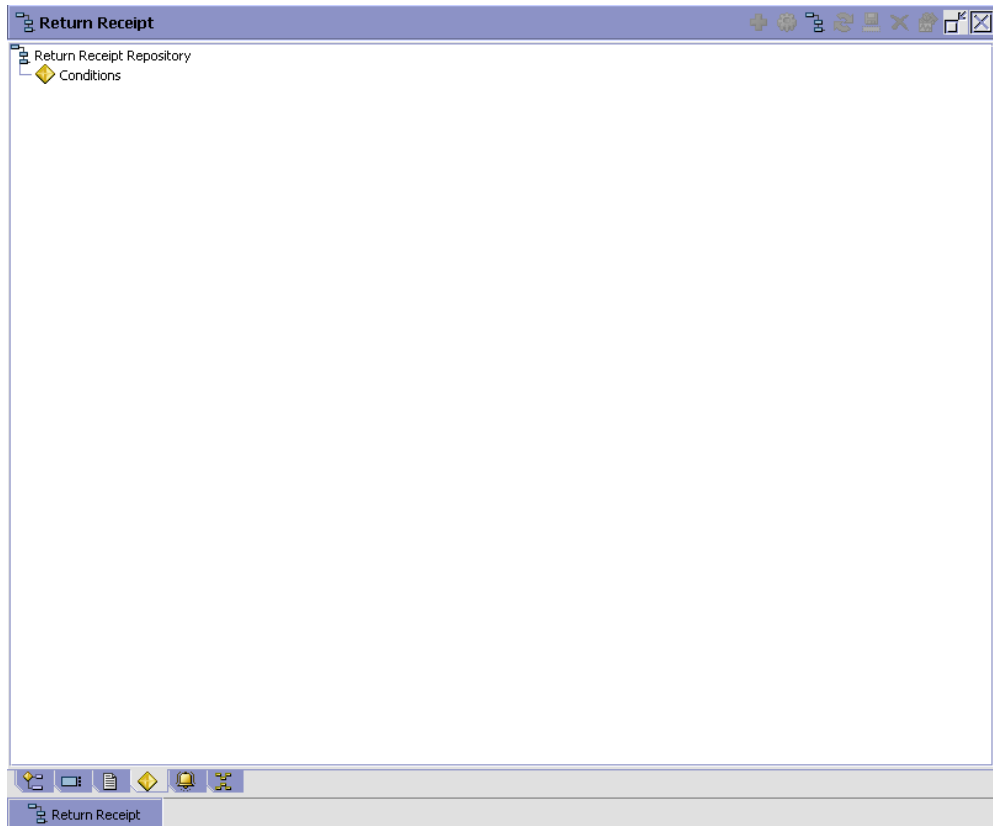

Table 5–36 *Return Receipt Pipeline - Conditions Tab Window*

Field	Description
Conditions	Displays conditions that are specific to the returns receipt pipeline, if any.

The Sterling WMS default pipeline does not have any conditions specified.

5.5.4.8 Actions

An **action** is a process or program that is triggered by an event. These processes and programs send user alert notifications and automatically resolve issues.

For example, when an order is released (the event), you can set an action to send the customer an e-mail.

For more information about Actions, see the *Selling and Fulfillment Foundation: Application Platform Configuration Guide*.

To view the action details of a return receipt pipeline:

1. From the tree in the application rules side panel, choose Receiving > Document Specific > Return Order > Receipt Process Model. The Return Receipt window displays.
2. In the Return Receipt window, choose .
3. The Actions tab window displays.

For more information about creating and modifying Actions, see the *Selling and Fulfillment Foundation: Application Platform Configuration Guide*.

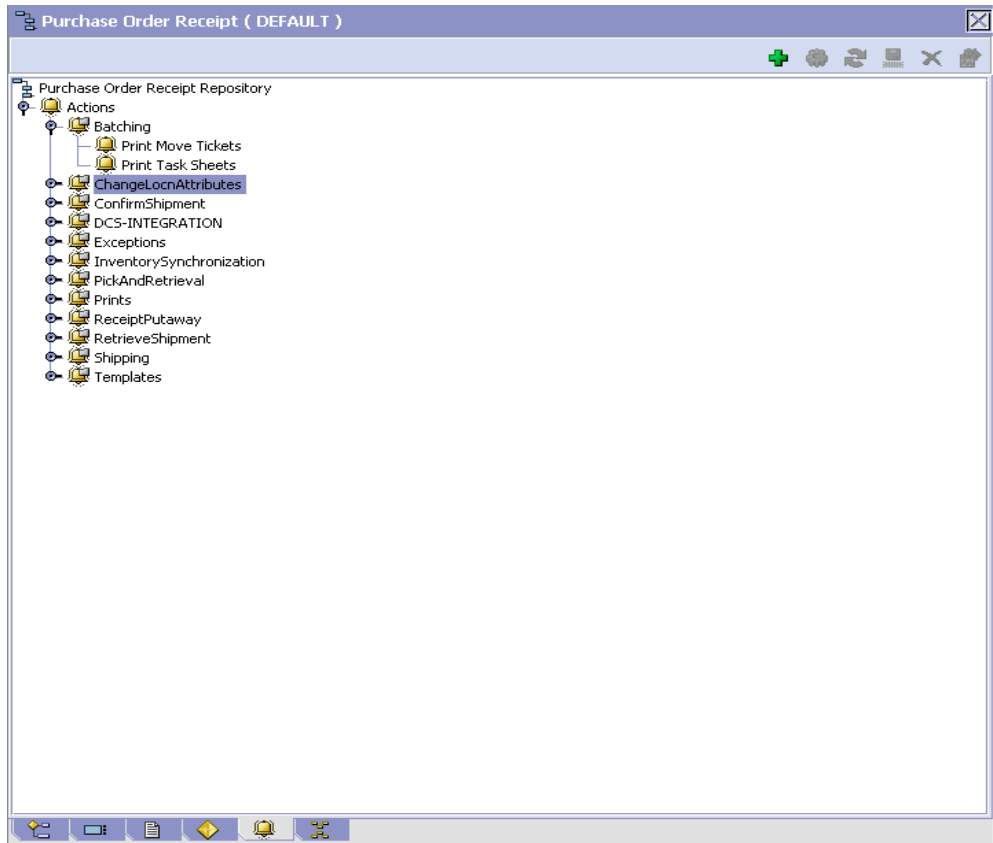

Table 5–37 Return Receipt Pipeline - Actions Tab Window

Field	Description
Batching	Default settings are provided for: Print Move Tickets – Invokes the batch printing service for printing the move tickets. Print Task Sheets – Invokes the batch print service for printing the task sheets.
ChangeLocnAttributes	

Table 5–37 Return Receipt Pipeline - Actions Tab Window

Field	Description
ConfirmShipment	Default settings are provided for: ConfirmShipment – Invokes the confirmShipment flow to confirm the shipment.
DCS-Integration	Default settings are provided for: InventoryDownload – Invokes the YantraWMSInventoryDownloadService service to download the inventory information from Selling and Fulfillment Foundation to DCS. PODownload – Invokes the YantraWMSPODownloadService service to download the Purchase Order information from Selling and Fulfillment Foundation to DCS.
Exceptions	Default settings are provided for: ShortagesDetected – Invokes the LogWavePlaFailure exception service when shortage of inventory occurs during wave release.
InventorySynchronization	Default settings are provided for: CollectInventoryMismatch – This service collects the inventory mismatch information between an external system and Selling and Fulfillment Foundation. This is typically caused when some inventory updates at a node or a warehouse are not reported to Selling and Fulfillment Foundation.
PickAndRetrieval	Default settings are provided for: ConfirmEmptyLocationAfterPick – Invokes the GenerateCountRequest flow which creates a count request.

Table 5–37 Return Receipt Pipeline - Actions Tab Window

Field	Description
Prints	<p>Default settings are provided for:</p> <p>PickList Print – Invokes the print service for printing the Pick List.</p> <p>LTL Manifest – Invokes the print service for printing the Less-than Truck Load Manifest.</p> <p>Print Load BOL – Invokes the print service for printing the Load Bill of Lading.</p> <p>Print PackList – Invokes the print service for printing the Pack List.</p> <p>Print Post Pick Container Labels – Invokes the print service for printing UCC-128 container labels for containers, when system defined packing process is used.</p> <p>Print Shipment BOL – Invokes the print service for printing the Shipment Bill of Lading.</p> <p>Print Shipping Label – Invokes the print service for printing the UCC-128 container labels.</p> <p>Print Wave – Invokes the Print service for printing a Wave.</p>
ReceiptPutaway	<p>Putaway products on receipt closure – Indicates the default action provided to automatically initiate putaway of purchase order receipts.</p>
RetrieveShipment	<p>Retrieve Requested Serial – This service invokes the retrieveShipment API to retrieve the requested serials to the specified location.</p>

Table 5–37 Return Receipt Pipeline - Actions Tab Window

Field	Description
Shipping	<p>Default settings are provided for:</p> <p>Load Left Origin – Invokes the doLoadLeftOriginUpdates service to mark that the load has left the origin.</p> <p>Stop Shipping – Invokes the RaiseStopShippingAlert service to raise an alert to stop the processing of the shipment.</p>
Templates	<p>Default settings are provided for:</p> <p>Log Exception – Logs the reasons due to which a count request could not be created for a Count Program.</p> <p>Publish Data – Sends data to external queue or internal tables.</p> <p>Raise Exception – Raises an alert using Event Management from the published information.</p> <p>Send Email – Raises an email action to create an email in the template format from the published information.</p> <p>Send Email-HTML format – Raises an email action to create an email in HTML format from the published information.</p>

5.5.4.9 Service Definitions

Service definitions are a representation of the logic that regulates document workflow services. The Service Builder is a graphical interface that enables you to create a graphical representation of these *services*.

For more information about Service Definitions, see the *Selling and Fulfillment Foundation: Application Platform Configuration Guide*.

To view the service definition details of a return receipt pipeline:

1. From the tree in the application rules side panel, choose Receiving > Document Specific > Return Order > Receipt Process Model. The Return Receipt window displays.
2. In the Return Receipt window, choose .
3. The Service Definitions tab window displays.

For more information about creating and modifying Service Definitions, see the *Selling and Fulfillment Foundation: Application Platform Configuration Guide*.

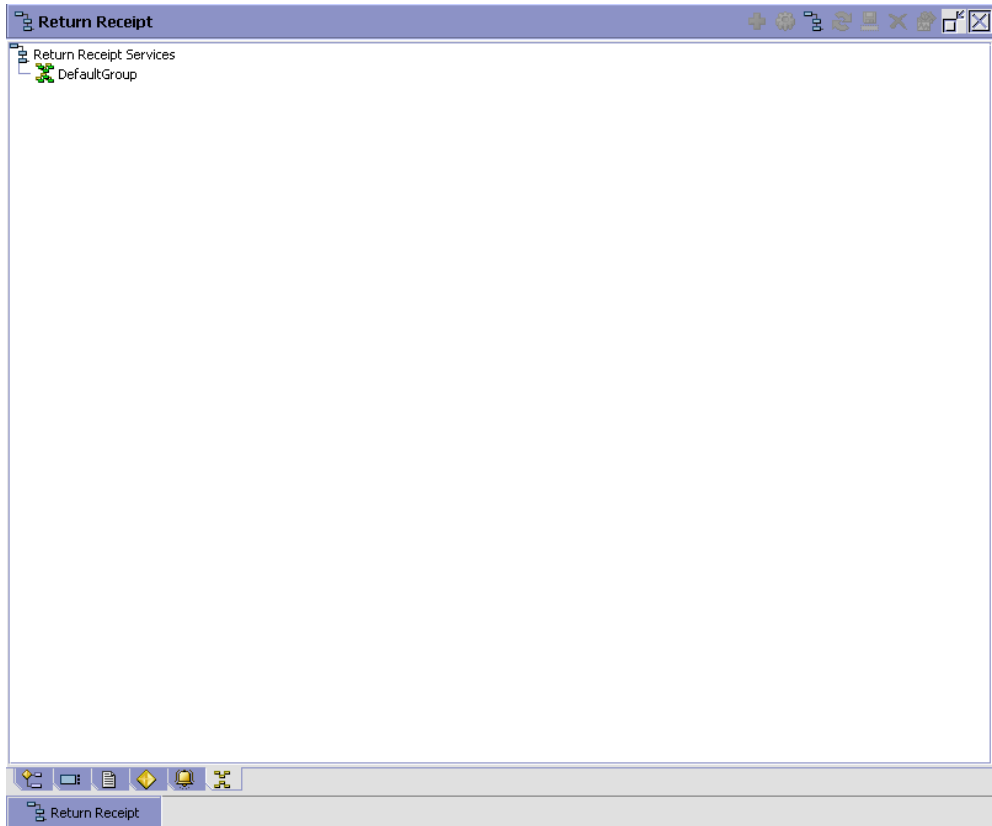

Table 5–38 *Return Receipt Pipeline - Service Definition Tab Window*

Field	Description
Default Group	Displays flows that are specific to the returns receipt pipeline.

The Sterling WMS default pipeline does not have any conditions specified.

5.5.5 Defining Receiving Preferences

The receiving preference configuration manages the receiving process of a warehouse.

A receiving preference identifies the characteristics of return shipments and provides guidelines to the execution transactions.

Use Receiving Preferences for:

- [Creating a Receiving Preference](#)
- [Modifying a Receiving Preference](#)

5.5.5.1 Creating a Receiving Preference

To create a receiving preference:

1. From the tree in the application rules side panel, choose Receiving > Document Specific > Return Order > Receiving Preferences.
2. The Receiving Preferences : Return Order window displays.
3. Enter information in the applicable fields. Refer [Table 5–39](#) for field value descriptions.
4. Choose .

Receiving Rules : Return Order : DEFAULT (DEFAULT / MA03)

Shipment entry allowed

Build Pallet

Always Optional

If Item Tag or Serial tracked

Build Case

Always Optional

If Item Tag or Serial tracked

Disposition Code

Receipt with QC

Receipt without QC

Preference for receipt closure by agent

Unconditionally Received quantity at least equal to expected quantity After Put away completion

Vendor Preferences

Vendor	Vendor Classification	Item ID	Item Classification	Force Case Content entry	Requires QC

Results 0

Receiving Rules : Return Order : DEFAULT (DEFAULT / MA03)

Table 5–39 Receiving Preferences : Return Order Window

Field	Description
Shipment Entry Allowed	<p>Select if shipment entry is to be created when a particular shipment is not available on the system.</p> <p>"Allow Shipment Entry" enables the system to automatically create a shipment entry in the system, if a shipment entry does not exist when a "Start Receipt" operation is performed.</p> <p>On creation and confirmation of the shipment, the "Include in Receipt" transaction is invoked, to enable the receiving process to be carried out on this receipt.</p> <p>Warehouses that receive shipment information in fax or email form can manually enter the information into the system. This allows for enhanced tracking and visibility.</p>
Build Pallet	
Always	Select if building of a pallet is mandatory during the receipt process.
Optional	Select if building of a pallet is optional.
If Item Tag or Serial Tracked	Select if building of pallet is required for items that are tag or serial tracked.
Build Case	
Always	Select if building of case is mandatory during the receipt process.
Optional	Select if building of case is optional.
If Item Tag or Serial tracked	Select if building of case is required for items that are tag or serial tracked.
Disposition Code	
Receipt with QC	Choose the disposition code to associate with receipts for vendors or shipments that require QC.
Receipt without QC	Choose the disposition code to associate with receipts for vendors or shipment that do not require QC.
Preference for Receipt Closure by Agent	

Table 5–39 Receiving Preferences : Return Order Window

Field	Description
Unconditionally	Select if receipt closure by the agent occurs every time the closure agent is run. This is typically used where receipts are closed as end-of-day process.
Received quantity at least equal to expected quantity	Select if receipt closure by the agent occurs when the received quantity is at least equal to the expected quantity.
After Putaway Completion	Select if receipt closure by the agent occurs after putaway is completed. This applies to warehouses that indicate availability only when inventory is putaway to their storage locations.
Vendor Preferences	Populated automatically from vendor preferences in Sterling Supply Collaboration. The preferences are evaluated to determine the best preference. The preference with most matches to the order details is determined as the best preference. For more information about Defining Customer Classifications, see the <i>Sterling Supply Collaboration: Configuration Guide</i> .
Vendor	This indicates the vendor. A vendor is defined as an external company that supplies materials that you order. You receive materials from your vendors. You are, in turn, vendors to your customers.
Vendor Classification	This indicates classification of the vendor.
Item ID	This indicates item ID.
Item Classification	This indicates the custom defined item storage definition.
Force Case Content entry	This indicates whether case content entry during receipt must be forced.
Requires QC	This indicates whether QC is required or not.

The closure of a shipment triggers the upload of receipt information to external HOST systems is updated in Sterling Supply Collaboration. For

example, inventory availability for the shipment is moved from an in-transit to on-hand.

Vendor-specific preferences, if any, configured as part of the Sterling Supply Collaboration displays here. For more information, see the *Sterling Supply Collaboration: Configuration Guide*.

Preferences for receiving a shipment are specified as a receiving preference for the ship node and enterprise level. A supervisor, may choose to override these preferences for a specific vendor. For example, a ship node requiring case content verification for most vendors. For a particular vendor a supervisor can override this requirement while manually creating shipment.

The feature of override is only relevant when the preference has been set forcing a granular activity. For example, override is not relevant for a ship node that does not require pallet content verification at a vendor level.

5.5.5.2 Modifying a Receiving Preference

Once a Receiving Preference has been created, it can be modified.

To modify a receiving preference:

1. From the tree in the application rules side panel, choose Receiving > Document Specific > Return Order > Receiving Preferences.
2. The Receiving Preferences : Return Order window displays with the list of existing rules.
3. Enter information in the applicable fields. Refer [Table 5–39](#) for field value descriptions.
4. Choose .

Any modification to a receiving preference is applied to all future transactions.

5.5.6 Defining Receiving Disposition

You can define common codes for receiving dispositions used when handling a receipt. This common code identifies what happens to items for the document type when they are received.

Use Receiving Disposition for:

- [Creating a Receiving Disposition](#)
- [Creating a New Receiving Disposition From an Existing Receiving Disposition](#)
- [Modifying a Receiving Disposition](#)
- [Deleting a Receiving Disposition](#)



5.5.6.1 Creating a Receiving Disposition

To create a receiving disposition:

1. From the tree in the application rules side panel, choose Receiving > Document Specific > Return Order > Receiving Disposition.
2. The Receiving Disposition : Return Order window displays.

Receiving Disposition : Return Order (DEFAULT)	
Receiving Disposition	Short Description
SENT FOR REPAIR	Sent For Repair
SCRAPPED	Scrapped
RESTOCKED	Restocked
TEST_DISP_OLD	Old Disposition
TEST_DISP_NEW	New Disposition

Results 5 Of 5

3. In the Receiving Disposition : Return Order window, choose . The Disposition Details pop-up window displays.
4. Enter information in the applicable fields. Refer [Table 5-40](#) for field value descriptions.
5. Choose .

Disposition Details

Receiving Disposition: SENT FOR REPAIR

Short Description: Sent For Repair

Product Class: [Dropdown]

Damaged Final Disposition

Disposition Transitions

Receiving Disposition
*

Results 0 Of 0

Table 5–40 *Disposition Details Pop-up Window*



Field	Description
Receiving Disposition	Enter the name of the receiving disposition.
Short Description	Enter a brief description of the receiving disposition.
Product Class	Select a product class to associate with received items, if applicable. For example, you could assign the product class of Returned to any returned items.
Damaged	Select Is Damaged if the receiving disposition is used for handling damaged items.

Table 5–40 Disposition Details Pop-up Window

Field	Description
Final Disposition	Select Final Disposition if the receiving disposition is to be used as final disposition for the receipt. Final Disposition marks the disposition code as final, and does not allow any further disposition transitions.
Disposition Transitions	This displays the existing Receiving Disposition codes that are available for associating a transition with the Receiving Disposition being created or modified.
Receiving Disposition	Existing Receiving Disposition Code available for transition association.

5.5.6.2 Creating a New Receiving Disposition From an Existing Receiving Disposition

To create a new receiving disposition from an existing receiving disposition:



1. From the tree in the application rules side panel, choose Receiving > Document Specific > Return Order > Receiving Disposition.
2. The Receiving Disposition : Return Order window displays with the list of Receiving Dispositions.
3. Choose the Receiving Disposition to be copied from. Choose . The Disposition Details pop-up window displays.
4. Enter information in the applicable fields. Refer [Table 5–40](#) for field value descriptions.
5. Choose .

5.5.6.3 Modifying a Receiving Disposition

Once a Receiving Disposition has been created, it may be modified.

To modify a receiving disposition:

1. From the tree in the application rules side panel, choose Receiving > Document Specific > Return Order > Receiving Disposition.
2. The Receiving Disposition : Return Order window displays with the list of Receiving Dispositions.

3. Select the Receiving Disposition to be modified. Choose . The Disposition Details pop-up window displays.
4. Enter information in the applicable fields. Refer [Table 5–40](#) for field value descriptions.
5. Choose .

5.5.6.4 Deleting a Receiving Disposition

To delete a receiving disposition:

1. From the tree in the application rules side panel, choose Receiving > Document Specific > Return Order > Receiving Disposition.
2. The Receiving Disposition : Return Order window displays with the list of Receiving Dispositions.
3. Select the Receiving Disposition to be deleted.
4. Choose .

5.5.7 Defining Disposition Codes

A disposition code identifies the product class and inventory status to be assigned to the inventory being received.

The valid list of disposition codes are typically managed as a central repository. The disposition code and description are automatically defaulted by the system for the appropriate type of order from the Reverse Logistics department, who typically own the disposition codes for the inventory. For more information, see the *Sterling Reverse Logistics: Configuration Guide*.

Use Disposition Codes for:

- [Creating a Receiving Disposition Code](#)
- [Modifying a Receiving Disposition Code](#)

5.5.7.1 Creating a Receiving Disposition Code

To create a receiving disposition code:

1. From the tree in the application rules side panel, choose Receiving > Document Specific > Return Order > Disposition Codes.
2. The Disposition Code : Return Order window displays.

3. Enter information in the applicable fields. Refer [Table 5–41](#) for field value descriptions.
4. Choose .

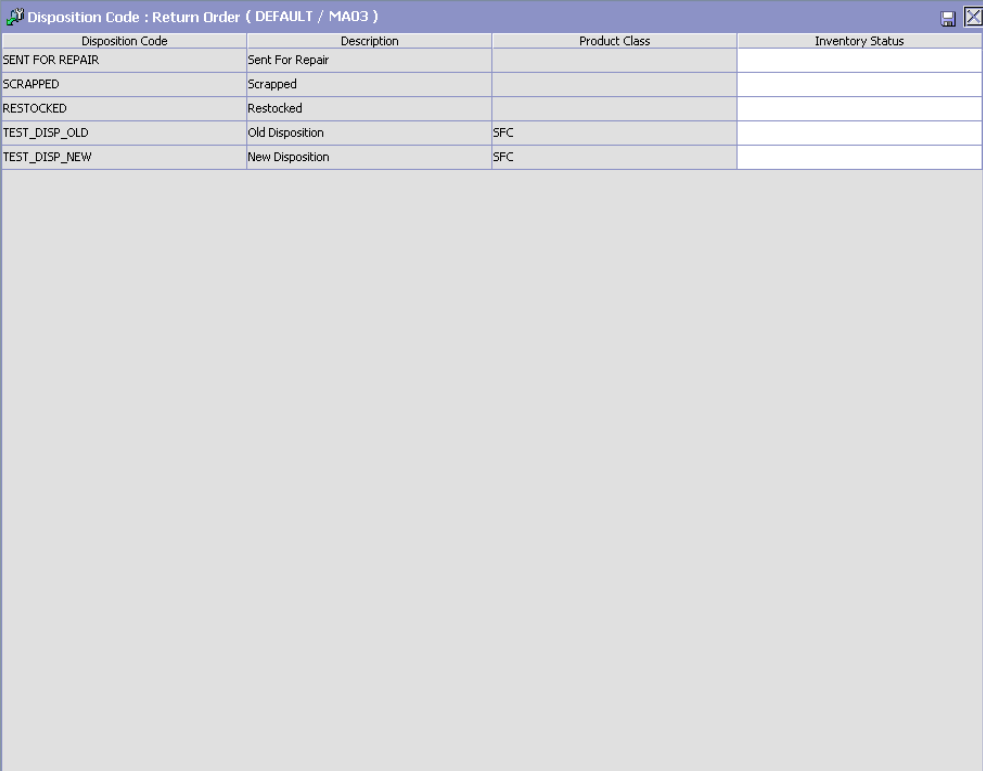

Disposition Code	Description	Product Class	Inventory Status
SENT FOR REPAIR	Sent For Repair		
SCRAPPED	Scrapped		
RESTOCKED	Restocked		
TEST_DISP_OLD	Old Disposition	SFC	
TEST_DISP_NEW	New Disposition	SFC	

Results 5 Of 0

Disposition Code : Return Order (DEFAULT / MA03)

Table 5–41 Receiving Disposition Window

Field	Description
Disposition Code	The disposition code displays.
Description	The description associated with the disposition code displays.

Table 5–41 Receiving Disposition Window

Field	Description
Product Class	Indicates the product class for the disposition.
Inventory Status	Choose the inventory status for the disposition. This is a mandatory field, and needs to be entered.

Inventory is received into the specified product class and inventory status for the disposition code entered.

If the Product class is not specified, the product class from the purchase order or the default product class from the item is used. It is mandatory to have product class is specified at one of these levels.

The disposition codes allow inspectors to utilize their terminology, instead of understanding inventory and storage implications.

5.5.7.2 Modifying a Receiving Disposition Code

Once a Receiving Disposition Code has been created, it can be modified.

To modify a receiving disposition code:

1. From the tree in the application rules side panel, choose Receiving > Document Specific > Return Order > Disposition Codes.
2. The Disposition Code : Return Order window displays with the list of existing dispositions.
3. Enter information in the applicable fields. Refer [Table 5–41](#) for field value descriptions.
4. Choose .

Only the inventory status associated with the disposition may be modified. The change of inventory status is applied to all future transactions.

5.6 Defining Vendors

You can define trading vendors in the Receiving section of the module.

Use Vendor for:

- [Defining Vendor Classifications](#)

- [Defining Vendor Definition](#)

5.6.1 Defining Vendor Classifications

You can configure the vendor classification codes used to associate with a vendor identification master. For more information about creating a vendor identification master, see [Section 5.6.2, "Defining Vendor Definition"](#) on page 426.

You can use the Vendor Classification branch for:

- [Creating a Vendor Classification](#)
- [Modifying a Vendor Classification](#)
- [Deleting a Vendor Classification](#)

5.6.1.1 Creating a Vendor Classification

To create a vendor classification:

1. From the tree in the application rules side panel, choose Receiving > Vendor > Vendor Classification. The Vendor Classification Codes window displays in the work area.

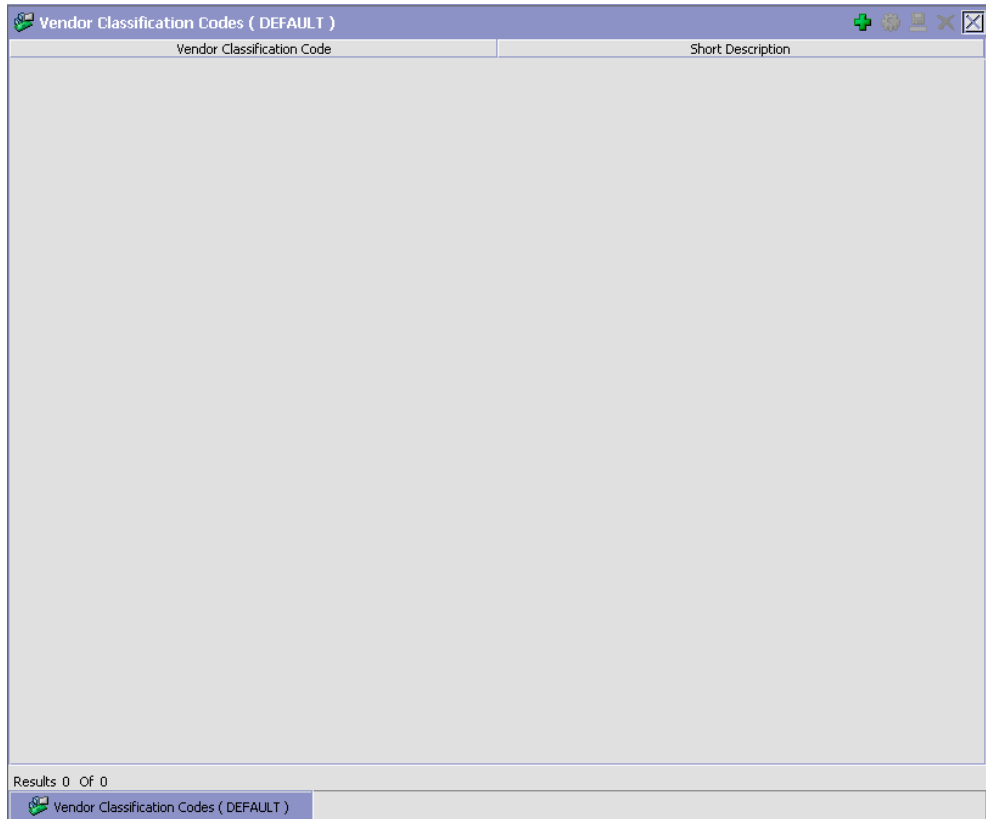



2. Choose . The Vendor Classification Code Details pop-up window displays.

The screenshot shows a dialog box titled "Vendor Classification Code Details". It contains three text input fields arranged vertically. The first field is labeled "Vendor Classification Code", the second is labeled "Short Description", and the third is labeled "Long Description". Each field is currently empty. There is a save icon in the top right corner of the dialog box.

3. In Vendor Classification Code, enter the classification ID code.
4. In Short Description, enter a brief description of the classification ID code.
5. In Long Description, enter a more detailed description of the classification ID code.
6. Choose .

5.6.1.2 Modifying a Vendor Classification

To modify a vendor classification:

1. From the tree in the application rules side panel, choose Receiving > Vendor > Vendor Classification. The Vendor Classification Codes window displays in the work area.
2. Select the applicable vendor classification code and choose . The Vendor Classification Code Details pop-up window displays.
3. In Short Description, enter a brief description of the classification ID code.
4. In Long Description, enter a more detailed description of the classification ID code.
5. Choose .

5.6.1.3 Deleting a Vendor Classification

To delete a vendor classification:

1. From the tree in the application rules side panel, choose Receiving > Vendor > Vendor Classification. The Vendor Classification Codes window displays in the work area.
2. Select the applicable vendor classification code and choose .

5.6.2 Defining Vendor Definition

You can configure vendor definitions used to establish a relationship between an organization and its Seller. When creating a vendor definition you associate an existing Seller organization with a specific vendor ID and classification. The vendor identification uniquely identifies the Seller organization in instances where multiple ERP systems download Seller information into Selling and Fulfillment Foundation.

Use Vendor Definition for:

- [Creating a Vendor Definition](#)
- [Modifying a Vendor Definition](#)
- [Deleting a Vendor Definition](#)

5.6.2.1 Creating a Vendor Definition

To create a vendor definition:

1. From the tree in the application rules side panel, choose Receiving > Vendor > Vendor Definition. The Vendor Search window displays in the work area.

Vendor Search (DEFAULT)

Vendor ID Seller Organization



Vendor Classification Max Records 1000

Search Results

Seller Organization	Vendor ID	Vendor Classification
---------------------	-----------	-----------------------

Results 0 Of 0

Vendor Search (DEFAULT)

2. Choose . The Vendor pop-up window displays.
3. Enter information into the applicable fields. Refer to [Table 5–42](#) for field value descriptions.
4. Choose .

The screenshot shows a 'Vendor' configuration window. At the top, there is a 'Vendor ID' text box and a 'Vendor Classification' dropdown menu with a green plus icon to its right. Below these are two radio buttons: 'Select An Existing Organization' (unselected) and 'Create A New Organization' (selected). Under 'Create A New Organization', there are several fields: 'Organization Code' and 'Organization Name' (text boxes), a checkbox for 'This Organization Is Also A Ship Node' (unselected), 'DUNS Number' and 'Account Number With Hub' (text boxes), and a 'Locale' dropdown menu set to 'US Eastern time' with a globe icon. At the bottom, there are three checkboxes: 'Sends Functional Acknowledgment' (unselected), 'Sends Commitment' (unselected), and 'Sends ASN' (unselected). Each checkbox has a corresponding 'Time' field (text box) to its right.

Table 5–42 Vendor Pop-Up Window



Field	Description
Vendor ID	Enter the identifier of the vendor.
Vendor Classification	Select the classification, if applicable.
Select An Existing Organization	Choose this option and select the applicable Seller if you want to associate the vendor with an existing Seller organization.
Create A New Organization	Choose this option if you want to create a new organization to associate with the vendor.
Organization Code	Enter the organization code.
Organization Name	Enter the name of the organization.
This Organization Is Also A Ship Node	Select this if the new organization is also a ship node.
DUNS Number	Enter the DUNS number of the seller.
Account Number With Hub	Enter the account number of the seller assigned by Hub organization.

Table 5–42 Vendor Pop-Up Window

Field	Description
Locale	Select the locale of the seller.
Sends Functional Acknowledgment	Check this box if the supplier sends a functional acknowledgment for a PO.
Functional Acknowledgment Time	Enter the number of days the supplier took to send the functional acknowledgment for a PO.
Sends Commitment	Check this box if the supplier sends a commitment for a PO.
Commitment Time	Enter the number of days the supplier took to send the commitment for a PO.
Send ASN	Check this box if the supplier sends an Advanced Shipment Notice (ASN) for a PO.

5.6.2.2 Modifying a Vendor Definition



To modify a vendor definition:

1. From the tree in the application rules side panel, choose Receiving > Vendor > Vendor Definition. The Vendor Search window displays in the work area.
2. Enter applicable search criteria and choose . A list of vendors displays.
3. Locate the applicable vendor and choose . The Vendor pop-up window displays.
4. From Vendor Classification, select the Seller's customer classification, if applicable.
5. From Seller Organization, select the Seller organization to associate with the vendor ID.
6. Choose .

5.6.2.3 Deleting a Vendor Definition

To delete a vendor definition:

1. From the tree in the application rules side panel, choose Receiving > Vendor > Vendor Definition. The Vendor Search window displays in the work area.

2. Enter applicable search criteria and choose . A list of vendors displays.
3. Locate the applicable vendor and choose .

5.7 Defining Location Storage Codes

A *Location Storage Code* indicates the storage classification for a location. Location storage code allows a warehouse to store all items of a given storage profile at the same location.

For example, inflammable items need to be stored separately in locations equipped to handle fire hazards. Marking all suitable locations with a certain storage code ensures that inflammable items are stored safely at these fireproof locations.

Note: For more information about setting up Location Storage Codes, see [Section 3.3, "Defining Location Storage Codes"](#) on page 40.

5.8 Defining Zone Constraints

A zone in a warehouse is created to represent a group of locations. Zones may also be dedicated to specific inventory attributes or item attributes.

The constraints are specified at a item attribute, classification and enterprise level. The constraints specified applies to each individual location.

For example, a zone is restricted to a particular enterprise.

Note: For more information about setting up constraints, see [Section 3.6, "Defining Zone Constraints"](#).

6

Configuring Quality Control

The Quality Control process defines the system for ensuring the maintenance of proper standards in manufactured goods, especially by periodic random inspection of the product. Quality control process is integral to a warehouse where the standards of the products stored needs to be ascertained as they are received and also before they are despatched.

Use Quality Control for:

- [Defining Activities](#)
- [Defining Activity Constraints](#)
- [Defining Retrieval Strategy](#)
- [Defining Putaway Preferences](#)

6.1 Defining Activities

Activities in the warehouse are grouped into Activity Groups. The Sterling WMS provides a pre-defined set of activity groups for a warehouse. Examples of activity groups include Receiving, VAS, QC, Picking, and Packing.

Each activity group is associated with activity codes that define each activity that is performed. For example, receiving activity group has pre-receiving, quality control and receiving activities.

The list here is specific to the Quality Control process.

Note: Activity Codes and Activity Constraints may be defined only when the WMS tree is loaded for Node / Hub combination.

Use Activities for:

- [Creating an Activity Code](#)
- [Modifying an Activity Code](#)
- [Deleting an Activity Code](#)
- [Setting Up Activity Constraints for Single SKU](#)
- [Setting Up Activity Constraints for Multi-SKU/Multi-Level Container](#)
- [Setting Up Activity Constraints for Container with Unknown Contents](#)

6.1.1 Creating an Activity Code

To create an activity code:

1. From the tree in the application rules side panel, choose Quality Control > Activities. The Activities window displays.
2. Enter information in the applicable fields. Refer [Table 6–1](#) for field value descriptions.
3. Choose .

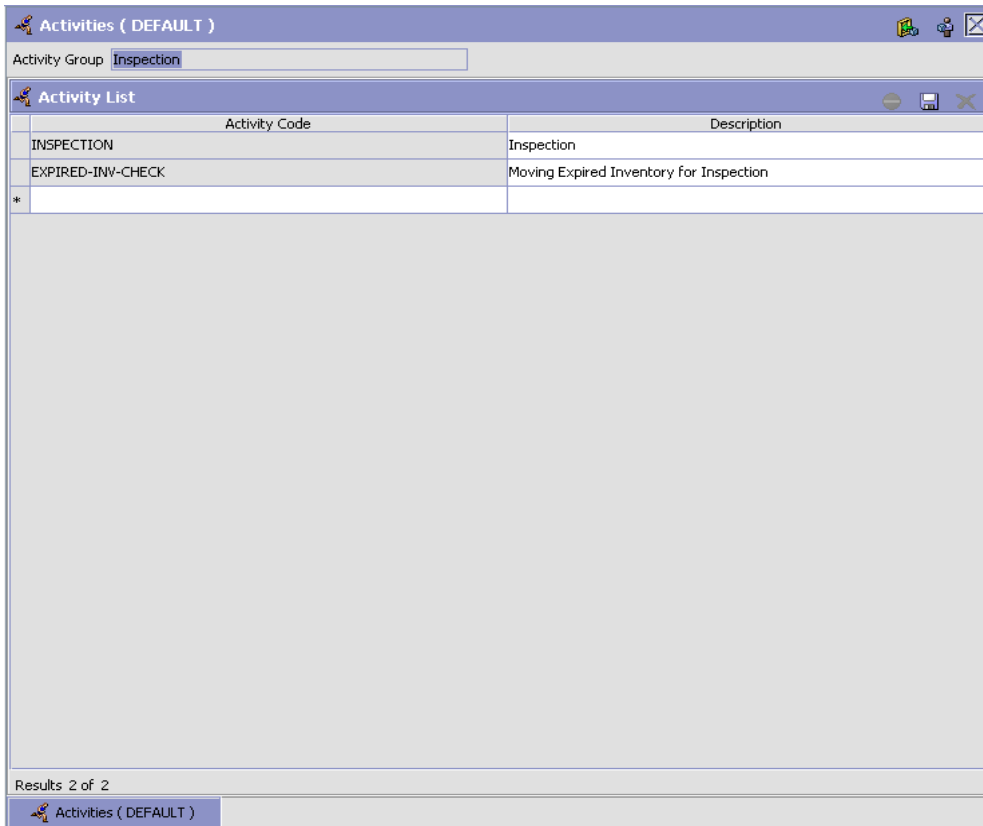



Table 6–1 Activities Window

Field	Description
Activity Group	This is automatically populated by the system as 'INSPECTION'.
Activity List	
Activity Code	Enter a name for the activity code. Activity code is the unique identity of the activity.
Description	Enter a brief description for the activity code.

6.1.2 Modifying an Activity Code

Once an activity code has been created, it can be modified.

To modify an activity code:

1. From the tree in the application rules side panel, choose Quality Control > Activities. The Activities window displays, with the list of activities.
2. Enter information in the applicable fields. Refer [Table 6–1](#) for field value descriptions.
3. Choose .

It is recommended that the Sterling WMS-provided list of activity codes is not modified.

6.1.3 Deleting an Activity Code

To delete an activity code:

1. From the tree in the application rules side panel, choose Quality Control > Activities. The Activities window displays, with the list of activities.
2. Choose the Activity Code to be deleted.
3. Choose .

It is recommended that the Sterling WMS-provided list of activity codes is not deleted.

6.2 Defining Activity Constraints

Activities in the warehouse are performed based on attributes of the inventory being received. The attributes considered are single SKU inventory, multi-SKU inventory and container.

Use Activity Constraint set-up for:

- [Setting Up Activity Constraints for Single SKU](#)
- [Setting Up Activity Constraints for Multi-SKU/Multi-Level Container](#)
- [Setting Up Activity Constraints for Container with Unknown Contents](#)

6.2.1 Setting Up Activity Constraints for Single SKU

The constraints for the activity of a single SKU are specified here.

Use Activity Constraint set-up for:

- [Creating an Activity Constraint for Single SKU](#)
- [Creating a New Activity Constraint for Single SKU from an Existing Activity Constraint](#)
- [Modifying an Activity Constraint for Single SKU](#)
- [Deleting an Activity Constraint for Single SKU](#)

6.2.1.1 Creating an Activity Constraint for Single SKU

To create an activity constraint for single SKU:

1. From the tree in the application rules side panel, choose Quality Control > Activities. The Activity Search window displays, with the list of activities.
2. Choose the Activity Code whose Activity Constraint is to be set up.
3. Choose . The Activity Constraints window displays.
4. In the Activity Constraints window, choose the Single-SKU tab. The Single-SKU tab window for Activity Constraints displays.

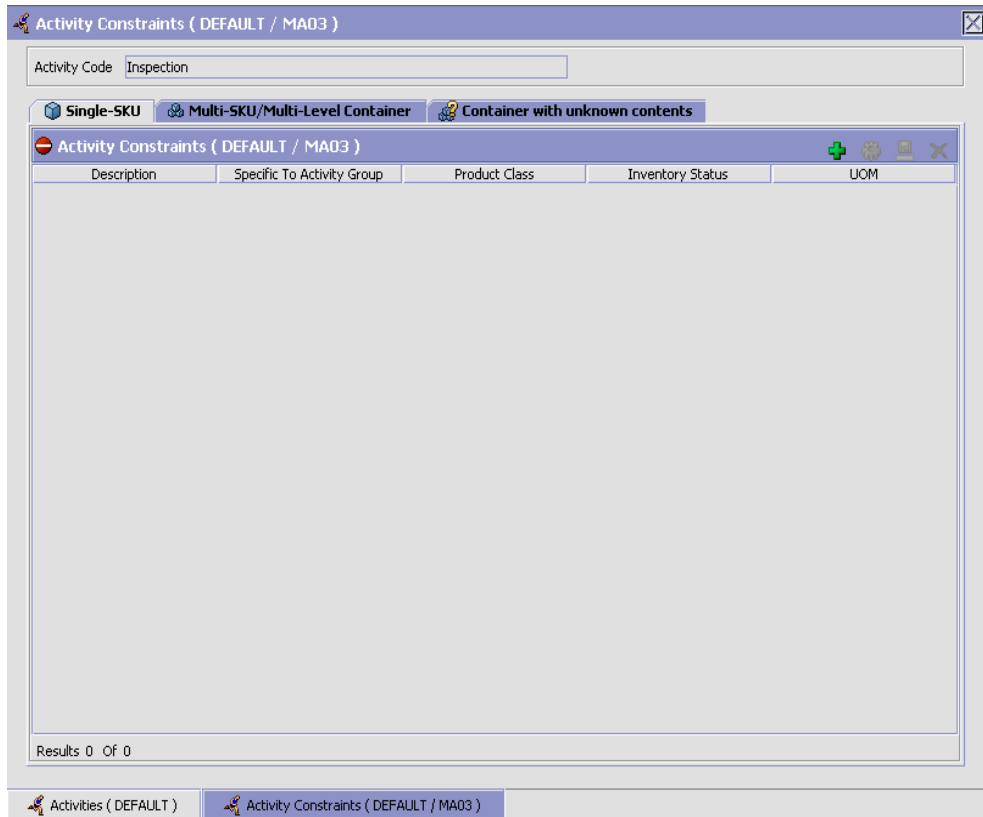



5. In the Single-SKU tab window, choose . The Activity Constraint Details window displays.
6. Enter information in the applicable fields. Refer [Table 6–2](#) for field value descriptions.
7. Choose .

Table 6–2 Activity Constraint Details - Single-SKU Tab Window

Field	Description
Description	Enter a description for the activity constraint.
To View Strategy Click here	Choose  to view or set up Putaway Strategy. For more details on setting up a putaway strategy see Setting Up Putaway Strategy for Single-SKUs . Note: Putaway strategy may be specified for the putaway preferences after the preference is saved.
Activity Code	This indicates the activity code for the constraint.

Table 6–2 Activity Constraint Details - Single-SKU Tab Window

Field	Description
Requesting Activity Group	Choose the requesting activity group. Typical values are Receipt, Packing, and Value Added Services.
Product Class	Choose the product class for the constraint, if applicable. Product class is the inventory classification of an item based on product's characteristics. Typical values are FQ - First Quality, SQ - Second Quality, etc.
Inventory Status	Choose the inventory status for the constraint, if applicable. Inventory status refers to an inventory sub classification based on the results of the inventory control processes within the warehouse.
Segment Type	Choose the segment type for the constraint, if applicable. This indicates an inventory category. Typical values are MTC – Made to Customer, and MTO - Made to Order.
Segment #	Enter the segment number for the constraint, if applicable. A segment holds either the specific buyer or specific order number that requires dedication.
UOM	Choose the UOM for the constraint, if applicable. UOM points to the Unit of measure of the item.
Container Type	The Container type associated with the UOM selected displays. Typical values are "Pallet" and "Case".
Item Classification	List of putaway item classifications for the Enterprise display. An example, Product Line is shown below.
Product Line	Choose relevant product line item classification for the putaway activity. Choose  . In the Classification window, select the applicable product line classification.
Location Priorities	

Table 6–2 Activity Constraint Details - Single-SKU Tab Window

Field	Description
Priority	<p>Enter a number to represent the priority.</p> <p>The priority is used to sequence the order in which the location priorities are evaluated. For example, all storage code level priorities are to be evaluated first before generic priorities.</p> <p>The priority needs to be a positive integer, greater than zero. This is a mandatory field.</p>
Location	<p>Choose the relevant location for the activity.</p> <p>This is a mandatory field.</p>

Setting Up Putaway Strategy for Single-SKUs

You can set up putaway strategies to putaway applicable inventory from a source zone to a target zone, based on the strategy specified.

To set up putaway strategy for single-SKUs:

1. In the Activity Constraint Details : Single SKU window, choose .
2. The Applicable Putaway Strategies window is displayed.

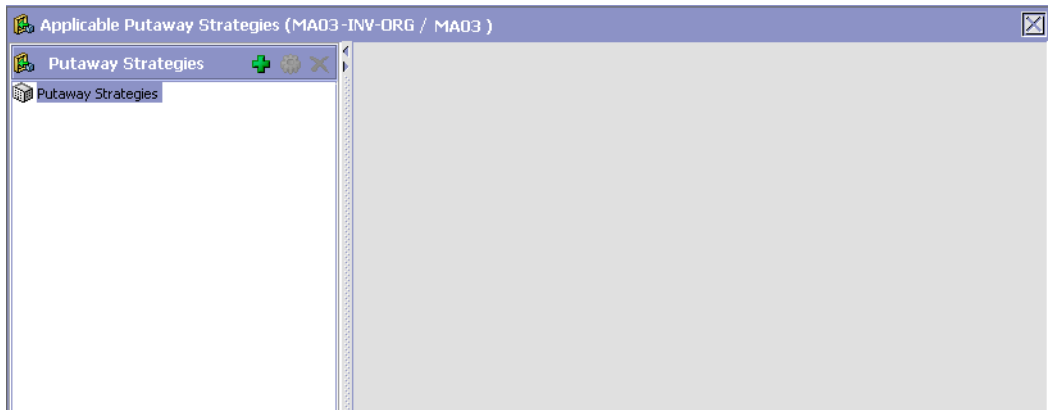

3. Choose  in the Putaway Strategies panel. The Putaway Strategy Details window appears in the right panel.
4. Enter information in the applicable fields. See the Putaway Strategy Details Window table for field value descriptions.

5. Choose .

Putaway Strategy Details

Description: Strategy for DVD-LockAndKey-EACH UOM: CASE

Item Classification:

Product Line: DVD

StorageType: LockAndKey

Product Line:

System Directed Putaway Task Types

	Source Zone	Target Zone	Container Type	Task Type
*				

Results: 0 Of 0

Ad Hoc Task Types

	Source Zone	Target Zone	Container Type	Task Type
*				

Results: 0 Of 0

Table 6–3 Putaway Strategy Details Window







Field	Description
Description	Enter a description for the Putaway Strategy.
UOM	Select the UOM for the Putaway Strategy, if applicable. Note: The UOM will be defaulted in instances where it has been specified in the Putaway Preference Details screen.
Item Classification	List of putaway item classifications for the Enterprise are displayed. An example, Product Line is shown below.
Product Line	Choose relevant product line item classification for the putaway activity. Choose  . In the Classification Values window, select the applicable product line classification.
System Directed Putaway Task Types	Displays the list of existing system directed putaway task types. You may use  to delete an existing system directed putaway task type.
Source Zone	Select the source zone from where the inventory is sourced.
Target Zone	Select the target zone to where the inventory is moved.
Container Type	Select the container type to be used to move the inventory from the source zone to the target zone. Typical values are Case and Pallet.
Task Type	Select the Putaway Task Type applicable to this putaway strategy. This field displays the list of existing system directed task types that belong to the 'PUTAWAY' activity group.
Ad hoc Task Types	Displays the list of existing ad hoc task types. You may use  to delete an existing ad hoc task type.
Source Zone	Select the source zone from where the inventory is sourced.

Table 6–3 Putaway Strategy Details Window

Field	Description
Target Zone	Select the target zone to where the inventory is moved.
Container Type	Select the container type to be used to move the inventory from the source zone to the target zone. Typical values are Case and Pallet.
Task Type	Select the Putaway Task Type applicable to this putaway strategy. This field displays the list of existing ad hoc task types that belong to the 'PUTAWAY' activity group.



6.2.1.2 Creating a New Activity Constraint for Single SKU from an Existing Activity Constraint

To create a new activity constraint for single SKU from an existing activity constraint:

1. From the tree in the application rules side panel, choose Quality Control > Activities. The Activity Search window displays, with the list of activities.
2. Choose the Activity Code whose Activity Constraint is to be set up.
3. Choose . The Activity Constraints window displays.
4. In the Activity Constraints window, choose the Single-SKU tab. The Single-SKU tab window for Activity Constraints displays.
5. In the Single-SKU tab window, choose the activity constraint that is to be copied from.
6. Choose . The Activity Constraint Details window displays.
7. Enter information in the applicable fields. Refer [Table 6–2](#) for field value descriptions.
8. Choose .



6.2.1.3 Modifying an Activity Constraint for Single SKU

To modify an activity constraint for single SKU:

1. From the tree in the application rules side panel, choose Quality Control > Activities. The Activity Search window displays, with the list of activities.
2. Choose the Activity Code whose Activity Constraint is to be modified.
3. Choose . The Activity Constraints window displays.
4. In the Activity Constraints window, choose the Single-SKU tab. The Single-SKU tab window for Activity Constraints displays.
5. In the Single-SKU tab window, choose the activity constraint that is to be modified.
6. Choose . The Activity Constraint Details window displays.
7. Enter information in the applicable fields. Refer [Table 6–2](#) for field value descriptions.
8. Choose .

6.2.1.4 Deleting an Activity Constraint for Single SKU

To delete an activity constraint for single SKU:

1. From the tree in the application rules side panel, choose Quality Control > Activities. The Activity Search window displays, with the list of activities.
2. Choose the Activity Code whose Activity Constraint is to be deleted.
3. Choose . The Activity Constraints window displays.
4. In the Activity Constraints window, choose the Single-SKU tab. The Single-SKU tab window for Activity Constraints displays.
5. In the Single-SKU tab window, choose the activity constraint that is to be deleted.
6. Choose .

6.2.2 Setting Up Activity Constraints for Multi-SKU/Multi-Level Container

The constraints for the activity of a multi-level case or pallet are specified here. This also applies to multi-level CASE with LPN and PALLET with LPN.

Use the Activity Constraints for Multi-SKU/Multi-Level Container set-up for:

- [Creating an Activity Constraint for Multi-SKU/Multi-Level Container](#)
- [Modifying an Activity Constraint for Multi-SKU/multi-level Container](#)
- [Deleting an Activity Constraint for Multi-SKU/Multi-Level Container](#)

6.2.2.1 Creating an Activity Constraint for Multi-SKU/Multi-Level Container

To create an activity constraint for multi-SKU/multi-level container:

1. From the tree in the application rules side panel, choose Quality Control > Activities. The Activity Search window displays, with the list of activities.
2. Choose the Activity Code whose Activity Constraint is to be set up.
3. Choose . The Activity Constraints window displays.

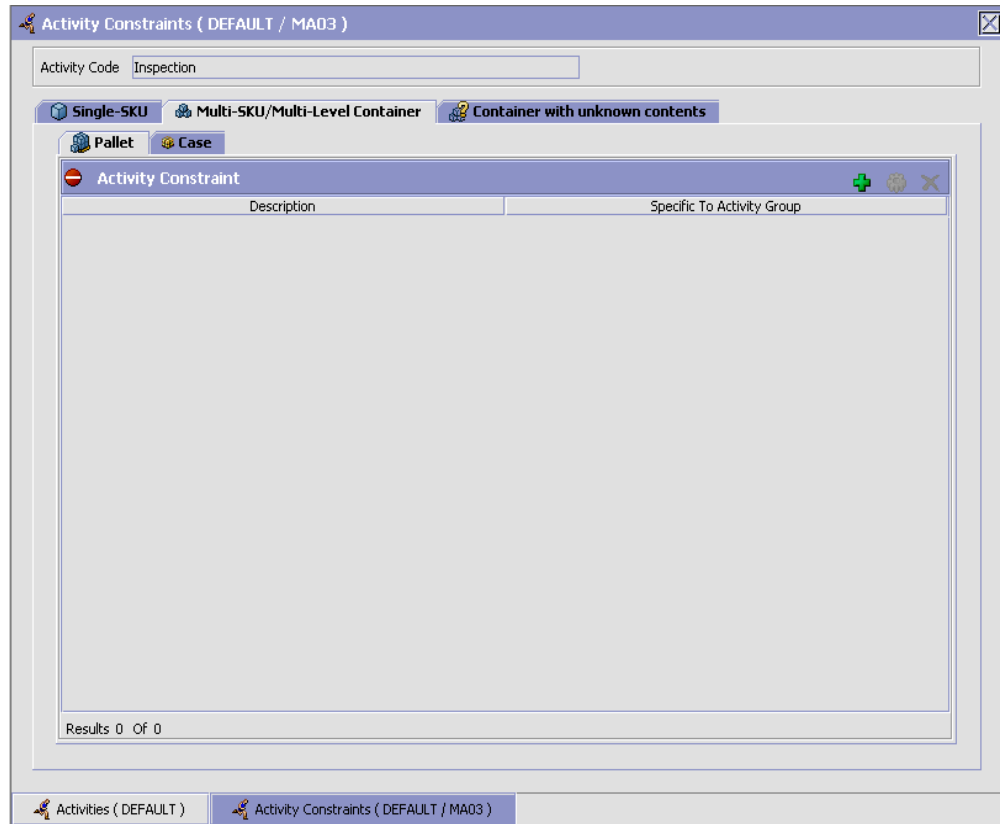



Activity Constraints for multi-level cases or pallets are specified separately:

- [Setting Up Activity Constraints for Multi-Level Pallets](#)
- [Setting Up Activity Constraints for Multi-Level Cases](#)

6.2.2.1.1 Setting Up Activity Constraints for Multi-Level Pallets

To set up activity constraints for multi-level pallets:

1. In the Multi-SKU/Multi-Level Container tab of Activity Constraints window, choose the Pallet tab. The Pallet tab window displays.
2. In the Pallet tab window, choose .

3. The Activity Constraint Details window displays.
4. Enter information in the applicable fields. Refer [Table 6–4](#) for field value descriptions.
5. Choose .

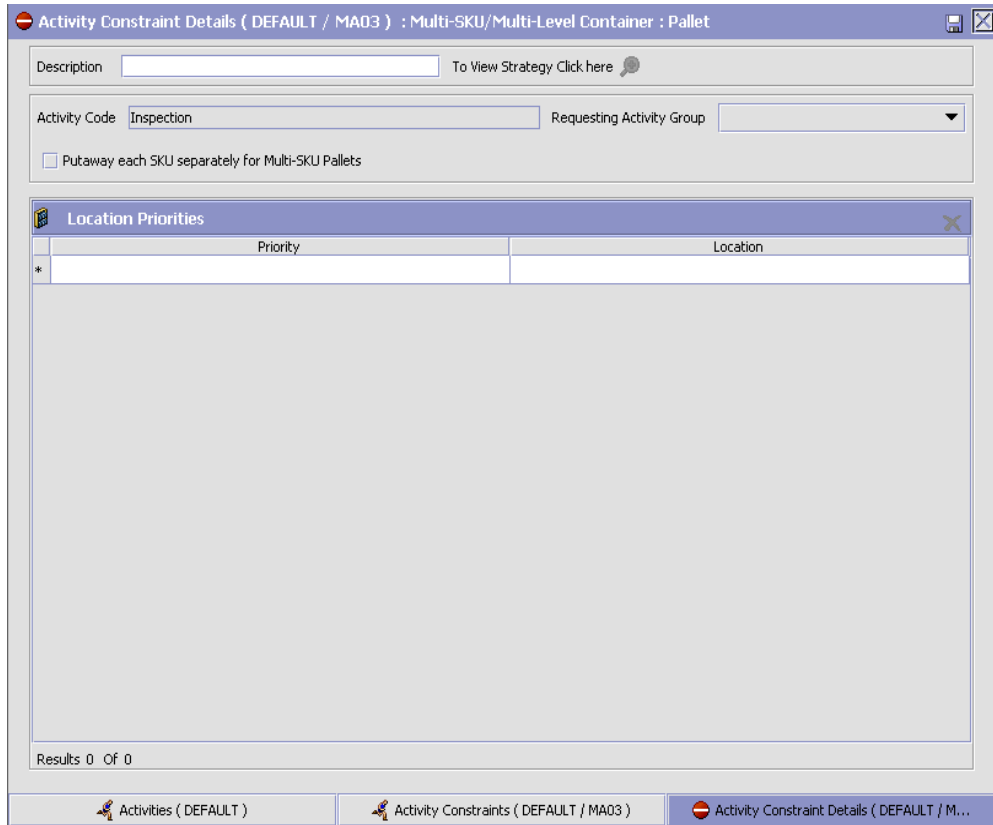

Activity Constraint Details (DEFAULT / MA03) : Multi-SKU/Multi-Level Container : Pallet

Description To View Strategy Click here 

Activity Code Requesting Activity Group

Putaway each SKU separately for Multi-SKU Pallets

Location Priorities	
Priority	Location
*	

Results 0 Of 0

Activities (DEFAULT) Activity Constraints (DEFAULT / MA03) Activity Constraint Details (DEFAULT / M...

Table 6–4 Activity Constraint Details - Multi-Level Pallet Tab

Field	Description
Description	Enter a description for the activity constraint.
To View Strategy Click here	<p>Choose  to view or set up Putaway Strategy. For more details on setting up a putaway strategy see Setting Up Putaway Strategy for Multi-SKU/Multi-Level Containers - Pallets.</p> <p>Note: Putaway strategy may be specified for the putaway preferences after the preference is saved.</p>
Activity Code	This indicates the activity code for the constraint.
Requesting Activity Group	<p>Choose the requesting activity group.</p> <p>Typical values are Receipt, Packing, and Value Added Services.</p>
Putaway each SKU separately for Multi-SKU Pallets	<p>Select if each SKU on the multi-SKU pallet is evaluated individually.</p> <p>If selected, the activity constraint for single SKU is evaluated for the multi-SKU pallet. The Zone Priorities Panel is removed on this selection.</p>
Location Priorities	
Priority	<p>Enter a number to represent the priority.</p> <p>The priority is used to sequence the order in which the location priorities are evaluated. For example, all storage code level priorities are to be evaluated first before generic priorities.</p> <p>The priority needs to be a positive integer, greater than zero. This is a mandatory field.</p>
Location	<p>Choose the relevant location for the activity.</p> <p>This is a mandatory field.</p>



Setting Up Putaway Strategy for Multi-SKU/Multi-Level Containers - Pallets

You can set up putaway strategies to putaway applicable inventory from a source zone to a target zone, based on the strategy specified.

To set up putaway strategy for multi-SKU/multi-level container pallets:

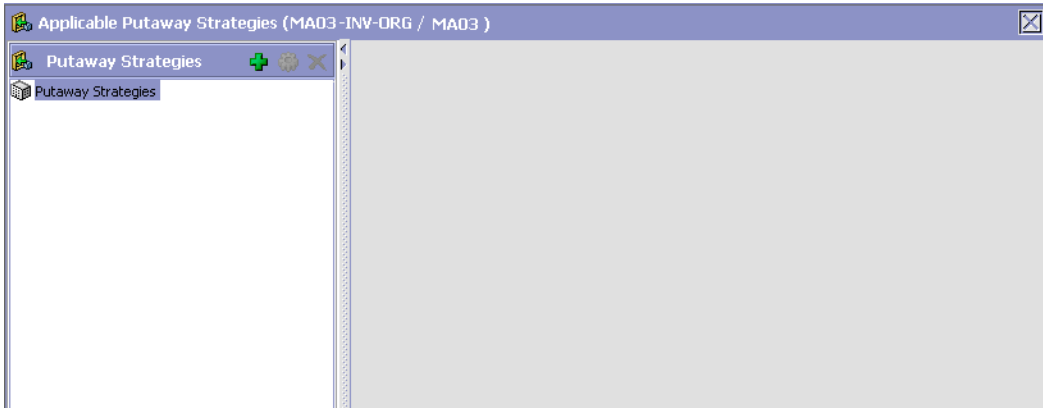
1. In the Activity Constraint Details : Multi-SKU/multi-level Containers : Pallet window, choose .
2. The Applicable Putaway Strategies window is displayed.



3. Choose  in the Putaway Strategies panel. The Putaway Strategy Details window appears in the right panel.
4. Enter information in the applicable fields. See the Putaway Strategy Details Window table for field value descriptions.
5. Choose .

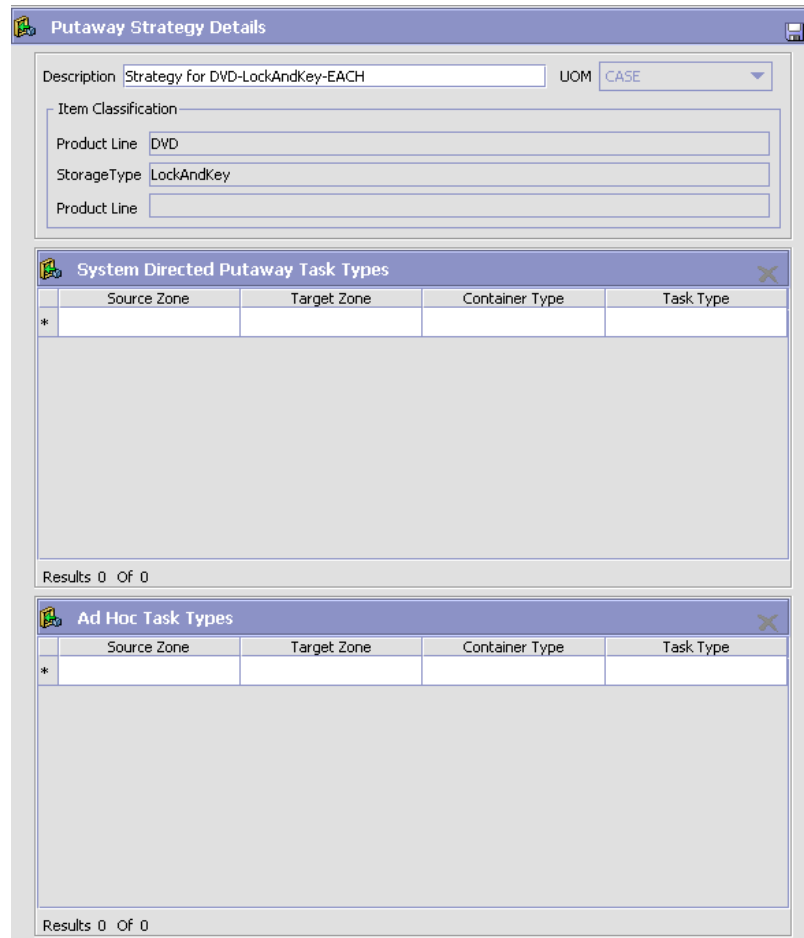

Table 6–5 Putaway Strategy Details Window

Field	Description
Description	Enter a description for the Putaway Strategy.
UOM	Select the UOM for the Putaway Strategy, if applicable. Note: The UOM will be defaulted in instances where it has been specified in the Putaway Preference Details screen.

Table 6–5 Putaway Strategy Details Window



Field	Description
Item Classification	List of putaway item classifications for the Enterprise are displayed. An example, Product Line is shown below.
Product Line	Choose relevant product line item classification for the putaway activity. Choose  . In the Classification Values window, select the applicable product line classification.
System Directed Putaway Task Types	Displays the list of existing system directed putaway task types. You may use  to delete an existing system directed putaway task type.
Source Zone	Select the source zone from where the inventory is sourced.
Target Zone	Select the target zone to where the inventory is moved.
Container Type	Select the container type to be used to move the inventory from the source zone to the target zone. Typical values are Case and Pallet.
Task Type	Select the Putaway Task Type applicable to this putaway strategy. This field displays the list of existing system directed task types that belong to the 'PUTAWAY' activity group.
Ad hoc Task Types	Displays the list of existing ad hoc task types. You may use  to delete an existing ad hoc task type.
Source Zone	Select the source zone from where the inventory is sourced.
Target Zone	Select the target zone to where the inventory is moved.

Table 6–5 Putaway Strategy Details Window



Field	Description
Container Type	Select the container type to be used to move the inventory from the source zone to the target zone. Typical values are Case and Pallet.
Task Type	Select the Putaway Task Type applicable to this putaway strategy. This field displays the list of existing ad hoc task types that belong to the 'PUTAWAY' activity group.

6.2.2.1.2 Setting Up Activity Constraints for Multi-Level Cases

To set up activity constraints for multi-level cases:

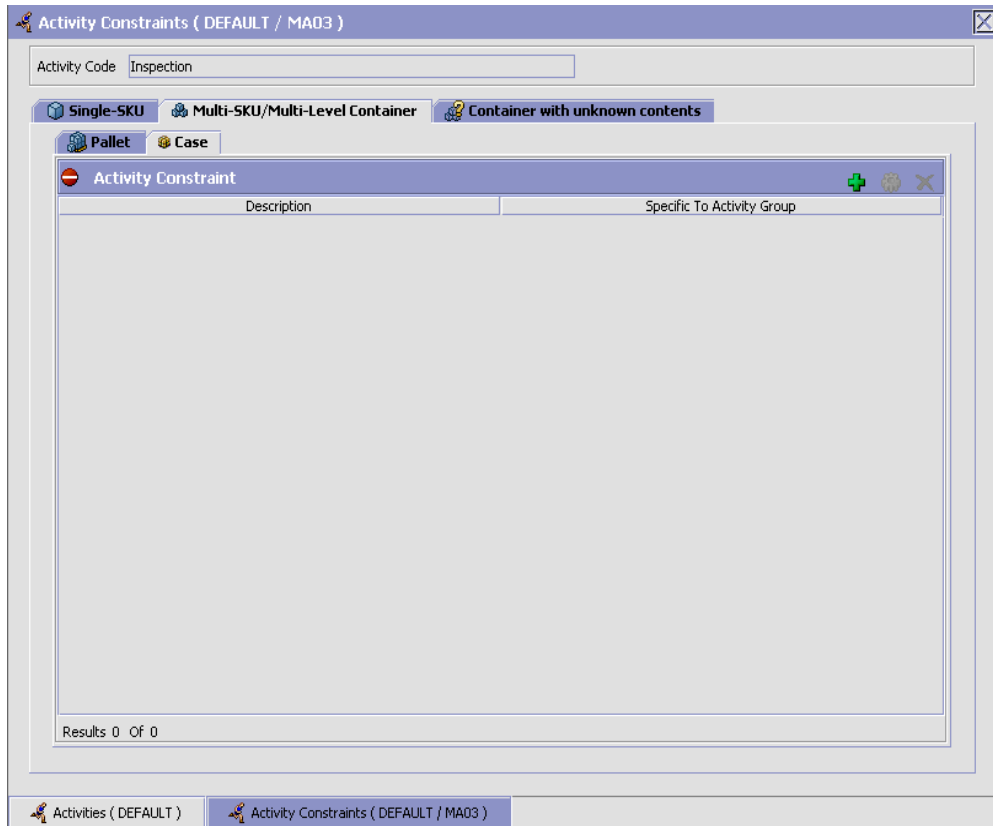
1. In the Multi-SKU/Multi-Level Container tab of Activity Constraints window, choose the Case tab. The Case tab window displays.



2. In the Case tab window, choose .
3. The Activity Constraint Details window displays.
4. Enter information in the applicable fields. Refer [Table 6–6](#) for field value descriptions.
5. Choose .

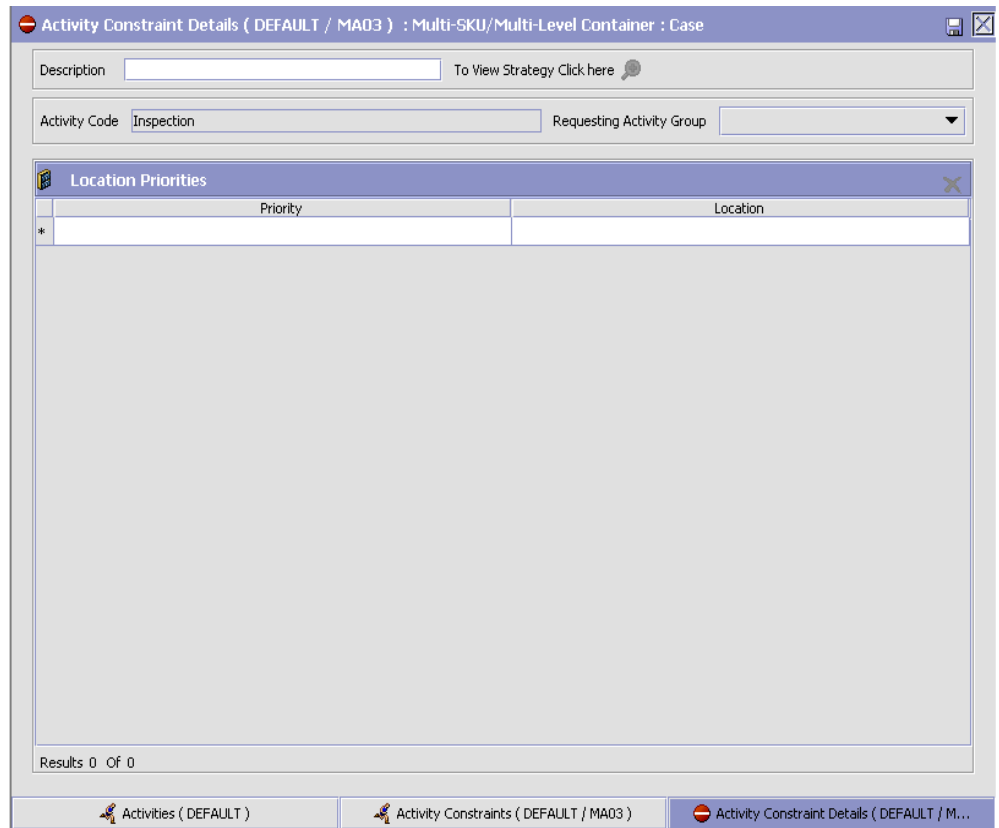

Table 6–6 Activity Constraint Details - Multi-Level Case Tab

Field	Description
Description	Enter a description for the activity constraint.
To View Strategy Click here	Choose  to view or set up Putaway Strategy. For more details on setting up a putaway strategy see Setting Up Putaway Strategy for Multi-SKU/Multi-Level Containers - Cases . Note: Putaway strategy may be specified for the putaway preferences after the preference is saved.
Activity Code	This indicates the activity code for the constraint.

Table 6–6 Activity Constraint Details - Multi-Level Case Tab

Field	Description
Requesting Activity Group	Choose the requesting activity group. Typical values are Receipt, Packing, and Value Added Services.
Location Priorities	
Priority	Enter a number to represent the priority. The priority is used to sequence the order in which the location priorities are evaluated. For example, all storage code level priorities are to be evaluated first before generic priorities. The priority needs to be a positive integer, greater than zero. This is a mandatory field.
Location	Choose the relevant location for the activity. This is a mandatory field.



Setting Up Putaway Strategy for Multi-SKU/Multi-Level Containers - Cases

You can set up putaway strategies to putaway applicable inventory from a source zone to a target zone, based on the strategy specified.

To set up putaway strategy for multi-SKU/multi-level container cases:

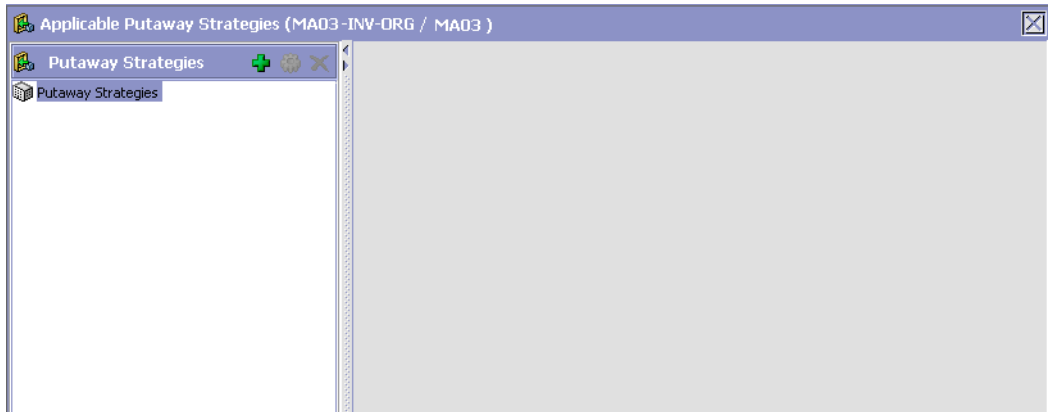
1. In the Activity Constraint Details : Multi-SKU/multi-level Containers : Case window, choose .
2. The Applicable Putaway Strategies window is displayed.



3. Choose  in the Putaway Strategies panel. The Putaway Strategy Details window appears in the right panel.
4. Enter information in the applicable fields. See the Putaway Strategy Details Window table for field value descriptions.
5. Choose .

Putaway Strategy Details

Description: Strategy for DVD-LockAndKey-EACH UOM: CASE

Item Classification

Product Line: DVD

StorageType: LockAndKey

Product Line:

System Directed Putaway Task Types

	Source Zone	Target Zone	Container Type	Task Type
*				

Results: 0 Of 0

Ad Hoc Task Types

	Source Zone	Target Zone	Container Type	Task Type
*				

Results: 0 Of 0

Table 6–7 Putaway Strategy Details Window

Field	Description
Description	Enter a description for the Putaway Strategy.
UOM	Select the UOM for the Putaway Strategy, if applicable. Note: The UOM will be defaulted in instances where it has been specified in the Putaway Preference Details screen.

Table 6–7 Putaway Strategy Details Window







Field	Description
Item Classification	List of putaway item classifications for the Enterprise are displayed. An example, Product Line is shown below.
Product Line	Choose relevant product line item classification for the putaway activity. Choose  . In the Classification Values window, select the applicable product line classification.
System Directed Putaway Task Types	Displays the list of existing system directed putaway task types. You may use  to delete an existing system directed putaway task type.
Source Zone	Select the source zone from where the inventory is sourced.
Target Zone	Select the target zone to where the inventory is moved.
Container Type	Select the container type to be used to move the inventory from the source zone to the target zone. Typical values are Case and Pallet.
Task Type	Select the Putaway Task Type applicable to this putaway strategy. This field displays the list of existing system directed task types that belong to the 'PUTAWAY' activity group.
Ad hoc Task Types	Displays the list of existing ad hoc task types. You may use  to delete an existing ad hoc task type.
Source Zone	Select the source zone from where the inventory is sourced.
Target Zone	Select the target zone to where the inventory is moved.

Table 6–7 Putaway Strategy Details Window

Field	Description
Container Type	Select the container type to be used to move the inventory from the source zone to the target zone. Typical values are Case and Pallet.
Task Type	Select the Putaway Task Type applicable to this putaway strategy. This field displays the list of existing ad hoc task types that belong to the 'PUTAWAY' activity group.



6.2.2.2 Modifying an Activity Constraint for Multi-SKU/multi-level Container

To modify an activity constraint for multi-SKU/multi-level container:

1. From the tree in the application rules side panel, choose Quality Control > Activities. The Activity Search window displays, with the list of activities.
2. Choose the Activity Code whose Activity Constraint is to be modified.
3. Choose . The Activity Constraints window displays.
4. In the Activity Constraints window, choose the Multi-SKU/Multi-Level Container tab. The Multi-SKU/Multi-Level Container tab window for Activity Constraints displays.
5. In the Multi-SKU/Multi-Level Container tab window, choose the activity constraint that is to be modified.
6. Choose . The Activity Constraint Details window displays.
7. Enter information in the applicable fields. For more information about modifying the fields, see [Section 6.2.2.1.1, "Setting Up Activity Constraints for Multi-Level Pallets"](#) on page 445 and [Section 6.2.2.1.2, "Setting Up Activity Constraints for Multi-Level Cases"](#) on page 451.
8. Choose .

6.2.2.3 Deleting an Activity Constraint for Multi-SKU/Multi-Level Container

To delete an activity constraint for Multi-SKU/Multi-Level Container:

1. From the tree in the application rules side panel, choose Quality Control > Activities. The Activity Search window displays, with the list of activities.
2. Choose the Activity Code whose Activity Constraint is to be modified.
3. Choose . The Activity Constraints window displays.
4. In the Activity Constraints window, choose the Multi-SKU/Multi-Level Container tab. The Multi-SKU/Multi-Level Container tab window for Activity Constraints displays.
5. In the Multi-SKU/Multi-Level Container tab window, choose the activity constraint that is to be deleted.
6. Choose .

6.2.3 Setting Up Activity Constraints for Container with Unknown Contents

The constraints for the activity of a multi-SKU case with LPN or pallet with LPN are specified here.

Use the Activity Constraints for Container set-up for:

- [Creating an Activity Constraint for Container with Unknown Contents](#)
- [Modifying an Activity Constraint for Container with Unknown Contents](#)
- [Deleting an Activity Constraint for Container with Unknown Contents](#)

6.2.3.1 Creating an Activity Constraint for Container with Unknown Contents

To create an activity constraint for container with unknown contents:

1. From the tree in the application rules side panel, choose Quality Control > Activities. The Activity Search window displays, with the list of activities.
2. Choose the Activity Code whose Activity Constraint is to be set up.
3. Choose . The Activity Constraints window displays.
4. In the Activity Constraints window, choose the Container with Unknown Contents tab. The Container with Unknown Contents tab window for Activity Constraints displays.

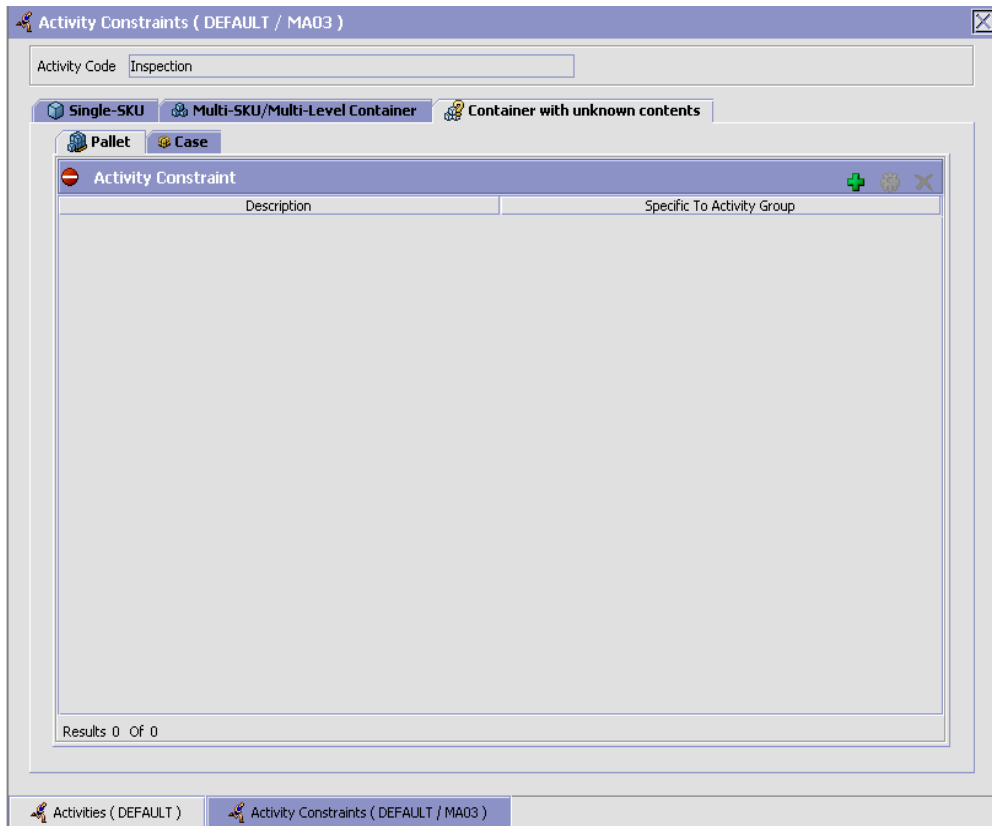



Activity Constraints for Container cases or pallets are specified separately:

- [Setting Up Activity Constraints for Container Pallets](#)
- [Setting Up Activity Constraints for Container Cases](#)

6.2.3.1.1 Setting Up Activity Constraints for Container Pallets

To set up activity constraints for containers pallets:

1. In the Container with Unknown Contents tab of Activity Constraints window, choose the Pallet tab. The Pallet tab window displays.
2. In the Pallet tab window, choose .

3. The Activity Constraint Details window displays.
4. Enter information in the applicable fields. Refer [Table 6–8](#) for field value descriptions.
5. Choose .

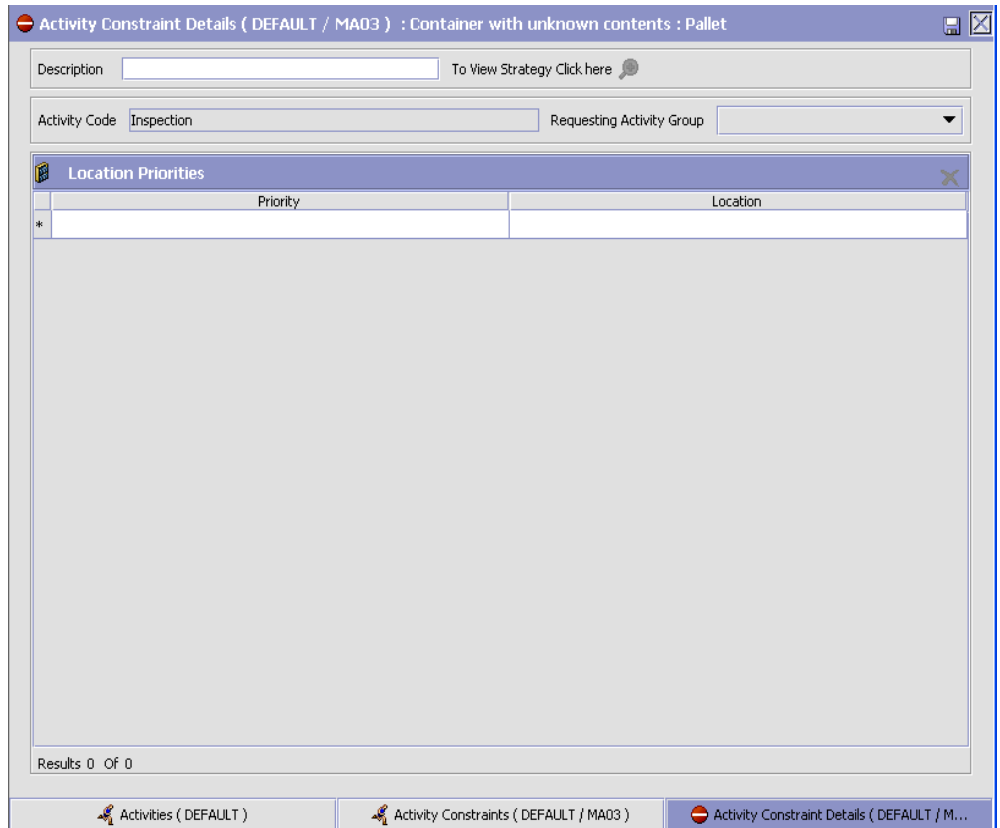



Table 6–8 Activity Constraint Details - Containers Pallet Tab

Field	Description
Description	Enter a description for the activity constraint.
To View Strategy Click here	Choose  to view or set up Putaway Strategy. For more details on setting up a putaway strategy see Setting Up Putaway Strategy for Container with Unknown contents - Pallets . Note: Putaway strategy may be specified for the putaway preferences after the preference is saved.
Activity Code	This indicates the activity code for the constraint.
Requesting Activity Group	Choose the requesting activity group. Typical values are Receipt, Packing, and Value Added Services.
Location Priorities	
Priority	Enter a number to represent the priority. The priority is used to sequence the order in which the location priorities are evaluated. For example, all storage code level priorities are to be evaluated first before generic priorities. The priority needs to be a positive integer, greater than zero. This is a mandatory field.
Location	Choose the relevant location for the activity. This is a mandatory field.

Setting Up Putaway Strategy for Container with Unknown contents - Pallets

You can set up putaway strategies to putaway applicable inventory from a source zone to a target zone, based on the strategy specified.

To set up putaway strategy for container with unknown content pallets:

1. In the Activity Constraint Details : Container with unknown contents : Pallet window, choose .
2. The Applicable Putaway Strategies window is displayed.

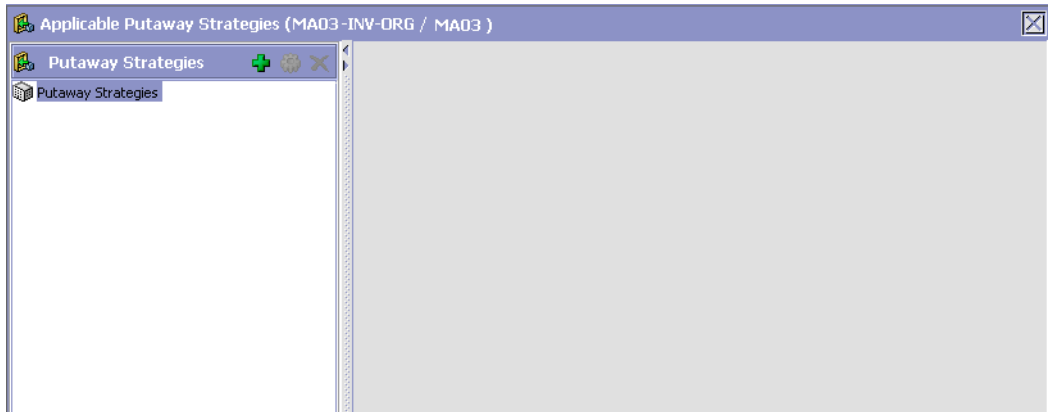



3. Choose  in the Putaway Strategies panel. The Putaway Strategy Details window appears in the right panel.
4. Enter information in the applicable fields. See the Putaway Strategy Details Window table for field value descriptions.
5. Choose .

Table 6–9 Putaway Strategy Details Window

Field	Description
Description	Enter a description for the Putaway Strategy.
UOM	Select the UOM for the Putaway Strategy, if applicable. Note: The UOM will be defaulted in instances where it has been specified in the Putaway Preference Details screen.

Table 6–9 Putaway Strategy Details Window



Field	Description
Item Classification	List of putaway item classifications for the Enterprise are displayed. An example, Product Line is shown below.
Product Line	Choose relevant product line item classification for the putaway activity. Choose  . In the Classification Values window, select the applicable product line classification.
System Directed Putaway Task Types	Displays the list of existing system directed putaway task types. You may use  to delete an existing system directed putaway task type.
Source Zone	Select the source zone from where the inventory is sourced.
Target Zone	Select the target zone to where the inventory is moved.
Container Type	Select the container type to be used to move the inventory from the source zone to the target zone. Typical values are Case and Pallet.
Task Type	Select the Putaway Task Type applicable to this putaway strategy. This field displays the list of existing system directed task types that belong to the 'PUTAWAY' activity group.
Ad hoc Task Types	Displays the list of existing ad hoc task types. You may use  to delete an existing ad hoc task type.
Source Zone	Select the source zone from where the inventory is sourced.
Target Zone	Select the target zone to where the inventory is moved.

Table 6–9 Putaway Strategy Details Window



Field	Description
Container Type	Select the container type to be used to move the inventory from the source zone to the target zone. Typical values are Case and Pallet.
Task Type	Select the Putaway Task Type applicable to this putaway strategy. This field displays the list of existing ad hoc task types that belong to the 'PUTAWAY' activity group.

6.2.3.1.2 Setting Up Activity Constraints for Container Cases

To set up activity constraints for container cases:

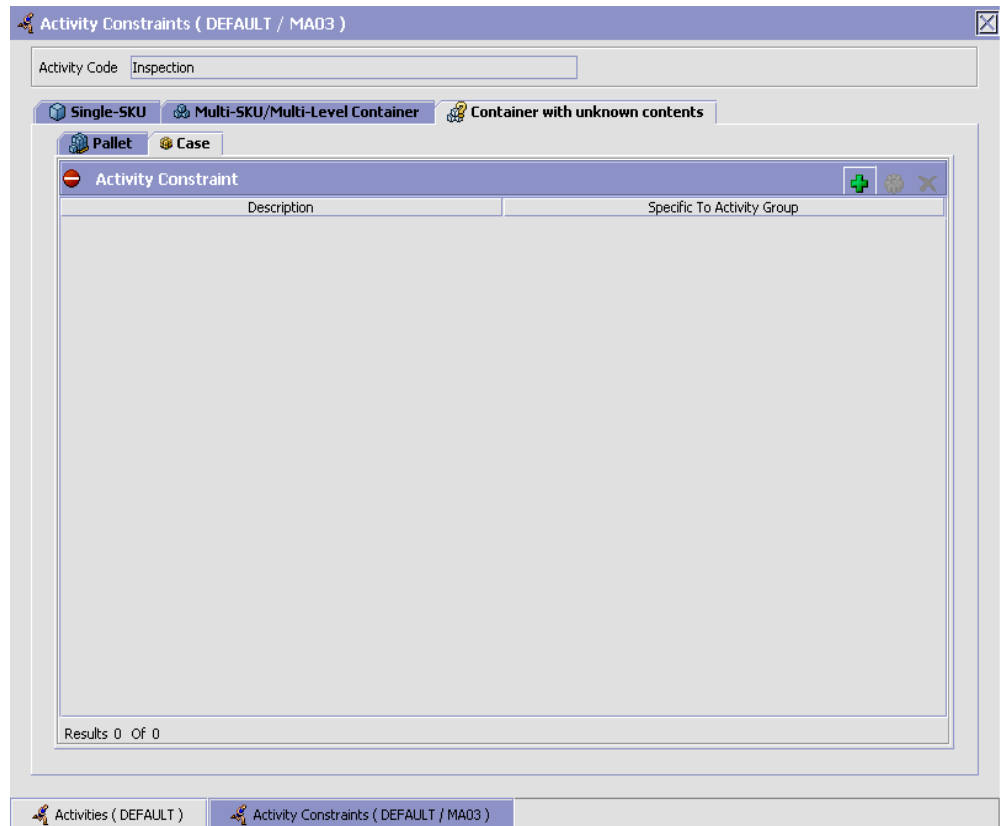
1. In the Container with Unknown Contents tab of Activity Constraints window, choose the Case tab. The Case tab window displays.



2. In the Case tab window, choose .
3. The Activity Constraint Details window displays.
4. Enter information in the applicable fields. Refer [Table 6–10](#) for field value descriptions.
5. Choose .

Activity Constraint Details (DEFAULT / MA03) : Container with unknown contents : Case

Description To View Strategy Click here

Activity Code Requesting Activity Group

Location Priorities	
Priority	Location
*	

Results 0 Of 0

Activities (DEFAULT) Activity Constraints (DEFAULT / MA03) Activity Constraint Details (DEFAULT / M...

Table 6–10 Activity Constraint Details - Containers Case Tab

Field	Description
Description	Enter a description for the activity constraint.
To View Strategy Click here	Choose to view or set up Putaway Strategy. For more details on setting up a putaway strategy see Setting Up Putaway Strategy for Container with unknown contents - Cases . Note: Putaway strategy may be specified for the putaway preferences after the preference is saved.
Activity Code	This indicates the activity code for the constraint.

Table 6–10 Activity Constraint Details - Containers Case Tab

Field	Description
Requesting Activity Group	Choose the requesting activity group. Typical values are Receipt, Packing, and Value Added Services.
Location Priorities	
Priority	Enter a number to represent the priority. The priority is used to sequence the order in which the location priorities are evaluated. For example, all storage code level priorities are to be evaluated first before generic priorities. The priority needs to be a positive integer, greater than zero. This is a mandatory field.
Location	Choose the relevant location for the activity. This is a mandatory field.



Setting Up Putaway Strategy for Container with unknown contents - Cases

You can set up putaway strategies to putaway applicable inventory from a source zone to a target zone, based on the strategy specified.

To set up putaway strategy for Container with unknown contents cases:

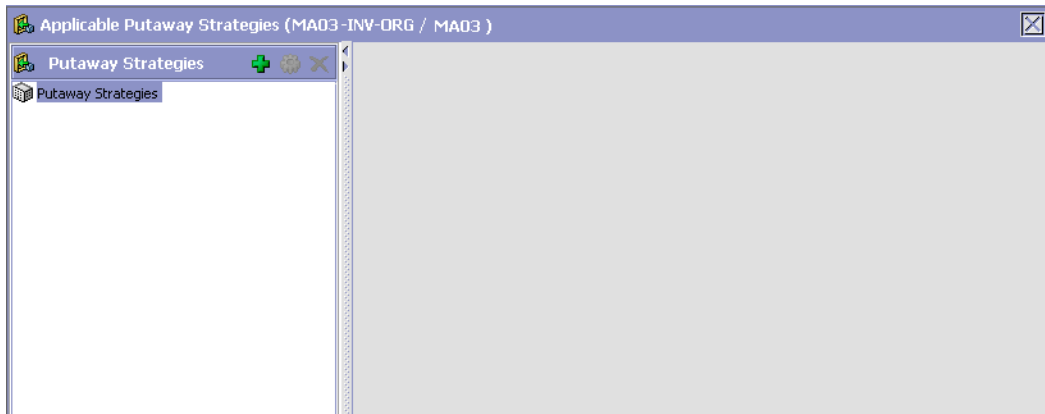
1. In the Activity Constraint Details : Container with unknown content : Case window, choose .
2. The Applicable Putaway Strategies window is displayed.



3. Choose  in the Putaway Strategies panel. The Putaway Strategy Details window appears in the right panel.
4. Enter information in the applicable fields. See the Putaway Strategy Details Window table for field value descriptions.
5. Choose .

The screenshot shows a software window titled "Putaway Strategy Details". It contains the following elements:

- Description:** A text field containing "Strategy for DVD-LockAndKey-EACH".
- UOM:** A dropdown menu set to "CASE".
- Item Classification:** A group box containing:
 - Product Line:** A text field containing "DVD".
 - StorageType:** A text field containing "LockAndKey".
 - Product Line:** An empty text field.
- System Directed Putaway Task Types:** A table with columns: Source Zone, Target Zone, Container Type, Task Type. It shows one row with an asterisk (*) in the first column and is otherwise empty.
- Ad Hoc Task Types:** A table with columns: Source Zone, Target Zone, Container Type, Task Type. It shows one row with an asterisk (*) in the first column and is otherwise empty.

Table 6–11 Putaway Strategy Details Window

Field	Description
Description	Enter a description for the Putaway Strategy.
UOM	Select the UOM for the Putaway Strategy, if applicable. Note: The UOM will be defaulted in instances where it has been specified in the Putaway Preference Details screen.

Table 6–11 Putaway Strategy Details Window







Field	Description
Item Classification	List of putaway item classifications for the Enterprise are displayed. An example, Product Line is shown below.
Product Line	Choose relevant product line item classification for the putaway activity. Choose  . In the Classification Values window, select the applicable product line classification.
System Directed Putaway Task Types	Displays the list of existing system directed putaway task types. You may use  to delete an existing system directed putaway task type.
Source Zone	Select the source zone from where the inventory is sourced.
Target Zone	Select the target zone to where the inventory is moved.
Container Type	Select the container type to be used to move the inventory from the source zone to the target zone. Typical values are Case and Pallet.
Task Type	Select the Putaway Task Type applicable to this putaway strategy. This field displays the list of existing system directed task types that belong to the 'PUTAWAY' activity group.
Ad hoc Task Types	Displays the list of existing ad hoc task types. You may use  to delete an existing ad hoc task type.
Source Zone	Select the source zone from where the inventory is sourced.
Target Zone	Select the target zone to where the inventory is moved.

Table 6–11 Putaway Strategy Details Window

Field	Description
Container Type	Select the container type to be used to move the inventory from the source zone to the target zone. Typical values are Case and Pallet.
Task Type	Select the Putaway Task Type applicable to this putaway strategy. This field displays the list of existing ad hoc task types that belong to the 'PUTAWAY' activity group.



6.2.3.2 Modifying an Activity Constraint for Container with Unknown Contents

To modify an activity constraint for container:

1. From the tree in the application rules side panel, choose Quality Control > Activities. The Activity Search window displays, with the list of activities.
2. Choose the Activity Code whose Activity Constraint is to be modified.
3. Choose . The Activity Constraints window displays.
4. In the Activity Constraints window, choose the Container with Unknown Contents tab. The Container with Unknown Contents tab window for Activity Constraints displays.
5. In the Container with Unknown Contents tab window, choose the activity constraint that is to be modified.
6. Choose . The Activity Constraint Details window displays.
7. Enter information in the applicable fields. For more information about modifying the fields, see [Section 6.2.3.1.1, "Setting Up Activity Constraints for Container Pallets"](#) on page 460 and [Section 6.2.3.1.2, "Setting Up Activity Constraints for Container Cases"](#) on page 466.
8. Choose .

6.2.3.3 Deleting an Activity Constraint for Container with Unknown Contents

To delete an activity constraint for container:

1. From the tree in the application rules side panel, choose Quality Control > Activities. The Activity Search window displays, with the list of activities.
2. Choose the Activity Code whose Activity Constraint is to be deleted.
3. Choose . The Activity Constraints window displays.
4. In the Activity Constraints window, choose the Container with Unknown Contents tab. The Container with Unknown Contents tab window for Activity Constraints displays.
5. In the Container with Unknown Contents tab window, choose the activity constraint that is to be deleted.
6. Choose .

6.3 Defining Retrieval Strategy

Retrieval Strategy defines the retrieval process to be followed when retrieving items for inspection. This is defined at the 'INSPECTION' activity group level.

For example, retrieving pre-received containers that have been putaway or retrieving inventory for inspection after they have been putaway.

Note: It is recommended that Zones containing Locations of type VIRTUAL should not be selected, while configuring the Putaway Preferences and Retrieval Strategy.

Use Retrieval Strategy for:



- [Creating a Retrieval Strategy](#)
- [Modifying a Retrieval Strategy](#)
- [Deleting a Retrieval Strategy](#)

6.3.1 Creating a Retrieval Strategy

To create a retrieval strategy:

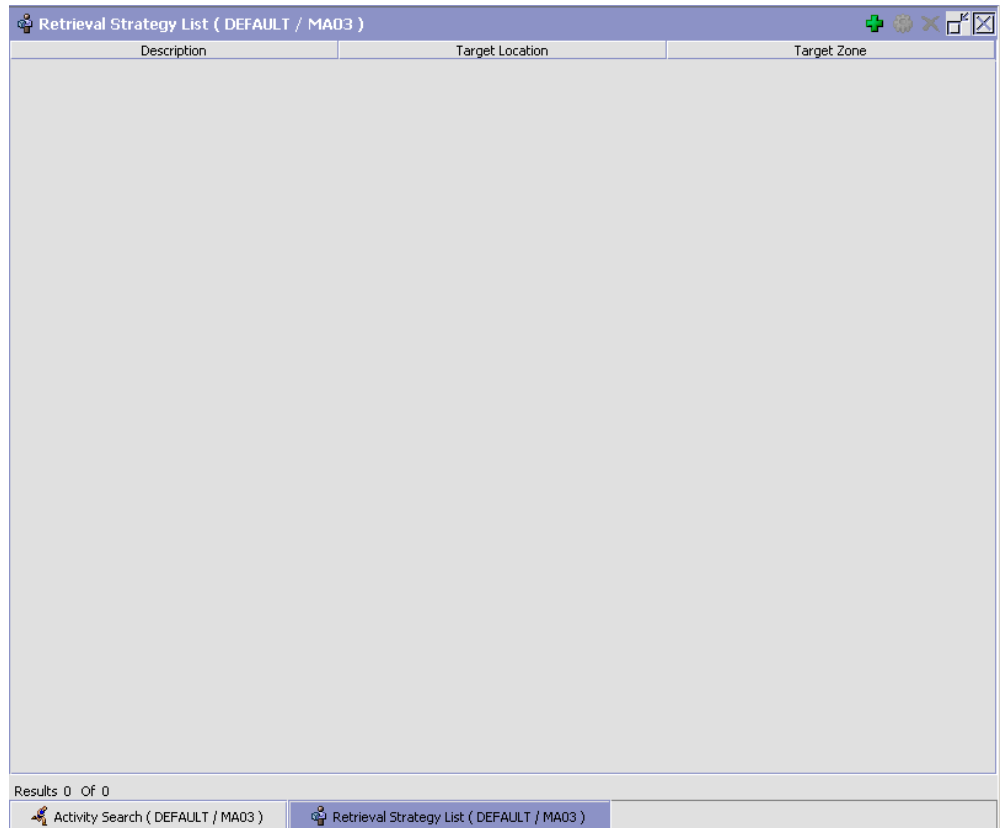
1. From the tree in the application rules side panel, choose Quality Control > Activities. The Activity Search window displays, with the list of activities.
2. In the top right corner, choose . The Retrieval Strategy List window displays.



3. In the Retrieval Strategy List window, choose . The Retrieval Strategy Details window displays.
4. Enter information in the applicable fields. Refer [Table 6–12](#) for field value descriptions.
5. Choose .

The screenshot shows a software window titled "Retrieval Strategy Details (DEFAULT / MA03)". The window contains a "Description" text input field. Below it are two radio buttons: "Target Location" (unselected) and "Target Zone" (selected). Underneath the radio buttons is a small icon of a building and another empty text input field. The window has a standard Windows-style title bar with minimize, maximize, and close buttons. At the bottom, there is a taskbar with three buttons: "Activity Search (DEFAULT / MA03)", "Retrieval Strategy List (DEFAULT / MA03)", and "Retrieval Strategy Details (DEFAULT / MA03)".

Table 6–12 *Retrieval Strategy Details Window*

Field	Description
Description	Enter a description for the retrieval strategy.

Table 6–12 Retrieval Strategy Details Window

Field	Description
Target Location	<p>Select if inventory is being retrieved to a specific location. For example, in retrieval for inspection strategy, inventory is retrieved to the quality control location in a warehouse.</p> <p>For more information about defining a target location, see Section 6.3.1.1, "Defining Target Location for Retrieval Strategy" on page 477.</p>
Target Zone	<p>Select if inventory is being retrieved to a zone. For example, in retrieval for receiving strategy, inventory is retrieved to the dock zone in a warehouse.</p> <p>For more information about defining a target location, see Section 6.3.1.2, "Defining Target Zone for Retrieval Strategy" on page 478.</p>

6.3.1.1 Defining Target Location for Retrieval Strategy

To define a target location for the retrieval strategy:

1. In the Retrieval Strategy Details window, select 'Target Location'.
2. Choose . The List of Values pop-up window displays.
3. Enter information in the applicable fields. Refer [Table 6–13](#) for field value descriptions.
4. Choose OK.

Note: When you define a target location for Retrieval Strategy, locations that are configured as REGULAR or STAGING displays.

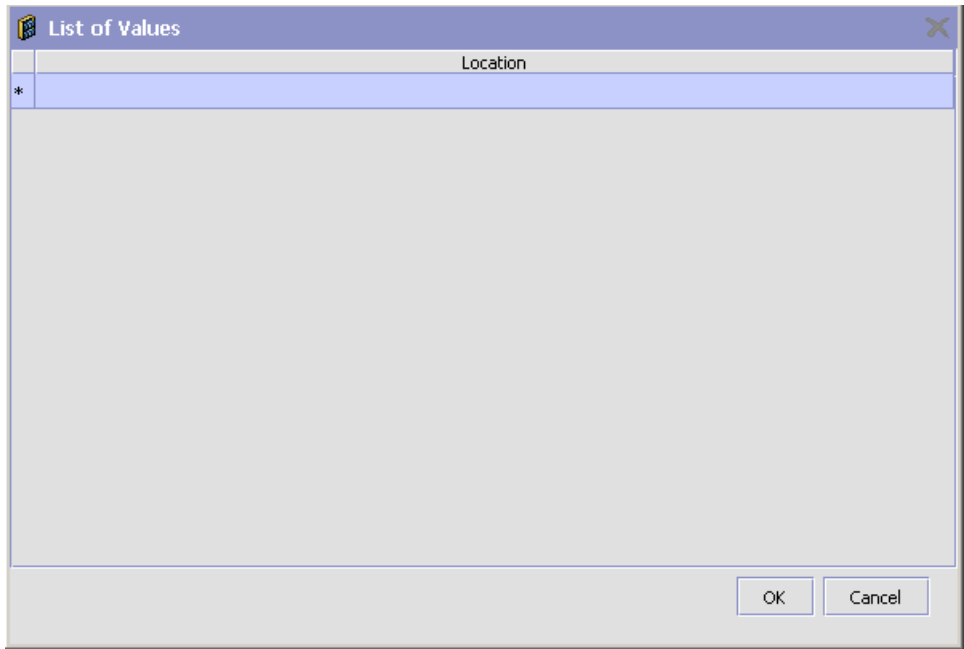



Table 6–13 *List of Values Pop-up Window*

Field	Description
Location	Choose the appropriate location for retrieval strategy.

6.3.1.2 Defining Target Zone for Retrieval Strategy

To define a target zone for the retrieval strategy:

1. In the Retrieval Strategy Details window, select 'Target Zone'.
2. Choose . The List of Values pop-up window displays.
3. Enter information in the applicable fields. Refer [Table 6–14](#) for field value descriptions.
4. Choose OK.

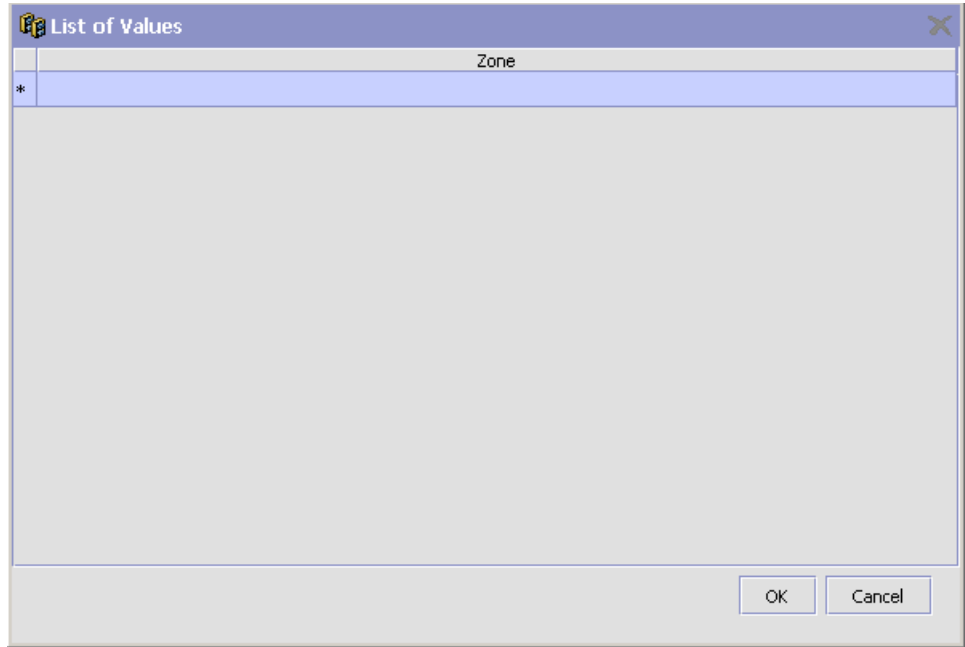

Table 6–14 *List of Values Pop-up Window*

Field	Description
Zone	Choose the appropriate zone for retrieval strategy.

6.3.1.2.1 Defining Pick Location Assignment

Pick Location Assignment (PLA) assigns the warehouse location(s) to the demand placed. PLA defines the list of zones to use for picking by specifying for a combination of item level attributes, such as classifications and unit of measure. Multiple PLA rules may be specified to ensure that the zone level constraints are unique to the item classification and unit of measure combination. For example, for SKUs stocked in pallets, cases and loose units, it is advisable to have 3 distinct rules to cover zones that are applicable for each unit of measure. The locations to be used in the zone can be filtered further by considering the least travel or pick-to-clean constraints.

After creating a Retrieval Strategy, you can define the Pick Location Assignment for the Retrieval Strategy.

To define pick location assignment:

1. On saving the Retrieval Strategy, the Pick Location panel displays in the Retrieval Strategy Details window.

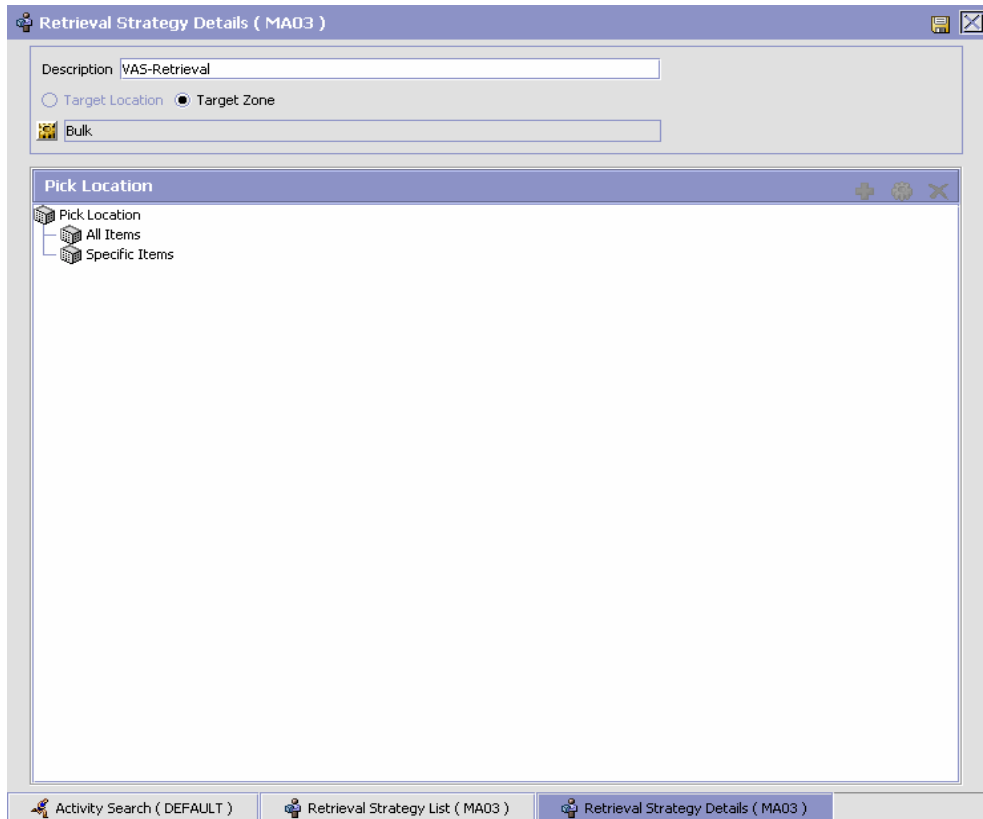



2. You can set up Pick Location Assignment for All Items or for Specific Items.

Assigning Pick Location Rules for All Items

You can define global PLA rules for all items in a warehouse based on unit of measure.

To assign pick location rules for all items:

1. From the Pick Location tree in the Pick Location panel in the Retrieval Strategy Details window, select All Items.
2. Choose . The UOM Condition pop-up window displays.
3. Enter information in the applicable fields. Refer to [Table 6–15](#) for field value descriptions.
4. Choose .

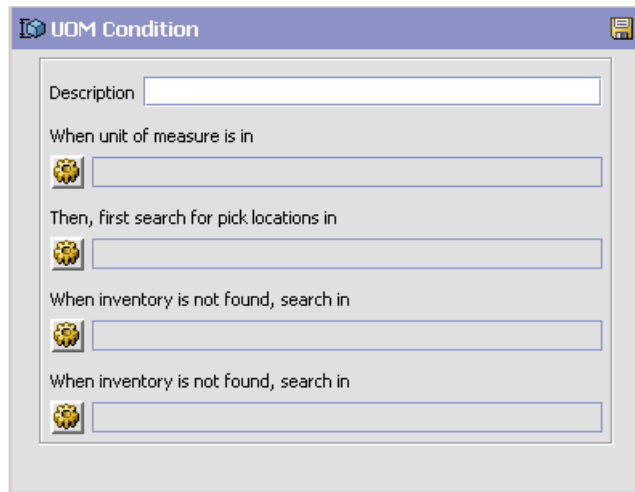

Table 6–15 UOM Condition Pop-Up Window





Field	Description
Description	Enter a brief description of the unit of measure condition.
When Unit of Measure is in	<p>You must specify the unit(s) of measure for which this condition is based. The system uses the pick location parameters that you specify to generate pick plans for items of the unit(s) of measure you select.</p> <p>Choose . The List of Values pop-up window displays. Select the blank line and choose a unit of measure from the drop-down menu. When you have finished adding units of measure, choose OK.</p>

Table 6–15 UOM Condition Pop-Up Window

Field	Description
Then First search for pick locations in	<p>You must specify the pick location parameters to be used initially.</p> <p>Choose . The Pick Location Assignment pop-up window displays. See The Pick Location Assignment Pop-Up Window for field level descriptions.</p> <p>When you have finished defining pick location parameters, choose OK.</p>
When inventory is not found, search in	<p>You can define pick location parameters to be used if inventory is not found using the initial parameters.</p> <p>Choose . The Pick Location Assignment pop-up window displays. See The Pick Location Assignment Pop-Up Window for field level descriptions.</p> <p>When you have finished defining pick location parameters, choose OK.</p>
When inventory is not found, search in	<p>You can define pick location parameters to be used if inventory is not found using the second set of parameters.</p> <p>Choose . The Pick Location Assignment pop-up window displays. See The Pick Location Assignment Pop-Up Window for field level descriptions.</p> <p>When you have finished defining pick location parameters, choose OK.</p>

The Pick Location Assignment Pop-Up Window

The Pick Location Assignment pop-up window is used to set the parameters used to determine the location from which items are picked. Refer to [Table 6–16](#) for field value descriptions.

Pick Location Assignment Rule

Description: Retrieval

Location Selection

1. Locations with Inventory Select locations having inventory from the following zones

 Select Inventory only when it is in one of the following status

 Optimize retrieval by Pick to clean Least number of trips Pick Sequence
 Round up quantity in a trip when possible to
 Case Each Half Pallet Inner Pack Pallet

2. Dedicated Locations For the remaining demand, select dedicated location(s) from the zones listed above.
 For items without dedicated locations dynamically slot a location from the zones listed above.

3. Cross Dock Locations For the demand left over from the previous steps, explore cross-docking opportunity.
 Search for inbound shipments that are in following status

Split Constraint
 Splitting is allowed for Pallets and Cases Pallets but not Cases Neither Pallets nor Cases

Task Creation
 Task Type: Retrieval Task Type - 3

OK Cancel

Table 6–16 Pick Location Assignment Window

Field	Description
Description	Enter a brief description of the pick location assignment parameters.
Location Selection	
Locations with Inventory	When this pick location assignment is used, the system initially tries to find the optimal location to pick inventory based on the parameters you define below. When allocating inventory to zones that have split constraints defined either at the PLA rule level or zone level, the Sterling Warehouse Management System does not consider any existing pend in quantities.

Table 6–16 Pick Location Assignment Window



Field	Description
Select locations having inventory from the following zones	<p>You must specify the zones that you want to pick from when this pick location assignment is used.</p> <p>Choose . The List of Values pop-up window displays. Select the blank line and choose a zone from the drop-down menu. When you have finished adding zones, choose OK.</p>
Optimize retrieval by	<ul style="list-style-type: none"> • Choose Pick to Clean to fulfill the demand by emptying as many LPNs or locations as possible for optimal usage of space in a zone. • Choose Least Number of Trips to fulfill the demand from the least number of locations, to enable users to make least number of trips when retrieving inventory. When there is more than one way to make the same least number of trips, the 'PickToClean' process is followed within the 'LeastNumberOfTrips' process. • Choose Pick Sequence to pick from locations in the order of their pick sequence. The system chooses locations having lower pick sequence numbers over locations having higher pick sequence numbers.
Round up quantity in a trip when possible to	<p>Select the unit of measure to round up to when retrieving inventory for replenishment. The round up occurs only in instances when there is sufficient inventory.</p> <p>For example, there is an item that is picked by EACH that needs to be replenished. 9 EACH needs to be replenished. 12 EACH make a CASE. If you select Case for this field, the algorithm rounds the unit of measure for this retrieval task from 9 EACH to 1 CASE.</p>
Dedicated Locations	<p>For pick demand that exists after the 'Locations with Inventory' algorithm has been performed, the system looks for locations dedicated specifically for the inventory.</p>

Table 6–16 Pick Location Assignment Window

Field	Description
For the remaining demand, select dedicated location(s) from the zones listed above.	Select this field if you want any pick demand that was not fulfilled using the above parameters to be picked from dedicated locations in the zones you have specified for Locations with Inventory. By selecting this field the system uses replenishment to ensure that the dedicated location remains stocked with pickable inventory.
For items without dedicated locations, dynamically slot a location from the zones listed above.	Select this field if you want items that do not have a dedicated picking location to be dynamically slotted for picking. The location is dynamically slotted in the zones you have specified for Locations with Inventory.
Cross Dock Locations	For any remaining pick demand, you can define the inbound shipment status level(s) from which items can be cross-docked. Cross-docking allows you to retrieve inventory directly from receiving staging locations and bring the inventory to the target location of the move request.
Search for inbound shipments that are in following status	<p>You can specify the inbound shipment status(es) that you want to search for inventory. The system searches for inbound shipments in the specified status(es). Once the shipment is received the system diverts the inventory to the dynamically slotted location.</p> <p>Choose . The List of Values pop-up window displays. Select the blank line and choose an inbound shipment status from the drop-down menu. When you have finished adding inbound shipment statuses, choose OK.</p>
Task Creation	
Task Type	<p>Choose the applicable task type.</p> <p>Choose  to create a new task type. For more information about Task Type, see Section 12.3, "Defining Task Types" on page 885.</p>

Note: For Dedicated Locations, Dynamic Slots, and Pick Fence, move request and replenish task are created. For Cross Dock Locations, move request and replenish task are NOT created, instead the Wave Release or Move Request Release creates "Activity Demand".

Assigning Pick Location Rules for Specific Items

You can define PLA rules for items in a warehouse based on item classification and unit of measure.

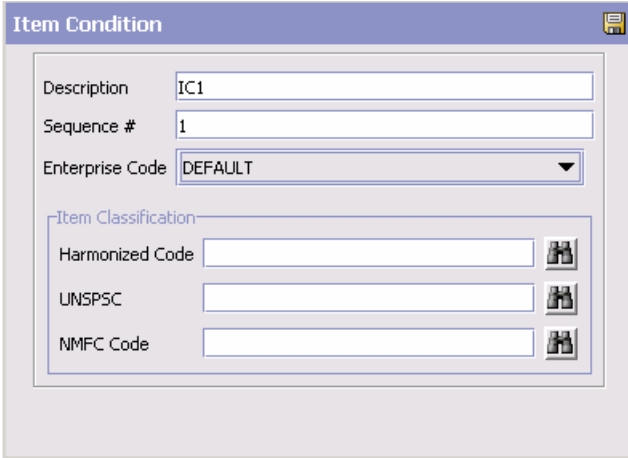

To assign pick location for specific items:

1. From the Pick Location tree in the Pick Location panel in the Retrieval Strategy Details window, select Specific Items.
2. Choose . The Item Condition pop-up window displays.



3. In Description, enter a brief description of the item condition.
4. In Sequence #, enter the sequence number. Items are evaluated for the criteria you define. The sequence number determines the order by which item conditions evaluate items. Once an item matches up with a item condition's criteria, it uses the applicable pick location assignment algorithms.



Note: When an item is being requested for performing PLA, the item conditions are evaluated in a sequence. Once any of the conditions is evaluated as 'true', no more conditions are further evaluated. The evaluated condition is used for performing PLA.

5. From Enterprise Code, select the Enterprise you want to associate with the item condition.
6. In Item Classification, enter the applicable classification parameters as per your business practices. Fields used in Classifications are mapped to the Enterprise that you select for the item condition. For more information about configuring classifications, see the *Catalog Management: Configuration Guide*.
7. Choose .
8. From the Pick Location tree, select the item assignment you created and choose . The UOM Condition pop-up window displays.
9. Enter information in the applicable fields. Refer to [Table 6–15](#) for field value descriptions.
10. Choose .

6.3.2 Modifying a Retrieval Strategy

Once a Retrieval Strategy has been created, it can be modified.



To modify a retrieval strategy:

1. From the tree in the application rules side panel, choose Quality Control > Activities. The Activity Search window displays, with the list of activities.
2. In the top right corner, choose . The Retrieval Strategy List window displays with the list of Retrieval Strategies.
3. In the Retrieval Strategy List window, choose the Retrieval Strategy to be modified.
4. Choose . The Retrieval Strategy Details window displays.

5. Enter information in the applicable fields. Refer [Table 6–12](#) for field value descriptions.
6. Choose .

6.3.3 Deleting a Retrieval Strategy

To delete a retrieval strategy:

1. From the tree in the application rules side panel, choose Quality Control > Activities. The Activity Search window displays, with the list of activities.
2. In the top right corner, choose . The Retrieval Strategy List window displays with the list of Retrieval Strategies.
3. In the Retrieval Strategy List window, choose the Retrieval Strategy to be deleted.
4. Choose .

6.4 Defining Putaway Preferences

Inventory being received at the dock require to be putaway to appropriate locations, based on shipment attributes, item classifications and location attributes.

The preferences for putting away of inventory is specified by zone and location storage attributes, for the SKU and container attributes.

Note: It is recommended that Zones containing Locations of type VIRTUAL should not be selected, while configuring the Putaway Preferences and Retrieval Strategy.

6.4.1 Selecting Putaway Preferences

The Sterling Warehouse Management System uses an algorithm to select the best storage or putaway preference for an activity from a list of preferences.

To select the best storage preference for an activity, the Sterling Warehouse Management System:

1. Determines if the inventory type is Single SKU, Multi SKU, or Unknown SKU.
If the inventory type is Single SKU, the system determines the corresponding UOM and item classification.
2. Determines the values of product class, inventory status, segment, or segment type for the inventory to match with the values configured in the storage preferences.
3. Sorts the matched values in the following order:
 - a. Enterprise Code
 - b. LPN Type
 - c. UOM
 - d. Product Class
 - e. Inventory Status
 - f. Segment Type
 - g. Segment
 - h. Item Classification 1
 - i. Item Classification 2
 - j. Item Classification 3

The best matched storage preference is used for the activity.

Use Putaway Preferences for:

- [Setting Up Putaway Preference for Single SKU](#)
- [Setting Up Putaway Preference for Multi-SKU/Multi-Level Container](#)
- [Setting Up Putaway Preferences for Container with Unknown Contents](#)

6.4.2 Setting Up Putaway Preference for Single SKU

The preferences for the putaway of a single SKU are specified here. This applies for all UOM of a SKU.

For example, the putaway preference for a CASE, PALLET and loose quantity of a single SKU being putaway are specified here.

Use Putaway Preferences for Single SKU set-up for:



- [Creating a Putaway Preferences for Single SKU](#)
- [Creating a New Putaway Preference for Single SKU from an existing Putaway Preference](#)
- [Modifying a Putaway Preference for Single SKU](#)
- [Deleting a Putaway Preference for Single SKU](#)

6.4.2.1 Creating a Putaway Preferences for Single SKU

To create a putaway preference for single SKU:

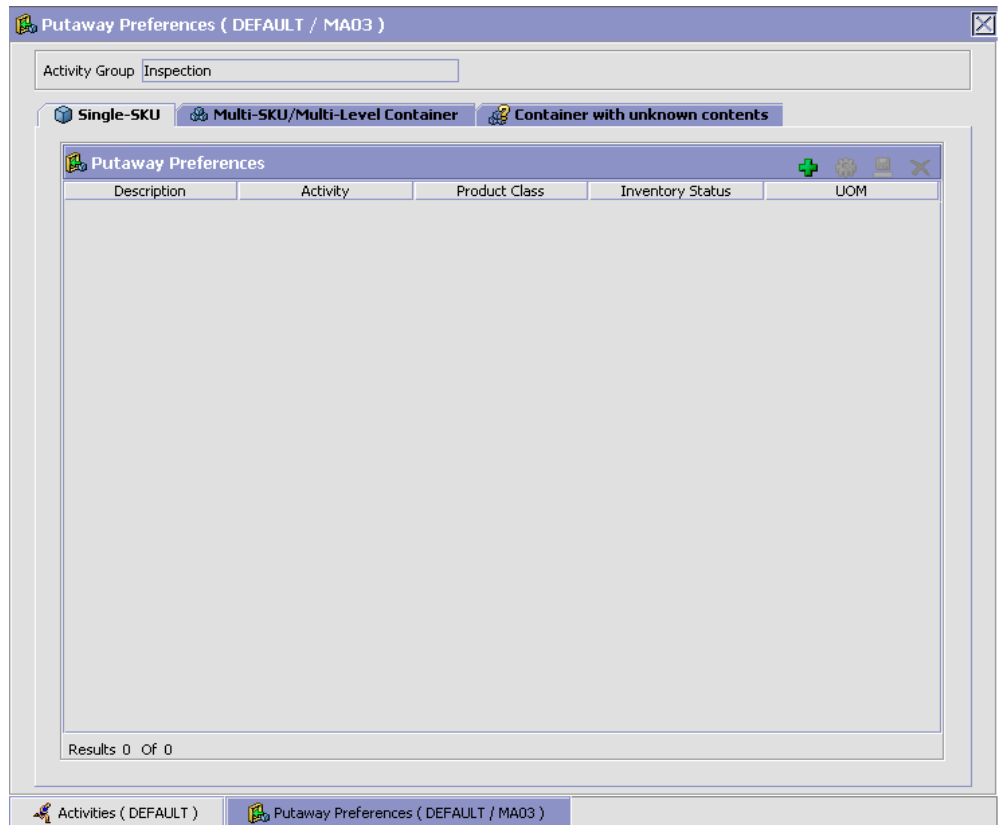
1. From the tree in the application rules side panel, choose Quality Control > Activities. The Activity Search window displays, with the list of activities.
2. In the top right corner, choose  in the Activity Search window to access Putaway Preferences window.
3. In the Putaway Preferences window, choose the Single-SKU tab. The Single-SKU tab window displays.



4. In the Single-SKU tab window, choose .
5. The Putaway Preference Details window displays.
6. Enter information in the applicable fields. Refer [Table 6–17](#) for field value descriptions.
7. Choose .

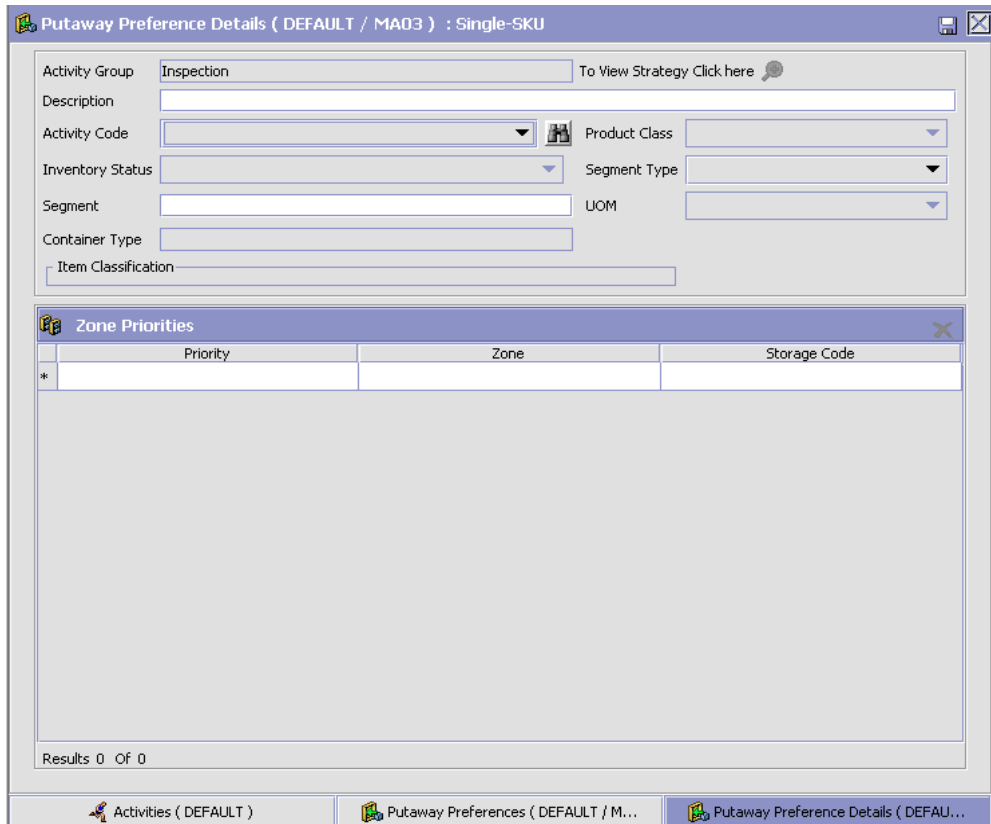

Table 6–17 Putaway Preference Details Window (Single SKU)

Field	Description
Activity Group	This is automatically populated by the system as 'INSPECTION'.
To View Strategy Click here	Choose  to view or set up Putaway Strategy. For more details on setting up a putaway strategy see Setting Up Putaway Strategy for Single-SKUs . Note: Putaway strategy may be specified for the putaway preferences after the preference is saved.
Description	Enter a brief description for the putaway preference.

Table 6–17 Putaway Preference Details Window (Single SKU)

Field	Description
Activity Code	Choose the activity code for the putaway preference. This is a mandatory field.
Product Class	Choose the product class for the preference, if applicable. Product class is the inventory classification of an item based on product's characteristics. Typical values are FQ - First Quality, SQ - Second Quality, etc.
Inventory Status	Choose the inventory status for the preference, if applicable. Inventory status refers to an inventory sub classification based on the results of the inventory control processes within the warehouse.
Segment Type	Enter the segment type for the preference, if applicable. This indicates an inventory category. Typical values are MTC – Made to Customer, and MTO - Made to Order.
Segment #	Enter the segment number for the preference, if applicable. A segment holds either the specific buyer or specific order number that requires dedication.
UOM	Choose the UOM for the preference, if applicable. UOM points to the Unit of measure of the item.
Container Type	The container type associated with the UOM selected displays. Typical values are "Pallet" and "Case".
Item Classification	List of putaway item classifications for the Enterprise display. An example, Product Line is shown below.
Product Line	Choose relevant product line item classification for the putaway activity. Choose  . In the Classification window, select the applicable product line classification.
Zone Priorities	

Table 6–17 Putaway Preference Details Window (Single SKU)

Field	Description
Priority	Enter a number to represent the priority. The priority is used to sequence the order in which the zone priorities are evaluated. For example, all storage code level priorities are to be evaluated first before generic priorities. The priority needs to be a positive integer, greater than zero. This is mandatory.
Zone	Choose the relevant zone for putaway. This is a mandatory field.
Storage Code	Choose the storage code for the zone, if applicable. This limits the locations being evaluated to the storage code specified. For example, putaway of hazardous items into a zone are restricted to the locations having the appropriate storage code.

Putaway strategy may be specified for the putaway preferences after the preference is saved. This is specified at an item classification and UOM level, if applicable.



Setting Up Putaway Strategy for Single-SKUs

You can set up putaway strategies to putaway applicable inventory from a source zone to a target zone, based on the strategy specified.

To set up putaway strategy for single-SKUs:

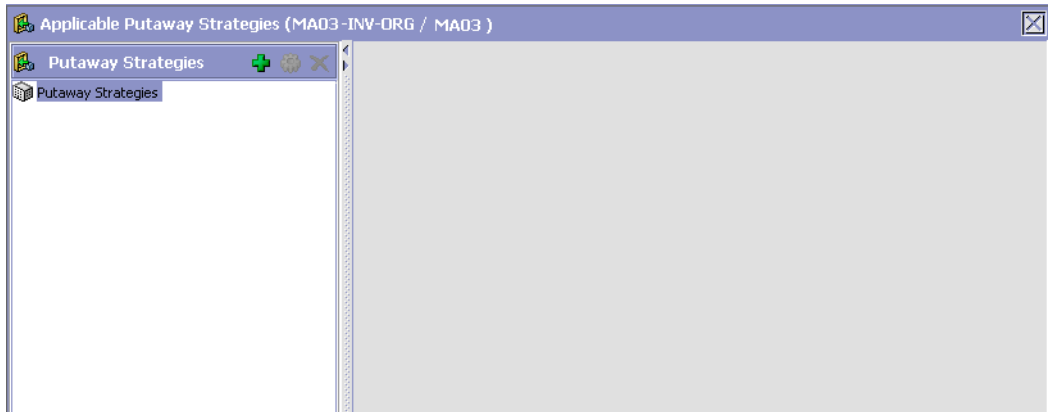
1. In the Putaway Preference Details : Single SKU window, choose .
2. The Applicable Putaway Strategies window is displayed.



3. Choose  in the Putaway Strategies panel. The Putaway Strategy Details window appears in the right panel.
4. Enter information in the applicable fields. See the Putaway Strategy Details Window table for field value descriptions.
5. Choose .

Putaway Strategy Details

Description: Strategy for DVD-LockAndKey-EACH UOM: CASE

Item Classification:

Product Line: DVD

StorageType: LockAndKey

Product Line:

System Directed Putaway Task Types

	Source Zone	Target Zone	Container Type	Task Type
*				

Results: 0 Of 0

Ad Hoc Task Types

	Source Zone	Target Zone	Container Type	Task Type
*				

Results: 0 Of 0

Table 6–18 Putaway Strategy Details Window

Field	Description
Description	Enter a description for the Putaway Strategy.
UOM	Select the UOM for the Putaway Strategy, if applicable. Note: The UOM will be defaulted in instances where it has been specified in the Putaway Preference Details screen.

Table 6–18 Putaway Strategy Details Window







Field	Description
Item Classification	List of putaway item classifications for the Enterprise are displayed. An example, Product Line is shown below.
Product Line	Choose relevant product line item classification for the putaway activity. Choose  . In the Classification Values window, select the applicable product line classification.
System Directed Putaway Task Types	Displays the list of existing system directed putaway task types. You may use  to delete an existing system directed putaway task type.
Source Zone	Select the source zone from where the inventory is sourced.
Target Zone	Select the target zone to where the inventory is moved.
Container Type	Select the container type to be used to move the inventory from the source zone to the target zone. Typical values are Case and Pallet.
Task Type	Select the Putaway Task Type applicable to this putaway strategy. This field displays the list of existing system directed task types that belong to the 'PUTAWAY' activity group.
Ad hoc Task Types	Displays the list of existing ad hoc task types. You may use  to delete an existing ad hoc task type.
Source Zone	Select the source zone from where the inventory is sourced.
Target Zone	Select the target zone to where the inventory is moved.

Table 6–18 Putaway Strategy Details Window

Field	Description
Container Type	Select the container type to be used to move the inventory from the source zone to the target zone. Typical values are Case and Pallet.
Task Type	Select the Putaway Task Type applicable to this putaway strategy. This field displays the list of existing ad hoc task types that belong to the 'PUTAWAY' activity group.

6.4.2.2 Creating a New Putaway Preference for Single SKU from an existing Putaway Preference



To create a new putaway preference for single SKU from an existing putaway preference:

1. From the tree in the application rules side panel, choose Quality Control > Activities. The Activity Search window displays, with the list of activities.
2. In the top right corner, choose  in the Activity Search window to access Putaway Preferences window.
3. In the Putaway Preferences window, choose the Single-SKU tab.
4. The Single-SKU tab window displays, with the list of putaway preferences.
5. Select the putaway preference to be copied from. Choose .
6. The Putaway Preference Details window displays.
7. Enter information in the applicable fields. Refer [Table 6–17](#) for field value descriptions.
8. Choose .

6.4.2.3 Modifying a Putaway Preference for Single SKU

Once a Putaway Preference for Single SKU has been created, it can be modified.



To modify a putaway preference for single SKU:

1. From the tree in the application rules side panel, choose Quality Control > Activities. The Activity Search window displays, with the list of activities.
2. In the top right corner, choose  in the Activity Search window to access Putaway Preferences window.
3. In the Putaway Preferences window, choose the Single-SKU tab.
4. The Single-SKU tab window displays, with the list of putaway preferences.
5. Select the putaway preference to be modified. Choose .
6. The Putaway Preference Details window displays.
7. Enter information in the applicable fields. Refer [Table 6–17](#) for field value descriptions.
8. Choose .

Only the description and item classification values not previously used may be specified. Additional zone priorities may also be specified. For all other changes, the preference must be deleted.

6.4.2.4 Deleting a Putaway Preference for Single SKU

To delete a putaway preference for single SKU:

1. From the tree in the application rules side panel, choose Quality Control > Activities. The Activity Search window displays, with the list of activities.
2. In the top right corner, choose  in the Activity Search window to access Putaway Preferences window.
3. In the Putaway Preferences window, choose the Single-SKU tab.
4. The Single-SKU tab window displays, with the list of putaway preferences.
5. Select the putaway preference to be deleted.
6. Choose .

6.4.3 Setting Up Putaway Preference for Multi-SKU/Multi-Level Container

The preferences for the putaway of a multi-level case or pallet are specified here. This also applies to multi-level CASE with LPN and PALLET with LPN.

Use the Putaway Preferences for Multi-Level SKU set-up for:

- [Creating a Putaway Preference for Multi-SKU/Multi-Level Container](#)
- [Creating a New Putaway Preference for a Multi-SKU/Multi-Level Container from an Existing Putaway Preference](#)
- [Modifying a Putaway Preference for Multi-SKU/Multi-Level Container](#)
- [Deleting a Putaway Preference for Multi-SKU/Multi-Level Container](#)

6.4.3.1 Creating a Putaway Preference for Multi-SKU/Multi-Level Container

To create a putaway preference for multi-SKU/multi-level container:

1. From the tree in the application rules side panel, choose Quality Control > Activities. The Activity Search window displays, with the list of activities.
2. In the top right corner, choose . The Putaway Preferences window displays.
3. In the Putaway Preferences window, choose the Multi-SKU/Multi-Level Container tab. The Multi-SKU/Multi-Level Container tab window displays.

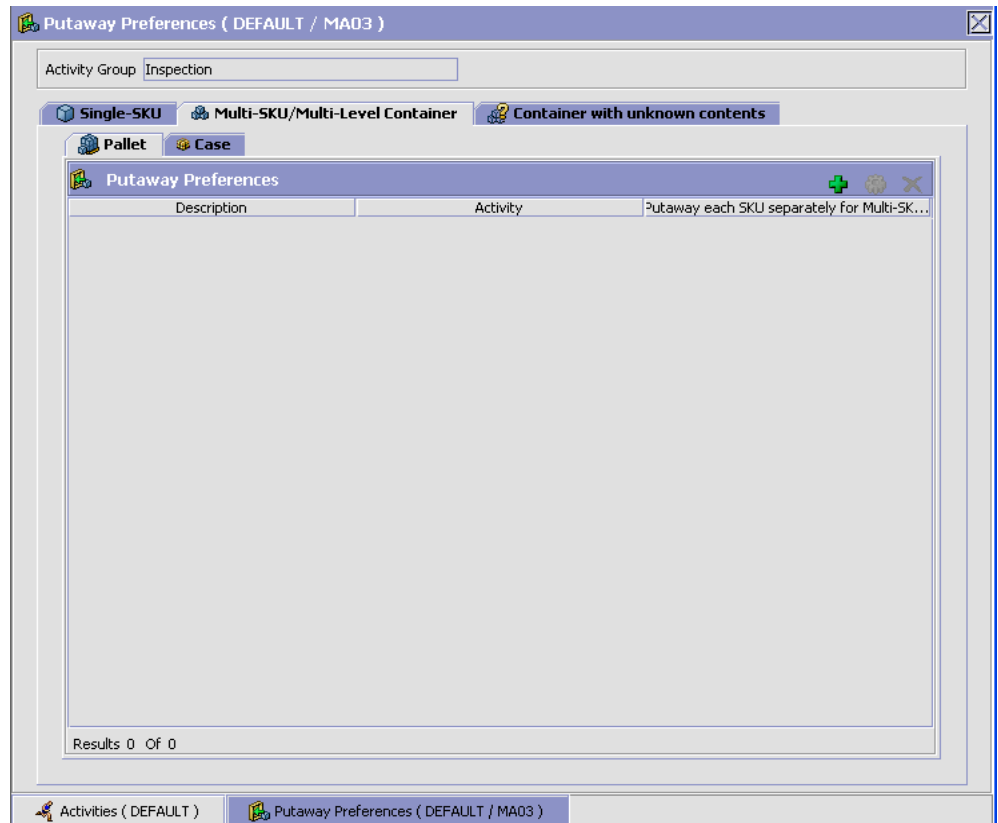



Putaway preferences for multi-level cases or pallets are specified separately:

- [Setting Up Putaway Preferences for a Multi-Level Pallet](#)
- [Setting Up Putaway Preference for a Multi-Level Case](#)

6.4.3.1.1 Setting Up Putaway Preferences for a Multi-Level Pallet

To set up putaway preference for a multi-level pallet:

1. In the Multi-SKU/Multi-Level Container tab of Putaway Preferences window, choose the Pallet tab. The Pallet tab window displays.
2. In the Pallet tab window, choose .

3. The Putaway Preference Details window displays.
4. Enter information in the applicable fields. Refer [Table 6–19](#) for field value descriptions.
5. Choose .

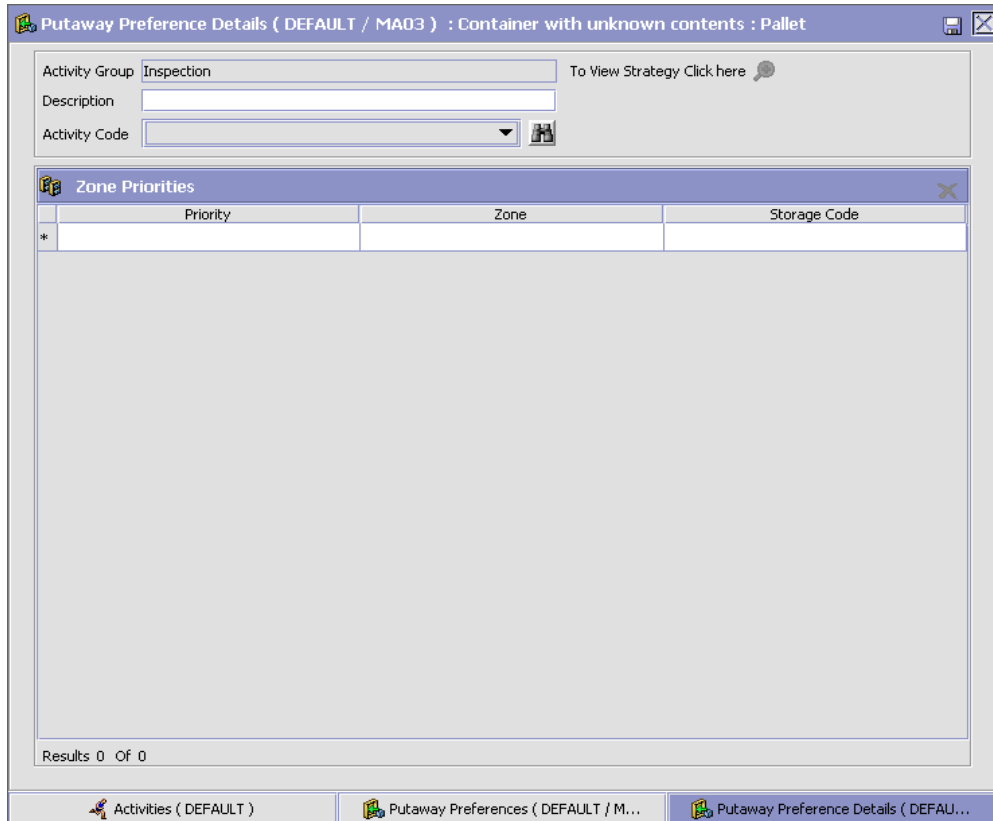

Putaway Preference Details (DEFAULT / MA03) : Container with unknown contents : Pallet

Activity Group: Inspection To View Strategy Click here

Description:

Activity Code: 

Zone Priorities

	Priority	Zone	Storage Code
*			

Results 0 Of 0

Activities (DEFAULT) Putaway Preferences (DEFAULT / M... Putaway Preference Details (DEFAU...

Table 6–19 Putaway Preference Details Window (Multi-Level Pallet)

Field	Description
Activity Group	This is automatically populated by the system as 'INSPECTION'.
To View Strategy Click here	Choose  to view or set up Putaway Strategy. For more details on setting up a putaway strategy see Setting Up Putaway Strategy for Multi-SKU/Multi-Level Containers - Pallets . Note: Putaway strategy may be specified for the putaway preferences after the preference is saved.
Description	Enter a brief description for the putaway preference.
Activity Code	Choose the activity code for the putaway preference. This is a mandatory field.
Put away each SKU separately for Multi-SKU Pallets	Select if each SKU on the multi-SKU pallet is evaluated individually. If selected, the putaway preferences for a single SKU are evaluated for the multi-SKU pallet. The Zone Priorities Panel is removed on this selection.
Zone Priorities	
Priority	Enter a number to represent the priority. The priority is used to sequence the order in which the zone priorities are evaluated. For example, all storage code level priorities are to be evaluated first before generic priorities. The priority needs to be a positive integer, greater than zero. This is mandatory.
Zone	Choose the relevant zone for putaway. This is a mandatory field.
Storage Code	Choose the storage code for the zone, if applicable. This limits the locations being evaluated to the storage code specified. For example, putaway of hazardous items into a zone are restricted to the locations having the appropriate storage code.

Putaway strategy may be specified for the putaway preferences after the preference is saved. This is specified at an item classification and UOM level, if applicable.



Setting Up Putaway Strategy for Multi-SKU/Multi-Level Containers - Pallets

You can set up putaway strategies to putaway applicable inventory from a source zone to a target zone, based on the strategy specified.

To set up putaway strategy for multi-SKU/multi-level container pallets:

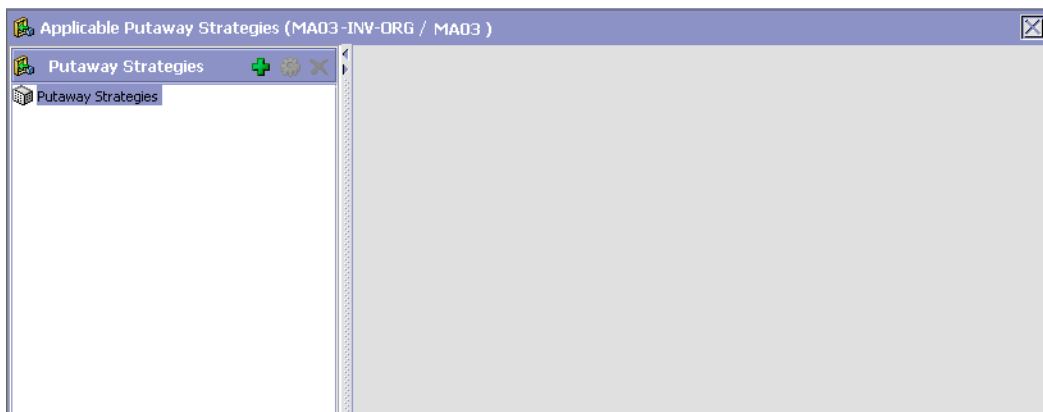
1. In the Putaway Preference Details : Multi-SKU/multi-level Containers : Pallet window, choose .
2. The Applicable Putaway Strategies window is displayed.



3. Choose  in the Putaway Strategies panel. The Putaway Strategy Details window appears in the right panel.
4. Enter information in the applicable fields. See the Putaway Strategy Details Window table for field value descriptions.
5. Choose .

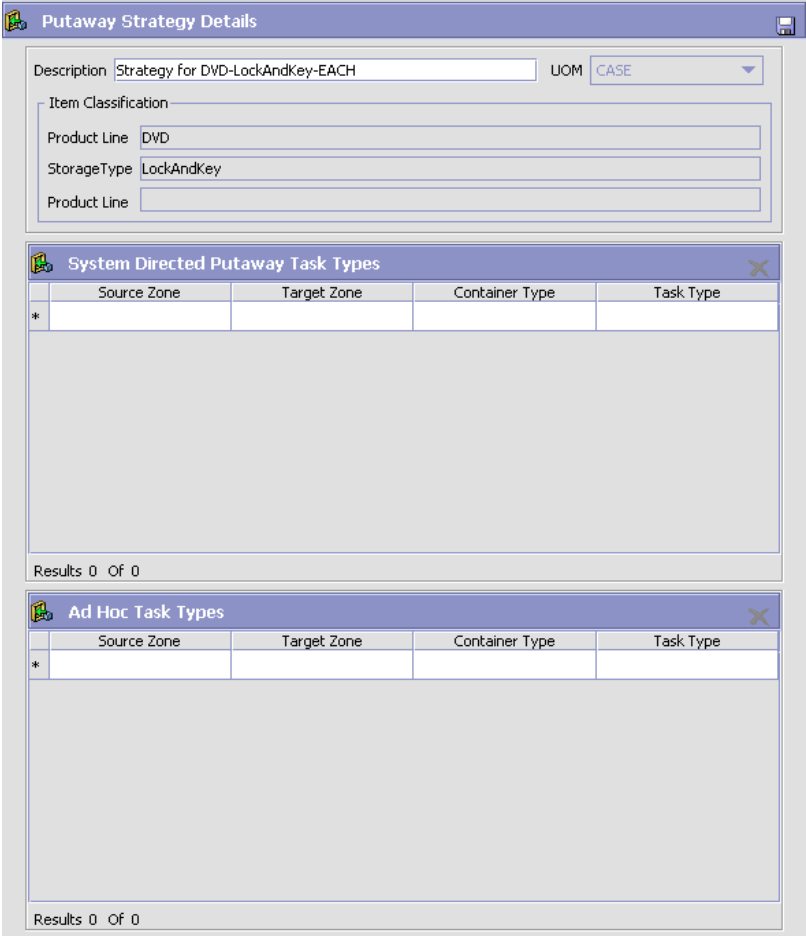

Table 6–20 Putaway Strategy Details Window

Field	Description
Description	Enter a description for the Putaway Strategy.
UOM	Select the UOM for the Putaway Strategy, if applicable. Note: The UOM will be defaulted in instances where it has been specified in the Putaway Preference Details screen.

Table 6–20 Putaway Strategy Details Window



Field	Description
Item Classification	List of putaway item classifications for the Enterprise are displayed. An example, Product Line is shown below.
Product Line	Choose relevant product line item classification for the putaway activity. Choose  . In the Classification Values window, select the applicable product line classification.
System Directed Putaway Task Types	Displays the list of existing system directed putaway task types. You may use  to delete an existing system directed putaway task type.
Source Zone	Select the source zone from where the inventory is sourced.
Target Zone	Select the target zone to where the inventory is moved.
Container Type	Select the container type to be used to move the inventory from the source zone to the target zone. Typical values are Case and Pallet.
Task Type	Select the Putaway Task Type applicable to this putaway strategy. This field displays the list of existing system directed task types that belong to the 'PUTAWAY' activity group.
Ad hoc Task Types	Displays the list of existing ad hoc task types. You may use  to delete an existing ad hoc task type.
Source Zone	Select the source zone from where the inventory is sourced.
Target Zone	Select the target zone to where the inventory is moved.

Table 6–20 Putaway Strategy Details Window



Field	Description
Container Type	Select the container type to be used to move the inventory from the source zone to the target zone. Typical values are Case and Pallet.
Task Type	Select the Putaway Task Type applicable to this putaway strategy. This field displays the list of existing ad hoc task types that belong to the 'PUTAWAY' activity group.

6.4.3.1.2 Setting Up Putaway Preference for a Multi-Level Case

To set up putaway preference for a multi-level case:

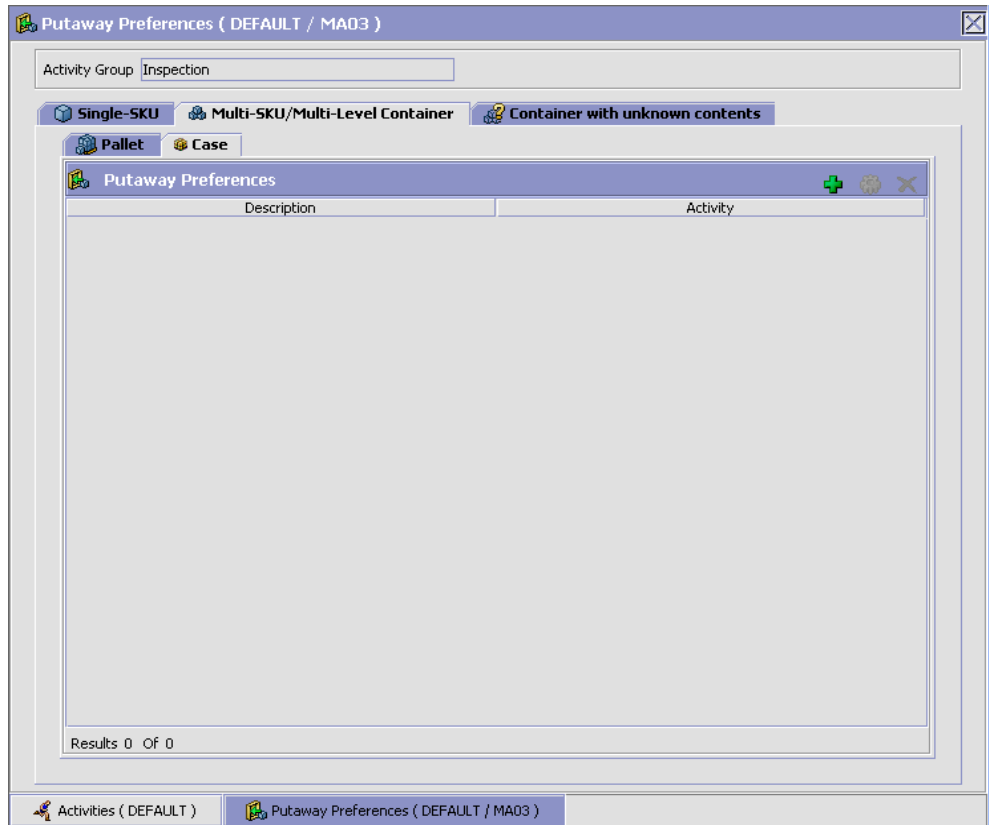
1. In the Multi-SKU/Multi-Level Container tab of Putaway Preferences window, choose the Case tab. The Case tab window displays.



2. In the Case tab window, choose .
3. The Putaway Preference Details window displays.
4. Enter information in the applicable fields. Refer [Table 6–21](#) for field value descriptions.
5. Choose .

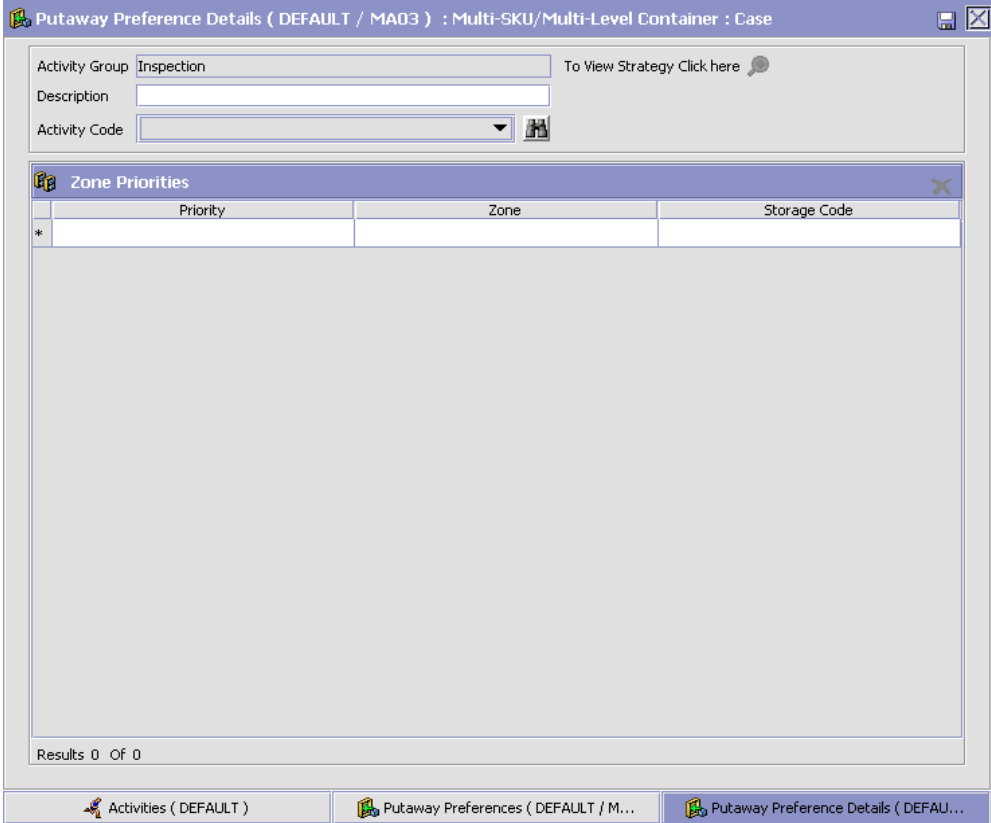

Table 6–21 Putaway Preference Details Window (Multi-Level Case)

Field	Description
Activity Group	This is automatically populated by the system as 'INSPECTION'.
To View Strategy Click here	Choose  to view or set up Putaway Strategy. For more details on setting up a putaway strategy see Setting Up Putaway Strategy for Multi-SKU/Multi-Level Containers - Cases . Note: Putaway strategy may be specified for the putaway preferences after the preference is saved.

Table 6–21 Putaway Preference Details Window (Multi-Level Case)

Field	Description
Description	Enter a brief description for the putaway preference.
Activity Code	Choose the activity code for the putaway preference. This is a mandatory field.
Zone Priorities	
Priority	Enter a number to represent the priority. The priority is used to sequence the order in which the zone priorities are evaluated. For example, all storage code level priorities are to be evaluated first before generic priorities. The priority needs to be a positive integer, greater than zero. This is mandatory.
Zone	Choose the relevant zone for putaway. This is a mandatory field.
Storage Code	Choose the storage code for the zone, if applicable. This limits the locations being evaluated to the storage code specified. For example, putaway of hazardous items into a zone are restricted to the locations having the appropriate storage code.

Putaway strategy may be specified for the putaway preferences after the preference is saved. This is specified at an item classification and UOM level, if applicable.



Setting Up Putaway Strategy for Multi-SKU/Multi-Level Containers - Cases

You can set up putaway strategies to putaway applicable inventory from a source zone to a target zone, based on the strategy specified.

To set up putaway strategy for multi-SKU/multi-level container cases:

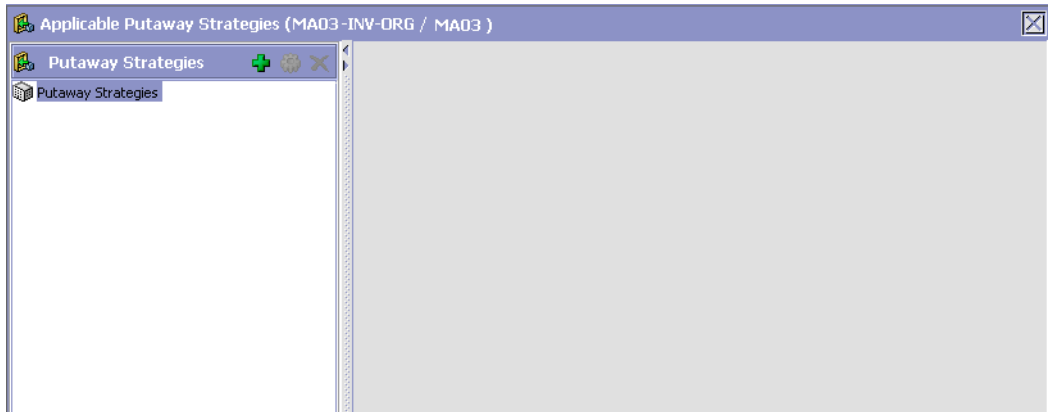
1. In the Putaway Preference Details : Multi-SKU/multi-level Containers : Case window, choose .
2. The Applicable Putaway Strategies window is displayed.



3. Choose  in the Putaway Strategies panel. The Putaway Strategy Details window appears in the right panel.
4. Enter information in the applicable fields. See the Putaway Strategy Details Window table for field value descriptions.
5. Choose .

Putaway Strategy Details

Description: Strategy for DVD-LockAndKey-EACH UOM: CASE

Item Classification

Product Line: DVD

StorageType: LockAndKey

Product Line:

System Directed Putaway Task Types

	Source Zone	Target Zone	Container Type	Task Type
*				

Results: 0 Of 0

Ad Hoc Task Types

	Source Zone	Target Zone	Container Type	Task Type
*				

Results: 0 Of 0

Table 6–22 Putaway Strategy Details Window

Field	Description
Description	Enter a description for the Putaway Strategy.
UOM	Select the UOM for the Putaway Strategy, if applicable. Note: The UOM will be defaulted in instances where it has been specified in the Putaway Preference Details screen.

Table 6–22 Putaway Strategy Details Window







Field	Description
Item Classification	List of putaway item classifications for the Enterprise are displayed. An example, Product Line is shown below.
Product Line	Choose relevant product line item classification for the putaway activity. Choose  . In the Classification Values window, select the applicable product line classification.
System Directed Putaway Task Types	Displays the list of existing system directed putaway task types. You may use  to delete an existing system directed putaway task type.
Source Zone	Select the source zone from where the inventory is sourced.
Target Zone	Select the target zone to where the inventory is moved.
Container Type	Select the container type to be used to move the inventory from the source zone to the target zone. Typical values are Case and Pallet.
Task Type	Select the Putaway Task Type applicable to this putaway strategy. This field displays the list of existing system directed task types that belong to the 'PUTAWAY' activity group.
Ad hoc Task Types	Displays the list of existing ad hoc task types. You may use  to delete an existing ad hoc task type.
Source Zone	Select the source zone from where the inventory is sourced.
Target Zone	Select the target zone to where the inventory is moved.

Table 6–22 Putaway Strategy Details Window

Field	Description
Container Type	Select the container type to be used to move the inventory from the source zone to the target zone. Typical values are Case and Pallet.
Task Type	Select the Putaway Task Type applicable to this putaway strategy. This field displays the list of existing ad hoc task types that belong to the 'PUTAWAY' activity group.

6.4.3.2 Creating a New Putaway Preference for a Multi-SKU/Multi-Level Container from an Existing Putaway Preference



To create a new putaway preference for multi-SKU/multi-level container from an existing putaway preference:

1. From the tree in the application rules side panel, choose Quality Control > Activities. The Activity Search window displays, with the list of activities.
2. In the top right corner, choose . The Putaway Preferences window displays.
3. In the Putaway Preferences window, choose the Multi-SKU/Multi-Level Container tab.
4. The Multi-SKU/Multi-Level Container tab window displays, with the list of putaway preferences.
5. Select the putaway preference to be copied from. Choose .
6. The Putaway Preference Details window displays.
7. Enter information in the applicable fields. For more information about modifying the fields, refer to [Section 6.4.3.1.1, "Setting Up Putaway Preferences for a Multi-Level Pallet"](#) on page 501 and [Section 6.4.3.1.2, "Setting Up Putaway Preference for a Multi-Level Case"](#) on page 507.
8. Choose .

6.4.3.3 Modifying a Putaway Preference for Multi-SKU/Multi-Level Container

Once a Putaway Preference for Multi-SKU/Multi-Level Container has been created, it can be modified.

To modify a putaway preference for multi-SKU/multi-level container:

1. From the tree in the application rules side panel, choose Quality Control > Activities. The Activity Search window displays, with the list of activities.
2. In the top right corner, choose . The Putaway Preferences window displays.
3. In the Putaway Preferences window, choose the Multi-SKU/Multi-Level Container tab.
4. The Multi-SKU/Multi-Level Container tab window displays, with the list of putaway preferences.
5. Select the putaway preference to be modified. Choose .
6. The Putaway Preference Details window displays.
7. Enter information in the applicable fields. For more information about modifying the fields, refer to [Section 6.4.3.1.1, "Setting Up Putaway Preferences for a Multi-Level Pallet"](#) on page 501 and [Section 6.4.3.1.2, "Setting Up Putaway Preference for a Multi-Level Case"](#) on page 507.
8. Choose .

The activity code corresponding to the preference cannot be modified. The preference must be deleted and recreated.

6.4.3.4 Deleting a Putaway Preference for Multi-SKU/Multi-Level Container

To delete a putaway preference for multiple SKU:

1. From the tree in the application rules side panel, choose Quality Control > Activities. The Activity Search window displays, with the list of activities.
2. In the top right corner, choose . The Putaway Preferences window displays.

3. In the Putaway Preferences window, choose the Multi-SKU/Multi-Level Container tab.
4. The Multi-SKU/Multi-Level Container tab window displays, with the list of putaway preferences.
5. Select the putaway preference to be deleted.
6. Choose .

6.4.4 Setting Up Putaway Preferences for Container with Unknown Contents

The preferences for the putaway of container with unknown contents are specified here. This applies to case and pallet with LPN where contents are not known.

For example, pre-receipt steps during receiving or returns where LPN labels may be scanned. Also, this applies to containers that are cross-docked to shipping lane upon receipt in merge in-transit centers.

Use Putaway Preferences for Container with Unknown Contents set-up for:

- [Creating a Putaway Preference for Container with Unknown Contents](#)
- [Creating a New Putaway Preference for Container with Unknown Contents from an Existing Putaway Preference](#)
- [Modifying a Putaway Preference for Container with Unknown Contents](#)
- [Deleting a Putaway Preference for Container with Unknown Contents](#)

6.4.4.1 Creating a Putaway Preference for Container with Unknown Contents

To create a putaway preference for container with unknown contents:

1. From the tree in the application rules side panel, choose Quality Control > Activities. The Activity Search window displays, with the list of activities.
2. In the top right corner, choose . The Putaway Preferences window displays.

3. In the Putaway Preferences window, choose the Container with Unknown Contents tab. The Container with Unknown Contents tab window displays.

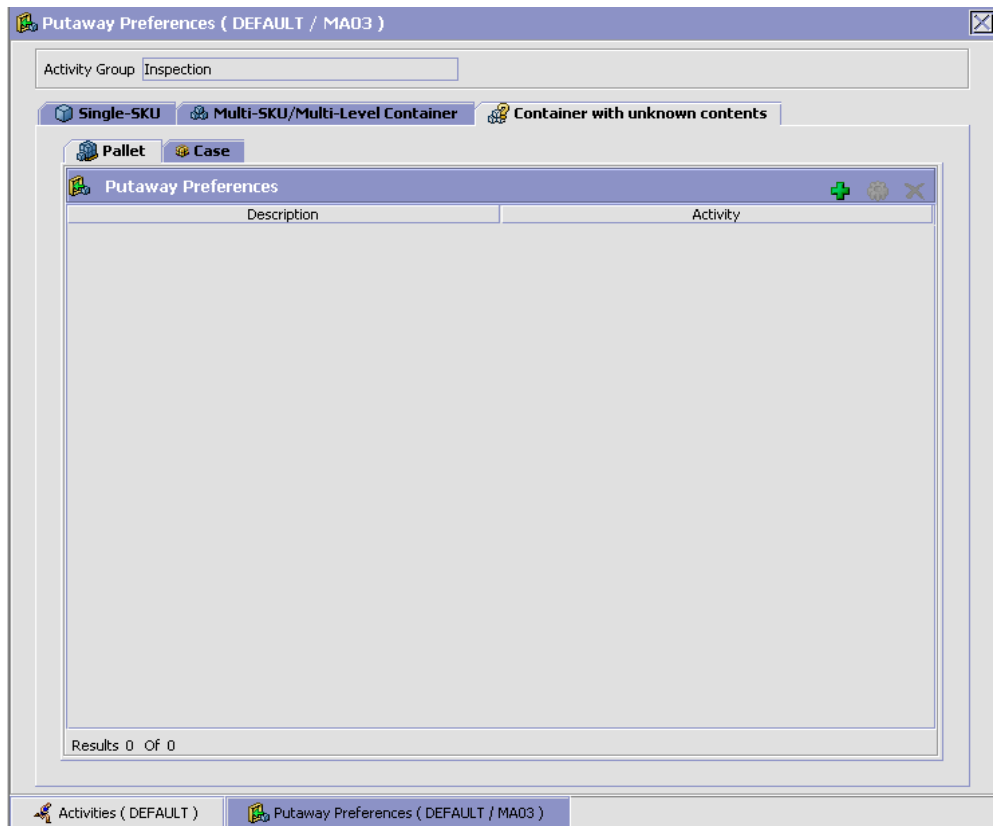



Putaway preferences are separately specified for a pallet and case:

- [Setting Up Putaway Preference for a Pallet](#)
- [Setting Up Putaway Preference for a Case](#)

6.4.4.1.1 Setting Up Putaway Preference for a Pallet

To set up putaway preference for a pallet:

1. In the Container with Unknown Contents tab of Putaway Preferences window, choose the Pallet tab. The Pallet tab window displays.

2. In the Pallet tab window, choose .
3. The Putaway Preference Details window displays.
4. Enter information in the applicable fields. Refer [Table 6–23](#) for field value descriptions.
5. Choose .

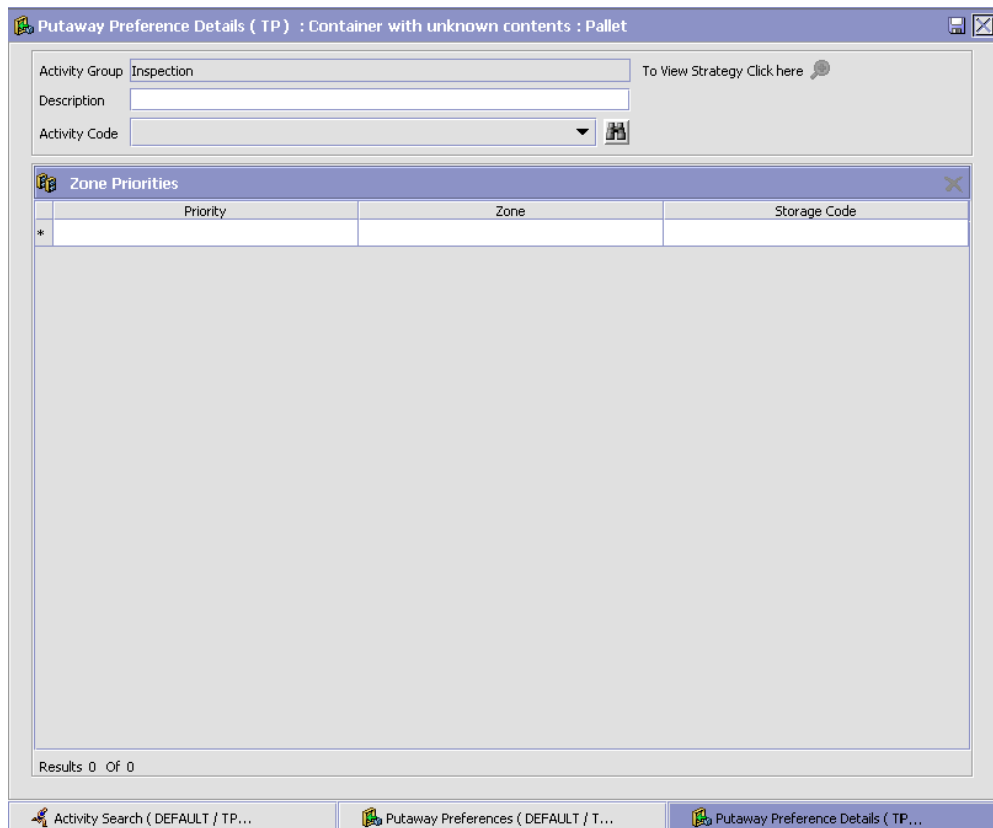

Putaway Preference Details (TP) : Container with unknown contents : Pallet

Activity Group: Inspection To View Strategy Click here

Description:

Activity Code: 

Priority	Zone	Storage Code
*		

Results 0 Of 0

Activity Search (DEFAULT / TP... Putaway Preferences (DEFAULT / T... Putaway Preference Details (TP...

Table 6–23 Putaway Preference Details Window - Container with Unknown Contents Pallet Tab

Field	Description
Activity Group	This is automatically populated by the system as 'INSPECTION'.
To View Strategy Click here	Choose  to view or set up Putaway Strategy. For more details on setting up a putaway strategy see Setting Up Putaway Strategy for Containers with Unknown Contents - Pallets . Note: Putaway strategy may be specified for the putaway preferences after the preference is saved.
Description	Enter a description for the activity constraint.
Activity Code	Choose the activity code for the putaway preference. This is a mandatory field.
Zone Priorities	
Priority	Enter a number to represent the priority. The priority is used to sequence the order in which the zone priorities are evaluated. For example, all storage code level priorities are to be evaluated first before generic priorities. The priority needs to be a positive integer, greater than zero. This is mandatory.
Zone	Choose the relevant zone for putaway. This is a mandatory field.
Storage Code	Choose the storage code for the zone, if applicable. This limits the locations being evaluated to the storage code specified. For example, putaway of hazardous items into a zone are restricted to the locations having the appropriate storage code.

For example, pre-received pallets, when putaway is automatically sorted by shipment, SCAC utilizing the above fields.



Setting Up Putaway Strategy for Containers with Unknown Contents - Pallets

You can set up putaway strategies to putaway applicable inventory from a source zone to a target zone, based on the strategy specified.

To set up putaway strategy for container with unknown content pallets:

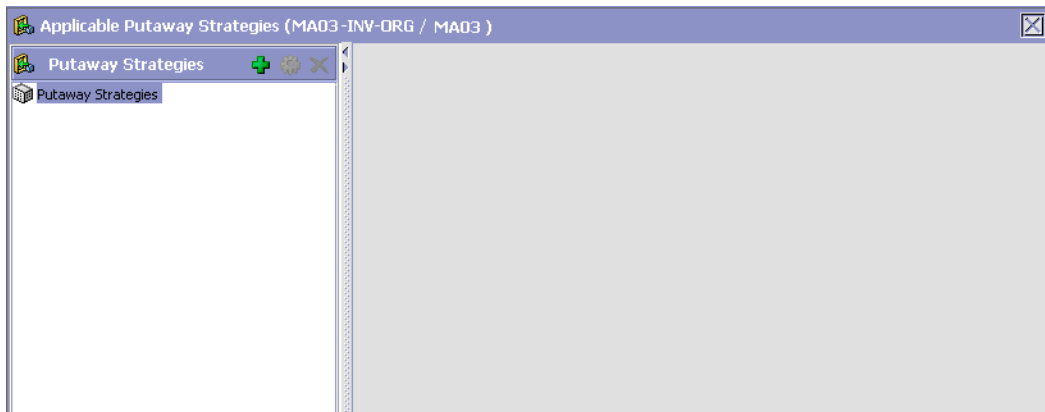
1. In the Putaway Preference Details : Container with unknown contents : Pallet window, choose .
2. The Applicable Putaway Strategies window is displayed.



3. Choose  in the Putaway Strategies panel. The Putaway Strategy Details window appears in the right panel.
4. Enter information in the applicable fields. See the Putaway Strategy Details Window table for field value descriptions.
5. Choose .

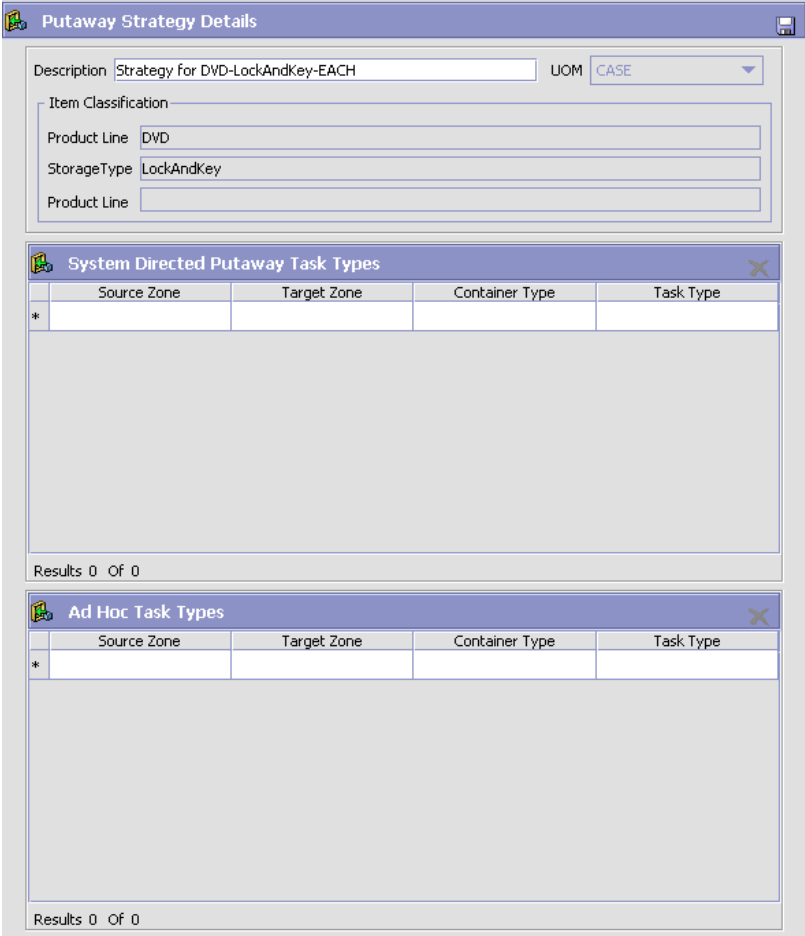

Table 6–24 Putaway Strategy Details Window

Field	Description
Description	Enter a description for the Putaway Strategy.
UOM	Select the UOM for the Putaway Strategy, if applicable. Note: The UOM will be defaulted in instances where it has been specified in the Putaway Preference Details screen.

Table 6–24 Putaway Strategy Details Window



Field	Description
Item Classification	List of putaway item classifications for the Enterprise are displayed. An example, Product Line is shown below.
Product Line	Choose relevant product line item classification for the putaway activity. Choose  . In the Classification Values window, select the applicable product line classification.
System Directed Putaway Task Types	Displays the list of existing system directed putaway task types. You may use  to delete an existing system directed putaway task type.
Source Zone	Select the source zone from where the inventory is sourced.
Target Zone	Select the target zone to where the inventory is moved.
Container Type	Select the container type to be used to move the inventory from the source zone to the target zone. Typical values are Case and Pallet.
Task Type	Select the Putaway Task Type applicable to this putaway strategy. This field displays the list of existing system directed task types that belong to the 'PUTAWAY' activity group.
Ad hoc Task Types	Displays the list of existing ad hoc task types. You may use  to delete an existing ad hoc task type.
Source Zone	Select the source zone from where the inventory is sourced.
Target Zone	Select the target zone to where the inventory is moved.

Table 6–24 Putaway Strategy Details Window



Field	Description
Container Type	Select the container type to be used to move the inventory from the source zone to the target zone. Typical values are Case and Pallet.
Task Type	Select the Putaway Task Type applicable to this putaway strategy. This field displays the list of existing ad hoc task types that belong to the 'PUTAWAY' activity group.

6.4.4.1.2 Setting Up Putaway Preference for a Case

To set up putaway preference for a case:

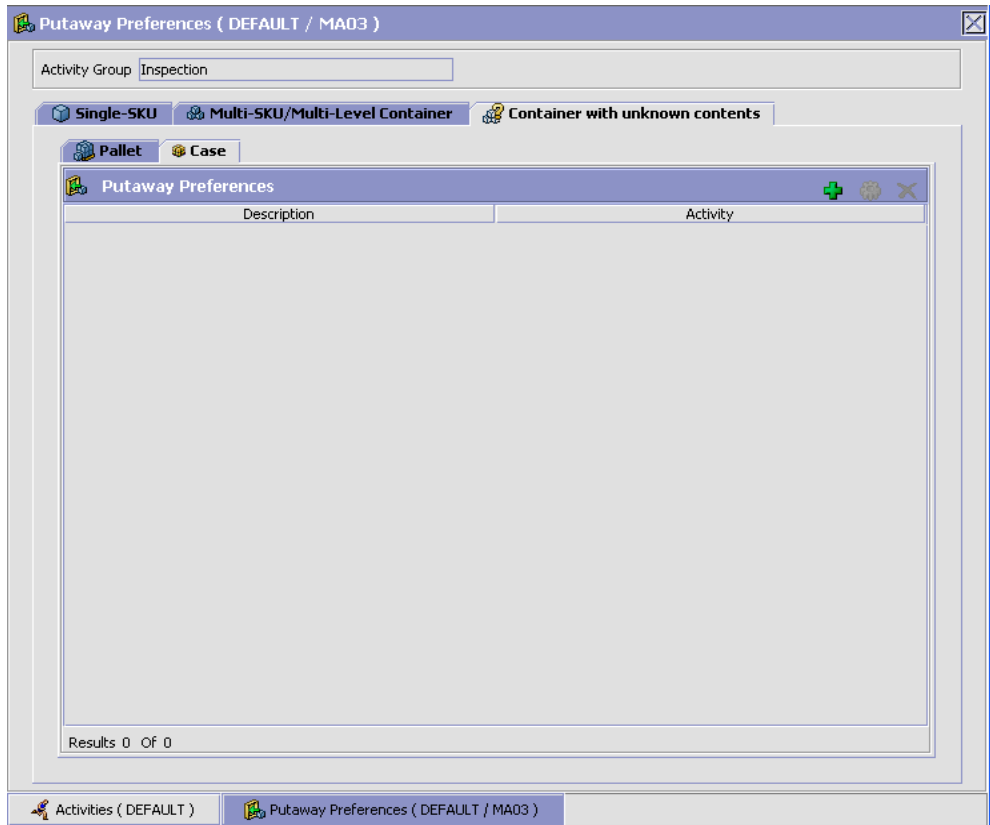
1. In the Container with Unknown Contents tab of Putaway Preferences window, choose the Case tab. The Case tab window displays.



2. In the Case tab window, choose .
3. The Putaway Preference Details window displays.
4. Enter information in the applicable fields. Refer [Table 6–25](#) for field value descriptions.
5. Choose .

Putaway Preference Details (DEFAULT / MA03) : Container with unknown contents : Case

Activity Group: Inspection To View Strategy Click here

Description:

Activity Code:

Zone Priorities

	Priority	Zone	Storage Code
*			

Results: 0 Of 0

Activities (DEFAULT) Putaway Preferences (DEFAULT / M... Putaway Preference Details (DEFAU...

Table 6–25 Putaway Preference Details Window - Container with Unknown Contents Case Tab

Field	Description
Activity Group	This is automatically populated by the system as 'INSPECTION'.
To View Strategy Click here	Choose  to view or set up Putaway Strategy. For more details on setting up a putaway strategy see Setting Up Putaway Strategy for Containers with Unknown Contents - Cases . Note: Putaway strategy may be specified for the putaway preferences after the preference is saved.
Description	Enter a description for the activity constraint.
Activity Code	Choose the activity code for the putaway preference. This is a mandatory field.
Zone Priorities	
Priority	Enter a number to represent the priority. The priority is used to sequence the order in which the zone priorities are evaluated. For example, all storage code level priorities are to be evaluated first before generic priorities. The priority needs to be a positive integer, greater than zero. This is mandatory.
Zone	Choose the relevant zone for putaway. This is a mandatory field.
Storage Code	Choose the storage code for the zone, if applicable. This limits the locations being evaluated to the storage code specified. For example, putaway of hazardous items into a zone are restricted to the locations having the appropriate storage code.



Setting Up Putaway Strategy for Containers with Unknown Contents - Cases

You can set up putaway strategies to putaway applicable inventory from a source zone to a target zone, based on the strategy specified.

To set up putaway strategy for container with unknown content cases:

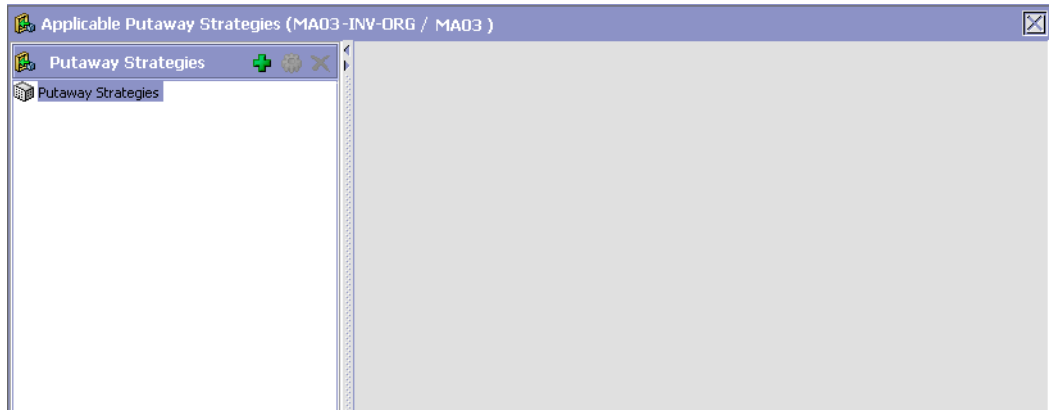
1. In the Putaway Preference Details : Container with unknown contents : Case window, choose .
2. The Applicable Putaway Strategies window is displayed.



3. Choose  in the Putaway Strategies panel. The Putaway Strategy Details window appears in the right panel.
4. Enter information in the applicable fields. See the Putaway Strategy Details Window table for field value descriptions.
5. Choose .

Putaway Strategy Details

Description: Strategy for DVD-LockAndKey-EACH UOM: CASE

Item Classification

Product Line: DVD

StorageType: LockAndKey

Product Line:

System Directed Putaway Task Types

	Source Zone	Target Zone	Container Type	Task Type
*				

Results: 0 Of 0

Ad Hoc Task Types

	Source Zone	Target Zone	Container Type	Task Type
*				

Results: 0 Of 0

Table 6–26 Putaway Strategy Details Window

Field	Description
Description	Enter a description for the Putaway Strategy.
UOM	Select the UOM for the Putaway Strategy, if applicable. Note: The UOM will be defaulted in instances where it has been specified in the Putaway Preference Details screen.

Table 6–26 Putaway Strategy Details Window







Field	Description
Item Classification	List of putaway item classifications for the Enterprise are displayed. An example, Product Line is shown below.
Product Line	Choose relevant product line item classification for the putaway activity. Choose  . In the Classification Values window, select the applicable product line classification.
System Directed Putaway Task Types	Displays the list of existing system directed putaway task types. You may use  to delete an existing system directed putaway task type.
Source Zone	Select the source zone from where the inventory is sourced.
Target Zone	Select the target zone to where the inventory is moved.
Container Type	Select the container type to be used to move the inventory from the source zone to the target zone. Typical values are Case and Pallet.
Task Type	Select the Putaway Task Type applicable to this putaway strategy. This field displays the list of existing system directed task types that belong to the 'PUTAWAY' activity group.
Ad hoc Task Types	Displays the list of existing ad hoc task types. You may use  to delete an existing ad hoc task type.
Source Zone	Select the source zone from where the inventory is sourced.
Target Zone	Select the target zone to where the inventory is moved.

Table 6–26 Putaway Strategy Details Window

Field	Description
Container Type	Select the container type to be used to move the inventory from the source zone to the target zone. Typical values are Case and Pallet.
Task Type	Select the Putaway Task Type applicable to this putaway strategy. This field displays the list of existing ad hoc task types that belong to the 'PUTAWAY' activity group.

6.4.4.2 Creating a New Putaway Preference for Container with Unknown Contents from an Existing Putaway Preference



To create a new putaway preference for container with unknown contents from an existing putaway preference:

1. From the tree in the application rules side panel, choose Quality Control > Activities. The Activity Search window displays, with the list of activities.
2. In the top right corner, choose . The Putaway Preferences window displays.
3. In the Putaway Preferences window, choose the Container with Unknown Contents tab.
4. The Container with Unknown Contents tab window displays, with the list of putaway preferences.
5. Select the putaway preference to be copied from. Choose .
6. The Putaway Preference Details window displays.
7. Enter information in the applicable fields. For more information about modifying the fields, refer to [Section 6.4.4.1.1, "Setting Up Putaway Preference for a Pallet"](#) on page 517 and [Section 6.4.4.1.2, "Setting Up Putaway Preference for a Case"](#) on page 523.
8. Choose .

6.4.4.3 Modifying a Putaway Preference for Container with Unknown Contents

Once a Putaway Preference for Container with Unknown Contents has been created, it can be modified.

To modify a putaway preference for container with unknown contents:

1. From the tree in the application rules side panel, choose Quality Control > Activities. The Activity Search window displays, with the list of activities.
2. In the top right corner, choose . The Putaway Preferences window displays.
3. In the Putaway Preferences window, choose the Container with Unknown Contents tab.
4. The Container with Unknown Contents tab window displays, with the list of putaway preferences.
5. Select the putaway preference to be modified. Choose .
6. The Putaway Preference Details window displays.
7. Enter information in the applicable fields. For more information about modifying the fields, refer to [Section 6.4.4.1.1, "Setting Up Putaway Preference for a Pallet"](#) on page 517 and [Section 6.4.4.1.2, "Setting Up Putaway Preference for a Case"](#) on page 523.
8. Choose .

The activity code corresponding to the preference cannot be modified. The preference must be deleted and recreated.

6.4.4.4 Deleting a Putaway Preference for Container with Unknown Contents

To delete a putaway preference for container with unknown contents:

1. From the tree in the application rules side panel, choose Quality Control > Activities. The Activity Search window displays, with the list of activities.
2. In the top right corner, choose . The Putaway Preferences window displays.
3. In the Putaway Preferences window, choose the Container with Unknown Contents tab.
4. The Container with Unknown Contents tab window displays, with the list of putaway preferences.
5. Select the putaway preference to be deleted.

6. Choose .

Configuring Picking

You can define the parameters and common codes used for determining algorithms and pipelines used for picking.

You can use the Picking branch for:

- [Defining the Outbound Pick Process Model](#)
- [Defining Pick Planning Parameters](#)
- [Defining Wave Cancellation Reasons](#)
- [Defining Purge Criteria](#)

7.1 Defining the Outbound Pick Process Model

Outbound Pick Process Model defines parameters and templates that distinguish a process type.

A **process type pipeline** is a series of transactions and statuses that guide document types, such as a Return Order, through a predefined process. A pipeline consists of the different statuses a document goes through during fulfillment, negotiation, shipment, or receipt. You can also set up transactions consisting of events, actions, and conditions, as they pertain to the pipeline you are configuring.

Repositories

A repository is a logical collection of entities that define the business process workflow.

The following entities are included in a repository:

- Pipelines
- Transactions

- Statuses
- Conditions
- Actions
- Services

Selling and Fulfillment Foundation provides a base repository for each of the system-defined process types. Some of the entities within a repository are copied when creating a new document type. For more information about creating a new document type, see the *Selling and Fulfillment Foundation: Application Platform Configuration Guide*.

The process of outbound picking is modeled through a pipeline. This represents the process configuration that is unique to a warehouse. A warehouse may also specify unique processes for each participating enterprise.

7.1.1 Pipeline Determination

Important: Pipeline determination rules are NOT used for outbound picking pipelines. As part of the shipment group configuration you can associate the pipeline to be used. For more information about associating a pipeline with a shipment group, see [Section 7.2.1.6, "Defining a Shipment Group's Advanced Parameters"](#) on page 600.

7.1.1.1 Condition Variables for Pipeline Determination

When using conditions for pipeline determination, the following condition variables can be used:

- Activity Group ID
- Shipment Group ID

7.1.2 Pipelines

For more information about Pipelines, see the *Selling and Fulfillment Foundation: Application Platform Configuration Guide*.

To view the outbound picking pipeline details:

1. From the tree in the application rules side panel, choose Picking > Outbound Picking > Pick Process Model. The Outbound Picking window displays.

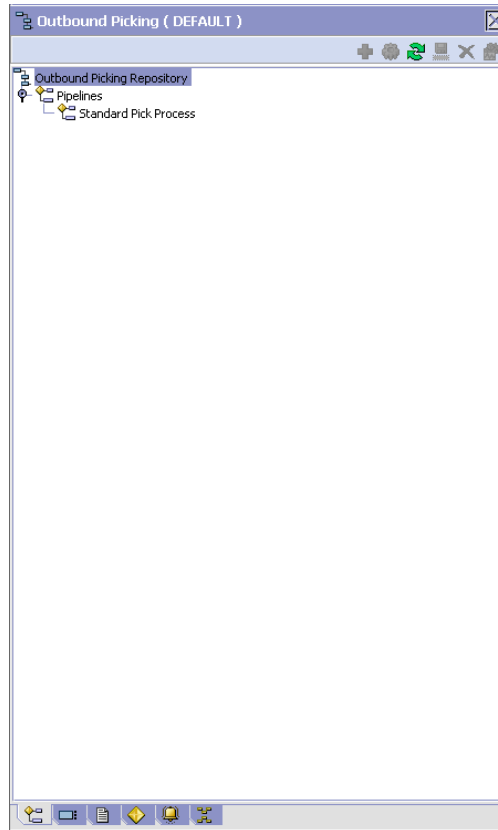

2. In the Outbound Picking window, choose Standard Pick Process. The Pipeline Detail: Standard Pick Process (Outbound Picking) window displays.

For more information about creating and modifying a Pipeline, see the *Selling and Fulfillment Foundation: Application Platform Configuration Guide*.

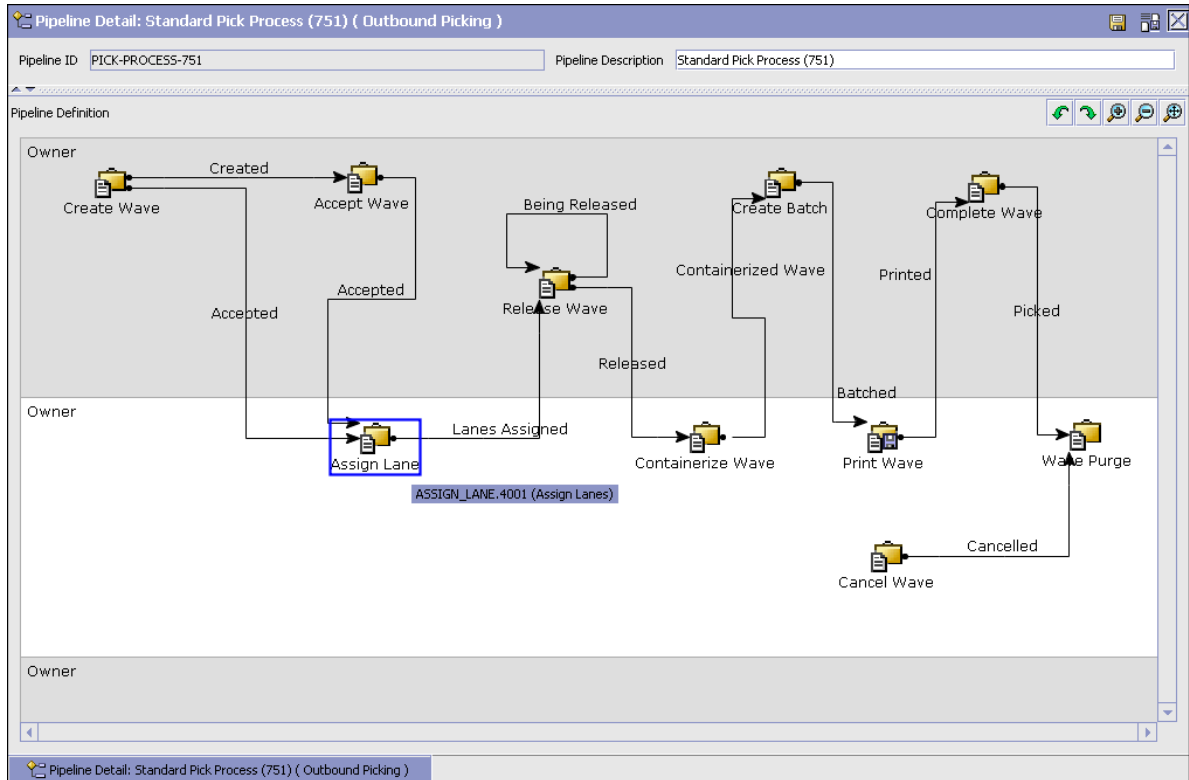

7.1.3 Transactions

Every process type has a set of base transactions defined for it. A transaction is a logical unit of work that is necessary for performing an activity within Selling and Fulfillment Foundation. Base transactions are predefined transactions that contain information about how the transaction behaves, such as how many copies of a transaction can be kept in a process type and whether or not it can have configurable base pick and drop statuses. Base transactions can be used to create new transactions. These transactions can be changed within the limits defined in the base transaction.

For more information about Transactions, see the *Selling and Fulfillment Foundation: Application Platform Configuration Guide*.

To view the transaction details for an outbound picking pipeline:

1. From the tree in the application rules side panel, choose Picking > Pick Process Model. The Outbound Picking window displays.
2. In the Outbound Picking window, choose .
3. The Transactions tab window displays.

For more information about creating and modifying Transactions, see the *Selling and Fulfillment Foundation: Application Platform Configuration Guide*.

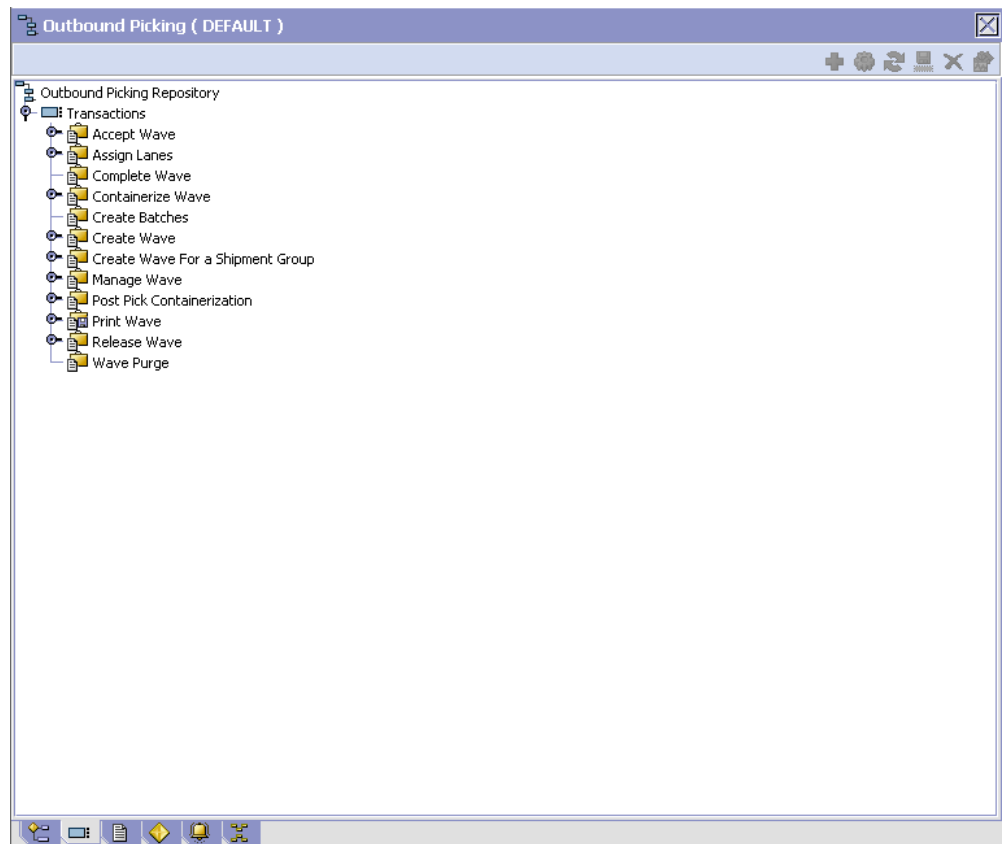

Table 7–1 Outbound Picking Pipeline - Transactions Tab Window

Field	Description
Accept Wave	This transaction represents that a wave must be accepted before continuing through the pipeline.
Assign Lanes	This transaction represents assigning shipments in a wave to a particular lane. From this lane the shipments are packed and loaded onto the appropriate carrier.
Complete Wave	This transaction represents a wave being completed.
Containerize Wave	This transaction represents shipments in a wave being packed into the appropriate containers at the time the pick is performed.
Create Batches	This transaction represents batch waves being created for batch picking.
Create Wave	This transaction represents a wave being generated by the system.
Create Wave For a Shipment Group	This transaction represents a wave being generated by the system for a particular shipment group.
Manage Wave	The transaction represents a period in which any adjustments can be made to a wave.
Post Pick Containerization	This transaction represents shipments in a wave being packed into the appropriate containers any time after the pick has performed.
Print Wave	This transaction represents a wave being printed by the system.
Release Wave	This transaction represents a wave being released by the system. Pick tasks and replenish tasks are also created during this process, if necessary.
Wave Purge	This transaction represents a wave may now be purged (moved out of) from the tables. For more information about purge criteria, see Section 7.4, "Defining Purge Criteria" on page 611

Note: To print UCC-128 Container Labels in instances where system-defined packing is followed, enable the ON_SUCCESS event of the POST_PICK_CNTR (Post Pick Containerization) transaction.

7.1.4 Statuses

Statuses are the actual states that a document moves through in the pipeline. A transaction can contain two types of statuses, a drop status and a pickup status. A document is moved into a **drop status** when the events and conditions of a transaction have been completed. A **pickup status** takes the document from the previous drop status and moves it through the next transaction. Created and Scheduled are examples of statuses.

For more information about Statuses, see the *Selling and Fulfillment Foundation: Application Platform Configuration Guide*.

To view the status details of an outbound picking pipeline:

1. From the tree in the application rules side panel, choose Picking > Pick Process Model. The Outbound Picking window displays.
2. In the Outbound Picking window, choose .
3. The Statuses tab window displays.

For more information about creating and modifying Statuses, see the *Selling and Fulfillment Foundation: Application Platform Configuration Guide*.

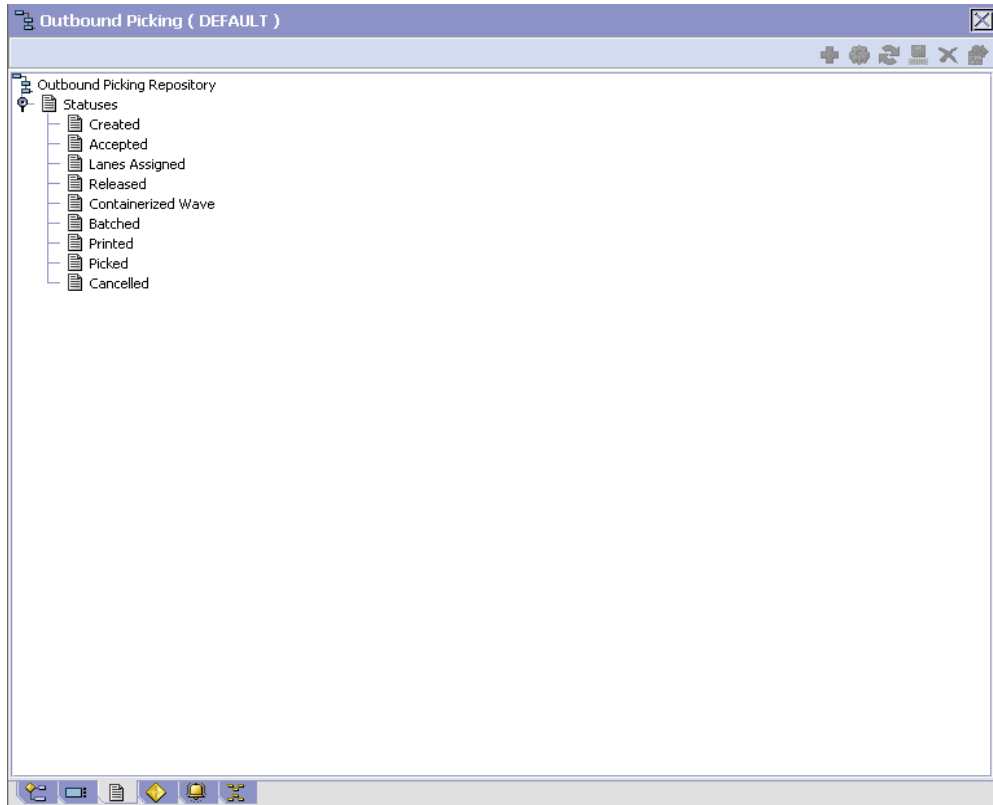

Table 7–2 Outbound Picking Pipeline - Statuses Tab Window

Field	Description
Created	This indicates that the wave has been created. This corresponds to 'Create Wave' and 'Create Wave For a Shipment Group' transactions.
Accepted	This indicates that the wave has been accepted. This corresponds to 'Accept Wave' transaction.
Lanes Assigned	This indicates that shipments in the wave have been assigned to the proper lanes to be loaded to a carrier. This corresponds to the 'Assign Lane' transaction.

Table 7–2 Outbound Picking Pipeline - Statuses Tab Window

Field	Description
Released	This indicates that the appropriate locations have been assigned for picking inventory for shipments in a wave. This corresponds to the 'Release Wave' transaction.
Containerized Wave	This indicates that shipments in a wave have been packed in their appropriate containers. This corresponds to the 'Containerize Wave' transaction.
Batched	This indicates that the wave has been batched for picking. This corresponds to the 'Create Batches' transaction.
Printed	This indicates that the wave has been printed for picking. This corresponds to the 'Print Wave' transaction.
Picked	This indicates that inventory has been picked for shipments in a wave.
Cancelled	This indicates that a wave have been cancelled.

7.1.5 Conditions

A **condition** matches document type attributes against decision points and routes the documents to different paths based on the specified attribute and value combinations. The document type attributes against which conditions can be created are predefined in Selling and Fulfillment Foundation. You can use these attributes in any combination or you can create conditions that run the appropriate application logic for specific circumstances.

For more information about Conditions, see the *Selling and Fulfillment Foundation: Application Platform Configuration Guide*.

To view the condition details of an outbound picking pipeline:

1. From the tree in the application rules side panel, choose Picking > Pick Process Model. The Outbound Picking window displays.
2. In the Outbound Picking window, choose .
3. The Conditions tab window displays.

For more information about creating and modifying Conditions, see the *Selling and Fulfillment Foundation: Application Platform Configuration Guide*.

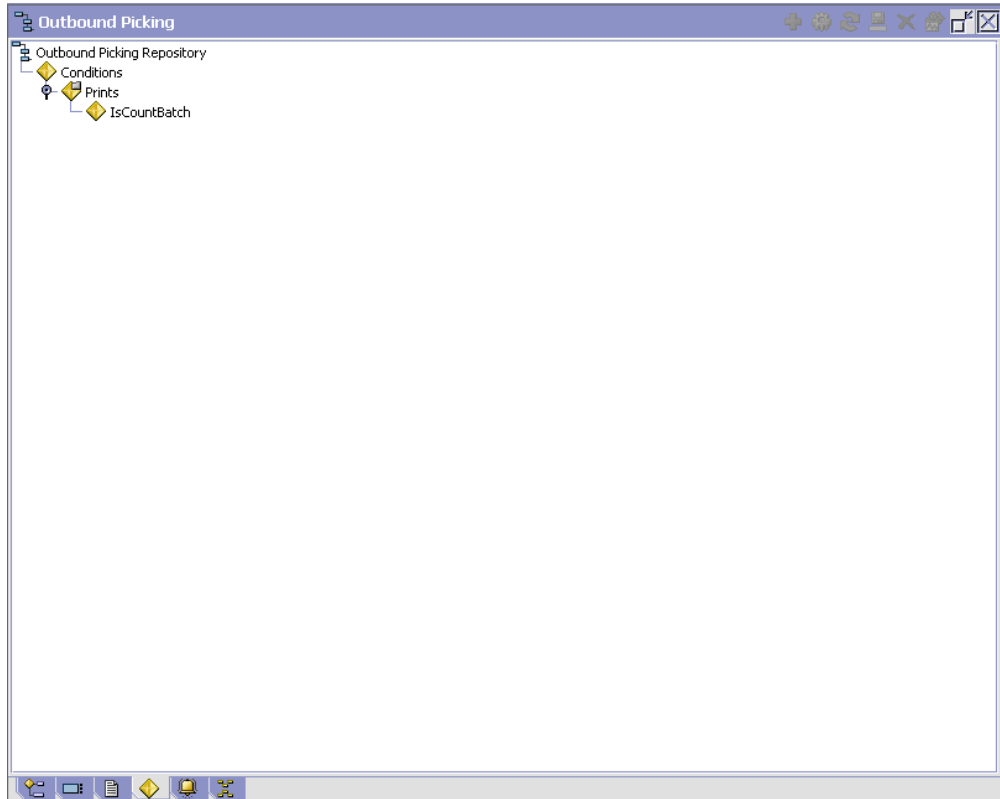

Table 7–3 *Outbound Picking Pipeline - Conditions Tab Window*

Field	Description
Prints	
IsCountBatch	Condition that evaluates if the activity group for the batch is COUNT.

7.1.6 Actions

An **action** is a process or program that is triggered by an event. These processes and programs send user alert notifications and automatically resolve issues.

For example, when an order is released (the event), you can set an action to send the customer an e-mail.

For more information about Actions, see the *Selling and Fulfillment Foundation: Application Platform Configuration Guide*.

To view the action details of an outbound picking pipeline:

1. From the tree in the application rules side panel, choose Picking > Pick Process Model. The Outbound Picking window displays.
2. In the Outbound Picking window, choose .
3. The Actions tab window displays.

For more information about creating and modifying Actions, see the *Selling and Fulfillment Foundation: Application Platform Configuration Guide*.

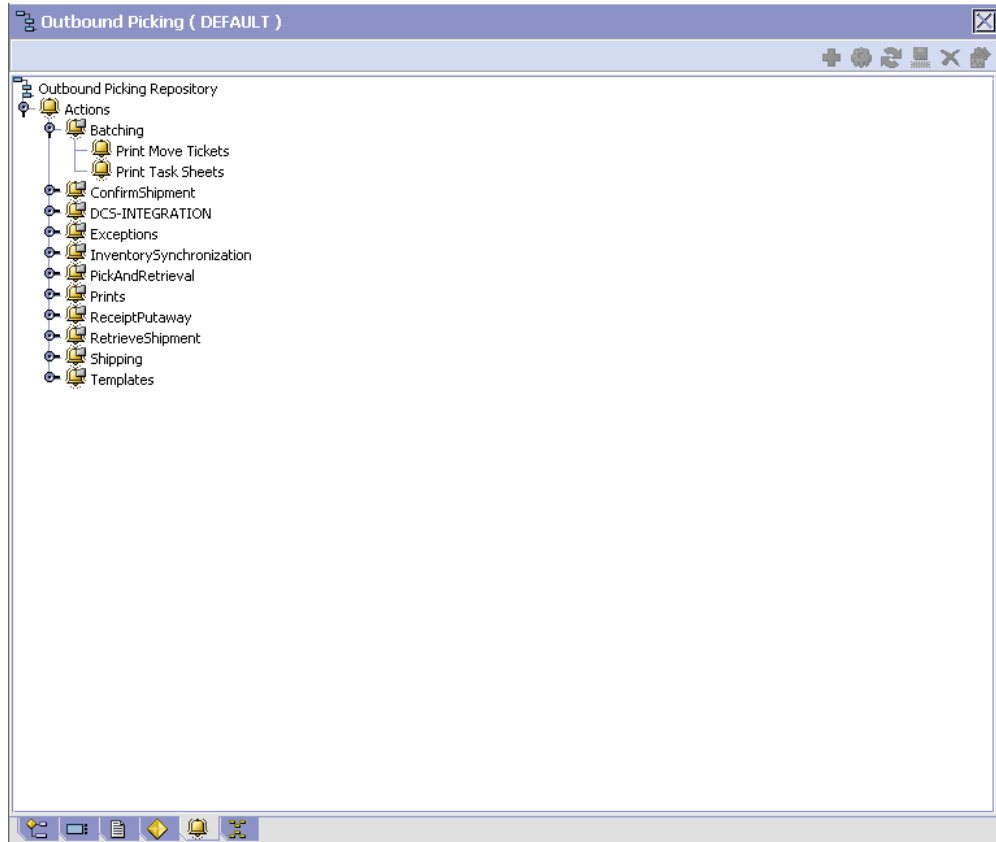

Table 7–4 Outbound Picking Pipeline - Actions Tab Window

Field	Description
Batching	<p>Default settings are provided for:</p> <p>Print Move Tickets – Invokes the batch printing service for printing the move tickets.</p> <p>Print Task Sheets – Invokes the batch print service for printing the task sheets.</p>
ConfirmShipment	<p>Default settings are provided for:</p> <p>ConfirmShipment – Invokes the confirmShipment flow to confirm the shipment.</p>

Table 7–4 Outbound Picking Pipeline - Actions Tab Window

Field	Description
DCS-Integration	Default settings are provided for: InventoryDownload – Invokes the YantraWMSInventoryDownloadService service to download the inventory information from Selling and Fulfillment Foundation to DCS. PODownload – Invokes the YantraWMSPODownloadService service to download the Purchase Order information from Selling and Fulfillment Foundation to DCS.
Exceptions	Default settings are provided for: ShortagesDetected – Invokes the LogWavePlaFailure exception service when shortage of inventory occurs during wave release.
InventorySynchronization	Default settings are provided for: CollectInventoryMismatch – This service collects the inventory mismatch information between an external system and Selling and Fulfillment Foundation. This is typically caused when some inventory updates at a node or a warehouse are not reported to Selling and Fulfillment Foundation.
PickAndRetrieval	Default settings are provided for: ConfirmEmptyLocationAfterPick – Invokes the GenerateCountRequest flow which creates a count request.

Table 7–4 Outbound Picking Pipeline - Actions Tab Window

Field	Description
Prints	<p>Default settings are provided for:</p> <p>PickList Print – Invokes the print service for printing the Pick List.</p> <p>LTL Manifest – Invokes the print service for printing the Less-than Truck Load Manifest.</p> <p>Print Load BOL – Invokes the print service for printing the Load Bill of Lading.</p> <p>Print PackList – Invokes the print service for printing the Pack List.</p> <p>Print Post Pick Container Labels – Invokes the print service for printing UCC-128 container labels for containers, when system defined packing process is used.</p> <p>Print Shipment BOL – Invokes the print service for printing the Shipment Bill of Lading.</p> <p>Print Shipping Label – Invokes the print service for printing the UCC-128 container labels.</p> <p>Print Wave – Invokes the Print service for printing a Wave.</p>
ReceiptPutaway	<p>Putaway products on receipt closure – Indicates the default action provided to automatically initiate putaway of purchase order receipts.</p>
RetrieveShipment	<p>Retrieve Requested Serial – This service invokes the retrieveShipment API to retrieve the requested serials to the specified location.</p>

Table 7–4 Outbound Picking Pipeline - Actions Tab Window

Field	Description
Shipping	<p>Default settings are provided for:</p> <p>Load Left Origin – Invokes the doLoadLeftOriginUpdates service to mark that the load has left the origin.</p> <p>Stop Shipping – Invokes the RaiseStopShippingAlert service to raise an alert to stop the processing of the shipment.</p>
Templates	<p>Default settings are provided for:</p> <p>Log Exception – Logs the reasons why a count request could not be created for a Count Program.</p> <p>Publish Data – Sends data to external queue or internal tables.</p> <p>Raise Exception – Raises an alert using Event Management from the published information.</p> <p>Send Email – Raises an email action to create an email in the template format from the published information.</p> <p>Send Email-HTML format – Raises an email action to create an email in HTML format from the published information.</p>

7.1.7 Service Definitions

Service definitions are a representation of the logic that regulates document workflow services. The Service Builder is a graphical interface that enables you to create a graphical representation of these *services*.

For more information about Service Definitions, see the *Selling and Fulfillment Foundation: Application Platform Configuration Guide*.

To view the service definition details of an outbound picking pipeline:

1. From the tree in the application rules side panel, choose Picking > Pick Process Model. The Outbound Picking window displays.
2. In the Outbound Picking Receipt window, choose .
3. The Service Definitions tab window displays.

For more information about creating and modifying Service Definitions, see the *Selling and Fulfillment Foundation: Application Platform Configuration Guide*.

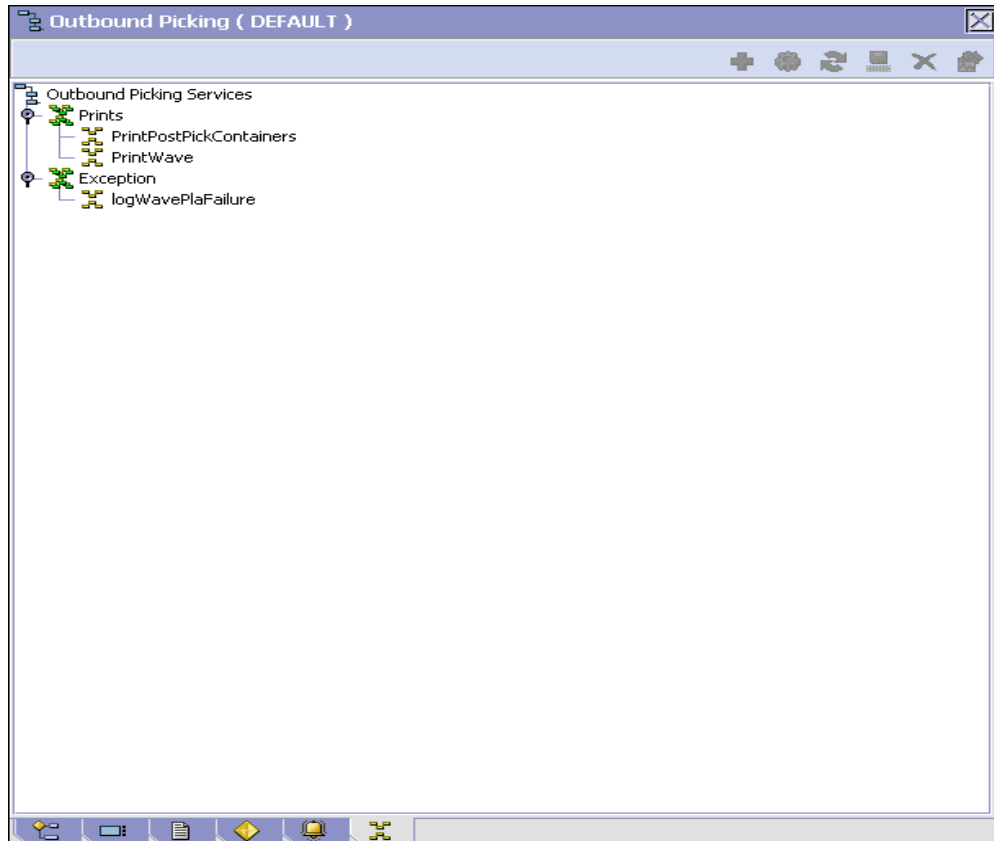

Table 7–5 Outbound Picking Pipeline - Service Definition Tab Window

Field	Description
Prints	
PrintPostPickContainers	The Print service for printing UCC-128 container labels for containers, when system-defined packing process is used.

Table 7–5 Outbound Picking Pipeline - Service Definition Tab Window

Field	Description
PrintWave	The Print service for printing a Wave.
Exceptions	
LogWavePLAFailure	Raises an alert when errors are detected during wave release.

7.2 Defining Pick Planning Parameters

You can define the parameters used when planning your pick strategy. These parameters include shipment group determination, wave size constraints, and the wave release schedule.

You can use the Pick Planning branch for:

- [Defining Shipment Groups](#)
- [Defining Wave Size Constraints](#)
- [Defining a Wave Release Schedule](#)

7.2.1 Defining Shipment Groups

A *shipment group* is made up of shipments with similar attributes grouped together based on defined shipment selector parameters. *Shipment selectors* consist of shipment and item attributes used to distinguish and group shipments. For example, an emergency shipment group has shipments with Priority Code as 'E' or shipments expected to be shipped four hours from now.

To define a shipment group:

1. From the tree in the application rules side panel, choose Picking > Pick Planning. The Pick Planning window displays in the work area.
2. Choose the Grouping And Prioritization tab. The Shipment Groups tree displays.

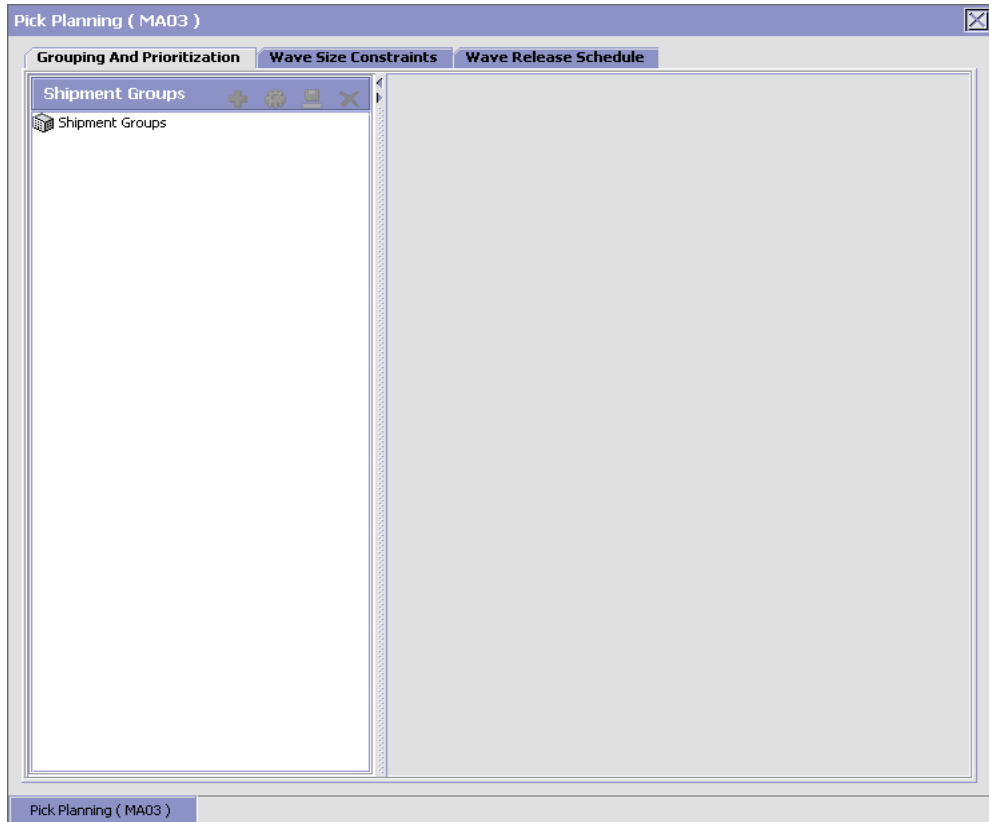

3. From the Shipment Groups tree, choose . The Shipment Group Details window displays in the right frame of the tab.



Shipment Group Details 

Shipment Group ID Sequence #

Description

Primary Info **Pick Strategy** **Sort For Shipping** **Advanced**

Priority ▼

Effective From Date  Effective To Date 

4. In Shipment Group ID, enter the shipment group number or id.
5. In Sequence #, enter a sequence number that is unique within the ship node. Shipments are evaluated for applicable shipment selectors. Shipment groups use selectors to evaluate shipments. The sequence number determines the order by which shipment groups evaluate the shipments. Once a shipment matches up with a shipment group's selector criteria, it is added to that group.

Note: Shipment groups display in the shipment group tree in descending order based on their sequence number. Lower sequence numbers take priority over higher sequence numbers, while evaluating shipment selectors.

6. In Description, enter a brief description of the shipment group.
7. In the Shipment Group Details window, choose the Primary Info tab.
8. From Priority, select the shipment group's priority. This priority is given to the wave and then assigned to the pick tasks for shipments belonging to this group.
9. In Effective From Date, enter the date from which the parameters defined for the shipment group are applicable.
10. In Effective To Date, enter the date to which the parameters defined for the shipment group are applicable.
11. On the Advanced Tab, select a pipeline.
12. Choose .

You can use the Shipment Group Details window for:

- [Defining a Shipment Group's Pick Strategy](#)
- [Defining a Shipment Group's Sort Strategy](#)
- [Defining a Shipment Group's Advanced Parameters](#)

You can use the Primary Info tab for:

- [Defining Shipment Selectors](#)
- [Defining Wave Size Constraints](#)
- [Algorithms Used to Determine Pick Locations](#)

7.2.1.1 Defining Shipment Selectors

Shipment selectors consist of shipment and item attributes used to distinguish and group shipments, which are processed using Item Pick, Order Pick, or Batch Pick.



To add shipments to a shipment group, any one of the following shipment selector criteria must match:

- Shipment attributes including customer, value, order type, pack and hold, VAS requirements, and priority
- Delivery attributes including mode and type of shipment, SCAC, and service
- Customer attributes including country and postal code
- Turnaround time attributes including request ship date and cancel dates
- Item classifications (for example, a heavy item in Electronics or a hazardous item in Chemicals)

A shipment selector is a combination of all defined attributes. For example, 'Priority Orders' shipment selector includes attributes such as order type, priority code, and requested ship date.

Note: Item pick does not process shipments that have 'Requested Serial Number'.

To define shipment selectors:

1. In the Primary Info tab of the Shipment Group Details window, choose  from the Shipment Selectors table. The Shipment Selector Details pop-up window displays.
2. Enter information in the applicable fields. Refer to [Table 7-6](#) for field value descriptions.
3. Choose .

Shipment Selector Details 

Shipment Group ID



Description

Shipment Attributes

Document Type

Enterprise Code Priority Code

Order Type Shipment Value exceeds

Buyer Organization  Receiving Node 

Ship Via

Delivery Method Any Ship Pickup Deliver

Shipment Mode

Carrier

Carrier Service Code is in 

Ship To

Country 

Postal Code Ranges From To

Additional Criteria

Condition Name

Delinquent Shipments

Ship Date Past Due

Delivery Date or Cancel Date is past due

Delivery Date or Cancel Date is within following hours

At Risk / Regular Shipments

Ship Date is within following hours

Delivery Date or Cancel Date is within following hours

Include Only Planned Shipments

Shipment Types

Single Line Shipments

Single Item Shipments

Pack and Hold

Pick Date Past Due

Pick Date is within following hours

Shipments with Value Added Services

Shipment Line Attributes

Table 7–6 Shipment Selector Details Pop-Up Window



Field	Description
Shipment Group ID	The shipment group ID.
Description	Enter a brief description of the shipment criteria.
Shipment Attributes	
Document Type	Enter the document type associated with the shipment group.
Enterprise Code	Select the Enterprise associated with the shipment group.
Priority Code	Enter the priority code associated with the shipment group.
Order Type	Enter the order type associated with the shipment group.
Shipment Value exceeds	Enter the amount and select the currency that you want shipments in the group to be greater than or equal to. For example, if you enter \$100 dollars, only shipments that have a value greater than or equal to \$100 are considered for this shipment group.
Buyer Organization	<p>You can specify the Buyer organization on the shipments you want to add to the group.</p> <p>Choose . The List of Values pop-up window displays. Select the blank line and choose a Buyer from the drop-down list menu. When you have finished adding Buyers, choose OK.</p>
Receiving Node	<p>You can specify the receiving node on the shipments you want to add to the group.</p> <p>Choose . The List of Values pop-up window displays. Select the blank line and choose a node from the drop-down list menu. When you have finished adding receiving nodes, choose OK.</p>
Ship Via	

Table 7–6 Shipment Selector Details Pop-Up Window

Field	Description
Delivery Method	<p>Choose Any if shipments in this group does not have any criteria for the mode of shipment and can choose ship, pickup, or deliver.</p> <p>Choose Ship if shipments in this group are shipped using a carrier.</p> <p>Choose Pickup if shipments in this group are picked up by customers at store locations.</p> <p>Choose Deliver if shipments in this group are delivered by a delivery service provider.</p>
Shipment Mode	Select the method used to ship shipments in this group. For example, select TL if shipments in this group belong to a Truckload.
Carrier	Select the carrier used to ship shipments in this group.
Carrier Service Code is in	<p>You can specify the carrier service used to ship shipments in this group.</p> <p>Choose . The List of Values pop-up window displays. Select the blank line and choose a carrier service from the drop-down list menu. When you have finished adding carrier services, choose OK.</p>
Ship To	
Country	Select the country that shipments in this group are shipped to.
Postal Code Ranges	Enter the postal code range for the regions that shipments in this group are shipped to.
Delinquent Shipments	
Ship Date Past Due	Select this field if you want to group shipments that are past due in this shipment group.
Delivery Date or Cancel Date is past due	If you selected Ship Date Past Due, select this field if you want to group shipments that are past due based on the original delivery date of the shipment or the shipment's cancel date.

Table 7-6 Shipment Selector Details Pop-Up Window

Field	Description
Delivery Date or Cancel Date is within following hours	If you selected Ship Date Past Due and want to specify the exact amount of hours after the delivery date or cancel date in which you want to group past due shipments, select this field and enter the number of hours.
Additional Criteria	
Condition Name	Select the appropriate additional custom condition associated with the shipment group.
At Risk/Regular Shipments	
Ship Date is within following hours	If you want to group shipments that are within specified number of hours before their ship date, select this field and enter the number of hours.
Delivery Date or Cancel Date is within following hours	If you want to group shipments that are within a specified number of hours before their delivery date or cancel date, select this field and enter the number of hours.
Include Only Planned Shipments	Check this box if you want to group only the planned shipments.
Shipment Types	
Single Line Shipments	Check this box if you want to group shipments with a single line.
Single Item Shipments	Check this box if you want to group shipments with a single item.
Pack and Hold	Check this box if you want to group shipments that are packed and kept on hold.
Pick Date Past Due	Check this box if you want to pick shipments for which the ship date is past due. This field is enabled only if you check the Pack and Hold box.
Pick Date is within following hours	If you want to group shipments that are within the specified number of hours before the pick date, select this field and enter the number of hours. This is enabled only when the Pack and Hold field is checked.

Table 7–6 Shipment Selector Details Pop-Up Window



Field	Description
Shipments with Value Added Services	Select this field if you want to group shipments that have value added services performed on them.
Shipment Line Attributes	
Classification Type this title varies depending upon the classifications that are displayed as per your business practices	A field used in Classifications is mapped to the Enterprise that you select for the shipment selector. For more information about configuring classifications, see the <i>Catalog Management: Configuration Guide</i> . Enter the valid value for the classifications.

7.2.1.2 Defining Wave Size Constraints

You can define a wave size constraints for waves created for a shipment group. These constraints limit the size of a wave. A *wave* is an aggregation of picks across zones and orders that are consolidated to optimize pick and prioritize shipment.

Important: In addition to wave size constraints defined for a node, the wave size constraints defined for a shipment group are also used. For more information about defining node level wave size constraints, see [Section 7.2.2, "Defining Wave Size Constraints"](#).

To define a shipment group's wave constraints:

1. In the Primary Info tab of the Shipment Group Details window, choose  from the Wave Size Constraints table. The Size Constraint Details pop-up window displays.
2. Enter information in the applicable fields. Refer to [Table 7–7](#) for field value descriptions.
3. Choose .

Size Constraint Details

Description

When shipment matches all the following conditions

Enterprise Code

Shipment Mode

Carrier

Shipment has more than one shipment line

Shipment has more than one case

And for shipments that have any lines having the following attributes

Then ensure that wave size does not exceed any of the following constraints

Loads # Shipments

Cases Volume CIN

Effort Estimate for resource pool

Shipment lines

Do not mix shipment profiles in wave, if the number of shipments in a profile exceeds

Table 7–7 Size Constraint Details Pop-Up Window

Field	Description
Description	Enter a brief description of the size constraint parameters.
When shipment matches all the following conditions	When shipments meet all of the conditions specified in the following fields, then the constraints indicated in the option you select below are applied.
Enterprise Code	Select the Enterprise that you want apply constraints to.

Table 7–7 Size Constraint Details Pop-Up Window

Field	Description
Shipment Mode	Select the shipment mode that you want to apply constraints to. For example, if parcel carriers cannot ship a certain amount of cases in a shipment, you can select Parcel and enter the case constraint below.
Carrier	Select the carrier that you want to apply constraints to. For example, if there is a specific carrier that does not ship more than a specified volume, you can select the carrier and enter the volume constraint below.
Shipment has more than one shipment line	Select this field if you want to apply the constraints only against shipments that have more than one line.
Shipment has more than one case	Select this field if you want to apply the constraints only against shipments with more than one case.
And for shipments that have any lines having the following attributes	Select this field if you want to use classifications to determine the wave constraint criteria. A field used in Classifications is mapped to the Enterprise that you select for the shipment selector. For more information about configuring classifications, see the <i>Catalog Management: Configuration Guide</i> . Enter the valid value for the classifications that display according to your business practices.
Then ensure that wave size does not exceed any of the following constraints	
# Loads	Enter the number of loads to limit in a wave if the above criteria is met. Note: This field does not display if the 'And for shipments that have any lines having the following attributes' option is selected.
# Shipments	Enter the number of shipments to limit in a wave if the above criteria is met. Note: This field does not display if the 'And for shipments that have any lines having the following attributes' option is selected.
# Cases	Enter the number of cases to limit in a wave if the above criteria is met. Note: This field does not display if the 'And for shipments that have any lines having the following attributes' option is selected.

Table 7–7 Size Constraint Details Pop-Up Window

Field	Description
Volume	Enter the volume and select the applicable unit of measure to limit a wave to if the above criteria is met. Note: This field does not display if the 'And for shipments that have any lines having the following attributes' option is selected.
Effort Estimate <estimate effort value> for resource pool	Enter the value of the estimated effort by selecting the UOM from the drop-down list. Select the particular resource pool from the drop-down list for which the effort is estimated.
# Shipment lines	Enter the number of shipment lines to limit in a wave if the above criteria is met. Note: This field does not display if the 'And for shipments that have any lines having the following attributes' option is selected.
Do not mix shipment profiles in wave if the number of shipments in a profile exceeds	Select this field and enter an applicable value (threshold value) to create a wave exclusively for a profile without any profile mixing, when the number of shipments for that profile exceeds the threshold value.

Important: To define a wave size constraint, select "# Shipments" option or "# Shipment lines" option. If you select both the options the system displays "Only one wave size constraint allowed out of # Shipments Or # Shipment Lines" error message.

7.2.1.3 Defining a Shipment Group's Pick Strategy

You can define a shipment group's pick strategy. A *pick strategy* is applied to each wave to determine the best method to pick inventory. A pick strategy consists of defined pick processes and pick location assignments.

The pick processes you can define are:

- **Item Picking**—a variation of batch picking where rather than picking a single order, all items from the zone are picked across shipments and later sorted and consolidated into individual orders or shipments.

- **Order Picking**— an order or shipment picker picks one order or shipment at a time in the assigned zones.
- **Batch Picking**— a picking where multiple orders or shipments are grouped into batches. In Batch Picking, constraints are defined at batch level for the zones, locations, and number of units.

To define a shipment group's pick strategy:

1. In the Shipment Group Details window, choose the Pick Strategy tab.

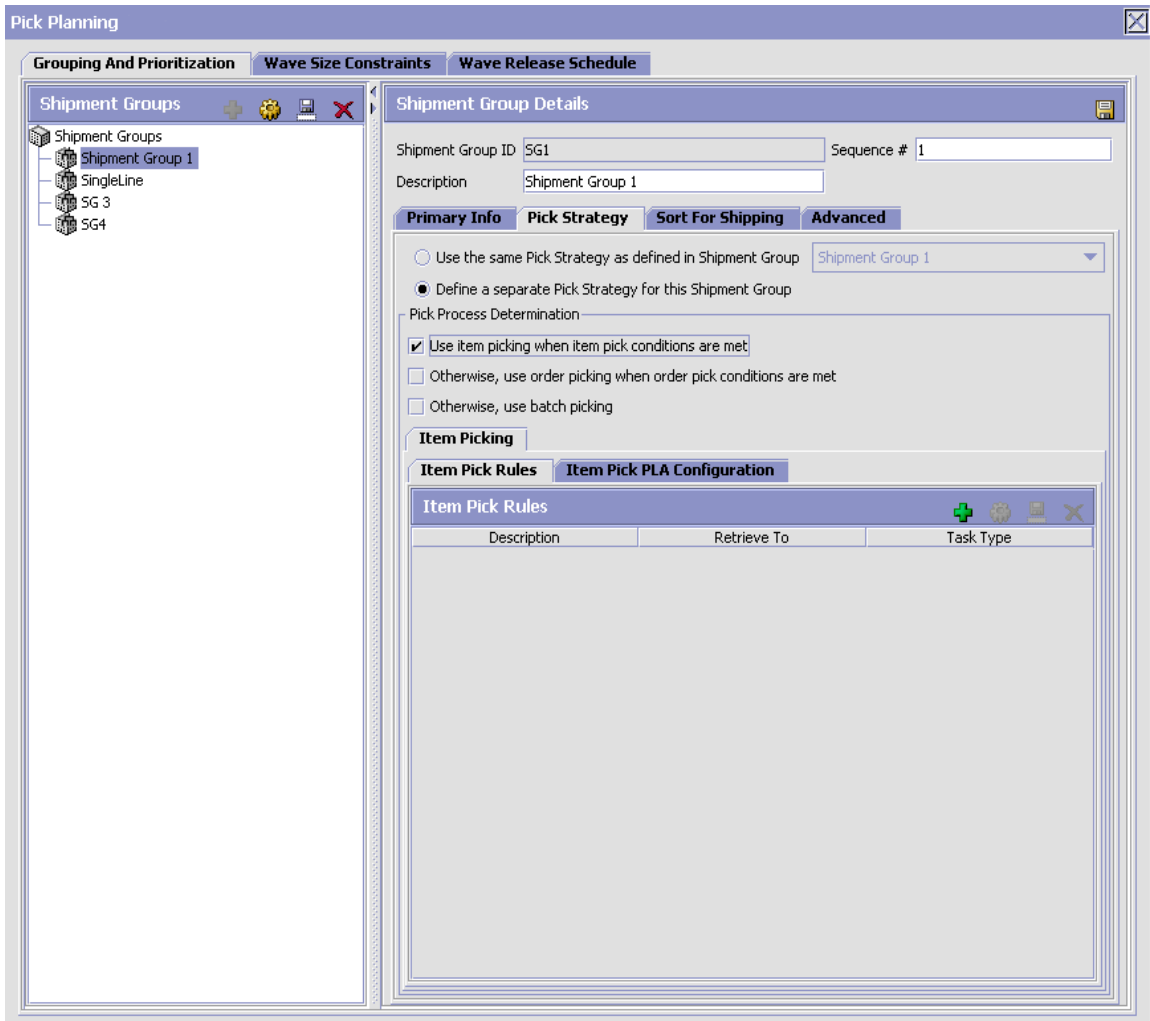

2. Choose 'Use the same Pick Strategy as defined in Shipment Group' and select the applicable shipment group if you want to use a pick strategy already defined for an existing shipment group.
3. Choose 'Define a separate Pick Strategy for this Shipment Group' if you want to define a new pick strategy for this shipment group. The

Pick Process Determination and Item Pick PLA Configuration tabs appear.

4. Choose .

7.2.1.4 Algorithms Used to Determine Pick Locations

The Sterling Warehouse Management System supports the following algorithms, which you can use to determine pick locations for Least Number of Trips and Pick-To-Clean optimizations:

- Default Algorithm—uses a simple approach to provide quick results.
- Constraint Solver Algorithm—takes more time, but arrives at a better solution.

For more information about using the appropriate algorithm to determine pick location, see [Section A.2.18, "Release Wave"](#).

Examples for 'Pick-To-Clean' Optimization

If the demand is for 150 units and if you configure "Do not break pallets" split constraint, the inventory picture is shown in [Table 7–8](#).

Table 7–8 Inventory Picture

Location	Pallet Identifier	LPN Quantity
L1	P1	5
L1	P2	10
L2	P3	15
L2	P4	20
L3	P5	40
L3	P6	40
L4	P7	80
L4	P8	80
L5	P9	80
L5	P10	140

- If you use the Default algorithm, the system allocates the following pallets, thus satisfying 130 units of demand:

- P1 (5)
- P2 (10)
- P3 (15)
- P4 (20)
- P5 (40)
- P6 (40)
- If you use the Constraint Solver algorithm, the system allocates the following pallets, thus satisfying 150 units of demand:
 - P1 (5)
 - P2 (10)
 - P3 (15)
 - P5 (40)
 - P7 (80)

Examples for 'Least Number of Trips' Optimization

If the demand is for 120 units and if you configure "Do not break pallets" split constraint, the inventory picture is shown in [Table 7–9](#).

Table 7–9 Inventory Picture

Location	Pallet Identifier	LPN Quantity
L1	P1	60
L1	P2	60
L2	P3	60
L2	P4	80



- If you use the Default algorithm, the system allocates pallet P4 (80), thus satisfying 80 units of demand.

Note: Since split constraints are configured and other pallets cannot be split, the system first chooses pallet P4. The system also cannot allocate full pallets as it exceeds the demand.

- If you use the Constraint Solver algorithm, the system allocates pallets P1 (60) and P2 (60), thus satisfying 120 units of demand.

7.2.1.4.1 Specifying Item Pick Rules

To determine item pick rules:

1. From the Pick Strategy tab in the Shipment Group Details window, in the Pick Process Determination panel, choose Use Item picking when item pick conditions are met.
2. From the Item Pick Rules tab, choose . The Item Picking Rule pop-up window displays.
3. Enter information in the applicable fields. Refer to [Table 7–10](#) for field value descriptions.
4. Choose .

Note: Shipments containing shipment lines with 'Requested Serial Number' are not processed.

Item Picking Rule

Description

Enterprise Code

When all of the following conditions are met

Unit of Measure

Shipment has exactly one line with just one unit

Use item picking Regardless of demand variations
 Based on demand variations as defined below

If total quantity for an item in the wave exceeds

If # of single unit shipments for an item in the wave exceeds

If # of shipments with same profile id exceeds

Retrieve items to A pack station
 Dynamically slotted locations in following zones

Staging zones

Pick from these zones using task type







Table 7–10 *Item Picking Rule Pop-Up Window*

Field	Description
Description	Enter a brief description of the item picking condition.
Enterprise Code	Select the Enterprise you want to associate with the item picking condition.

Table 7–10 Item Picking Rule Pop-Up Window

Field	Description
When all of the following conditions are met	<p>When a shipment meets all of the conditions specified in the following fields, then the item picking parameters specified in the option you select below are applied.</p> <p>If these classifications are met along with the other conditions, item picking is performed.</p> <p>Note: The item classification names vary depending on the Enterprise and the classifications set for Retrieval type of tasks.</p> <p>'Item Classifications' can be entered in the pop up window only when an enterprise is selected and its 'Inventory Org' has classifications defined.</p>
Unit of Measure	Select the unit of measure you want to consider when using these item picking parameters for a shipment.
Shipment	<p>Select 'has exactly one line' if you want to consider the item picking parameters for shipments with only one line.</p> <p>Select 'with just one unit' if you want to consider the item picking parameters for shipments with only one item.</p>
Use item picking	<p>Choose 'Regardless of demand variations' if you want item picking to be performed regardless of any constraints when the above conditions are met.</p> <p>Choose 'Based on demand variations as defined below' if you want item picking to be performed based on the parameters you define below.</p>
If total quantity for an item in the wave exceeds	Select this field and enter the applicable quantity if you want to exclude cases or pallets from item picking if the quantity for that item exceeds the specified quantity. To exclude cases and/or pallets, you must select one or both of the following options if you select this field
If # of single unit shipments for an item in the wave exceeds	Select this field and enter the applicable quantity if you do not want to consider items that have the unit of measure of CASE and a quantity of 1 when the number of single unit shipments for the item exceeds the number you specify.

Table 7–10 Item Picking Rule Pop-Up Window

Field	Description				
If # of shipments with same profile id exceeds	Select this field and enter the applicable number (threshold value) if you want to perform an item pick operation, when the same profile identifier shipments in that wave exceeds the threshold value.				
Retrieve items to	<p>Choose "A pack station" if you want to retrieve items to a pack station.</p> <p>Choose "Dynamically slotted locations in following zones" if you want to retrieve items to a staging location.</p> <table border="1" data-bbox="622 621 1268 1338"> <tr> <td data-bbox="622 621 853 1095">Staging Zones</td> <td data-bbox="861 621 1268 1095"> <p>Click . The Item Pick Staging Zones window displays. Select a zone and click OK.</p> <p>Click  to create a zone. For more information about creating a zone, see Section 3.5.1, "Creating a Zone" on page 47.</p> <p>Note: The locations in the staging zone should be of "Regular" location type to ensure that the dynamic slotting of locations is accurately accomplished.</p> </td> </tr> <tr> <td data-bbox="622 1104 853 1338">Pick from these zones using task type</td> <td data-bbox="861 1104 1268 1338">Select the order pick task type for the tasks you want to perform to move items from the staging location. For more information about the task type wizard, see Section 12.3, "Defining Task Types" on page 885.</td> </tr> </table>	Staging Zones	<p>Click . The Item Pick Staging Zones window displays. Select a zone and click OK.</p> <p>Click  to create a zone. For more information about creating a zone, see Section 3.5.1, "Creating a Zone" on page 47.</p> <p>Note: The locations in the staging zone should be of "Regular" location type to ensure that the dynamic slotting of locations is accurately accomplished.</p>	Pick from these zones using task type	Select the order pick task type for the tasks you want to perform to move items from the staging location. For more information about the task type wizard, see Section 12.3, "Defining Task Types" on page 885.
Staging Zones	<p>Click . The Item Pick Staging Zones window displays. Select a zone and click OK.</p> <p>Click  to create a zone. For more information about creating a zone, see Section 3.5.1, "Creating a Zone" on page 47.</p> <p>Note: The locations in the staging zone should be of "Regular" location type to ensure that the dynamic slotting of locations is accurately accomplished.</p>				
Pick from these zones using task type	Select the order pick task type for the tasks you want to perform to move items from the staging location. For more information about the task type wizard, see Section 12.3, "Defining Task Types" on page 885.				

7.2.1.4.2 Specifying Item Pick Location Configuration

Pick Location Assignment (PLA) assigns the warehouse locations to the demand placed. You can define the list of zones to use for picking by

specifying for a combination of item level attributes, such as classifications and unit of measure. Multiple PLA rules may be specified to ensure that the zone level constraints are unique to the item classification and unit of measure combination. For example, for SKUs stocked in pallets, cases and loose units, it is advisable to have 3 distinct rules to cover zones that are applicable for each unit of measure. The locations to be used in the zone can be filtered further by considering the least travel or pick-to-clean constraints.

You can use the Item Pick PLA Configuration tab for:

- [Configuring Pick Location Rules for All Items](#)
- [Configuring Pick Location Rules for Specific Items](#)

Configuring Pick Location Rules for All Items

You can define global PLA rules for all items in a warehouse based on unit of measure.

To assign pick location rules for all items:



1. From the Item Picking tab in the Shipment Group Details window, choose the Item Pick PLA Configuration tab.
2. From the Pick Location tree, select All Items.
3. Choose . The UOM Condition pop-up window displays.
4. Enter information in the applicable fields. Refer to [Table 7–16](#) for field value descriptions.
5. Choose .

Table 7–11 UOM Condition Pop-Up Window





Field	Description
Description	Enter a brief description of the unit of measure condition.
When Unit of Measure is in	<p>You must specify the units of measure for which this condition is based. The system uses the pick location parameters that you specify to generate pick plans for items of the units of measure you select.</p> <p>Choose . The List of Values pop-up window displays. Select the blank line and choose a unit of measure from the drop-down list menu. When you have finished adding units of measure, choose OK.</p>
Then, first search for pick locations as per PLA rule	<p>You must specify the pick location parameters to be used initially according to the pick location assignment rule.</p> <p>Choose . The Pick Location Assignment pop-up window displays. See Pick Location Assignment Rule (Item Pick) Pop-Up Window for field level descriptions.</p> <p>When you have finished defining pick location parameters, choose OK.</p>

Table 7–11 UOM Condition Pop-Up Window

Field	Description
<p>When inventory is not found, search as per PLA rule</p>	<p>You can define pick location parameters to be used if inventory is not found using the initial parameters according to the pick location assignment rule.</p> <p>Choose . The Pick Location Assignment pop-up window displays. See Pick Location Assignment Rule (Item Pick) Pop-Up Window for field value descriptions.</p> <p>When you have finished defining pick location parameters, choose OK.</p>
<p>When inventory is still not found, search as per PLA rule</p>	<p>You can define pick location parameters to be used if inventory is not found using the second set of parameters according to the pick location assignment rule.</p> <p>Choose . The Pick Location Assignment pop-up window displays. See Pick Location Assignment Rule (Item Pick) Pop-Up Window for field value descriptions.</p> <p>When you have finished defining pick location parameters, choose OK.</p>

Pick Location Assignment Rule (Item Pick) Pop-Up Window

The Pick Location Assignment pop-up window is used to set the parameters used to determine the location from which items are picked. Refer to [Table 7–12](#) for field value descriptions.

Pick Location Assignment Rule

Description

Location Selection

1. Locations with Inventory Select locations having inventory from the following zones

 and having inventory in one of the following status

Optimize retrieval by Pick to clean Least number of trips Pick Sequence

2. Dedicated Locations For the remaining demand, select dedicated location(s) from the zones listed above.
 Replenish when inventory goes below minimum quantity for dedicated items
 Replenish the locations up to max quantity for dedicated items

3. Cross Dock Locations For the demand left over from the previous steps, explore cross-docking opportunity.
 Search for inbound shipments that are in following status

Split Constraint

Splitting is allowed for Pallets and Cases Pallets but not Cases Neither Pallets nor Cases

Task Creation

Item Picking Task Type 

OK Cancel

Table 7–12 Item Pick Location Assignment Window

Field	Description
Description	Enter a brief description of the pick location assignment parameters.
Location Selection	

Table 7–12 Item Pick Location Assignment Window



Field	Description
Locations with Inventory	<p>When this pick location assignment is used, the system initially tries to find the optimal location to pick inventory based on the parameters you define below.</p> <p>When allocating the inventory for zones that have split constraints defined at either the PLA rule level or the zone level, the Sterling Warehouse Management System does not consider any existing pend in quantities.</p>
Select locations having inventory from the following zones	<p>You must specify the zones that you want to pick from when this pick location assignment is used.</p> <p>Choose . The List of Values pop-up window displays. Select the blank line and choose a zone from the drop-down list menu. When you have finished adding zones, choose OK.</p>
and having inventory in one of the following status	<p>Specify the inventory status that you want to pick from when this pick location assignment is used.</p> <p>Choose . The Inventory Status List pop-up window displays. Select the blank line and choose a zone from the drop-down list menu. When you have finished adding zones, choose OK.</p>
Optimize retrieval by	<ul style="list-style-type: none"> • Choose Pick to Clean to fulfill the demand by emptying as many LPNs or locations as possible for optimal usage of space in a zone. • Choose Least Number of Trips to fulfill the demand from the least number of locations, to enable users to make least number of trips when retrieving inventory. When there is more than one way to make the same least number of trips, the 'PickToClean' process is followed within the 'LeastNumberOfTrips' process. • Choose Pick Sequence to pick from locations in the order of their pick sequence. The system chooses locations having lower pick sequence numbers over locations having higher pick sequence numbers.

Table 7–12 Item Pick Location Assignment Window



Field	Description
Dedicated Locations	If there is still a pick demand after the locations with inventory algorithm is performed, the system searches for locations dedicated for the inventory.
For the remaining demand, select dedicated location(s) from the zones listed above.	<p>Select this checkbox if you want to perform pick using the above parameters for any pick demand that was not fulfilled from dedicated locations in zones that you have specified for locations with inventory. By selecting this field, the system uses replenishment strategy to ensure that the dedicated location always has inventory to pick.</p> <p>The Sterling Warehouse Management System does not replenish the zones that have split constraints, although replenishment strategies are configured.</p>
Replenish when inventory goes below minimum quantity for dedicated items	<p>This field is enabled when the Dedicated Locations are configured.</p> <p>Select this checkbox to replenish the inventory when it goes below the minimum quantity for the dedicated items.</p>
Replenish the locations up to max quantity for dedicated items	<p>This field is enabled when the Dedicated Locations are configured.</p> <p>Select this checkbox to replenish the locations up to the maximum quantity for the dedicated items.</p>
Cross Dock Locations	For any remaining pick demand, you can define the inbound shipment status levels from which items can be cross-docked. Cross-docking allows you to retrieve inventory directly from receiving staging locations and bring the inventory to a dynamically slotted location for picking.
For the demand left over from the previous steps, explore cross-docking opportunity. Search for inbound shipments that are in following status	<p>You can specify the inbound shipment statuses that you want to search for inventory. The system searches for inbound shipments in the specified statuses. Once the shipment is received the system diverts the inventory to the dynamically slotted location.</p> <p>Choose . The Shipment Statuses pop-up window displays. Select the blank line and choose an inbound shipment status from the drop-down list menu. When you have finished adding inbound shipment statuses, choose OK.</p>

Table 7–12 Item Pick Location Assignment Window

Field	Description
Split Constraint	
<p>The system allows the user to break open an LPN for all zones specified in the PLA based on the option specified.</p> <p>If split constraints are defined at the zone and PLA rule levels, the system chooses the most restrictive constraint to ensure that constraints defined are not violated.</p>	
Splitting is allowed for:	
Pallets and Cases	Choose this if you want to allow users to break open both pallets and cases.
Pallets but not Cases	Choose this if you want to allow users to break open only pallets.
Neither Pallets nor Cases	Choose this if you do not want to allow users to break open pallets or cases.
Task Creation	
Item Picking Task Type	<p>Select a type of task to use for item picking from the zones specified for this pick location assignment.</p> <p>Choose . The Task Type Wizard window displays. For more information about the task type wizard, see Section 12.3, "Defining Task Types".</p>

Configuring Pick Location Rules for Specific Items

You can define PLA rules for items in a warehouse based on the item classification and unit of measure.

Note: Only Item Classifications corresponding to the Classification Purpose "retrieval" can be configured here.

To assign pick location for specific items:

1. From the Item Picking tab in the Shipment Group Details window, choose the Item Pick PLA Configuration tab.
2. From the Pick Location tree, select Specific Items.

3. Choose . The Item Condition pop-up window displays.

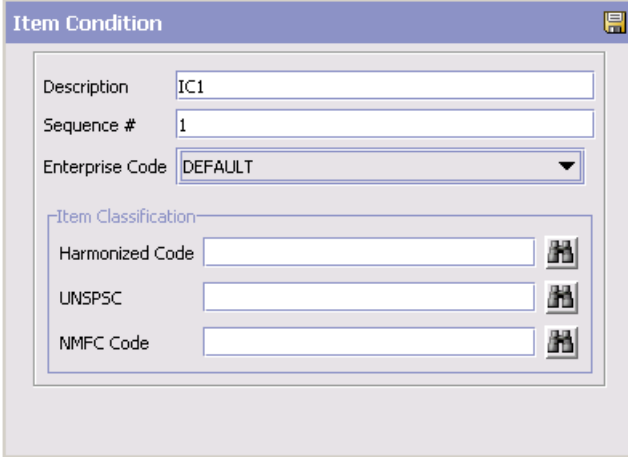

The screenshot shows the 'Item Condition' dialog box. It has a title bar with the text 'Item Condition' and a save icon. The main area contains the following fields:

- Description: IC1
- Sequence #: 1
- Enterprise Code: DEFAULT (dropdown menu)
- Item Classification section:
 - Harmonized Code: [input field] [help icon]
 - UNSPSC: [input field] [help icon]
 - NMFC Code: [input field] [help icon]

4. In Description, enter a brief description of the item condition.
5. In Sequence #, enter the sequence number. Items are evaluated for the criteria you define. The sequence number determines the order by which item conditions evaluate items. Once an item matches up with an item condition's criteria, it uses the applicable pick location assignment algorithms.



Note: When requesting an item for performing PLA, the item conditions are evaluated in a sequence. Once any of the conditions is evaluated as 'true', no more conditions are further evaluated. The evaluated condition is used for performing PLA.

6. From Enterprise Code, select the Enterprise you want to associate with the item condition.
7. In Item Classification, enter the applicable classification parameters according to your business practices. Fields used in Classifications are mapped to the Enterprise that you select for the item condition. For more information about configuring classifications, see the *Catalog Management: Configuration Guide*.

Note: To successfully release a wave, it is mandatory to specify both Item Pick Rules and Item Pick PLA Configuration.

7.2.1.4.3 Specifying Order Pick Rules

To specify order pick parameters:

1. From the Pick Strategy tab in the Shipment Group Details window, in the Pick Process Determination panel, choose Otherwise, use order picking when order pick conditions are met.
2. From the Order Pick Rules tab, choose . The Order Picking Condition pop-up window displays.
3. Enter information in the applicable fields. Refer to [Table 7–13](#) for field value descriptions.
4. Choose .

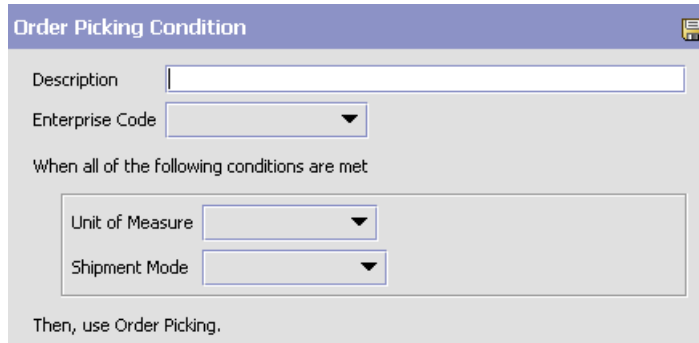

Table 7–13 Order Picking Condition Pop-Up Window

Field	Description
Description	Enter a brief description of the order picking condition.
Enterprise Code	Select the Enterprise you want to associate with the order picking condition.
When all of the following conditions are met	

Table 7–13 Order Picking Condition Pop-Up Window

Field	Description
Unit of Measure	Select an applicable unit of measure. If this unit of measure is met along with the other conditions, you can perform order picking.
Shipment Mode	Select an applicable shipment mode. If this shipment mode is met along with the other conditions, you can perform order picking.

7.2.1.4.4 Specifying Order Pick Location Configuration

Pick Location Assignment (PLA) assigns the warehouse locations to the demand placed. You can define the list of zones to use for picking by specifying for a combination of item level attributes, such as classifications and unit on measure. Multiple PLA rules may be specified to ensure that the zone level constraints are unique to the item classification and unit of measure combination. For example, for SKUs stocked in pallets, cases and loose units, it is advisable to have 3 distinct rules to cover zones that are applicable for each unit of measure. The locations to be used in the zone can be filtered further by considering the least travel or pick-to-clean constraints.

You can use the Order Pick PLA Configuration tab for:

- [Configuring Pick Location Rules for All Items](#)
- [Configuring Pick Location Rules for Specific Items](#)

Configuring Pick Location Rules for All Items

You can define global PLA rules for all items in a warehouse based on unit of measure.

To assign pick location rules for all items:

1. From the Order Picking tab in the Shipment Group Details window, choose the Order Pick PLA Configuration tab.
2. From the Pick Location tree, select All Items.
3. Choose . The UOM Condition pop-up window displays.
4. Enter information in the applicable fields. Refer to [Table 7–14](#) for field value descriptions.

5. Choose .

Table 7–14 UOM Condition Pop-Up Window





Field	Description
Description	Enter a brief description of the unit of measure condition.
When Unit of Measure is in	<p>You must specify the units of measure for which this condition is based. The system uses the pick location parameters that you specify to generate pick plans for items of the units of measure you select.</p> <p>Choose . The List of Values pop-up window displays. Select the blank line and choose a unit of measure from the drop-down list menu. When you have finished adding units of measure, choose OK.</p>
Then, first search for pick locations as per PLA rule	<p>You must specify the pick location parameters to be used initially according to the pick location assignment rule.</p> <p>Choose . The Pick Location Assignment pop-up window displays. See Pick Location Assignment Rule (Order Pick) Pop-Up Window for field value descriptions.</p> <p>When you have finished defining pick location parameters, choose OK.</p>

Table 7–14 UOM Condition Pop-Up Window

Field	Description
<p>When inventory is not found, search as per PLA rule</p>	<p>You can define pick location parameters to be used if inventory is not found using the initial parameters according to the pick location assignment rule.</p> <p>Choose . The Pick Location Assignment pop-up window displays. See Pick Location Assignment Rule (Order Pick) Pop-Up Window for field value descriptions.</p> <p>When you have finished defining pick location parameters, choose OK.</p>
<p>When inventory is still not found, search as per PLA rule</p>	<p>You can define pick location parameters to be used if inventory is not found using the second set of parameters according to the pick location assignment rule.</p> <p>Choose . The Pick Location Assignment pop-up window displays. See Pick Location Assignment Rule (Order Pick) Pop-Up Window for field value descriptions.</p> <p>When you have finished defining pick location parameters, choose OK.</p>

Note: To successfully release a wave, it is mandatory to specify both Order Pick Rules and Order Pick PLA Configuration.

Pick Location Assignment Rule (Order Pick) Pop-Up Window

The Pick Location Assignment pop-up window is used to set the parameters used to determine the location from which items are picked. Refer to [Table 7–15](#) for field value descriptions.

Pick Location Assignment Rule

Description

Location Selection

1. Locations with Inventory Select locations having inventory from the following zones

 and having inventory in one of the following status

 Optimize retrieval by: Pick to clean Least number of trips Pick Sequence

2. Dedicated Locations For the remaining demand, select dedicated location(s) from the zones listed above.
 Replenish when inventory goes below minimum quantity for dedicated items
 Replenish the locations up to max quantity for dedicated items
 For items without dedicated locations dynamically slot a location from the zones listed above.

3. Pick Fence Locations Whenever a dedicated location has demand that exceeds times location capacity
 Dynamically slot a location from the following zones instead

4. Cross Dock Locations For the demand left over from the previous steps, explore cross-docking opportunity.
 Search for inbound shipments that are in following status

 Retrieve to a dynamically slotted location in following zones

Split Constraint
 Splitting is allowed for Pallets and Cases Pallets but not Cases Neither Pallets nor Cases

Task Creation
 Order Picking Task Type

OK Cancel

Table 7–15 Order Pick Location Assignment Window

Field	Description
Description	Enter a brief description of the pick location assignment parameters.
Location Selection	

Table 7–15 Order Pick Location Assignment Window



Field	Description
Locations with Inventory	<p>When this pick location assignment is used, the system initially tries to find the optimal location to pick inventory based on the parameters you define below.</p> <p>When allocating inventory for zones that have split constraints defined at either the PLA rule level or the zone level, the Sterling Warehouse Management System does not consider any existing pend in quantities.</p>
Select locations having inventory from the following zones	<p>You must specify the zones that you want to pick from when this pick location assignment is used.</p> <p>Choose . The List of Values pop-up window displays. Select the blank line and choose a zone from the drop-down list menu. When you have finished adding zones, choose OK.</p>
and having inventory in one of the following status	<p>Specify the inventory status that you want to pick from when this pick location assignment is used.</p> <p>Choose . The Inventory Status List pop-up window displays. Select the blank line and choose a zone from the drop-down list menu. When you have finished adding zones, choose OK.</p>
Optimize retrieval by	<ul style="list-style-type: none"> • Choose Pick to Clean to fulfill the demand by emptying as many LPNs or locations as possible for optimal usage of space in a zone. • Choose Least Number of Trips to fulfill the demand from the least number of locations, to enable users to make least number of trips when retrieving inventory. When there is more than one way to make the same least number of trips, the 'PickToClean' process is followed within the 'LeastNumberOfTrips' process. • Choose Pick Sequence to pick from locations in the order of their pick sequence. The system chooses locations having lower pick sequence numbers over locations having higher pick sequence numbers.

Table 7–15 Order Pick Location Assignment Window

Field	Description
Dedicated Locations	If there is still pick demand after the Locations with Inventory algorithm has been performed, the system looks for locations dedicated specifically for the inventory.
For the remaining demand, select dedicated locations from the zones listed above.	<p>Select this checkbox if you want any pick demand that was not fulfilled using the above parameters to be picked from dedicated locations in the zones you have specified for Locations with Inventory. By selecting this field the system uses replenishment to ensure that the dedicated location remains stocked with pickable inventory.</p> <p>The Sterling Warehouse Management System does not replenish zones that have split constraints, although replenishment strategies are configured.</p>
Replenish when Inventory goes below minimum quantity for dedicated items	<p>This field is enabled when the Dedicated Locations are configured.</p> <p>Select this checkbox to replenish the inventory when it goes below the minimum quantity for the dedicated items.</p>
Replenish the locations up to max quantity for dedicated items	<p>This field is enabled when the Dedicated Locations are configured.</p> <p>Select this checkbox to replenish the locations up to the maximum quantity for the dedicated items.</p>
For items without dedicated locations, dynamically slot a location from the zones listed above.	Select this checkbox if you want items that do not have a dedicated picking location to be dynamically slotted for picking. The location is dynamically slotted in the zones you have specified for Locations with Inventory.
Pick Fence Locations	When demand for inventory at a dedicated location exceeds its normal levels, you can specify the zones in which that inventory can be dynamically slotted for picking.
Whenever a dedicated location has demand that is <i>n</i> times location capacity	<p>Enter the multiple by which demand must exceed a dedicated location's capacity before a location is dynamically slotted for picking.</p> <p>For example, you enter 5. A dedicated location has a capacity of 10 cases. A location is dynamically slotted for picking if there is a demand for 50 cases or more.</p>

Table 7–15 Order Pick Location Assignment Window





Field	Description
Dynamically slot a location from the following zones instead	<p>You can specify the zones in which the system assigns dynamically slotted locations if demand exceeds the specified level.</p> <p>Choose . The List of Values pop-up window displays. Select the blank line and choose a zone from the drop-down list menu. When you have finished adding zones, choose OK.</p>
Cross Dock Locations	<p>For any remaining pick demand, you can define the inbound shipment status levels from which items can be cross-docked. Cross-docking allows you to retrieve inventory directly from receiving staging locations and bring the inventory to a dynamically slotted location for picking.</p>
Search for inbound shipments that are in following status	<p>You can specify the inbound shipment statuses that you want to search for inventory. The system searches for inbound shipments in the specified statuses. Once the shipment is received the system diverts the inventory to the dynamically slotted location.</p> <p>Choose . The Shipment Statuses pop-up window displays. Select the blank line and choose an inbound shipment status from the drop-down list menu. When you have finished adding inbound shipment statuses, choose OK.</p>
Retrieve to a dynamically slotted location in following zones	<p>You can specify the zones in which the system assigns dynamically slotted locations to which inventory is brought from the receiving dock for picking.</p> <p>Choose . The Cross Dock Zones pop-up window displays. Select the blank line and choose a zone from the drop-down list menu. When you have finished adding zones, choose OK.</p>
Split Constraint	
<p>The system allows the user to break open an LPN for all zones specified in the PLA based on the option specified.</p> <p>If split constraints are defined at the zone and PLA rule levels, the system chooses the most restrictive constraint to ensure that constraints defined are not violated.</p>	

Table 7–15 Order Pick Location Assignment Window

Field	Description
Splitting is allowed for:	
Pallets and Cases	Choose this if you want to allow users to break open both pallets and cases.
Pallets but not Cases	Choose this if you want to allow users to break open only pallets.
Neither Pallets nor Cases	Choose this if you do not want to allow users to break open pallets or cases.
Task Creation	
Order Picking Task Type	Select the type of task to use for order picking from the zones specified for this pick location assignment. Choose  . The Task Type Wizard window displays. For more information about the task type wizard, see Section 12.3, "Defining Task Types" .

Important: During order pick, if you want to pick inventory for all configured UOMs into the same container for a shipment, choose a task type that picks inventory directly into the container.

Note: For Dedicated Locations, move request and replenish task are created. For Cross Dock Locations, move request and replenish task are NOT created, instead the Wave Release creates "Activity Demand".

Configuring Pick Location Rules for Specific Items

You can define PLA rules for items in a warehouse based on the item classification and unit of measure.



Note: Only Item Classifications corresponding to the Classification Purpose "retrieval" can be configured here.

To assign pick location rules for specific items:

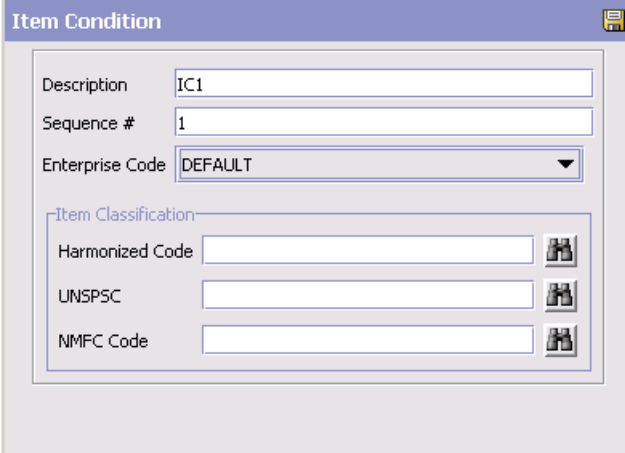
1. From the Order Picking tab in the Shipment Group Details window, choose the Order Pick PLA Configuration tab.
2. From the Pick Location tree, select Specific Items.
3. Choose . The Item Condition pop-up window displays.



The screenshot shows the 'Item Condition' dialog box. It has a title bar with the text 'Item Condition' and a save icon. The dialog contains the following fields:

- Description: IC1
- Sequence #: 1
- Enterprise Code: DEFAULT (dropdown menu)
- Item Classification section:
 - Harmonized Code: [input field] 
 - UNSPSC: [input field] 
 - NMFC Code: [input field] 

4. In Description, enter a brief description of the item condition.
5. In Sequence #, enter the sequence number. Items are evaluated for the criteria you define. The sequence number determines the order by which item conditions evaluate items. Once an item matches up with an item condition's criteria, it uses the applicable pick location assignment algorithms.

Note: When requesting an item for performing PLA, the item conditions are evaluated in a sequence. Once any of the conditions is evaluated as 'true', no more conditions are further evaluated. The evaluated condition is used for performing PLA.

6. From Enterprise Code, select the Enterprise you want to associate with the item condition.
7. In Item Classification, enter the applicable classification parameters according to your business practices. Fields used in Classifications are mapped to the Enterprise that you select for the item condition. For more information about configuring classifications, see the *Catalog Management: Configuration Guide*.

Note: To successfully release a wave, it is mandatory to specify both Item Pick Rules and Item Pick PLA Configuration.

7.2.1.4.5 Specifying Batch Pick Rules

There is no configuration with regard to setting up of rules for Batch Picking.

Batch Picking is used when there are no matches to the Item Pick and Order Pick rules, and when in the Pick Process Determination panel, the Otherwise, use batch picking checkbox is selected.

7.2.1.4.6 Specifying Batch Pick Location Configuration

Pick Location Assignment (PLA) assigns the warehouse locations to the demand placed. You can define the list of zones to use for picking by specifying for a combination of item level attributes, such as classifications and unit on measure. Multiple PLA rules may be specified to ensure that the zone level constraints are unique to the item classification and unit of measure combination. For example, for SKUs stocked in pallets, cases and loose units, it is advisable to have 3 distinct rules to cover zones that are applicable for each unit of measure. The locations to be used in the zone can be filtered further by considering the least travel or pick-to-clean constraints.

You can use the Batch Pick PLA Configuration tab for:

- [Configuring Pick Location Rules for All Items](#)
- [Configuring Pick Location Rules for Specific Items](#)

Configuring Pick Location Rules for All Items

You can define global PLA rules for all items in a warehouse based on unit of measure.

To assign pick location rules for all items:



1. From the Batch Picking tab in the Shipment Group Details window, choose the Batch Pick PLA Configuration tab.
2. From the Pick Location tree, select All Items.
3. Choose . The UOM Condition pop-up window displays.
4. Enter information in the applicable fields. Refer to [Table 7–16](#) for field value descriptions.
5. Choose .

Table 7–16 UOM Condition Pop-Up Window





Field	Description
Description	Enter a brief description of the unit of measure condition.
When Unit of Measure is in	<p>You must specify the units of measure for which this condition is based. The system uses the pick location parameters that you specify to generate pick plans for items of the units of measure you select.</p> <p>Choose . The List of Values pop-up window displays. Select the blank line and choose a unit of measure from the drop-down list menu. When you have finished adding units of measure, choose OK.</p>

Table 7–16 UOM Condition Pop-Up Window

Field	Description
<p>Then, first search for pick locations as per PLA rule</p>	<p>You must specify the pick location parameters to be used initially according to the pick location assignment rule.</p> <p>Choose . The Pick Location Assignment pop-up window displays. See The Pick Location Assignment Rule (Batch Pick) Pop-Up Window for field level descriptions.</p> <p>When you have finished defining pick location parameters, choose OK.</p>
<p>When inventory is not found, search as per PLA rule</p>	<p>You can define pick location parameters to be used if inventory is not found using the initial parameters according to the pick location assignment rule.</p> <p>Choose . The Pick Location Assignment pop-up window displays. See The Pick Location Assignment Rule (Batch Pick) Pop-Up Window for field level descriptions.</p> <p>When you have finished defining pick location parameters, choose OK.</p>
<p>When inventory is still not found, search as per PLA rule</p>	<p>You can define pick location parameters to be used if inventory is not found using the second set of parameters according to the pick location assignment rule.</p> <p>Choose . The Pick Location Assignment pop-up window displays. See The Pick Location Assignment Rule (Batch Pick) Pop-Up Window for field level descriptions.</p> <p>When you have finished defining pick location parameters, choose OK.</p>



The Pick Location Assignment Rule (Batch Pick) Pop-Up Window

The Pick Location Assignment pop-up window is used to set the parameters used to determine the location from which items are picked. Refer to [Table 7–17](#) for field value descriptions.

Pick Location Assignment Rule

Description



Location Selection

1. Locations with Inventory Select locations having inventory from the following zones
 
and having inventory in one of the following status
 

Optimize retrieval by Pick to clean Least number of trips Pick Sequence

2. Dedicated Locations For the remaining demand, select dedicated location(s) from the zones listed above.
 Replenish when inventory goes below minimum quantity for dedicated items
 Replenish the locations up to max quantity for dedicated items
 For items without dedicated locations dynamically slot a location from the zones listed above.

3. Pick Fence Locations Whenever a dedicated location has demand that exceeds times location capacity
Dynamically slot a location from the following zones instead
 

4. Cross Dock Locations For the demand left over from the previous steps, explore cross-docking opportunity.
Search for inbound shipments that are in following status
 
Retrieve to a dynamically slotted location in following zones
 

Split Constraint

Splitting is allowed for Pallets and Cases Pallets but not Cases Neither Pallets nor Cases

Task Creation



Order Picking Task Type  

Table 7–17 Batch Pick Location Assignment Window

Field	Description
Description	Enter a brief description of the pick location assignment parameters.
Location Selection	

Table 7–17 Batch Pick Location Assignment Window



Field	Description
Locations with Inventory	<p>When this pick location assignment is used, the system initially tries to find the optimal location to pick inventory based on the parameters you define below.</p> <p>When allocating inventory for zones that have split constraints defined at either the PLA rule level or the zone level, the Sterling Warehouse Management System does not consider any existing pend in quantities.</p>
Select locations having inventory from the following zones	<p>You must specify the zones that you want to pick from when this pick location assignment is used.</p> <p>Choose . The List of Values pop-up window displays. Select the blank line and choose a zone from the drop-down list menu. When you have finished adding zones, choose OK.</p>
and having inventory in one of the following status	<p>Specify the inventory status that you want to pick from when this pick location assignment is used.</p> <p>Choose . The Inventory Status List pop-up window displays. Select the blank line and choose a zone from the drop-down list menu. When you have finished adding zones, choose OK.</p>
Optimize retrieval by	<ul style="list-style-type: none"> • Choose Pick to Clean to fulfill the demand by emptying as many LPNs or locations as possible for optimal usage of space in a zone. • Choose Least Number of Trips to fulfill the demand from the least number of locations, to enable users to make least number of trips when retrieving inventory. When there is more than one way to make the same least number of trips, the 'PickToClean' process is followed within the 'LeastNumberOfTrips' process. • Choose Pick Sequence to pick from locations in the order of their pick sequence. The system chooses locations having lower pick sequence numbers over locations having higher pick sequence numbers.

Table 7–17 Batch Pick Location Assignment Window

Field	Description
Dedicated Locations	If there is still pick demand after the Locations with Inventory algorithm has been performed, the system looks for locations dedicated specifically for the inventory.
For the remaining demand, select dedicated locations from the zones listed above.	<p>Select this checkbox if you want any pick demand that was not fulfilled using the above parameters to be picked from dedicated locations in the zones you have specified for Locations with Inventory. By selecting this field the system uses replenishment to ensure that the dedicated location remains stocked with pickable inventory.</p> <p>The Sterling Warehouse Management System does not replenish zones that have split constraints, although replenishment strategies are configured.</p>
Replenish when inventory goes below minimum quantity for dedicated items	<p>This field is enabled when the Dedicated Locations are configured.</p> <p>Select this checkbox to replenish the inventory when it goes below the minimum quantity for the dedicated items.</p>
Replenish the locations up to max quantity for dedicated items	<p>This field is enabled when the Dedicated Locations are configured.</p> <p>Select this checkbox to replenish the locations up to the maximum quantity for the dedicated items.</p>
For items without dedicated locations, dynamically slot a location from the zones listed above.	Select this checkbox if you want items that do not have a dedicated picking location to be dynamically slotted for picking. The location is dynamically slotted in the zones you have specified for Locations with Inventory.
Pick Fence Locations	When demand for inventory at a dedicated location exceeds its normal levels, you can specify the zones in which that inventory can be dynamically slotted for picking.
Whenever a dedicated location has demand that is n times location capacity	<p>Enter the multiple by which demand must exceed a dedicated location's capacity before a location is dynamically slotted for picking.</p> <p>For example, you enter 5. A dedicated location has a capacity of 10 cases. A location is dynamically slotted for picking if there is a demand for 50 cases or more.</p>

Table 7–17 Batch Pick Location Assignment Window





Field	Description
Dynamically slot a location from the following zones instead	<p>You can specify the zones in which the system assigns dynamically slotted locations if demand exceeds the specified level.</p> <p>Choose . The List of Values pop-up window displays. Select the blank line and choose a zone from the drop-down list menu. When you have finished adding zones, choose OK.</p>
Cross Dock Locations	<p>For any remaining pick demand, you can define the inbound shipment status levels from which items can be cross-docked. Cross-docking allows you to retrieve inventory directly from receiving staging locations and bring the inventory to a dynamically slotted location for picking.</p>
Search for inbound shipments that are in following status	<p>You can specify the inbound shipment statuses that you want to search for inventory. The system searches for inbound shipments in the specified statuses. Once the shipment is received the system diverts the inventory to the dynamically slotted location.</p> <p>Choose . The Shipment Statuses pop-up window displays. Select the blank line and choose an inbound shipment status from the drop-down list menu. When you have finished adding inbound shipment statuses, choose OK.</p>
Retrieve to a dynamically slotted location in following zones	<p>You can specify the zones in which the system assigns dynamically slotted locations to which inventory is brought from the receiving dock for picking.</p> <p>Choose . The Cross Dock Zones pop-up window displays. Select the blank line and choose a zone from the drop-down list menu. When you have finished adding zones, choose OK.</p>
Split Constraint	
<p>The system allows the user to break open an LPN for all zones specified in the PLA based on the option specified.</p> <p>If split constraints are defined at the zone and PLA rule levels, the system chooses the most restrictive constraint to ensure that constraints defined are not violated.</p>	

Table 7–17 Batch Pick Location Assignment Window

Field	Description
Splitting is allowed for:	
Pallets and Cases	Choose this if you want to allow users to break open both pallets and cases.
Pallets but not Cases	Choose this if you want to allow users to break open only pallets.
Neither Pallets nor Cases	Choose this if you do not want to allow users to break open pallets or cases.
Task Creation	
Batch Picking Task Type	Select the type of task to use for batch picking from the zones specified for this pick location assignment. Choose  . The Task Type Wizard window displays. For more information about the task type wizard, see Section 12.3, "Defining Task Types" on page 885.

Note: For Dedicated Locations, move request and replenish tasks are created. For Cross Dock Locations, move request and replenish tasks are NOT created, instead the Wave Release creates "Activity Demand".

Configuring Pick Location Rules for Specific Items

You can define PLA rules for items in a warehouse based on the item classification and unit of measure.

Note: Only Item Classifications corresponding to the Classification Purpose "retrieval" can be configured here.

To assign pick location rules for specific items:

1. From the Batch Picking tab in the Shipment Group Details window, choose the Batch Pick PLA Configuration tab.
2. From the Pick Location tree, select Specific Items.

3. Choose . The Item Condition pop-up window displays.

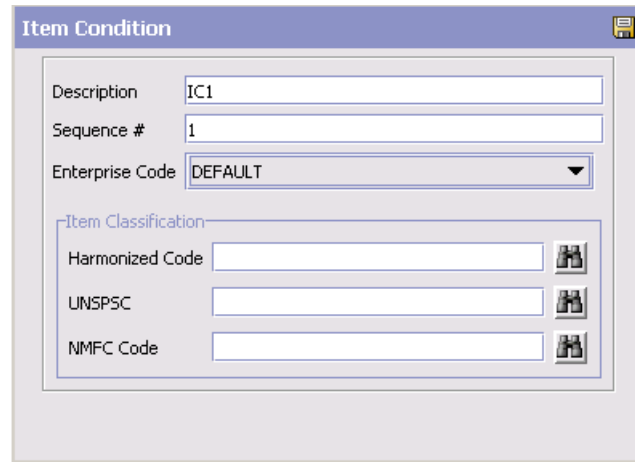

4. In Description, enter a brief description of the item condition.
5. In Sequence #, enter the sequence number. Items are evaluated for the criteria you define. The sequence number determines the order by which item conditions evaluate items. Once an item matches up with an item condition's criteria, it uses the applicable pick location assignment algorithms.

Note: When requesting an item for performing PLA, the item conditions are evaluated in a sequence. Once any of the conditions is evaluated as 'true', no more conditions are further evaluated. The evaluated condition is used for performing PLA.

6. From Enterprise Code, select the Enterprise you want to associate with the item condition.
7. In Item Classification, enter the applicable classification parameters according to your business practices. Fields used in Classifications are mapped to the Enterprise that you select for the item condition. For more information about configuring classifications, see the *Catalog Management: Configuration Guide*.

Note: To successfully release a wave, it is mandatory to specify both Item Pick Rules and Item Pick PLA Configuration.

7.2.1.5 Defining a Shipment Group's Sort Strategy

You can define how waves belonging to this shipment group are sorted. You can configure logic for machine sorters by carrier, and by shipment.

To define a shipment group's sort strategy:

1. In the Shipment Group Details window, choose the Sort For Shipping tab.
2. Choose 'Use the same Sort Strategy as defined in Shipment Group' and select the applicable shipment group if you want to use a sort strategy already defined for an existing shipment group.

Important: If you choose to use another shipment group's sort strategy, any modifications you make to the sort strategy in the original shipment group has a direct impact on the sort strategy of all shipment groups inheriting from it.

3. Choose 'Define a separate Sort Strategy for this Shipment Group' if you want to define a new sort strategy for this shipment group. The Carrier Sorting and Shipment Sorting tabs appear.
4. Choose .



You can use the Sort For Shipping Tab for:

- [Defining Carrier Sorting Parameters](#)
- [Defining Shipment Sorting Parameters](#)

7.2.1.5.1 Defining Carrier Sorting Parameters

If you selected 'Define a separate Sort Strategy for this Shipment Group', you can define carrier sorting parameters.

To define carrier sorting parameters:

1. From the Sort For Shipping tab in the Shipment Group Details window, choose the Carrier Sorting tab.
2. Select 'First, sort by Carrier' if applicable.
3. From Equipment Type, select the equipment type the machine sorter you are defining parameters for belongs to.
4. From Equipment, select the machine sorter you want to define parameters for. The Chute Dedication table displays.
5. From the Chute Dedication table, choose . The Chute Dedication Details pop-up window displays.
6. Enter information in the applicable fields. Refer to [Table 7–18](#) for field value descriptions.
7. Choose .

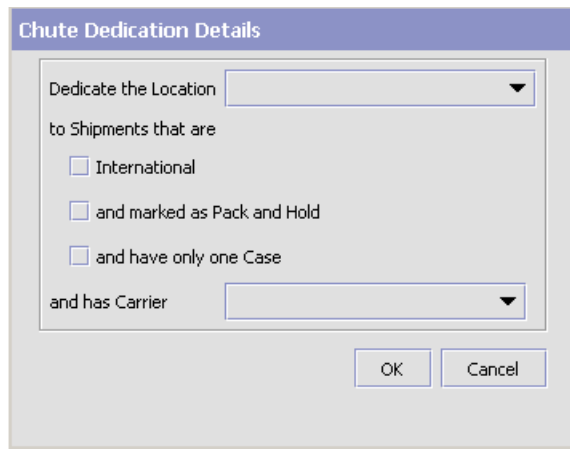

Table 7–18 Chute Dedication Details Pop-Up Window

Field	Description
Dedicate the Location	Select the location that you want the machine to sort shipments that meet the criteria you define in the following fields.
to Shipments that are	

Table 7–18 Chute Dedication Details Pop-Up Window

Field	Description
International	Select this field if you want to sort export shipments to the selected international location.
and marked as Pack and Hold	Select this if you want to sort shipments marked as Pack and Hold to the selected location.
and have only one Case	Select this field if you want to sort single carton shipments to the selected location.
and has Carrier	Select the carrier you want to apply this sorting rule to. For example, if you want to sort all shipments being shipped by UPS to location 1 (L1) for loading.

7.2.1.5.2 Defining Shipment Sorting Parameters

If you selected 'Define a separate Sort Strategy for this Shipment Group', you can define shipment sorting parameters.

To define shipment sorting parameters:



1. From the Sort For Shipping tab in the Shipment Group Details window, choose the Shipment Sorting tab.
2. Enter information in the applicable fields. Refer to [Table 7–19](#) for field value descriptions.
3. Choose .

Table 7–19 Shipment Sorting Tab

Field	Description
Then, sort by Shipment	Select this field if you want to define parameters for sorting by shipment. Note: Carrier sorting is performed before shipment sorting.
Shipment Sorting Rules	
Equipment Type	If you chose Sort using Equipment, select the equipment type the machine sorter you are defining parameters for belongs to.
Equipment	If you chose Sort using Equipment, select the machine sorter you want to define parameters for. The Chute Dedication table displays. To define new chute dedication parameters, choose  and refer to Table 7–18 for field value descriptions.

7.2.1.6 Defining a Shipment Group's Advanced Parameters

You can define process model used for waves, the wave acceptance process, and the wave release process.

To define a shipment group's advanced parameters:

1. In the Shipment Group Details window, choose the Advanced tab.
2. Enter information in the applicable fields. Refer to [Table 7–20](#) for field value descriptions.
3. Choose .

Table 7–20 Advanced Tab

Field	Description
Process Model	
Wave Pipeline	Select the pipeline you want to use for processing waves belonging to this shipment group.
Acceptance Process	

Table 7–20 Advanced Tab

Field	Description
Automatically accept every wave	Choose this field if you want waves to be accepted regardless of size and total number of shipments.
Automatically accept only those waves that meet any of the following conditions	Choose this field and enter the applicable parameters if you want to automatically accept waves that meet specified volume and/or shipment number constraints and manually accept waves that do not.
All waves are manually accepted	Choose this field if you want all waves belonging to this shipment group to be manually accepted.
Wave Release Process	
# Waves released concurrently	Enter the maximum number of waves against this shipment group you want to be released to the warehouse at one time.
Wave Create Process	
Limit the # Waves being Processed to	Enter the maximum number of waves against this shipment group you want to process to the warehouse at one time.
Before Wave Status	Select the wave status from the drop-down list to include the number of waves against this shipment group. Note: The system will count all the waves prior to the selected wave status.

7.2.2 Defining Wave Size Constraints

You can define wave size constraints for waves. These constraints limit the size of a wave. A *wave* is an aggregation of picks across zones and orders that are consolidated to optimize pick and prioritize shipment.



You can use the Wave Constraints tab for:

- [Creating Wave Size Constraints](#)
- [Modifying Wave Size Constraints](#)
- [Deleting Wave Size Constraints](#)

7.2.2.1 Creating Wave Size Constraints

To create wave size constraints:

Defining Pick Planning Parameters

1. From the tree in the application rules side panel, choose Picking > Pick Planning. The Pick Planning window displays in the work area.
2. Choose the Wave Size Constraints tab. The Wave Size Constraints window displays.
3. Choose  from the Wave Size Constraints table. The Size Constraint Details pop-up window displays.
4. Enter information in the applicable fields. Refer to [Table 7–21](#) for field value descriptions.
5. Choose .

Size Constraint Details

Description

When shipment matches all the following conditions

Enterprise Code

Shipment Mode

Carrier

Shipment has more than one shipment line

Shipment has more than one case

And for shipments that have any lines having the following attributes

Then ensure that wave size does not exceed any of the following constraints

Loads # Shipments

Cases Volume CIN

Effort Estimate for resource pool

Shipment lines

Do not mix shipment profiles in wave, if the number of shipments in a profile exceeds

Table 7–21 Size Constraint Details Pop-Up Window

Field	Description
Description	Enter a brief description of the size constraint parameters.
When shipment matches all the following conditions	When shipments meet all of the conditions specified in the following fields, then the constraints indicated in the option you select below are applied.
Enterprise Code	Select the Enterprise that you want apply constraints to.
Shipment Mode	Select the shipment mode that you want to apply constraints to. For example, if parcel carriers cannot ship a certain amount of cases in a shipment, you can select Parcel and enter the case constraint below.
Carrier	Select the carrier that you want to apply constraints to. For example, if there is a specific carrier that does not ship more than a specified volume, you can select the carrier and enter the volume constraint below.
Shipment has more than one shipment line	Select this field if you want to apply the constraints only against shipments that have more than one line.
Shipment has more than one case	Select this field if you want to apply the constraints only against shipments with more than one case.
And for shipments that have any lines having the following attributes	Select this field if you want to use classifications to determine the wave constraint criteria. A field used in Classifications is mapped to the Enterprise that you select for the shipment selector. For more information about configuring classifications, see the <i>Catalog Management: Configuration Guide</i> . Enter the valid value for the classifications that display according to your business practices.
Then ensure that wave size does not exceed any of the following constraints	
#Loads	Enter the number of loads to limit in a wave if the above criteria is met. Note: This field does not display if the 'And for shipments that have any lines having the following attributes' option is selected.



Table 7–21 Size Constraint Details Pop-Up Window

Field	Description
# Shipments	Enter the number of shipments to limit in a wave if the above criteria is met. Note: This field does not display if the 'And for shipments that have any lines having the following attributes' option is selected.
# Cases	Enter the number of cases to limit in a wave if the above criteria is met. Note: This field does not display if the 'And for shipments that have any lines having the following attributes' option is selected.
Volume	Enter the volume and select the applicable unit of measure to limit a wave to if the above criteria is met. Note: This field does not display if the 'And for shipments that have any lines having the following attributes' option is selected.
Effort Estimate <effort estimate value> for resource pool	Enter the value of the estimated effort by selecting the UOM from the drop-down list. Select the particular resource pool from the drop-down list for which the effort is estimated.
# Shipment lines	Enter the number of shipment lines to limit in a wave if the above criteria is met. Note: This field does not display if the 'And for shipments that have any lines having the following attributes' option is selected.
Do not mix shipment profiles in wave if the number of shipments in a profile exceeds	Select this field and enter an applicable value (threshold value) to create a wave exclusively for a profile without any profile mixing, when the number of shipments for that profile exceeds the threshold value.

Important: To define a wave size constraint, select "# Shipments" option or "# Shipment lines" option. If you select both the options the system displays "Only one wave size constraint allowed out of # Shipments Or # Shipment Lines" error message.

7.2.2.2 Modifying Wave Size Constraints

To modify wave size constraints:

1. From the tree in the application rules side panel, choose Picking > Pick Planning. The Pick Planning window displays in the work area.
2. Choose the Wave Size Constraints tab. The Wave Size Constraints window displays.
3. Locate the applicable wave size constraint and choose . The Size Constraint Details pop-up window displays.
4. Enter information in the applicable fields. Refer to [Table 7–21](#) for field value descriptions.
5. Choose .

7.2.2.3 Deleting Wave Size Constraints

To delete wave size constraints:

1. From the tree in the application rules side panel, choose Picking > Pick Planning. The Pick Planning window displays in the work area.
2. Choose the Wave Size Constraints tab. The Wave Size Constraints window displays.
3. Locate the applicable wave size constraint and choose .

7.2.3 Defining a Wave Release Schedule

You can define the schedule used to release waves for picking in the warehouse for a given day. You can define the different times and days that waves belonging to a shipment group are released.

For example, if you have a shipment group (S1) defined for a specific carrier that only picks up shipments at 3 PM on Thursdays and Fridays, you would not want the system to generate pick waves for shipments belonging to that group on Monday at 9 AM.

You might want the wave to be released earlier than 3 hours before the pickup time to allot for picking, packing, value-added services, and so on. Using the wave release schedule you can schedule waves for S1 to be released for picking only on Thursday and Friday at noon through 12:30. In this scenario, as the previous pick tasks for the day are completed

during the timeframe you have scheduled for S1, the waves are released on Thursday and Friday between noon and 12:30.

However, if for some reason of the warehouse has fallen behind on pick tasks, and the S1 waves were not released between the specified timeframe, these shipments are stamped and added to the next scheduled wave release timeframe for S1. For example, the warehouse falls behind on its pick tasks on a Thursday morning. The previously released waves spill into the noon to 12:30 timeframe and the S1 waves do not get released. In this case, shipments in these unreleased waves are stamped and picked back up for wave release on Friday.

You can use the Wave Release Schedule tab for:

- [Creating a Wave Release Schedule](#)
- [Modifying a Wave Release Timeframe](#)
- [Deleting a Wave Release Timeframe](#)

7.2.3.1 Creating a Wave Release Schedule

To create a wave release schedule for a shipment group:

1. From the tree in the application rules side panel, choose Picking > Pick Planning. The Pick Planning window displays in the work area.
2. Choose the Wave Release Schedule tab. The Wave Release Schedule window displays. You can view wave release timeframe details.
3. Check the Delayed Inventory Allocation Support box for the Allocate Task agent to allocate tasks in a multi-threaded fashion.
4. Check the Do Not Consider Pending Inventory For Allocation box to enable or disable the Release Wave agent to consider pending inventory available at the source location for allocation.

For more information about allocating tasks, see [Section A.2.2, "Allocate Task"](#).

The screenshot shows the 'Wave Release Schedule' window. It includes the following configuration options:

- Inventory Allocation Configuration:**
 - Delayed Inventory Allocation Support
 - Do Not Consider Pending Inventory For Allocation
- If Inventory Shortage Found in the Shipment:**
 - Remove Shipments From Wave
 - Remove Shipment Lines From Wave
 - Remove Shortage Quantities From Wave

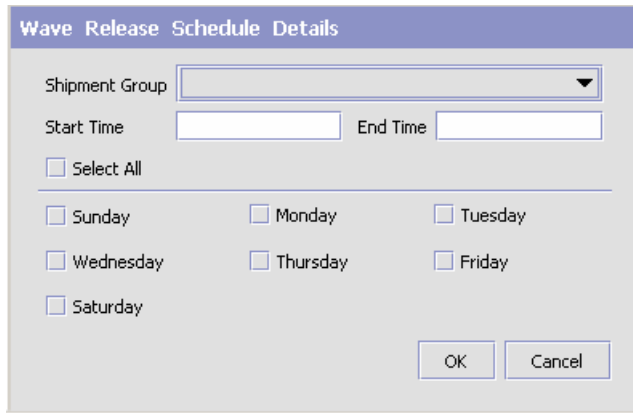

Below the configuration is a grid for scheduling. The grid has columns for time slots: Early Morning (10:30, 12:30, 14:30), Morning (16:30, 18:30, 20:30), Afternoon (22:30, 0:30, 2:30), and Night (4:30, 6:30, 8:30). The first row of the grid contains the numbers 123 and 456 in the leftmost column, with the rest of the grid cells being empty.

5. If there is a shortage in inventory, you can choose any one of the following options:
 - Remove Shipments From Wave.
 - Remove Shipments Lines From Wave.
 - Remove Shortage Quantities From Wave.
6. Choose . The Wave Release Schedule Details pop-up window displays.



The dialog box titled "Wave Release Schedule Details" contains the following elements:

- A "Shipment Group" drop-down menu.
- Two text input fields for "Start Time" and "End Time".
- A "Select All" checkbox.
- Seven checkboxes for the days of the week: Sunday, Monday, Tuesday, Wednesday, Thursday, Friday, and Saturday.
- "OK" and "Cancel" buttons at the bottom right.



7. From the Shipment Group drop-down list menu, select the shipment group for which you want to create a wave release timeframe.
8. In Start Time, enter the start time for the wave release timeframe.
9. In End Time, enter the end time for the wave release timeframe.
10. Select the days for which the wave release timeframe are valid.
11. Choose . A graphical representation of the wave release timeframe displays in the wave timesheet for the shipment group, in the Wave Release Schedule window.
12. Continue to add wave release timeframes for the defined shipment groups.
13. When you have completed the wave release schedule, choose .

Note: While creating Wave Size Constraint if you check the 'Do not mix shipment profiles in wave if the number of shipments in a profile exceeds' box, then it is advisable to choose 'Remove Shipments From Wave' option in the Wave Release Schedule' screen.

If the other two options "Remove Shipment Lines From Wave" or " Remove shortage Quantities From Wave" are chosen, then in such scenario odd shipment with a different profile ID could be created in a wave, which was meant for a different profile.

7.2.3.2 Modifying a Wave Release Timeframe

To modify a wave release timeframe from a shipment group:

1. From the tree in the application rules side panel, choose Picking > Pick Planning. The Pick Planning window displays in the work area.
2. Choose the Wave Release Schedule tab. The Wave Release Schedule window displays.
3. From the wave release timesheet, select the timeframe you want to modify.
4. Choose . The Wave Release Schedule Details pop-up window displays.
5. Make the changes, as necessary. Choose .

7.2.3.3 Deleting a Wave Release Timeframe

To delete a wave release timeframe from a shipment group:

1. From the tree in the application rules side panel, choose Picking > Pick Planning. The Pick Planning window displays in the work area.
2. Choose the Wave Release Schedule tab. The Wave Release Schedule window displays.
3. From the wave release timesheet, select the timeframe you want to delete.
4. Choose .

7.3 Defining Wave Cancellation Reasons

You can define wave cancellation reasons that can be specified when a user cancels a wave in the Application Consoles.

You can use the Wave Cancellation Reasons branch for:

- [Creating a Wave Cancellation Reason](#)
- [Modifying a Wave Cancellation Reason Code](#)
- [Deleting a Wave Cancellation Reason](#)

7.3.1 Creating a Wave Cancellation Reason

To create a wave cancellation reason:

1. From the tree in the application rules side panel, choose Picking > Wave Cancellation Reasons. The Wave Cancellation Reason window displays in the work area.
2. Choose . The Wave Cancellation Reasons pop-up window displays.

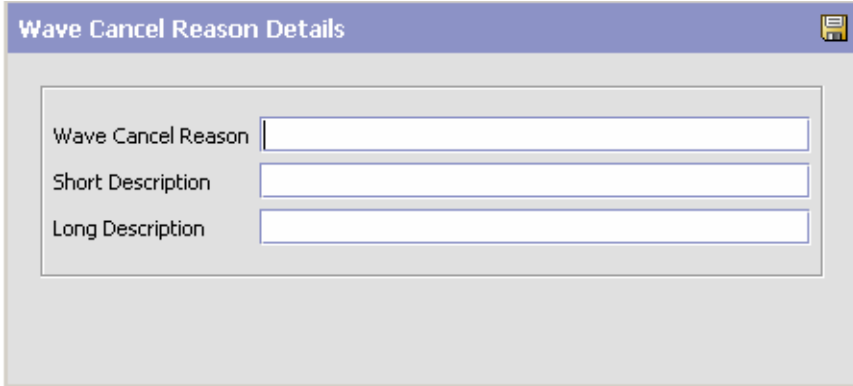

The screenshot shows a dialog box titled "Wave Cancel Reason Details". It contains three text input fields:



- Wave Cancel Reason
- Short Description
- Long Description

3. In Wave Cancel Reason, enter the name of the wave cancellation reason.
4. In Short Description, enter a brief description of the wave cancellation reason.
5. In Long Description, enter a more detailed description of the wave cancellation reason.

6. Choose .

7.3.2 Modifying a Wave Cancellation Reason Code

To modify a wave cancellation reason code:

1. From the tree in the application rules side panel, choose Picking > Wave Cancellation Reasons. The Wave Cancellation Reason window displays in the work area.
2. Select the applicable wave cancellation reason and choose . The Wave Cancellation Reasons pop-up window displays.
3. In Short Description, enter a brief description of the wave cancellation reason.
4. In Long Description, enter a more detailed description of the wave cancellation reason.
5. Choose .

7.3.3 Deleting a Wave Cancellation Reason

To delete a wave cancellation reason:

1. From the tree in the application rules side panel, choose Picking > Wave Cancellation Reasons. The Wave Cancellation Reason window displays in the work area.
2. Select the applicable wave cancellation reason and choose .

7.4 Defining Purge Criteria

Transactional data collected by the Sterling WMS during the execution are periodically removed from the "live" transactional tables. It is common to retain order related information for extended periods of time. There are history tables provided for relevant transactional tables to move data from the day-to-day "live" tables to a historical table.

Purge is the process by which old data is removed from the system database. A purge minimizes the number of unused database records to increase search efficiency and reduces the size of the required physical disk.

7.4.1 Setting Up Purge Criteria

To set up purge criteria:

1. From the tree in the application rules side panel, choose Picking > Purge Criteria. The Purge Criteria List window displays.

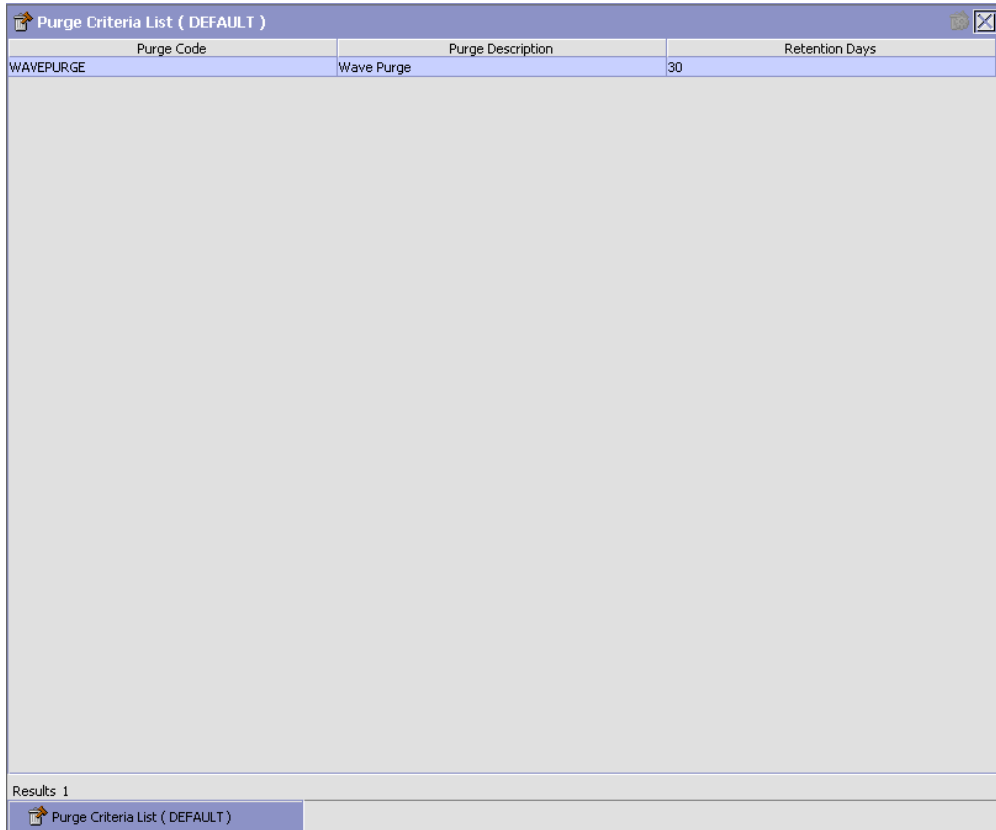



2. In the Purge Criteria List window, choose . The Purge Criteria Details pop-up window displays.
3. Enter information in the applicable fields. Refer [Table 7–22](#) for field value descriptions.
4. Choose .

Table 7–22 Purge Criteria Details Pop-up Window

Field	Description
Purge Code	Identifies a purge program. This is a system defined code.
Description	Description of the purge.
Rollback Segment	Defines the rollback segment that should be explicitly used for the purge transaction qualified by the purge code. This is useful when there are huge logical data sets that have to be purged. This is optional and used for order related purges.
Retention Days	Enter the number of days of data to be retained in the database (going backwards from the time the program runs). Make sure that your table size takes into account the number of retention days entered here.

Table 7–22 Purge Criteria Details Pop-up Window

Field	Description
Write To Log File	Check this box if you want purged data written to a log. The log can be backed up and used as a journal at a later date.
Log File Name	<p>Enter a log file name. This is applicable only if 'Write To Log File' is checked. This file consists records of the specific table that is purged.</p> <p>The log file is created in the directory specified in the <code>yfs.purge.path</code> property. If this is not passed, it defaults to the value specified in the <code>yfs.properties</code> file. If a variable is introduced, then the <code>yfs.purge.path</code> is ignored. To modify this property, add an entry for it in the <code><INSTALL_DIR>/properties/customer_overrides.properties</code> file. For additional information about modifying properties and the <code>customer_overrides.properties</code> file, see the <i>Selling and Fulfillment Foundation: Properties Guide</i>.</p> <p>For information about file name limitations relating to internationalization, see the <i>Selling and Fulfillment Foundation: Localization Guide</i>.</p>

Configuring Value Added Services

The Value Added Services (VAS) area in the warehouse performs activities that include packaging, monogramming and ticketing. The retrieval rules are defined further in this section.

The different types of Value Added Service activities include:

- Monogramming on a T-shirt
- Building computer to buyer's specification
- Segregating individual boxes from larger boxes
- Scratch guarding a sofa
- Installing a PC at home

As the above examples suggest, Value Added Services related activities apply both before and after the shipping process.

NOTE: To be able to confirm a Work Order you should have an Inventory Status Transition Rule setup for the Zone that the VAS location belongs. This Inventory Status Transition Rule should be defined from Blank to an Inventory Status that is associated with an ONHAND Supply Type.

Use Value Added Services for:

- [Defining Activities](#)
- [Defining Retrieval Strategy](#)

- [Defining Putaway Preferences](#)
- [Defining Work Order Cancellation Reasons](#)
- [Defining Allocation Considerations](#)
- [Defining Value Added Services Modification Rules](#)
- [Defining Value Added Services Process Type Details](#)
- [Defining Value Added Services Process Model](#)
- [Defining Purge Criteria](#)

8.1 Defining Activities

Activities in the warehouse are grouped into Activity Groups. The Sterling WMS provides a pre-defined set of activity groups for a warehouse. Examples of activity groups include Receiving, VAS, Picking and Packing.

Each activity group is associated with activity codes that define each activity that is performed. For example, receiving activity group has pre-receiving, Packing and receiving activities.

The list here is specific to the VAS process.

Note: Activity Codes and Activity Constraints may be defined only when the WMS tree is loaded for Node / Hub combination.

Use Activities for:

- [Creating an Activity Code](#)
- [Modifying an Activity Code](#)
- [Deleting an Activity Code](#)
- [Setting Up Activity Constraints for Single SKU](#)
- [Setting Up Activity Constraints for Containers](#)

8.1.1 Creating an Activity Code

To create an activity code:

1. From the tree in the application rules side panel, choose VAS > Activities. The Activities window displays.
2. Enter information in the applicable fields. Refer [Table 8–1](#) for field value descriptions.
3. Choose .

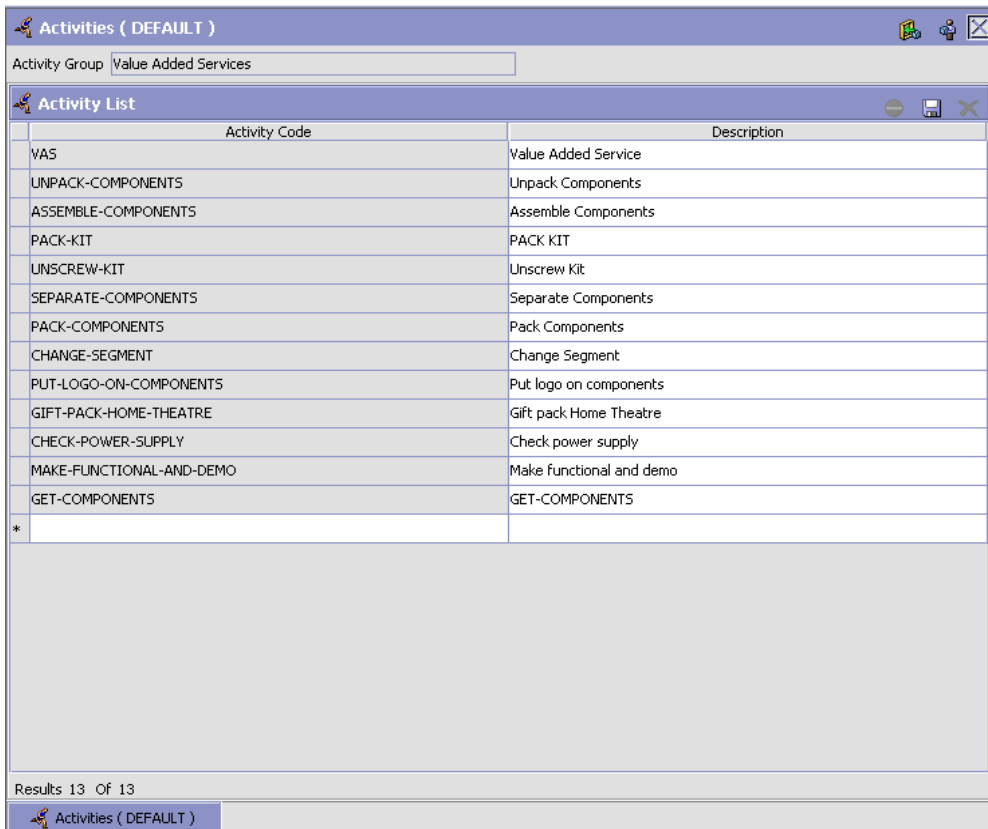



Table 8–1 Activities Window

Field	Description
Activity Group	This is automatically populated by the system as 'Value Added Services'.
Activity List	
Activity Code	Enter a name for the activity code. Activity code is the unique identity of the activity.
Description	Enter a brief description for the activity code.

8.1.2 Modifying an Activity Code

Once an activity code has been created, it can be modified.

To modify an activity code:

1. From the tree in the application rules side panel, choose VAS > Activities. The Activities window displays, with the list of activities.
2. Enter information in the applicable fields. Refer [Table 8–1](#) for field value descriptions.
3. Choose .

It is recommended that the Sterling WMS-provided list of activity codes is not modified.

8.1.3 Deleting an Activity Code

To delete an activity code:

1. From the tree in the application rules side panel, choose VAS > Activities. The Activities window displays, with the list of activities.
2. Choose the Activity Code to be deleted.
3. Choose .

It is recommended that the Sterling WMS-provided list of activity codes is not deleted.

8.2 Defining Activity Constraints

Activities in the warehouse are performed based on attributes of the shipment, container or inventory requiring VAS. The attributes considered are single SKU inventory, and containers.

When an Activity is performed on an Item (Pre-pick VAS, or VAS for stocking), you need to define the activity constraints in the Single SKU Tab. When the Activity is performed on a container (Post-pick VAS) you need to define it for the Container.

Use Activity Constraint set-up for:

- [Setting Up Activity Constraints for Single SKU](#)
- [Setting Up Activity Constraints for Containers](#)

8.2.1 Setting Up Activity Constraints for Single SKU

The constraints for the activity of a single SKU are specified here. This applies for all UOM of a SKU.

Use Activity Constraint set-up for:



- [Creating an Activity Constraint for Single SKU](#)
- [The Applicable Putaway Strategies window is displayed.](#)
- [Modifying an Activity Constraint for Single SKU](#)
- [Deleting an Activity Constraint for Single SKU](#)

8.2.1.1 Creating an Activity Constraint for Single SKU

To create an activity constraint for single SKU:

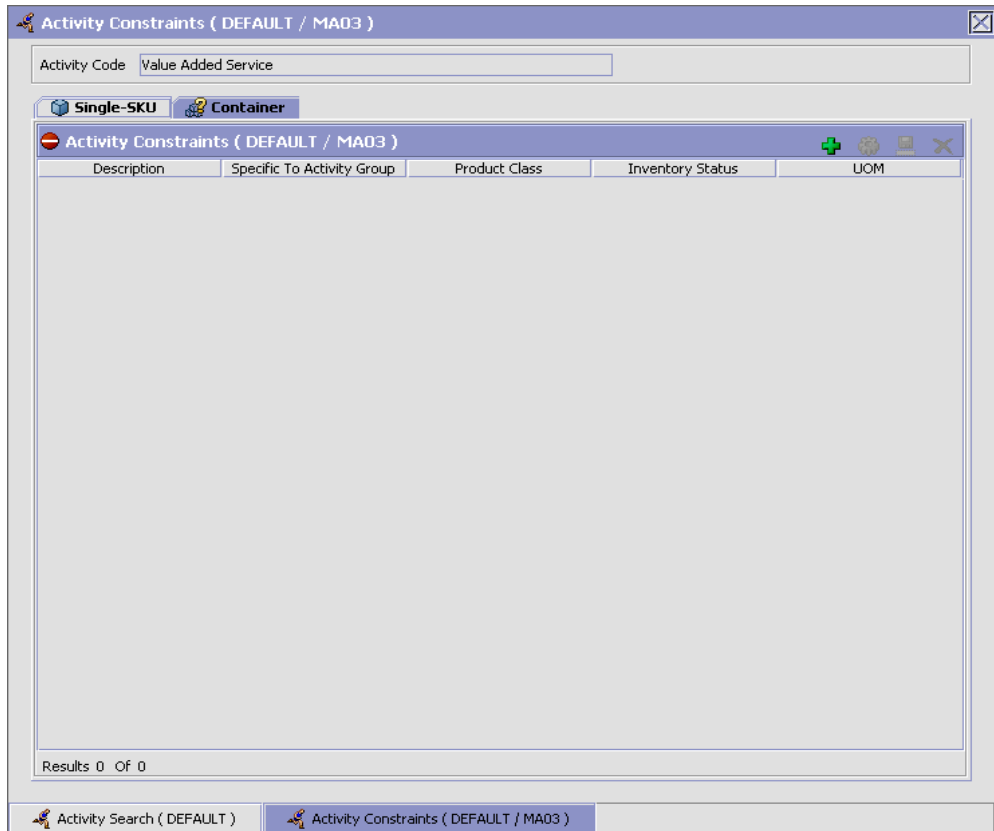
1. From the tree in the application rules side panel, choose VAS > Activities. The Activity Search window displays, with the list of activities.
2. Choose the Activity Code whose Activity Constraint is to be set up.
3. Choose . The Activity Constraints window displays.
4. In the Activity Constraints window, choose the Single-SKU tab. The Single-SKU tab window for Activity Constraints displays.



5. In the Single-SKU tab window, choose . The Activity Constraint Details window displays.
6. Enter information in the applicable fields. Refer [Table 8–2](#) for field value descriptions.
7. Choose .

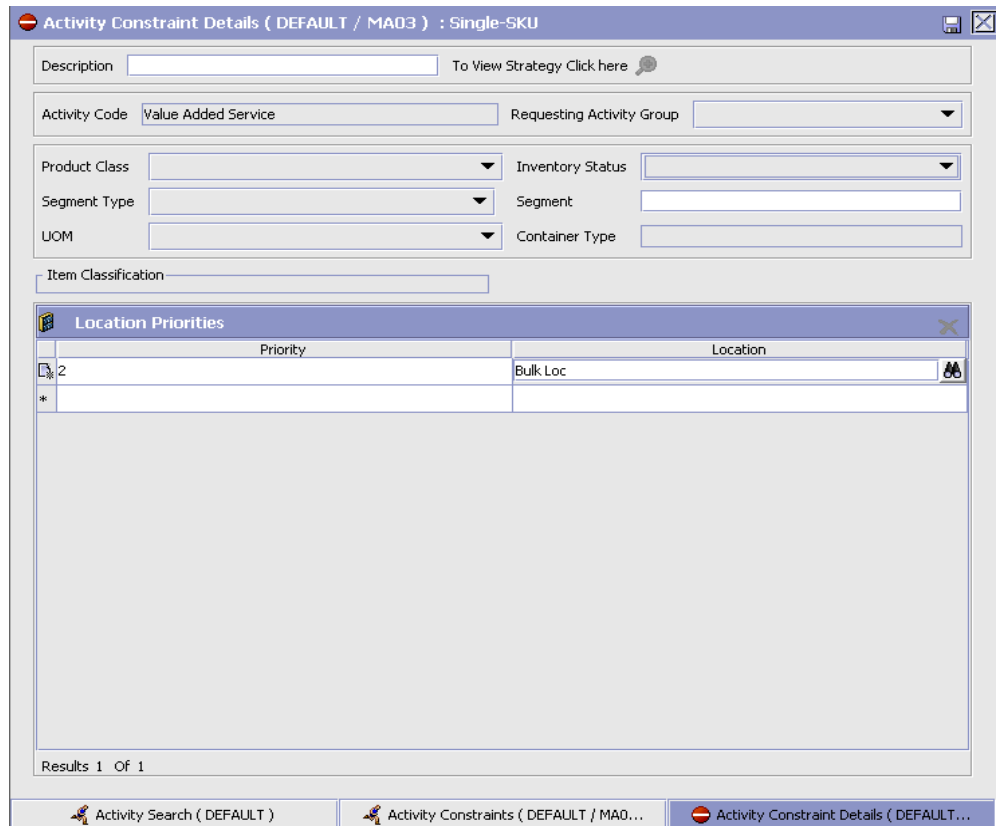

Table 8–2 Activity Constraint Details - Single-SKU Tab Window

Field	Description
Description	Enter a description for the activity constraint.
To View Strategy Click here	Choose  to view or set up Putaway Strategy. For more details on setting up a putaway strategy see Setting Up Putaway Strategy for Single-SKUs . Note: Putaway strategy may be specified for the putaway preferences after the preference is saved.
Activity Code	This indicates the activity code for the constraint.

Table 8–2 Activity Constraint Details - Single-SKU Tab Window

Field	Description
Requesting Activity Group	Choose the requesting activity group. Typical values are Receipt, and Packing.
Product Class	Choose the product class for the constraint, if applicable. Product class is the inventory classification of an item based on product's characteristics. Typical values are FQ - First Quality, SQ - Second Quality, etc.
Inventory Status	Choose the inventory status for the constraint, if applicable. Inventory status refers to an inventory sub classification based on the results of the inventory control processes within the warehouse.
Segment Type	Enter the segment type for the constraint, if applicable. This indicates an inventory category. Typical values are MTC – Made to Customer, and MTO - Made to Order.
Segment #	Enter the segment number for the constraint, if applicable. A segment holds either the specific buyer or specific order number that requires dedication.
UOM	Choose the UOM for the constraint, if applicable. UOM points to the Unit of measure of the item.
Container Type	The container type associated with the UOM selected displays. Typical values are "Pallet" and "Case".
Item Classification	List of putaway item classifications for the Enterprise display. An example, Product Line is shown below.
Product Line	Choose relevant product line item classification for the putaway activity. Choose  . In the Classification window, select the applicable product line classification.
Location Priorities	

Table 8–2 Activity Constraint Details - Single-SKU Tab Window

Field	Description
Priority	<p>Enter a number to represent the priority.</p> <p>The priority is used to sequence the order in which the location priorities are evaluated. For example, all storage code level priorities are to be evaluated first before generic priorities.</p> <p>The priority needs to be a positive integer, greater than zero. This is a mandatory field.</p>
Location	<p>Choose the relevant location for the activity.</p> <p>This is a mandatory field.</p>

Setting Up Putaway Strategy for Single-SKUs

You can set up putaway strategies to putaway applicable inventory from a source zone to a target zone, based on the strategy specified.

To set up putaway strategy for single-SKUs:

1. In the Activity Constraint Details : Single SKU window, choose .
2. The Applicable Putaway Strategies window is displayed.

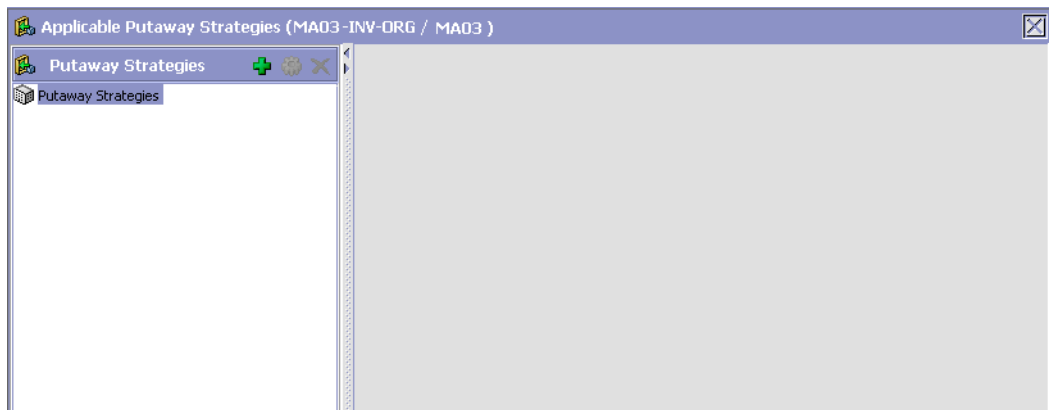

3. Choose  in the Putaway Strategies panel. The Putaway Strategy Details window appears in the right panel.
4. Enter information in the applicable fields. See the Putaway Strategy Details Window table for field value descriptions.

5. Choose .

Putaway Strategy Details

Description: Strategy for DVD-LockAndKey-EACH UOM: CASE

Item Classification:

Product Line: DVD

StorageType: LockAndKey

Product Line:

System Directed Putaway Task Types

	Source Zone	Target Zone	Container Type	Task Type
*				

Results: 0 Of 0

Ad Hoc Task Types

	Source Zone	Target Zone	Container Type	Task Type
*				

Results: 0 Of 0

Table 8–3 Putaway Strategy Details Window







Field	Description
Description	Enter a description for the Putaway Strategy.
UOM	Select the UOM for the Putaway Strategy, if applicable. Note: The UOM will be defaulted in instances where it has been specified in the Putaway Preference Details screen.
Item Classification	List of putaway item classifications for the Enterprise are displayed. An example, Product Line is shown below.
Product Line	Choose relevant product line item classification for the putaway activity. Choose  . In the Classification Values window, select the applicable product line classification.
System Directed Putaway Task Types	Displays the list of existing system directed putaway task types. You may use  to delete an existing system directed putaway task type.
Source Zone	Select the source zone from where the inventory is sourced.
Target Zone	Select the target zone to where the inventory is moved.
Container Type	Select the container type to be used to move the inventory from the source zone to the target zone. Typical values are Case and Pallet.
Task Type	Select the Putaway Task Type applicable to this putaway strategy. This field displays the list of existing system directed task types that belong to the 'PUTAWAY' activity group.
Ad hoc Task Types	Displays the list of existing ad hoc task types. You may use  to delete an existing ad hoc task type.
Source Zone	Select the source zone from where the inventory is sourced.

Table 8–3 Putaway Strategy Details Window

Field	Description
Target Zone	Select the target zone to where the inventory is moved.
Container Type	Select the container type to be used to move the inventory from the source zone to the target zone. Typical values are Case and Pallet.
Task Type	Select the Putaway Task Type applicable to this putaway strategy. This field displays the list of existing ad hoc task types that belong to the 'PUTAWAY' activity group.



8.2.1.2 Creating a New Activity Constraint for Single SKU from an Existing Activity Constraint

To create a new activity constraint for single SKU from an existing activity constraint:

1. From the tree in the application rules side panel, choose VAS > Activities. The Activity Search window displays, with the list of activities.
2. Choose the Activity Code whose Activity Constraint is to be set up.
3. Choose . The Activity Constraints window displays.
4. In the Activity Constraints window, choose the Single-SKU tab. The Single-SKU tab window for Activity Constraints displays.
5. In the Single-SKU tab window, choose the activity constraint that is to be copied from.
6. Choose . The Activity Constraint Details window displays.
7. Enter information in the applicable fields. Refer [Table 8–2](#) for field value descriptions.
8. Choose .



8.2.1.3 Modifying an Activity Constraint for Single SKU

To modify an activity constraint for single SKU:

1. From the tree in the application rules side panel, choose VAS > Activities. The Activity Search window displays, with the list of activities.
2. Choose the Activity Code whose Activity Constraint is to be set up.
3. Choose . The Activity Constraints window displays.
4. In the Activity Constraints window, choose the Single-SKU tab. The Single-SKU tab window for Activity Constraints displays.
5. In the Single-SKU tab window, choose the activity constraint that is to be modified.
6. Choose . The Activity Constraint Details window displays.
7. Enter information in the applicable fields. Refer [Table 8–2](#) for field value descriptions.
8. Choose .

8.2.1.4 Deleting an Activity Constraint for Single SKU

To delete an activity constraint for single SKU:

1. From the tree in the application rules side panel, choose VAS > Activities. The Activity Search window displays, with the list of activities.
2. Choose the Activity Code whose Activity Constraint is to be set up.
3. Choose . The Activity Constraints window displays.
4. In the Activity Constraints window, choose the Single-SKU tab. The Single-SKU tab window for Activity Constraints displays.
5. In the Single-SKU tab window, choose the activity constraint that is to be deleted.
6. Choose .

8.2.2 Setting Up Activity Constraints for Containers

The constraints for the activity of a multi-SKU case or pallet are specified here. This also applies to multi-SKU CASE with LPN and PALLET with LPN.

Use the Activity Constraints for Containers set-up for:

- [Creating an Activity Constraint for Containers](#)

- [Modifying an Activity Constraint for Containers](#)
- [Deleting an Activity Constraint for Containers](#)

8.2.2.1 Creating an Activity Constraint for Containers

To create an activity constraint for Containers:

1. From the tree in the application rules side panel, choose VAS > Activities. The Activity Search window displays, with the list of activities.
2. Choose the Activity Code whose Activity Constraint is to be set up.
3. Choose . The Activity Constraints window displays.
4. In the Activity Constraints window, choose the Container tab. The Container tab window for Activity Constraints displays.

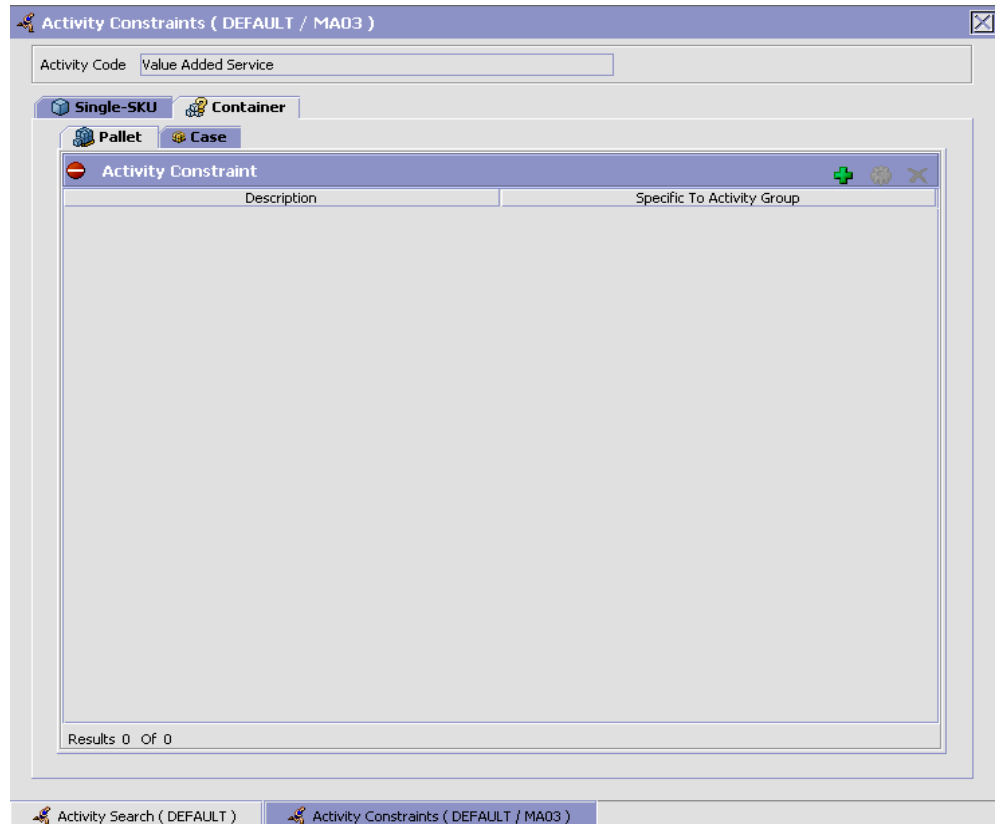



Activity Constraints for Pallets and Cases are specified separately:

- [Setting Up Activity Constraints for Pallets](#)
- [The Applicable Putaway Strategies window is displayed.](#)

8.2.2.1.1 Setting Up Activity Constraints for Pallets

To set up activity constraints for pallets:

1. In the Container tab of Activity Constraints window, choose the Pallet tab. The Pallet tab window displays.
2. In the Pallet tab window, choose .
3. The Activity Constraint Details window displays.

4. Enter information in the applicable fields. Refer [Table 8–4](#) for field value descriptions.
5. Choose .

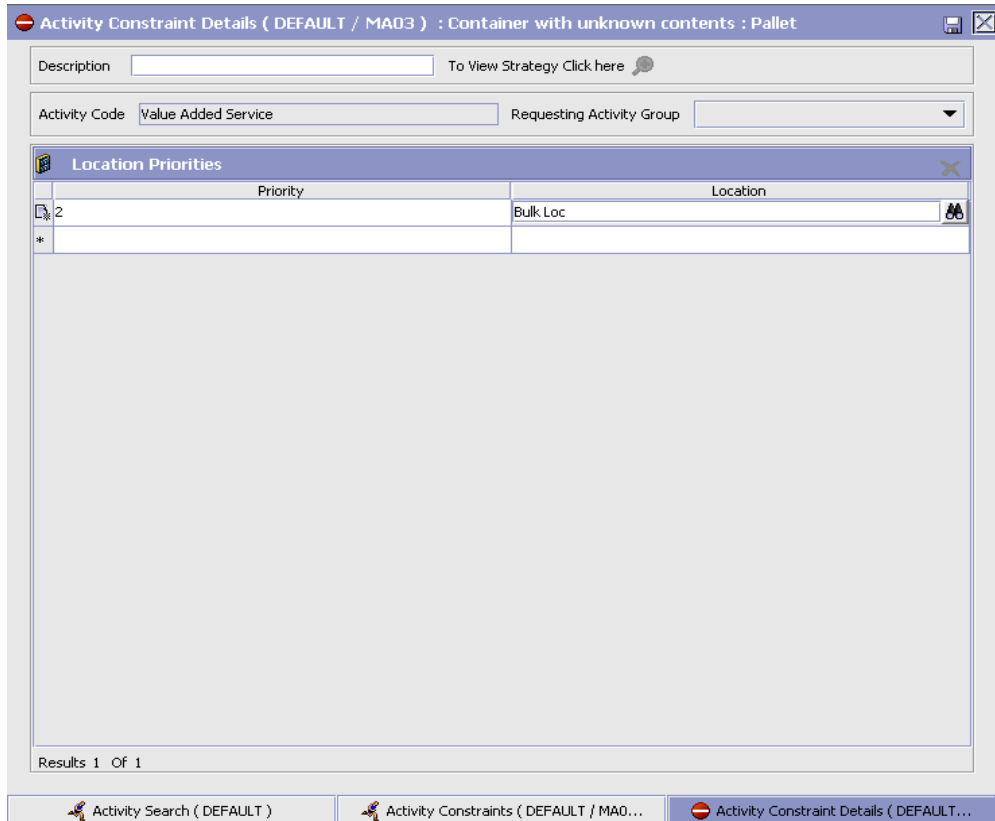



The screenshot shows a software window titled "Activity Constraint Details (DEFAULT / MA03) : Container with unknown contents : Pallet". The window contains several input fields and a table.

Fields include:

- Description: To View Strategy Click here 
- Activity Code:
- Requesting Activity Group:

The "Location Priorities" table is displayed below the fields:

	Priority	Location
 2		Bulk Loc 
*		

Results 1 Of 1

At the bottom, there are three tabs: "Activity Search (DEFAULT)", "Activity Constraints (DEFAULT / MA0...", and "Activity Constraint Details (DEFAULT..." (the last one is active).

Table 8–4 Activity Constraint Details - Pallet Tab

Field	Description
Description	Enter a description for the activity constraint.
To View Strategy Click here	Choose  to view or set up Putaway Strategy. For more details on setting up a putaway strategy see Setting Up Putaway Strategy for Multi-SKU/Multi-Level Containers - Pallets . Note: Putaway strategy may be specified for the putaway preferences after the preference is saved.
Activity Code	This indicates the activity code for the constraint.
Requesting Activity Group	Choose the requesting activity group. Typical values are Receipt, and Packing.
Location Priorities	
Priority	Enter a number to represent the priority. The priority is used to sequence the order in which the location priorities are evaluated. For example, all storage code level priorities are to be evaluated first before generic priorities. The priority needs to be a positive integer, greater than zero. This is a mandatory field.
Location	Choose the relevant location for the activity. This is a mandatory field.



Setting Up Putaway Strategy for Multi-SKU/Multi-Level Containers - Pallets

You can set up putaway strategies to putaway applicable inventory from a source zone to a target zone, based on the strategy specified.

To set up putaway strategy for multi-SKU/multi-level container pallets:

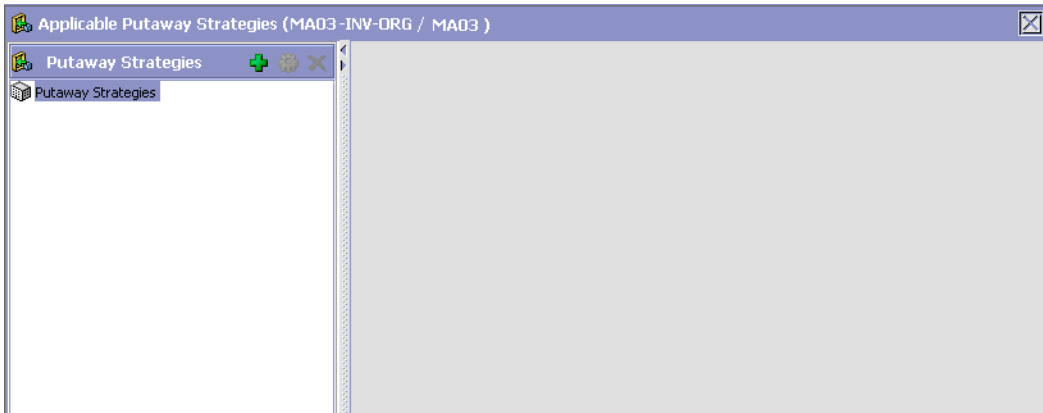
1. In the Activity Constraint Details : Multi-SKU/multi-level Containers : Pallet window, choose .
2. The Applicable Putaway Strategies window is displayed.



3. Choose  in the Putaway Strategies panel. The Putaway Strategy Details window appears in the right panel.
4. Enter information in the applicable fields. See the Putaway Strategy Details Window table for field value descriptions.
5. Choose .

The screenshot shows a software window titled "Putaway Strategy Details". It contains several input fields and two empty tables.

Putaway Strategy Details

Description: Strategy for DVD-LockAndKey-EACH UOM: CASE

Item Classification

Product Line: DVD

StorageType: LockAndKey

Product Line:

System Directed Putaway Task Types

	Source Zone	Target Zone	Container Type	Task Type
*				

Results 0 Of 0

Ad Hoc Task Types

	Source Zone	Target Zone	Container Type	Task Type
*				

Results 0 Of 0

Table 8–5 Putaway Strategy Details Window

Field	Description
Description	Enter a description for the Putaway Strategy.
UOM	Select the UOM for the Putaway Strategy, if applicable. Note: The UOM will be defaulted in instances where it has been specified in the Putaway Preference Details screen.

Table 8–5 Putaway Strategy Details Window



Field	Description
Item Classification	List of putaway item classifications for the Enterprise are displayed. An example, Product Line is shown below.
Product Line	Choose relevant product line item classification for the putaway activity. Choose  . In the Classification Values window, select the applicable product line classification.
System Directed Putaway Task Types	Displays the list of existing system directed putaway task types. You may use  to delete an existing system directed putaway task type.
Source Zone	Select the source zone from where the inventory is sourced.
Target Zone	Select the target zone to where the inventory is moved.
Container Type	Select the container type to be used to move the inventory from the source zone to the target zone. Typical values are Case and Pallet.
Task Type	Select the Putaway Task Type applicable to this putaway strategy. This field displays the list of existing system directed task types that belong to the 'PUTAWAY' activity group.
Ad hoc Task Types	Displays the list of existing ad hoc task types. You may use  to delete an existing ad hoc task type.
Source Zone	Select the source zone from where the inventory is sourced.
Target Zone	Select the target zone to where the inventory is moved.

Table 8–5 Putaway Strategy Details Window



Field	Description
Container Type	Select the container type to be used to move the inventory from the source zone to the target zone. Typical values are Case and Pallet.
Task Type	Select the Putaway Task Type applicable to this putaway strategy. This field displays the list of existing ad hoc task types that belong to the 'PUTAWAY' activity group.

8.2.2.1.2 Setting Up Activity Constraints for Cases

To set up activity constraints for cases:

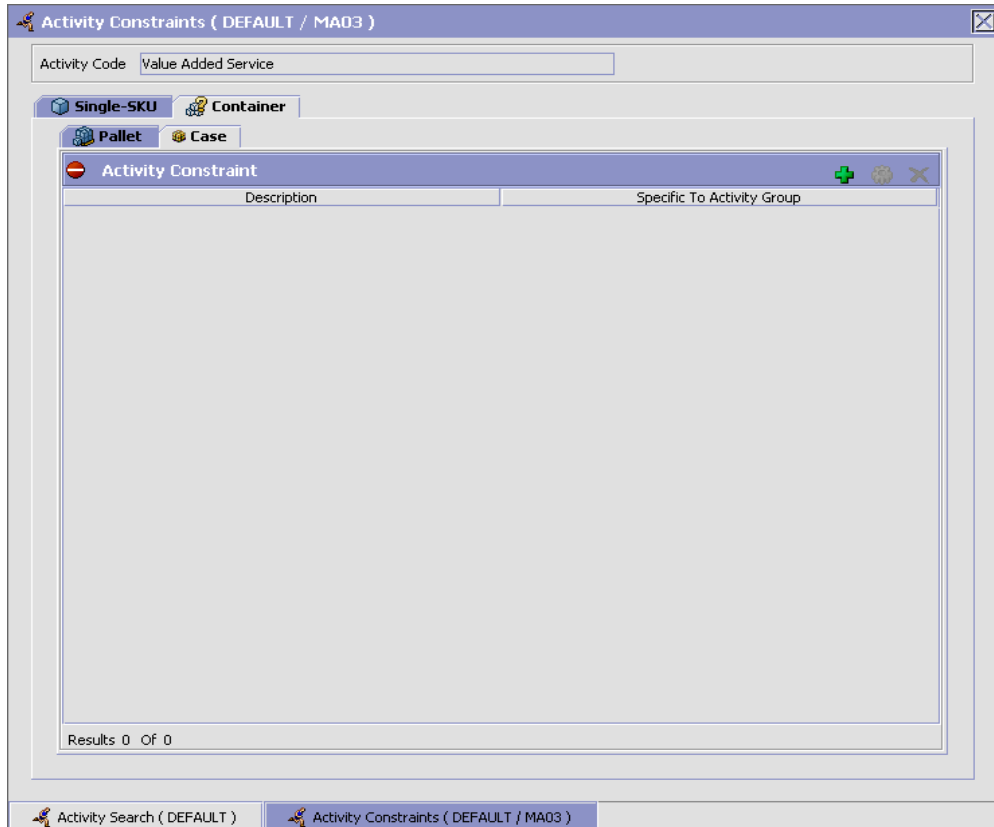
1. In the Container tab of Activity Constraints window, choose the Case tab. The Case tab window displays.



2. In the Case tab window, choose .
3. The Activity Constraint Details window displays.
4. Enter information in the applicable fields. Refer [Table 8–6](#) for field value descriptions.
5. Choose .

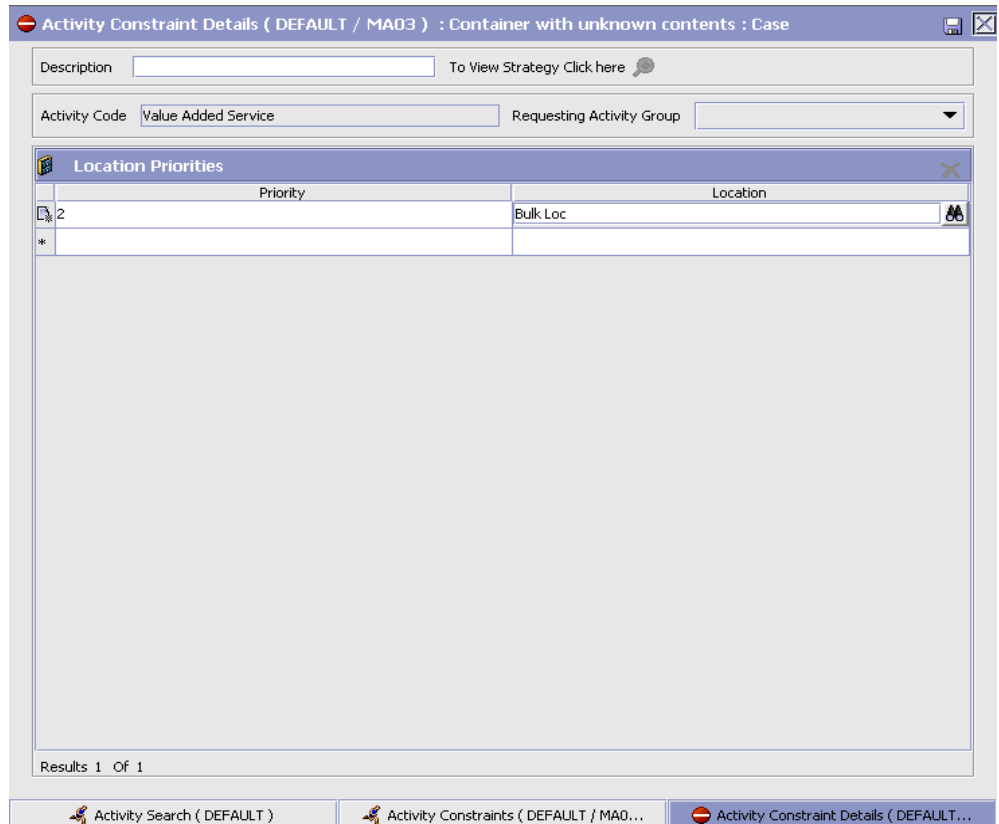

Table 8–6 Activity Constraint Details - Case Tab

Field	Description
Description	Enter a description for the activity constraint.
To View Strategy Click here	Choose  to view or set up Putaway Strategy. For more details on setting up a putaway strategy see Setting Up Putaway Strategy for Multi-SKU/Multi-Level Containers - Cases . Note: Putaway strategy may be specified for the putaway preferences after the preference is saved.
Activity Code	This indicates the activity code for the constraint.

Table 8–6 Activity Constraint Details - Case Tab

Field	Description
Requesting Activity Group	Choose the requesting activity group. Typical values are Receipt, and Packing.
Location Priorities	
Priority	Enter a number to represent the priority. The priority is used to sequence the order in which the location priorities are evaluated. For example, all storage code level priorities are to be evaluated first before generic priorities. The priority needs to be a positive integer, greater than zero. This is a mandatory field.
Location	Choose the relevant location for the activity. This is a mandatory field.

Setting Up Putaway Strategy for Multi-SKU/Multi-Level Containers - Cases

You can set up putaway strategies to putaway applicable inventory from a source zone to a target zone, based on the strategy specified.

To set up putaway strategy for multi-SKU/multi-level container cases:

1. In the Activity Constraint Details : Multi-SKU/multi-level Containers : Case window, choose .
2. The Applicable Putaway Strategies window is displayed.

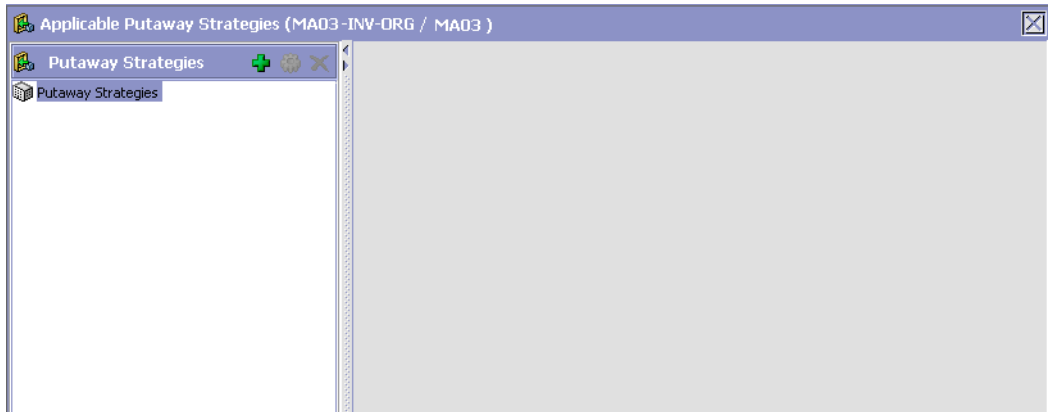



3. Choose  in the Putaway Strategies panel. The Putaway Strategy Details window appears in the right panel.
4. Enter information in the applicable fields. See the Putaway Strategy Details Window table for field value descriptions.
5. Choose .

Table 8–7 Putaway Strategy Details Window

Field	Description
Description	Enter a description for the Putaway Strategy.
UOM	Select the UOM for the Putaway Strategy, if applicable. Note: The UOM will be defaulted in instances where it has been specified in the Putaway Preference Details screen.

Table 8–7 Putaway Strategy Details Window







Field	Description
Item Classification	List of putaway item classifications for the Enterprise are displayed. An example, Product Line is shown below.
Product Line	Choose relevant product line item classification for the putaway activity. Choose  . In the Classification Values window, select the applicable product line classification.
System Directed Putaway Task Types	Displays the list of existing system directed putaway task types. You may use  to delete an existing system directed putaway task type.
Source Zone	Select the source zone from where the inventory is sourced.
Target Zone	Select the target zone to where the inventory is moved.
Container Type	Select the container type to be used to move the inventory from the source zone to the target zone. Typical values are Case and Pallet.
Task Type	Select the Putaway Task Type applicable to this putaway strategy. This field displays the list of existing system directed task types that belong to the 'PUTAWAY' activity group.
Ad hoc Task Types	Displays the list of existing ad hoc task types. You may use  to delete an existing ad hoc task type.
Source Zone	Select the source zone from where the inventory is sourced.
Target Zone	Select the target zone to where the inventory is moved.

Table 8–7 Putaway Strategy Details Window

Field	Description
Container Type	Select the container type to be used to move the inventory from the source zone to the target zone. Typical values are Case and Pallet.
Task Type	Select the Putaway Task Type applicable to this putaway strategy. This field displays the list of existing ad hoc task types that belong to the 'PUTAWAY' activity group.

8.2.2.2 Modifying an Activity Constraint for Containers



To modify an activity constraint for containers:

1. From the tree in the application rules side panel, choose VAS > Activities. The Activity Search window displays, with the list of activities.
2. Choose the Activity Code whose Activity Constraint is to be set up.
3. Choose . The Activity Constraints window displays.
4. In the Activity Constraints window, choose the Container tab. The Container tab window for Activity Constraints displays.
5. In the Container tab window, choose the activity constraint that is to be modified.
6. Choose . The Activity Constraint Details window displays.
7. Enter information in the applicable fields. For more information about modifying the fields, see [Section 8.2.2.1.1, "Setting Up Activity Constraints for Pallets"](#) on page 629 and [Section 2, "The Applicable Putaway Strategies window is displayed."](#) on page 631.
8. Choose .

8.2.2.3 Deleting an Activity Constraint for Containers

To delete an activity constraint for containers:

1. From the tree in the application rules side panel, choose VAS > Activities. The Activity Search window displays, with the list of activities.
2. Choose the Activity Code whose Activity Constraint is to be set up.

3. Choose . The Activity Constraints window displays.
4. In the Activity Constraints window, choose the Container tab. The Container tab window for Activity Constraints displays.
5. In the Container tab window, choose the activity constraint that is to be deleted.
6. Choose .

8.3 Defining Retrieval Strategy

Retrieval Strategy defines the retrieval process to be followed when retrieving items for VAS. This is defined at the 'VAS' activity group level.

For example, requests created for retrieval of components for a work order specifying a location or zone to be retrieved to.

Note: It is recommended that Zones containing Locations of type VIRTUAL should not be selected, while configuring the Putaway Preferences and Retrieval Strategy.

Use Retrieval Strategy for:



- [Creating a Retrieval Strategy](#)
- [Modifying a Retrieval Strategy](#)
- [Deleting a Retrieval Strategy](#)

8.3.1 Creating a Retrieval Strategy

To create a retrieval strategy:

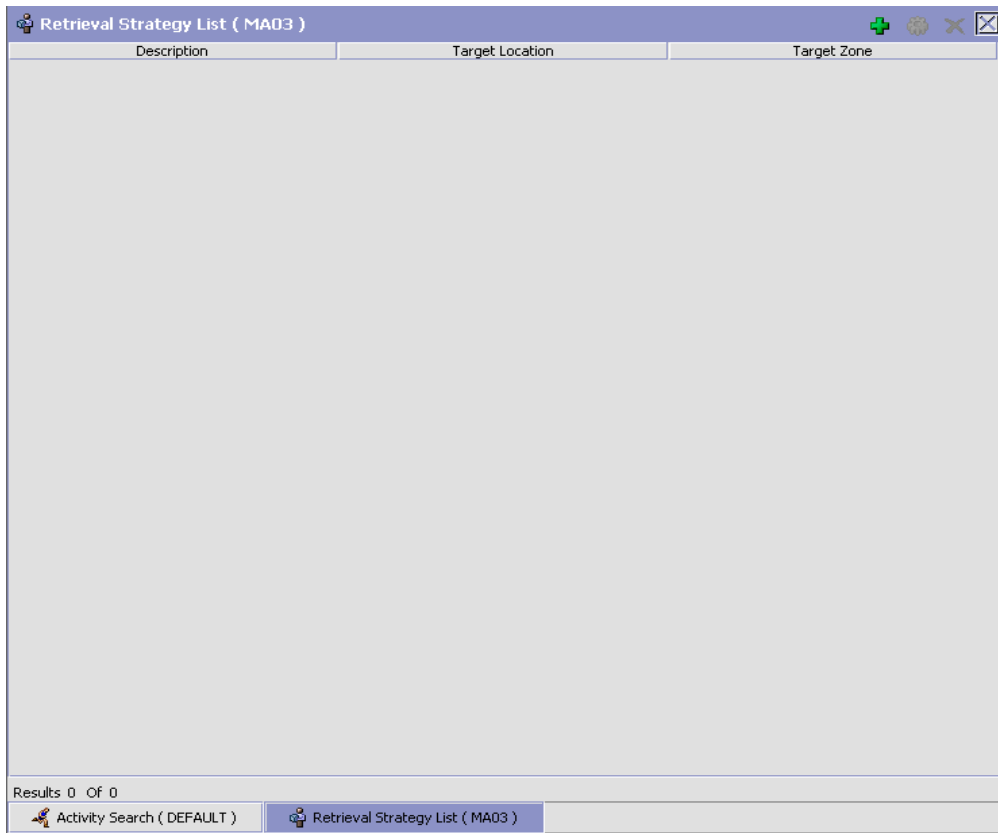
1. From the tree in the application rules side panel, choose VAS > Activities. The Activity Search window displays, with the list of activities.
2. In the top right corner, choose . The Retrieval Strategy List window displays.



3. In the Retrieval Strategy List window, choose . The Retrieval Strategy Details window displays.
4. Enter information in the applicable fields. Refer [Table 8–8](#) for field value descriptions.
5. Choose .

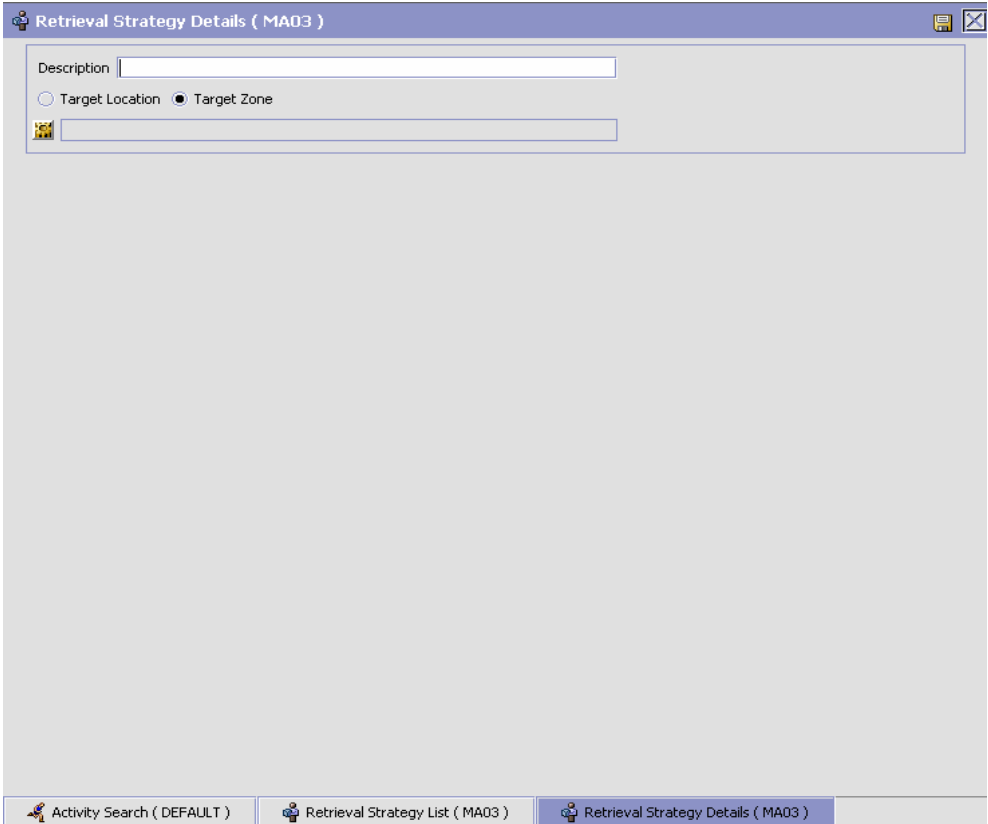

Table 8–8 Retrieval Strategy Details Window

Field	Description
Description	Enter a description for the retrieval strategy.

Table 8–8 Retrieval Strategy Details Window

Field	Description
Target Location	<p>Select if inventory is being retrieved to a specific location. For example, in retrieval for inspection strategy, inventory is retrieved to the Packing location in a warehouse.</p> <p>For more information about defining a target location, see Section 8.3.1.1, "Defining Target Location for Retrieval Strategy" on page 646.</p>
Target Zone	<p>Select if inventory is being retrieved to any location in a particular zone. For example, in retrieval for receiving strategy, inventory is retrieved to the dock zone in a warehouse.</p> <p>For more information about defining a target location, see Section 8.3.1.2, "Defining Target Zone for Retrieval Strategy" on page 647.</p>

8.3.1.1 Defining Target Location for Retrieval Strategy

To define a target location for the retrieval strategy:

1. In the Retrieval Strategy Details window, select 'Target Location'.
2. Choose . The List of Values pop-up window displays.
3. Enter information in the applicable fields. Refer [Table 8–9](#) for field value descriptions.
4. Choose OK.

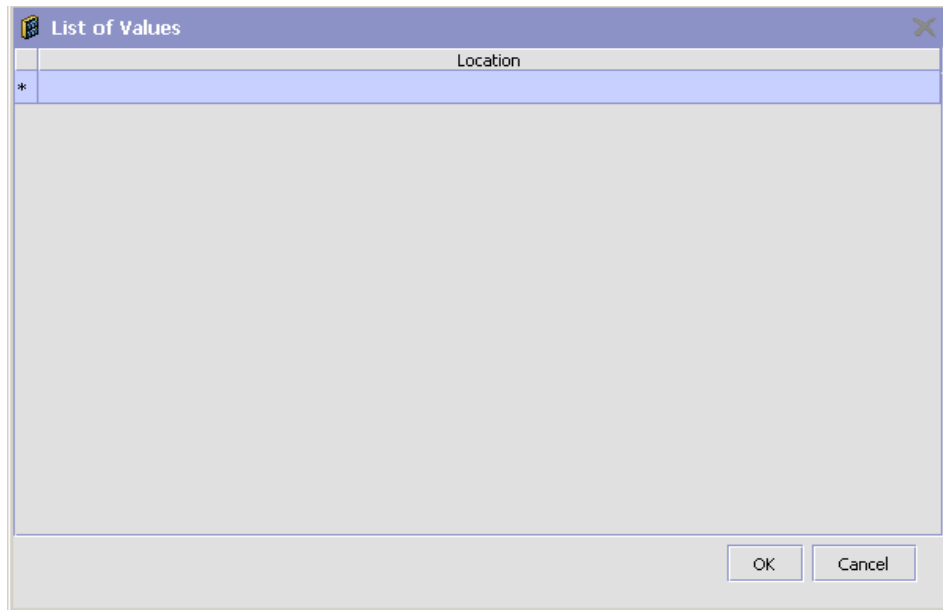



Table 8–9 *List of Values Pop-up Window*

Field	Description
Location	Choose the appropriate location for retrieval strategy.

8.3.1.2 Defining Target Zone for Retrieval Strategy

To define a target zone for the retrieval strategy:

1. In the Retrieval Strategy Details window, select 'Target Zone'.
2. Choose . The List of Values pop-up window displays.
3. Enter information in the applicable fields. Refer [Table 8–10](#) for field value descriptions.
4. Choose OK.

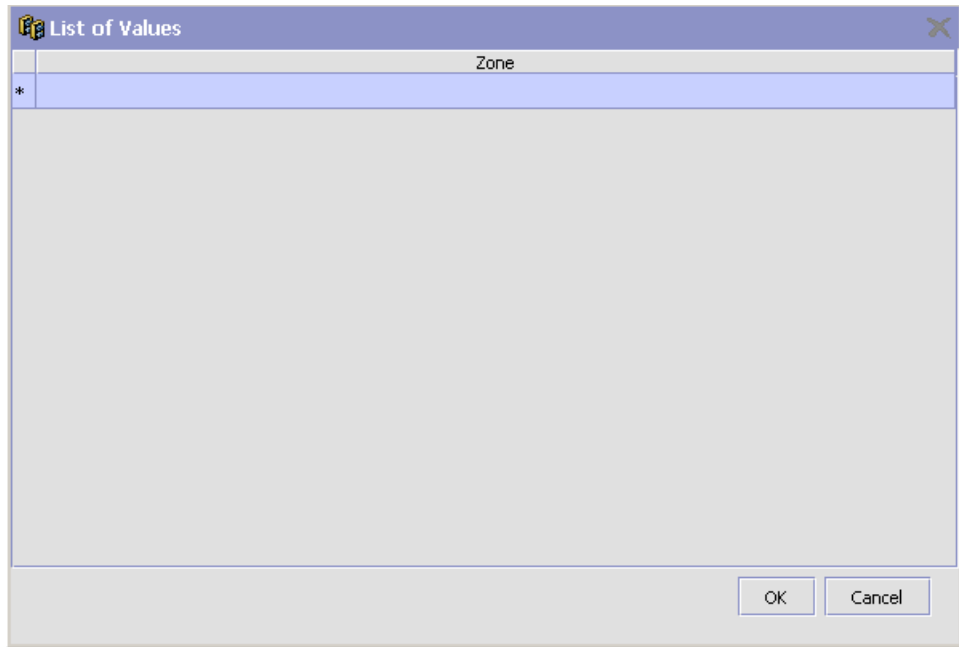

Table 8–10 *List of Values Pop-up Window*

Field	Description
Zone	Choose the appropriate zone for retrieval strategy.

8.3.1.2.1 Defining Pick Location Assignment

Pick Location Assignment (PLA) assigns the warehouse location(s) to the demand placed. PLA defines the list of zones to use for picking by specifying for a combination of item level attributes, such as classifications and unit of measure. Multiple PLA rules may be specified to ensure that the zone level constraints are unique to the item classification and unit of measure combination. For example, for SKUs stocked in pallets, cases and loose units, it is advisable to have 3 distinct rules to cover zones that are applicable for each unit of measure. The locations to be used in the zone can be filtered further by considering the least travel or pick-to-clean constraints.

After creating a Retrieval Strategy, you can define the Pick Location Assignment for the Retrieval Strategy.

To define pick location assignment:

1. On saving the Retrieval Strategy, the Pick Location panel displays in the Retrieval Strategy Details window.

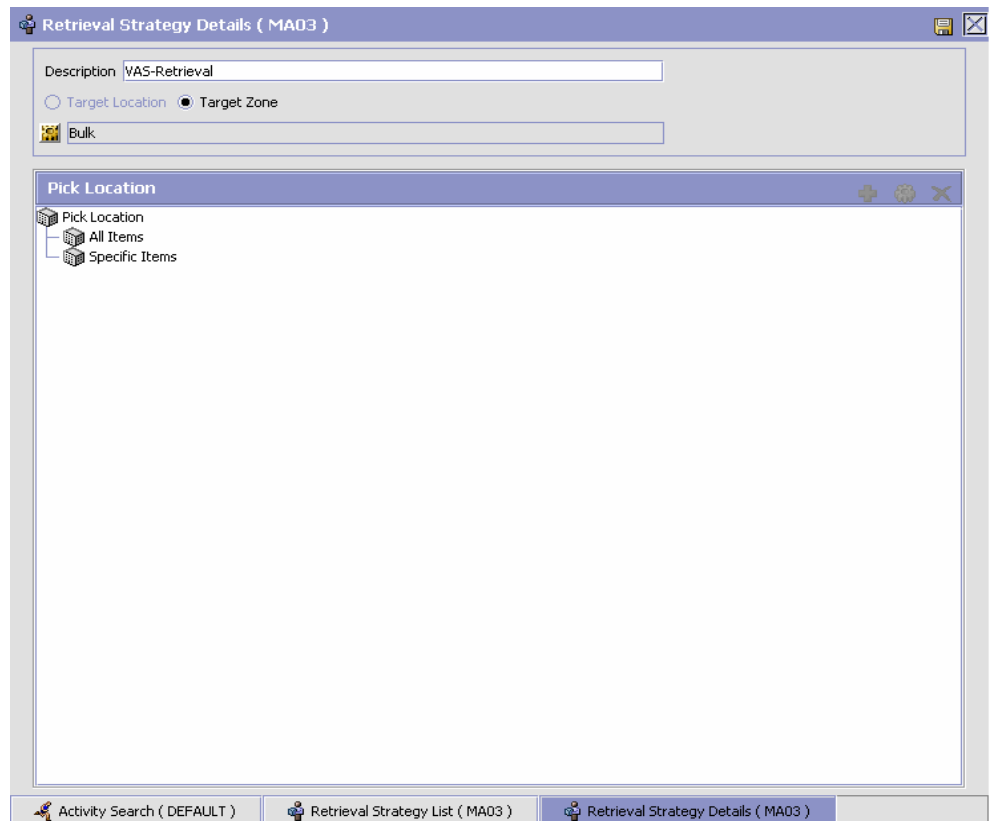



2. You can set up Pick Location Assignment for All Items or for Specific Items.

Assigning Pick Location Rules for All Items

You can define global PLA rules for all items in a warehouse based on unit of measure.

To assign pick location rules for all items:

1. From the Pick Location tree in the Pick Location panel in the Retrieval Strategy Details window, select All Items.
2. Choose . The UOM Condition pop-up window displays.
3. Enter information in the applicable fields. Refer to [Table 8–11](#) for field value descriptions.
4. Choose .

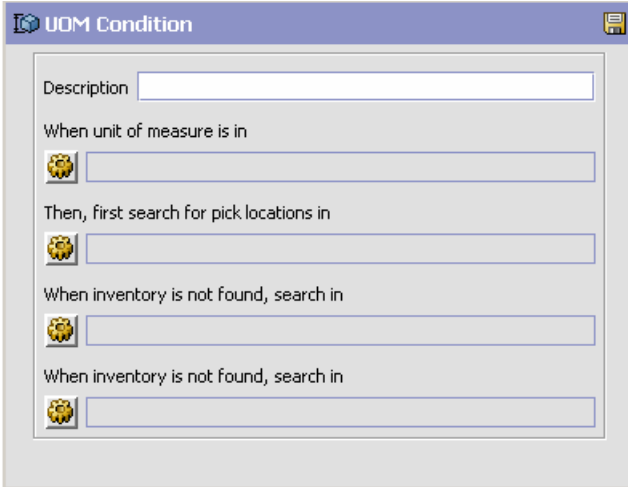

The screenshot shows a dialog box titled "UOM Condition". It contains the following fields:





- Description:
- When unit of measure is in: 
- Then, first search for pick locations in: 
- When inventory is not found, search in: 
- When inventory is not found, search in: 

Table 8–11 UOM Condition Pop-Up Window





Field	Description
Description	Enter a brief description of the unit of measure condition.
When Unit of Measure is in	<p>You must specify the unit(s) of measure for which this condition is based. The system uses the pick location parameters that you specify to generate pick plans for items of the unit(s) of measure you select.</p> <p>Choose . The List of Values pop-up window displays. Select the blank line and choose a unit of measure from the drop-down menu. When you have finished adding units of measure, choose OK.</p>
Then First search for pick locations in	<p>You must specify the pick location parameters to be used initially.</p> <p>Choose . The Pick Location Assignment pop-up window displays. See The Pick Location Assignment Pop-Up Window for field level descriptions.</p> <p>When you have finished defining pick location parameters, choose OK.</p>

Table 8–11 UOM Condition Pop-Up Window

Field	Description
When inventory is not found, search in	<p>You can define pick location parameters to be used if inventory is not found using the initial parameters.</p> <p>Choose . The Pick Location Assignment pop-up window displays. See The Pick Location Assignment Pop-Up Window for field level descriptions.</p> <p>When you have finished defining pick location parameters, choose OK.</p>
When inventory is not found, search in	<p>You can define pick location parameters to be used if inventory is not found using the second set of parameters.</p> <p>Choose . The Pick Location Assignment pop-up window displays. See The Pick Location Assignment Pop-Up Window for field level descriptions.</p> <p>When you have finished defining pick location parameters, choose OK.</p>

The Pick Location Assignment Pop-Up Window

The Pick Location Assignment pop-up window is used to set the parameters used to determine the location from which items are picked. Refer to [Table 8–12](#) for field value descriptions.

Pick Location Assignment Rule

Description: Retrieval

Location Selection

1. Locations with Inventory: Select locations having inventory from the following zones

 Select Inventory only when it is in one of the following status

 Optimize retrieval by: Pick to clean Least number of trips Pick Sequence
 Round up quantity in a trip when possible to:
 Case Each Half Pallet Inner Pack Pallet

2. Dedicated Locations: For the remaining demand, select dedicated location(s) from the zones listed above.
 For items without dedicated locations dynamically slot a location from the zones listed above.

3. Cross Dock Locations: For the demand left over from the previous steps, explore cross-docking opportunity.
 Search for inbound shipments that are in following status

Split Constraint
 Splitting is allowed for: Pallets and Cases Pallets but not Cases Neither Pallets nor Cases

Task Creation
 Task Type: Retrieval Task Type - 3

OK Cancel

Table 8–12 Pick Location Assignment Window

Field	Description
Description	Enter a brief description of the pick location assignment parameters.
Location Selection	
Locations with Inventory	When this pick location assignment is used, the system initially tries to find the optimal location to pick inventory based on the parameters you define below. When allocating inventory for the zones that have split constraints defined at either the PLA rule level or the zone level, the Sterling Warehouse Management System does not consider any existing pend in quantities.

Table 8–12 Pick Location Assignment Window

Field	Description
Select locations having inventory from the following zones	<p>You must specify the zones that you want to pick from when this pick location assignment is used.</p> <p>Choose . The List of Values pop-up window displays. Select the blank line and choose a zone from the drop-down menu. When you have finished adding zones, choose OK.</p>
Optimize retrieval by	<ul style="list-style-type: none"> • Choose Pick to Clean to fulfill the demand by emptying as many LPNs or locations as possible for optimal usage of space in a zone. • Choose Least Number of Trips to fulfill the demand from the least number of locations, to enable users to make least number of trips when retrieving inventory. When there is more than one way to make the same least number of trips, the 'PickToClean' process is followed within the 'LeastNumberOfTrips' process. • Choose Pick Sequence to pick from locations in the order of their pick sequence. The system chooses locations having lower pick sequence numbers over locations having higher pick sequence numbers.
Round up quantity in a trip when possible to	<p>Select the unit of measure to round up to when retrieving inventory for replenishment. The round up occurs only in instances when there is sufficient inventory.</p> <p>For example, there is an item that is picked by EACH that needs to be replenished. 9 EACH needs to be replenished. 12 EACH make a CASE. If you select Case for this field, the algorithm rounds the unit of measure for this retrieval task from 9 EACH to 1 CASE.</p>
Dedicated Locations	<p>For pick demand that exists after the 'Locations with Inventory' algorithm has been performed, the system looks for locations dedicated specifically for the inventory.</p>

Table 8–12 Pick Location Assignment Window



Field	Description
For the remaining demand, select dedicated location(s) from the zones listed above.	Select this field if you want any pick demand that was not fulfilled using the above parameters to be picked from dedicated locations in the zones you have specified for Locations with Inventory. By selecting this field the system uses replenishment to ensure that the dedicated location remains stocked with pickable inventory.
For items without dedicated locations, dynamically slot a location from the zones listed above.	Select this field if you want items that do not have a dedicated picking location to be dynamically slotted for picking. The location is dynamically slotted in the zones you have specified for Locations with Inventory.
Cross Dock Locations	For any remaining pick demand, you can define the inbound shipment status levels from which items can be cross-docked. Cross-docking allows you to retrieve inventory directly from receiving staging locations and bring the inventory to a dynamically slotted location for picking.
Search in inbound shipments that are in following status	<p>You can specify the inbound shipment statuses that you want to search for inventory. The system searches for inbound shipments in the specified status(es). Once the shipment is received the system diverts the inventory to the dynamically slotted location.</p> <p>Choose . The List of Values pop-up window displays. Select the blank line and choose an inbound shipment status from the drop-down menu. When you have finished adding inbound shipment statuses, choose OK.</p>
Split Constraint	
The system allows the user to break open an LPN for all zones specified in the PLA based on the option specified.	
If split constraints are defined at the zone and PLA rule levels, the system chooses the most restrictive constraint to ensure that constraints defined are not violated.	
Splitting is allowed for:	
Pallets and Cases	Choose this if you want to allow users to break open both pallets and cases.

Table 8–12 Pick Location Assignment Window

Field	Description
Pallets but not Cases	Choose this if you want to allow users to break open only pallets.
Neither Pallets nor Cases	Choose this if you do not want to allow users to break open pallets or cases.
Task Creation	
Task Type	Choose the applicable task type. Choose  to create a new task type. For more information about Task Type, see Section 12.3, "Defining Task Types" on page 885.

Note: For Dedicated Locations, Dynamic Slots, and Pick Fence, move request and replenish tasks are created. For Cross Dock Locations, move request and replenish task are NOT created, instead the Wave Release creates "Activity Demand".

Assigning Pick Location Rules for Specific Items

You can define PLA rules for items in a warehouse based on item classification and unit of measure.

To assign pick location for specific items:

1. From the Pick Location tree in the Pick Location panel in the Retrieval Strategy Details window, select Specific Items.
2. Choose . The Item Condition pop-up window displays.



The screenshot shows the 'Item Condition' configuration window. It includes the following fields and options:

- Description:** Text input field containing 'IC1'.
- Sequence #:** Text input field containing '1'.
- Enterprise Code:** Dropdown menu with 'DEFAULT' selected.
- Item Classification:** A section containing three rows:
 - Harmonized Code:** Text input field with a help icon.
 - UNSPSC:** Text input field with a help icon.
 - NMFC Code:** Text input field with a help icon.

3. In Description, enter a brief description of the item condition.
4. In Sequence #, enter the sequence number. Items are evaluated for the criteria you define. The sequence number determines the order by which item conditions evaluate items. Once an item matches up with a item condition's criteria, it uses the applicable pick location assignment algorithms.

Note: When an item is being requested for performing PLA, the item conditions are evaluated in a sequence. Once any of the conditions is evaluated as 'true', no more conditions are further evaluated. The evaluated condition is used for performing PLA.



5. From Enterprise Code, select the Enterprise you want to associate with the item condition.
6. In Item Classification, enter the applicable classification parameters as per your business practices. Fields used in Classifications are mapped to the Enterprise that you select for the item condition. For more information about configuring classifications, see the *Catalog Management: Configuration Guide*.

7. Choose .
8. From the Pick Location tree, select the item assignment you created and choose . The UOM Condition pop-up window displays.
9. Enter information in the applicable fields. Refer to [Table 8–11](#) for field value descriptions.
10. Choose .

8.3.2 Modifying a Retrieval Strategy



Once a Retrieval Strategy has been created, it can be modified.

To modify a retrieval strategy:

1. From the tree in the application rules side panel, choose VAS > Activities. The Activity Search window displays, with the list of activities.
2. In the top right corner, choose . The Retrieval Strategy List window displays with the list of Retrieval Strategies.
3. Choose the Retrieval Strategy to be modified. Choose . The Retrieval Strategy Details window displays.
4. Enter information in the applicable fields. Refer [Table 8–8](#) for field value descriptions.
5. Choose .

8.3.3 Deleting a Retrieval Strategy

To delete a retrieval strategy:

1. From the tree in the application rules side panel, choose VAS > Activities. The Activity Search window displays, with the list of activities.
2. In the top right corner, choose . The Retrieval Strategy List window displays with the list of Retrieval Strategies.
3. Choose the Retrieval Strategy to be deleted.
4. Choose .

8.4 Defining Putaway Preferences

Inventory being received at the dock require to be putaway to appropriate locations, based on shipment attributes, item classifications and location attributes.

The preferences for putting away of inventory is specified by zone and location storage attributes, for the SKU and container attributes.

Note: It is recommended that Zones containing Locations of type VIRTUAL should not be selected, while configuring the Putaway Preferences and Retrieval Strategy.

8.4.1 Selecting Putaway Preferences

The Sterling Warehouse Management System uses an algorithm to select the best storage or putaway preference for an activity from a list of preferences.

To select the best storage preference for an activity, the Sterling Warehouse Management System:

1. Determines if the inventory type is Single SKU, Multi SKU, or Unknown SKU.

If the inventory type is Single SKU, the system determines the corresponding UOM and item classification.

2. Determines the values of product class, inventory status, segment, or segment type for the inventory to match with the values configured in the storage preferences.
3. Sorts the matched values in the following order:
 - a. Enterprise Code
 - b. LPN Type
 - c. UOM
 - d. Product Class
 - e. Inventory Status
 - f. Segment Type

- g. Segment
- h. Item Classification 1
- i. Item Classification 2
- j. Item Classification 3

The best matched storage preference is used for the activity.

Use Putaway Preferences for:

- [Setting Up Putaway Preference for Single SKU](#)
- [Setting Up Putaway Preferences for Multiple SKU](#)
- [Setting Up Putaway Preferences for Container with Unknown Contents](#)

8.4.2 Setting Up Putaway Preference for Single SKU

The preferences for the putaway of a single SKU are specified here. This applies for all UOM of a SKU.

For example, the putaway strategy for a CASE, PALLET and loose quantity of a single SKU being putaway are specified here.

Use Putaway Preferences for Single SKU set-up for:

- [Creating a Putaway Preference for Single SKU](#)
- [The Applicable Putaway Strategies window is displayed.](#)
- [Modifying a Putaway Preference for Single SKU](#)
- [Deleting a Putaway Preference for Single SKU](#)



8.4.2.1 Creating a Putaway Preference for Single SKU

To create a putaway preference for single SKU:

1. From the tree in the application rules side panel, choose VAS > Activities. The Activity Search window displays, with the list of activities.
2. In the top right corner, choose . The Putaway Preferences window displays.

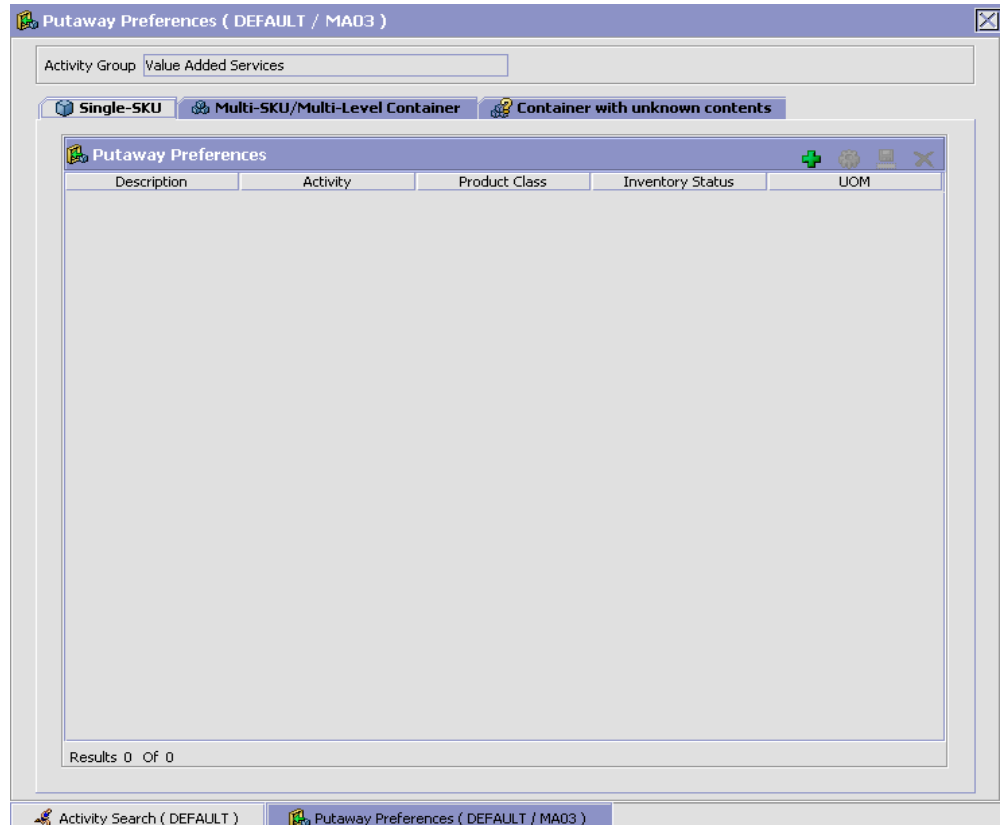
3. In the Putaway Preferences window, choose the Single-SKU tab. The Single-SKU tab window displays.



4. In the Single-SKU tab window, choose .
5. The Putaway Preference Details window displays.
6. Enter information in the applicable fields. Refer [Table 8–13](#) for field value descriptions.
7. Choose .

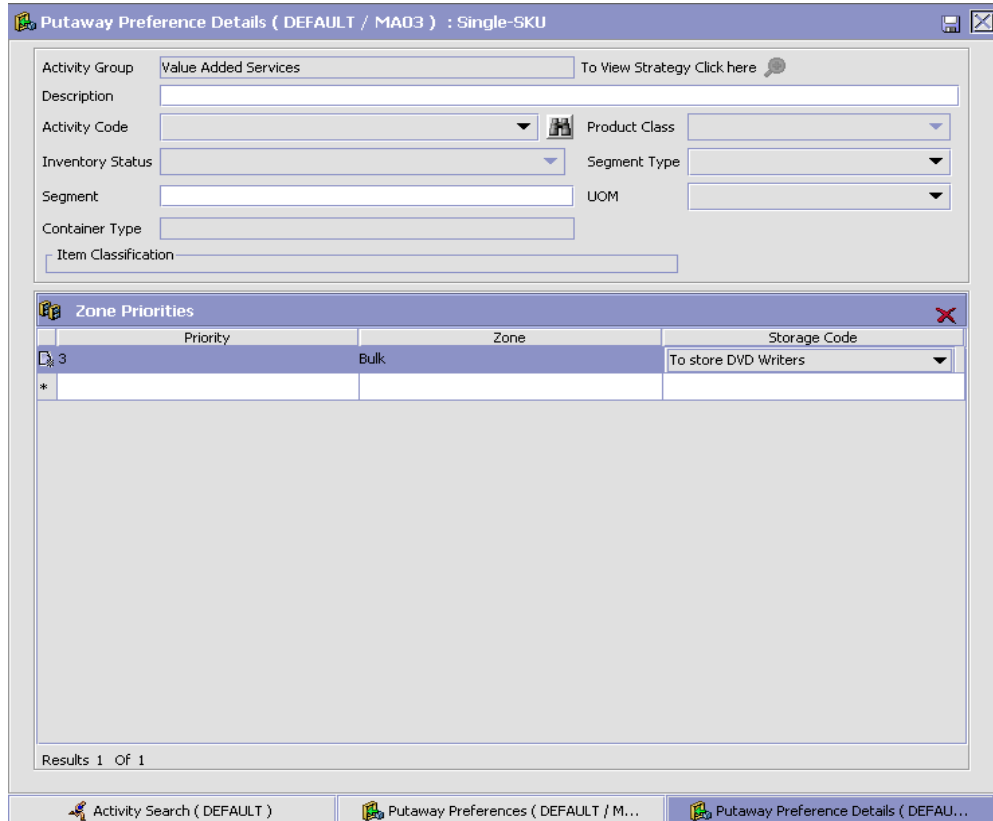

Table 8–13 Putaway Preference Details Window (Single SKU)

Field	Description
Activity Group	This is automatically populated by the system as 'Value Added Services'.
To View Strategy Click here	Choose  to view or set up Putaway Strategy. For more details on setting up a putaway strategy see Setting Up Putaway Strategy for Single-SKUs . Note: Putaway strategy may be specified for the putaway preferences after the preference is saved.
Description	Enter a brief description for the putaway preference.

Table 8–13 Putaway Preference Details Window (Single SKU)

Field	Description
Activity Code	Choose the Activity Code for the putaway preference. This is a mandatory field.
Product Class	Choose the product class for the preference, if applicable. Product class is the inventory classification of an item based on product's characteristics. Typical values are FQ - First Quality, SQ - Second Quality, etc.
Inventory Status	Choose the inventory status for the preference, if applicable. Inventory status refers to an inventory sub classification based on the results of the inventory control processes within the warehouse.
Segment Type	Enter the segment type for the preference, if applicable. This indicates an inventory category. Typical values are MTC – Made to Customer, and MTO - Made to Order.
Segment #	Enter the segment number for the preference, if applicable. A segment holds either the specific buyer or specific order number that requires dedication.
UOM	Choose the UOM for the preference, if applicable. UOM points to the Unit of measure of the item.
Container Type	The container type associated with the UOM selected displays. Typical values are "Pallet" and "Case".
Item Classification	List of putaway item classifications for the Enterprise display. An example, Product Line is shown below.
Product Line	Choose relevant product line item classification for the putaway activity. Choose  . In the Classification window, select the applicable product line classification.
Zone Priorities	

Table 8–13 Putaway Preference Details Window (Single SKU)

Field	Description
Priority	Enter a number to represent the priority. The priority is used to sequence the order in which the zone priorities are evaluated. For example, all storage code level priorities are to be evaluated first before generic priorities. The priority needs to be a positive integer, greater than zero. This is mandatory.
Zone	Choose the relevant zone for putaway. This is a mandatory field.
Storage Code	Choose the storage code for the zone, if applicable. This limits the locations being evaluated to the storage code specified. For example, putaway of hazardous items into a zone are restricted to the locations having the appropriate storage code.

Putaway strategy may be specified for the putaway preferences after the preference is saved. This is specified at an item classification and UOM level, if applicable.



Setting Up Putaway Strategy for Single-SKUs

You can set up putaway strategies to putaway applicable inventory from a source zone to a target zone, based on the strategy specified.

To set up putaway strategy for single-SKUs:

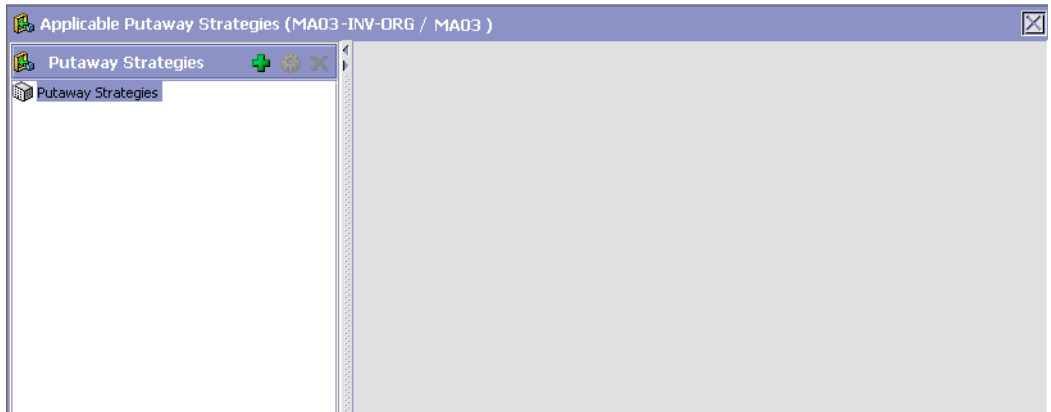
1. In the Putaway Preference Details : Single SKU window, choose .
2. The Applicable Putaway Strategies window is displayed.



3. Choose  in the Putaway Strategies panel. The Putaway Strategy Details window appears in the right panel.
4. Enter information in the applicable fields. See the Putaway Strategy Details Window table for field value descriptions.
5. Choose .

Putaway Strategy Details

Description: Strategy for DVD-LockAndKey-EACH UOM: CASE

Item Classification:

Product Line: DVD

StorageType: LockAndKey

Product Line:

System Directed Putaway Task Types

	Source Zone	Target Zone	Container Type	Task Type
*				

Results: 0 Of 0

Ad Hoc Task Types

	Source Zone	Target Zone	Container Type	Task Type
*				

Results: 0 Of 0

Table 8–14 Putaway Strategy Details Window

Field	Description
Description	Enter a description for the Putaway Strategy.
UOM	Select the UOM for the Putaway Strategy, if applicable. Note: The UOM will be defaulted in instances where it has been specified in the Putaway Preference Details screen.

Table 8–14 Putaway Strategy Details Window







Field	Description
Item Classification	List of putaway item classifications for the Enterprise are displayed. An example, Product Line is shown below.
Product Line	Choose relevant product line item classification for the putaway activity. Choose  . In the Classification Values window, select the applicable product line classification.
System Directed Putaway Task Types	Displays the list of existing system directed putaway task types. You may use  to delete an existing system directed putaway task type.
Source Zone	Select the source zone from where the inventory is sourced.
Target Zone	Select the target zone to where the inventory is moved.
Container Type	Select the container type to be used to move the inventory from the source zone to the target zone. Typical values are Case and Pallet.
Task Type	Select the Putaway Task Type applicable to this putaway strategy. This field displays the list of existing system directed task types that belong to the 'PUTAWAY' activity group.
Ad hoc Task Types	Displays the list of existing ad hoc task types. You may use  to delete an existing ad hoc task type.
Source Zone	Select the source zone from where the inventory is sourced.
Target Zone	Select the target zone to where the inventory is moved.

Table 8–14 Putaway Strategy Details Window

Field	Description
Container Type	Select the container type to be used to move the inventory from the source zone to the target zone. Typical values are Case and Pallet.
Task Type	Select the Putaway Task Type applicable to this putaway strategy. This field displays the list of existing ad hoc task types that belong to the 'PUTAWAY' activity group.

8.4.2.2 Creating a New Putaway Preference for Single SKU from an Existing Putaway Preference



To create a new putaway preference for single SKU from an existing putaway preference:

1. From the tree in the application rules side panel, choose VAS > Activities. The Activity Search window displays, with the list of activities.
2. In the top right corner, choose . The Putaway Preferences window displays.
3. In the Putaway Preferences window, choose the Single-SKU tab.
4. The Single-SKU tab window displays, with the list of putaway preferences.
5. Select the putaway preference to be copied from. Choose .
6. The Putaway Preference Details window displays.
7. Enter information in the applicable fields. Refer [Table 8–13](#) for field value descriptions.
8. Choose .

8.4.2.3 Modifying a Putaway Preference for Single SKU

Once a Putaway Preference for Single SKU has been created, it can be modified.



To modify a putaway preference for single SKU:

1. From the tree in the application rules side panel, choose VAS > Activities. The Activity Search window displays, with the list of activities.
2. In the top right corner, choose . The Putaway Preferences window displays.
3. In the Putaway Preferences window, choose the Single-SKU tab.
4. The Single-SKU tab window displays, with the list of putaway preferences.
5. Select the putaway preference to be modified. Choose .
6. The Putaway Preference Details window displays.
7. Enter information in the applicable fields. Refer [Table 8–13](#) for field value descriptions.
8. Choose .

Only the description and item classification values not previously used may be specified. Additional zone priorities may also be specified. For any other changes, the preference must be deleted.

8.4.2.4 Deleting a Putaway Preference for Single SKU

To delete a putaway preference for single SKU:

1. From the tree in the application rules side panel, choose VAS > Activities. The Activity Search window displays, with the list of activities.
2. In the top right corner, choose . The Putaway Preferences window displays.
3. In the Putaway Preferences window, choose the Single-SKU tab.
4. The Single-SKU tab window displays, with the list of putaway preferences.
5. Select the putaway preference to be deleted.
6. Choose .

8.4.3 Setting Up Putaway Preferences for Multiple SKU

The preferences for the putaway of a multi-SKU case or pallet, and multi-level LPNs are specified here. This also applies to multi-SKU CASE with LPN and PALLET with LPN.

Use the Putaway Preferences for Multiple SKU set-up for:

- [Creating a Putaway Preference for Multiple SKU](#)
- [Creating a New Putaway Preference for Multiple SKU from an Existing Putaway Preference](#)
- [Modifying a Putaway Preference for Multiple SKU](#)
- [Deleting a Putaway Preference for Multiple SKU](#)

8.4.3.1 Creating a Putaway Preference for Multiple SKU

To create a putaway preference for multiple SKU:

1. From the tree in the application rules side panel, choose VAS > Activities. The Activity Search window displays, with the list of activities.
2. In the top right corner, choose . The Putaway Preferences window displays.
3. In the Putaway Preferences window, choose the Multi-SKU/Multi-Level Container tab. The Multi-SKU/Multi-Level Container tab window displays.

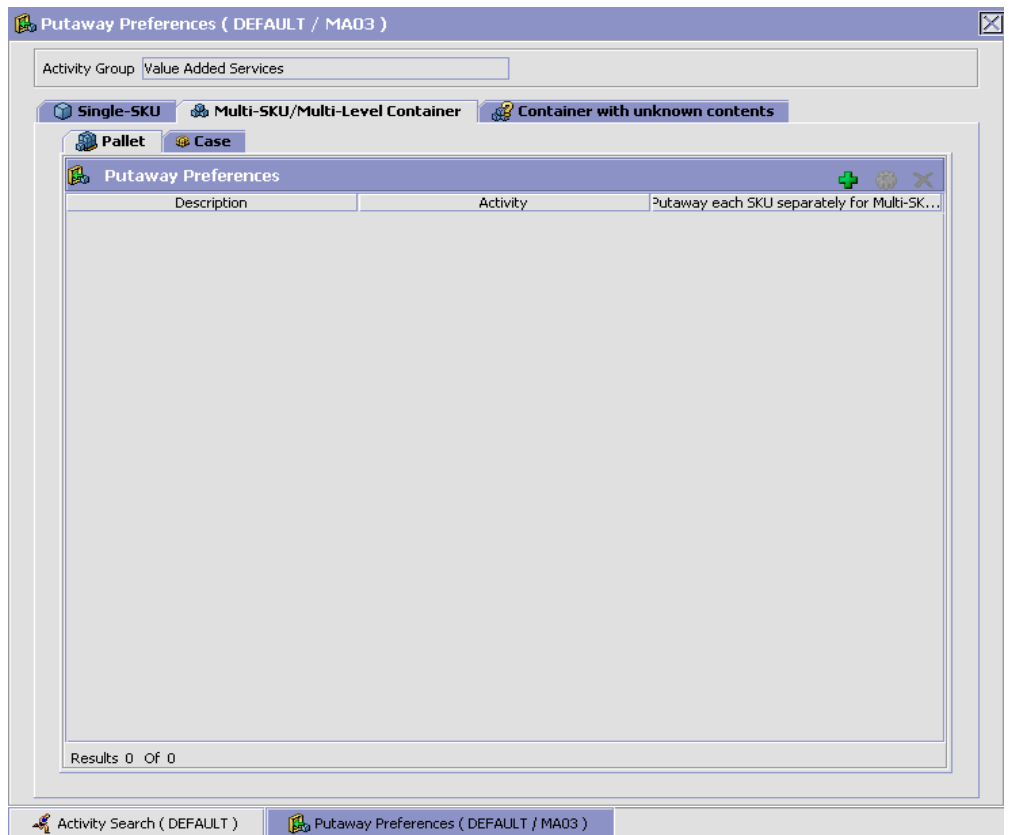



Putaway preferences for multi-SKU cases or pallets are specified separately:

- [Setting Up Putaway Preference for a Pallet](#)
- [Setting Up Putaway Preference for a Case](#)

8.4.3.1.1 Setting Up Putaway Preference for a Pallet

To set up putaway preference for a pallet:

1. In the Multi-SKU/Multi-Level Container tab of Putaway Preferences window, choose the Pallet tab. The Pallet tab window displays.
2. In the Pallet tab window, choose .

3. The Putaway Preference Details window displays.
4. Enter information in the applicable fields. Refer [Table 8–15](#) for field value descriptions.
5. Choose .

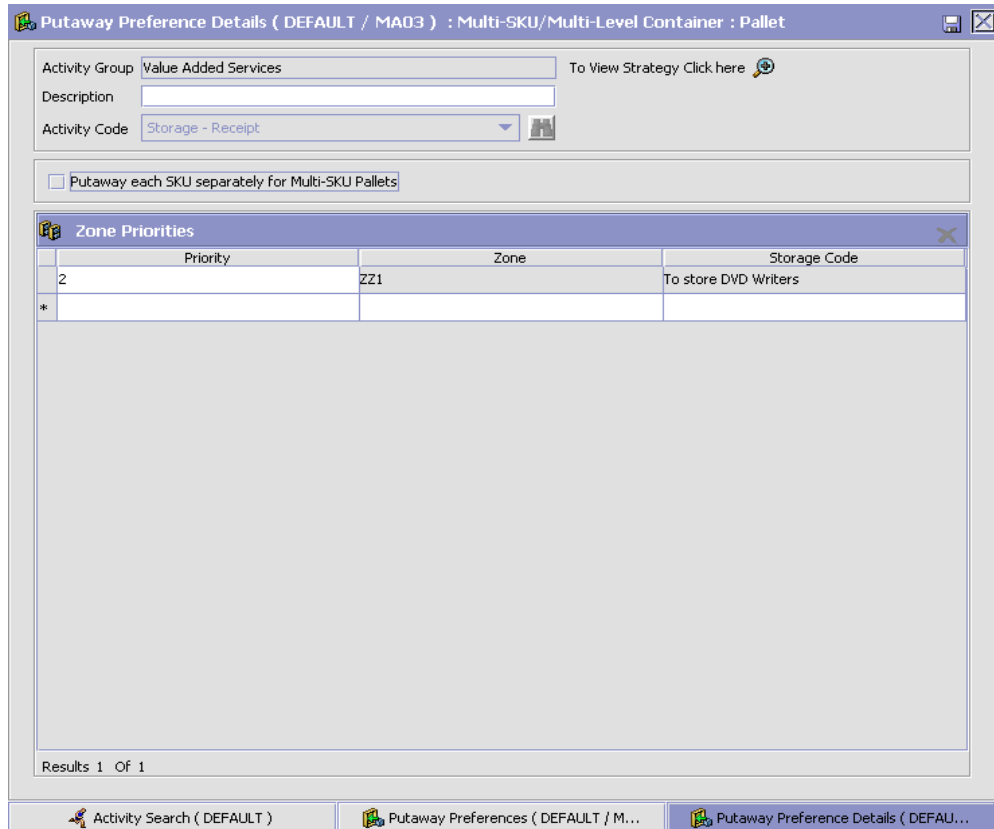

Putaway Preference Details (DEFAULT / MA03) : Multi-SKU/Multi-Level Container : Pallet

Activity Group Value Added Services To View Strategy Click here 

Description

Activity Code Storage - Receipt 

Putaway each SKU separately for Multi-SKU Pallets

Priority	Zone	Storage Code
2	ZZ1	To store DVD Writers
*		

Results 1 Of 1

Activity Search (DEFAULT) Putaway Preferences (DEFAULT / M... Putaway Preference Details (DEFAU...

Table 8–15 Putaway Preference Details Window (Multi-Level)

Field	Description
Activity Group	This is automatically populated by the system as 'Value Added Services'.
To View Strategy Click here	Choose  to view or set up Putaway Strategy. For more details on setting up a putaway strategy see Setting Up Putaway Strategy for Multi-SKU/Multi-Level Containers - Pallets . Note: Putaway strategy may be specified for the putaway preferences after the preference is saved.
Description	Enter a brief description for the putaway preference.
Activity Code	Choose the Activity Code for the putaway preference. This is a mandatory field.
Put away each SKU separately for Multi-SKU Pallets	Select if each SKU on the multi-SKU pallet is evaluated individually. If selected, the putaway preferences for a single SKU are evaluated for the multi-SKU pallet. The Zone Priorities Panel is removed on this selection.
Zone Priorities	
Priority	Enter a number to represent the priority. The priority is used to sequence the order in which the zone priorities are evaluated. For example, all storage code level priorities are to be evaluated first before generic priorities. The priority needs to be a positive integer, greater than zero. This is mandatory.
Zone	Choose the relevant zone for putaway. This is a mandatory field.
Storage Code	Choose the storage code for the zone, if applicable. This limits the locations being evaluated to the storage code specified. For example, putaway of hazardous items into a zone are restricted to the locations having the appropriate storage code.

Putaway strategy may be specified for the putaway preferences after the preference is saved. This is specified at an item classification and UOM level, if applicable.



Setting Up Putaway Strategy for Multi-SKU/Multi-Level Containers - Pallets

You can set up putaway strategies to putaway applicable inventory from a source zone to a target zone, based on the strategy specified.

To set up putaway strategy for multi-SKU/multi-level container pallets:

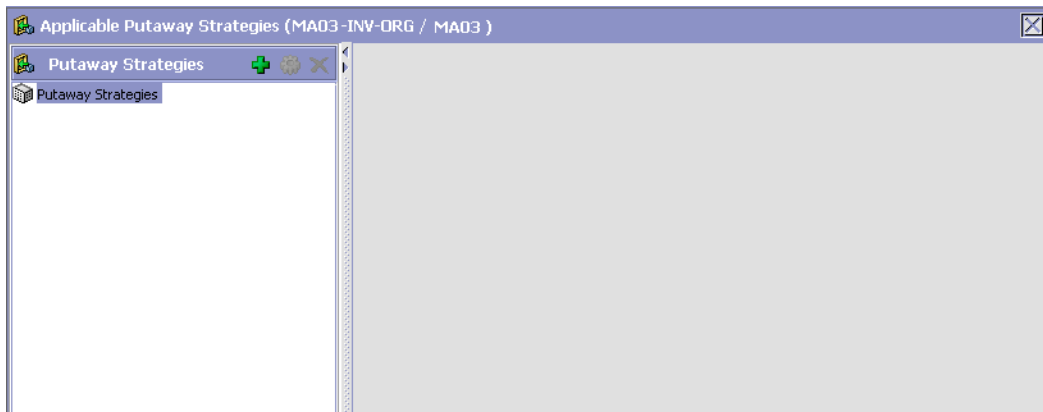
1. In the Putaway Preference Details : Multi-SKU/multi-level Containers : Pallet window, choose .
2. The Applicable Putaway Strategies window is displayed.



3. Choose  in the Putaway Strategies panel. The Putaway Strategy Details window appears in the right panel.
4. Enter information in the applicable fields. See the Putaway Strategy Details Window table for field value descriptions.
5. Choose .

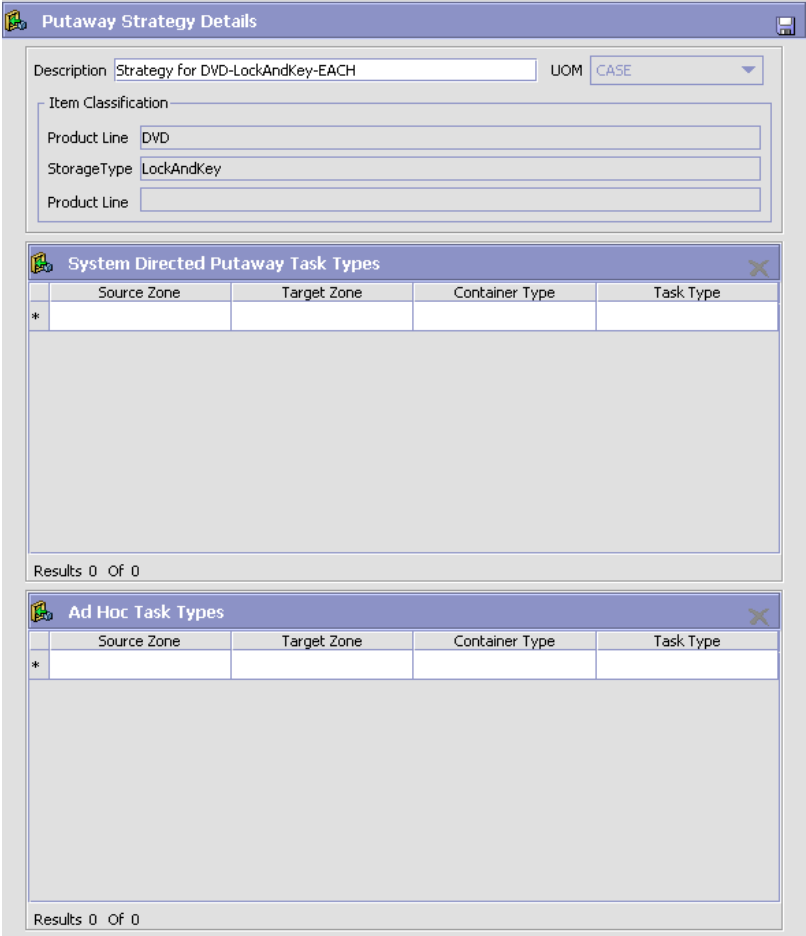

Table 8–16 Putaway Strategy Details Window

Field	Description
Description	Enter a description for the Putaway Strategy.
UOM	Select the UOM for the Putaway Strategy, if applicable. Note: The UOM will be defaulted in instances where it has been specified in the Putaway Preference Details screen.

Table 8–16 Putaway Strategy Details Window



Field	Description
Item Classification	List of putaway item classifications for the Enterprise are displayed. An example, Product Line is shown below.
Product Line	Choose relevant product line item classification for the putaway activity. Choose  . In the Classification Values window, select the applicable product line classification.
System Directed Putaway Task Types	Displays the list of existing system directed putaway task types. You may use  to delete an existing system directed putaway task type.
Source Zone	Select the source zone from where the inventory is sourced.
Target Zone	Select the target zone to where the inventory is moved.
Container Type	Select the container type to be used to move the inventory from the source zone to the target zone. Typical values are Case and Pallet.
Task Type	Select the Putaway Task Type applicable to this putaway strategy. This field displays the list of existing system directed task types that belong to the 'PUTAWAY' activity group.
Ad hoc Task Types	Displays the list of existing ad hoc task types. You may use  to delete an existing ad hoc task type.
Source Zone	Select the source zone from where the inventory is sourced.
Target Zone	Select the target zone to where the inventory is moved.

Table 8–16 Putaway Strategy Details Window



Field	Description
Container Type	Select the container type to be used to move the inventory from the source zone to the target zone. Typical values are Case and Pallet.
Task Type	Select the Putaway Task Type applicable to this putaway strategy. This field displays the list of existing ad hoc task types that belong to the 'PUTAWAY' activity group.

8.4.3.1.2 Setting Up Putaway Preference for a Case

To set up putaway preference for a case:

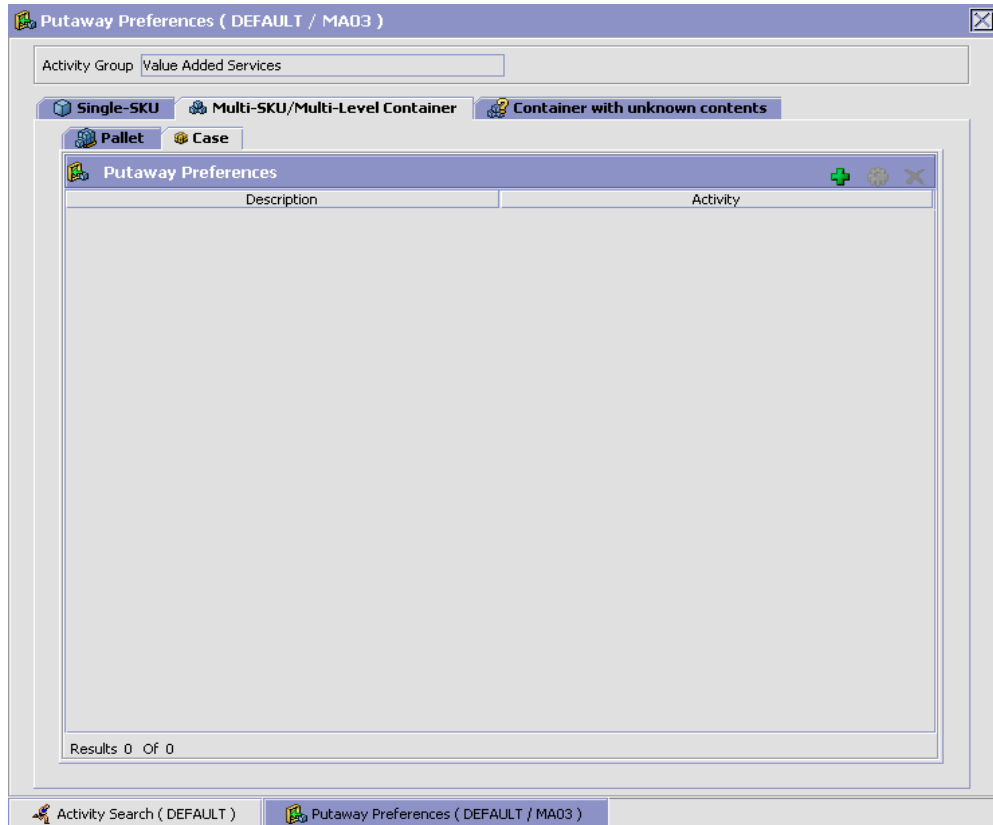
1. In the Multi-SKU/Multi-Level Container tab of Putaway Preferences window, choose the Case tab. The Case tab window displays.



2. In the Case tab window, choose .
3. The Putaway Preference Details window displays.
4. Enter information in the applicable fields. Refer [Table 8–17](#) for field value descriptions.
5. Choose .

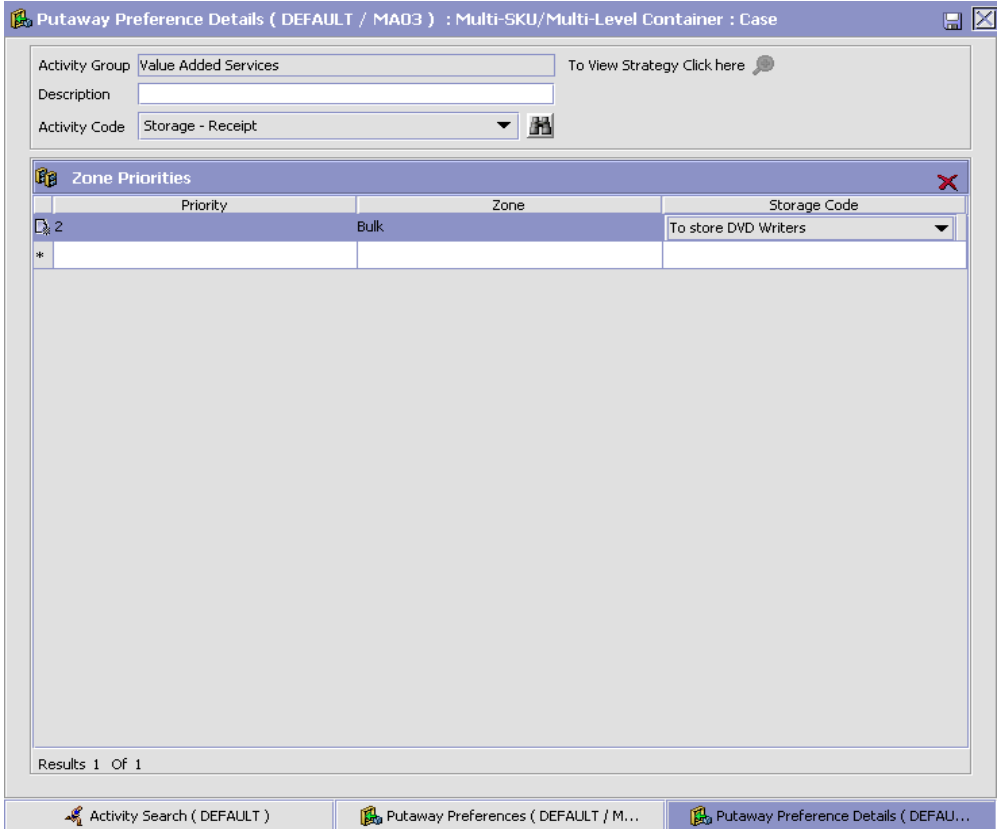

Table 8–17 Putaway Preference Details Window (Multi-Level Case)

Field	Description
Activity Group	This is automatically populated by the system as 'Value Added Services'.
To View Strategy Click here	Choose  to view or set up Putaway Strategy. For more details on setting up a putaway strategy see Setting Up Putaway Strategy for Multi-SKU/Multi-Level Containers - Cases . Note: Putaway strategy may be specified for the putaway preferences after the preference is saved.

Table 8–17 Putaway Preference Details Window (Multi-Level Case)

Field	Description
Description	Enter a brief description for the putaway preference.
Activity Code	Choose the Activity Code for the putaway preference. This is a mandatory field.
Zone Priorities	
Priority	Enter a number to represent the priority. The priority is used to sequence the order in which the zone priorities are evaluated. For example, all storage code level priorities are to be evaluated first before generic priorities. The priority needs to be a positive integer, greater than zero. This is mandatory.
Zone	Choose the relevant zone for putaway. This is a mandatory field.
Storage Code	Choose the storage code for the zone, if applicable. This limits the locations being evaluated to the storage code specified. For example, putaway of hazardous items into a zone are restricted to the locations having the appropriate storage code.

Putaway strategy may be specified for the putaway preferences after the preference is saved. This is specified at an item classification and UOM level, if applicable.

Setting Up Putaway Strategy for Multi-SKU/Multi-Level Containers - Cases

You can set up putaway strategies to putaway applicable inventory from a source zone to a target zone, based on the strategy specified.

To set up putaway strategy for multi-SKU/multi-level container cases:

1. In the Putaway Preference Details : Multi-SKU/multi-level Containers : Case window, choose .
2. The Applicable Putaway Strategies window is displayed.

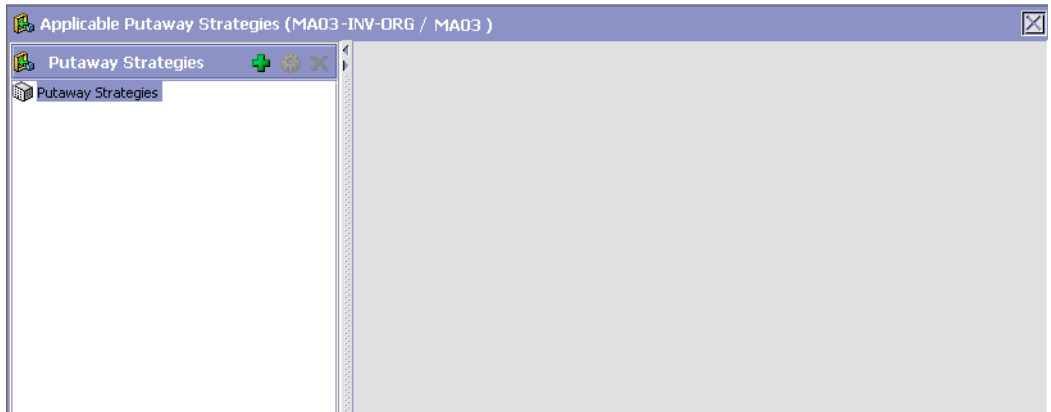



3. Choose  in the Putaway Strategies panel. The Putaway Strategy Details window appears in the right panel.
4. Enter information in the applicable fields. See the Putaway Strategy Details Window table for field value descriptions.
5. Choose .

Table 8–18 Putaway Strategy Details Window

Field	Description
Description	Enter a description for the Putaway Strategy.
UOM	Select the UOM for the Putaway Strategy, if applicable. Note: The UOM will be defaulted in instances where it has been specified in the Putaway Preference Details screen.

Table 8–18 Putaway Strategy Details Window







Field	Description
Item Classification	List of putaway item classifications for the Enterprise are displayed. An example, Product Line is shown below.
Product Line	Choose relevant product line item classification for the putaway activity. Choose  . In the Classification Values window, select the applicable product line classification.
System Directed Putaway Task Types	Displays the list of existing system directed putaway task types. You may use  to delete an existing system directed putaway task type.
Source Zone	Select the source zone from where the inventory is sourced.
Target Zone	Select the target zone to where the inventory is moved.
Container Type	Select the container type to be used to move the inventory from the source zone to the target zone. Typical values are Case and Pallet.
Task Type	Select the Putaway Task Type applicable to this putaway strategy. This field displays the list of existing system directed task types that belong to the 'PUTAWAY' activity group.
Ad hoc Task Types	Displays the list of existing ad hoc task types. You may use  to delete an existing ad hoc task type.
Source Zone	Select the source zone from where the inventory is sourced.
Target Zone	Select the target zone to where the inventory is moved.

Table 8–18 Putaway Strategy Details Window

Field	Description
Container Type	Select the container type to be used to move the inventory from the source zone to the target zone. Typical values are Case and Pallet.
Task Type	Select the Putaway Task Type applicable to this putaway strategy. This field displays the list of existing ad hoc task types that belong to the 'PUTAWAY' activity group.

8.4.3.2 Creating a New Putaway Preference for Multiple SKU from an Existing Putaway Preference



To create a new putaway preference for multiple SKU from an existing putaway preference:

1. From the tree in the application rules side panel, choose VAS > Activities. The Activity Search window displays, with the list of activities.
2. In the top right corner, choose . The Putaway Preferences window displays.
3. In the Putaway Preferences window, choose the Multi-SKU/Multi-Level Container tab.
4. The Multi-SKU/Multi-Level Container tab window displays, with the list of putaway preferences.
5. Select the putaway preference to be copied from. Choose .
6. The Putaway Preference Details window displays.
7. Enter information in the applicable fields. For more information about modifying the fields, refer to [Section 8.4.3.1.1, "Setting Up Putaway Preference for a Pallet"](#) on page 671 and [Section 8.4.3.1.2, "Setting Up Putaway Preference for a Case"](#) on page 677.
8. Choose .

8.4.3.3 Modifying a Putaway Preference for Multiple SKU

Once a Putaway Preference for Multiple SKU has been created, it can be modified.



To modify a putaway preference for multiple SKU:

1. From the tree in the application rules side panel, choose VAS > Activities. The Activity Search window displays, with the list of activities.
2. In the top right corner, choose . The Putaway Preferences window displays.
3. In the Putaway Preferences window, choose the Multi-SKU/Multi-Level Container tab.
4. The Multi-SKU/Multi-Level Container tab window displays, with the list of putaway preferences.
5. Select the putaway preference to be modified. Choose .
6. The Putaway Preference Details window displays.
7. Enter information in the applicable fields. For more information about modifying the fields, refer to [Section 8.4.3.1.1, "Setting Up Putaway Preference for a Pallet"](#) on page 671 and [Section 8.4.3.1.2, "Setting Up Putaway Preference for a Case"](#) on page 677.
8. Choose .

The activity code corresponding to the preference cannot be modified. The preference must be deleted and recreated.

8.4.3.4 Deleting a Putaway Preference for Multiple SKU

To delete a putaway preference for multiple SKU:

1. From the tree in the application rules side panel, choose VAS > Activities. The Activity Search window displays, with the list of activities.
2. In the top right corner, choose . The Putaway Preferences window displays.
3. In the Putaway Preferences window, choose the Multi-SKU/Multi-Level Container tab.
4. The Multi-SKU/Multi-Level Container tab window displays, with the list of putaway preferences.
5. Select the putaway preference to be deleted.
6. Choose .

8.4.4 Setting Up Putaway Preferences for Container with Unknown Contents

The preferences for the putaway of container with unknown contents are specified here. This applies to case and pallet with LPN where contents are not known.

For example, pre-receipt steps during receiving or returns where LPN labels may be scanned. Also, this applies to containers that are cross-docked to shipping lane upon receipt in merge in-transit centers.

Use Putaway Preferences for Container with Unknown Contents set-up for:

- [Creating a Putaway Preference for Container with Unknown Contents](#)
- [Creating a New Putaway Preference for Container with Unknown Contents from an Existing Putaway Preference](#)
- [Modifying a Putaway Preference for Container with Unknown Contents](#)
- [Deleting a Putaway Preference for Container with Unknown Contents](#)

8.4.4.1 Creating a Putaway Preference for Container with Unknown Contents

To create a putaway preference for container with unknown contents:

1. From the tree in the application rules side panel, choose VAS > Activities. The Activity Search window displays, with the list of activities.
2. In the top right corner, choose . The Putaway Preferences window displays.
3. In the Putaway Preferences window, choose the Container with Unknown Contents tab. The Container with Unknown Contents tab window displays.

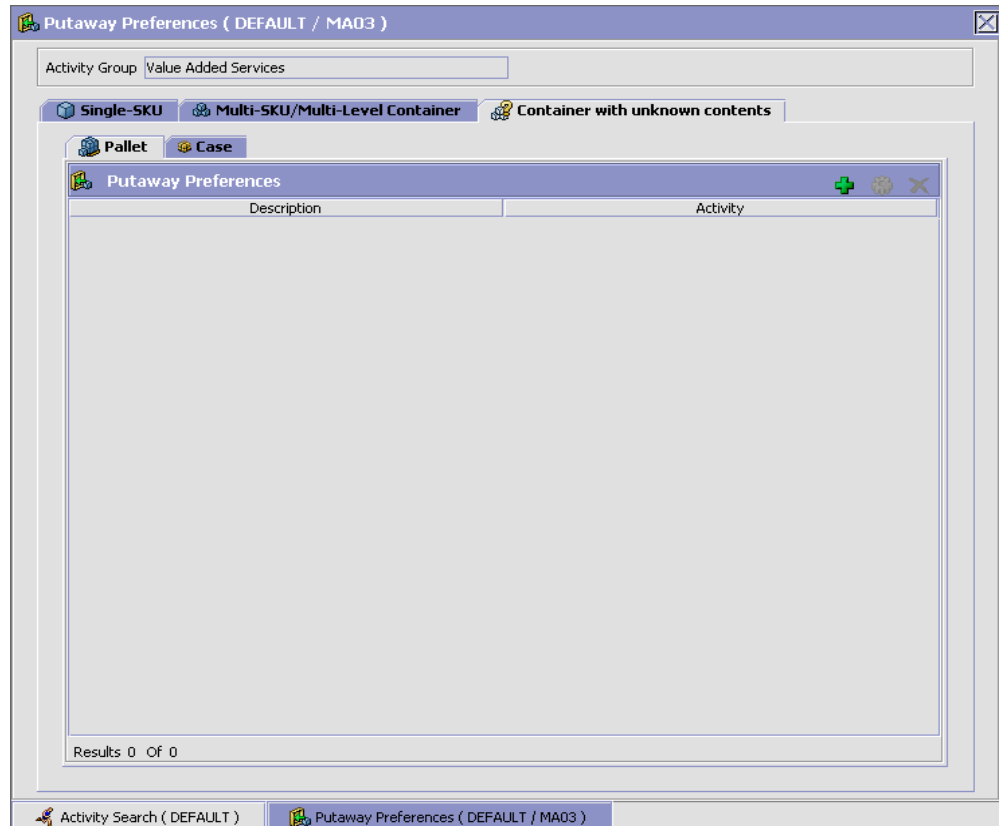



Putaway preferences are separately specified for a pallet and case:

- [Setting Up Putaway Preference for a Pallet](#)
- [Setting Up Putaway Preference for a Case](#)

8.4.4.1.1 Setting Up Putaway Preference for a Pallet

To set up putaway preference for a pallet:

1. In the Container with Unknown Contents tab of Putaway Preferences window, choose the Pallet tab. The Pallet tab window displays.
2. In the Pallet tab window, choose .
3. The Putaway Preference Details window displays.

4. Enter information in the applicable fields. Refer [Table 8–19](#) for field value descriptions.
5. Choose .

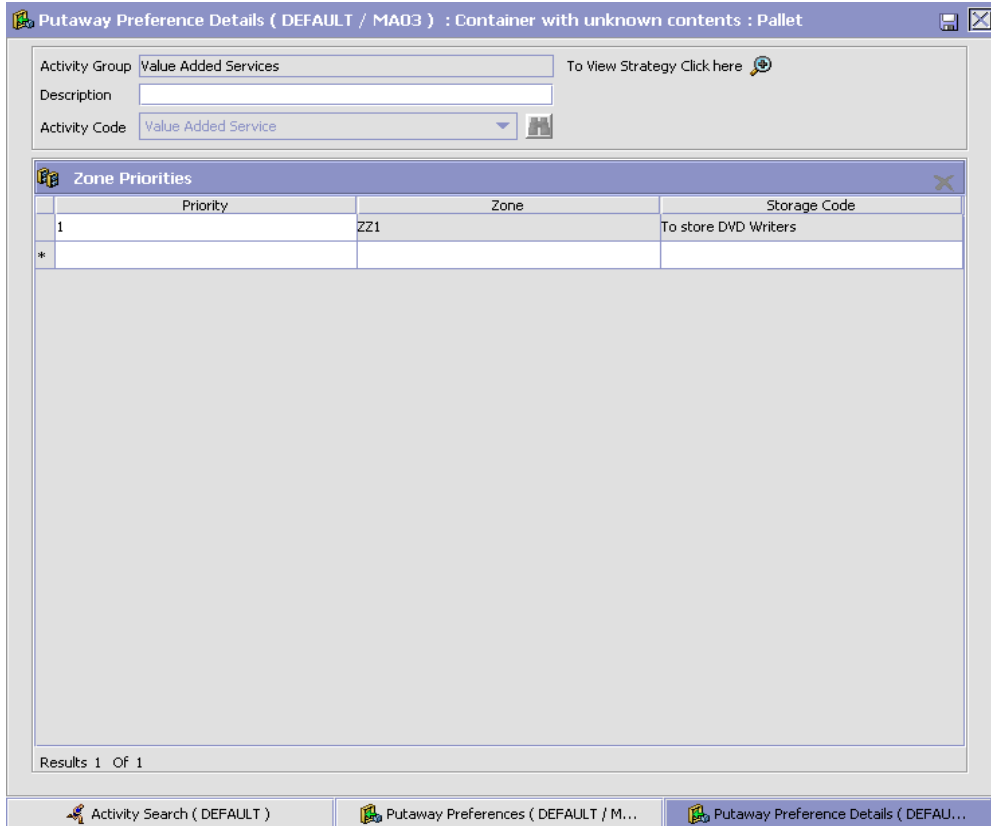

The screenshot shows a software window titled "Putaway Preference Details (DEFAULT / MA03) : Container with unknown contents : Pallet". The window contains a form with the following fields:

- Activity Group: Value Added Services
- Description: (empty text box)
- Activity Code: Value Added Service

Below the form is a table titled "Zone Priorities" with the following data:

Priority	Zone	Storage Code
1	ZZ1	To store DVD Writers
*		

At the bottom of the window, there is a status bar showing "Results 1 Of 1" and a taskbar with three open windows: "Activity Search (DEFAULT)", "Putaway Preferences (DEFAULT / M...", and "Putaway Preference Details (DEFAU...".

Table 8–19 Putaway Preference Details Window - Container with Unknown Contents Pallet Tab

Field	Description
Activity Group	This is automatically populated by the system as 'Value Added Services'.
To View Strategy Click here	Choose  to view or set up Putaway Strategy. For more details on setting up a putaway strategy see Setting Up Putaway Strategy for Containers with Unknown Contents - Pallets . Note: Putaway strategy may be specified for the putaway preferences after the preference is saved.
Description	Enter a brief description for the putaway preference.
Activity Code	Choose the Activity Code for the putaway preference. This is a mandatory field.
Zone Priorities	
Priority	Enter a number to represent the priority. The priority is used to sequence the order in which the zone priorities are evaluated. For example, all storage code level priorities are to be evaluated first before generic priorities. The priority needs to be a positive integer, greater than zero. This is mandatory.
Zone	Choose the relevant zone for putaway. This is a mandatory field.
Storage Code	Choose the storage code for the zone, if applicable. This limits the locations being evaluated to the storage code specified. For example, putaway of hazardous items into a zone are restricted to the locations having the appropriate storage code.

For example, pre-received pallets, when putaway is automatically sorted by shipment, SCAC utilizing the above fields.



Setting Up Putaway Strategy for Containers with Unknown Contents - Pallets

You can set up putaway strategies to putaway applicable inventory from a source zone to a target zone, based on the strategy specified.

To set up putaway strategy for container with unknown content pallets:

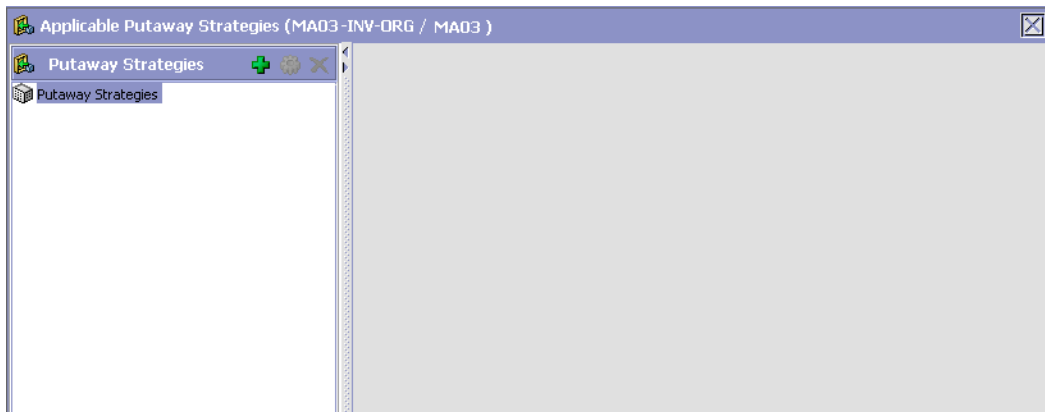
1. In the Putaway Preference Details : Container with unknown contents : Pallet window, choose .
2. The Applicable Putaway Strategies window is displayed.



3. Choose  in the Putaway Strategies panel. The Putaway Strategy Details window appears in the right panel.
4. Enter information in the applicable fields. See the Putaway Strategy Details Window table for field value descriptions.
5. Choose .

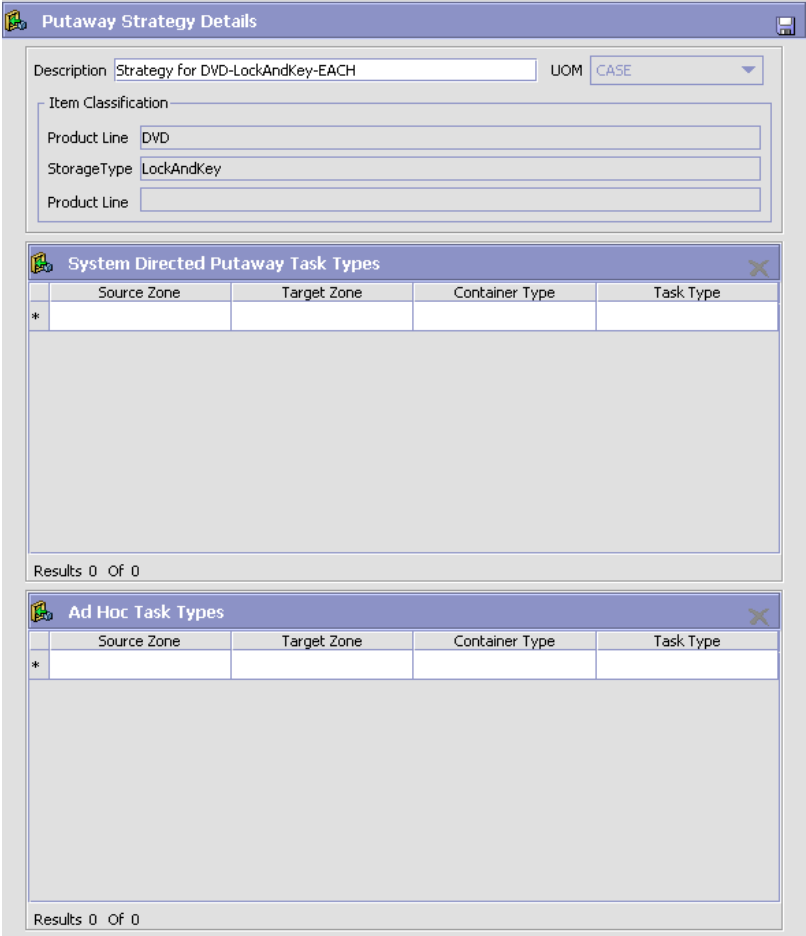

Table 8–20 Putaway Strategy Details Window

Field	Description
Description	Enter a description for the Putaway Strategy.
UOM	Select the UOM for the Putaway Strategy, if applicable. Note: The UOM will be defaulted in instances where it has been specified in the Putaway Preference Details screen.

Table 8–20 Putaway Strategy Details Window



Field	Description
Item Classification	List of putaway item classifications for the Enterprise are displayed. An example, Product Line is shown below.
Product Line	Choose relevant product line item classification for the putaway activity. Choose  . In the Classification Values window, select the applicable product line classification.
System Directed Putaway Task Types	Displays the list of existing system directed putaway task types. You may use  to delete an existing system directed putaway task type.
Source Zone	Select the source zone from where the inventory is sourced.
Target Zone	Select the target zone to where the inventory is moved.
Container Type	Select the container type to be used to move the inventory from the source zone to the target zone. Typical values are Case and Pallet.
Task Type	Select the Putaway Task Type applicable to this putaway strategy. This field displays the list of existing system directed task types that belong to the 'PUTAWAY' activity group.
Ad hoc Task Types	Displays the list of existing ad hoc task types. You may use  to delete an existing ad hoc task type.
Source Zone	Select the source zone from where the inventory is sourced.
Target Zone	Select the target zone to where the inventory is moved.

Table 8–20 Putaway Strategy Details Window



Field	Description
Container Type	Select the container type to be used to move the inventory from the source zone to the target zone. Typical values are Case and Pallet.
Task Type	Select the Putaway Task Type applicable to this putaway strategy. This field displays the list of existing ad hoc task types that belong to the 'PUTAWAY' activity group.

8.4.4.1.2 Setting Up Putaway Preference for a Case

To set up putaway preference for a case:

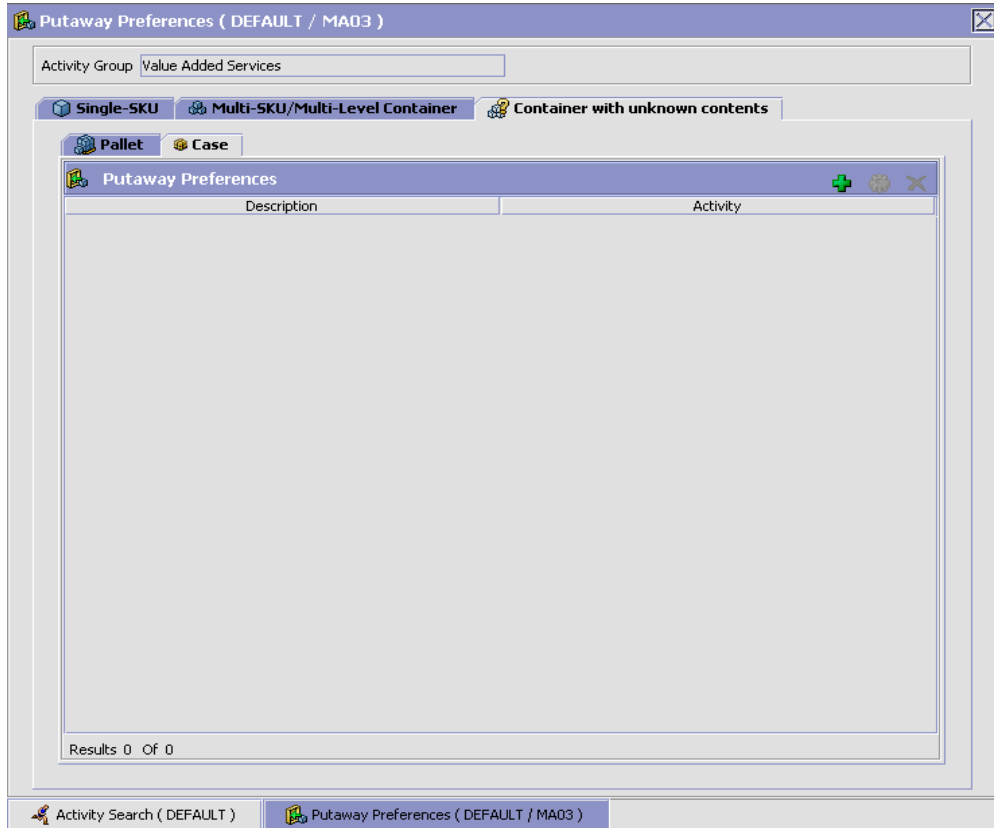
1. In the Container with Unknown Contents tab of Putaway Preferences window, choose the Case tab. The Case tab window displays.



2. In the Case tab window, choose .
3. The Putaway Preference Details window displays.
4. Enter information in the applicable fields. Refer [Table 8–21](#) for field value descriptions.
5. Choose .

Putaway Preference Details (DEFAULT / MA03) : Container with unknown contents : Case

Activity Group Value Added Services To View Strategy Click here

Description

Activity Code Value Added Service

Zone Priorities

	Priority	Zone	Storage Code
	3	ZZ1	To store DVD Writers
*			

Results 1 Of 1

Activity Search (DEFAULT) Putaway Preferences (DEFAULT / M... Putaway Preference Details (DEFAU...

Table 8–21 Putaway Preference Details Window - Container with Unknown Contents Case Tab

Field	Description
Activity Group	This is automatically populated by the system as 'Value Added Services'.
To View Strategy Click here	Choose  to view or set up Putaway Strategy. For more details on setting up a putaway strategy see Setting Up Putaway Strategy for Containers with Unknown Contents - Cases . Note: Putaway strategy may be specified for the putaway preferences after the preference is saved.
Description	Enter a brief description for the putaway preference.
Activity Code	Choose the Activity Code for the putaway preference. This is a mandatory field.
Zone Priorities	
Priority	Enter a number to represent the priority. The priority is used to sequence the order in which the zone priorities are evaluated. For example, all storage code level priorities are to be evaluated first before generic priorities. The priority needs to be a positive integer, greater than zero. This is mandatory.
Zone	Choose the relevant zone for putaway. This is a mandatory field.
Storage Code	Choose the storage code for the zone, if applicable. This limits the locations being evaluated to the storage code specified. For example, putaway of hazardous items into a zone are restricted to the locations having the appropriate storage code.



Setting Up Putaway Strategy for Containers with Unknown Contents - Cases

You can set up putaway strategies to putaway applicable inventory from a source zone to a target zone, based on the strategy specified.

To set up putaway strategy for container with unknown content cases:

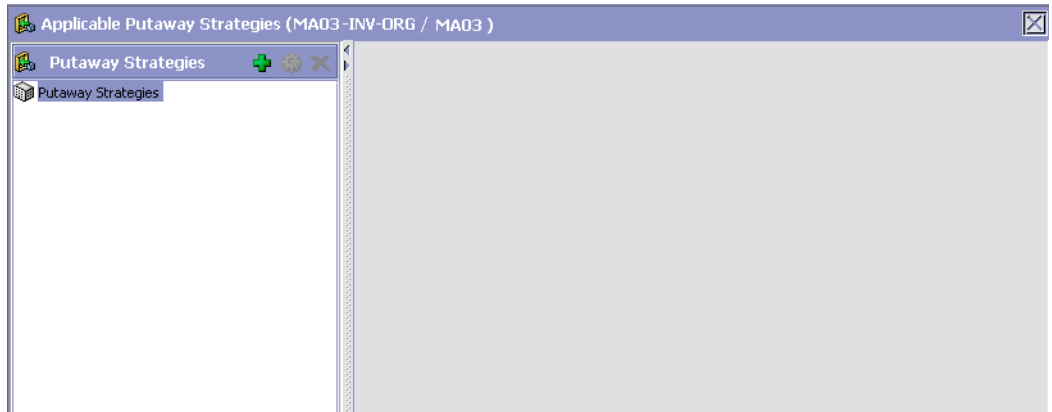
1. In the Putaway Preference Details : Container with unknown contents : Case window, choose .
2. The Applicable Putaway Strategies window is displayed.



3. Choose  in the Putaway Strategies panel. The Putaway Strategy Details window appears in the right panel.
4. Enter information in the applicable fields. See the Putaway Strategy Details Window table for field value descriptions.
5. Choose .

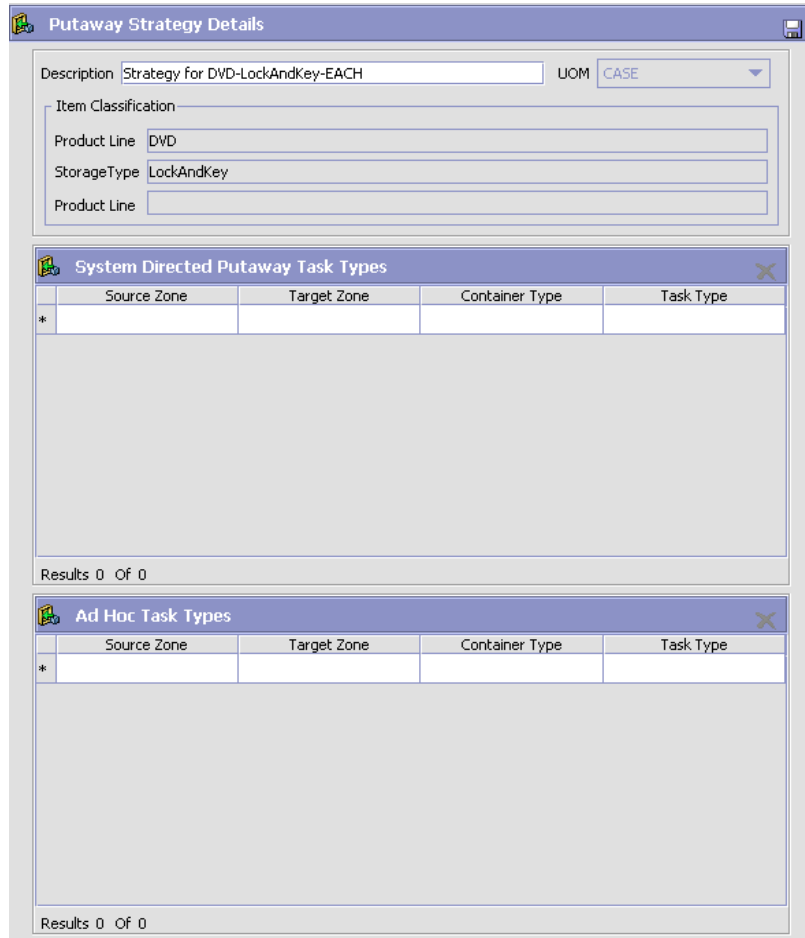

Table 8–22 Putaway Strategy Details Window

Field	Description
Description	Enter a description for the Putaway Strategy.
UOM	Select the UOM for the Putaway Strategy, if applicable. Note: The UOM will be defaulted in instances where it has been specified in the Putaway Preference Details screen.

Table 8–22 Putaway Strategy Details Window







Field	Description
Item Classification	List of putaway item classifications for the Enterprise are displayed. An example, Product Line is shown below.
Product Line	Choose relevant product line item classification for the putaway activity. Choose  . In the Classification Values window, select the applicable product line classification.
System Directed Putaway Task Types	Displays the list of existing system directed putaway task types. You may use  to delete an existing system directed putaway task type.
Source Zone	Select the source zone from where the inventory is sourced.
Target Zone	Select the target zone to where the inventory is moved.
Container Type	Select the container type to be used to move the inventory from the source zone to the target zone. Typical values are Case and Pallet.
Task Type	Select the Putaway Task Type applicable to this putaway strategy. This field displays the list of existing system directed task types that belong to the 'PUTAWAY' activity group.
Ad hoc Task Types	Displays the list of existing ad hoc task types. You may use  to delete an existing ad hoc task type.
Source Zone	Select the source zone from where the inventory is sourced.
Target Zone	Select the target zone to where the inventory is moved.

Table 8–22 Putaway Strategy Details Window

Field	Description
Container Type	Select the container type to be used to move the inventory from the source zone to the target zone. Typical values are Case and Pallet.
Task Type	Select the Putaway Task Type applicable to this putaway strategy. This field displays the list of existing ad hoc task types that belong to the 'PUTAWAY' activity group.

8.4.4.2 Creating a New Putaway Preference for Container with Unknown Contents from an Existing Putaway Preference



To create a new putaway preference for container with unknown contents from an existing putaway preference:

1. From the tree in the application rules side panel, choose VAS > Activities. The Activity Search window displays, with the list of activities.
2. In the top right corner, choose . The Putaway Preferences window displays.
3. In the Putaway Preferences window, choose the Container with Unknown Contents tab.
4. The Container with Unknown Contents tab window displays, with the list of putaway preferences.
5. Select the putaway preference to be copied from. Choose .
6. The Putaway Preference Details window displays.
7. Enter information in the applicable fields. For more information about modifying the fields, refer to [Section 8.4.4.1.1, "Setting Up Putaway Preference for a Pallet"](#) on page 687 and [Section 8.4.4.1.2, "Setting Up Putaway Preference for a Case"](#) on page 693.
8. Choose .

8.4.4.3 Modifying a Putaway Preference for Container with Unknown Contents

Once a Putaway Preference for Container with Unknown Contents has been created, it can be modified.

To modify a putaway preference for container with unknown contents:

1. From the tree in the application rules side panel, choose VAS > Activities. The Activity Search window displays, with the list of activities.
2. In the top right corner, choose . The Putaway Preferences window displays.
3. In the Putaway Preferences window, choose the Container with Unknown Contents tab.
4. The Container with Unknown Contents tab window displays, with the list of putaway preferences.
5. Select the putaway preference to be modified. Choose .
6. The Putaway Preference Details window displays.
7. Enter information in the applicable fields. For more information about modifying the fields, refer to [Section 8.4.4.1.1, "Setting Up Putaway Preference for a Pallet"](#) on page 687 and [Section 8.4.4.1.2, "Setting Up Putaway Preference for a Case"](#) on page 693.
8. Choose .

The activity code corresponding to the preference cannot be modified. The preference must be deleted and recreated. Refer to [Section 8.4.4.4, "Deleting a Putaway Preference for Container with Unknown Contents"](#) on page 701.

8.4.4.4 Deleting a Putaway Preference for Container with Unknown Contents

To delete a putaway preference for container with unknown contents:

1. From the tree in the application rules side panel, choose VAS > Activities. The Activity Search window displays, with the list of activities.
2. In the top right corner, choose . The Putaway Preferences window displays.
3. In the Putaway Preferences window, choose the Container with Unknown Contents tab.
4. The Container with Unknown Contents tab window displays, with the list of putaway preferences.

5. Select the putaway preference to be deleted.
6. Choose .

8.5 Defining Work Order Cancellation Reasons

A reason code is associated with cancellation of work order requests.

Note: Viewing of Work Order Cancellation Reason Code is available only for Enterprise and Node users.

Use Work Order Cancellation Reasons for:

- [Creating a Work Order Cancellation Reason](#)
- [Creating a New Work Order Cancellation Reason from an Existing Work Order Cancellation Reason](#)
- [Modifying a Work Order Cancellation Reason](#)
- [Deleting a Work Order Cancellation Reason](#)

8.5.1 Creating a Work Order Cancellation Reason

To create a work order cancellation reason:

1. From the tree in the application rules side panel, choose VAS > VAS Process > Work Order Cancellation Reasons. The Work Order Cancellation Reasons window displays.

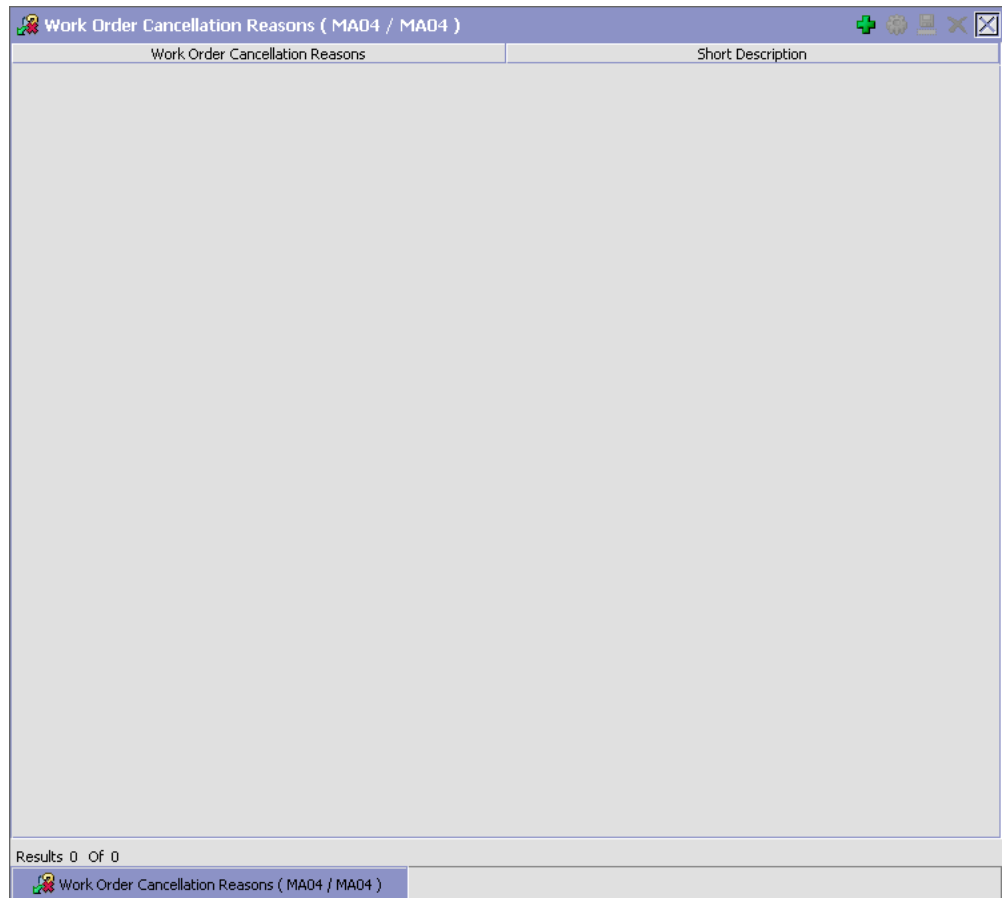



2. In the Work Order Cancellation Reasons window, choose .
3. The Work Order Cancellation Reason Code Details pop-up window displays.
4. Enter information in the applicable fields. Refer [Table 8–23](#) for field value descriptions.
5. Choose .

Table 8–23 *Work Order Cancellation Reason Code Details Pop-up Window*

Field	Description
Work Order Cancellation Reasons	Enter a code for the work order cancellation reason.
Short Description	Enter a short description for the work order cancellation reason code.
Long Description	Enter a long description for the work order cancellation reason code.

8.5.2 Creating a New Work Order Cancellation Reason from an Existing Work Order Cancellation Reason

To create a new Work Order Cancellation Reason from an existing Work Order Cancellation Reason:



1. From the tree in the application rules side panel, choose VAS > VAS Process > Work Order Cancellation Reasons. The Work Order Cancellation Reasons window displays with the list of Work Order Cancellation Reason Codes.
2. Choose the Work Order Cancellation Reason to be copied.
3. Choose . The Work Order Cancellation Reason Code Details pop-up window displays.
4. Enter information in the applicable fields. Refer [Table 8–23](#) for field value descriptions.

5. Choose .

8.5.3 Modifying a Work Order Cancellation Reason

Once a Work Order Cancellation Reason has been created, it can be modified.

To modify a Work Order Cancellation Reason:

1. From the tree in the application rules side panel, choose VAS > VAS Process > Work Order Cancellation Reasons. The Work Order Cancellation Reasons window displays with the list of Work Order Cancellation Reason Codes.
2. Choose the Work Order Cancellation Reason to be modified.
3. Choose . The Work Order Cancellation Reason Code Details pop-up window displays.
4. Enter information in the applicable fields. Refer [Table 8–23](#) for field value descriptions.
5. Choose .

8.5.4 Deleting a Work Order Cancellation Reason

To delete a Work Order Cancellation Reason Code:

1. From the tree in the application rules side panel, choose VAS > VAS Process > Work Order Cancellation Reasons. The Work Order Cancellation Reasons window displays with the list of Work Order Cancellation Reason Codes.
2. Choose the Work Order Cancellation Reason to be deleted.
3. Choose .

8.6 Defining Allocation Considerations

A work order for service items belonging to one of the following service item group codes would result in inventory transformations on confirmation:

- KIT - Kitting
- DKIT - De-kitting

- COMPL - Compliance
- INVC Inventory-Change

The Allocation Considerations configuration is used by Selling and Fulfillment Foundation to provide visibility into such inventory transformations. For instance:

- When a work order is created, demand is placed against the original inventory (the one being consumed), and supply is increased for the new inventory (the one being created).

Note: The supply being increased is not an onhand supply. It is an indicative supply that would be available in future.

The demands being increased are not promised demands.

- When a work order is allocated, the demands placed are modified to indicate that the demands are promised. The supplies may also be modified to indicate their increased chance of arrival.

Note: These demands and supplies could be utilized to assess the availability of inventory.

- When a work order is confirmed, the supply for the original inventory is removed and supply for the new inventory is created.

Use Allocation Considerations for:

- [Creating a Work Order Allocation Consideration](#)
- [Modifying a Work Order Allocation Consideration](#)
- [Deleting a Work Order Allocation Consideration](#)

8.6.1 Creating a Work Order Allocation Consideration

To create a work order allocation consideration:

1. From the tree in the application rules side panel, choose VAS > VAS Process > Allocation Considerations. The Work Order Allocation Considerations window displays.

Service Item Group	Demand Type for Consumed	Supply Type for Created
KIT	OPEN_ORDER	WO_PLACED
DKIT	OPEN_ORDER	WO_PLACED
INVC	OPEN_ORDER	WO_PLACED
COMPL	OPEN_ORDER	WO_PLACED

Results 4 Of 4



2. In the Work Order Allocation Considerations window, choose . The Work Order Allocation Consideration pop-up window displays.
3. Enter information in the applicable fields. Refer [Table 8–24](#) for field value descriptions.
4. Choose .



Table 8–24 Work Order Allocation Consideration Pop-up Window

Field	Description
Service Item Group	Choose the service item group for which the allocation considerations are being created.
Demand Type for Consumed	Associate the type of demand to identify inventory consumed to work orders for the service item group.
Supply Type for Created	Associate the type of supply to identify inventory created by the work order for the service item group.
Demand Type for Allocated	Associate the type of demand to identify inventory allocated to work orders for the service item group.
Supply Type for Allocated	Associate the type of supply to identify inventory allocated by the work order for the service item group.
Actual Supply Type for Consumed	Choose the supply type for inventory consumed at the confirmation. This field is used when the work order is placed for a Node that is not "Integrated WMS".
Actual Supply Type for Created	Choose the Supply Type for inventory created at the confirmation. This field is used when the work order is placed for a Node that is not "Integrated WMS".

8.6.2 Modifying a Work Order Allocation Consideration

Once a work order allocation consideration has been created, it can be modified.

To modify a work order allocation consideration:

1. From the tree in the application rules side panel, choose VAS > VAS Process > Allocation Considerations. The Work Order Allocation Considerations window displays with the list of Work Order Allocation Considerations.
2. Choose the Work Order Allocation Consideration to be modified.
3. Choose . The Work Order Allocation Consideration pop-up window displays.
4. Enter information in the applicable fields. Refer [Table 8–24](#) for field value descriptions.
5. Choose .

8.6.3 Deleting a Work Order Allocation Consideration

To delete a work order allocation consideration:

1. From the tree in the application rules side panel, choose VAS > VAS Process > Allocation Considerations. The Work Order Allocation Considerations window displays with the list of Work Order Allocation Considerations.
2. Choose the Work Order Allocation Consideration to be deleted.
3. Choose .

8.7 Defining Value Added Services Modification Rules



Most order document types flow through a pipeline without requiring any intervention by a customer service representative. However, there are times when modifications are required, such as modifying quantity or activities required. Selling and Fulfillment Foundation supports modifications through the Console and APIs. It is critical to decide which modifications are allowed for each modification type, modification level, and status combination.

Important: Contemplate business and system integration implications before allowing a modification that is disallowed as part of the system defaults.

For more information about modification rules, see the *Sterling Distributed Order Management: Configuration Guide*.

8.7.1 Setting Up Value Added Services Modification Rules

To set up Value Added Services modification rules:

1. From the tree in the application rules side panel, choose VAS > VAS Process > VAS Modification Rules. The Modification Rules window displays.
2. In the Modification Rules window, select the Value Added Services Process whose Modification Rule is to be set. Refer [Table 8–25](#) for field value descriptions.
3. Choose  to allow modification.
4. Choose  to disallow modification.
5. Choose  to ignore modification.

For more information about defining modification rules, see the *Sterling Distributed Order Management: Configuration Guide*.

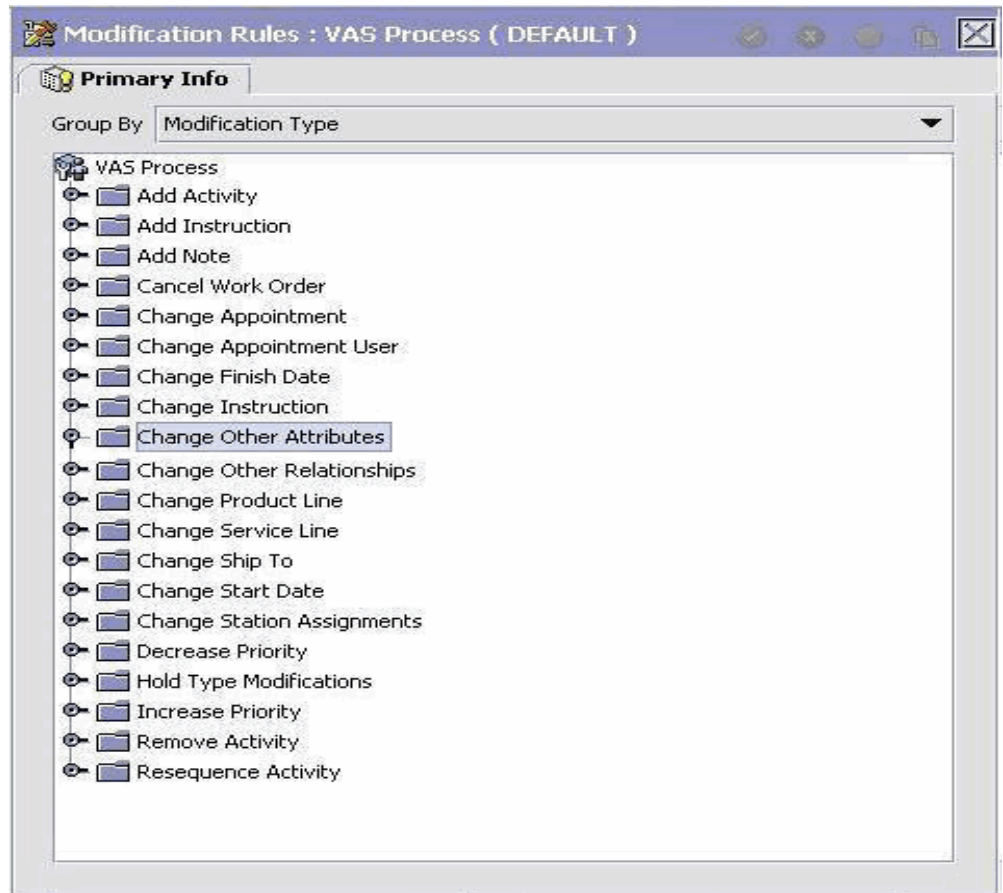

Table 8–25 *Modification Rules Window*

Field	Description
Primary Info	
Group by	View the VAS Modification Rules grouped by Modification Type, Modification Level, or by Status.
Modification Type	VAS Modification Rules grouped by Modification Type. Statuses display grouped by Modification Level for each Modification Type.

Table 8–25 Modification Rules Window

Field	Description
Add Activity	Allow or Disallow or Ignore the addition of an activity appropriately.
Add Instruction	Allow or Disallow or Ignore the addition of an instruction appropriately.
Cancel Work Order	Allow or Disallow or Ignore the cancellation of a work order appropriately.
Change Finish Date	Allow or Disallow or Ignore the modification of a finish date appropriately.
Change Instruction	Allow or Disallow or Ignore the modification of an instruction appropriately.
Change Other Relationships	Allow or Disallow or Ignore the modification of other relationships appropriately.
Change Start Date	Allow or Disallow or Ignore the modification of a start date appropriately.
Change Station Assignments	Allow or Disallow or Ignore the modification of station assignments appropriately.
Decrease Priority	Allow or Disallow or Ignore the decrease in priority appropriately.
Increase Priority	Allow or Disallow or Ignore the increase in priority appropriately.
Remove Activity	Allow or Disallow or Ignore the removal of an activity appropriately.
Resequence Activity	Allow or Disallow or Ignore the resequencing of an activity appropriately.
Modification Level	VAS Modification Rules grouped by Modification Level. Statuses display grouped by Modification Type for each Modification Level.
Activity	Allow or Disallow or Ignore the modification types at the activity level appropriately.
Work Order	Allow or Disallow or Ignore the modification types at the work order level appropriately.

Table 8–25 Modification Rules Window

Field	Description
Status	VAS Modification Rules grouped by Status. Modification Types display grouped by Modification Level for each Status.
Work Order Created	Allow or Disallow or Ignore the modification types for the Work Order Created status appropriately.

For more information about the Allow, Disallow, and Ignore features, see the *Sterling Distributed Order Management: Configuration Guide*.

8.8 Defining Value-Added Services Hold Types

Work orders can be placed on hold manually or automatically, by applying a particular hold type. Certain transactions can be configured to not process documents that are on a given hold. Likewise, modification types can be configured to not process documents that are on a given hold. By default, all transactions and modification types are allowed to process all documents for all hold types.

The transactions that can be prevented from processing work orders on a given hold type have the check box *This Transaction Can Be Stopped From Processing Work Orders That Are On Hold* checked in the *Others* tab of the transaction details. For more information about viewing transaction details, refer to the *Selling and Fulfillment Foundation: Application Platform Configuration Guide*.



You can use the Hold Types branch for:

- [Creating a Hold Type](#)
- [Modifying a Hold Type](#)
- [Deleting a Hold Type](#)

8.8.1 Creating a Hold Type

To create a hold type:

1. From the tree in the application rules side panel, choose VAS > VAS Process > Hold Types. The Hold Types window displays in the work area.

2. Click . The Hold Type pop-up window displays. The type of this hold in the Hold Type field, and its description in the Description field. Enter the rest of the information in the applicable fields. Refer to [Table 8–26](#), [Table 8–27](#) and [Table 8–28](#) for field value descriptions.
3. Click .

Hold Type Hold Type Description

Hold Creation **Hold Resolution** **Hold Effects**

Hold Create Automatically

On Work Order Creation

On Resolution Of Hold Type

When The Following Modifications Are Performed

Modification Type	Modification Level
-------------------	--------------------

For All Work Order

Only For Work Order Satisfying Following Condition

Manual Hold

ALL_USERGROUPS_CAN_APPLY_HOLD

Users Belonging To The Following User Groups Can Put Work Order On This Hold

Group ID	Group Name
----------	------------

Table 8–26 Hold Type window, Hold Creation tab



Field	Description
Hold Created Automatically	
On Work Order Creation	Check this to apply this hold type to all work orders on work order creation.
On Resolution Of Hold Type	Check this to apply this hold type on resolution of another hold type. Select from the drop-down list the hold type that, upon resolution, triggers this hold type.
When The Following Modifications Are Performed	<p>Modification types that automatically apply this hold type to a work order.</p> <p>Click  to modify the list. In the subsequent pop-up window:</p> <ul style="list-style-type: none"> • Use the right arrow to move the available modification types that you wish to associate with this hold type to the subscribed list. • Use the left arrow to unsubscribe the modification types that you wish to disassociate with this hold type and move them back into the available list.
For All Work Orders	Select this radio button if the above conditions should be checked for all work orders.
Only For Work Order Satisfying Following Condition	Select this radio button if the above conditions should only be checked for work orders satisfying a certain condition. Click  to build or modify the condition for evaluation. For more information about using the condition builder, refer to the <i>Selling and Fulfillment Foundation: Application Platform Configuration Guide</i> .
Manual Hold	

Table 8–26 Hold Type window, Hold Creation tab

Field	Description
All User Groups Can Apply Hold	Select this radio button if all user groups can apply this hold to a work order.
Users Belonging To The Following User Groups Can Put Work Orders On This Hold	<p>Select this radio button if only users belonging to certain user groups may apply this hold to a work order.</p> <p>Click  to modify the list. In the subsequent pop-up window:</p> <ul style="list-style-type: none"> • Use the right arrow to move the available user groups that you wish to associate with this hold type to the subscribed list. • Use the left arrow to unsubscribe the user groups that you wish to disassociate with this hold type and move them back into the available list.

Table 8–27 Hold Type window, Hold Resolution tab

Field	Description
Hold Resolved Automatically	
The Following Time-Triggered Transaction Will Process Created Holds	From the drop-down list, select the time-triggered transaction that will process created holds.
The Following Time-Triggered Transaction Will Process Rejected Holds	From the drop-down list, select the time-triggered transaction that will process rejected holds.
Hold Resolved Manually	

Table 8–27 Hold Type window, Hold Resolution tab





Field	Description
All Users Can Process This Hold	Select this radio button if all user groups may process this hold.
Users Belonging To The Following User Groups Can Process This Hold	<p>Select this radio button if only users belonging to certain user groups may process this hold.</p> <p>Click  to modify the list. In the subsequent pop-up window:</p> <ul style="list-style-type: none"> Use the right arrow to move the available user groups that you wish to associate with this hold type to the subscribed list. Use the left arrow to unsubscribe the user groups that you wish to disassociate with this hold type and move them back into the available list.

Table 8–28 Hold Type window, Hold Effects tab

Fields	Description
Transactions That Will Be Stopped From Processing Work Orders On This Hold	<p>Transactions that are disallowed when this hold type is applied to a work order.</p> <p>Click  to modify the list. In the subsequent pop-up window:</p> <ul style="list-style-type: none"> Use the right arrow to move the available modification types that you wish to associate with this hold type to the subscribed list. <p>Use the left arrow to unsubscribe the modification types that you wish to disassociate with this hold type and move them back into the available list.</p>
The Following Modifications Are Not Allowed For Work Orders On This Hold	<p>Modification types are disallowed when this hold type is applied to a work order.</p> <p>Click  to modify the list. In the subsequent pop-up window:</p> <ul style="list-style-type: none"> Use the right arrow to move the available transactions that you wish to associate with this hold type to the subscribed list. <p>Use the left arrow to unsubscribe transactions that you wish to disassociate with this hold type and move them back into the available list.</p>

8.8.2 Modifying a Hold Type

1. From the tree in the application rules side panel, choose VAS > VAS Process > Hold Types. The Hold Types window displays in the work area.
2. Select the applicable hold type and click . The Hold Type pop-up window displays. Enter information in the applicable fields. Refer to [Table 8–26](#), [Table 8–27](#) and [Table 8–28](#) for field value descriptions.
3. Click .

8.8.3 Deleting a Hold Type

1. From the tree in the application rules side panel, choose VAS > VAS Process > Hold Types. The Hold Types window displays in the work area.
2. Select the applicable hold type and click .

8.9 Defining Value Added Services Process Type Details

Value Added Services Process Type Details define parameters and templates that distinguish a process type.

A **process type pipeline** is a series of transactions and statuses that guide document types, such as a Value Added Services execution, through a predefined process. A pipeline consists of the different statuses a document goes through during fulfillment, negotiation, shipment, or receipt. You can also set up transactions consisting of events, actions, and conditions, as they pertain to the pipeline you are configuring.

Repositories

A repository is a logical collection of entities that define the business process workflow.

The following entities are included in a repository:

- Pipelines
- Transactions
- Statuses

- Conditions
- Actions
- Services

Selling and Fulfillment Foundation provides a base repository for each of the system-defined process types. Some of the entities within a repository are copied when creating a new document type. For more information about creating a new document type, see the *Selling and Fulfillment Foundation: Application Platform Configuration Guide*.

For more information about defining process type details, see the *Selling and Fulfillment Foundation: Application Platform Configuration Guide*.

8.9.1 Viewing Value Added Services Process Type Details

To view Value Added Services process type details:

1. From the tree in the application rules side panel, choose VAS > VAS Process > VAS Process Type Details. The Process Type Details : Work Order window displays.
2. Primary information of the Process Type displays in the applicable fields. Refer [Table 8–29](#) for field value descriptions.

For more information about defining the primary information for process type details, see the *Selling and Fulfillment Foundation: Application Platform Configuration Guide*.

Process Type Details : Work Order (DEFAULT)

Primary Info

Process Type: VAS Process Type Name: VAS

Description: VAS

Table 8–29 *Process Type Details : Work Order Window*

Field	Description
Primary Info	
Process Type	This is automatically populated by the system as "VAS".
Process Type Name	This indicates the name of the process type.
Description	This provides a brief description for the process type.

8.10 Defining Value Added Services Process Model

The Value Added Services process is modeled through a pipeline. This represents the process configuration that is unique to a warehouse. A warehouse may also specify unique processes for each participating enterprise.

For example, a warehouse that performs ticketing for outbound shipments after pick and pack into a carton is complete.

8.10.1 Pipeline Determination

Pipeline determination is used to set up conditions that affect which pipeline is used during the start of the business process workflow. For example, an organization deals with sales orders that sometimes contain hazardous materials. They have two separate pipelines, one in which orders with order lines without any hazardous materials go through and one in which orders with order lines containing hazardous materials must go through for inspection before continuing through the order process. The organization uses pipeline determination to set up a condition that determines whether or not order lines contain hazardous materials and sends the order line down the correct pipeline.

For more information about Pipeline Determination, see the *Selling and Fulfillment Foundation: Application Platform Configuration Guide*.

8.10.2 Hub Rule

When you expand the Pipeline Determination branch, the components display depends on what role you are logged in as. If you are logged in as a Hub role, the Hub Rule displays. If you are logged in as an Enterprise role, both the Hub Rule and all user created determination rules (For example, My Rule) components display. Double-click on the applicable rule to display the pipeline determination rules.

Note: If you are logged in as an Enterprise role, the Hub Rule screen is grayed out and cannot be modified.

Drag conditions and pipelines into the work area to construct pipeline determination rules. A single pipeline or condition must be the root.

Conditions cannot link back to an earlier component in the chain and a pipeline cannot be linked to twice.

Note: When configuring pipeline determination for an order document type pipeline, note that pipeline determination is only considered when adding a line or creating an order. When changes are made to draft orders pipeline determination does not occur.

8.10.2.1 Condition Variables for Pipeline Determination

When using conditions for pipeline determination, the following condition variables can be used:

- Enterprise Code
- Provider Organization Code
- Node Key
- Purpose
- Service Item Group Code
- Service Item ID
- Segment Type
- Segment
- Has Components
- Status
- Pre Call Status
- Appt Status
- Number Of Attempts
- Number Of Hours until Appointment
- Number Of Hours After Appointment
- Number Of Hours After Last Execution
- Last Execution Success
- Open Work Order Flag

For more information about Pipeline Determination and Hub Rule, see *Selling and Fulfillment Foundation: Application Platform Configuration Guide*.

8.10.3 Pipelines

For more information about Pipelines, see the *Selling and Fulfillment Foundation: Application Platform Configuration Guide*.

To view the Value Added Services pipeline details:

1. From the tree in the application rules side panel, choose VAS > VAS Process > VAS Process Model. The VAS Process window displays.

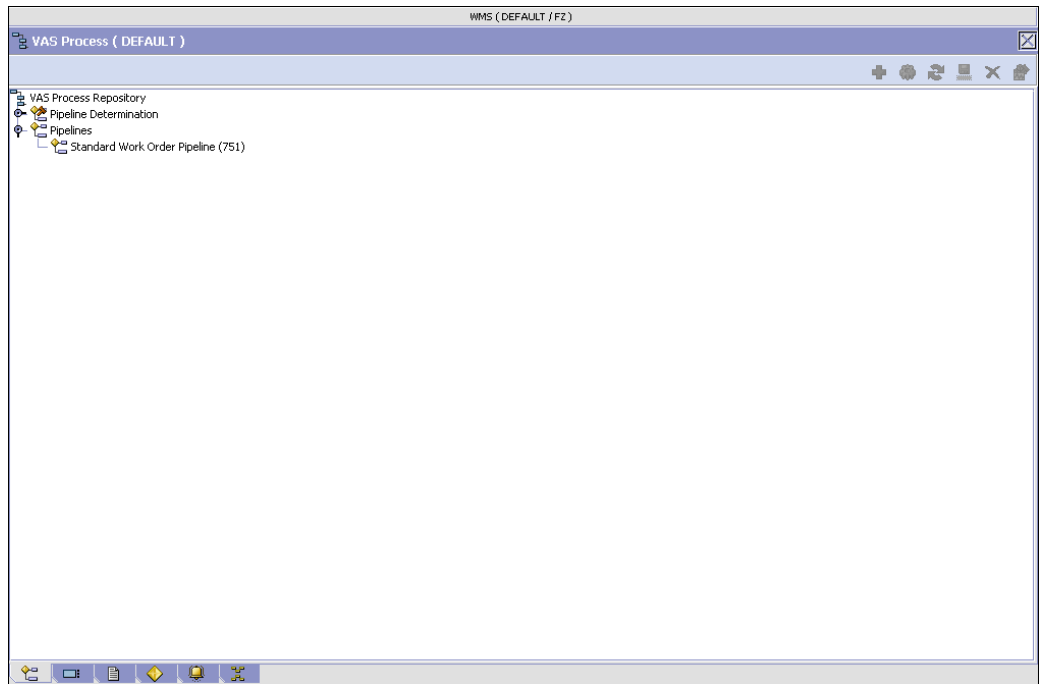

2. In the VAS Process window, choose VAS Process Repository > Pipelines > Standard Work Order Pipeline.
3. The Pipeline Detail: Standard Work Order Pipeline (VAS Process) window displays.

For more information about creating or modifying a pipeline, see the *Selling and Fulfillment Foundation: Application Platform Configuration Guide*.

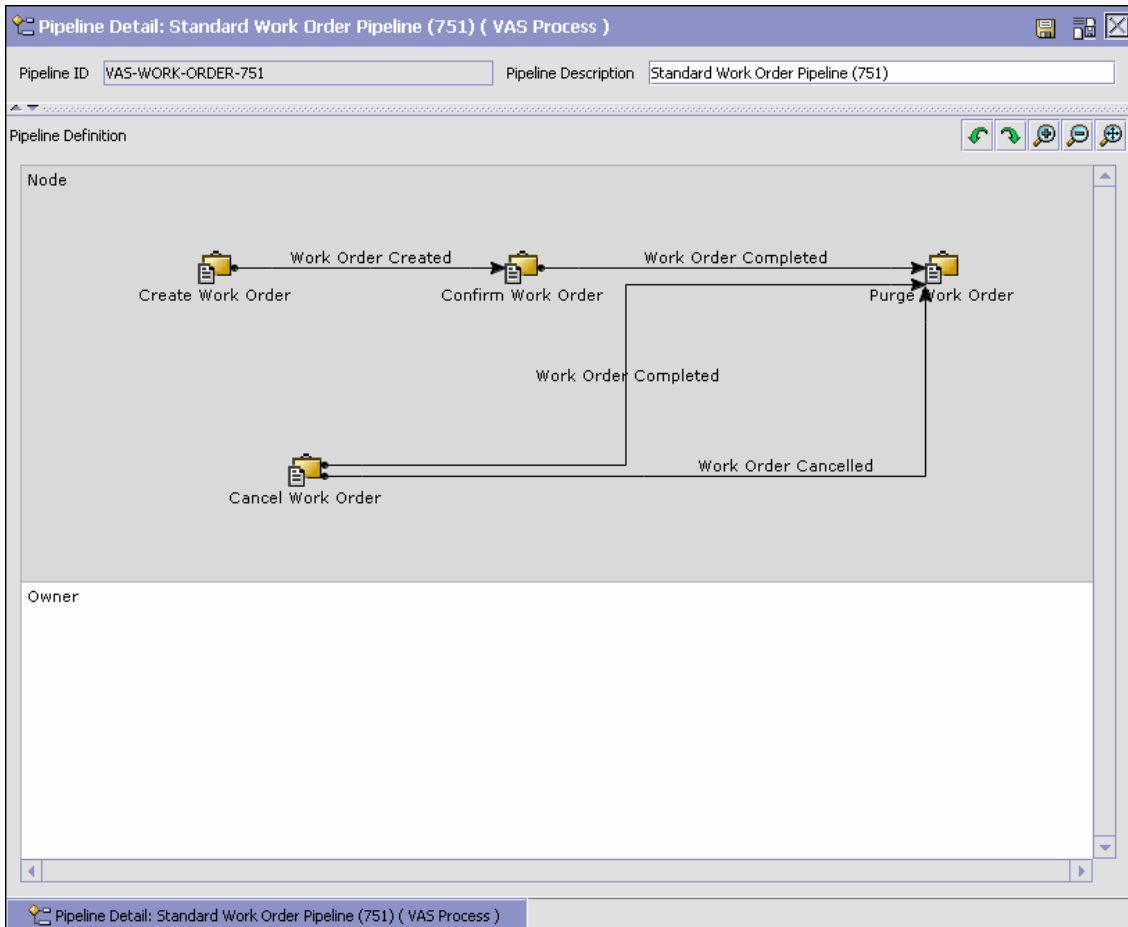

8.10.4 Transactions

Every process type has a set of base transactions defined for it. A transaction is a logical unit of work that is necessary for performing activity within Selling and Fulfillment Foundation. Base transactions are predefined transactions that contain information about how the

transaction behaves, such as how many copies of a transaction can be kept in a process type and whether or not it can have configurable base pick and drop statuses. Base transactions can be used to create new transactions. These transactions can be changed within the limits defined in the base transaction.

For more information about Transactions, see the *Selling and Fulfillment Foundation: Application Platform Configuration Guide*.

To view the transaction details for a Value Added Services pipeline:

1. From the tree in the application rules side panel, choose VAS > VAS Process > VAS Process Model. The Work Order VAS window displays.
2. In the Work Order VAS window, choose .
3. The Transactions tab window displays.

For more information about creating or modifying Transactions, see the *Selling and Fulfillment Foundation: Application Platform Configuration Guide*.

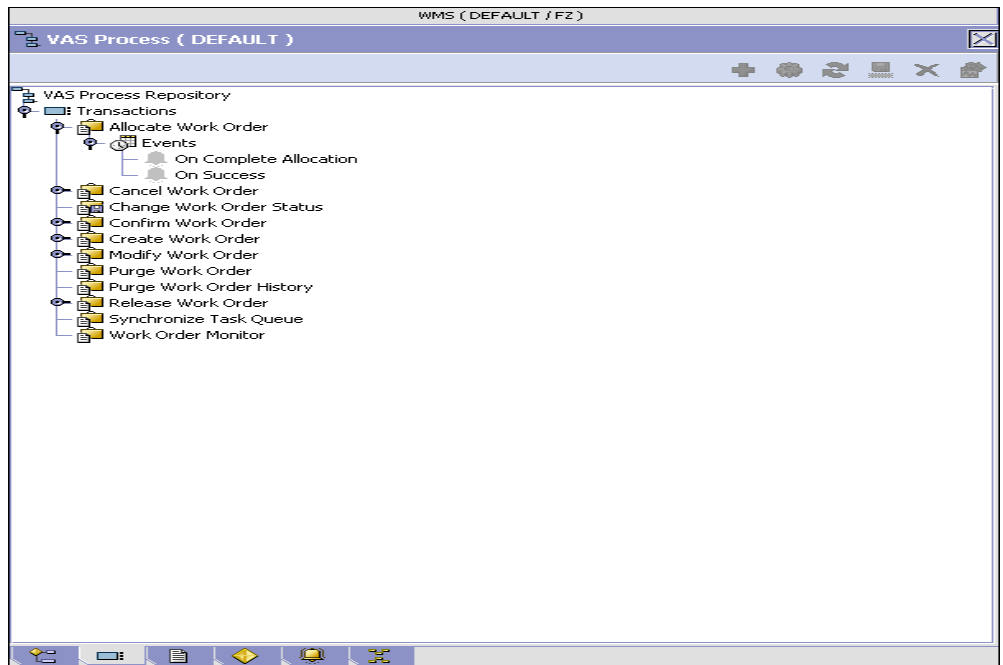

Table 8–30 Work Order VAS Pipeline - Transactions Tab Window

Field	Description
Allocate Work Order	This transaction represents allocation of the work order for the VAS process.
Cancel Work Order	This transaction represents the cancellation of a work order created for VAS.
Change Work Order Status	This transaction represents the change in status of a work order created for VAS.
Confirm Work Order	This transaction represents that the work order needs to be confirmed for VAS.
Create Work Order	This transaction represents creation of a work order for VAS.
Modify Work Order	This transaction represents the modification of a work order for VAS.
Purge Work Order History	This transaction represents the purge of the work order history for VAS.
Purge Work Order	This transaction represents the purge of work orders created for VAS.
Release Work Order	This transaction represents the release of work orders created for VAS.

8.10.5 Statuses

Statuses are the actual states that a document moves through in the pipeline. A transaction can contain two types of statuses, a drop status and a pickup status. A document is moved into a **drop status** when the events and conditions of a transaction have been completed. A **pickup status** takes the document from the previous drop status and moves it through the next transaction. Created and Scheduled are examples of statuses.

For more information about Statuses, see the *Selling and Fulfillment Foundation: Application Platform Configuration Guide*.

To view the status details of a VAS pipeline:

1. From the tree in the application rules side panel, choose VAS > VAS Process > VAS Process Model. The Work Order VAS window displays.

2. In the Work Order VAS window, choose .
3. The Statuses tab window displays.

For more information about creating or modifying Statuses, see the *Selling and Fulfillment Foundation: Application Platform Configuration Guide*.

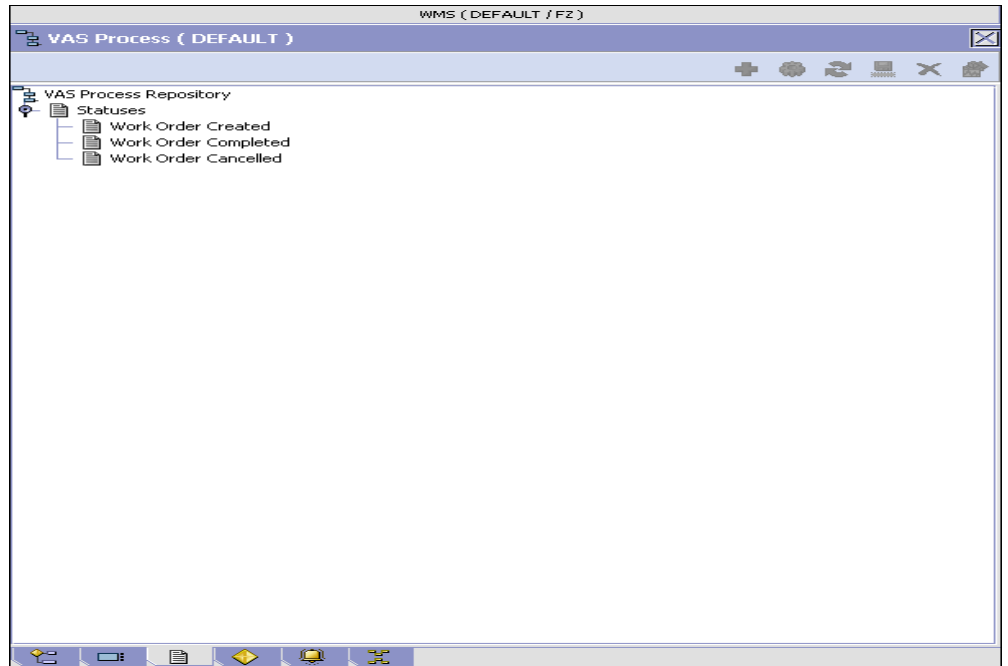

Table 8–31 Work Order VAS Pipeline - Statuses Tab Window

Field	Description
Work Order Created	This indicates that a work order is created. This corresponds to the first step of the 'Create Work Order' transaction.
Work Order Confirmed	This indicates all activities required for the work order is complete. This corresponds to the 'Confirm Work Order' transaction. This transaction creates inventory for the parent item on the work order. Putaway process for the finished inventory to storage or to packing or shipping zones can be initiated.
Work Order Canceled	This indicates cancellation of VAS for the shipment. This corresponds to the 'Cancel Work Order' transaction.

8.10.6 Conditions

A **condition** matches document type attributes against decision points and routes the documents to different paths based on the specified attribute and value combinations. The document type attributes against which conditions can be created are predefined in Selling and Fulfillment Foundation. You can use these attributes in any combination or you can create conditions that run the appropriate application logic for specific circumstances.

For more information about Conditions, see the *Selling and Fulfillment Foundation: Application Platform Configuration Guide*.

To view the condition details of a Value Added Services pipeline:

1. From the tree in the application rules side panel, choose VAS > VAS Process > VAS Process Model. The Work Order VAS window displays.
2. In the Work Order VAS window, choose .
3. The Conditions tab window displays.

For more information about creating and modifying Conditions, see the *Selling and Fulfillment Foundation: Application Platform Configuration Guide*.

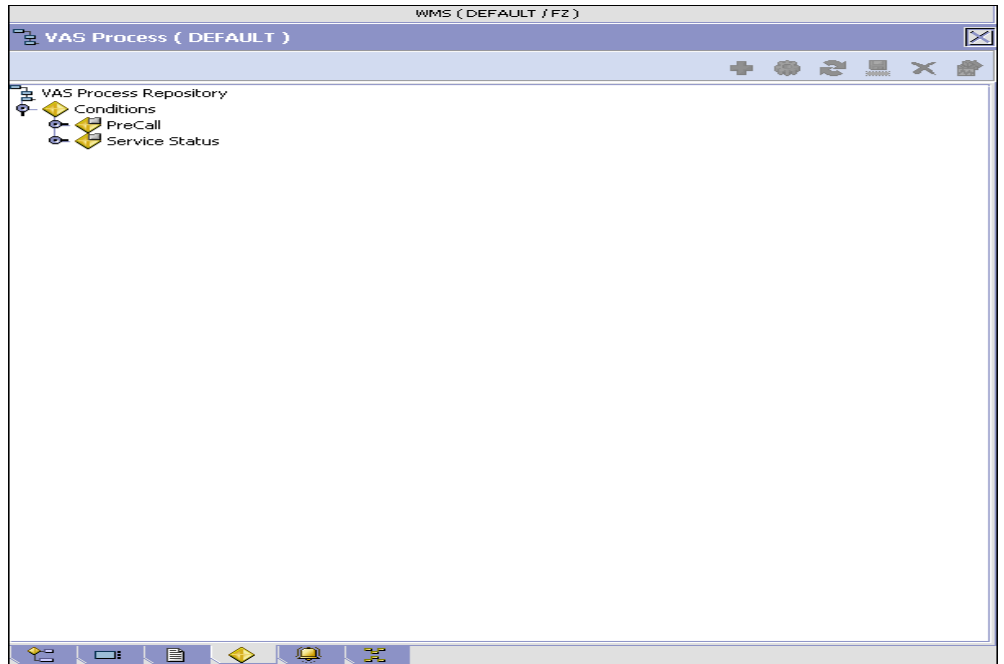

Table 8–32 Work Order VAS Pipeline - Conditions Tab Window

Field	Description
Conditions	Displays service definitions that are specific to the VAS pipeline, if any.

The Sterling WMS default pipeline does not have any service definitions specified.

8.10.7 Actions

An **action** is a process or program that is triggered by an event. These processes and programs send user alert notifications and automatically resolve issues.

For example, when an order is released (the event), you can set an action to send the customer an e-mail.

For more information about Actions, see the *Selling and Fulfillment Foundation: Application Platform Configuration Guide*.

To view the action details of a VAS pipeline:

1. From the tree in the application rules side panel, choose VAS > VAS Process > VAS Process Model. The Work Order VAS window displays.
2. In the Work Order VAS window, choose .
3. The Actions tab window displays.

For more information about creating or modifying Actions, see the *Selling and Fulfillment Foundation: Application Platform Configuration Guide*.

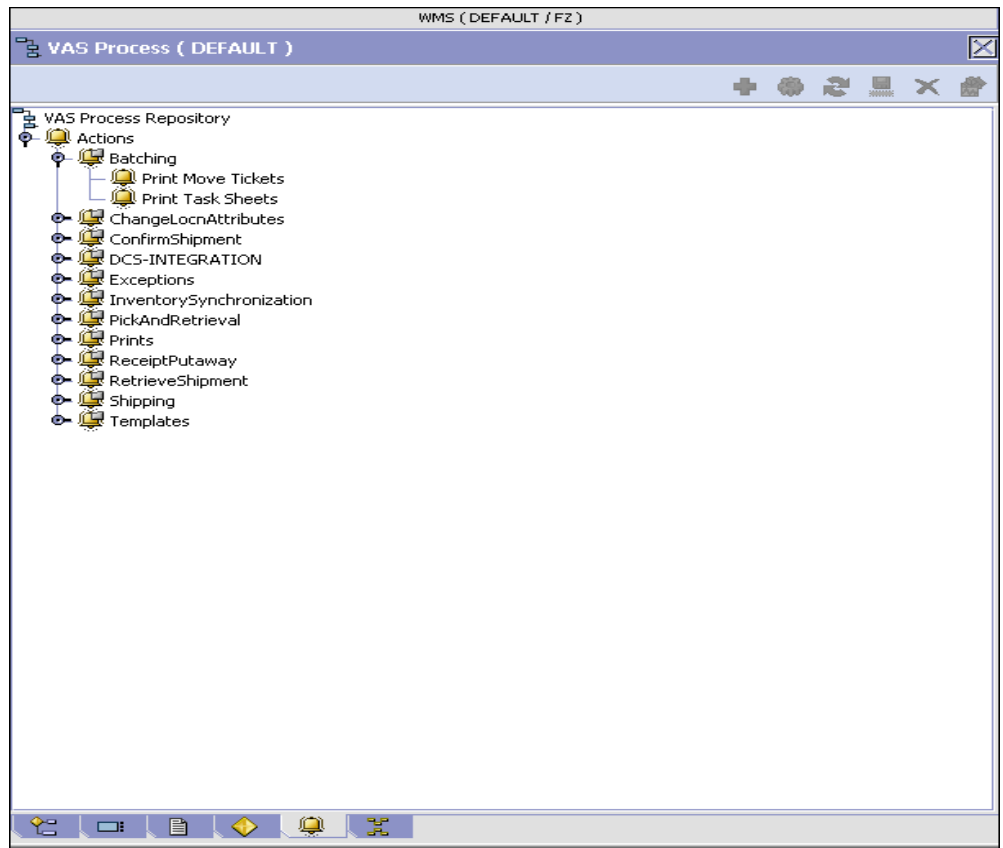

Table 8–33 Work Order VAS Pipeline - Actions Tab Window

Field	Description
Batching	Default settings are provided for: Print Move Tickets – Invokes the batch printing service for printing the move tickets. Print Task Sheets – Invokes the batch print service for printing the task sheets.
ConfirmShipment	Default settings are provided for: ConfirmShipment – Invokes the confirmShipment flow to confirm the shipment.

Table 8–33 Work Order VAS Pipeline - Actions Tab Window

Field	Description
DCS-Integration	<p>Default settings are provided for:</p> <p>InventoryDownload – Invokes the YantraWMSInventoryDownloadService service to download the inventory information from Selling and Fulfillment Foundation to DCS.</p> <p>PODownload – Invokes the YantraWMSPODownloadService service to download the Purchase Order information from Selling and Fulfillment Foundation to DCS.</p>
Exceptions	<p>Default settings are provided for:</p> <p>ShortagesDetected – Invokes the LogWavePlaFailure exception service when shortage of inventory occurs during wave release.</p>
InventorySynchronization	<p>Default settings are provided for:</p> <p>CollectInventoryMismatch – This service collects the inventory mismatch information between an external system and Selling and Fulfillment Foundation. This is typically caused when some inventory updates at a node or a warehouse are not reported to Selling and Fulfillment Foundation.</p>
PickAndRetrieval	<p>Default settings are provided for:</p> <p>ConfirmEmptyLocationAfterPick – Invokes the GenerateCountRequest flow which creates a count request.</p>

Table 8–33 Work Order VAS Pipeline - Actions Tab Window

Field	Description
Prints	<p>Default settings are provided for:</p> <p>PickList Print – Invokes the print service for printing the Pick List.</p> <p>LTL Manifest – Invokes the print service for printing the Less-than Truck Load Manifest.</p> <p>Print Load BOL – Invokes the print service for printing the Load Bill of Lading.</p> <p>Print PackList – Invokes the print service for printing the Pack List.</p> <p>Print Post Pick Container Labels – Invokes the print service for printing UCC-128 container labels for containers, when system defined packing process is used.</p> <p>Print Shipment BOL – Invokes the print service for printing the Shipment Bill of Lading.</p> <p>Print Shipping Label – Invokes the print service for printing the UCC-128 container labels.</p> <p>Print Wave – Invokes the Print service for printing a Wave.</p>
ReceiptPutaway	<p>Putaway products on receipt closure – Indicates the default action provided to automatically initiate putaway of purchase order receipts.</p>
RetrieveShipment	<p>Retrieve Requested Serial – This service invokes the retrieveShipment API to retrieve the requested serials to the specified location.</p>

Table 8–33 Work Order VAS Pipeline - Actions Tab Window

Field	Description
Shipping	Default settings are provided for: Load Left Origin – Invokes the doLoadLeftOriginUpdates service to mark that the load has left the origin. Stop Shipping – Invokes the RaiseStopShippingAlert service to raise an alert to stop the processing of the shipment.
Templates	Default settings are provided for: Log Exception – Logs the reasons due to which a count request could not be created for a Count Program. Publish Data – Sends data to external queue or internal tables. Raise Exception – Raises an alert using Event Management from the published information. Send E-mail – Raises an email action to create an e-mail in the template format from the published information. Send E-mail-HTML format – Raises an e-mail action to create an e-mail in HTML format from the published information.

8.10.8 Service Definitions

Service definitions are a representation of the logic that regulates document workflow services. The Service Builder is a graphical interface that enables you to create a graphical representation of these *services*.

For more information about Service Definitions, see the *Selling and Fulfillment Foundation: Application Platform Configuration Guide*.

To view the service definition details of a VAS pipeline:

1. From the tree in the application rules side panel, choose VAS > VAS Process > VAS Process Model. The Work Order VAS window displays.
2. In the Work Order VAS window, choose .
3. The Service Definitions tab window displays.

For more information about creating or modifying Service Definitions, see the *Selling and Fulfillment Foundation: Application Platform Configuration Guide*.

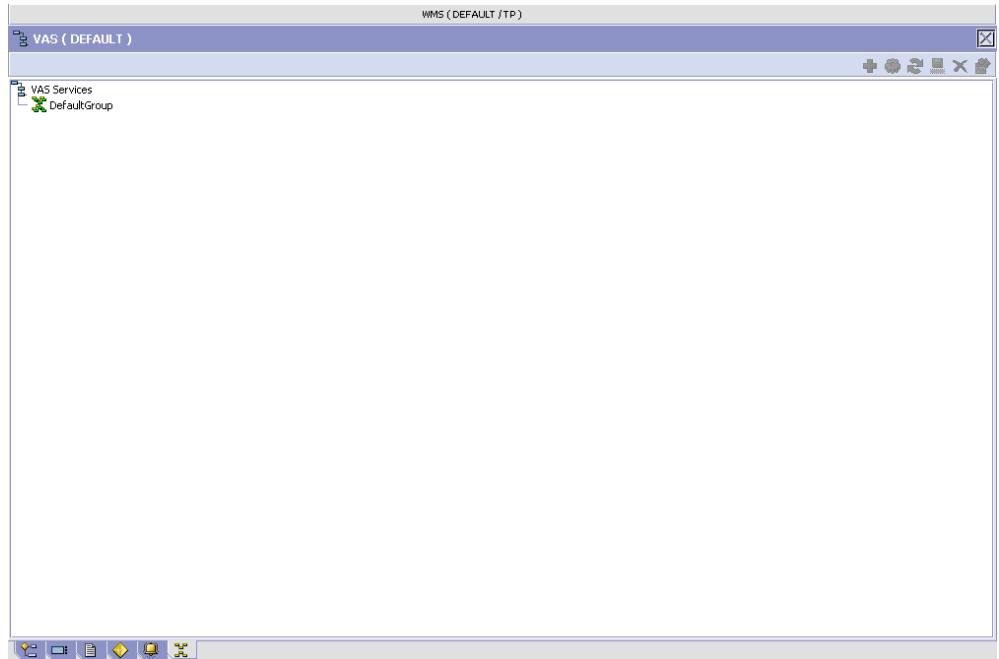

Table 8–34 Work Order VAS Pipeline - Service Definition Tab Window

Field	Description
Service Definitions	Displays service definitions that are specific to the VAS pipeline, if any.

The Sterling WMS default pipeline does not have any service definitions specified.

8.11 Defining Purge Criteria

Transactional data collected by the Sterling WMS during execution are periodically removed from the "live" transactional tables. It is common to

retain order related information for extended periods of time. There are history tables provided for relevant transactional tables to move data from the day-to-day "live" tables to a historical table.

Purge is the process by which old data is removed from the system database. A purge minimizes the number of unused database records to increase search efficiency and reduces the size of the required physical disk.

8.11.1 Setting Up Purge Criteria



To set up purge criteria:

1. From the tree in the application rules side panel, choose VAS > VAS Process > Purge Criteria. The Purge Criteria List window displays.

Purge Code	Purge Description	Retention Days
WORK_ORDER_PURGE	Work Order Purge	30
WORK_ORDER_HISTORY_PURGE	Work Order History Purge	30

Results 2

Purge Criteria List : Work Order (DEFAULT)

2. In the Purge Criteria List window, choose the Purge Code whose Purge Criteria is to be set up.
3. Choose . The Purge Criteria Details pop-up window displays.
4. Enter information in the applicable fields. Refer [Table 8–35](#) for field value descriptions.
5. Choose .

Purge Criteria Details

Purge Code: Description:

Rollback Segment: Retention Days:

Write To Log File Log File Name:

Table 8–35 Purge Criteria Details Pop-up Window

Field	Description
Purge Code	Identifies a purge program. This is a system defined code.
Description	Description of the purge.
Rollback Segment	<p>Defines the rollback segment that should be explicitly used for the purge transaction qualified by the purge code.</p> <p>This is useful when there are huge logical data sets that have to be purged. This is optional and used for order related purges.</p>
Retention Days	Enter the number of days of data to be retained in the database (going backwards from the time the program runs). Make sure that your table size takes into account the number of retention days entered here.

Table 8–35 Purge Criteria Details Pop-up Window

Field	Description
Write To Log File	Check this box if you want purged data written to a log. The log can be backed up and used as a journal at a later date.
Log File Name	<p>Enter a log file name. This is applicable only if 'Write To Log File' is checked. This file consists records of the specific table that is purged.</p> <p>The log file is created in the directory specified in the <code>yfs.purge.path</code> property. If this is not passed, it defaults to the value specified in the <code>yfs.properties</code> file. If a variable is introduced, then the <code>yfs.purge.path</code> is ignored. To modify this property, add an entry for it in the <code><INSTALL_DIR>/properties/customer_overrides.properties</code> file. For additional information about overriding properties using the <code>customer_overrides.properties</code> file, see the <i>Selling and Fulfillment Foundation: Properties Guide</i>.</p> <p>For information about file name limitations relating to internationalization, see the <i>Selling and Fulfillment Foundation: Localization Guide</i>.</p>

Configuring Packing

Packing activities in a warehouse are determined based on the strategies used in outbound planning. For example, a warehouse that containerizes on wave release (pre-pick containerization) or a warehouse that picks the product to a pack station and then performs manual containerization.

The pack process and its activities are specified here.

Use Packing for:

- [Defining Activities](#)
- [Defining Activity Constraints](#)
- [Defining Pack Planning](#)
- [Defining Inventory Containers](#)
- [Defining Shipping Containers](#)
- [Defining Pack Modification Rules](#)
- [Defining Pack Process Type Details](#)
- [Defining Pack Process Model](#)

9.1 Defining Activities

Activities in the warehouse are grouped into Activity Groups. The Sterling WMS provides a pre defined set of activity groups for a warehouse. Examples of activity groups include Receiving, VAS, Picking and Packing.

Each activity group is associated with activity codes that define each activity that is performed. For example, receiving activity group has pre-receiving, Packing and receiving activities.

The list here is specific to the Packing process.

Note: Activity Codes and Activity Constraints may be defined only when the WMS tree is loaded for Node / Hub combination.

Use Activities for:

- [Creating an Activity Code](#)
- [Modifying an Activity Code](#)
- [Deleting an Activity Code](#)
- [Setting Up Activity Constraints for Container](#)

9.1.1 Creating an Activity Code

To create an activity code:

1. From the tree in the application rules side panel, choose Packing > Activities. The Activities window displays.
2. Enter information in the applicable fields. Refer [Table 9–1](#) for field value descriptions.
3. Choose .

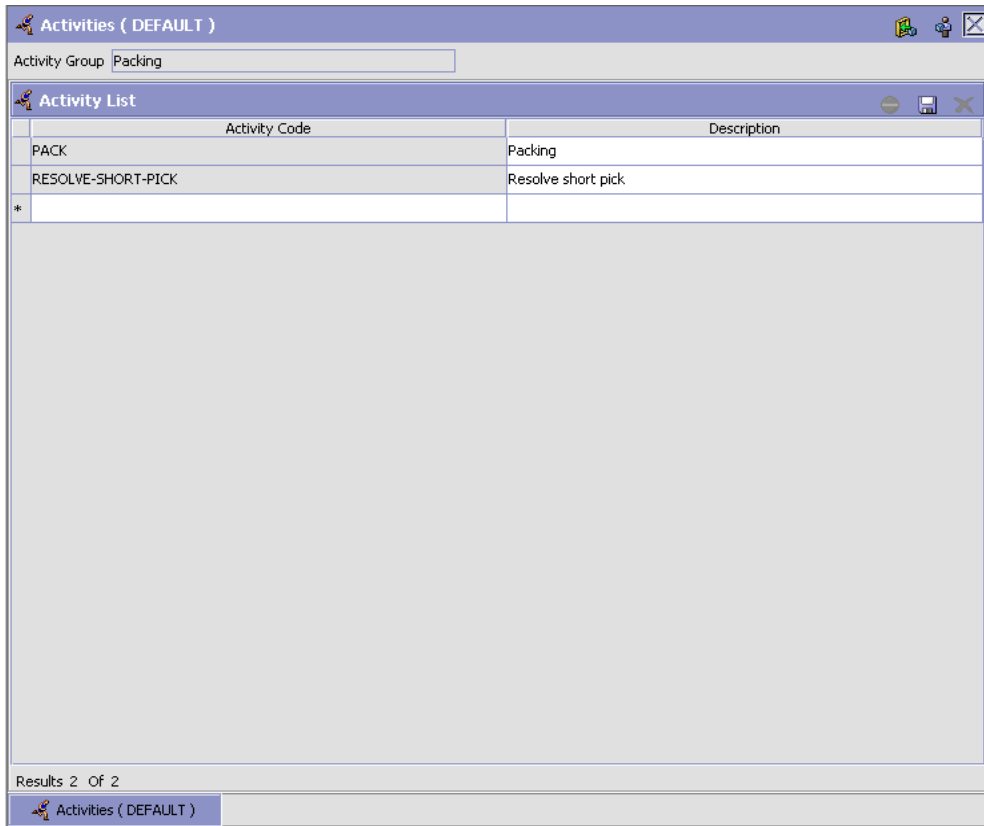



Table 9–1 Activities Window

Field	Description
Activity Group	This is automatically populated by the system as 'Packing'.
Activity List	
Activity Code	Enter a name for the activity code. Activity code is the unique identity of the activity.
Description	Enter a brief description for the activity code.

9.1.2 Modifying an Activity Code

Once an activity code has been created, it can be modified.

To modify an activity code:

1. From the tree in the application rules side panel, choose Packing > Activities. The Activities window displays, with the list of activities.
2. Enter information in the applicable fields. Refer [Table 9–1](#) for field value descriptions.
3. Choose .

It is recommended that the Sterling WMS-provided list of activity codes is not modified.

9.1.3 Deleting an Activity Code

To delete an activity code:

1. From the tree in the application rules side panel, choose Packing > Activities. The Activities window displays, with the list of activities.
2. Choose the Activity Code to be deleted.
3. Choose .

It is recommended that the Sterling WMS-provided list of activity codes is not deleted.

9.2 Defining Activity Constraints

Activities in the warehouse are performed based on attributes of the inventory being received.

The attributes considered for the activity code 'Packing' are single-SKU and multi-SKU/multi-level container, while the attribute considered for all other activity codes belonging to the Packing process is container.

NOTE: In Pack activity based on what inventory you are packing (Loose Product, inventory case, or inventory pallet) you need to go to the appropriate Activity Constraints screen.

Use Activity Constraint set-up for:

- [Setting Up Activity Constraints for Single SKU](#)
- [Setting Up Activity Constraints for Multi-SKU/Multi-Level Container](#)
- [Setting Up Activity Constraints for Container](#)

9.2.1 Setting Up Activity Constraints for Single SKU

The constraints for the activity of a single SKU are specified here.

Note: Activity constraints for single SKU is applicable only to the 'Packing' activity code.

Use Activity Constraint set-up for:

- [Creating an Activity Constraint for Single SKU](#)
- [The Applicable Putaway Strategies window is displayed.](#)
- [Modifying an Activity Constraint for Single SKU](#)
- [Deleting an Activity Constraint for Single SKU](#)

9.2.1.1 Creating an Activity Constraint for Single SKU

To create an activity constraint for single SKU:

1. From the tree in the application rules side panel, choose Packing > Activities. The Activity Search window displays, with the list of activities.
2. Choose the Activity Code whose Activity Constraint is to be set up.
3. Choose . The Activity Constraints window displays.
4. In the Activity Constraints window, choose the Single-SKU tab. The Single-SKU tab window for Activity Constraints displays.

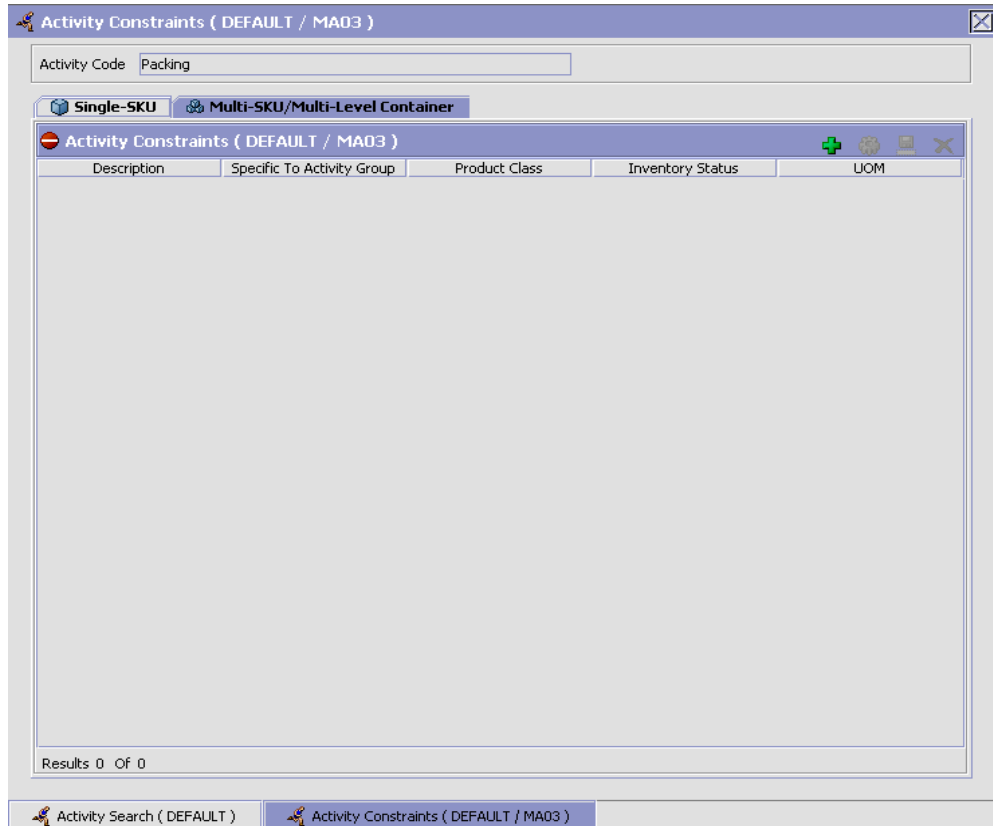



5. In the Single-SKU tab window, choose . The Activity Constraint Details window displays.
6. Enter information in the applicable fields. Refer [Table 9–2](#) for field value descriptions.
7. Choose .

Table 9–2 Activity Constraint Details - Single-SKU Tab Window

Field	Description
Description	Enter a description for the activity constraint.
To View Strategy Click here	Choose  to view or set up Putaway Strategy. For more details on setting up a putaway strategy see Setting Up Putaway Strategy for Single-SKUs . Note: Putaway strategy may be specified for the putaway preferences after the preference is saved.
Activity Code	This indicates the activity code for the constraint.

Table 9–2 Activity Constraint Details - Single-SKU Tab Window

Field	Description
Requesting Activity Group	Choose the requesting activity group. Typical values are Receipt, Packing, and Value Added Services.
Product Class	Choose the product class for the constraint, if applicable. Product class is the inventory classification of an item based on product's characteristics. Typical values are FQ - First Quality, SQ - Second Quality, etc.
Inventory Status	Choose the inventory status for the constraint, if applicable. Inventory status refers to an inventory sub classification based on the results of the inventory control processes within the warehouse.
Segment Type	Choose the segment type for the constraint, if applicable. This indicates an inventory category. Typical values are MTC – Made to Customer, and MTO - Made to Order.
Segment #	Enter the segment number for the constraint, if applicable. A segment holds either the specific buyer or specific order number that requires dedication.
UOM	Choose the UOM for the constraint, if applicable. UOM points to the Unit of measure of the item.
Container Type	The Container type associated with the UOM selected displays. Typical values are "Pallet" and "Case".
Item Classification	List of putaway item classifications for the Enterprise display. An example, Product Line is shown below.
Product Line	Choose relevant product line item classification for the putaway activity. Choose  . In the Classification window, select the applicable product line classification.
Location Priorities	

Table 9–2 Activity Constraint Details - Single-SKU Tab Window

Field	Description
Priority	<p>Enter a number to represent the priority.</p> <p>The priority is used to sequence the order in which the location priorities are evaluated. For example, all storage code level priorities are to be evaluated first before generic priorities.</p> <p>The priority needs to be a positive integer, greater than zero. This is a mandatory field.</p>
Location	<p>Choose the relevant location for the activity.</p> <p>This is a mandatory field.</p>

Setting Up Putaway Strategy for Single-SKUs

You can set up putaway strategies to putaway applicable inventory from a source zone to a target zone, based on the strategy specified.

To set up putaway strategy for single-SKUs:

1. In the Activity Constraint Details : Single SKU window, choose .
2. The Applicable Putaway Strategies window is displayed.

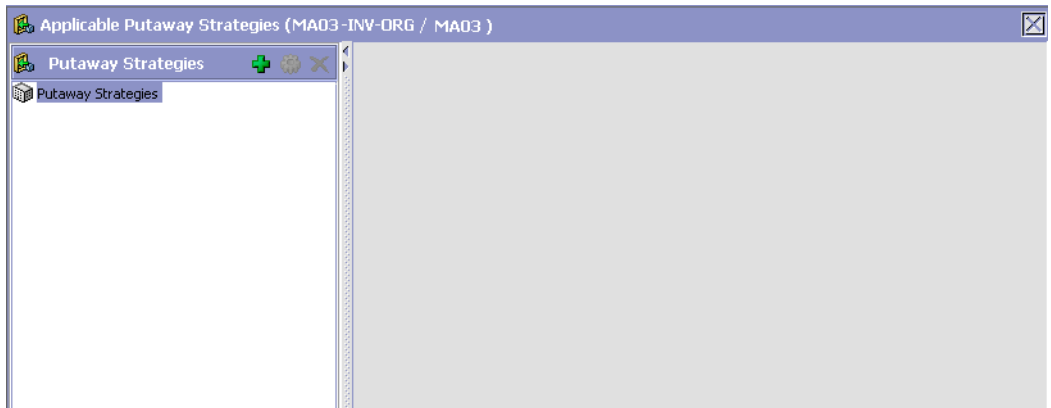

3. Choose  in the Putaway Strategies panel. The Putaway Strategy Details window appears in the right panel.
4. Enter information in the applicable fields. See the Putaway Strategy Details Window table for field value descriptions.

5. Choose .

Putaway Strategy Details

Description: Strategy for DVD-LockAndKey-EACH UOM: CASE

Item Classification:

Product Line: DVD

StorageType: LockAndKey

Product Line:

System Directed Putaway Task Types

	Source Zone	Target Zone	Container Type	Task Type
*				

Results: 0 Of 0

Ad Hoc Task Types

	Source Zone	Target Zone	Container Type	Task Type
*				

Results: 0 Of 0

Table 9–3 Putaway Strategy Details Window







Field	Description
Description	Enter a description for the Putaway Strategy.
UOM	Select the UOM for the Putaway Strategy, if applicable. Note: The UOM will be defaulted in instances where it has been specified in the Putaway Preference Details screen.
Item Classification	List of putaway item classifications for the Enterprise are displayed. An example, Product Line is shown below.
Product Line	Choose relevant product line item classification for the putaway activity. Choose  . In the Classification Values window, select the applicable product line classification.
System Directed Putaway Task Types	Displays the list of existing system directed putaway task types. You may use  to delete an existing system directed putaway task type.
Source Zone	Select the source zone from where the inventory is sourced.
Target Zone	Select the target zone to where the inventory is moved.
Container Type	Select the container type to be used to move the inventory from the source zone to the target zone. Typical values are Case and Pallet.
Task Type	Select the Putaway Task Type applicable to this putaway strategy. This field displays the list of existing system directed task types that belong to the 'PUTAWAY' activity group.
Ad hoc Task Types	Displays the list of existing ad hoc task types. You may use  to delete an existing ad hoc task type.
Source Zone	Select the source zone from where the inventory is sourced.

Table 9–3 Putaway Strategy Details Window

Field	Description
Target Zone	Select the target zone to where the inventory is moved.
Container Type	Select the container type to be used to move the inventory from the source zone to the target zone. Typical values are Case and Pallet.
Task Type	Select the Putaway Task Type applicable to this putaway strategy. This field displays the list of existing ad hoc task types that belong to the 'PUTAWAY' activity group.



9.2.1.2 Creating a New Activity Constraint for Single SKU from an Existing Activity Constraint

To create a new activity constraint for single SKU from an existing activity constraint:

1. From the tree in the application rules side panel, choose Packing > Activities. The Activity Search window displays, with the list of activities.
2. Choose the Activity Code whose Activity Constraint is to be set up.
3. Choose . The Activity Constraints window displays.
4. In the Activity Constraints window, choose the Single-SKU tab. The Single-SKU tab window for Activity Constraints displays.
5. In the Single-SKU tab window, choose the activity constraint that is to be copied from.
6. Choose . The Activity Constraint Details window displays.
7. Enter information in the applicable fields. Refer [Table 9–2](#) for field value descriptions.
8. Choose .



9.2.1.3 Modifying an Activity Constraint for Single SKU

To modify an activity constraint for single SKU:

1. From the tree in the application rules side panel, choose Packing > Activities. The Activity Search window displays, with the list of activities.
2. Choose the Activity Code whose Activity Constraint is to be modified.
3. Choose . The Activity Constraints window displays.
4. In the Activity Constraints window, choose the Single-SKU tab. The Single-SKU tab window for Activity Constraints displays.
5. In the Single-SKU tab window, choose the activity constraint that is to be modified.
6. Choose . The Activity Constraint Details window displays.
7. Enter information in the applicable fields. Refer [Table 9–2](#) for field value descriptions.
8. Choose .

9.2.1.4 Deleting an Activity Constraint for Single SKU

To delete an activity constraint for single SKU:

1. From the tree in the application rules side panel, choose Packing > Activities. The Activity Search window displays, with the list of activities.
2. Choose the Activity Code whose Activity Constraint is to be deleted.
3. Choose . The Activity Constraints window displays.
4. In the Activity Constraints window, choose the Single-SKU tab. The Single-SKU tab window for Activity Constraints displays.
5. In the Single-SKU tab window, choose the activity constraint that is to be deleted.
6. Choose .

9.2.2 Setting Up Activity Constraints for Multi-SKU/Multi-Level Container

The constraints for the activity of a multi-level case or pallet are specified here. This also applies to multi-level CASE with LPN and PALLET with LPN.

Note: Activity Constraints for Multi-SKU/Multi-Level Container is applicable only to the 'Packing' activity code.

Use the Activity Constraints for Multi-SKU/Multi-Level Container set-up for:

- [Creating an Activity Constraint for Multi-SKU/Multi-Level Container](#)
- [The Applicable Putaway Strategies window is displayed.](#)
- [Deleting an Activity Constraint for Multi-SKU/Multi-Level Container](#)

9.2.2.1 Creating an Activity Constraint for Multi-SKU/Multi-Level Container

To create an activity constraint for multi-SKU/multi-level container:

1. From the tree in the application rules side panel, choose Packing > Activities. The Activity Search window displays, with the list of activities.
2. Choose the Activity Code whose Activity Constraint is to be set up.
3. Choose . The Activity Constraints window displays.

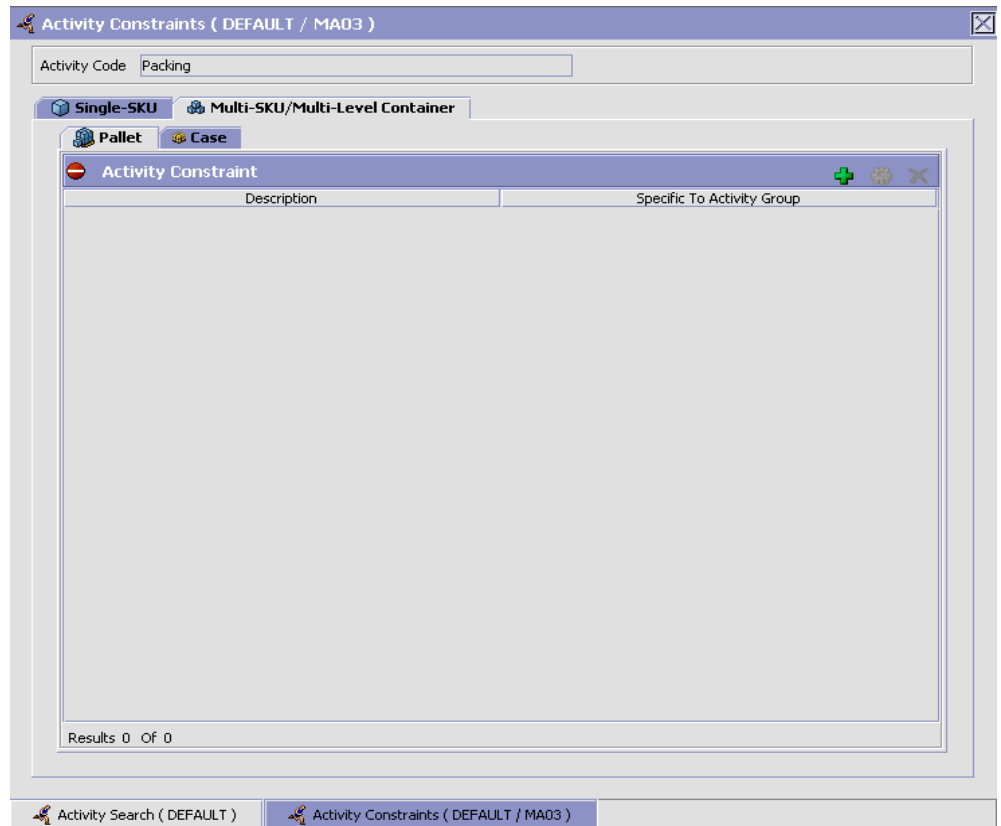



Activity Constraints for multi-level cases or pallets are specified separately:

- [Setting Up Activity Constraints for Multi-Level Pallets](#)
- [Setting Up Activity Constraints for Multi-Level Cases](#)

9.2.2.1.1 Setting Up Activity Constraints for Multi-Level Pallets

To set up activity constraints for multi-level pallets:

1. In the Multi-SKU/Multi-Level Container tab of Activity Constraints window, choose the Pallet tab. The Pallet tab window displays.
2. In the Pallet tab window, choose .

3. The Activity Constraint Details window displays.
4. Enter information in the applicable fields. Refer [Table 9–4](#) for field value descriptions.
5. Choose .

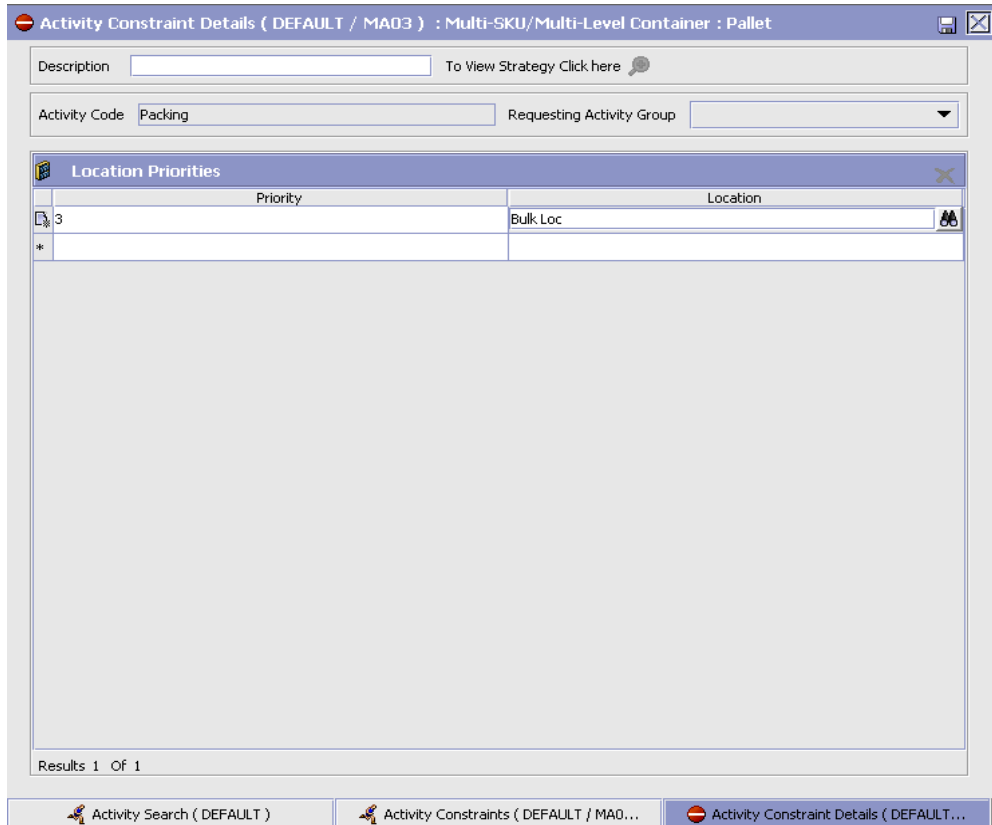

Activity Constraint Details (DEFAULT / MA03) : Multi-SKU/Multi-Level Container : Pallet

Description To View Strategy Click here 

Activity Code Requesting Activity Group

Priority	Location
3	Bulk Loc 
*	

Results 1 Of 1

Activity Search (DEFAULT) Activity Constraints (DEFAULT / MA0... Activity Constraint Details (DEFAULT...

Table 9–4 Activity Constraint Details - Multi-Level Pallet Tab

Field	Description
Description	Enter a description for the activity constraint.
To View Strategy Click here	Choose  to view or set up Putaway Strategy. For more details on setting up a putaway strategy see Setting Up Putaway Strategy for Multi-SKU/Multi-Level Containers - Pallets . Note: Putaway strategy may be specified for the putaway preferences after the preference is saved.
Activity Code	This indicates the activity code for the constraint.
Requesting Activity Group	Choose the requesting activity group. Typical values are Receipt, Packing, and Value Added Services.
Location Priorities	
Priority	Enter a number to represent the priority. The priority is used to sequence the order in which the location priorities are evaluated. For example, all storage code level priorities are to be evaluated first before generic priorities. The priority needs to be a positive integer, greater than zero. This is a mandatory field.
Location	Choose the relevant location for the activity. This is a mandatory field.



Setting Up Putaway Strategy for Multi-SKU/Multi-Level Containers - Pallets

You can set up putaway strategies to putaway applicable inventory from a source zone to a target zone, based on the strategy specified.

To set up putaway strategy for multi-SKU/multi-level container pallets:

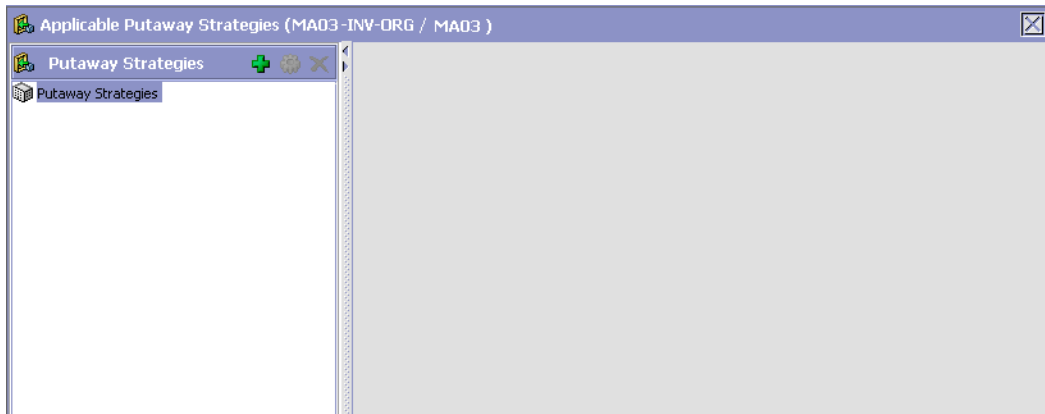
1. In the Activity Constraint Details : Multi-SKU/multi-level Containers : Pallet window, choose .
2. The Applicable Putaway Strategies window is displayed.



3. Choose  in the Putaway Strategies panel. The Putaway Strategy Details window appears in the right panel.
4. Enter information in the applicable fields. See the Putaway Strategy Details Window table for field value descriptions.
5. Choose .

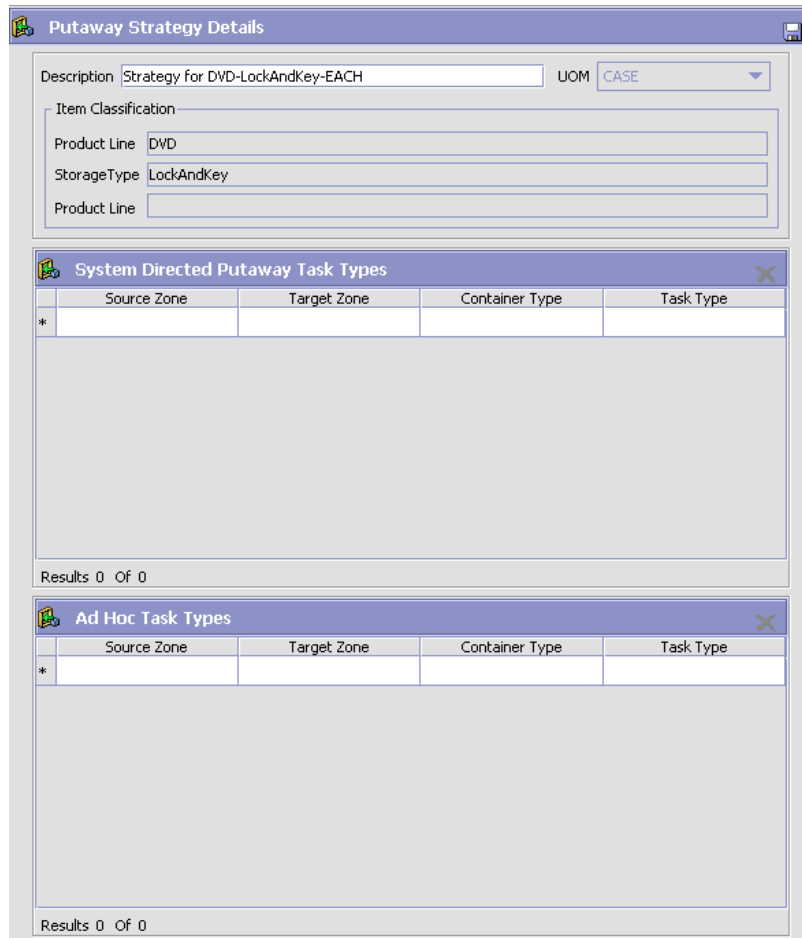

Table 9–5 Putaway Strategy Details Window

Field	Description
Description	Enter a description for the Putaway Strategy.
UOM	Select the UOM for the Putaway Strategy, if applicable. Note: The UOM will be defaulted in instances where it has been specified in the Putaway Preference Details screen.

Table 9–5 Putaway Strategy Details Window



Field	Description
Item Classification	List of putaway item classifications for the Enterprise are displayed. An example, Product Line is shown below.
Product Line	Choose relevant product line item classification for the putaway activity. Choose  . In the Classification Values window, select the applicable product line classification.
System Directed Putaway Task Types	Displays the list of existing system directed putaway task types. You may use  to delete an existing system directed putaway task type.
Source Zone	Select the source zone from where the inventory is sourced.
Target Zone	Select the target zone to where the inventory is moved.
Container Type	Select the container type to be used to move the inventory from the source zone to the target zone. Typical values are Case and Pallet.
Task Type	Select the Putaway Task Type applicable to this putaway strategy. This field displays the list of existing system directed task types that belong to the 'PUTAWAY' activity group.
Ad hoc Task Types	Displays the list of existing ad hoc task types. You may use  to delete an existing ad hoc task type.
Source Zone	Select the source zone from where the inventory is sourced.
Target Zone	Select the target zone to where the inventory is moved.

Table 9–5 Putaway Strategy Details Window



Field	Description
Container Type	Select the container type to be used to move the inventory from the source zone to the target zone. Typical values are Case and Pallet.
Task Type	Select the Putaway Task Type applicable to this putaway strategy. This field displays the list of existing ad hoc task types that belong to the 'PUTAWAY' activity group.

9.2.2.1.2 Setting Up Activity Constraints for Multi-Level Cases

To set up activity constraints for multi-level cases:

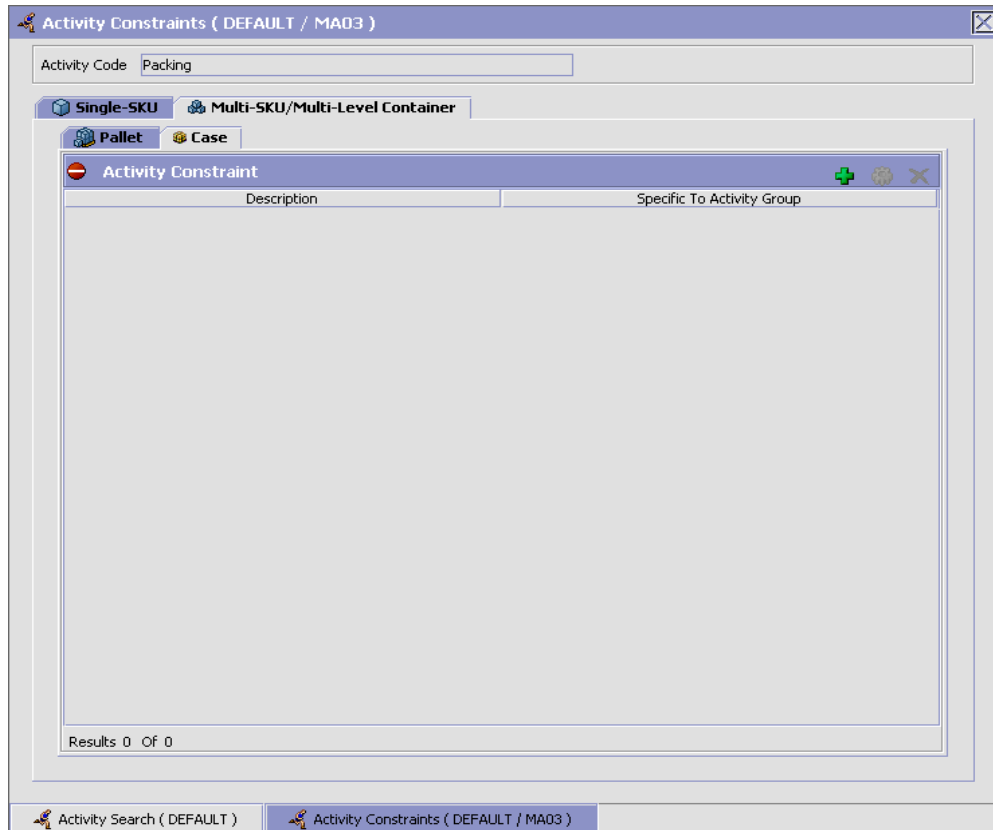
1. In the Multi-SKU/Multi-Level Container tab of Activity Constraints window, choose the Case tab. The Case tab window displays.



2. In the Case tab window, choose .
3. The Activity Constraint Details window displays.
4. Enter information in the applicable fields. Refer [Table 9-6](#) for field value descriptions.
5. Choose .

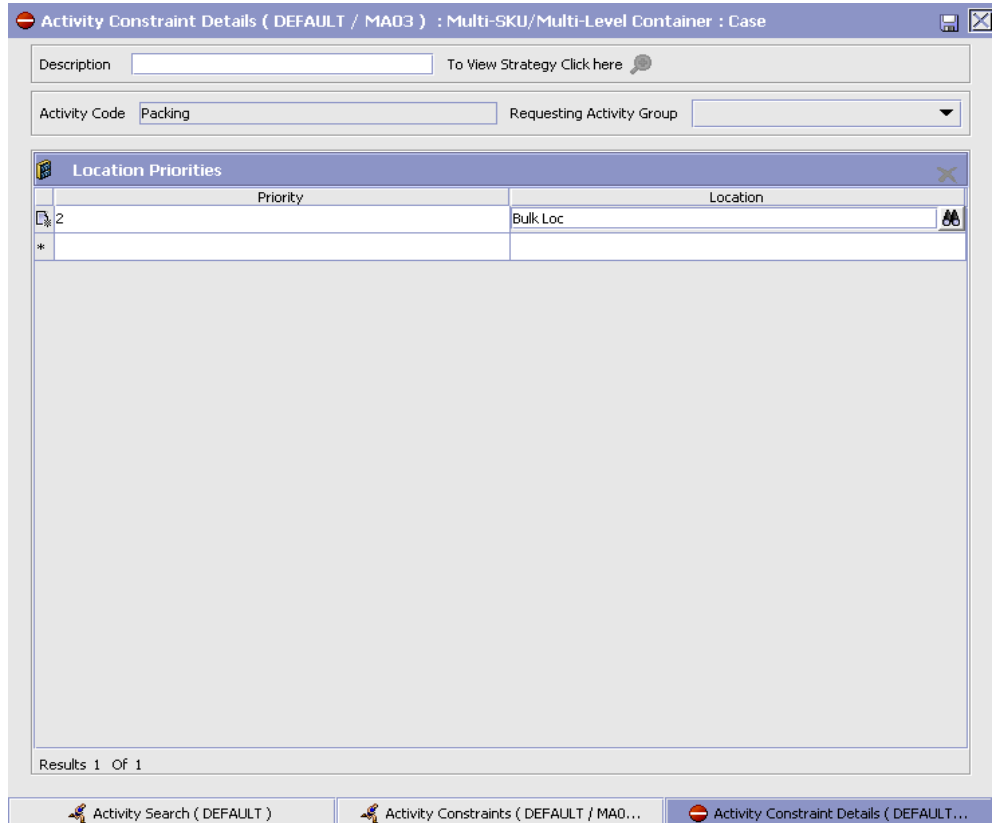

Table 9–6 Activity Constraint Details - Multi-Level Case Tab

Field	Description
Description	Enter a description for the activity constraint.
To View Strategy Click here	Choose  to view or set up Putaway Strategy. For more details on setting up a putaway strategy see Setting Up Putaway Strategy for Multi-SKU/Multi-Level Containers - Cases . Note: Putaway strategy may be specified for the putaway preferences after the preference is saved.
Activity Code	This indicates the activity code for the constraint.

Table 9–6 Activity Constraint Details - Multi-Level Case Tab

Field	Description
Requesting Activity Group	Choose the requesting activity group. Typical values are Receipt, Packing, and Value Added Services.
Location Priorities	
Priority	Enter a number to represent the priority. The priority is used to sequence the order in which the location priorities are evaluated. For example, all storage code level priorities are to be evaluated first before generic priorities. The priority needs to be a positive integer, greater than zero. This is a mandatory field.
Location	Choose the relevant location for the activity. This is a mandatory field.

Setting Up Putaway Strategy for Multi-SKU/Multi-Level Containers - Cases

You can set up putaway strategies to putaway applicable inventory from a source zone to a target zone, based on the strategy specified.

To set up putaway strategy for multi-SKU/multi-level container cases:

1. In the Activity Constraint Details : Multi-SKU/multi-level Containers : Case window, choose .
2. The Applicable Putaway Strategies window is displayed.

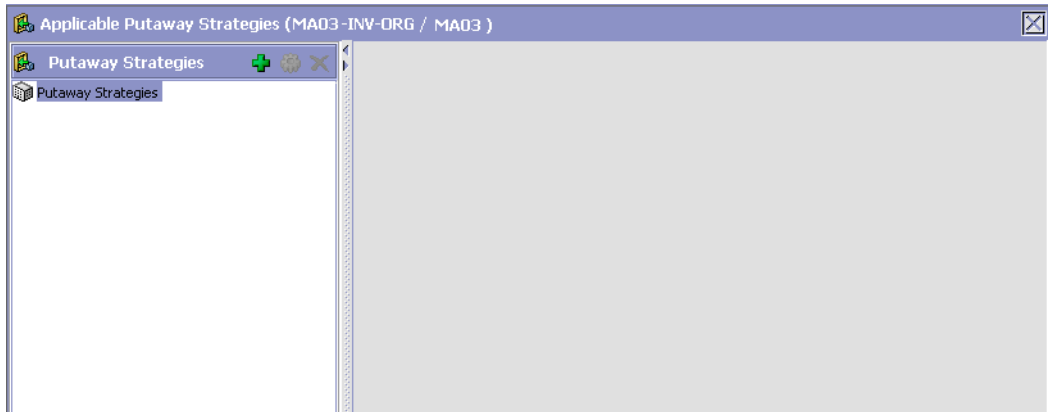



3. Choose  in the Putaway Strategies panel. The Putaway Strategy Details window appears in the right panel.
4. Enter information in the applicable fields. See the Putaway Strategy Details Window table for field value descriptions.
5. Choose .

Table 9–7 Putaway Strategy Details Window

Field	Description
Description	Enter a description for the Putaway Strategy.
UOM	Select the UOM for the Putaway Strategy, if applicable. Note: The UOM will be defaulted in instances where it has been specified in the Putaway Preference Details screen.

Table 9–7 Putaway Strategy Details Window







Field	Description
Item Classification	List of putaway item classifications for the Enterprise are displayed. An example, Product Line is shown below.
Product Line	Choose relevant product line item classification for the putaway activity. Choose  . In the Classification Values window, select the applicable product line classification.
System Directed Putaway Task Types	Displays the list of existing system directed putaway task types. You may use  to delete an existing system directed putaway task type.
Source Zone	Select the source zone from where the inventory is sourced.
Target Zone	Select the target zone to where the inventory is moved.
Container Type	Select the container type to be used to move the inventory from the source zone to the target zone. Typical values are Case and Pallet.
Task Type	Select the Putaway Task Type applicable to this putaway strategy. This field displays the list of existing system directed task types that belong to the 'PUTAWAY' activity group.
Ad hoc Task Types	Displays the list of existing ad hoc task types. You may use  to delete an existing ad hoc task type.
Source Zone	Select the source zone from where the inventory is sourced.
Target Zone	Select the target zone to where the inventory is moved.

Table 9–7 Putaway Strategy Details Window

Field	Description
Container Type	Select the container type to be used to move the inventory from the source zone to the target zone. Typical values are Case and Pallet.
Task Type	Select the Putaway Task Type applicable to this putaway strategy. This field displays the list of existing ad hoc task types that belong to the 'PUTAWAY' activity group.



9.2.2.2 Modifying an Activity Constraint for Multi-SKU/Multi-Level Container

To modify an activity constraint for multi-SKU/multi-level container:

1. From the tree in the application rules side panel, choose Packing > Activities. The Activity Search window displays, with the list of activities.
2. Choose the Activity Code whose Activity Constraint is to be modified.
3. Choose . The Activity Constraints window displays.
4. In the Activity Constraints window, choose the Multi-SKU/Multi-Level Container tab. The Multi-SKU/Multi-Level Container tab window for Activity Constraints displays.
5. In the Multi-SKU/Multi-Level Container tab window, choose the activity constraint that is to be modified.
6. Choose . The Activity Constraint Details window displays.
7. Enter information in the applicable fields. For more information about modifying the fields, see [Section 9.2.2.1.1, "Setting Up Activity Constraints for Multi-Level Pallets"](#) on page 755 and [Section 9.2.2.1.2, "Setting Up Activity Constraints for Multi-Level Cases"](#) on page 761.
8. Choose .

9.2.2.3 Deleting an Activity Constraint for Multi-SKU/Multi-Level Container

To delete an activity constraint for Multi-SKU/Multi-Level Container:

1. From the tree in the application rules side panel, choose Packing > Activities. The Activity Search window displays, with the list of activities.
2. Choose the Activity Code whose Activity Constraint is to be modified.
3. Choose . The Activity Constraints window displays.
4. In the Activity Constraints window, choose the Multi-SKU/Multi-Level Container tab. The Multi-SKU/Multi-Level Container tab window for Activity Constraints displays.
5. In the Multi-SKU/Multi-Level Container tab window, choose the activity constraint that is to be deleted.
6. Choose .

9.2.3 Setting Up Activity Constraints for Container

The constraints for the activity of a Container are specified here. This also applies to CASE with LPN and PALLET with LPN.

Note: Activity Constraints for Container is applicable to all the activity codes, other than the 'Packing' activity code.

Use the Activity Constraints for Container set-up for:

- [Creating an Activity Constraint for Container](#)
- [The Applicable Putaway Strategies window is displayed.](#)
- [Deleting an Activity Constraint for Container](#)

9.2.3.1 Creating an Activity Constraint for Container

To create an activity constraint for Container:

1. From the tree in the application rules side panel, choose Packing > Activities. The Activity Search window displays, with the list of activities.
2. Choose the Activity List whose Activity Constraint is to be set up.
3. Choose . The Activity Constraints window displays.

4. In the Activity Constraints window, choose the Container tab. The Container tab window for Activity Constraints displays.

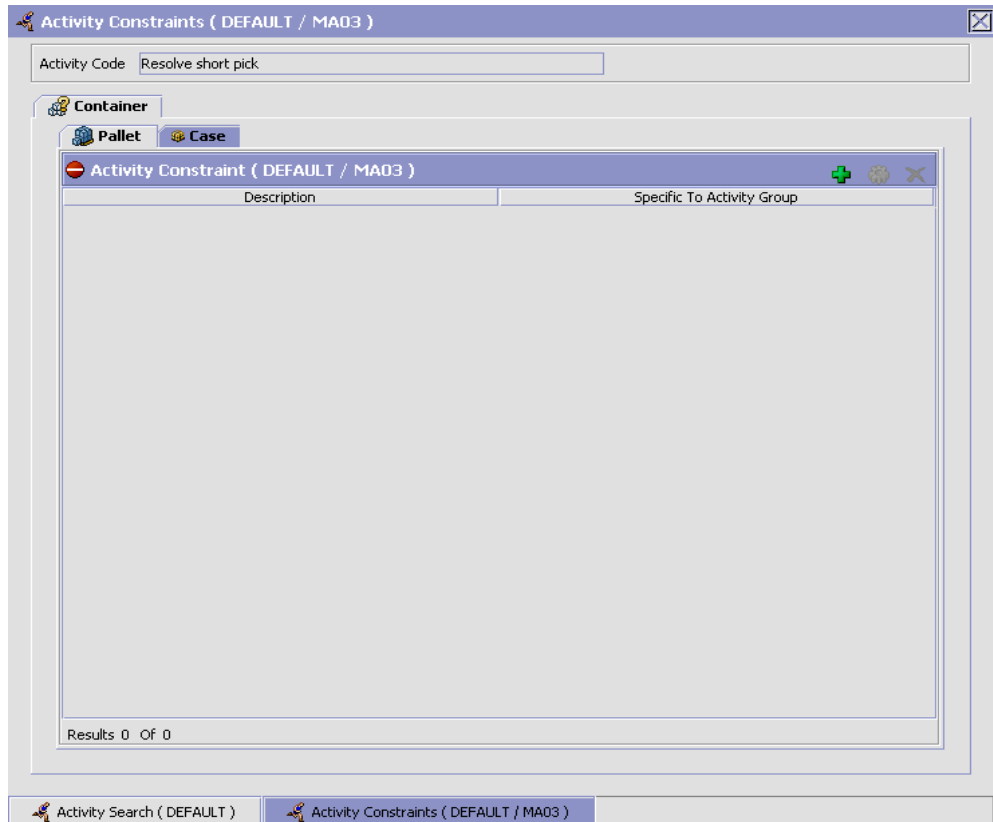



Activity Constraints for Container cases or pallets are specified separately:

- [Setting Up Activity Constraints for Pallets](#)
- [The Applicable Putaway Strategies window is displayed.](#)

9.2.3.1.1 Setting Up Activity Constraints for Pallets

To set up activity constraints for pallets:

1. In the Container tab of Activity Constraints window, choose the Pallet tab. The Pallet tab window displays.

2. In the Pallet tab window, choose .
3. The Activity Constraint Details window displays.
4. Enter information in the applicable fields. Refer [Table 9–8](#) for field value descriptions.
5. Choose .

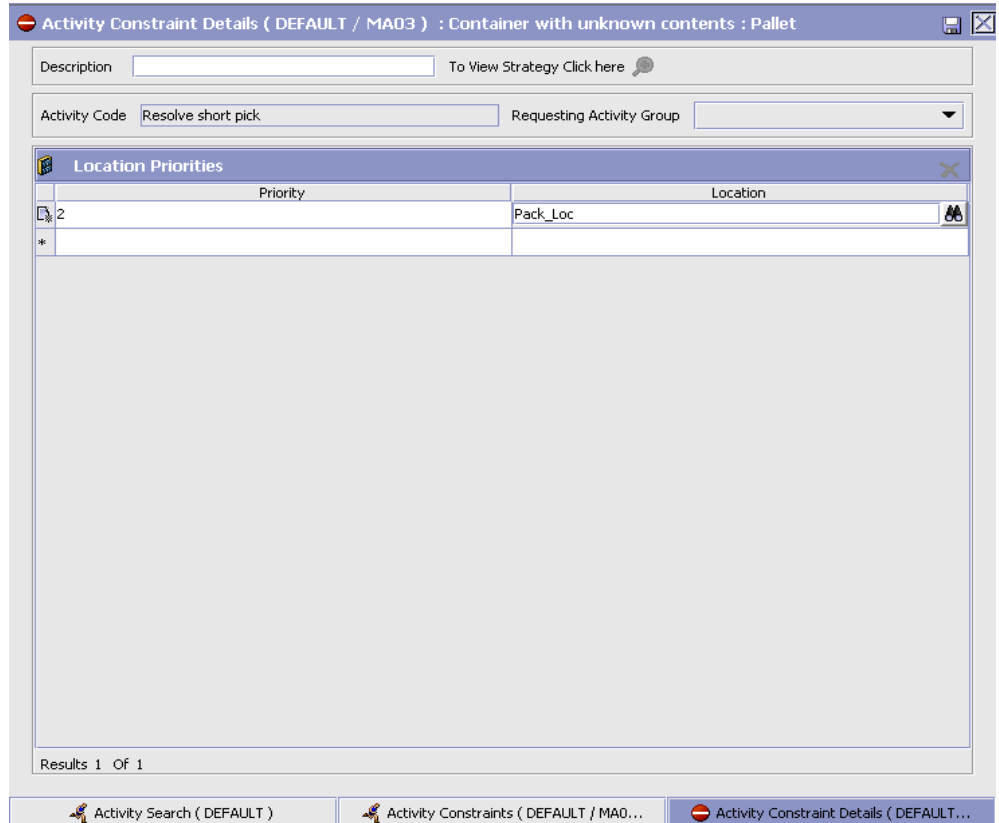



Table 9–8 Activity Constraint Details - Pallet Tab

Field	Description
Description	Enter a description for the activity constraint.
To View Strategy Click here	Choose  to view or set up Putaway Strategy. For more details on setting up a putaway strategy see Setting Up Putaway Strategy for Container with Unknown contents - Pallets . Note: Putaway strategy may be specified for the putaway preferences after the preference is saved.
Activity Code	This indicates the activity code for the constraint.
Requesting Activity Group	Choose the requesting activity group. Typical value is Outbound Picking.
Location Priorities	
Priority	Enter a number to represent the priority. The priority is used to sequence the order in which the zone priorities are evaluated. For example, all storage code level priorities are to be evaluated first before generic priorities. The priority needs to be a positive integer, greater than zero. This is a mandatory field.
Location	Choose the relevant location for the activity. This is a mandatory field.

Setting Up Putaway Strategy for Container with Unknown contents - Pallets

You can set up putaway strategies to putaway applicable inventory from a source zone to a target zone, based on the strategy specified.

To set up putaway strategy for container with unknown content pallets:

1. In the Activity Constraint Details : Container with unknown contents : Pallet window, choose .
2. The Applicable Putaway Strategies window is displayed.

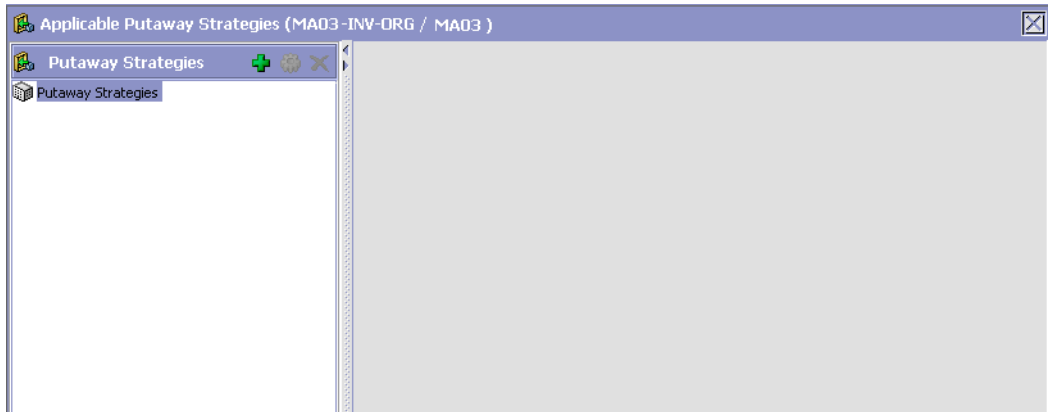



3. Choose  in the Putaway Strategies panel. The Putaway Strategy Details window appears in the right panel.
4. Enter information in the applicable fields. See the Putaway Strategy Details Window table for field value descriptions.
5. Choose .

Table 9–9 Putaway Strategy Details Window

Field	Description
Description	Enter a description for the Putaway Strategy.
UOM	Select the UOM for the Putaway Strategy, if applicable. Note: The UOM will be defaulted in instances where it has been specified in the Putaway Preference Details screen.

Table 9–9 Putaway Strategy Details Window



Field	Description
Item Classification	List of putaway item classifications for the Enterprise are displayed. An example, Product Line is shown below.
Product Line	Choose relevant product line item classification for the putaway activity. Choose  . In the Classification Values window, select the applicable product line classification.
System Directed Putaway Task Types	Displays the list of existing system directed putaway task types. You may use  to delete an existing system directed putaway task type.
Source Zone	Select the source zone from where the inventory is sourced.
Target Zone	Select the target zone to where the inventory is moved.
Container Type	Select the container type to be used to move the inventory from the source zone to the target zone. Typical values are Case and Pallet.
Task Type	Select the Putaway Task Type applicable to this putaway strategy. This field displays the list of existing system directed task types that belong to the 'PUTAWAY' activity group.
Ad hoc Task Types	Displays the list of existing ad hoc task types. You may use  to delete an existing ad hoc task type.
Source Zone	Select the source zone from where the inventory is sourced.
Target Zone	Select the target zone to where the inventory is moved.

Table 9–9 Putaway Strategy Details Window



Field	Description
Container Type	Select the container type to be used to move the inventory from the source zone to the target zone. Typical values are Case and Pallet.
Task Type	Select the Putaway Task Type applicable to this putaway strategy. This field displays the list of existing ad hoc task types that belong to the 'PUTAWAY' activity group.

9.2.3.1.2 Setting Up Activity Constraints for Cases

To set up activity constraints for cases:

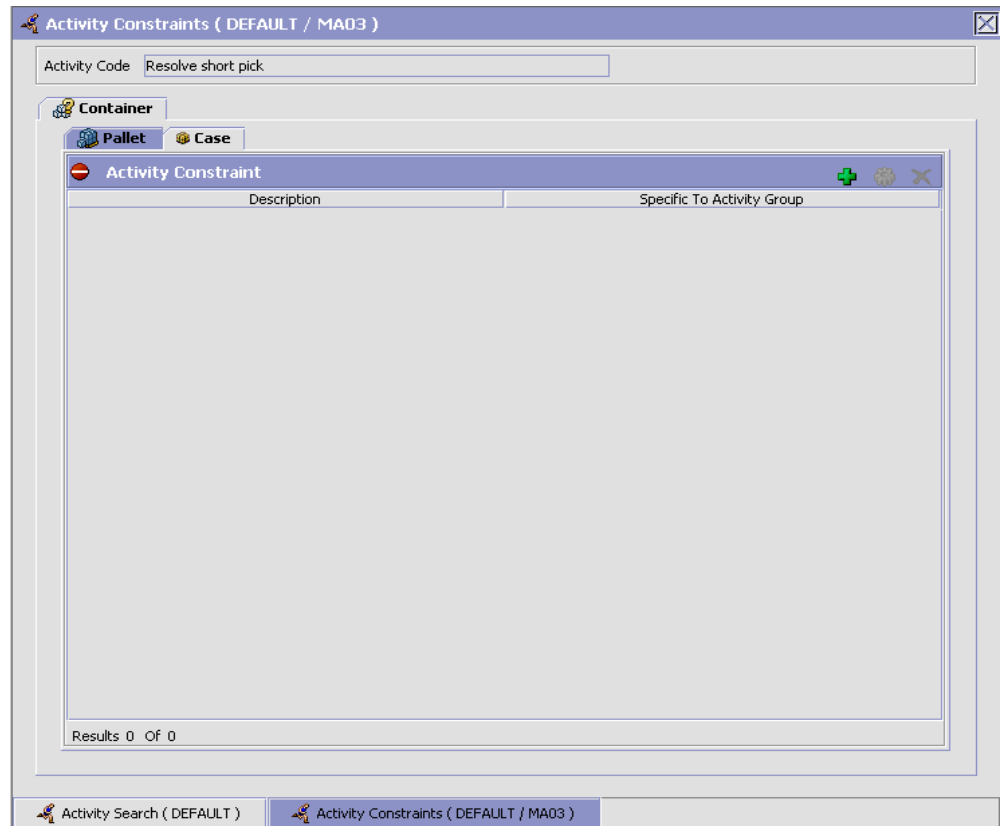
1. In the Container tab of Activity Constraints window, choose the Case tab. The Case tab window displays.



2. In the Case tab window, choose .
3. The Activity Constraint Details window displays.
4. Enter information in the applicable fields. Refer [Table 9–10](#) for field value descriptions.
5. Choose .

The screenshot shows a software window titled "Activity Constraint Details (DEFAULT / MA03) : Container with unknown contents : Case". The window contains several input fields and a table.

Fields include:

- Description: To View Strategy Click here
- Activity Code: Resolve short pick
- Requesting Activity Group:

The main section is a table titled "Location Priorities" with the following data:

	Priority	Location
	2	Pack_Loc
	1	Bulk Loc
	*	

At the bottom of the table area, it says "Results 2 Of 2".

The window's taskbar shows three tabs: "Activity Search (DEFAULT)", "Activity Constraints (DEFAULT / MA0...", and "Activity Constraint Details (DEFAULT...".

Table 9–10 Activity Constraint Details - Case Tab

Field	Description
Description	Enter a description for the activity constraint.
To View Strategy Click here	Choose to view or set up Putaway Strategy. For more details on setting up a putaway strategy see Setting Up Putaway Strategy for Container with unknown contents - Cases . Note: Putaway strategy may be specified for the putaway preferences after the preference is saved.
Activity Code	This indicates the activity code for the constraint.

Table 9–10 Activity Constraint Details - Case Tab

Field	Description
Requesting Activity Group	Choose the requesting activity group. Typical value is Outbound Picking.
Location Priorities	
Priority	Enter a number to represent the priority. The priority is used to sequence the order in which the zone priorities are evaluated. For example, all storage code level priorities are to be evaluated first before generic priorities. The priority needs to be a positive integer, greater than zero. This is a mandatory field.
Location	Choose the relevant location for the activity. This is a mandatory field.

Setting Up Putaway Strategy for Container with unknown contents - Cases

You can set up putaway strategies to putaway applicable inventory from a source zone to a target zone, based on the strategy specified.

To set up putaway strategy for Container with unknown contents cases:

1. In the Activity Constraint Details : Container with unknown content : Case window, choose .
2. The Applicable Putaway Strategies window is displayed.

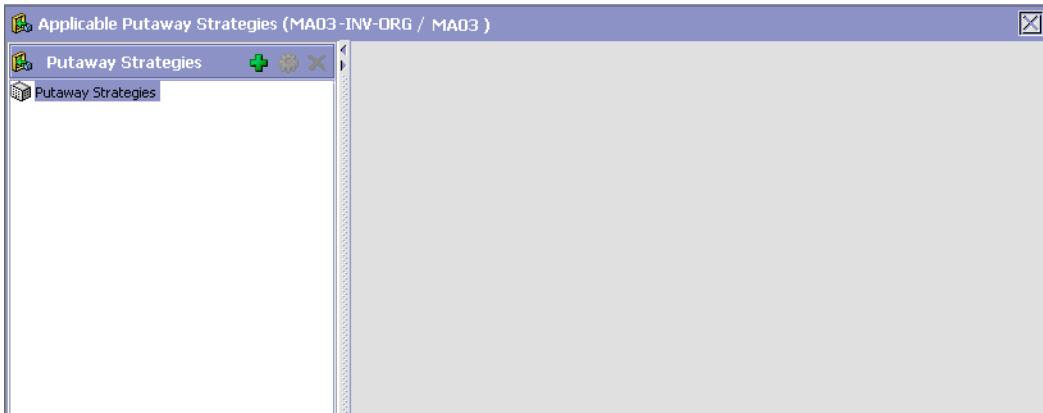



3. Choose  in the Putaway Strategies panel. The Putaway Strategy Details window appears in the right panel.
4. Enter information in the applicable fields. See the Putaway Strategy Details Window table for field value descriptions.
5. Choose .

Table 9–11 Putaway Strategy Details Window

Field	Description
Description	Enter a description for the Putaway Strategy.
UOM	Select the UOM for the Putaway Strategy, if applicable. Note: The UOM will be defaulted in instances where it has been specified in the Putaway Preference Details screen.

Table 9–11 Putaway Strategy Details Window







Field	Description
Item Classification	List of putaway item classifications for the Enterprise are displayed. An example, Product Line is shown below.
Product Line	Choose relevant product line item classification for the putaway activity. Choose  . In the Classification Values window, select the applicable product line classification.
System Directed Putaway Task Types	Displays the list of existing system directed putaway task types. You may use  to delete an existing system directed putaway task type.
Source Zone	Select the source zone from where the inventory is sourced.
Target Zone	Select the target zone to where the inventory is moved.
Container Type	Select the container type to be used to move the inventory from the source zone to the target zone. Typical values are Case and Pallet.
Task Type	Select the Putaway Task Type applicable to this putaway strategy. This field displays the list of existing system directed task types that belong to the 'PUTAWAY' activity group.
Ad hoc Task Types	Displays the list of existing ad hoc task types. You may use  to delete an existing ad hoc task type.
Source Zone	Select the source zone from where the inventory is sourced.
Target Zone	Select the target zone to where the inventory is moved.

Table 9–11 Putaway Strategy Details Window

Field	Description
Container Type	Select the container type to be used to move the inventory from the source zone to the target zone. Typical values are Case and Pallet.
Task Type	Select the Putaway Task Type applicable to this putaway strategy. This field displays the list of existing ad hoc task types that belong to the 'PUTAWAY' activity group.

9.2.3.2 Modifying an Activity Constraint for Container



To modify an activity constraint for container:

1. From the tree in the application rules side panel, choose Packing > Activities. The Activity Search window displays, with the list of activities.
2. Choose the Activity List whose Activity Constraint is to be set up.
3. Choose . The Activity Constraints window displays.
4. In the Activity Constraints window, choose the Container tab. The Container tab window for Activity Constraints displays.
5. In the Container tab window, choose the activity constraint that is to be modified.
6. Choose . The Activity Constraint Details window displays.
7. Enter information in the applicable fields. For more information about modifying the fields, see [Section 9.2.3.1.1, "Setting Up Activity Constraints for Pallets"](#) on page 770 and [Section 2, "The Applicable Putaway Strategies window is displayed."](#) on page 772.
8. Choose .

9.2.3.3 Deleting an Activity Constraint for Container

To delete an activity constraint for container:

1. From the tree in the application rules side panel, choose Packing > Activities. The Activity Search window displays, with the list of activities.
2. Choose the Activity List whose Activity Constraint is to be set up.

3. Choose . The Activity Constraints window displays.
4. In the Activity Constraints window, choose the Container tab. The Container tab window for Activity Constraints displays.
5. In the Container tab window, choose the activity constraint that is to be deleted.
6. Choose .

9.3 Defining Putaway Preferences

Inventory being received at the dock require to be putaway to appropriate locations, based on shipment attributes, item classifications and location attributes.

The preferences for putting away of inventory is specified by zone and location storage attributes, for the SKU and container attributes.

For more information on defining a putaway preference, see [Section 8.4, "Defining Putaway Preferences"](#) on page 659.

Note: Choose  in the top right corner of the Activity Search window to access the Putaway Preferences window.

9.4 Defining Retrieval Strategy

Retrieval Strategy defines the retrieval process to be followed when retrieving items for Packing. This is defined at the 'Packing' activity group level.

For more information on defining a retrieval strategy, see [Section 8.3, "Defining Retrieval Strategy"](#) on page 643.

Note: Choose  in the top right corner of the Activity Search window to access the Retrieval Strategy window.

9.5 Defining Pack Planning

Pack planning is the process of determining the parameters used when performing containerization. *Containerization* is the process of using

standardized containers for the storage and transport of loose units from a warehouse. The containers used for containerization are defined in Catalog Management. For more information about defining containers, see the *Catalog Management: Configuration Guide*.

If you pack during picking, the results of containerization are used during picking. If you pack after picking, the results of containerization are used during packing.

The actual instance of when the packing should be performed, is specified as part of Task Type configuration in pick planning. This decision affects the way in which containerization logic works. However, the parameters that govern the logic remain the same regardless of when packing is performed.

Containerization logic is governed by inbound compliance, pack strategy, and node and enterprise level parameters. This section describes the various node and enterprise level parameters governing containerization.

For more information configuring the task type to set up the instance of picking (pack during picking, or pack after picking), see [Section 12.3, "Defining Task Types"](#) on page 885.

For more information about Pick Planning, see [Section 7.2, "Defining Pick Planning Parameters"](#) on page 549.

To define pack planning parameters:

1. From the tree in the application rules side panel, choose Packing > Pack Planning. The Pack Planning window displays.
2. Enter information in the applicable fields. Refer [Table 9–12](#) for field value descriptions.
3. Choose .

Pack Planning (DEFAULT / MA03)

Limit number of SKUs per case to

Do not mix in a case

Customer PO # Department Code
 Item ID Mark For
 Product Class Unit Of Measure

Do not mix in a pallet

Customer PO # Department Code
 Item ID Mark For
 Product Class Unit Of Measure

Overpack product under following conditions

Overpack when containerization category is in

StorageType PickingType

ItemType

ProductLine

And case volume is less than Cubic Inches

Containers

Use only these containers

Parcel Shipments **Other Shipments**

Shipping Container Marking

SCM not required
 SCM required without content
 SCM required with content

SCM Label Level

Do not apply SCM
 Apply SCM on all cases
 Apply SCM on all shipping units (cases or pallets)

Settings for pack after pick process

Containerization is done by system

Only for items with containerization category in

StorageType PickingType

ItemType

ProductLine

Containerization is performed

Upfront during wave release While packing, upon request

Pack Planning (DEFAULT / MA03)

Table 9–12 Pack Planning Window

Field	Description
Limit number of SKUs per case to	Enter the maximum number of SKUs that can be packed into a case.
Do not mix in a case	Note: The items with classification purpose 'Container Category Classification' are never mixed in a container, irrespective of the Do Not Mix constraints settings.

Table 9–12 Pack Planning Window

Field	Description
Customer PO #	Select this field if you do not want SKUs for shipments with different customer purchase order numbers to be packed into the same case.
Department Code	Select this field if you do not want SKUs for shipments with different department codes to be packed into the same case.
Item ID	Select this field if you do not want SKUs with different item IDs to be packed into the same case.
Mark For	Select this field if you do not want SKUs for shipments with different mark for addresses to be packed into the same case.
Product Class	Select this field if you do not want SKUs with different product classes to be packed into the same case.
Unit of Measure	Select this field if you do not want SKUs with different units of measure to be packed into the same case.
Do not mix in a pallet	Note: The items with classification purpose 'Container Category Classification' are never mixed in a container, irrespective of the Do Not Mix constraints settings.
Customer PO #	Select this field if you do not want SKUs for shipments with different customer purchase order numbers to be packed onto the same pallet.
Department Code	Select this field if you do not want SKUs for shipments with different department codes to be packed onto the same pallet.
Item ID	Select this field if you do not want SKUs with different item IDs to be packed onto the same pallet.
Mark For	Select this field if you do not want SKUs for shipments with different mark for addresses to be packed onto the same pallet.
Product Class	Select this field if you do not want SKUs with different product classes to be packed onto the same pallet.
Unit of Measure	Select this field if you do not want SKUs with different units of measure to be packed onto the same pallet.
Overpack product under following conditions	

Table 9–12 Pack Planning Window



Field	Description
Overpack when containerization category is in	<p>You can specify the containerization categories that you want to allow overpacking for. For more information about containerization categories, see the <i>Catalog Management: Configuration Guide</i>.</p> <p>By default, five container category classification purposes are provided to perform containerization based on multiple item attributes. You can configure these container category classification purposes to be associated with the item attributes, for example, StorageType, ItemType, ProductLine, and so on as per your requirements.</p> <p>You can reserve a container for the items belonging to all the containerization categories that are configured in the system.</p> <p>Choose  of the container category classification purpose that you want to perform overpacking for. The List of Values pop-up window displays. Select the blank line and choose a containerization category from the drop-down menu. When you have finished adding containerization categories, choose OK.</p>
And case volume is less than	Enter the volume that the case volume must be less than, for overpacking to occur for the specified containerization categories.
Containers	
Use only following containers	You can specify the specific containers you want to use for this packing plan.
Parcel Shipments and Other Shipments Tabs	You can specify the parameters for both parcel shipments and other shipments. The fields on both tabs are identical.
Shipping Container Marking	
SCM not required	Select this field if a shipping container marking is not required on a container.
SCM required without content	Select this field if a shipping container marking is required on a container but does not have to describe the contents.

Table 9–12 Pack Planning Window

Field	Description
SCM required with content	Select this field if a shipping container marking is required on a container with all applicable information about the contents.
SCM Label Level	
Do not apply SCM	If you selected 'SCM not required', this field is automatically chosen.
Apply SCM on all cases	If you specified that shipment container markings are required, choose this field if you want to apply them on cases only.
Apply SCM on all shipping units (cases or pallets)	If you specified that shipment container markings are required, choose this field if you want to apply them on cases and pallets.
Settings for pack after pick process	
Containerization is done by system	<p>Select this field to indicate that containerization is performed by the system.</p> <p>If this field is not selected, containerization must be done manually.</p> <p>Note: When containerization is performed manually, the constraints that you specify in this window are still applied.</p> <p>This field is to be selected if you want the cartonization to be carried out after Picking.</p>

Table 9–12 Pack Planning Window

Field	Description
<p>Only for items with containerization category in</p>	<p>You can define containerization settings which are applicable only for items belonging to the specified containerization category. When an item does not fall under a specified containerization category, then the containerization for that item is done manually.</p> <p>By default, five container category classification purposes are provided to perform containerization based on multiple item attributes. You can configure these container category classification purposes to be associated with the item attributes, for example, StorageType, ItemType, ProductLine, and so on as per your requirements.</p> <p>You can reserve a container for the items belonging to all the containerization categories that are configured in the system.</p> <p>Choose  of the container category classification purpose that you want to include in the containerization settings. The List of Values pop-up window displays. Select the blank line and choose a containerization category from the drop-down menu. When you have finished adding containerization categories, choose OK.</p>
<p>Containerization is performed</p>	<p>Choose 'Upfront during wave release' if you want containerization to be determined when the system is releasing a wave.</p> <p>Choose 'While packing, upon request' if you want containerization to be determined at the time of packing when requested by the packer.</p>

Over pack is specified for items that have case packs that are smaller than regular outbound containers and can be packed with other items. This reduces the handling charges for the shipment.

Full Containerization and Loose Containerization

Full Containerization, refers to an instance where CASE or PALLET quantities are picked into a container. Loose Containerization, on the other hand, refers to an instance where loose quantities (even if across SKUs) are picked into the container.

Full Containerization is done when a Task Type is configured as Pick Full Pallets. For more information configuring the task type, see [Section 12.3, "Defining Task Types"](#) on page 885.

For example, Loose Containerization applies in a scenario where Do Not Mix constraints are set, and Pick Task has been configured to pick into carton or apply labels.

Do not mix constraints ONLY applies to Loose cartons and NOT to standard case/pallet picks. The system containerization process does not support multi-SKU palletization. It only deals with cartonization for single-SKU/multi-SKU cases and single-SKU pallets.

On the other hand, in an instance where the Do Not Mix Constraints has been set up in Pack Strategy, SCM Required=Y with system containerization, and pick tasks have been set to pick into carton or apply labels, the containers for loose cases, full cases, and full pallets are created.

To undertake Full Containerization using containerizeWave for per-pick scenario, select "Containerization is done by the system" and "Upfront during wave release," in the pack planning setting of pack after pick process.

Post-Pick Containerization and Pre-Pick Containerization

Post-Pick Containerization is when containerization is done by the system after the Picking process. To set up a containerization as post-pick, you need to select 'Use System Containerization' field, and the 'While packing, upon request' option in 'Containerization is performed' field in the 'Settings for Pack after Pick Process' in the Pack Planning window.

Pre-Pick Containerization is when containerization is done by the system before the Picking process. Pre-Pick Containerization is done when the 'Pack while Pick' and the 'Use System Containerization' fields are checked in the Task Type Wizard, while configuring the Task Type.

For more information configuring the task type, see [Section 12.3, "Defining Task Types"](#) on page 885.

Shipping Container Marking Settings for Movement of Inventory

The relationship between Shipping Container Marking (SCM) settings and movement of inventory to Ship Sort / Pack Location is illustrated in [Table 9–13](#):

Table 9–13 Inventory Movement to Ship Sort Location

Shipping Container Marking	Deposit Location	Inventory Location	Description
SCM not required	Ship Sort Location	Ship Sort Location	In this strategy user has picked the inventory. Ship Sort Location is suggested as Deposit location. Inventory is also moved to Ship Sort Location.
SCM required without content	Pack Location	Ship Sort Location	In this strategy user has picked the inventory, where Task Type is 'Picking into Equipment'. Pack Location is suggested as Deposit location. Inventory is physically present at the Pack Location but according to the system it is present in the Ship Sort Location.
SCM required without content	Ship Sort Location	Ship Sort Location	In this strategy user has picked the inventory, where Task Type is 'Picking into Inventory case or pallet'. Ship Sort Location is suggested as Deposit location. Inventory is moved to Ship Sort Location.
SCM required with content	Pack Location	Pack Location	In this strategy user has picked the inventory. Pack Location is suggested as Deposit location. Inventory is also moved to Pack Location.

The above mentioned relationship is independent of 'Pack While Picking' settings. When 'Pack While Picking' is set to YES, and the above options are exhausted, the action taken is in accordance with the Container

Routing set up under the Container Pipeline. The order of action undertaken is Next Action Location, Carrier Sort Location, Ship Sort Location, Source Drop Off, and User Override.

9.6 Defining Container Build

Containers may be built in a warehouse either during retrieval or picking or after packing is complete. The placing of items or cases into a container is based on the process being employed.

Typically, containers are built to group cases during the manifesting or trailer loading or due to customer (buyer) compliance during the outbound process. Containers are also built to move items or cases or items in the warehouse from one location to another or for pack and hold activities. Therefore, the container build is either for inventory movements referred to as “inventory containers”, or for outbound shipments referred to as “outbound containers”.

The attributes to consider while defining inventory containers or shipping containers are specified here.

9.7 Defining Inventory Containers

Inventory containers in the Sterling WMS are used to associate multiple cases or items into a pallet to facilitate subsequent putaway and retrieval at the pallet level. Before the manifesting process for parcel shipments, inventory containers may be built to ensure that all containers associated with a shipment are shipped together.

Use Build Inventory Containers for:

- [Creating an Inventory Container](#)
- [Modifying an Inventory Container](#)
- [Deleting an Inventory Container](#)
- [Setting Up Activity Constraints for Inventory Containers](#)
- [Defining Putaway Strategy](#)
- [Defining Retrieval Strategy](#)

9.7.1 Creating an Inventory Container

To create an inventory container:

1. From the tree in the application rules side panel, choose Packing > Container Build > Build Inventory Containers. The Activity Search window displays.
2. Enter information in the applicable fields. Refer [Table 9–14](#) for field value descriptions.
3. Choose .

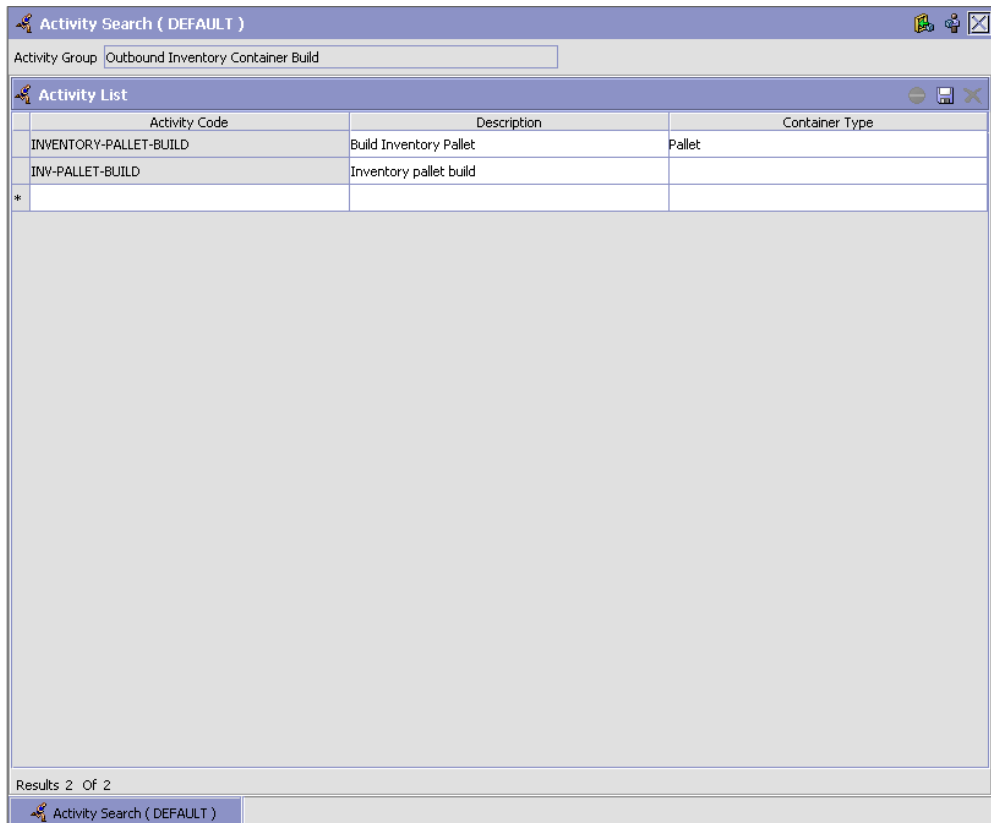

Activity Search (DEFAULT)

Activity Group: Outbound Inventory Container Build

Activity Code	Description	Container Type
INVENTORY-PALLET-BUILD	Build Inventory Pallet	Pallet
INV-PALLET-BUILD	Inventory pallet build	
*		

Results 2 Of 2

Activity Search (DEFAULT)

Table 9–14 Activity Search Window

Field	Description
Activity Group	This is automatically populated by the system as 'Outbound Inventory Container Build'.
Activity List	
Activity Code	Enter a name for the activity code. Activity code is the unique identity of the activity.
Description	Enter a brief description for the activity code.
Container Type	Choose container type for the activity code. The container type may be Pallet or Case.

The contents of inventory containers are visible either through the Location Inventory console or through the corresponding shipment (pack and hold).

9.7.2 Modifying an Inventory Container

Once an inventory container has been created, it can be modified.

To modify an inventory container:

1. From the tree in the application rules side panel, choose Packing > Container Build > Build Inventory Containers. The Activity Search window displays with the list of activities.
2. Enter information in the applicable fields. Refer [Table 9–14](#) for field value descriptions.
3. Choose .

It is recommended that the Sterling WMS-provided list of activity codes is not modified.

9.7.3 Deleting an Inventory Container

To delete an inventory container:

1. From the tree in the application rules side panel, choose Packing > Container Build > Build Inventory Containers. The Activity Search window displays with the list of activities.
2. Choose the Activity List to be deleted.

3. Choose .

It is recommended that the Sterling WMS-provided list of activity codes is not deleted.

9.7.4 Setting Up Activity Constraints for Inventory Containers

Activities in the warehouse are performed based on attributes of the inventory being received. The attributes considered are single SKU inventory, multi-SKU inventory and container.

Inventory Container is used to specify the constraints for the activity of a container. This also applies to CASE with LPN and PALLET with LPN.

To set up activity constraints for an inventory container:

1. From the tree in the application rules side panel, choose Packing > Container Build > Build Inventory Containers. The Activity Search window displays with the list of activities.
2. Choose the Activity List whose Activity Constraint is to be set up.
3. Choose . The Container Build Constraint Details window displays.
4. Enter information in the applicable fields. Refer [Table 9–15](#) for field value descriptions.

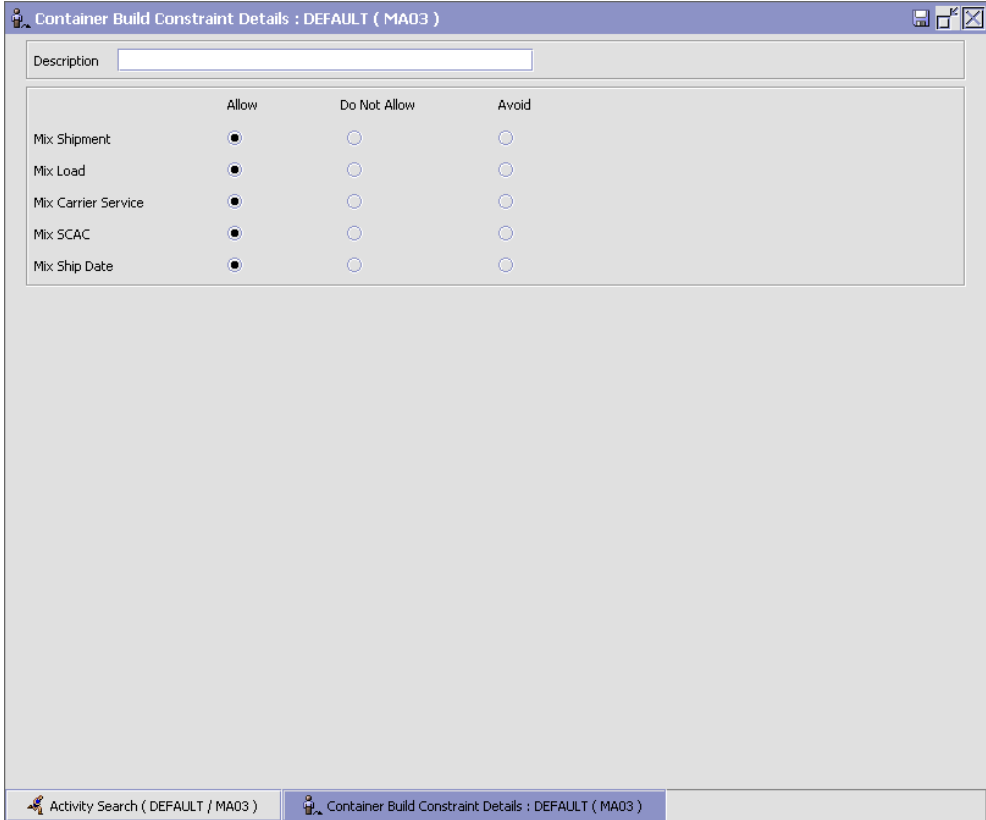

Table 9–15 Container Build Constraint Details Window

Field	Description
Description	Enter a description for the activity constraint.
	<p>Allow – Select if activities with differences in said attributes should be allowed to be mixed.</p> <p>Do Not Allow – Select if activities with differences in said attributes should not be allowed to be mixed.</p> <p>Avoid – Select if the mixing of activities with differences in said attributes should be avoided. The algorithm first uses the 'Do Not Allow' feature, and uses the 'Allow' feature if no location is found.</p>

Table 9–15 Container Build Constraint Details Window

Field	Description
Mix Shipment	Select if activities belonging to different shipments can be mixed.
Mix Load	Select if activities belonging to different loads can be mixed.
Mix Carrier Service	Select if activities belonging to different carrier services can be mixed.
Mix SCAC	Select if activities belonging to different SCAC can be mixed.
Mix Ship Date	Select if activities belonging to different ship dates can be mixed.

9.7.5 Defining Putaway Strategy

Inventory being received at the dock require to be putaway to appropriate locations, based on shipment attributes, item classifications and location attributes.

The preferences for putting away of inventory is specified by zone and location storage attributes, for the SKU and container attributes.

For more information on defining a putaway strategy, see [Section 8.4, "Defining Putaway Preferences"](#) on page 659.

Note: Choose  in the top right corner of the Activity Search window to access the Putaway Strategy window.

9.7.6 Defining Retrieval Strategy

Retrieval Strategy defines the retrieval process to be followed when retrieving items for Packing. This is defined at the 'Packing' activity group level.

For more information on defining a retrieval strategy, see [Section 8.3, "Defining Retrieval Strategy"](#) on page 643.

Note: Choose  in the top right corner of the Activity Search window to access the Retrieval Strategy window.

9.8 Defining Shipping Containers

Outbound (shipping) containers are built to customer (buyer) or carrier or warehouse process requirements. Containers are normally built considering shipments or loads or the pack and hold date of a shipment. Buyer compliance requirements including mixing of mark-for, customer purchase orders are also considered.

The temporary building of pack and hold containers, before the actual shipping of shipment, is considered as inventory containers. For more information about Inventory Containers, see [Section 9.7, "Defining Inventory Containers"](#) on page 793.

Use Build Shipping Containers for:

- [Creating a Shipping Container](#)
- [Modifying a Shipping Container](#)
- [Deleting a Shipping Container](#)
- [Setting Up Activity Constraints for Shipping Containers](#)
- [Defining Putaway Strategy](#)
- [Defining Retrieval Strategy](#)

9.8.1 Creating a Shipping Container

To create a shipping container:

1. From the tree in the application rules side panel, choose Packing > Container Build > Build Shipping Containers. The Activity Search window displays.
2. Enter information in the applicable fields. Refer [Table 9–16](#) for field value descriptions.
3. Choose .

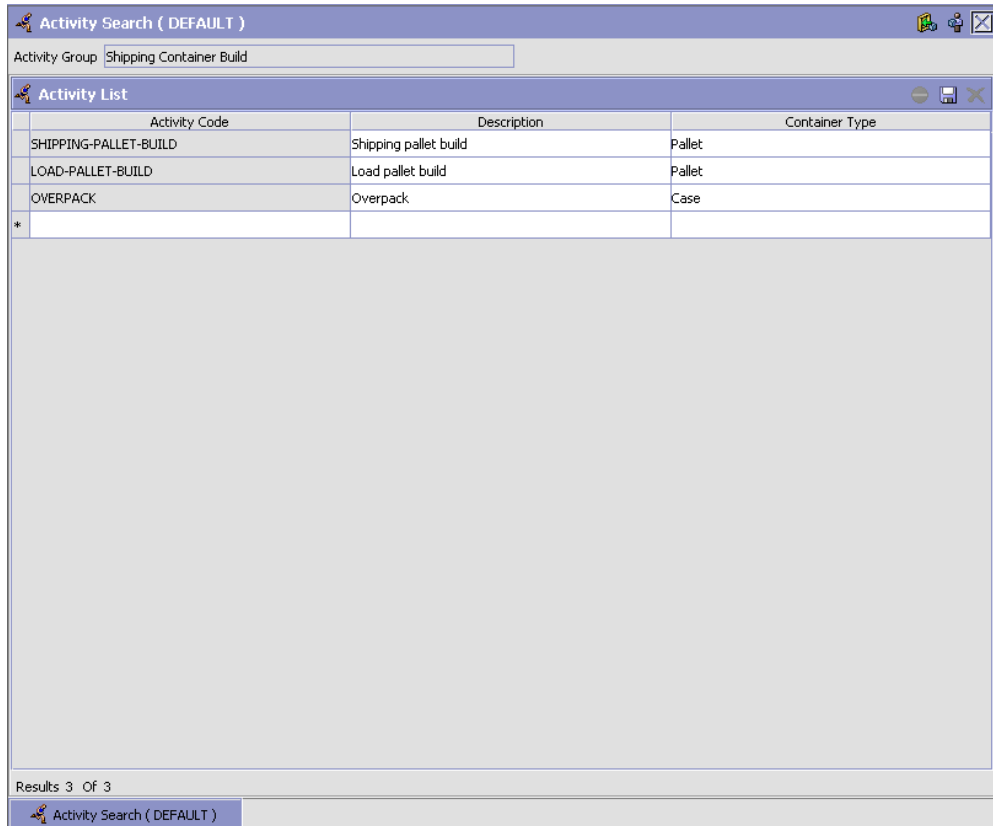

Table 9–16 Activity Search Window

Field	Description
Activity Group	This is automatically populated by the system as 'Shipping Container Build'.
Activity List	
Activity Code	Enter a name for the activity code. Activity code is the unique identity of the activity.

Table 9–16 Activity Search Window

Field	Description
Description	Enter a brief description for the activity code.
Container Type	Choose container type for the activity code. The container type may be Pallet or Case.

The contents of inventory containers are visible either through the Location Inventory console or through the corresponding shipment (pack and hold).

9.8.2 Modifying a Shipping Container

Once a shipping container has been created, it can be modified.

To modify a shipping container:

1. From the tree in the application rules side panel, choose Packing > Container Build > Build Shipping Containers. The Activity Search window displays with the list of activities.
2. Enter information in the applicable fields. Refer [Table 9–16](#) for field value descriptions.
3. Choose .

It is recommended that the Sterling WMS-provided list of activity codes is not modified.

9.8.3 Deleting a Shipping Container

To delete a shipping container:

1. From the tree in the application rules side panel, choose Packing > Container Build > Build Shipping Containers. The Activity Search window displays with the list of activities.
2. Choose the Activity List to be deleted.
3. Choose .



It is recommended that the Sterling WMS-provided list of activity codes is not deleted.

9.8.4 Setting Up Activity Constraints for Shipping Containers

Activities in the warehouse are performed based on attributes of the inventory being received. The attributes considered are single SKU inventory, multi-SKU inventory and container.

Shipping Container is used to specify the constraints for the activity of a container. This also applies to CASE with LPN and PALLET with LPN.

To set up activity constraint for a shipping container:

1. From the tree in the application rules side panel, choose Packing > Container Build > Build Shipping Containers. The Activity Search window displays with the list of activities.
2. Choose the Activity List whose Activity Constraint is to be set up.
3. Choose . The Container Build Constraint Details window displays.
4. Enter information in the applicable fields. Refer [Table 9–17](#) for field value descriptions.
5. Choose .

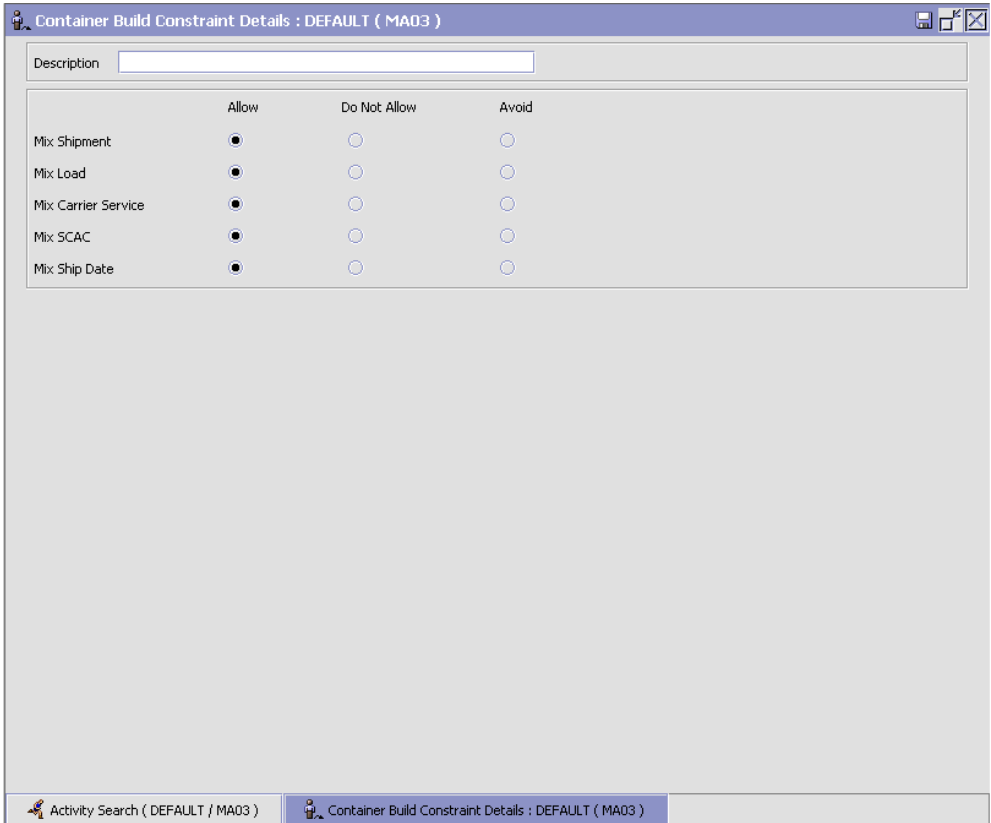

Table 9–17 Container Build Constraint Details Window

Field	Description
Description	Enter a description for the activity constraint.
	<p>Allow – Select if activities with differences in said attributes should be allowed to be mixed.</p> <p>Do Not Allow – Select if activities with differences in said attributes should not be allowed to be mixed.</p> <p>Avoid – Select if the mixing of activities with differences in said attributes should be avoided. The algorithm first uses the 'Do Not Allow' feature, and uses the 'Allow' feature if no location is found.</p>

Table 9–17 Container Build Constraint Details Window

Field	Description
Mix Shipment	Select if activities belonging to different shipments can be mixed.
Mix Load	Select if activities belonging to different loads can be mixed.
Mix Carrier Service	Select if activities belonging to different carrier services can be mixed. Note: This is applicable only for inventory containers.
Mix SCAC	Select if activities belonging to different SCAC can be mixed. Note: This is applicable only for inventory containers.
Mix Ship Date	Select if activities belonging to different ship dates can be mixed.

9.8.5 Defining Putaway Strategy

Inventory being received at the dock require to be putaway to appropriate locations, based on shipment attributes, item classifications and location attributes.

The preferences for putting away of inventory is specified by zone and location storage attributes, for the SKU and container attributes.

For more information on defining a putaway strategy, see [Section 8.4, "Defining Putaway Preferences"](#) on page 659.

Note: Choose  in the top right corner of the Activity Search window to access the Putaway Strategy window.

9.8.6 Defining Retrieval Strategy

Retrieval Strategy defines the retrieval process to be followed when retrieving items for Packing. This is defined at the 'Packing' activity group level.

For more information on defining a retrieval strategy, see [Section 8.3, "Defining Retrieval Strategy"](#) on page 643.

Note: Choose  in the top right corner of the Activity Search window to access the Retrieval Strategy window.

9.9 Defining Pack Modification Rules



Most order document types flow through a pipeline without requiring any intervention by a customer service representative. However, there are times when modifications are required, such as changing credit card information or quantity. Selling and Fulfillment Foundation supports modifications through the Console and APIs. It is critical for you to decide which modifications are allowed for each modification type, modification level, and status combination.

Important: Contemplate business and system integration implications before allowing a modification that is disallowed as part of the system defaults.

For more information about modification rules, see the *Sterling Distributed Order Management: Configuration Guide*.

9.9.1 Setting Up Pack Modification Rules

To set up pack modification rules:

1. From the tree in the application rules side panel, choose Packing > Pack Process > Pack Modification Rules. The Modification Rules window displays.
2. In the Modification Rules window, select the Pack Process whose Modification Rule is to be set. Refer [Table 9–18](#) for field value descriptions.
3. Choose  to allow order modification.
4. Choose  to disallow order modification.
5. Choose  to ignore order modification.

For more information about defining and changing modification rules, see the *Sterling Distributed Order Management: Configuration Guide*.

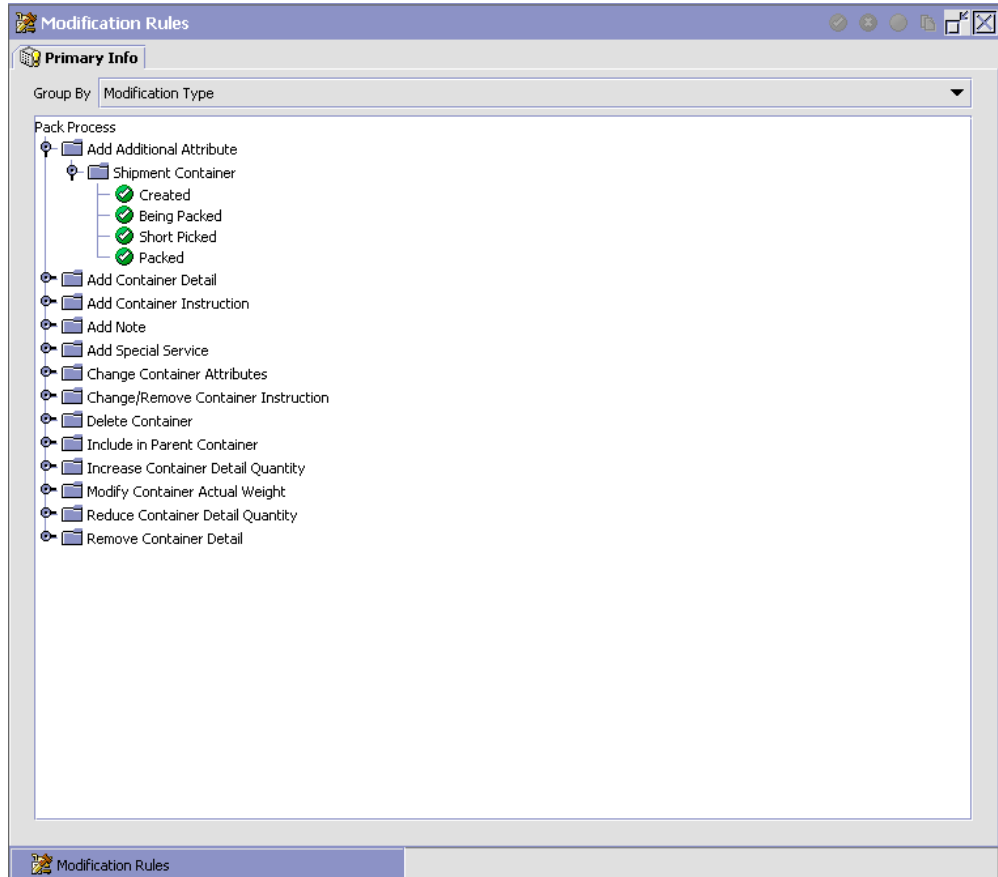

Table 9–18 *Modification Rules Window*

Field	Description
Primary Info	
Group by	View the Pack Modification Rules grouped by Modification Type, Modification Level, or by Status.
Modification Type	Pack Modification Rules grouped by Modification Type. Statuses display grouped by Modification Level for each Modification Type.

Table 9–18 Modification Rules Window

Field	Description
Add Additional Attribute	Allow or Disallow or Ignore modification type appropriately.
Add Container Detail	Allow or Disallow or Ignore modification type appropriately.
Add Container Instruction	Allow or Disallow or Ignore modification type appropriately.
Add Note	Allow or Disallow or Ignore modification type appropriately.
Add Special Service	Allow or Disallow or Ignore modification type appropriately.
Change Container Attribute	Allow or Disallow or Ignore modification type appropriately.
Change/Remove Container Instruction	Allow or Disallow or Ignore modification type appropriately.
Delete Container	Allow or Disallow or Ignore modification type appropriately.
Include in Parent Container	Allow or Disallow or Ignore modification type appropriately.
Increase Container Detail Quantity	Allow or Disallow or Ignore modification type appropriately.
Modify Container Actual Weight	Allow or Disallow or Ignore modification type appropriately.
Reduce Container Detail Quantity	Allow or Disallow or Ignore modification type appropriately.
Remove Container Detail	Allow or Disallow or Ignore modification type appropriately.
Modification Level	Pack Modification Rules grouped by Modification Level. Statuses display grouped by Modification Type for each Modification Level.
Shipment Container	Allow or Disallow or Ignore modification level appropriately.
Status	Pack Modification Rules grouped by Status. Modification Types display grouped by Modification Level for each Modification Type.

For more information about Modification Rules, see the *Sterling Distributed Order Management: Configuration Guide*.

9.10 Defining Pack Process Type Details

Pack Process Type Details define parameters and templates that distinguish a process type.

A **process type pipeline** is a series of transactions and statuses that guide document types, such as a Return Order, through a predefined process. A pipeline consists of the different statuses a document goes through during fulfillment, negotiation, shipment, or receipt. You can also set up transactions consisting of events, actions, and conditions, as they pertain to the pipeline you are configuring.

Repositories

A repository is a logical collection of entities that define the business process workflow.

The following entities are included in a repository:

- Pipelines
- Transactions
- Statuses
- Conditions
- Actions
- Services

Selling and Fulfillment Foundation provides a base repository for each of the system-defined process types. Some of the entities within a repository are copied when creating a new document type. For more information about creating a new document type, see the *Selling and Fulfillment Foundation: Application Platform Configuration Guide*.

For more information about defining process type details, see the *Selling and Fulfillment Foundation: Application Platform Configuration Guide*.

9.10.1 Viewing Pack Process Type Details

To view pack process type details:

1. From the tree in the application rules side panel, choose Packing > Pack Process > Pack Process Type Details. The Process Type Details : Container window displays.
2. Primary information of the Process Type displays in the applicable fields. Refer [Table 9–19](#) for field value descriptions.

For more information about defining the primary information for process type details, see the *Selling and Fulfillment Foundation: Application Platform Configuration Guide*.

The screenshot shows a software window titled "Process Type Details : Container". Inside the window, there is a tab labeled "Primary Info". Below the tab, there are three input fields:

- Process Type:** PACK
- Process Type Name:** Pack Process
- Description:** Pack Process

The rest of the window is a large, empty gray area. At the bottom of the window, there is a status bar with the text "Process Type Details : Container".

Table 9–19 Process Type Details : Container Window

Field	Description
Primary Info	
Process Type	This is automatically populated by the system as "PACK".
Process Type Name	This indicates the name of the process type.
Description	This provides a brief description for the process type.

9.11 Defining Pack Process Model

The pack process is modeled through a pipeline. This represents the process configuration that is unique to a warehouse. A warehouse may also specify unique processes for each participating enterprise.

For example, a warehouse that performs ticketing for outbound shipments after pick and pack into a carton is complete.

9.11.1 Pipeline Determination

Pipeline determination is used to set up conditions that affect which pipeline is used during the start of the business process workflow. For example, an organization deals with sales orders that sometimes contain hazardous materials. They have two separate pipelines, one in which orders with order lines without any hazardous materials go through and one in which orders with order lines containing hazardous materials must go through for inspection before continuing through the order process. The organization uses pipeline determination to set up a condition that determines whether or not order lines contain hazardous materials and sends the order line down the correct pipeline.

For more information about Pipeline Determination, see the *Selling and Fulfillment Foundation: Application Platform Configuration Guide*.

9.11.2 Hub Rule

When you expand the Pipeline Determination branch, the components display depends on what role you are logged in as. If you are logged in as a Hub role, the Hub Rule displays. If you are logged in as an Enterprise role, both the Hub Rule and all user created determination

rules (For example, My Rule) components display. Double-click on the applicable rule to display the pipeline determination rules.

Note: If you are logged in as an Enterprise role, the Hub Rule screen is grayed out and cannot be modified.

Drag conditions and pipelines into the work area to construct pipeline determination rules. A single pipeline or condition must be the root. Conditions cannot link back to an earlier component in the chain and a pipeline cannot be linked to twice.

Note: When configuring pipeline determination for an order document type pipeline, note that pipeline determination is only considered when adding a line or creating an order. When changes are made to draft orders pipeline determination does not occur.

9.11.2.1 Condition Variables for Pipeline Determination

When using conditions for pipeline determination, the following condition variables can be used:

Node Attributes

- Ship Node
- Receiving Node
- Ship from Ship Node Interface Type
- Ship from Supplier Code
- Ship from DCM Integration Real Time
- Ship from Country
- Ship to Ship Node Interface Type
- Ship to Supplier Code
- Ship to DCM Integration Real Time
- Ship to Country

Organization Attributes

- Enterprise Code
- Buyer Organization Code
- Seller Organization Code

Shipment Attributes

- Ship Mode
- Carrier Type
- Carrier
- Freight Terms
- Delivery Code
- Pack and Hold
- Shipment Container Count
- Is Shipment Containerized

Container Attributes

- Is Shipment Container
- Is Load Container
- Is Inventory Pallet
- Is Converted From LPN
- Is Serial Capture Pending
- Is Pack Process Complete
- Is Product Placing Complete
- Requires VAS
- Has Child Containers
- Number of Items
- Container Type

For more information about Pipeline Determination and Hub Rule, see the *Selling and Fulfillment Foundation: Application Platform Configuration Guide*.

9.11.3 Pipelines

To view the pack pipeline details:

1. From the tree in the application rules side panel, choose Packing > Pack Process > Pack Process Model. The Pack Process window displays.

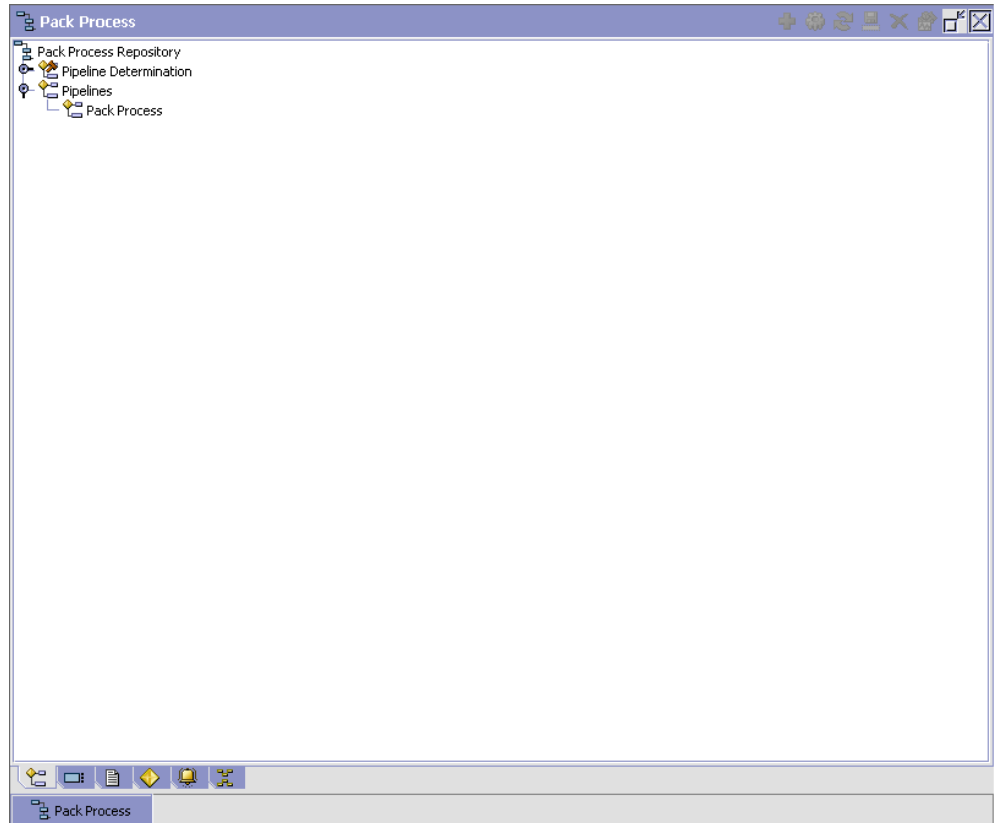

2. In the Pack Process window, choose Pack Process Repository > Pipelines > Pack Process.
3. The Pipeline Detail: Pack Process (Pack Process) window displays.

After packing a container, if you want to perform a VAS operation, extend the pack pipeline and add the new extended status with the Requires VAS container attribute connected to the listener. To perform the VAS

operation, the system automatically creates a work order. On completion of VAS, the container status changes to Packed.

For more information about creating and modifying a pipeline, see the *Selling and Fulfillment Foundation: Application Platform Configuration Guide*.

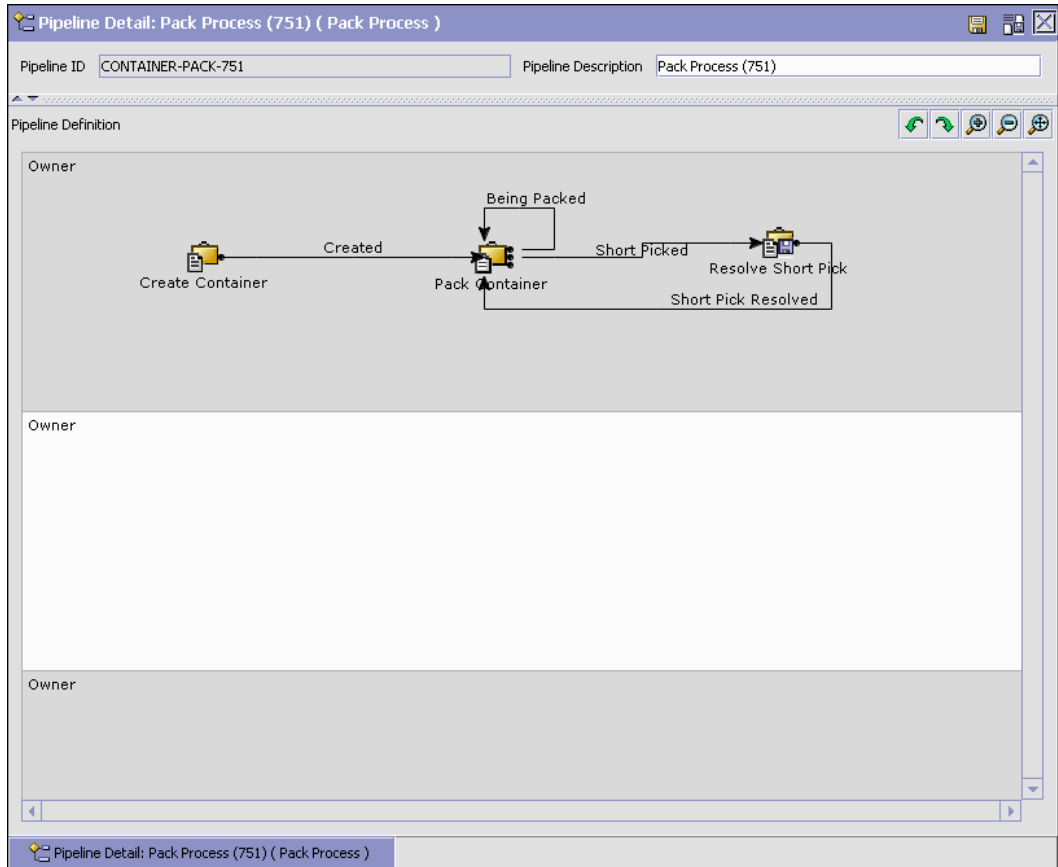

Post-Pick Value Added Services Configuration Settings

For Post-Pick Value Added Services to happen, the buyer-compliance for the same should be defined, with a service definition associated with it. Again, the 'Container pipeline' should have a 'listener' (that listens to the valid status of the work order) to create a work order for the container.

Typically, the pipeline should be as follows:

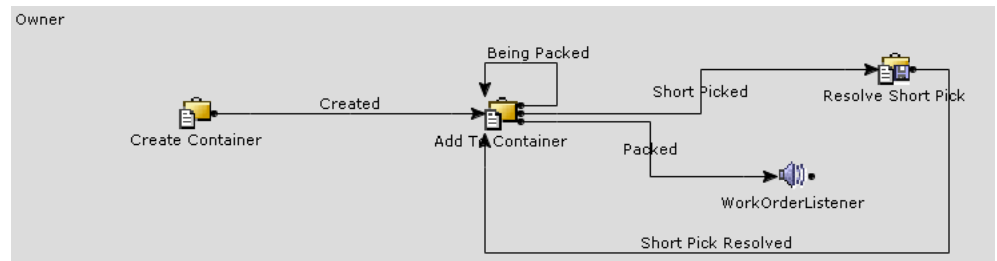

For more information about value added services, see the *Sterling Warehouse Management System: Concepts Guide*.

For more information about configuring value added services, see [Section 8, "Configuring Value Added Services"](#) on page 615.

For more information about Configuring Pipeline components, see the *Selling and Fulfillment Foundation: Application Platform Configuration Guide*.

Extending Container Pipelines for Items that Require VAS

Perform the following steps to extend the container pipelines for items that require VAS:

1. Create a new status extension of the Packed status, for example, Awaiting WO.
2. Configure a Requires VAS condition such that this condition picks containers from the Packed status, and depending on the evaluation of the Requires VAS condition, puts the containers in the Awaiting WO status.
3. The WorkOrderListener should pick the containers that are in this new status.

9.11.4 Transactions

Every process type has a set of base transactions defined for it. A transaction is a logical unit of work that is necessary for performing an activity within Selling and Fulfillment Foundation. Base transactions are predefined transactions that contain information about how the transaction behaves, such as how many copies of a transaction can be

kept in a process type and whether or not it can have configurable base pick and drop statuses. Base transactions can be used to create new transactions. These transactions can be changed within the limits defined in the base transaction.

For more information about Transactions, see *Selling and Fulfillment Foundation: Application Platform Configuration Guide*.

To view the transaction details for a pack pipeline:

1. From the tree in the application rules side panel, choose Packing > Pack Process > Pack Process Model. The Pack Process window displays.
2. In the Pack Process window, choose .
3. The Transactions tab window displays.

For more information about creating and modifying Transactions, see the *Selling and Fulfillment Foundation: Application Platform Configuration Guide*.

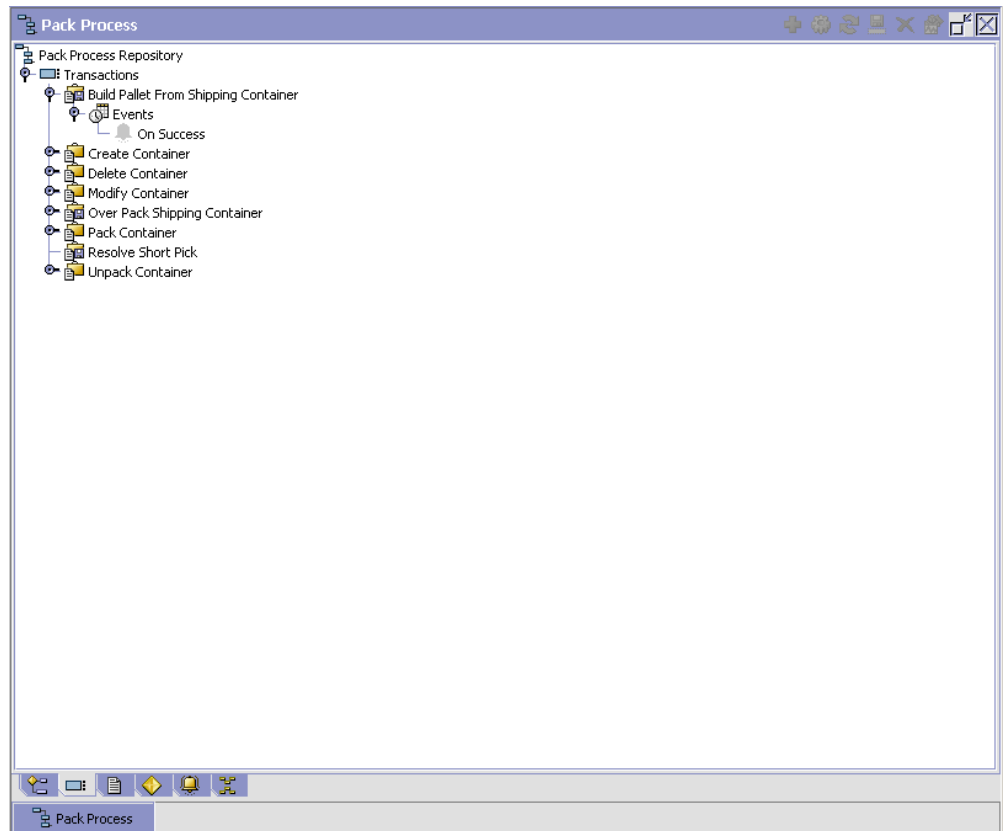

Table 9–20 Pack Process Pipeline - Transactions Tab Window

Field	Description
Build Pallet From Shipping Container	This transaction represents that a pallet can be built from the shipping containers.
Create Container	This transaction represents the creation of container that is used for packing of shipment. This applies to warehouses that do 'post-pick containerization'.
Delete Container	This transaction represents that container contents can be deleted.

Table 9–20 Pack Process Pipeline - Transactions Tab Window

Field	Description
Modify Container	This transaction represents that container level or attributes can be modified.
Overpack Shipping Container	This transaction represents that the shipping containers can be overpacked.
Pack Container	This transaction represents that container contents can be packed.
Resolve Short Pick	This transaction represents that the shipment for packing has been short picked, and can be resolved.
Unpack Container	This transaction represents that container contents can be unpacked.

9.11.5 Statuses

Statuses are the actual states that a document moves through in the pipeline. A transaction can contain two types of statuses, a drop status and a pickup status. A document is moved into a **drop status** when the events and conditions of a transaction have been completed. A **pickup status** takes the document from the previous drop status and moves it through the next transaction. Created and Scheduled are examples of statuses.

For more information about Statuses, see the *Selling and Fulfillment Foundation: Application Platform Configuration Guide*.

To view the status details of a pack pipeline:

1. From the tree in the application rules side panel, choose Packing > Pack Process > Pack Process Model. The Pack Process window displays.
2. In the Pack Process window, choose .
3. The Statuses tab window displays.

For more information about creating and modifying Statuses, see the *Selling and Fulfillment Foundation: Application Platform Configuration Guide*.

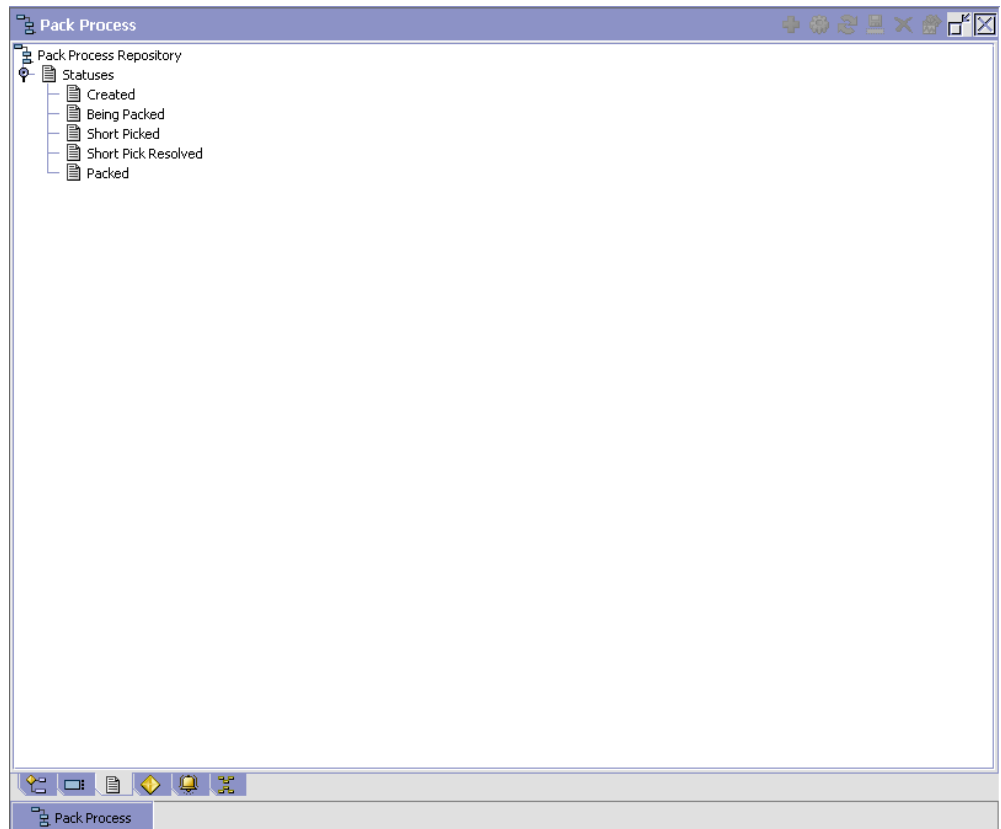

Table 9–21 Pack Process Pipeline - Statuses Tab Window

Field	Description
Created	This indicates that the shipment is opened for packing. This corresponds to 'Create Container' transaction.
Being Packed	This indicates that the packing of the shipment is in progress. This corresponds to 'Add to Container' transaction.
Short Picked	This indicates that the shipment for packing has been short picked. This corresponds to exceptions being reported on a container during the pick pipeline process transaction.

Table 9–21 Pack Process Pipeline - Statuses Tab Window

Field	Description
Short Pick Resolved	This indicates that the short pick exception has been resolved. This corresponds to 'Resolve Short Pick' transaction.
Packed	This indicates that packing for the shipment is complete. This corresponds to the 'Close Container' action from the pack station.

9.11.6 Conditions

A **condition** matches document type attributes against decision points and routes the documents to different paths based on the specified attribute and value combinations. The document type attributes against which conditions can be created are predefined in Selling and Fulfillment Foundation. You can use these attributes in any combination or you can create conditions that run the appropriate application logic for specific circumstances.

For more information about Conditions, see the *Selling and Fulfillment Foundation: Application Platform Configuration Guide*.

To view the condition details of a pack pipeline:

1. From the tree in the application rules side panel, choose Packing > Pack Process > Pack Process Model. The Pack Process window displays.
2. In the Pack Process window, choose .
3. The Conditions tab window displays.

For more information about creating and modifying Conditions, see the *Selling and Fulfillment Foundation: Application Platform Configuration Guide*.

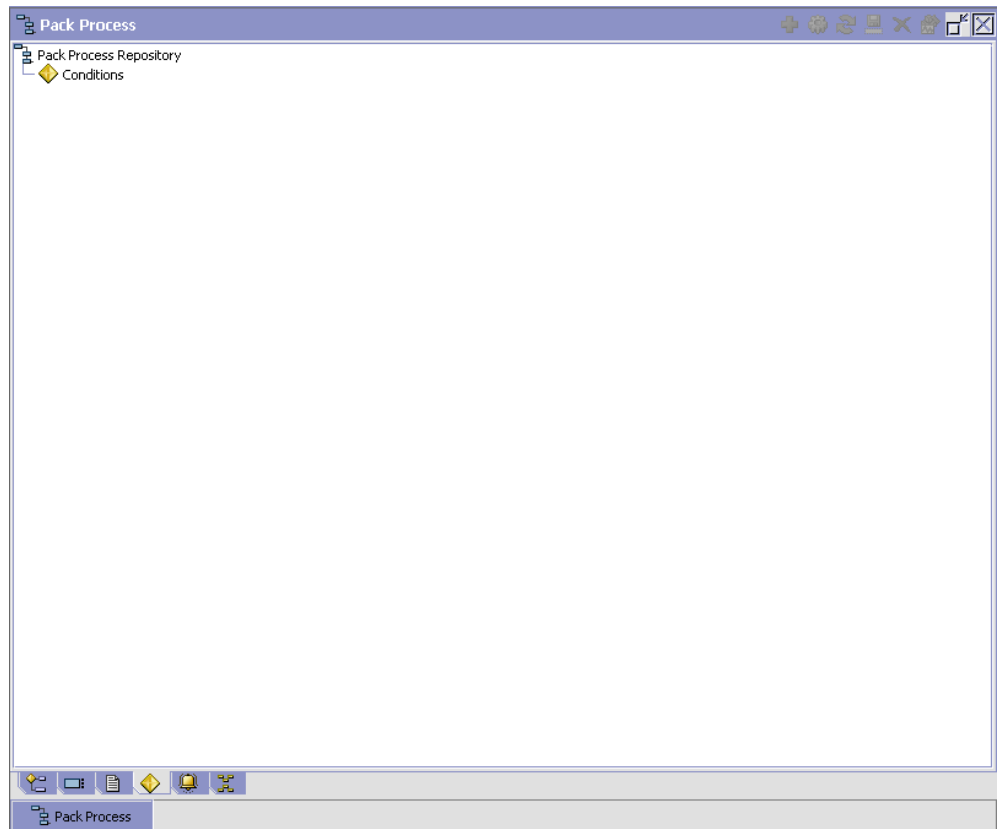

Table 9–22 Pack Process Pipeline - Conditions Tab Window

Field	Description
Conditions	Displays conditions that are specific to the pack process pipeline, if any.

The Sterling WMS default pipeline does not have any conditions specified.

9.11.7 Actions

An **action** is a process or program that is triggered by an event. These processes and programs send user alert notifications and automatically resolve issues.

For example, when an order is released (the event), you can set an action to send the customer an e-mail.

For more information about Actions, see the *Selling and Fulfillment Foundation: Application Platform Configuration Guide*.

To view the action details of a pack pipeline:

1. From the tree in the application rules side panel, choose Packing > Pack Process > Pack Process Model. The Pack Process window displays.
2. In the Pack Process window, choose .
3. The Actions tab window displays.

For more information about creating and modifying Actions, see the *Selling and Fulfillment Foundation: Application Platform Configuration Guide*.

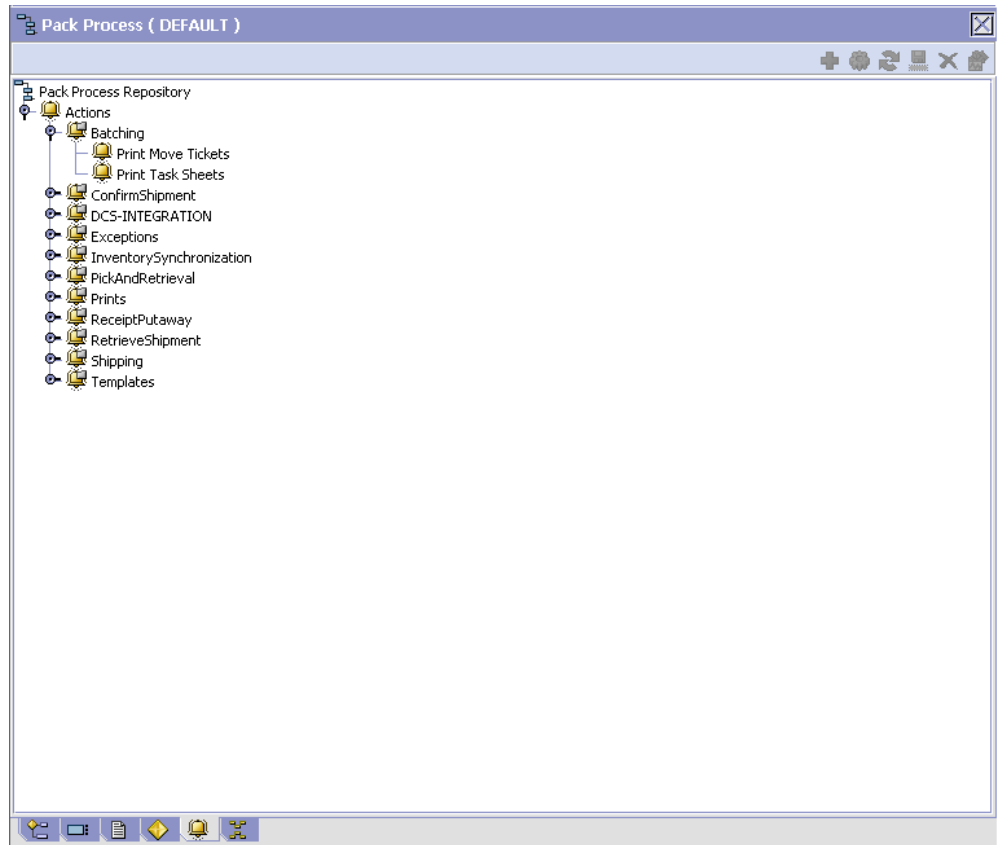

Table 9–23 Pack Process Pipeline - Actions Tab Window

Field	Description
Batching	Default settings are provided for: Print Move Tickets – Invokes the batch printing service for printing the move tickets. Print Task Sheets – Invokes the batch print service for printing the task sheets.
ConfirmShipment	Default settings are provided for: ConfirmShipment – Invokes the confirmShipment flow to confirm the shipment.

Table 9–23 Pack Process Pipeline - Actions Tab Window

Field	Description
DCS-Integration	Default settings are provided for: InventoryDownload – Invokes the YantraWMSInventoryDownloadService service to download the inventory information from Selling and Fulfillment Foundation to DCS. PODownload – Invokes the YantraWMSPODownloadService service to download the Purchase Order information from Selling and Fulfillment Foundation to DCS.
Exceptions	Default settings are provided for: ShortagesDetected – Invokes the LogWavePlaFailure exception service when shortage of inventory occurs during wave release.
InventorySynchronization	Default settings are provided for: CollectInventoryMismatch – This service collects the inventory mismatch information between an external system and Selling and Fulfillment Foundation. This is typically caused when some inventory updates at a node or a warehouse are not reported to Selling and Fulfillment Foundation.
PickAndRetrieval	Default settings are provided for: ConfirmEmptyLocationAfterPick – Invokes the GenerateCountRequest flow which creates a count request.

Table 9–23 Pack Process Pipeline - Actions Tab Window

Field	Description
Prints	<p>Default settings are provided for:</p> <p>PickList Print – Invokes the print service for printing the Pick List.</p> <p>LTL Manifest – Invokes the print service for printing the Less-than Truck Load Manifest.</p> <p>Print Load BOL – Invokes the print service for printing the Load Bill of Lading.</p> <p>Print PackList – Invokes the print service for printing the Pack List.</p> <p>Print Post Pick Container Labels – Invokes the print service for printing UCC-128 container labels for containers, when system defined packing process is used.</p> <p>Print Shipment BOL – Invokes the print service for printing the Shipment Bill of Lading.</p> <p>Print Shipping Label – Invokes the print service for printing the UCC-128 container labels.</p> <p>Print Wave – Invokes the Print service for printing a Wave.</p>
ReceiptPutaway	<p>Putaway products on receipt closure – Indicates the default action provided to automatically initiate putaway of purchase order receipts.</p>
RetrieveShipment	<p>Retrieve Requested Serial – This service invokes the retrieveShipment API to retrieve the requested serials to the specified location.</p>

Table 9–23 Pack Process Pipeline - Actions Tab Window

Field	Description
Shipping	Default settings are provided for: Load Left Origin – Invokes the doLoadLeftOriginUpdates service to mark that the load has left the origin. Stop Shipping – Invokes the RaiseStopShippingAlert service to raise an alert to stop the processing of the shipment.
Templates	Default settings are provided for: Log Exception – Logs the reasons due to which a count request could not be created for a Count Program. Publish Data – Sends data to external queue or internal tables. Raise Exception – Raises an alert using the Event Management from the published information. Send Email – Raises an email action to create an email in the template format from the published information. Send Email-HTML format – Raises an email action to create an email in HTML format from the published information.

9.11.8 Service Definitions

Service definitions are a representation of the logic that regulates document workflow services. The Service Builder is a graphical interface that enables you to create a graphical representation of these *services*.

For more information about Service Definitions, see the *Selling and Fulfillment Foundation: Application Platform Configuration Guide*.

To view the service definition details of a pack pipeline:

1. From the tree in the application rules side panel, choose Packing > Pack Process > Pack Process Model. The Pack Process window displays.
2. In the Pack Process window, choose .
3. The Service Definitions tab window displays.

For more information about creating and modifying Service Definitions, see the *Selling and Fulfillment Foundation: Application Platform Configuration Guide*.

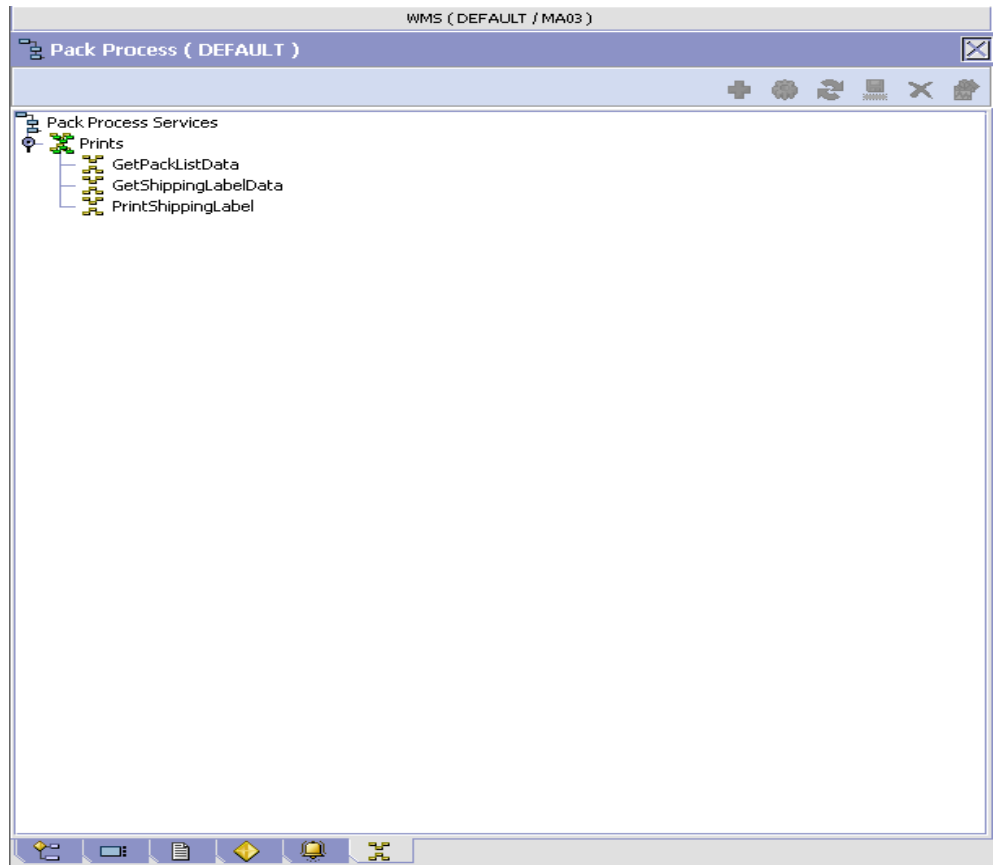

Table 9–24 Pack Process Pipeline - Service Definition Tab Window

Field	Description
GetPackListData	The print service for getting the data required to print a Pack List.

Table 9–24 Pack Process Pipeline - Service Definition Tab Window

Field	Description
GetShippingLabelData	The print service for getting the data required to print a Shipping Label.
PrintShippingLabel	The Print service for printing a Shipping Label.

10

Configuring Shipping

Shipping defines the process to be followed after the completion of the Packing and VAS processes. For example, shipping activities include trailer loading and manifesting.

The activities relating to the ship and load process are specified here.

Use Shipping for:

- [Defining Customers](#)
- [Defining Activities](#)
- [Defining Parcel Carrier Preferences](#)
- [Defining LTL Carrier Preferences](#)
- [Defining Shipping Modification Rules](#)
- [Defining Shipping Hold Types](#)
- [Defining Shipping Process Type Details](#)
- [Defining Shipping Process Model](#)
- [Defining Load Modification Rules](#)
- [Defining Load Hold Types](#)
- [Defining Load Process Type Details](#)
- [Defining Load Process Model](#)

10.1 Defining Customers

You can define the customers that buy from an organization.

Use Customer for:

- [Defining Customer Classifications](#)
- [Defining Customer Definitions](#)

10.1.1 Defining Customer Classifications

You can configure the customer classification codes to associate with a customer identification master. For more information about creating a customer identification master, see [Section 10.1.2, "Defining Customer Definitions"](#) on page 833.

Use Customer Classification for:

- [Creating a Customer Classification](#)
- [Modifying a Customer Classification](#)
- [Deleting a Customer Classification](#)

10.1.1.1 Creating a Customer Classification

To create a customer classification:

1. From the tree in the application rules side panel, choose Shipping > Customer > Customer Classification. The Customer Classification Codes window displays in the work area.

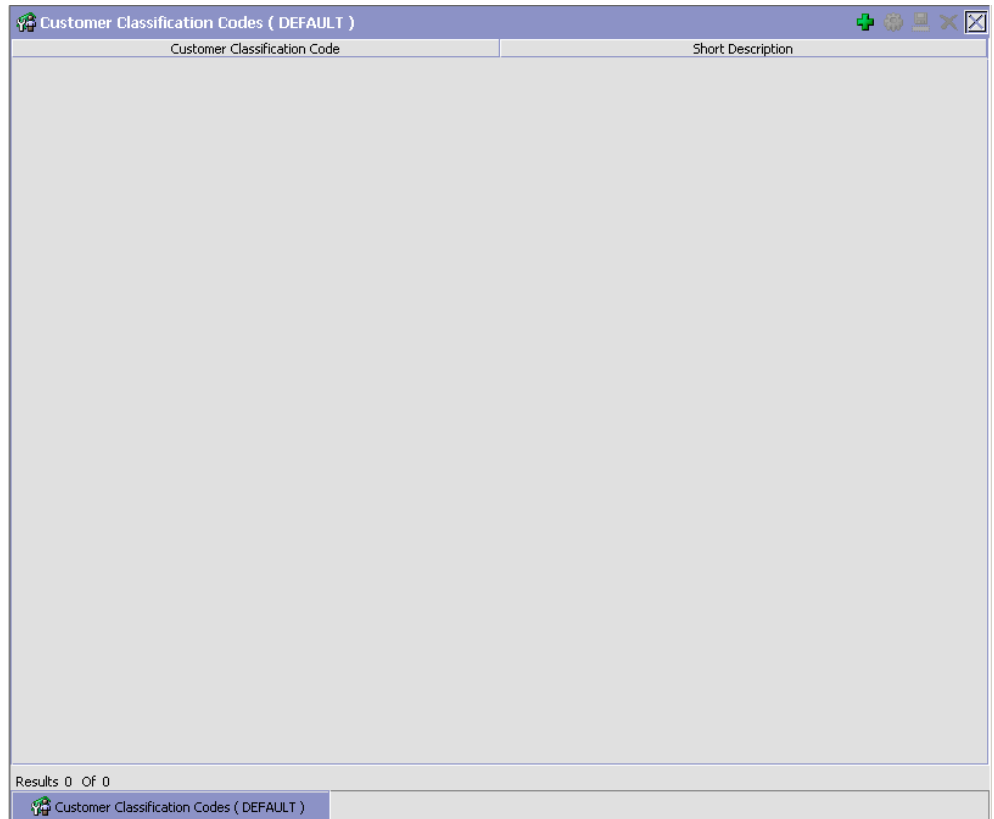

2. Choose . The Customer Classification Code Details pop-up window displays.

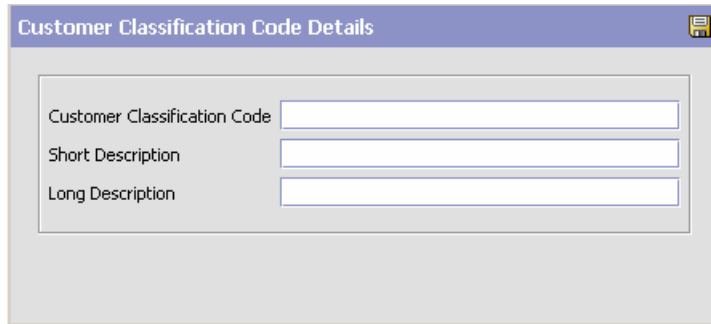



The screenshot shows a dialog box titled "Customer Classification Code Details". It contains three text input fields: "Customer Classification Code", "Short Description", and "Long Description". A save icon is visible in the top right corner of the dialog.

3. In Customer Classification Code, enter the classification ID code.
4. In Short Description, enter a brief description of the classification ID code.
5. In Long Description, enter a more detailed description of the classification ID code.
6. Choose .

10.1.1.2 Modifying a Customer Classification

To modify a customer classification:

1. From the tree in the application rules side panel, choose Shipping > Customer > Customer Classification. The Customer Classification Codes window displays in the work area.
2. Select the applicable customer classification code and choose . The Customer Classification Code Details pop-up window displays.
3. In Short Description, enter a brief description of the classification ID code.
4. In Long Description, enter a more detailed description of the classification ID code.
5. Choose .

10.1.1.3 Deleting a Customer Classification

To delete a customer classification:

1. From the tree in the application rules side panel, choose Shipping > Customer > Customer Classification. The Customer Classification Codes window displays in the work area.
2. Select the applicable customer classification code and choose .

10.1.2 Defining Customer Definitions

You can configure the customer definitions that establish a relationship between an organization and its Buyers. When creating a customer definition, you associate an existing Buyer organization with a specific customer ID and classification. The customer identification uniquely identifies the Buyer organization in instances where multiple ERP systems download Buyer information into Selling and Fulfillment Foundation.

Use Customer Definition for:

- [Creating a Customer Definition](#)
- [Modifying a Customer Definition](#)
- [Deleting a Customer Definition](#)

10.1.2.1 Creating a Customer Definition

To create a customer definition:

1. From the tree in the application rules side panel, choose Shipping > Customer > Customer Definition. The Customer Search window displays in the work area.

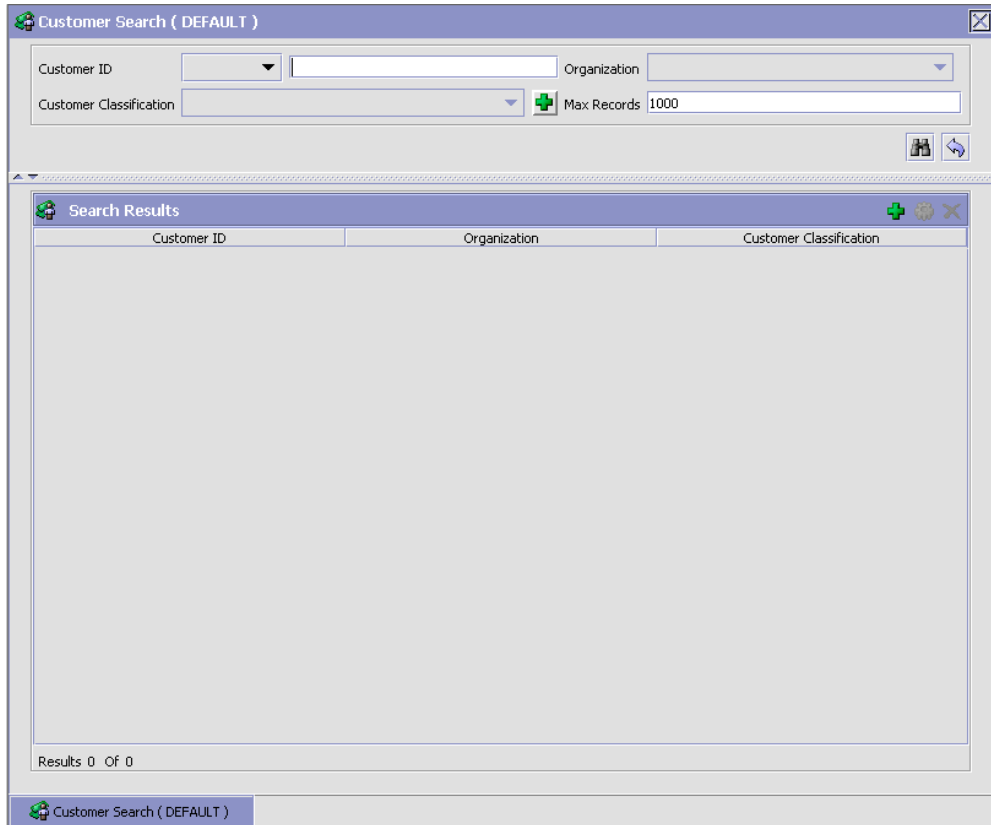



2. Choose . The Customer pop-up window displays.
3. Enter information into the applicable fields. Refer to [Table 10-1](#) for field value descriptions.
4. Choose .

Table 10–1 Customer Pop-Up Window

Field	Description
This Customer Is a Business	Select this if the customer with whom you trade participates as a company (as in a B2B scenario). If you choose this option, see Business Customer Details in this table for further information specific to this scenario.
This Customer Is a Consumer	Select this if the customer with whom you trade participates as an individual (as in a B2C scenario). If you choose this option, see Business Customer Details in this table for further information specific to this scenario.
Customer ID	Enter the unique ID.



Table 10–1 Customer Pop-Up Window

Field	Description
Customer Classification	Select the classification, if applicable.
Business Customer Details	
Select Existing Organization	Choose this and select the applicable Buyer if you want to associate the customer ID with an existing Buyer organization.
Create A New Organization	Choose this if you want to create a new organization to associate with the customer.
Organization Code	If you chose Create Buyer Organization, enter the Buyer's organization code.
Organization Name	When creating a new organization, enter the Buyer's organization name.
This Organization Is Also a Ship To	When creating a new organization, choose this if the organization also functions as a receiving node.
DUNS Number	If you chose Create Buyer Organization, enter the Buyer's DUNS number.
Account Number With Hub	If you chose Create Buyer Organization, enter the Buyer's account number with the Hub organization.
Locale	If you chose Create Buyer Organization, select the Buyer's locale.
Consumer Address Details	
Address	Enter the consumer's name and shipping address here.
Contact Info	Enter the consumer's telephone, cell phone, fax number, and e-mail address.

10.1.2.2 Modifying a Customer Definition



To modify a customer definition:

1. From the tree in the application rules side panel, choose Shipping > Customer > Customer Definition. The Customer Search window displays in the work area.
2. Enter applicable search criteria and choose . A list of customers displays.

3. Locate the applicable customer and choose . The Customer pop-up window displays.
4. From Customer Classification, select the Buyer's customer classification, if applicable.
5. From Buyer Organization, select the Buyer organization to associate with the customer ID.
6. Choose .

10.1.2.3 Deleting a Customer Definition

To delete a customer definition:

1. From the tree in the application rules side panel, choose Shipping > Customer > Customer Definition. The Customer Search window displays in the work area.
2. Enter applicable search criteria and choose . A list of customers displays.
3. Locate the applicable customer and choose .

10.2 Defining Activities

Activities in the warehouse are grouped into Activity Groups. The Sterling WMS provides a pre-defined set of activity groups for a warehouse. Examples of activity groups include Receiving, VAS, Picking, Packing, and Shipping.

Each activity group is associated with activity codes that define each activity that is performed. For example, shipping activity group has Trailer Loading, and Manifesting activities.

The list here is specific to the Shipping process.

Note: Activity Codes and Activity Constraints may be defined only when the WMS tree is loaded for Node / Hub combination.

Use Activities for:

- [Creating an Activity Code](#)

- [Modifying an Activity Code](#)
- [Deleting an Activity Code](#)
- [Setting Up Activity Constraints for Container](#)

10.2.1 Creating an Activity Code

To create an activity code:

1. From the tree in the application rules side panel, choose Shipping > Activities. The Activity Search window displays.
2. Enter information in the applicable fields. Refer [Table 10–2](#) for field value descriptions.
3. Choose .

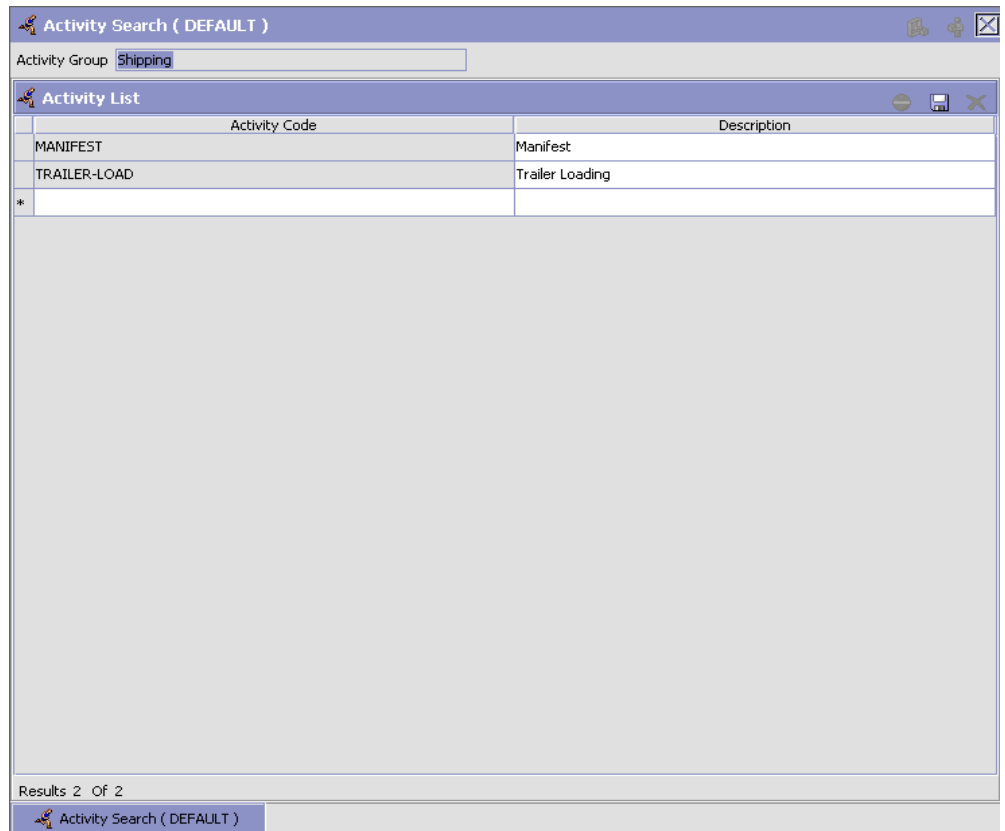



Table 10–2 Activity Search Window

Field	Description
Activity Group	This is automatically populated by the system as 'SHIP'.
Activity List	
Activity Code	Enter a name for the activity code. Activity code is the unique identity of the activity.
Description	Enter a brief description for the activity code.

10.2.2 Modifying an Activity Code

Once an activity code has been created, it can be modified.

To modify an activity code:

1. From the tree in the application rules side panel, choose Shipping > Activities. The Activity Search window displays, with the list of activities.
2. Enter information in the applicable fields. Refer [Table 10–2](#) for field value descriptions.
3. Choose .

It is recommended that the Sterling WMS-provided list of activity codes is not modified.

10.2.3 Deleting an Activity Code

To delete an activity code:

1. From the tree in the application rules side panel, choose Shipping > Activities. The Activity Search window displays, with the list of activities.
2. Choose the Activity Code to be deleted.
3. Choose .

It is recommended that the Sterling WMS-provided list of activity codes is not deleted.

10.3 Activity Constraints

Activities in the warehouse are performed based on attributes of the inventory being received. The attributes considered for Packing are containers.

Use Activity Constraint set-up for:

- [Setting Up Activity Constraints for Container](#)

10.3.1 Setting Up Activity Constraints for Container

The constraints for the activity of a Container are specified here. This also applies to CASE with LPN and PALLET with LPN.

Use the Activity Constraints for Container set-up for:

- [Creating an Activity Constraint for Container](#)
- [Modifying an Activity Constraint for Container](#)
- [Deleting an Activity Constraint for Container](#)

10.3.1.1 Creating an Activity Constraint for Container

To create an activity constraint for Container:

1. From the tree in the application rules side panel, choose Shipping > Activities. The Activity Search window displays, with the list of activities.
2. Choose the Activity List whose Activity Constraint is to be set up.
3. Choose . The Activity Constraints window displays.
4. In the Activity Constraints window, choose the Container tab. The Container tab window for Activity Constraints displays.

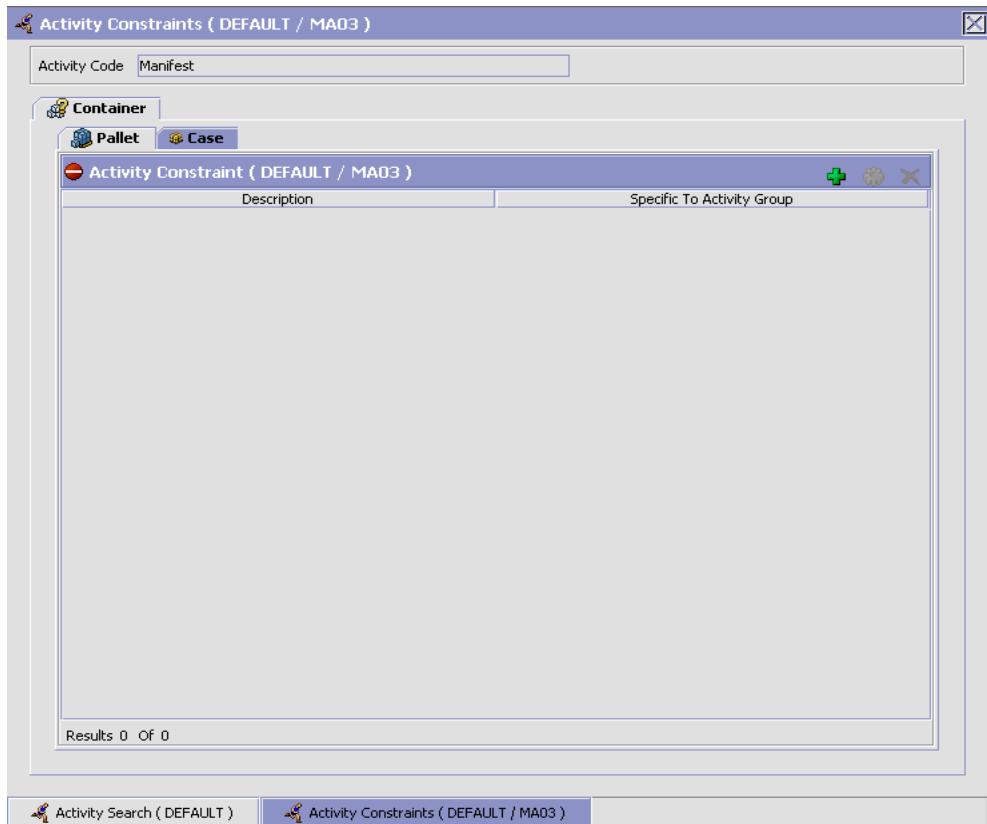



Activity Constraints for Container cases or pallets are specified separately:

- [Setting Up Activity Constraints for Container Pallets](#)
- [The Applicable Putaway Strategies window is displayed.](#)

10.3.1.1.1 Setting Up Activity Constraints for Container Pallets

To set up activity constraints for container pallets:

1. In the Container tab of Activity Constraints window, choose the Pallet tab. The Pallet tab window displays.
2. In the Pallet tab window, choose .

3. The Activity Constraint Details window displays.
4. Enter information in the applicable fields. Refer [Table 10–3](#) for field value descriptions.
5. Choose .

Activity Constraint Details (DEFAULT / MA03) : Container with unknown contents : Pallet

Description To View Strategy Click here 

Activity Code Requesting Activity Group

Location Priorities	
Priority	Location
2	Bulk Loc
3	Pack_Loc 
*	

Results 2 Of 2

Activity Search (DEFAULT) Activity Constraints (DEFAULT / MA0... Activity Constraint Details (DEFAULT...

Table 10–3 Activity Constraint Details - Containers Pallet Tab

Field	Description
Description	Enter a description for the activity constraint.
To View Strategy Click here	Choose  to view or set up Putaway Strategy. For more details on setting up a putaway strategy see Setting Up Putaway Strategy for Container with Unknown contents - Pallets . Note: Putaway strategy may be specified for the putaway preferences after the preference is saved.
Activity Code	This indicates the activity code for the constraint.
Requesting Activity Group	Choose the requesting activity group. Typical value is Outbound Picking.
Location Priorities	
Priority	Enter a number to represent the priority. The priority is used to sequence the order in which the location priorities are evaluated. For example, all storage code level priorities are to be evaluated first before generic priorities. The priority needs to be a positive integer, greater than zero. This is a mandatory field.
Location	Choose the relevant location for the activity. This is a mandatory field.



Setting Up Putaway Strategy for Container with Unknown contents - Pallets

You can set up putaway strategies to putaway applicable inventory from a source zone to a target zone, based on the strategy specified.

To set up putaway strategy for container with unknown content pallets:

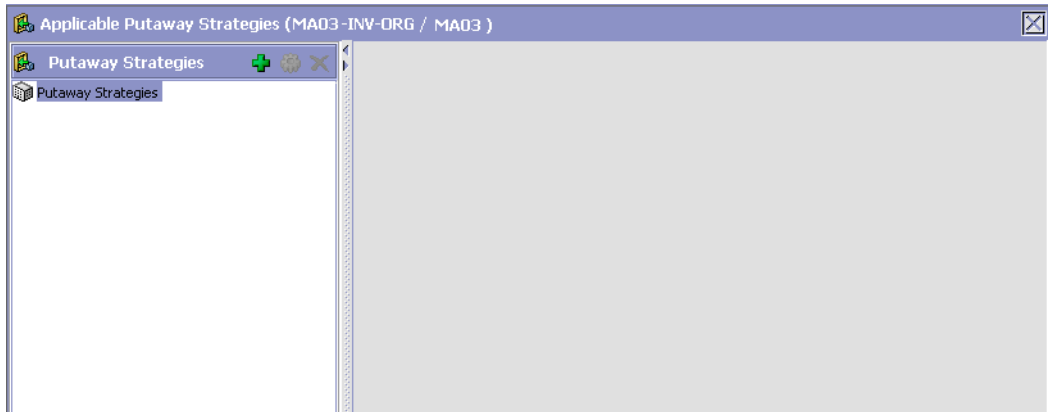
1. In the Activity Constraint Details : Container with unknown contents : Pallet window, choose .
2. The Applicable Putaway Strategies window is displayed.



3. Choose  in the Putaway Strategies panel. The Putaway Strategy Details window appears in the right panel.
4. Enter information in the applicable fields. See the Putaway Strategy Details Window table for field value descriptions.
5. Choose .

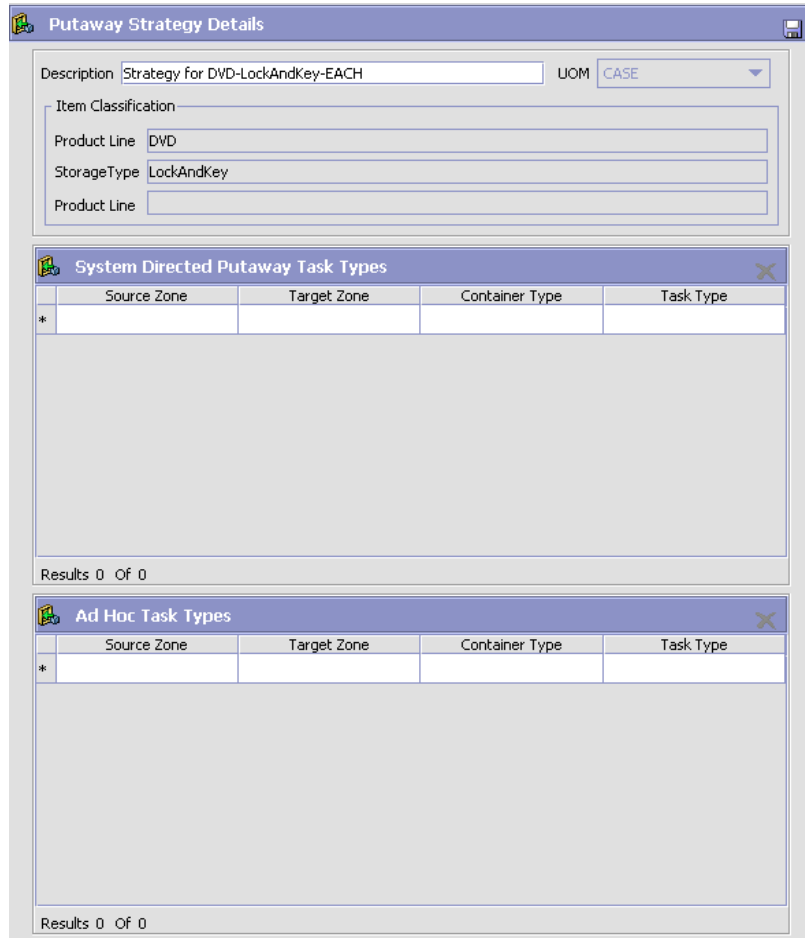

Table 10–4 Putaway Strategy Details Window

Field	Description
Description	Enter a description for the Putaway Strategy.
UOM	Select the UOM for the Putaway Strategy, if applicable. Note: The UOM will be defaulted in instances where it has been specified in the Putaway Preference Details screen.

Table 10–4 Putaway Strategy Details Window



Field	Description
Item Classification	List of putaway item classifications for the Enterprise are displayed. An example, Product Line is shown below.
Product Line	Choose relevant product line item classification for the putaway activity. Choose  . In the Classification Values window, select the applicable product line classification.
System Directed Putaway Task Types	Displays the list of existing system directed putaway task types. You may use  to delete an existing system directed putaway task type.
Source Zone	Select the source zone from where the inventory is sourced.
Target Zone	Select the target zone to where the inventory is moved.
Container Type	Select the container type to be used to move the inventory from the source zone to the target zone. Typical values are Case and Pallet.
Task Type	Select the Putaway Task Type applicable to this putaway strategy. This field displays the list of existing system directed task types that belong to the 'PUTAWAY' activity group.
Ad hoc Task Types	Displays the list of existing ad hoc task types. You may use  to delete an existing ad hoc task type.
Source Zone	Select the source zone from where the inventory is sourced.
Target Zone	Select the target zone to where the inventory is moved.

Table 10–4 Putaway Strategy Details Window



Field	Description
Container Type	Select the container type to be used to move the inventory from the source zone to the target zone. Typical values are Case and Pallet.
Task Type	Select the Putaway Task Type applicable to this putaway strategy. This field displays the list of existing ad hoc task types that belong to the 'PUTAWAY' activity group.

10.3.1.1.2 Setting Up Activity Constraints for Container Cases

To set up activity constraints for container cases:

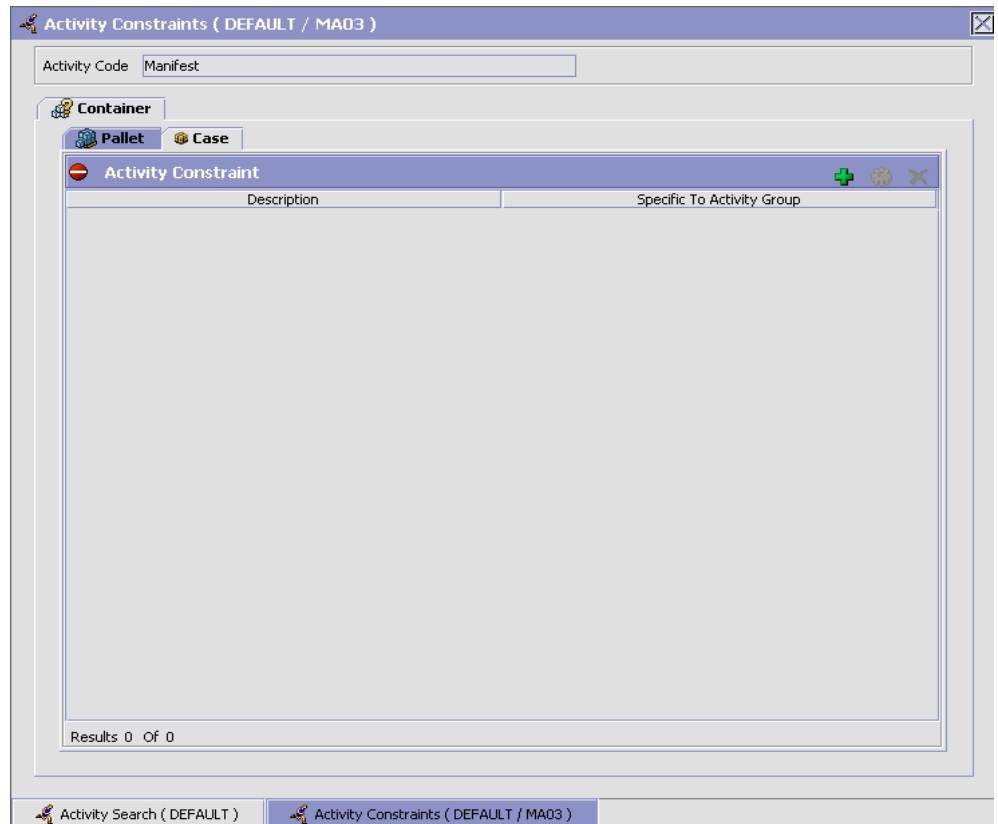
1. In the Container tab of Activity Constraints window, choose the Case tab. The Case tab window displays.



2. In the Case tab window, choose .
3. The Activity Constraint Details window displays.
4. Enter information in the applicable fields. Refer [Table 10–5](#) for field value descriptions.
5. Choose .

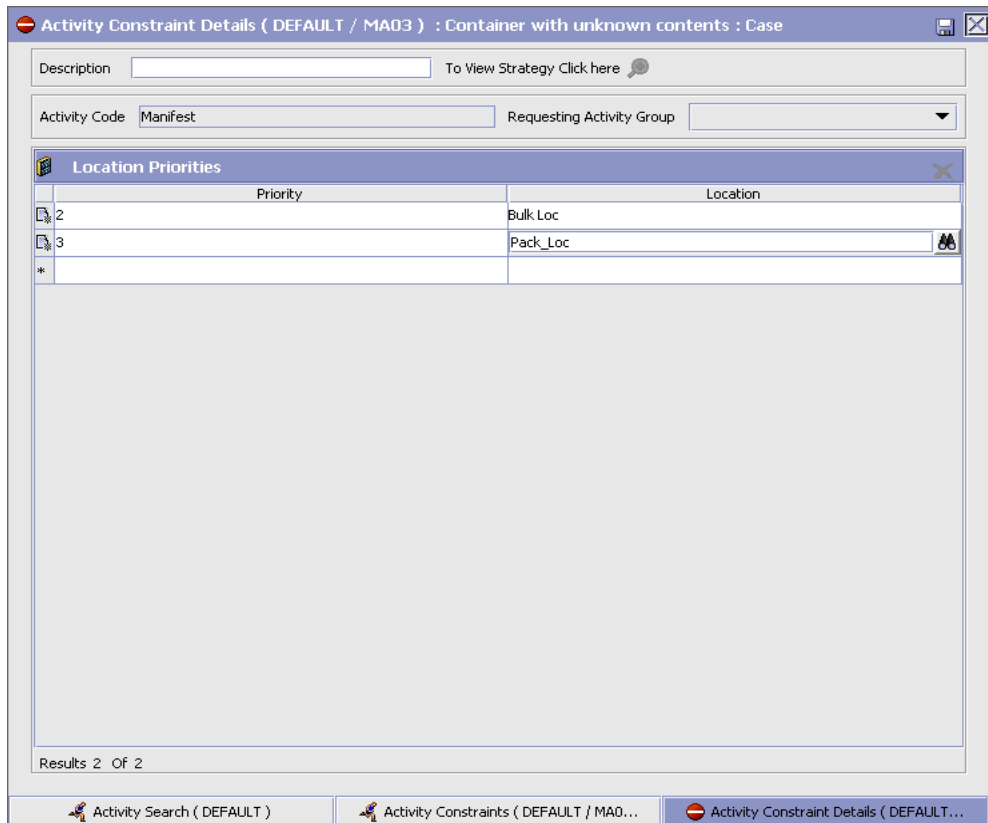

Table 10–5 Activity Constraint Details - Containers Case Tab

Field	Description
Description	Enter a description for the activity constraint.
To View Strategy Click here	Choose  to view or set up Putaway Strategy. For more details on setting up a putaway strategy see Setting Up Putaway Strategy for Container with unknown contents - Cases . Note: Putaway strategy may be specified for the putaway preferences after the preference is saved.
Activity Code	This indicates the activity code for the constraint.

Table 10–5 Activity Constraint Details - Containers Case Tab

Field	Description
Requesting Activity Group	Choose the requesting activity group. Typical value is Outbound Picking.
Location Priorities	
Priority	Enter a number to represent the priority. The priority is used to sequence the order in which the location priorities are evaluated. For example, all storage code level priorities are to be evaluated first before generic priorities. The priority needs to be a positive integer, greater than zero. This is a mandatory field.
Location	Choose the relevant location for the activity. This is a mandatory field.



Setting Up Putaway Strategy for Container with unknown contents - Cases

You can set up putaway strategies to putaway applicable inventory from a source zone to a target zone, based on the strategy specified.

To set up putaway strategy for Container with unknown contents cases:

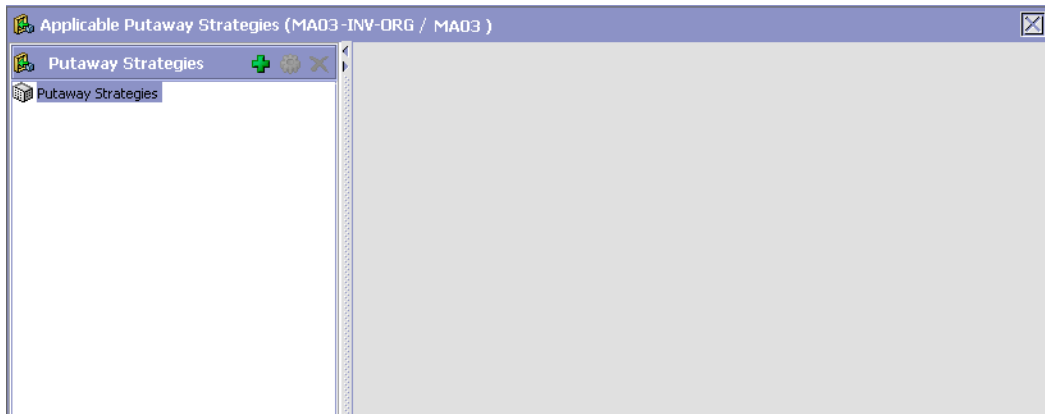
1. In the Activity Constraint Details : Container with unknown content : Case window, choose .
2. The Applicable Putaway Strategies window is displayed.



3. Choose  in the Putaway Strategies panel. The Putaway Strategy Details window appears in the right panel.
4. Enter information in the applicable fields. See the Putaway Strategy Details Window table for field value descriptions.
5. Choose .

The screenshot shows a software window titled "Putaway Strategy Details". It contains the following elements:

- Description:** A text field containing "Strategy for DVD-LockAndKey-EACH".
- UOM:** A dropdown menu set to "CASE".
- Item Classification:** A section containing three text fields:
 - Product Line: "DVD"
 - StorageType: "LockAndKey"
 - Product Line: (empty)
- System Directed Putaway Task Types:** A table with columns "Source Zone", "Target Zone", "Container Type", and "Task Type". It shows one row with an asterisk (*) in the first column and is otherwise empty. Below the table, it says "Results 0 Of 0".
- Ad Hoc Task Types:** A table with the same columns as the one above. It also shows one row with an asterisk (*) in the first column and is otherwise empty. Below the table, it says "Results 0 Of 0".

Table 10–6 Putaway Strategy Details Window

Field	Description
Description	Enter a description for the Putaway Strategy.
UOM	Select the UOM for the Putaway Strategy, if applicable. Note: The UOM will be defaulted in instances where it has been specified in the Putaway Preference Details screen.

Table 10–6 Putaway Strategy Details Window







Field	Description
Item Classification	List of putaway item classifications for the Enterprise are displayed. An example, Product Line is shown below.
Product Line	Choose relevant product line item classification for the putaway activity. Choose  . In the Classification Values window, select the applicable product line classification.
System Directed Putaway Task Types	Displays the list of existing system directed putaway task types. You may use  to delete an existing system directed putaway task type.
Source Zone	Select the source zone from where the inventory is sourced.
Target Zone	Select the target zone to where the inventory is moved.
Container Type	Select the container type to be used to move the inventory from the source zone to the target zone. Typical values are Case and Pallet.
Task Type	Select the Putaway Task Type applicable to this putaway strategy. This field displays the list of existing system directed task types that belong to the 'PUTAWAY' activity group.
Ad hoc Task Types	Displays the list of existing ad hoc task types. You may use  to delete an existing ad hoc task type.
Source Zone	Select the source zone from where the inventory is sourced.
Target Zone	Select the target zone to where the inventory is moved.

Table 10–6 Putaway Strategy Details Window

Field	Description
Container Type	Select the container type to be used to move the inventory from the source zone to the target zone. Typical values are Case and Pallet.
Task Type	Select the Putaway Task Type applicable to this putaway strategy. This field displays the list of existing ad hoc task types that belong to the 'PUTAWAY' activity group.

10.3.1.2 Modifying an Activity Constraint for Container



To modify an activity constraint for container:

1. From the tree in the application rules side panel, choose Shipping > Activities. The Activity Search window displays, with the list of activities.
2. Choose the Activity List whose Activity Constraint is to be set up.
3. Choose . The Activity Constraints window displays.
4. In the Activity Constraints window, choose the Container tab. The Container tab window for Activity Constraints displays.
5. In the Container tab window, choose the activity constraint to be modified.
6. Choose . The Activity Constraint Details window displays.
7. Enter information in the applicable fields. For more information about modifying the fields, see [Section 10.3.1.1.1, "Setting Up Activity Constraints for Container Pallets"](#) on page 842 and [Section 2, "The Applicable Putaway Strategies window is displayed."](#) on page 844.
8. Choose .

10.3.1.3 Deleting an Activity Constraint for Container

To delete an activity constraint for container:

1. From the tree in the application rules side panel, choose Shipping > Activities. The Activity Search window displays, with the list of activities.
2. Choose the Activity List whose Activity Constraint is to be set up.

3. Choose . The Activity Constraints window displays.
4. In the Activity Constraints window, choose the Container tab. The Container tab window for Activity Constraints displays.
5. In the Container tab window, choose the activity constraint to be deleted.
6. Choose .

10.4 Defining Parcel Carrier Preferences

Parcel Carrier Preferences are used to set up carrier specific preferences that is used in the shipping process. Parcel Carrier Preferences define the carrier name, organization code, and shipper account information, along with third party billing information.

Use Parcel Carrier Preferences for:



- [Creating a Parcel Carrier Preference](#)
- [Creating a New Parcel Carrier Preference from an Existing Parcel Carrier Preference](#)
- [Modifying a Parcel Carrier Preference](#)
- [Deleting a Parcel Carrier Preference](#)

10.4.1 Creating a Parcel Carrier Preference

To create a parcel carrier preference:

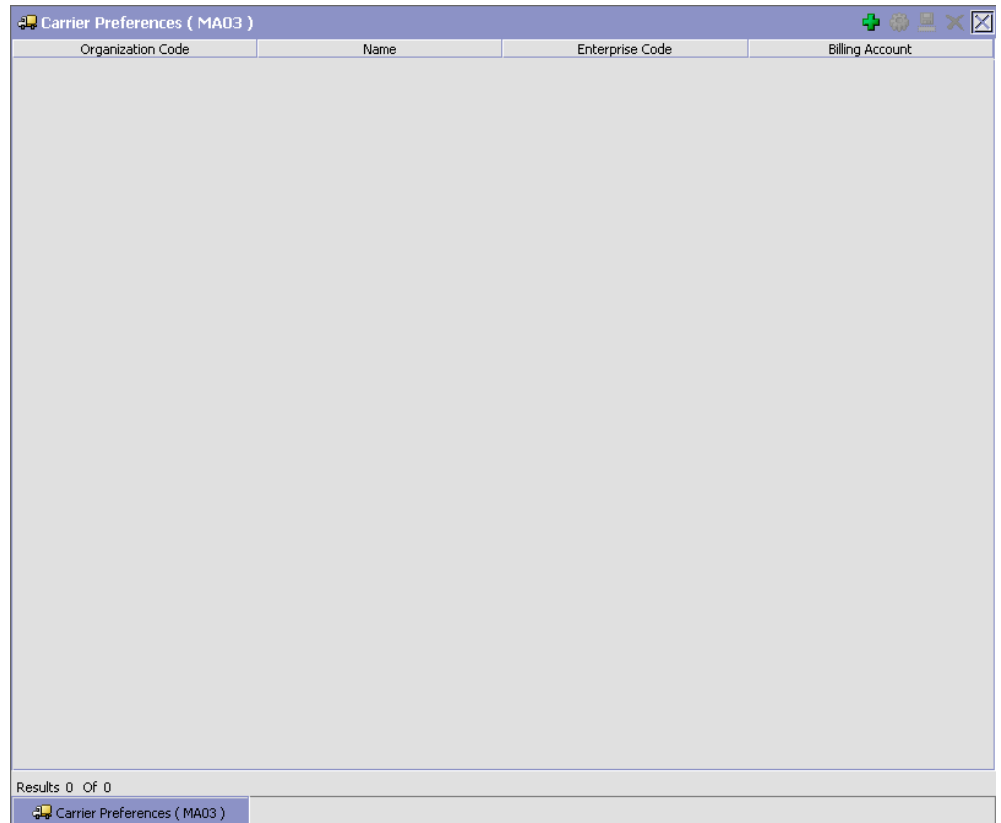
1. From the tree in the application rules side panel, choose Shipping > Parcel Carrier Preferences. The Parcel Carrier Preferences window displays.



2. In the Parcel Carrier Preferences window, choose . The Parcel Carrier Preferences Detail pop-up window displays.
3. Enter information in the applicable fields. Refer [Table 10–7](#) for field value descriptions.
4. Choose .

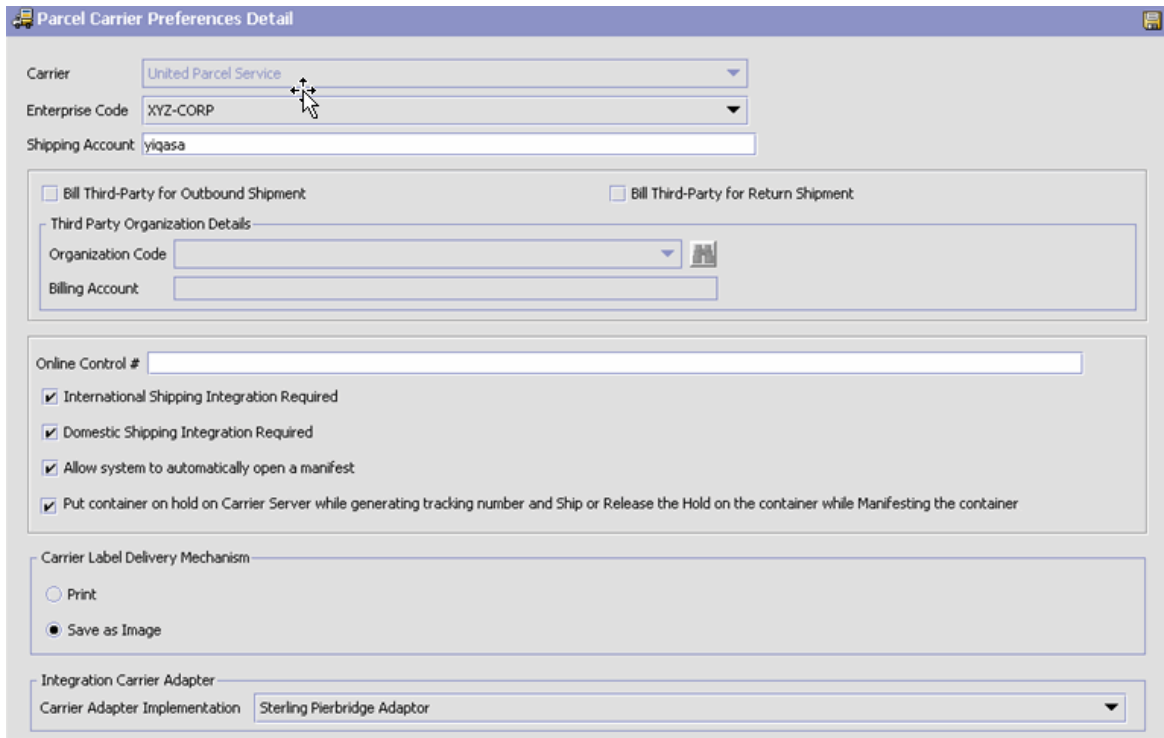

Parcel Carrier Preferences Detail

Carrier: United Parcel Service

Enterprise Code: XYZ-CORP

Shipping Account: yiqasa

Bill Third-Party for Outbound Shipment Bill Third-Party for Return Shipment

Third Party Organization Details

Organization Code: [dropdown]

Billing Account: [text field]

Online Control #: [text field]

International Shipping Integration Required

Domestic Shipping Integration Required

Allow system to automatically open a manifest

Put container on hold on Carrier Server while generating tracking number and Ship or Release the Hold on the container while Manifesting the container

Carrier Label Delivery Mechanism

Print

Save as Image

Integration Carrier Adapter

Carrier Adapter Implementation: Sterling Pierbridge Adaptor



Table 10–7 Parcel Carrier Preferences Detail Pop-up Window

Field	Description
Carrier	Choose the carrier to set up the preferences. This is a mandatory field.
Enterprise Code	Choose the enterprise code.
Shipping Account	Enter the shipping account information.
Bill Third Party for Outbound Shipment	Check this box to bill shipping charges to a third-party organization.
Bill Third Party for Return Shipment	Check this box to bill return shipping charges to a third-party organization.
Third Party Organization Details	

Field	Description
Organization Code	Choose the organization code of the third party organization.
Billing Account	Choose the billing account information of the third party organization.
Online Control #	Enter the online control number for the carrier preference.
International Shipping Integration Required	Check this box if international shipping integration is required.
Domestic Shipping Integration Required	Check this box if domestic shipping integration is required.
Allow system to automatically open a manifest	Check this box if the system should be allowed to automatically open a manifest.
Put container on hold on Carrier Server while generating tracking number and Ship or Release the Hold on the container while Manifesting the container	Check this box if the system should be allowed to put container on hold on carrier server while generating tracking number. Ship or release the hold while manifesting the container.
Carrier Label Delivery Mechanism	
Print	Choose this option to print the carrier label automatically.
Save as Image	Choose this option to save the carrier label in PNG format.
Integration Carrier Adapter	
Carrier Adapter Implementation	Choose the Carrier Adapter that you want to integrate with the selected carrier.

10.4.2 Creating a New Parcel Carrier Preference from an Existing Parcel Carrier Preference



To create a new parcel carrier preference from an existing parcel carrier preference:

1. From the tree in the application rules side panel, choose Shipping > Parcel Carrier Preferences. The Parcel Carrier Preferences window displays, with the list of Parcel Carrier Preferences.
2. In the Parcel Carrier Preferences window, choose the Parcel Carrier Preference to be copied from.
3. Choose . The Parcel Carrier Preferences Detail pop-up window displays.
4. Enter information in the applicable fields. Refer [Table 10–7](#) for field value descriptions.
5. Choose .

10.4.3 Modifying a Parcel Carrier Preference

Once a parcel carrier preference has been created, it can be modified.

To modify a parcel carrier preference:

1. From the tree in the application rules side panel, choose Shipping > Parcel Carrier Preferences. The Parcel Carrier Preferences window displays, with the list of Parcel Carrier Preferences.
2. In the Parcel Carrier Preferences window, choose the Parcel Carrier Preference to be modified.
3. Choose . The Parcel Carrier Preference Details pop-up window displays.
4. Enter information in the applicable fields. Refer [Table 10–7](#) for field value descriptions.
5. Choose .

10.4.4 Deleting a Parcel Carrier Preference

To delete a parcel carrier preference:

1. From the tree in the application rules side panel, choose Shipping > Parcel Carrier Preferences. The Parcel Carrier Preferences window displays, with the list of Parcel Carrier Preferences.
2. Choose the Parcel Carrier Preference to be deleted.
3. Choose .

10.5 Defining LTL Carrier Preferences

The LTL Carrier Preferences setup is used to configure the PRO Number generation in the Sterling WMS.

PRO Number refers to the unique progressive or serial number assigned by the carrier to identify and track a specific shipment. This is used on freight bills, bills of lading, and waybills for invoicing and tracking purposes.

A warehouse may define the range of PRO Numbers assigned by a carrier. The PRO Number has a fixed length defined for each carrier, and may contain a prefix.

PRO Number is typically generated during routing for a load with carrier type 'LTL'. The PRO number is regenerated automatically when the carrier/service on the load is changed.

Use LTL Carrier Preferences for:

- [Creating an LTL Carrier Preference](#)
- [Creating a New LTL Carrier Preference from an Existing LTL Carrier Preference](#)
- [Modifying an LTL Carrier Preference](#)
- [Deleting an LTL Carrier Preference](#)

10.5.1 Creating an LTL Carrier Preference

To create an LTL carrier preference:

1. From the tree in the application rules side panel, choose Shipping > LTL Carrier Preferences. The LTL Carrier Preferences window displays.

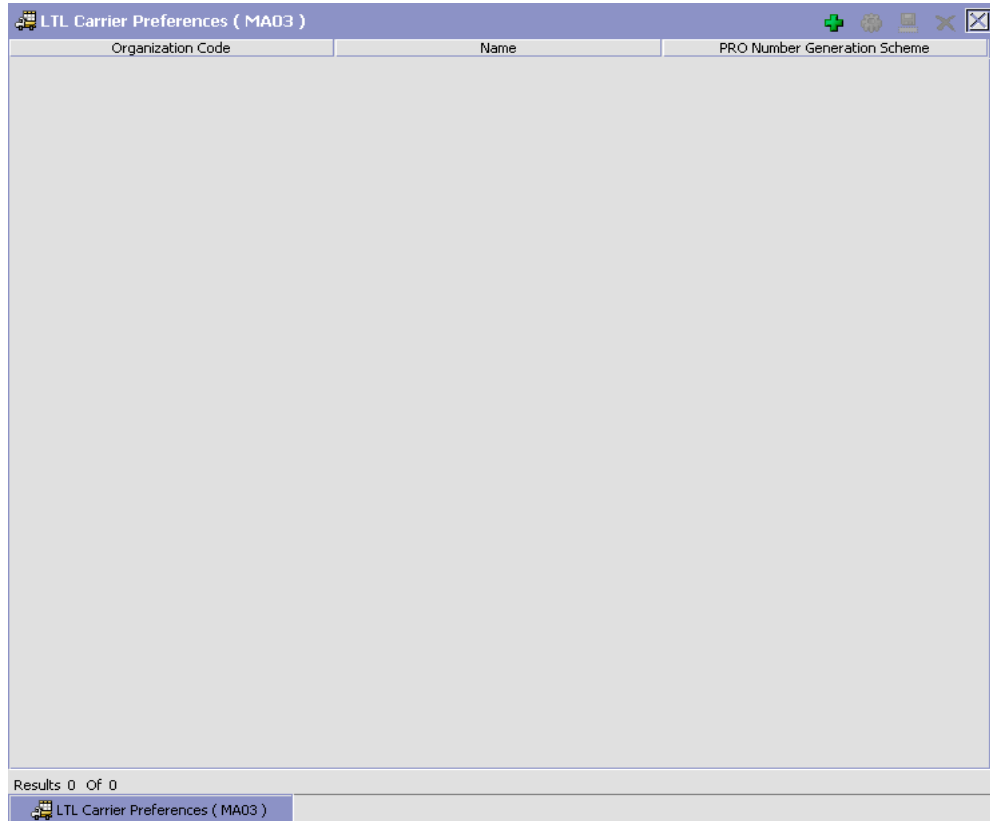



2. In the LTL Carrier Preferences window, choose . The PRO Number Generation Scheme pop-up window displays.
3. Enter information in the applicable fields. Refer [Table 10–8](#) for field value descriptions.
4. Choose .

Table 10–8 PRO Number Generation Scheme Popup Window

Field	Description
PRO Number Generation Scheme	One of the following actions is initiated based on the Generation Scheme selected: <ul style="list-style-type: none"> • The Sterling WMS generates the PRO Numbers • The Sterling WMS uses the PRO Numbers generated by an external system, or • The Sterling WMS does not generate PRO Numbers.
Carrier	Choose the carrier whose PRO Number Generation Scheme is being defined.
System Generated	Select System Generated if the Sterling WMS should generate PRO Numbers.
Externally Generated	Select Externally Generated if the Sterling WMS should use PRO Numbers generated by an external system.

Table 10–8 PRO Number Generation Scheme Popup Window

Field	Description
Do Not Generate	Select 'Do Not Generate' if PRO Numbers should not be generated.
Set up data for System Generated scheme	This is applicable only when the Sterling WMS generates the PRO Numbers.
PRO Number Sets	When the first range of PRO Numbers is used up, the Sterling WMS utilizes the second range of PRO Numbers, and vice versa.
PRO Number Set - 1	Defines the first range of PRO Numbers to be used by the Sterling WMS.
PRO Number Prefix	Enter the PRO Number Prefix to be used in generating the first range of PRO Numbers. PRO Number Prefix can be alpha numeric, and is not included for computing the check digit.
PRO Number Start	Enter the PRO Number Start to be used in generating the first range of PRO Numbers. PRO Number Start is the starting number for the first set of PRO Numbers.
PRO Number End	Enter the PRO Number End to be used in generating the first range of PRO number. PRO Number End is the ending number for the first set of PRO Numbers.
PRO Number Set - 2	Defines the second range of PRO Numbers to be used by the Sterling WMS.
PRO Number Prefix	Enter the PRO Number Prefix to be used in generating the second range of PRO Numbers. PRO Number Prefix can be alpha numeric, and is not included for computing the check digit.
PRO Number Start	Enter the PRO Number Start to be used in generating the second range of PRO Numbers. PRO Number Start is the starting number for the second set of PRO Numbers.
PRO Number End	Enter the PRO Number End to be used in generating the second range of PRO Numbers. PRO Number End is the ending number for the second set of PRO Numbers.

Table 10–8 PRO Number Generation Scheme Popup Window

Field	Description
Notification Threshold	<p>Enter the notification threshold at which an alert is raised to the user. This gains importance in instances where the second set of PRO Numbers is not defined.</p> <p>The notification threshold defines the number of unassigned PRO Numbers available till the PRO Number End. This enables the warehouse to talk to the carrier and get a new range of PRO Numbers.</p> <p>Note: If the PRO Number End is X, and the notification threshold is set to 50, the Sterling WMS raises an alert to the user, when the current PRO Number (unassigned) reaches X-50.</p>
Notification Service	<p>Choose Notification Service to be used.</p> <p>Notification Service is the service that is invoked when Notification Threshold is reached.</p>
Check Digit Determination	<p>Defines the check digit determination algorithm to be used for PRO Number Generation.</p>
Select Algorithm	<p>Choose the relevant algorithm for check digit determination.</p> <p>Typical values are MOD11, MOD10, INT10, CWC7, TSU11, NWTP7, MOD7, UPS, and NOCHECKDIGIT.</p> <p>Notes:</p> <ul style="list-style-type: none"> When the relevant algorithm for check digit is chosen, the check digit is generated out-of-the-box by the Sterling WMS. <p>For more details about Check Digit Determination Algorithm, see Section 10.5.1.1, "Setting Up a Check Digit Determination Algorithm" on page 865.</p> <ul style="list-style-type: none"> When you select "NO CHECK DIGIT" algorithm for check digit, it will enable you to generate the PRO Number without any check digit.

10.5.1.1 Setting Up a Check Digit Determination Algorithm

10.5.1.1.1 Creating a Check Digit Determination Algorithm

To set up a check digit determination algorithm:

1. In the PRO Number Generation Scheme pop-up window, choose .

- The Check Digit Algorithms Search window displays.

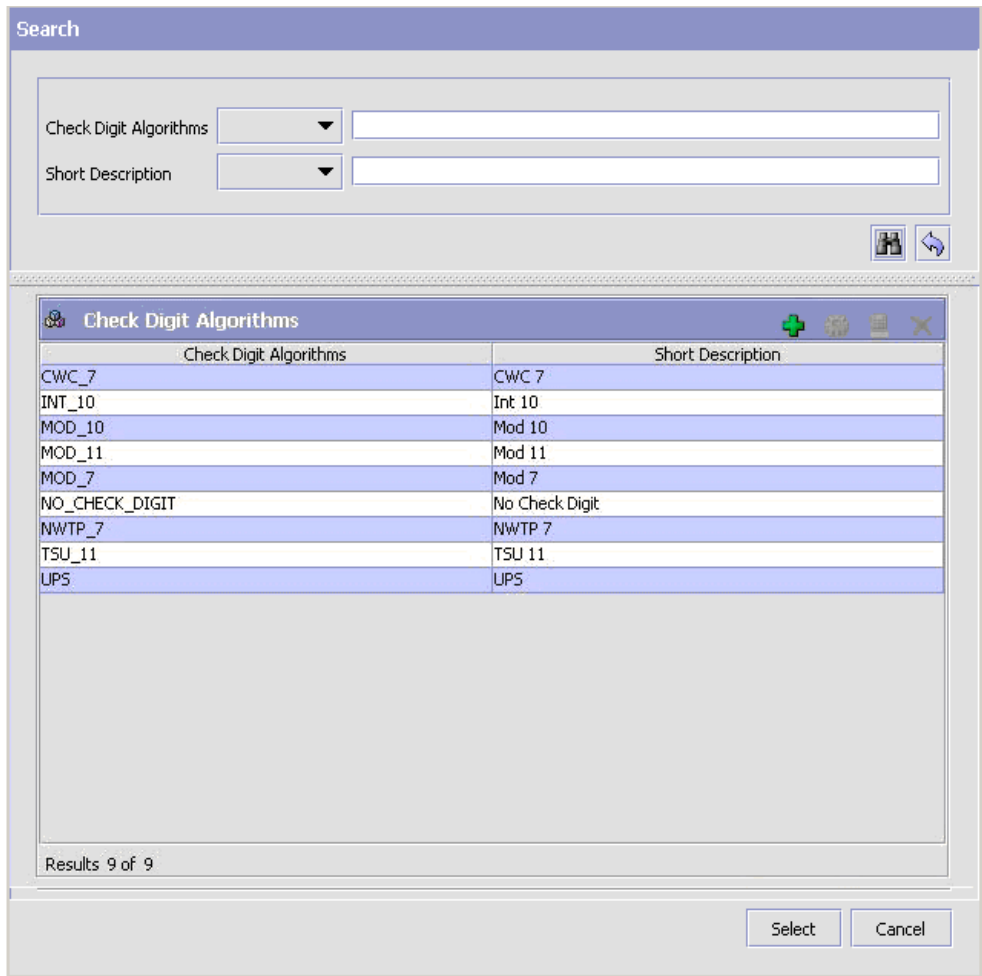

- In the Check Digit Algorithms panel, choose . The Check Digit Logic Details pop-up window displays.
- Enter information in the applicable fields. Refer [Table 10–9](#) for field value descriptions.
- Choose .

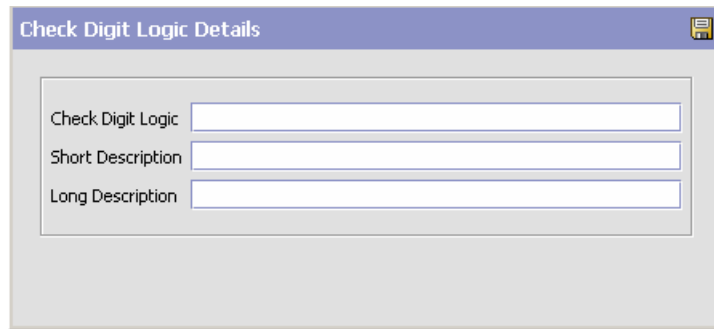





Table 10–9 *Check Digit Logic Details Popup Window*

Field	Description
Check Digit Logic	Enter the check digit logic for the algorithm being created.
Short Description	Enter a short description for the algorithm being created.
Long Description	Enter a long description for the algorithm being created.

10.5.1.1.2 Creating a New Check Digit Determination Algorithm from an Existing Check Digit Determination Algorithm

To create a new check digit determination algorithm from an existing check digit determination algorithm:





1. In the PRO Number Generation Scheme pop-up window, choose .
2. The Check Digit Algorithms Search window displays.
3. In the Search panel, enter applicable search criteria, and choose .
4. The relevant search results displays in the Check Digit Algorithms panel.
5. From the Check Digit Algorithms list, choose the Check Digit Algorithm to be copied from.
6. Choose . The Check Digit Logic Details pop-up window displays.

7. Enter information in the applicable fields. Refer [Table 10–9](#) for field value descriptions.
8. Choose .

10.5.1.1.3 Modifying a Check Digit Determination Algorithm



Once a check digit determination algorithm has been created, it can be modified.

To modify a check digit determination algorithm:

1. In the PRO Number Generation Scheme pop-up window, choose .
2. The Check Digit Algorithms Search window displays.
3. In the Search panel, enter applicable search criteria, and choose .
4. The relevant search results display in the Check Digit Algorithms panel.
5. From the Check Digit Algorithms list, choose the Check Digit Algorithm to be modified.
6. Choose . The Check Digit Logic Details pop-up window displays.
7. Enter information in the applicable fields. Refer [Table 10–9](#) for field value descriptions.
8. Choose .



10.5.1.1.4 Deleting a Check Digit Determination Algorithm

To delete a check digit determination algorithm:

1. In the PRO Number Generation Scheme pop-up window, choose .
2. The Check Digit Algorithms Search window displays.
3. In the Search panel, enter applicable search criteria, and choose .
4. The relevant search results displays in the Check Digit Algorithms panel.
5. From the Check Digit Algorithms list, choose the Check Digit Algorithm to be deleted.
6. Choose .

10.5.2 Creating a New LTL Carrier Preference from an Existing LTL Carrier Preference



To create a new LTL carrier preference from an existing LTL carrier preference:

1. From the tree in the application rules side panel, choose Shipping > LTL Carrier Preferences. The LTL Carrier Preferences window displays, with the list of LTL Carrier Preferences.
2. In the LTL Carrier Preferences window, choose the LTL Carrier Preference to be copied from.
3. Choose . The PRO Number Generation Scheme pop-up window displays.
4. Enter information in the applicable fields. Refer [Table 10–8](#) for field value descriptions.
5. Choose .

10.5.3 Modifying an LTL Carrier Preference

Once an LTL carrier preference has been created, it can be modified.

To modify an LTL carrier preference:

1. From the tree in the application rules side panel, choose Shipping > LTL Carrier Preferences. The LTL Carrier Preferences window displays, with the list of LTL Carrier Preferences.
2. In the LTL Carrier Preferences window, choose the LTL Carrier Preference to be modified.
3. Choose . The PRO Number Generation Scheme pop-up window displays.
4. Enter information in the applicable fields. Refer [Table 10–8](#) for field value descriptions.
5. Choose .

10.5.4 Deleting an LTL Carrier Preference

To delete an LTL carrier preference:

1. From the tree in the application rules side panel, choose Shipping > LTL Carrier Preferences. The LTL Carrier Preferences window displays, with the list of LTL Carrier Preferences.
2. Choose the LTL Carrier Preference to be deleted.
3. Choose .

10.6 Defining Shipping Modification Rules

The shipping modification rules apply to the following document types:

- Sales Order
- Transfer Order

For more information about shipping, defining, and changing modification rules, see the *Sterling Distributed Order Management: Configuration Guide*.

10.7 Defining Shipping Hold Types

The shipping hold types apply to the following document types:

- Sales Order
- Transfer Order

For more information about hold types, see the *Sterling Distributed Order Management: Configuration Guide*.

For more information about defining and modifying hold types, see the *Sterling Logistics Management: Configuration Guide*.

10.8 Defining Shipping Process Type Details

The shipping process type details apply to the following document types:

- Sales Order
- Transfer Order

For more information about shipping process type details, see the *Sterling Distributed Order Management: Configuration Guide*.

For more information about defining and modifying process type details, see the *Selling and Fulfillment Foundation: Application Platform Configuration Guide*.

10.9 Defining Shipping Process Model

The shipping process models apply to the following document types:

- Sales Order
- Transfer Order

For more information about shipping process models, see the *Sterling Distributed Order Management: Configuration Guide*.

For more information about pipeline determination, see the *Selling and Fulfillment Foundation: Application Platform Configuration Guide*.

10.10 Defining Load Modification Rules

The load modification rules apply to the following document types:

- Load

For more information about load modification rules, see the *Sterling Logistics Management: Configuration Guide*.

For more information about defining and changing modification rules, see the *Selling and Fulfillment Foundation: Application Platform Configuration Guide*.

10.11 Defining Load Hold Types

The load hold types apply to the load document types.

For more information about load hold types and defining and modifying load hold types see the *Sterling Logistics Management: Configuration Guide*.

10.12 Defining Load Process Type Details

The load process type details apply to the following document types:

- Load

For more information about load process type details, see the *Sterling Logistics Management: Configuration Guide*.

For more information about defining and modifying process type details, see the *Selling and Fulfillment Foundation: Application Platform Configuration Guide*.

10.13 Defining Load Process Model

The load process models apply to the following document types:

- Load

For more information about load process models, see the *Sterling Logistics Management: Configuration Guide*.

For more information about pipeline determination, see the *Selling and Fulfillment Foundation: Application Platform Configuration Guide*.

Configuring Transportation

You can record transportation or in-transit updates for a container. These updates are recorded against activities defined in Selling and Fulfillment Foundation as transportation activities.

11.1 Creating an Activity Code

To create an activity code:

1. From the tree in the application rules side panel, choose Transportation > Activities. The Activity Search window displays.
2. Enter information in the applicable fields. Refer to [Table 11–1](#) for field value descriptions.
3. Choose .

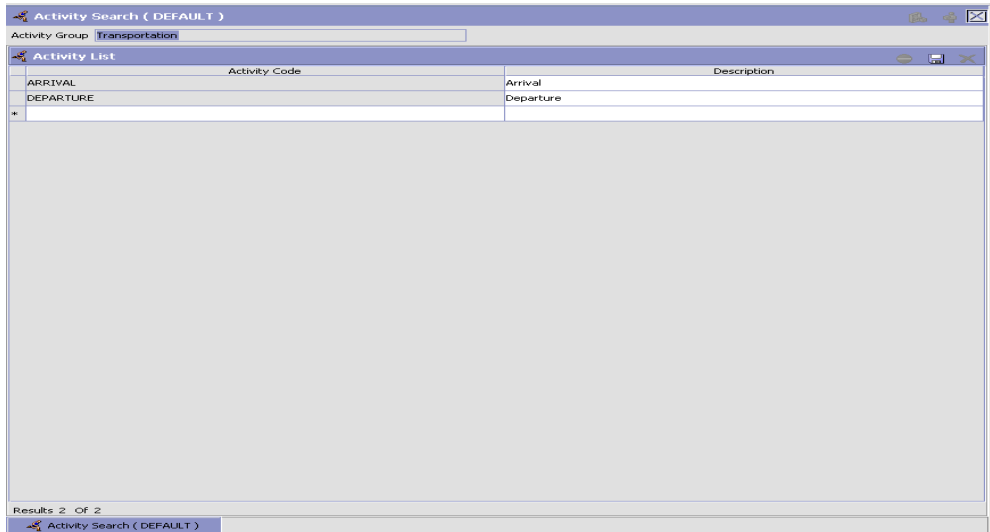



Table 11–1 Activity Search Window

Field	Description
Activity Group	This field is automatically populated by the system as 'Transportation'.
Activity List	
Activity Code	Enter a name for the activity code. This Activity Code is the unique identity of the activity.
Description	Enter a brief description for the activity code.

11.2 Modifying an Activity Code

To modify an activity code:

1. From the tree in the application rules side panel, choose Transportation > Activities. The Activity Search window displays, with the list of activities.
2. Enter information in the applicable fields. Refer to [Table 11–1](#) for field value descriptions.
3. Choose .

Note: It is recommended that you do not modify the list of activity codes provided by the Sterling WMS.

11.3 Deleting an Activity Code

To delete an activity code:

1. From the tree in the application rules side panel, choose Transportation > Activities. The Activity Search window displays, with the list of activities.
2. Choose the Activity Code to be deleted.
3. Choose .

Note: It is recommended that you do not modify the list of activity codes provided by the Sterling WMS.

12

Configuring Task Management

Task Management configuration enables you to set up your warehouse to optimize node throughput and maximize worker efficiency. Task management configuration consists of the following procedures:

- [Defining Installation Rules](#)
- [Defining Reason Codes](#)
- [Defining Task Types](#)
- [Defining User Skills](#)
- [Defining Productivity Types](#)
- [Defining Execution Exceptions](#)
- [Defining Transaction Repository](#)
- [Defining Purge Criteria](#)
- [Defining Aisle-Level User Constraints](#)

12.1 Defining Installation Rules



Installation rules are the set of rules that apply to task management for the following features:

- Task Statuses
- Batch Statuses
- Task References

12.1.1 Defining Task Statuses

Task statuses are the milestones within a pipeline through which a task travel. Batch status values are predefined and require common code set up. Extended statuses cannot be created.

To modify task status descriptions:

1. From the tree in the application rules side panel, choose Task Management > Installation Rules > Task Status. The Task Status window displays.
2. In the Task Status window, choose the task to be modified.
3. Choose . The Task Status Details popup window displays.
4. Edit information as applicable in the Long Description and Short Description fields.
5. Choose .

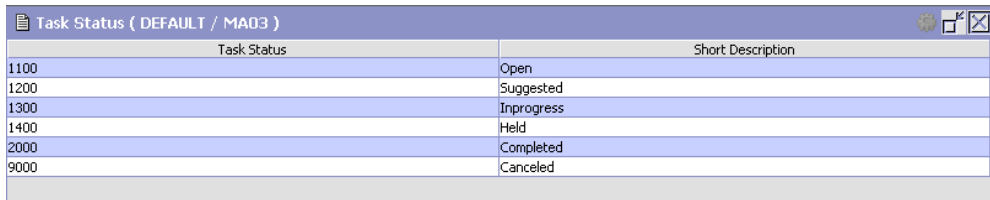

Task Status	Short Description
1100	Open
1200	Suggested
1300	Inprogress
1400	Held
2000	Completed
9000	Canceled

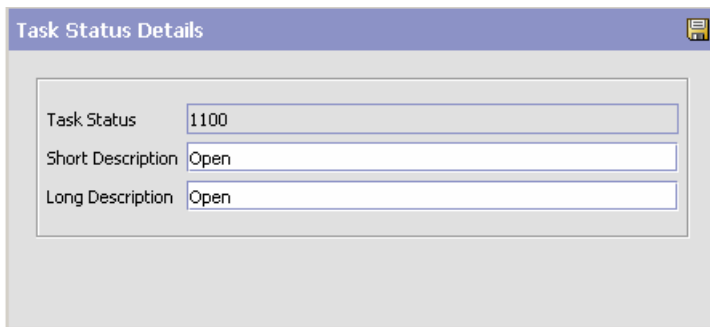

Task Status Details

Task Status:

Short Description:



Long Description:

12.1.2 Modifying Batch Status Descriptions

Batch statuses are the milestones within a pipeline that a batch of tasks travel through. Batch status values are pre-defined and require common code set up. Extended statuses cannot be created.

You can modify the description associated with each batch status.

To modify batch status descriptions:

1. From the tree in the application rules side panel, choose Task Management > Installation Rules > Batch Status. The Batch Status window displays.
2. In the Batch Status window, choose the batch to be modified.
3. Choose . The Batch Status Details popup window displays.
4. Edit information as applicable in the Long Description and Short Description fields.
5. Choose .

Batch Status (DEFAULT / MA03)

Batch Status	Short Description
1100	Open
2000	Completed
9000	Canceled

Results 3 Of 3

Batch Status (DEFAULT / MA03)



Batch Status Details

Batch Status	<input type="text" value="1100"/>
Short Description	<input type="text" value="Open"/>
Long Description	<input type="text" value="Open"/>

12.1.3 Viewing Task References

Task references are displays on the task summary. Each task can have multiple transaction reference. Task References are shipped as a set of Activity Groups.

To add task references:

1. From the tree in the application rules side panel, choose Task Management > Installation Rules > Task References. The Task References window displays.
2. In the Task references window, choose the Activity Group for which you want to view the task reference details.
3. Choose . The Task Reference Details popup window displays.
4. Choose a relevant Activity Group and Task Reference.
5. Choose .

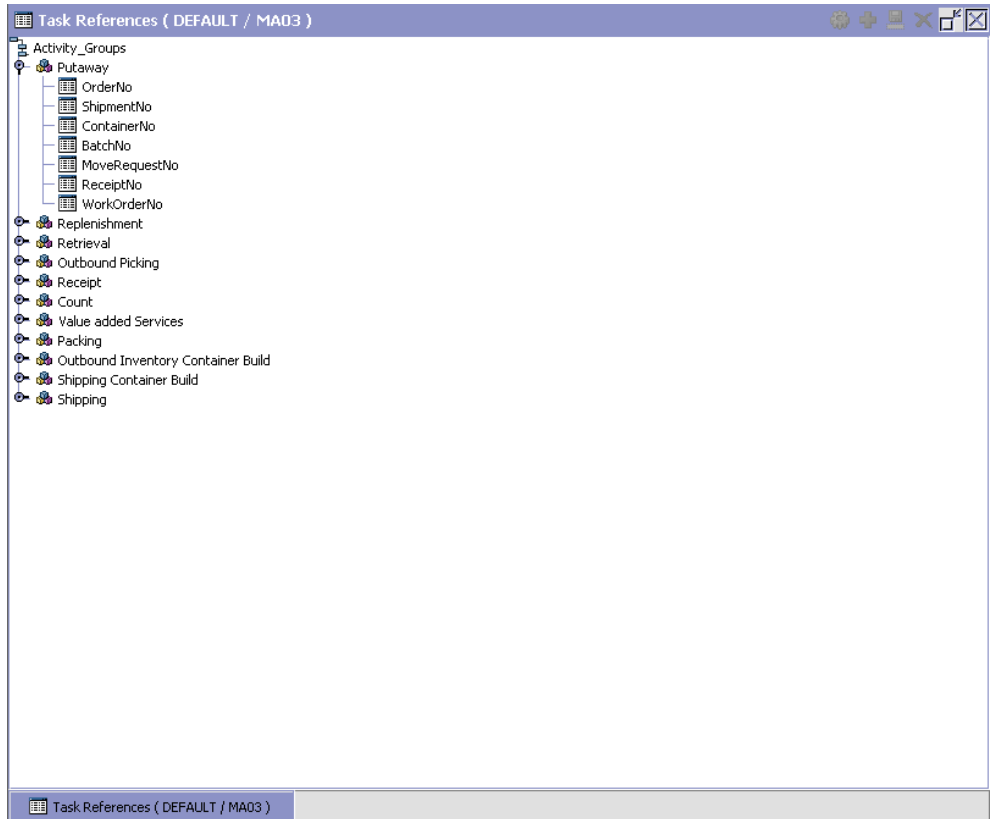

12.2 Defining Reason Codes



Reason codes are literals that enable the run-time users to add explanations for carrying out certain procedures, such as putting a task on hold for inventory replenishment.

Use Reason Codes for:

- [Setting Up Task Modification Reasons](#)

12.2.1 Setting Up Task Modification Reasons

To set up task modification reasons:

1. From the tree in the application rules side panel, choose Task Management > Reason Codes > Task Modification Reasons. The Task Modification Reasons window displays.
2. Choose . The Task Status Change Reason Details popup window displays.
3. Enter information in the applicable fields.
4. Choose .

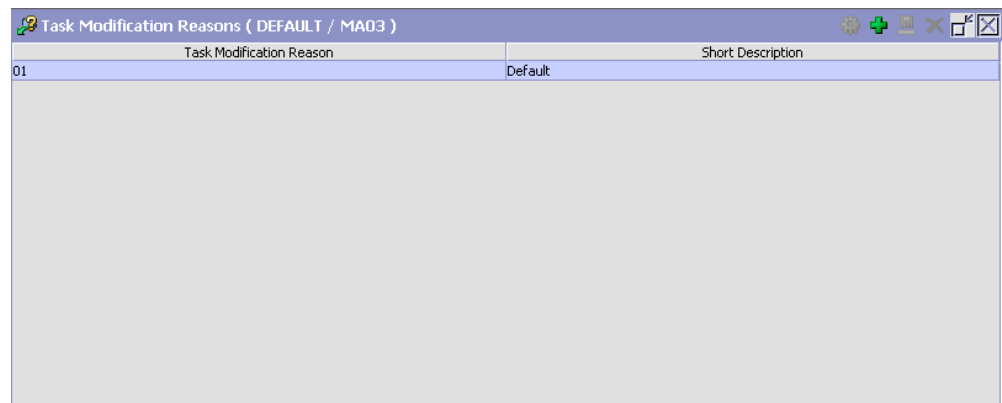

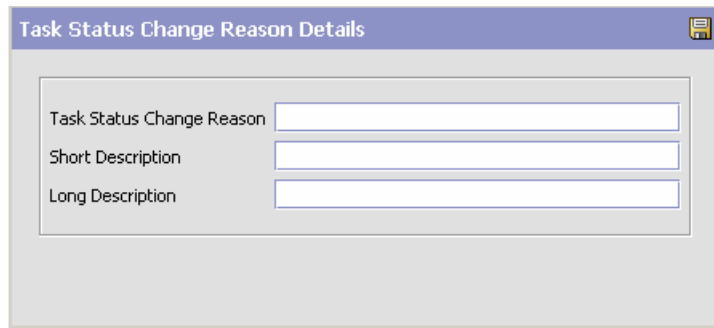



The screenshot shows a dialog box titled "Task Status Change Reason Details". It contains three text input fields:

- Task Status Change Reason
- Short Description
- Long Description



12.2.2 Modifying Reason Codes

To modify task modification reasons:

1. From the tree in the application rules side panel, choose Task Management > Reason Codes > Task Modification Reasons. The Task Modification Reasons window displays.
2. Select the Task Modification Reason to be modified.
3. Choose . The Task Status Change Reason Details popup window displays.
4. Enter information in the applicable fields.
5. Choose .

12.2.3 Deleting Reason Codes

To delete task modification reasons:

1. From the tree in the application rules side panel, choose Task Management > Reason Codes > Task Modification Reasons. The Task Modification Reasons window displays.
2. Select the Modification Reason Code to be deleted.
3. Choose .
4. Choose .

12.3 Defining Task Types

Task types provide a way to define exactly how common tasks are to be performed. For example, an everyday task may involve picking cases from shelves and bringing them to a packing station.

When you create a task type, you can define very specifically the way in which a task should be performed. Then, by assigning a task type to individual tasks, the task executor knows exactly how the task should be performed. For example, a user group called "Pickers" would have an associated task type called "Picking Batches," which specifies that their set of tasks are to pick sets of items from Zone A and deposit them in Zone B.

Task types are grouped within Activity Groups. Selling and Fulfillment Foundation has predefined Activity Groups that enable you to easily define a set of task types that share some common characteristics with other tasks that belong to the same Activity Group.

Note: You cannot add, delete, or modify Activity Groups. However, you can add, delete, and modify Task Types within these Activity Groups.

Each Activity Group has an associated group of activities. For example, the Outbound Picking activity group consists of tasks pertaining to picking, such as the following activities:

- Picking batches
- Picking items
- Picking orders

12.3.1 Understanding Task Type Logic Flows

Each task type may require a specialized flow of logic, depending on the activities performed within the task type. For example, one task type for outbound products may involve counting, picking, and packing a product; and another task type for replenishment may involve unpacking, counting, and shelving a product. These task types may contain sub flows of logic as follows:

- Count - This flow may involve a batching subflow and a mobile device subflow. See [Figure 12–3, "Count Flow Task Type Logic"](#).
- Outbound Picking - This flow may involve a batching subflow. See [Figure 12–4, "Outbound Picking Task Type Logic"](#).
- Mobile Device - This flow captures activities that involve a mobile device and may involve a batching subflow. See [Figure 12–6, "Mobile Device Task Type Logic"](#).

These flows of logic depict the decision tree presented to you by the Task Type Wizard. This section describes the Task Type wizard flow of logic from start to finish. For a description of the graphical elements used to depict the logic see [Figure 12–1, "Task Type Wizard Logic Flow"](#).

Figure 12–1 Task Type Wizard Logic Flow

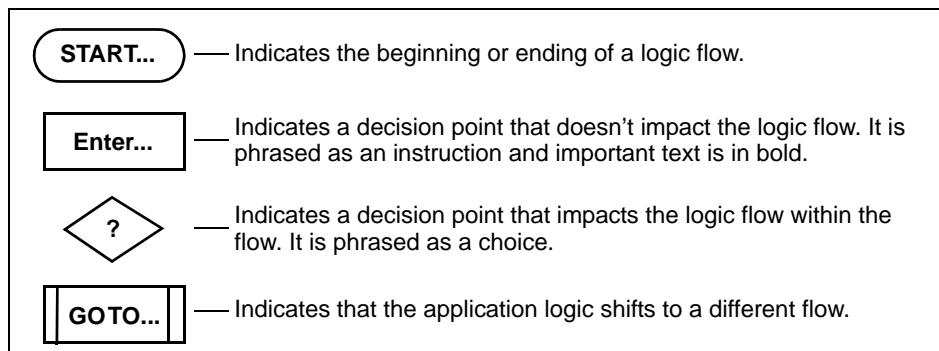

Start Flow

For each task type, the Task Type Wizard begins with logic flow shown in [Figure 12–2, "Start Task Type Logic"](#).

Figure 12–2 Start Task Type Logic

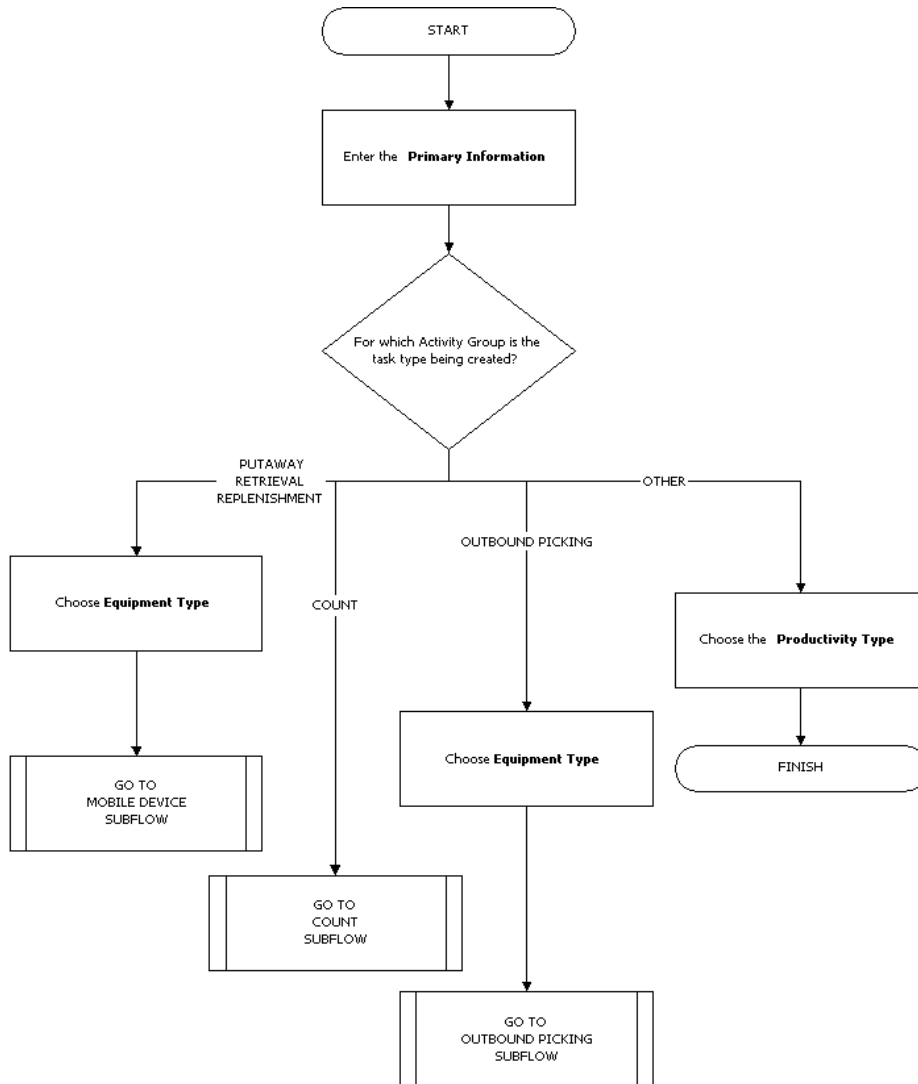

Count Flow

For Count task types, the Task Type Wizard uses the logic flow shown in Figure 12–3, "Count Flow Task Type Logic".

Figure 12–3 Count Flow Task Type Logic

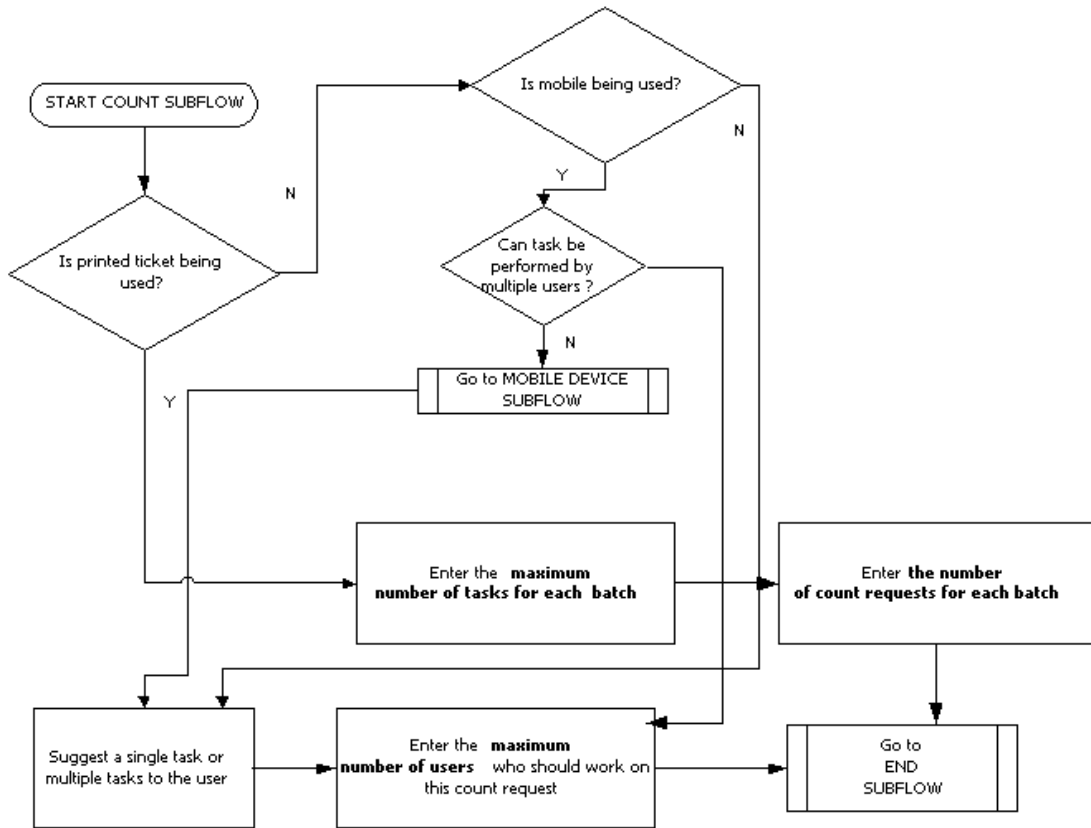

Outbound Picking Flow

For Outbound Picking task types, the Task Type Wizard uses the logic flow shown in [Figure 12–4, "Outbound Picking Task Type Logic"](#).

Figure 12-4 Outbound Picking Task Type Logic

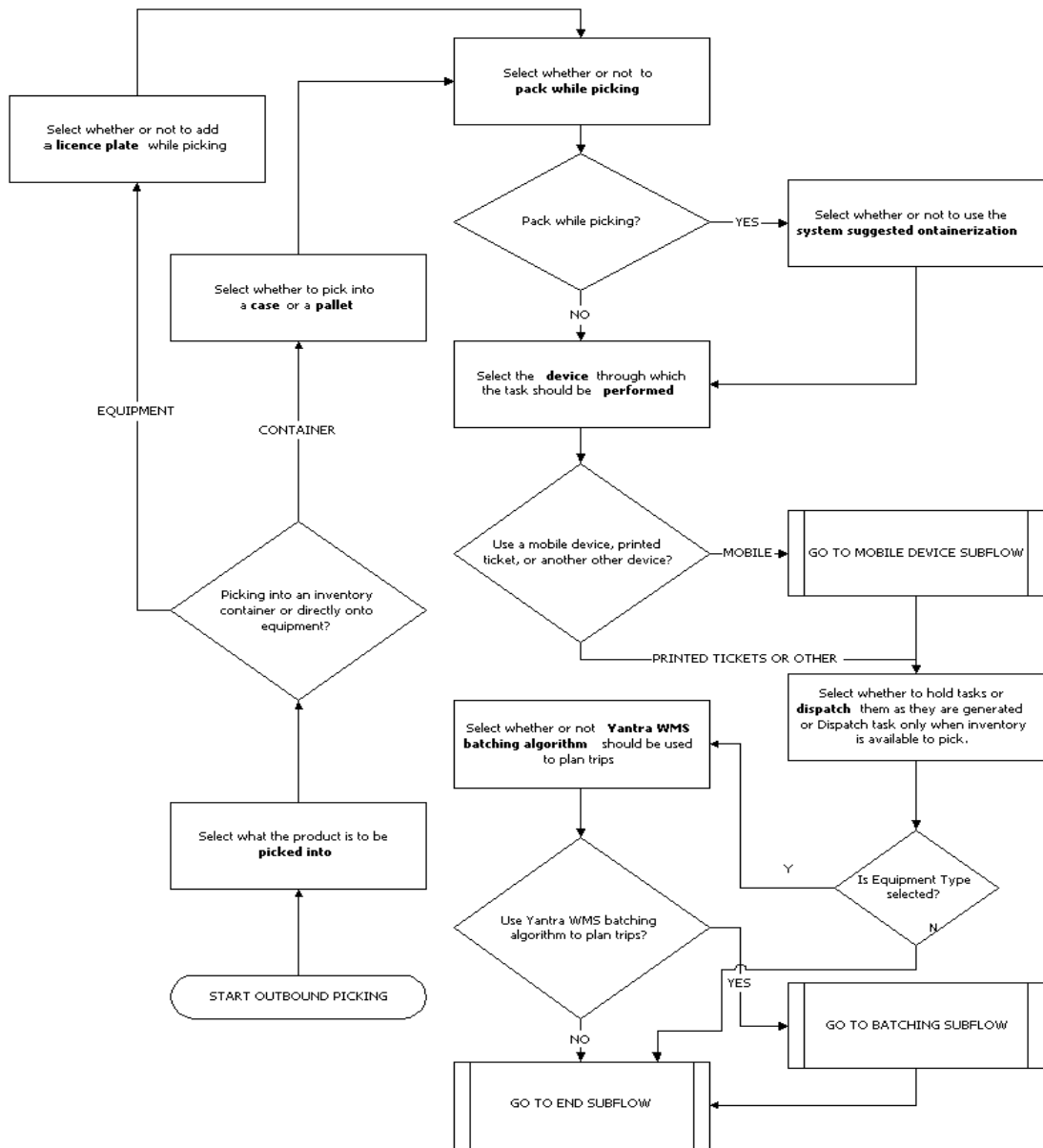

Batching Subflow

For task types that involve batching, the Task Type Wizard uses the logic flow shown in Figure 12–5, "Batching Subflow Task Type Logic".

Figure 12–5 Batching Subflow Task Type Logic

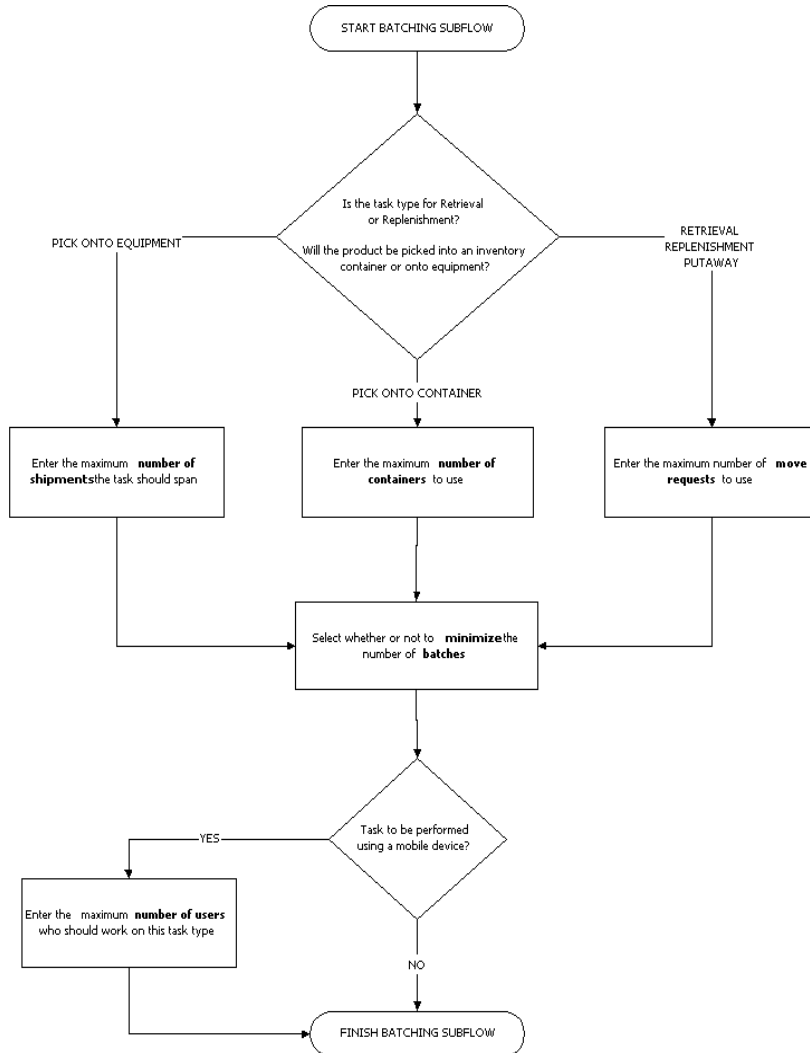

Mobile Device Subflow

For task types that involve a mobile device, the Task Type Wizard uses the logic flow shown in [Figure 12–6, "Mobile Device Task Type Logic"](#).

Figure 12–6 Mobile Device Task Type Logic



End Flow

For each task type, the Task Type Wizard completes the logic flow shown in Figure 12–7, "End Flow Task Type Logic".

Figure 12–7 End Flow Task Type Logic

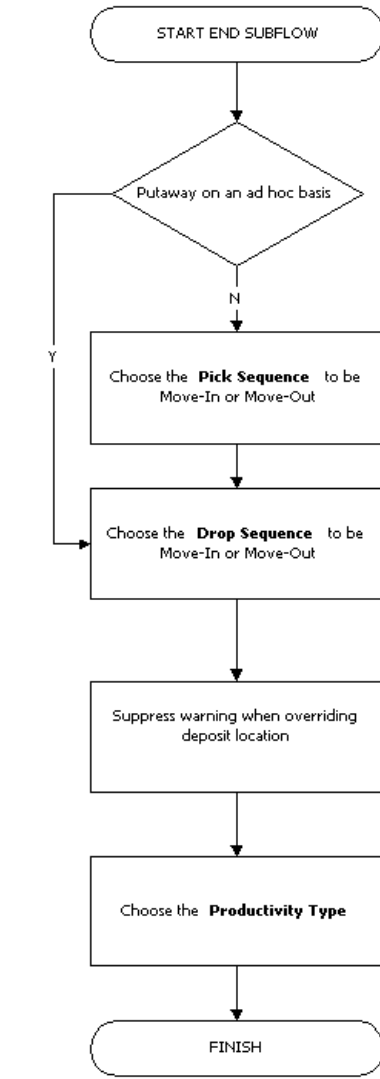

12.3.2 Creating a Task Type

Selling and Fulfillment Foundation provides a Task Type Wizard that enables you to plan work flow activities.

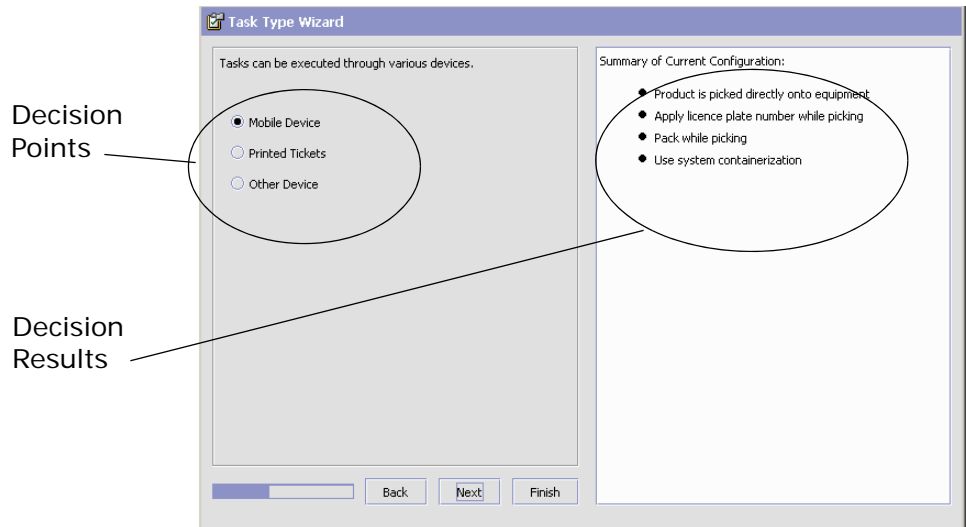

The Task Type Wizard displays configuration choices that are tailored to the Activity Group for which you are configuring a Task Type. As you make decisions, the wizard displays information in two panels as shown in Figure 12-3. The left panel displays decision points for you to take action on and the right panel displays the results of the decisions you have made.

To create a task type:

1. From the tree in the application rules side panel, choose Task Management > Task Types. The Task Types window displays.
2. Select the Activity Group within which you want to create a task type.
3. Choose **+**. The Task Type Wizard displays.
4. For Task Type, enter an identifier.
5. For Description, enter a description of the Task Type. This description displays in the Task Types tree later.

6. From the Activity drop-down, choose an Activity. The items that appear on this list correspond with the Activity Group for which you are configuring a task type.
7. Choose Next. This begins the flow of logic as illustrated in [Section 12.3.1, "Understanding Task Type Logic Flows"](#) on page 885. Enter information in the applicable fields and choose Next to continue until all applicable decision points have been answered.
8. Choose .

Notes: When outbound pick tasks are run using printed tickets or other devices, the system automatically completes pick tasks that are open when performing pack operations.



Task Assignment Sort Order

Task Types are prioritized based on the User Task Type priority (user skillsets) and Task Type priority (importance accorded to the task type).

When there is a conflict between the priority accorded to any said Task Type (where two task types have the same priority), any one of the task types are sorted and suggested for completion based on availability.

12.3.3 Modifying a Task Type

To modify a task type:

1. From the tree in the application rules side panel, choose Task Management > Task Types. The Task Types window displays.
2. Expand the Activity Group that contains the task type you want to modify, if needed.
3. Choose . The Task Type Wizard popup window displays.
4. Enter information in the applicable fields.
5. Choose .

12.3.4 Deleting a Task Type

To delete a task type:

1. From the tree in the application rules side panel, choose Task Management > Task Types. The Task Types window displays.
2. Expand the Activity Group that contains the task type you want to delete, if needed.
3. Select the Task Type you want to delete.
4. Choose .

12.4 Defining User Skills

User Skills define the types of tasks and the places within a node are associated with a specific Team.

Teams are used to control access to the data contained in specific document types and Enterprises within the Sterling Commerce Console. A team is used to further restrict the access to any Enterprises or document types that are a sub-set of the default access list. For more information about defining teams, see the *Selling and Fulfillment Foundation: Application Platform Configuration Guide*.

User skills are based on data security settings that have been defined, and consist of user task types and user zones defined.

User Task Types

User task types consist of the following criteria:

- Task type
- Task type priority

You can add, modify, and delete user task types as needed.

User Zones

User zones consist of the following criteria:

- Type
- Zone
- Aisle

You can add, modify, and delete user task zones as needed.

Note: Setting Up User Task Types are mandatory, while Setting Up User Zones is optional.

12.4.1 Adding a User Task Type

To add a user task type:

1. From the tree in the application rules side panel, choose Task Management > User Skills. The User Skills window displays.



2. Select the Team within which you want to define user skills. The User Skills window refreshes to display information as it pertains to the Team you selected.
3. In the User Task Types panel, select relevant Task Type and enter a Priority for the task type.
4. Choose .

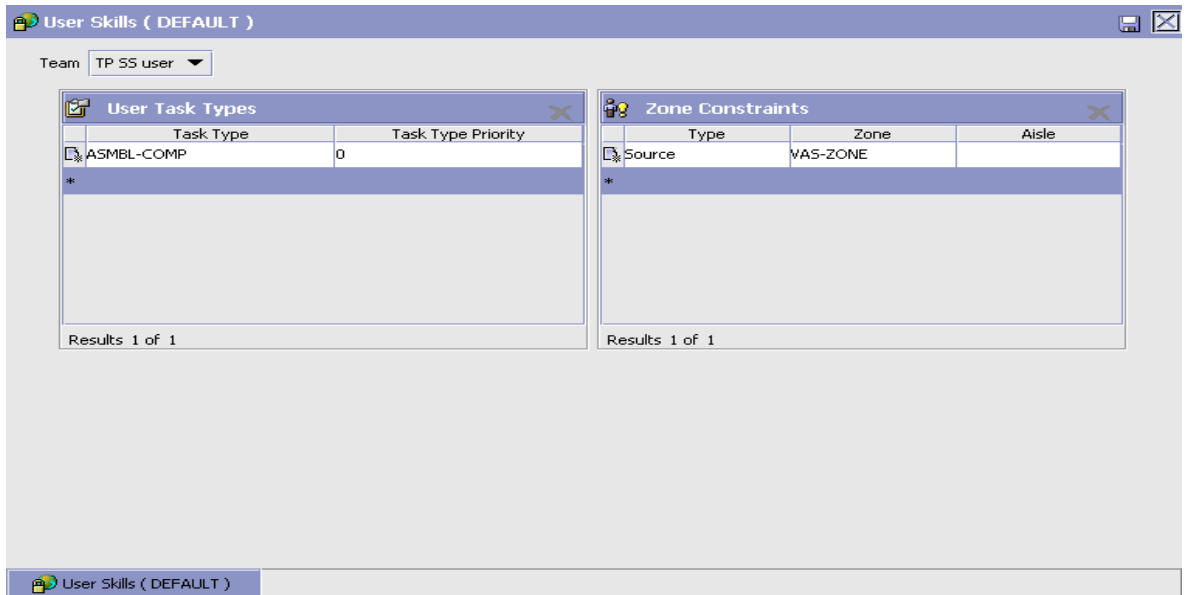

12.4.1.1 Modifying a User Task Type Definition

To modify a user task type definition:

1. From the tree in the application rules side panel, choose Task Management > User Skills. The User Skills window displays.
2. Select the Team within which you want to define user skills. The User Skills window refreshes to display information as it pertains to the Team you selected.
3. In the User Task Types panel, select the Task Type you want to modify and enter new data as needed.
4. Choose .

12.4.1.2 Deleting a User Task Type Definition

To delete a user task type definition:

1. From the tree in the application rules side panel, choose Task Management > User Skills. The User Skills window displays.

2. Select the Team within which you want to delete a user task type. The User Skills window refreshes to display information as it pertains to the Team you selected.
3. In the User Task Types panel, select the task type you want to delete.
4. Choose .

12.4.2 Adding Zone Constraints

To add a zone constraint:

1. From the tree in the application rules side panel, choose Task Management > User Skills. The User Skills window displays.
2. Select the Team within which you want to define user skills. The User Skills window refreshes to display information as it pertains to the Team you selected.
3. In the Zone Constraints panel, select a Zone, select a zone type (for example, Source or Target), select a zone area (for example B1 or L1) and enter an aisle number.
4. Choose .

Note: The Zone Type field is mandatory for all entries in the Zone Constraints panel, else 'Type must be entered' error is thrown while saving.

For Zone constraints to be applicable for task types with activity code as Count, select Source as the Zone type.

12.4.2.1 Modifying a Zone Constraint

To modify a zone constraint:

1. From the tree in the application rules side panel, choose Task Management > User Skills. The User Skills window displays.
2. Select the Team within which you want to define user skills. The User Skills window refreshes to display information as it pertains to the Team you selected.
3. In the User Zone panel, select a Zone you want to modify and enter new data as needed.

4. Choose .

12.4.2.2 Deleting a User Zone Definition

To delete a zone constraint:

1. From the tree in the application rules side panel, choose Task Management > User Skills. The User Skills window displays.
2. Select the Team within which you want to delete a user zone definition. The User Skills window refreshes to display information as it pertains to the Team you selected.
3. In the User Zone panel, select the zone you want to delete.
4. Choose .

12.5 Defining Productivity Types

Use Productivity Types for:

- [Setting Up Productivity Types](#)
- [Setting Up Purge Criteria](#)

12.5.1 Setting Up Productivity Types

The Sterling WMS tracks all activities performed at the user and activity level. This is measured against productivity metric associated with the activity. This enables a warehouse to calculate labor efficiency, and support activity-based compensation to all users.

The Sterling WMS models each activity in a warehouse by identifying variables applicable to the productivity of an activity. A warehouse defines Standard Allowable Minutes (SAM) for all variables in the activity. SAM values are determined after detailed time and motion study on each activity, which includes receiving, pallet moves, case replenishment, and special ticketing.

The different variables that would impact total time spent on an activity include the number of locations visited, UOMs and items in the trip. The additional factors are the number of aisles and distance traveled. If multiple trips are required to complete the activity, then that is also factored into the total time spent.

For example, replenishment from a bulk storage location has effort to pick an empty pallet, pick product into the pallet from multiple locations, drop off pallet into a location and traverse aisles while performing pick and drop off.

These distinct activities are captured by Standard Allowable Minutes (SAM). A productivity type is associated with a SAM and some additional attributes that define the capturing of the activity.

Activities that run through the Sterling WMS are associated with a task type. Manual tasks run can be associated directly with a productivity type. For example, stacking of pallets, setting up of cartons for a cart.

Use Productivity Types for:

- [Creating a Productivity Type](#)
- [Modifying a Productivity Type](#)
- [Deleting a Productivity Type](#)

12.5.1.1 Creating a Productivity Type

To create a productivity type:

1. From the tree in the application rules side panel, choose Task Management > Productivity > Productivity Types. The Productivity Types window displays.
2. Choose . The Productivity Type Details window displays.

Productivity Type Details (MA01)

Productivity Type: PT1

Description: Productivity Type 1

Capture Trip Level Metrics: Yes No

Max Idle Time Between Tasks: []

SAM Definition | Productivity References | Task Types | Equipment Types

Task Execution | Planning

SAM Per Productivity Batch 0 | 0

SAM Per Task 0 | 0

Product

Task Execution | Planning

SAM Per Item 0 | 0

SAM Per Case 0 | 0

SAM Per Unit Weight 0 | 0

SAM Per Unit 0 | 0

SAM Per Pallet 0 | 0

Location

SAM Per Source Location 0 | SAM Per Source Aisle 0

SAM Per Target Location 0 | SAM Per Target Aisle 0

SAM Per Unit Horizontal Distance 0 | SAM Per Source Level 0

SAM Per Unit Vertical Distance 0 | SAM Per Target Level 0

Productivity Types (MA01) | Productivity Type Details (MA01)

Note: For voice-based tasks, productivity for a user is not tracked correctly.

When creating a Productivity Type, you must understand the following concepts:

- [Setting Up a Productivity Type's SAM Definition](#)
- [Setting Up a Productivity Type's Productivity References](#)

- [Setting Up a Productivity Type's Task Types](#)
- [Setting Up a Productivity Type's Equipment Types](#)

12.5.1.1.1 Setting Up a Productivity Type's SAM Definition

The productivity is tracked in terms of Standard Allowable Minutes for the productivity type.

For example, Number of Pallets is multiplied by Allowed Minutes Per Pallet to derive the Credited Minutes.

To set up a productivity type's SAM definition:

1. In Productivity Type Details window, choose the SAM Definition tab.
2. Enter information in the applicable fields. Refer [Table 12–1](#) for field value descriptions.
3. Choose .

Table 12–1 SAM Definition Tab

Field	Description
Productivity Type	Enter a name for the productivity type. This indicates the type defined for this SAM. It is directly associated to a task type. Typical values are 'Pallet Moves', 'Case Moves', 'Loose Pick' and 'Unloading Cartons from Trailer'.
Description	Enter a description for the productivity type.
Capture Trip Level Metrics	Choose "Yes" to capture trip level metric. Choose "No" not to capture trip level metric. A trip either indicates a batch of activity done, or denotes the travel from the first pickup to the corresponding drop-off of inventory. This flag indicates that extra credits are given for the number of trips. For example, a user who travels through 50 locations in a single trip, versus a user who has to complete 5 trips to complete 50 locations.
Max Idle Time Between Tasks	Enter the maximum idle time between tasks.
SAM Definition	
Task Execution	

Table 12–1 SAM Definition Tab

Field	Description
SAM Per Productivity Batch	<p>Check the box to enter SAM for each productivity batch in minutes for task execution.</p> <p>This indicates the time credited for users for each system created batch or a trip, if trip-level metrics is set to "Yes".</p> <p>Warehouses that do not create batches and have the trip-level metrics set to "No", the time credit is considered for the entire day.</p>
SAM Per Task	<p>Check the box to enter SAM for each task in minutes for task execution.</p> <p>This indicates the time credited for users fro each task performed. Typically, either SAM per Productivity Batch or SAM Per Task values are used to specify SAM for a productivity type.</p>
Planning	
SAM Per Productivity Batch	<p>Check this box to enter SAM for each productivity batch in minutes for task planning.</p> <p>This indicates the time credited for users for each system created batch or a trip, if trip-level metrics is set to "Yes".</p> <p>Warehouses that do not create batches and have the trip-level metrics set to "No", the time credit is considered for the entire day.</p>
SAM Per Task	<p>Check this box to enter SAM for each task in minutes for task planning.</p> <p>Indicates the time credit for users for each task performed. Typically, either SAM per Productivity Batch or SAM Per Task values are used to specify SAM for a productivity type.</p>
Product	
Task Execution	
SAM Per Item	<p>Check this box to enter SAM for each item in minutes for task execution.</p> <p>This indicates the time credited for users per item handled.</p>

Table 12–1 SAM Definition Tab

Field	Description
SAM Per Case	<p>Check this box to enter SAM for each case in minutes for task execution.</p> <p>This indicates the time credited for users per case handled.</p>
SAM Per Unit Weight	<p>Check this box to enter SAM for each unit weight in minutes for task execution.</p> <p>This indicates the time credited for users per unit weight handled.</p>
SAM Per Unit	<p>Check this box to enter SAM for each unit in minutes for task execution.</p> <p>This indicates the time credited for users per unit handled.</p>
SAM Per Pallet	<p>Check this box to enter SAM for each pallet in minutes for task execution.</p> <p>This indicates the time credited for users per pallet handled.</p>
Planning	
SAM Per Item	<p>Check this box to enter SAM for each item in minutes for task planning.</p> <p>This indicates the time credited for users per item handled.</p>
SAM Per Case	<p>Check this box to enter SAM for each case in minutes for task planning.</p> <p>This indicates the time credited for users per case handled.</p>
SAM Per Unit Weight	<p>Check this box to enter SAM for each unit weight in minutes for task planning.</p> <p>This indicates the time credited for users per unit weight handled.</p>
SAM Per Unit	<p>Check this box to enter SAM for each unit in minutes for task planning.</p> <p>This indicates the time credited for users per unit handled.</p>

Table 12–1 SAM Definition Tab

Field	Description
SAM Per Pallet	Check this box to enter SAM for each pallet in minutes for task planning. Indicates the time credit for users per pallet handled.
Location	
SAM Per Source Location	Enter SAM for each source location in minutes. This indicates the time credited for users per source location visited.
SAM Per Source Aisle	Enter SAM for each source aisle in minutes. This indicates the time credited for users per source aisle visited.
SAM Per Target Location	Enter SAM for each target location in minutes. This indicates the time credited for users per target location visited.
SAM Per Target Aisle	Enter SAM for each target aisle in minutes. This indicates the time credited for users per target aisle visited.
SAM Per Unit Horizontal Distance	Enter SAM for each unit horizontal distance in minutes. This indicates the time credited for users per unit horizontal distance visited.
SAM Per Source Level	Enter SAM for each source level in minutes. This indicates the time credited for users per source level visited.
SAM Per Unit Vertical Distance	Enter SAM for each unit vertical distance in minutes. This indicates the time credited for users per unit vertical distance visited.
SAM Per Target Level	Enter SAM for each target level in minutes. This indicates the time credited for users per target level visited.

Typically, a unique productivity type is created for each combination of type of equipment, UOM being handled.

SAM values for manual processes, such as picking using printed batch sheets, are manually input through the *Productivity Console*.

12.5.1.1.2 Setting Up a Productivity Type's Productivity References

A productivity reference indicates the transactional attribute being tracked for grouping purposes.

Note: A productivity type must be first created before a reference is associated with it. Click on the Save button to create the productivity type.

For example, for productivity type associated to a receipt or putaway task, receipt number is the transactional reference. Productivity grouping is done at a user level, productivity type level, and reference level for a particular day or a trip level.

To set up a productivity type's productivity references:

1. In Productivity Type Details window, choose the Productivity References tab.
2. Enter information in the applicable fields. Refer [Table 12–2](#) for field value descriptions.
3. Choose .

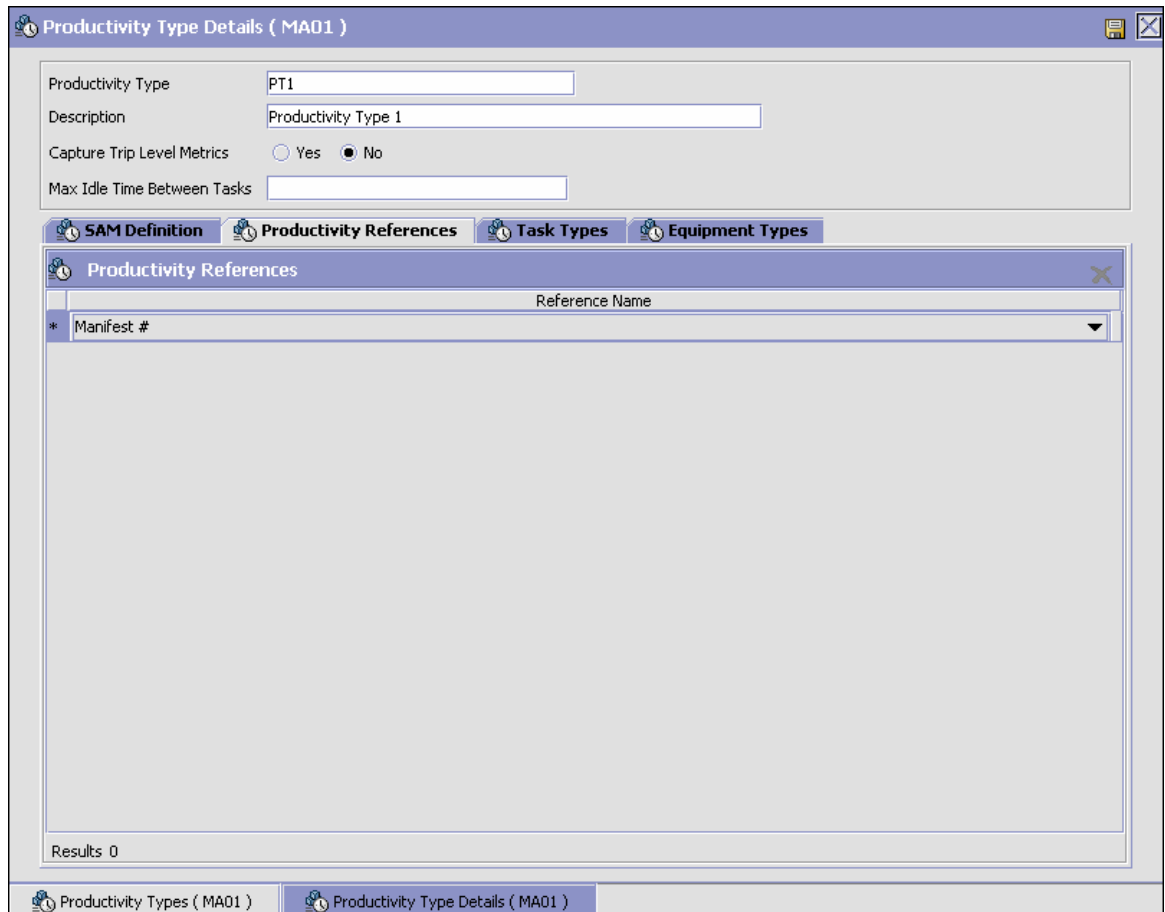

Table 12–2 Productivity References Tab

Field	Description
Reference Name	<p>Select the transactional reference associated with the productivity type from the drop-down list.</p> <p>Specify multiple references to track for a productivity type. For example, receipt productivity type has user id, receipt number, and shipment number, which are tracked as references.</p>

12.5.1.1.3 Setting Up a Productivity Type's Task Types

A productivity type is associated with a task type. The association with a task type allows for the SAM timings to be associated to an activity and the equipment being used.

For more information about the attributes associated with a task, see [Section 12.3, "Defining Task Types"](#).

For example, a productivity type of putaway is associated with task types that are used to perform putaway.

To set up a productivity type's task types:

1. In Productivity Type Details window, choose the Task Types tab.
2. Enter information in the applicable fields. Refer to [Table 12–3](#) for field value descriptions.
3. Choose .

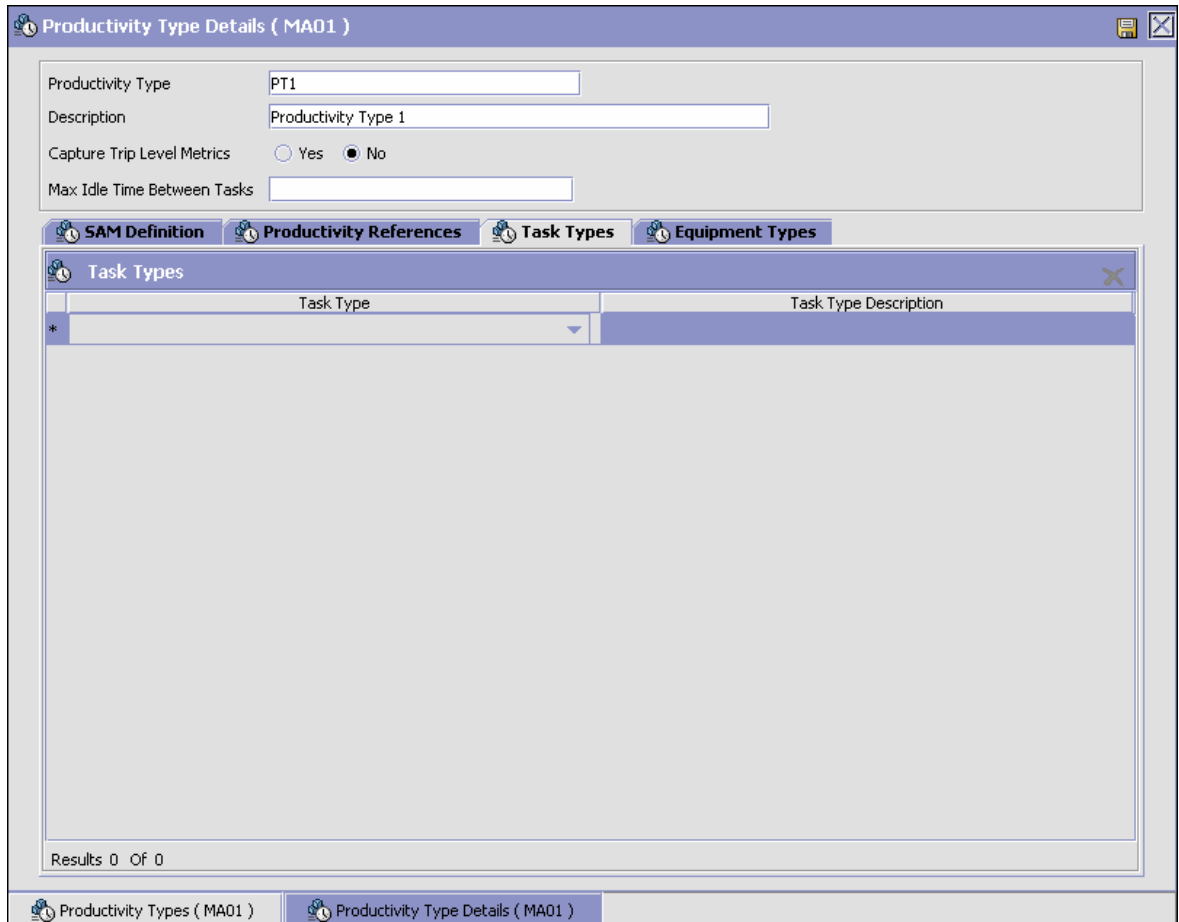

Table 12–3 Task Types Tab

Field	Description
Task Type	Choose the task type for the productivity type.
Task Type Description	Task type description is automatically populated for the task type selected.



12.5.1.1.4 Setting Up a Productivity Type's Equipment Types

A productivity type may be associated with an equipment type. When an equipment type uses an equipment and is associated with a productivity type, the SAM values defined for the equipment type are used to override the original SAM values defined for a productivity type.

To set up a productivity type's equipment types:

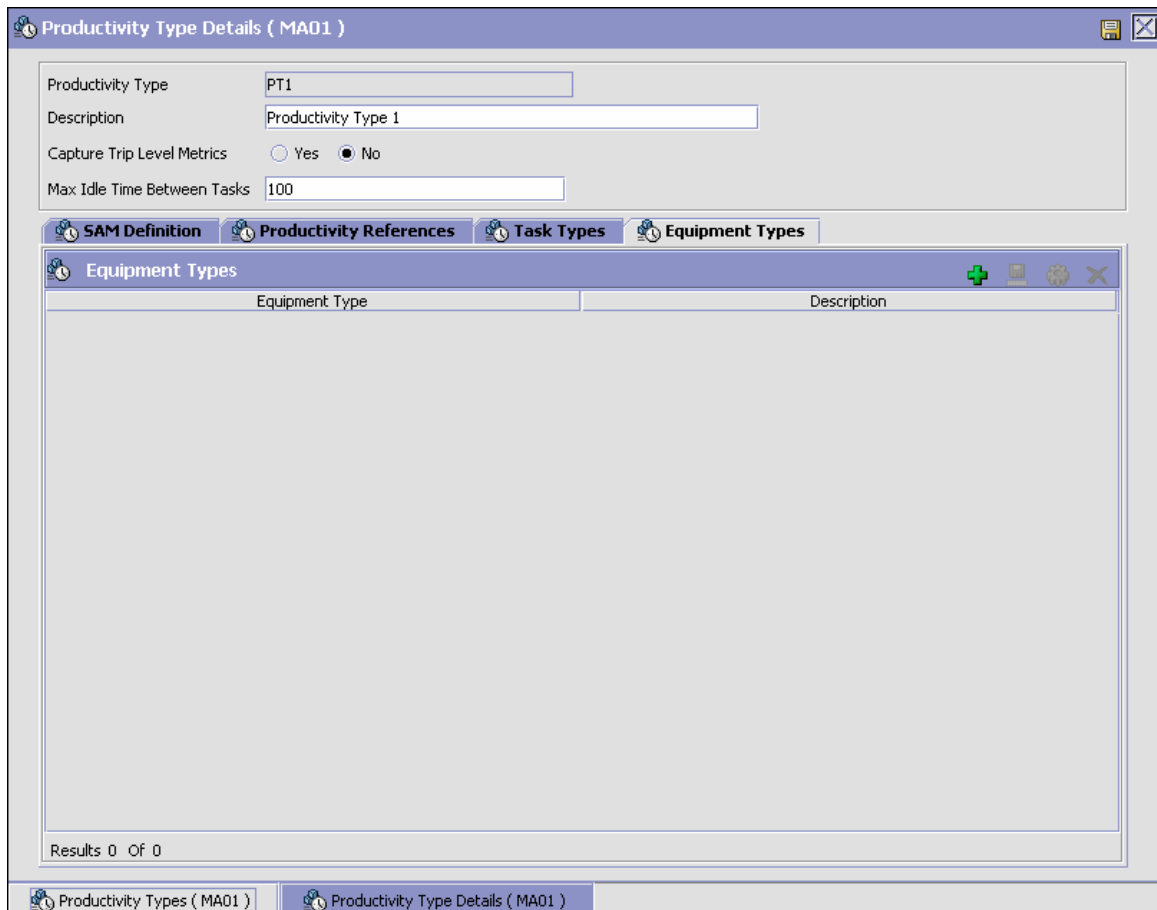
1. In the Productivity Type Details window, choose the Equipment Types tab. The Equipment Types window displays.



2. In the Equipment Types window, choose .
3. The SAM Definition For Equipment Type window displays.
4. Enter information in the applicable fields. Refer to [Table 12-4](#) for field value descriptions.
5. Choose .

SAM Definition For Equipment Type

Equipment Type: Productivity Type:

Description:

Capture Trip Level Metrics: Yes No

Max Idle Time Between Tasks:

SAM Definition

	Task Execution	Planning
SAM Per Productivity Batch	<input type="checkbox"/> <input type="text" value="0"/>	<input type="checkbox"/> <input type="text" value="0"/>
SAM Per Task	<input type="checkbox"/> <input type="text" value="0"/>	<input type="checkbox"/> <input type="text" value="0"/>
Product		
	Task Execution	Planning
SAM Per Item	<input type="checkbox"/> <input type="text" value="0"/>	<input type="checkbox"/> <input type="text" value="0"/>
SAM Per Case	<input type="checkbox"/> <input type="text" value="0"/>	<input type="checkbox"/> <input type="text" value="0"/>
SAM Per Unit Weight	<input type="checkbox"/> <input type="text" value="0"/>	<input type="checkbox"/> <input type="text" value="0"/>
SAM Per Unit	<input type="checkbox"/> <input type="text" value="0"/>	<input type="checkbox"/> <input type="text" value="0"/>
SAM Per Pallet	<input type="checkbox"/> <input type="text" value="0"/>	<input type="checkbox"/> <input type="text" value="0"/>
Location		
SAM Per Source Location	<input type="checkbox"/> <input type="text" value="0"/>	SAM Per Source Aisle <input type="checkbox"/> <input type="text" value="0"/>
SAM Per Target Location	<input type="checkbox"/> <input type="text" value="0"/>	SAM Per Target Aisle <input type="checkbox"/> <input type="text" value="0"/>
SAM Per Unit Horizontal Distance	<input type="checkbox"/> <input type="text" value="0"/>	SAM Per Source Level <input type="checkbox"/> <input type="text" value="0"/>
SAM Per Unit Vertical Distance	<input type="checkbox"/> <input type="text" value="0"/>	SAM Per Target Level <input type="checkbox"/> <input type="text" value="0"/>

Productivity Types (MA01) | Productivity Type Details (MA01) | **SAM Definition For Equipment Type**

Table 12–4 SAM Definition For Equipment Type

Fields	Description
Equipment Type	Select the equipment type from the drop-down list.
Productivity Type	Displays the productivity type associated with the selected equipment type.
Description	Displays the description of the productivity type.
Capture Trip Level Metrics	This is inherited from the previously configured trip level metrics as explained in Table 12–1, "SAM Definition Tab"
Max Idle Time Between Tasks	Displays the maximum idle time between tasks.
SAM Definition	
Task Execution	
SAM Per Productivity Batch	<p>Check this box to enter the SAM for each productivity batch (in minutes) for the task execution.</p> <p>If trip-level metrics are set to "Yes", this indicates the time credited to users for each system created batch or a trip.</p> <p>For warehouses that do not create batches and have the trip-level metrics set to "No", the time credit is considered for the entire day.</p>
SAM Per Task	<p>Check this box to enter the SAM for each task (in minutes) for task execution.</p> <p>This indicates the time credited to users for each task performed. Typically, either the SAM Per Productivity Batch or the SAM Per Task values are used to specify the SAM for a productivity type.</p>
Planning	
SAM Per Productivity Batch	<p>Check this box to enter the SAM for each productivity batch in minutes for task planning.</p> <p>If trip-level metrics are set to "Yes", this indicates the time credited to users for each system created batch or a trip.</p> <p>For warehouses that do not create batches and have the trip-level metrics set to "No", the time credit is considered for the entire day.</p>

Table 12–4 SAM Definition For Equipment Type

Fields	Description
SAM Per Task	<p>Check this box to enter the SAM for each task (in minutes) for task planning.</p> <p>Indicates the time credited to users for each task performed. Typically, either the SAM Per Productivity Batch or the SAM Per Task values are used to specify the SAM for a productivity type.</p>
Product	
Task Execution	
SAM Per Item	<p>Check this box to enter the SAM for each item (in minutes) for task execution.</p> <p>This indicates the time credited to users per item handled.</p>
SAM Per Case	<p>Check this box to enter the SAM for each case (in minutes) for task execution.</p> <p>This indicates the time credited to users per case handled.</p>
SAM Per Unit Weight	<p>Check this box to enter the SAM for each unit weight (in minutes) for task execution.</p> <p>This indicates the time credited to users per unit weight handled.</p>
SAM Per Unit	<p>Check this box to enter the SAM for each unit (in minutes) for task execution.</p> <p>This indicates the time credited to users per unit handled.</p>
SAM Per Pallet	<p>Check this box to enter the SAM for each pallet (in minutes) for task execution.</p> <p>This indicates the time credited to users per pallet handled.</p>
Planning	
SAM Per Item	<p>Check this box to enter the SAM for each item (in minutes) for task planning.</p> <p>This indicates the time credited to users per item handled.</p>

Table 12–4 SAM Definition For Equipment Type

Fields	Description
SAM Per Case	Check this box to enter the SAM for each case (in minutes) for task planning. This indicates the time credited to users per case handled.
SAM Per Unit Weight	Check this box to enter the SAM for each unit weight (in minutes) for task planning. This indicates the time credited to users per unit weight handled.
SAM Per Unit	Check this box to enter the SAM for each unit (in minutes) for task planning. This indicates the time credited to users per unit handled.
SAM Per Pallet	Check this box to enter the SAM for each pallet (in minutes) for task planning. This indicates the time credited to users per pallet handled.
Location	
SAM Per Source Location	Enter the SAM for each source location (in minutes). This indicates the time credited to users per source location visited.
SAM Per Source Aisle	Enter the SAM for each source aisle (in minutes). This indicates the time credited to users per source aisle visited.
SAM Per Target Location	Enter the SAM for each target location (in minutes). This indicates the time credited to users per target location visited.
SAM Per Target Aisle	Enter the SAM for each target aisle (in minutes). This indicates the time credited to users per target aisle visited.
SAM Per Unit Horizontal Distance	Enter the SAM for each unit horizontal distance (in minutes). This indicates the time credited to users per unit horizontal distance visited.



Table 12–4 SAM Definition For Equipment Type

Fields	Description
SAM Per Source Level	Enter the SAM for each source level (in minutes). This indicates the time credited to users per source level visited.
SAM Per Unit Vertical Distance	Enter the SAM for each unit vertical distance (in minutes). This indicates the time credited to users per unit vertical distance visited.
SAM Per Target Level	Enter the SAM for each target level (in minutes). This indicates the time credited to users per target level visited.

12.5.1.2 Modifying a Productivity Type

Once a Productivity Type has been created, it can be modified.

To modify a productivity type:

1. From the tree in the application rules side panel, choose Task Management > Productivity > Productivity Types. The Productivity Types window displays with the list of Productivity Types.
2. Choose the Productivity Type to be modified. Choose .
3. The Productivity Type Details window displays.
4. Enter information in the applicable fields.
5. Choose .

All modifications to the productivity type are applied to all future transactions.

For more information about modifying fields in the Productivity Type Details window, refer to [Section 12.5.1.1.1, "Setting Up a Productivity Type's SAM Definition"](#), [Section 12.5.1.1.2, "Setting Up a Productivity Type's Productivity References"](#), [Section 12.5.1.1.3, "Setting Up a Productivity Type's Task Types"](#), and [Setting Up a Productivity Type's Equipment Types](#).

12.5.1.3 Deleting a Productivity Type

To delete a productivity type:

1. From the tree in the application rules side panel, choose Task Management > Productivity > Productivity Types. The Productivity Types window displays with the list of Productivity Types.
2. Choose the Productivity Type to be deleted.
3. Choose .

A productivity type cannot be deleted if there are productivity records associated to it. In such situations, it is recommended that the associated task types be removed.

12.5.2 Setting Up Purge Criteria

Transactional data collected by the Sterling WMS during execution are periodically removed from the "live" transactional tables. It is common to retain order related information for extended periods of time. There are history tables provided for relevant transactional tables to move data from the day-to-day "live" tables to a historical table.

Purge is the process by which old data is removed from the system database. A purge minimizes the number of unused database records to increase search efficiency and reduces the size of the required physical disk.

12.5.2.1 Setting Up Purge Criteria

To set up purge criteria:



1. From the tree in the application rules side panel, choose Task Management > Productivity > Productivity Types > Purge Criteria. The Purge Criteria List window displays.
2. In the Purge Criteria List window, choose . The Purge Criteria Details pop-up window displays.
3. Enter information in the applicable fields. Refer [Table 12–11](#) for field value descriptions.
4. Choose .

Table 12–5 *Purge Criteria Details Pop-up Window*

Field	Description
Purge Code	Identifies a purge program. This is a system defined code.
Description	Description of the purge.
Rollback Segment	Defines the rollback segment that should be explicitly used for the purge transaction qualified by the purge code. This is useful when there are huge logical data sets that have to be purged. This is optional and used for order related purges.
Retention Days	Enter the number of days of data to be retained in the database (going backwards from the time the program runs). Make sure that your table size takes into account the number of retention days entered here.

Table 12–5 Purge Criteria Details Pop-up Window

Field	Description
Write To Log File	Check this box if you want purged data written to a log. The log can be backed up and used as a journal at a later date.
Log File Name	<p>Enter a log file name. This is applicable only if 'Write To Log File' is checked. This file consists records of the specific table that is purged.</p> <p>The log file is created in the directory specified in the <code>yfs.purge.path</code> property. If this is not passed, it defaults to the value specified in the <code>yfs.properties</code> file. If a variable is introduced, then the <code>yfs.purge.path</code> is ignored. To modify this property, add an entry for it in the <code><INSTALL_DIR>/properties/customer_overrides.properties</code> file. For additional information about modifying properties and the <code>customer_overrides.properties</code> file, see the <i>Selling and Fulfillment Foundation: Properties Guide</i>.</p> <p>For information about file name limitations relating to internationalization, see the <i>Selling and Fulfillment Foundation: Localization Guide</i>.</p>

12.6 Defining Execution Exceptions

Exceptions that occur during the execution of tasks in the warehouse are categorized into exception codes. The codes are classified into three broad categories:

- Pick
- Deposit
- Skip

The exception code allows evaluation at the ship node level for efficiency and accuracy.

Use Execution Exceptions for:

- [Creating a Pick Execution Exception](#)
- [Modifying a Pick Execution Exception](#)
- [Deleting a Pick Execution Exception](#)

- [Creating a Deposit Execution Exception](#)
- [Modifying a Deposit Execution Exception](#)
- [Deleting a Deposit Execution Exception](#)
- [Creating a Skip Execution Exception](#)
- [Modifying a Skip Execution Exception](#)
- [Deleting a Skip Execution Exception](#)

12.6.1 Creating a Pick Execution Exception

Exceptions that occur during the activity of picking a product for execution, being the first step of putaway, retrieval, or outbound pick process are defined here.

For example, a location being empty (or inventory shortage), when retrieval is requested from it.

To create a pick execution exception:

1. From the tree in the application rules side panel, choose Task Management > Execution Exceptions. The Execution Exception window displays.
2. Choose the Pick tab. The Pick tab window displays.

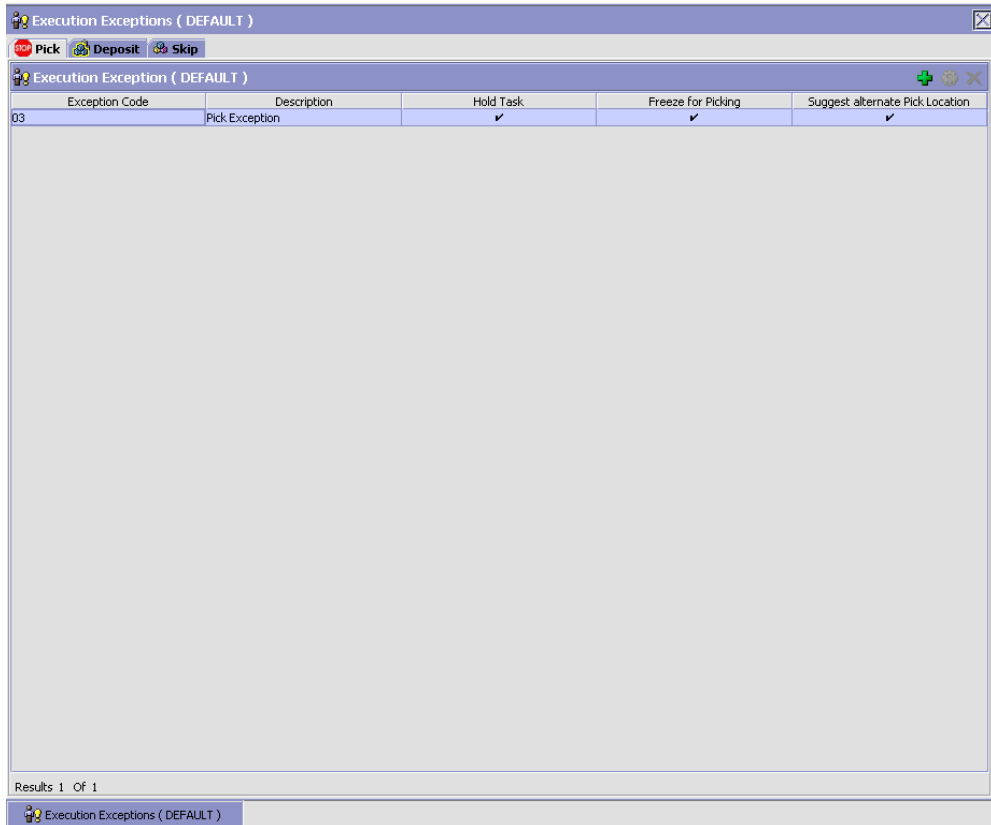



3. In the Pick tab window, choose . The Execution Exception Details window displays.
4. Enter information in the applicable fields. Refer [Table 12–6](#) for field value descriptions.
5. Choose .

Table 12–6 Execution Exception Details Window

Field	Description
Exception Code	Enter the name of the exception code.
Description	Enter a description for the exception code.
Exception Type	This is automatically populated by the system as "PICK".
Service Name	Enter service name for the execution. The service name indicates a service created using the Service Definition Framework. These services are used to incorporate enterprise specific business logic.
Inventory status for unavailable quantity	Choose the inventory status for unavailable quantity during pick due to this exception. The inventory status of the inventory in exception is automatically changed to this inventory status.
Hold Task	Select if the task being currently run is put on hold due to this exception.
Freeze for picking	Select if the location is frozen for further pick and retrieval transactions due to this exception.
Suggested alternate Pick location	Select if an alternate may be suggested by the system automatically for this exception.
Freeze for putaway	This option is not relevant for pick execution and is grayed out.



Table 12–6 Execution Exception Details Window

Field	Description
Suggested alternate Deposit location	This option is not relevant for pick execution and is grayed out.
Mark target as full	This option is not relevant for pick execution and is grayed out.
Unassign User	This option is not relevant for pick execution and is grayed out.
Allow partial deposit of Inventory	Select this option to allow depositing a portion of the picked inventory.

12.6.2 Modifying a Pick Execution Exception

Once a Pick Execution Exception has been created, it can be modified.

To modify a pick execution exception:

1. From the tree in the application rules side panel, choose Task Management > Execution Exceptions. The Execution Exception window displays.
2. Choose the Pick tab. The Pick tab window displays with the list of Execution Exceptions.
3. Choose the Execution Exception to be modified.
4. Choose . The Execution Exception Details window displays.
5. Enter information in the applicable fields. Refer [Table 12–6](#) for field value descriptions.
6. Choose .

12.6.3 Deleting a Pick Execution Exception

To delete a pick execution exception:

1. From the tree in the application rules side panel, choose Task Management > Execution Exceptions. The Execution Exception window displays.
2. Choose the Pick tab. The Pick tab window displays with the list of Execution Exceptions.

3. Choose the Execution Exception to be deleted.
4. Choose .

12.6.4 Creating a Deposit Execution Exception

Exceptions that occur during the activity of depositing product after pick is completed during putaway, retrieval, or outbound pick process are defined here.

For example, exception recorded when the location to deposit is already full.

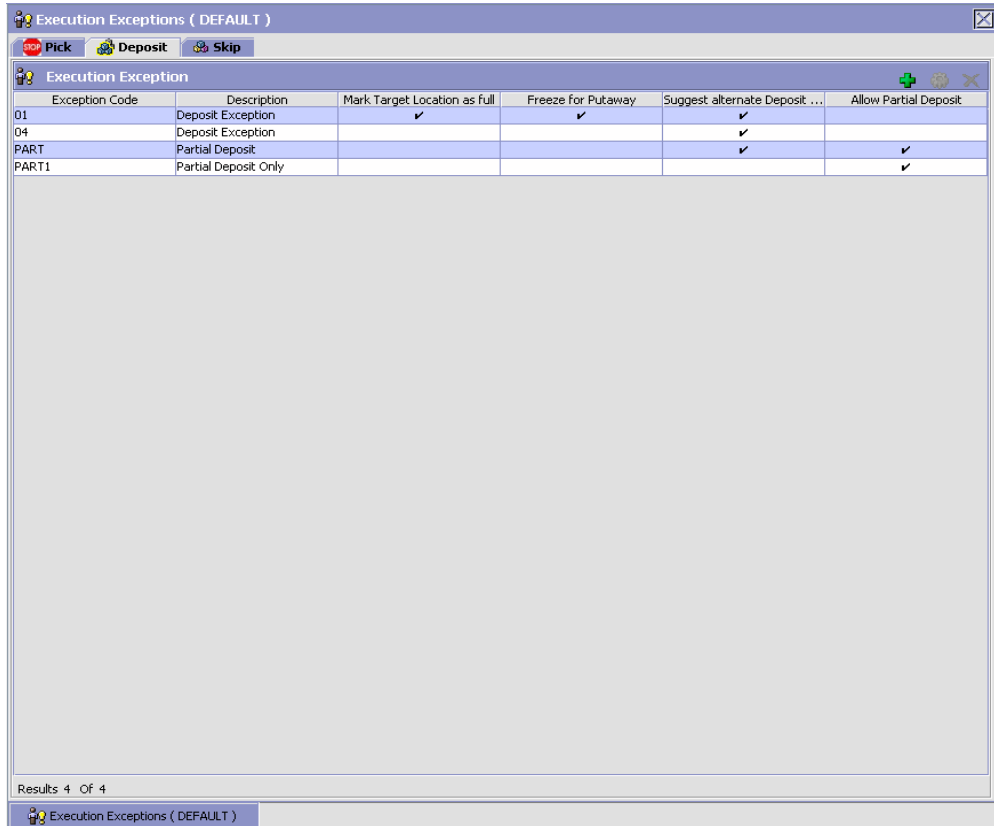

To create a deposit execution exception:

1. From the tree in the application rules side panel, choose Task Management > Execution Exceptions. The Execution Exception window displays.
2. Choose the Deposit tab. The Deposit tab window displays.



Exception Code	Description	Mark Target Location as full	Freeze for Putaway	Suggest alternate Deposit ...	Allow Partial Deposit
01	Deposit Exception	✓	✓	✓	
04	Deposit Exception			✓	
PART	Partial Deposit			✓	✓
PART1	Partial Deposit Only				✓

Results: 4 Of 4

3. In the Deposit tab window, choose . The Execution Exception Details window displays.
4. Enter information in the applicable fields. Refer [Table 12-7](#) for field value descriptions.
5. Choose .

Execution Exception Code Details

Exception Code: Description:

Exception Type: Service Name: 

Inventory status for unavailable quantity: Check Digit:

Hold Task Freeze On Variance
 Suggest alternate Pick location Freeze for Putaway
 Suggest alternate Deposit Location Mark Target Location as full
 Suggest location from the same target zone Allow partial deposit of Inventory
 Suggest location based on putaway preferences
 Unassign User

Table 12–7 Execution Exception Details Window

Field	Description
Exception Code	Enter the name of the exception code.
Description	Enter a description for the exception code.
Exception Type	This is automatically populated by the system as "DEPOSIT".
Service Name	Enter service name for the execution. The service name indicates a service created using the Service Definition Framework. These services are used to incorporate enterprise specific business logic.
Inventory status for unavailable quantity	This option is not relevant for deposit execution and is grayed out.
Hold Task	This option is not relevant for deposit execution and is grayed out.
Freeze for Picking	This option is not relevant for deposit execution and is grayed out.
Suggest alternate Pick location	This option is not relevant for deposit execution and is grayed out.
Freeze for Putaway	Select if the location is frozen for further putaway transactions due to this exception.

Table 12–7 Execution Exception Details Window

Field	Description
Suggest alternate Deposit Location	<p>Select this check box if an alternative location will be automatically suggested by the system for this exception. If this check box is selected, the following options are enabled. Based on your requirement, select one of the following options:</p> <ul style="list-style-type: none"> • Suggest location from the same target zone - Select this option if an alternative deposit location must be suggested from the same target zone. • Suggest location based on putaway preferences - Select this option if an alternative deposit location must be suggested from any zone based on the putaway preferences.
Mark Target Location as full	<p>Select if the location does not have any more capacity. This indicates the capacity of the location on the system differs from the physical product in the location.</p>
Unassign User	<p>This option is not relevant for deposit execution and is grayed out.</p>
Allow partial deposit of Inventory	<p>Select this option to allow depositing a portion of the picked inventory.</p>



Note: While creating a deposit execution exception, in addition to checking 'Suggest alternate Deposit location', it is required to check either 'Freeze for Putaway' or 'Mark Target Location as full' field.

This ensures that an alternate deposit location is suggested on exception, and prevents a location with exception from being suggested for deposit.

12.6.5 Modifying a Deposit Execution Exception

Once a Deposit Execution Exception has been created, it can be modified.

To modify a deposit execution exception:

1. From the tree in the application rules side panel, choose Task Management > Execution Exceptions. The Execution Exception window displays.
2. Choose the Deposit tab. The Deposit tab window displays with the list of Execution Exceptions.
3. Choose the Execution Exception to be modified.
4. Choose . The Execution Exception Details window displays.
5. Enter information in the applicable fields. Refer [Table 12–7](#) for field value descriptions.
6. Choose .

12.6.6 Deleting a Deposit Execution Exception

To delete a deposit execution exception:

1. From the tree in the application rules side panel, choose Task Management > Execution Exceptions. The Execution Exception window displays.
2. Choose the Deposit tab. The Deposit tab window displays with the list of Execution Exceptions.
3. Choose the Execution Exception to be deleted.
4. Choose .

12.6.7 Creating a Skip Execution Exception

The exceptions that are recorded when a user skips a task that is suggested, are recorded here.

To create a skip execution exception:

1. From the tree in the application rules side panel, choose Task Management > Execution Exceptions. The Execution Exception window displays.
2. Choose the Skip tab. The Skip tab window displays.

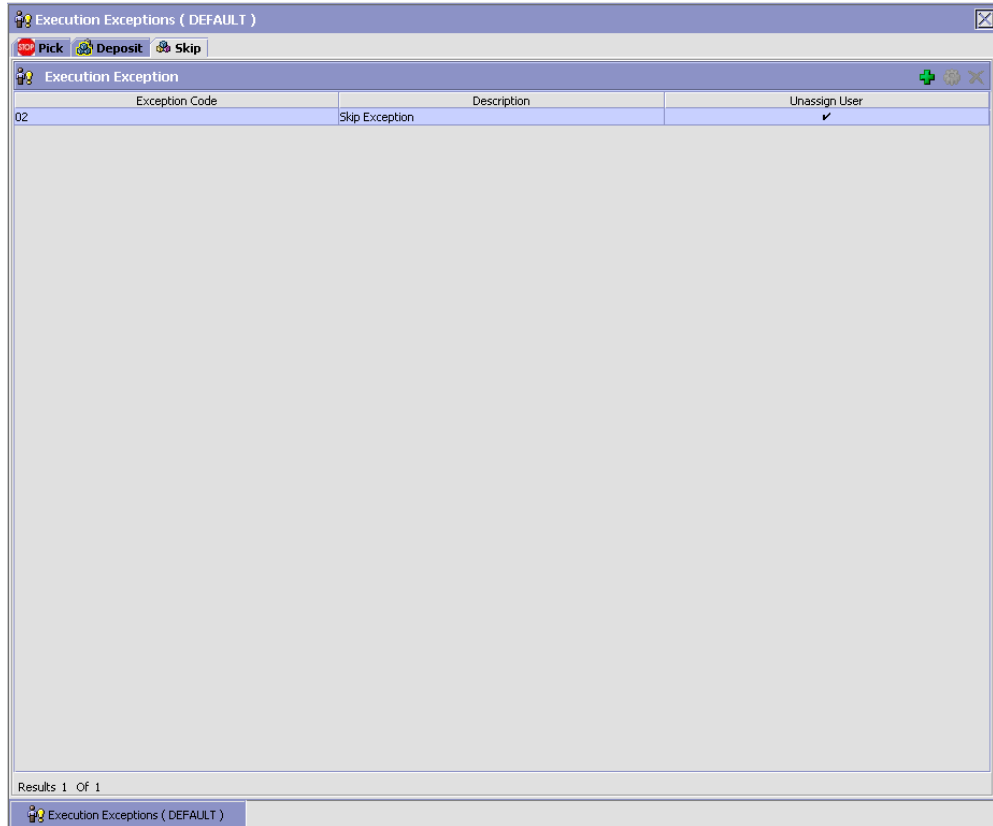



3. In the Skip tab window, choose . The Execution Exception Details window displays.
4. Enter information in the applicable fields. Refer [Table 12–8](#) for field value descriptions.
5. Choose .

Table 12–8 Execution Exception Details Window

Field	Description
Exception Code	Enter the name of the exception code.
Description	Enter a description for the exception code.
Exception Type	This is automatically populated by the system as "SKIP".
Service Name	Enter service name for the execution. The service name indicates a service created using the Service Definition Framework. These services are used to incorporate enterprise specific business logic.
Inventory status for unavailable quantity	This option is not relevant for skip execution and is grayed out.
Hold Task	This option is not relevant for skip execution and is grayed out.
Freeze source for move out	This option is not relevant for skip execution and is grayed out.
Suggested alternate Pick location	This option is not relevant for skip execution and is grayed out.
Freeze source for move in	This option is not relevant for skip execution and is grayed out.
Suggested alternate Deposit location	This option is not relevant for skip execution and is grayed out.



Table 12–8 Execution Exception Details Window

Field	Description
Mark target as full	This option is not relevant for skip execution and is grayed out.
Unassign User	Select if another user may run the task.
Allow partial deposit of Inventory	Select this option to allow depositing a portion of the picked inventory.

12.6.8 Modifying a Skip Execution Exception

Once a Skip Execution Exception has been created, it can be modified.

To modify a skip execution exception:

1. From the tree in the application rules side panel, choose Task Management > Execution Exceptions. The Execution Exception window displays.
2. Choose the Skip tab. The Skip tab window displays with the list of Execution Exceptions.
3. Choose the Execution Exception to be modified.
4. Choose . The Execution Exception Details window displays.
5. Enter information in the applicable fields. Refer [Table 12–8](#) for field value descriptions.
6. Choose .

12.6.9 Deleting a Skip Execution Exception

To delete a skip execution exception:

1. From the tree in the application rules side panel, choose Task Management > Execution Exceptions. The Execution Exception window displays.
2. Choose the Skip tab. The Skip tab window displays with the list of Execution Exceptions.
3. Choose the Execution Exception to be deleted.
4. Choose .

12.7 Defining Transaction Repository

A repository is a logical collection of entities that define the business process workflow. Transaction Repository includes the following entities:

- Transactions
- Conditions
- Actions
- Services

Selling and Fulfillment Foundation provides a base repository for each of the system-defined process types. Some of the entities within a repository are copied when creating a new document type. For more information about creating a new document type, see the *Selling and Fulfillment Foundation: Application Platform Configuration Guide*.

For more information about defining process type details, see *Selling and Fulfillment Foundation: Application Platform Configuration Guide*.

12.7.1 Transactions

Every process type has a set of base transactions defined for it. A transaction is a logical unit of work that is necessary for performing an activity within Selling and Fulfillment Foundation. Base transactions are predefined transactions that contain information about how the transaction behaves, such as how many copies of a transaction can be kept in a process type and whether or not it can have configurable base pick and drop statuses. Base transactions can be used to create new transactions. These transactions can be changed within the limits defined in the base transaction.

For more information about Transactions, see the *Selling and Fulfillment Foundation: Application Platform Configuration Guide*.

To view the transaction repository details for task management:

1. From the tree in the application rules side panel, choose Task Management > Transaction Repository. The Task Execution window displays.
2. In the Task Execution window, choose .
3. The Transactions tab window displays.

For more information about creating and modifying Transactions, see the *Selling and Fulfillment Foundation: Application Platform Configuration Guide*.

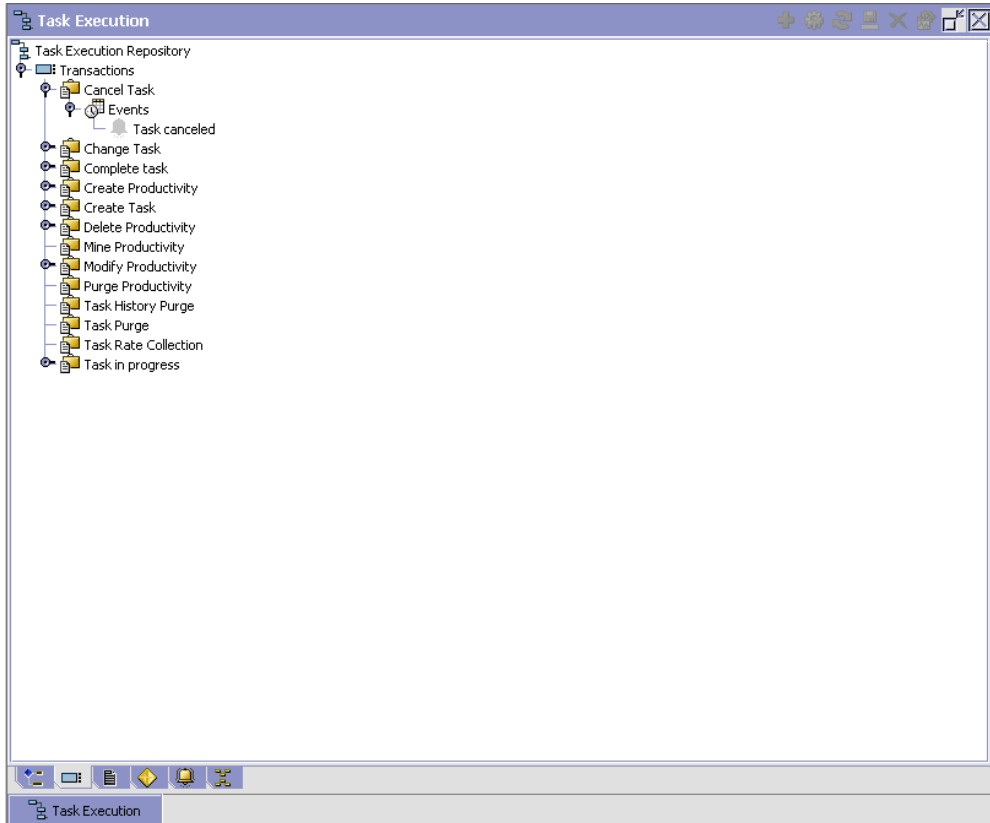

Table 12–9 *WMS Inventory - Transactions Tab Window*

Field	Description
Cancel Task	This transaction represents the cancellation of a task.
Change Task	This transaction represents the modification of a task.
Complete Task	This transaction represents the completion of a task.

Table 12–9 WMS Inventory - Transactions Tab Window

Field	Description
Create Productivity	This transaction represents the creation of a productivity.
Create Task	This transaction represents the creation of a task.
Delete Productivity	This transaction represents the deletion of a productivity.
Mine Productivity	This transaction represents mine productivity.
Modify Productivity	This transaction represents the modification of a productivity.
Purge Productivity	This transaction represents a productivity that may now be purged.
Task History Purge	This transaction represents a task history that may now be purged.
Task Purge	This transaction represents a task that may now be purged.
Task Rate Collection	This transaction represents the collection of a task rate.
Task in Progress	This transaction represents a task in progress.

12.7.2 Conditions

A **condition** matches document type attributes against decision points and routes the documents to different paths based on the specified attribute and value combinations. The document type attributes against which conditions can be created are predefined in Selling and Fulfillment Foundation. You can use these attributes in any combination or you can create conditions that run the appropriate application logic for specific circumstances.

For more information about Conditions, see the *Selling and Fulfillment Foundation: Application Platform Configuration Guide*.

To view the condition repository details for Task Management:

1. From the tree in the application rules side panel, choose Task Management > Transaction Repository. The Task Execution window displays.
2. In the Task Execution window, choose .

3. The Conditions tab window displays.

For more information about creating and modifying Conditions, see the *Selling and Fulfillment Foundation: Application Platform Configuration Guide*.

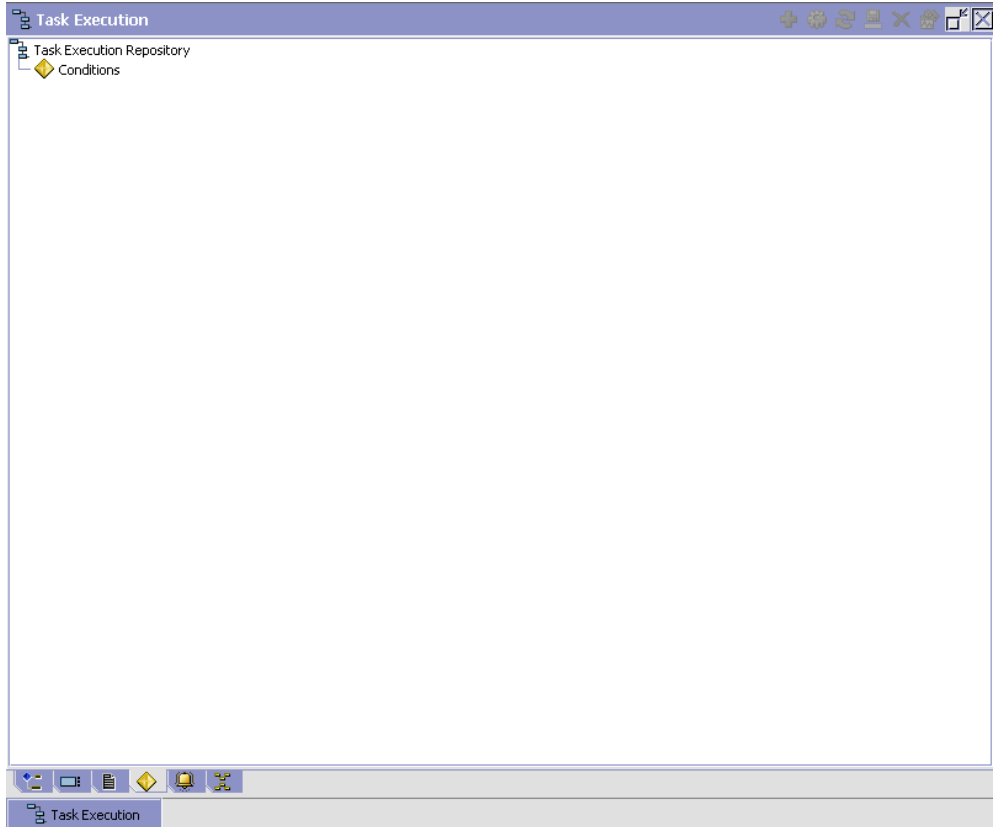

The Sterling WMS default transaction repository does not have any conditions specified.

12.7.3 Actions

An **action** is a process or program that is triggered by an event. These processes and programs send user alert notifications and automatically resolve issues.

For example, when a variance task is created (the event), you can set an action to send the enterprise user an e-mail.

For more information about Actions, see the *Selling and Fulfillment Foundation: Application Platform Configuration Guide*.

To view the action repository details for Task Management:

1. From the tree in the application rules side panel, choose Task Management > Transaction Repository. The Task Execution window displays.
2. In the Task Execution window, choose .
3. The Actions tab window displays.

For more information about creating and modifying Actions, see *Selling and Fulfillment Foundation: Application Platform Configuration Guide*.

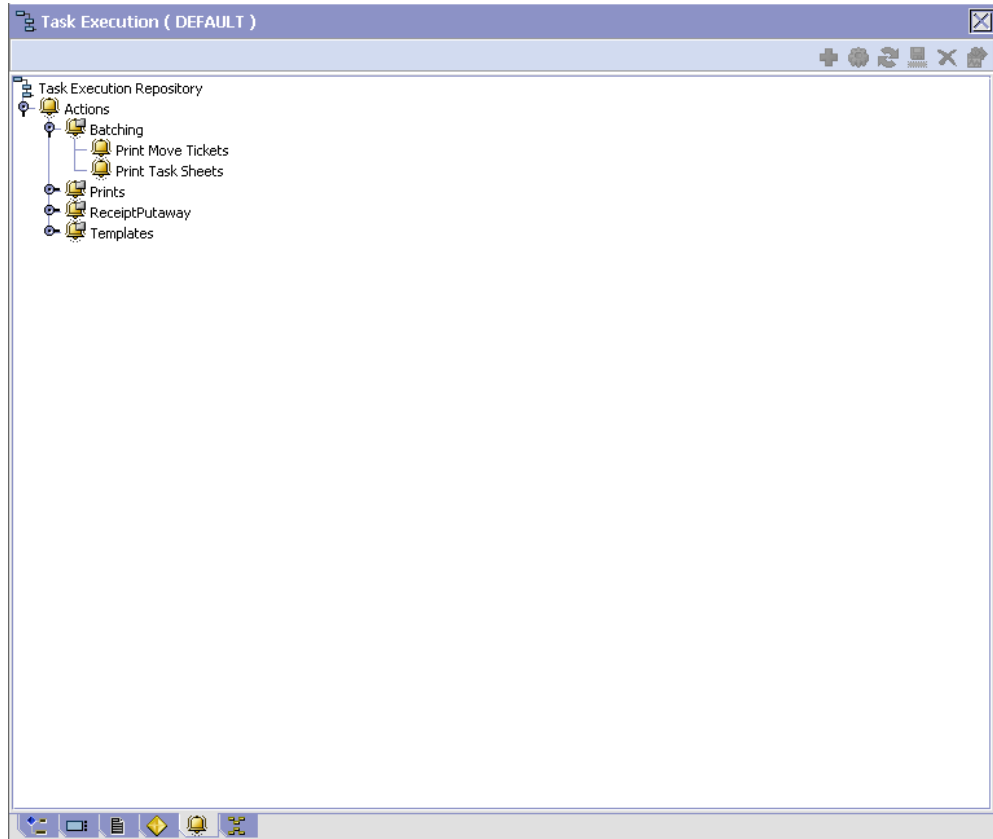

Table 12–10 WMS Inventory - Actions Tab Window

Field	Description
Batching	Default settings are provided for: Print Move Tickets – Invokes the batch printing service for printing the move tickets. Print Task Sheets – Invokes the batch print service for printing the task sheets.
ConfirmShipment	Default settings are provided for: ConfirmShipment – Invokes the confirmShipment flow to confirm the shipment.

Table 12–10 WMS Inventory - Actions Tab Window

Field	Description
DCS-Integration	Default settings are provided for: InventoryDownload – Invokes the YantraWMSInventoryDownloadService service to download the inventory information from Selling and Fulfillment Foundation to DCS. PODownload – Invokes the YantraWMSPODownloadService service to download the Purchase Order information from Selling and Fulfillment Foundation to DCS.
Exceptions	Default settings are provided for: ShortagesDetected – Invokes the LogWavePlaFailure exception service when shortage of inventory occurs during wave release.
InventorySynchronizat ion	Default settings are provided for: CollectInventoryMismatch – This service collects the inventory mismatch information between an external system and Selling and Fulfillment Foundation. This is typically caused when some inventory updates at a node or a warehouse are not reported to Selling and Fulfillment Foundation.
PickAndRetrieval	Default settings are provided for: ConfirmEmptyLocationAfterPick – Invokes the GenerateCountRequest flow which creates a count request.

Table 12–10 WMS Inventory - Actions Tab Window

Field	Description
Prints	<p>Default settings are provided for:</p> <p>PickList Print – Invokes the print service for printing the Pick List.</p> <p>LTL Manifest – Invokes the print service for printing the Less-than Truck Load Manifest.</p> <p>Print Load BOL – Invokes the print service for printing the Load Bill of Lading.</p> <p>Print PackList – Invokes the print service for printing the Pack List.</p> <p>Print Post Pick Container Labels – Invokes the print service for printing UCC-128 container labels for containers, when system defined packing process is used.</p> <p>Print Shipment BOL – Invokes the print service for printing the Shipment Bill of Lading.</p> <p>Print Shipping Label – Invokes the print service for printing the UCC-128 container labels.</p> <p>Print Wave – Invokes the Print service for printing a Wave.</p>
ReceiptPutaway	<p>Putaway products on receipt closure – Indicates the default action provided to automatically initiate putaway of purchase order receipts.</p>
RetrieveShipment	<p>Retrieve Requested Serial – This service invokes the retrieveShipment API to retrieve the requested serials to the specified location.</p>

Table 12–10 WMS Inventory - Actions Tab Window

Field	Description
Shipping	<p>Default settings are provided for:</p> <p>Load Left Origin – Invokes the doLoadLeftOriginUpdates service to mark that the load has left the origin.</p> <p>Stop Shipping – Invokes the RaiseStopShippingAlert service to raise an alert to stop the processing of the shipment.</p>
Templates	<p>Default settings are provided for:</p> <p>Log Exception – Logs the reasons due to which a count request could not be created for a Count Program.</p> <p>Publish Data – Sends data to external queue or internal tables.</p> <p>Raise Exception – Raises an alert using Event Management from the published information.</p> <p>Send Email – Raises an email action to create an email in the template format from the published information.</p> <p>Send Email-HTML format – Raises an email action to create an email in HTML format from the published information.</p>

12.7.4 Service Definitions

Service definitions are a representation of the logic that regulates document workflow services. The Service Builder is a graphical interface that enables you to create a graphical representation of these *services*.

For more information about Service Definitions, see the *Selling and Fulfillment Foundation: Application Platform Configuration Guide*.

To view the service definition repository details for Task Management:

1. From the tree in the application rules side panel, choose Task Management > Transaction Repository. The Task Execution window displays.
2. In the Task Execution window, choose .
3. The Service Definitions tab window displays.

For more information about creating and modifying Service Definitions, see the *Selling and Fulfillment Foundation: Application Platform Configuration Guide*.

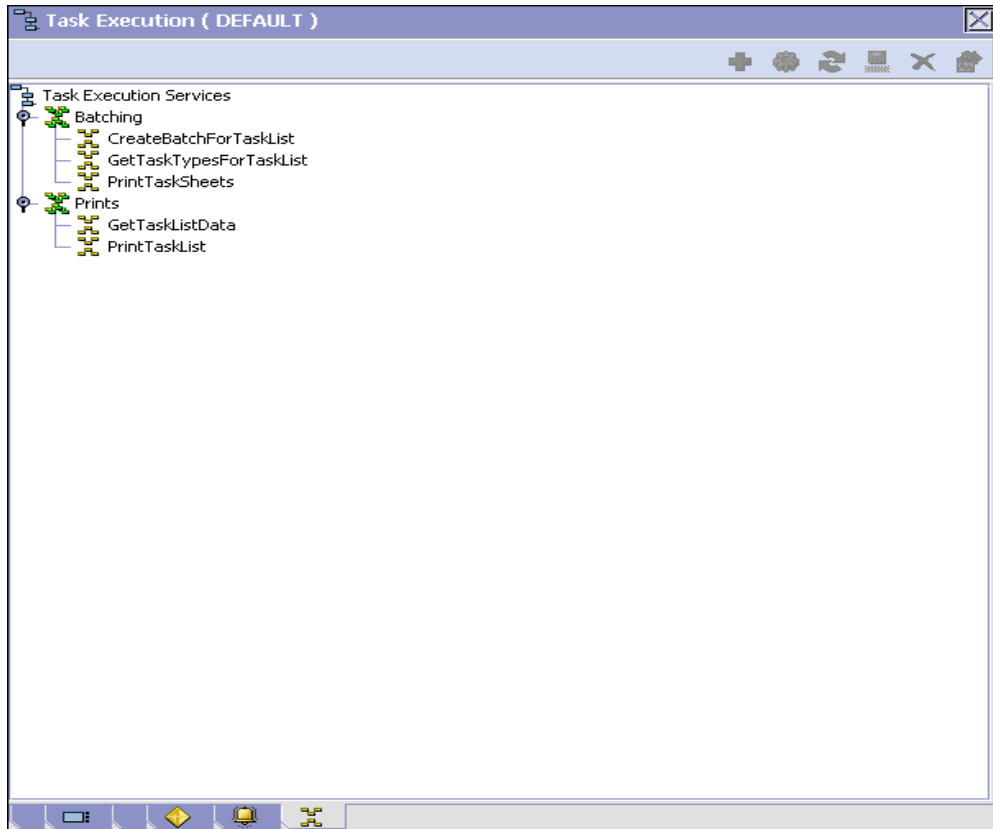

The Sterling WMS default transaction repository does not have any service definitions specified.

12.8 Defining Purge Criteria

Transactional data collected by the Sterling WMS during the execution are periodically removed from the 'live' transactional tables. It is common to retain order related information for extended periods of time.

There are history tables provided for relevant transactional tables to move data from the day-to-day 'live' tables to a historical table.

Purge is the process by which old data is removed from the system database. A purge minimizes the number of unused database records to increase search efficiency and reduces the size of the required physical disk.

12.8.1 Setting Up Purge Criteria

To set up purge criteria:

1. From the tree in the application rules side panel, choose Task Management > Purge Criteria. The Purge Criteria List window displays.

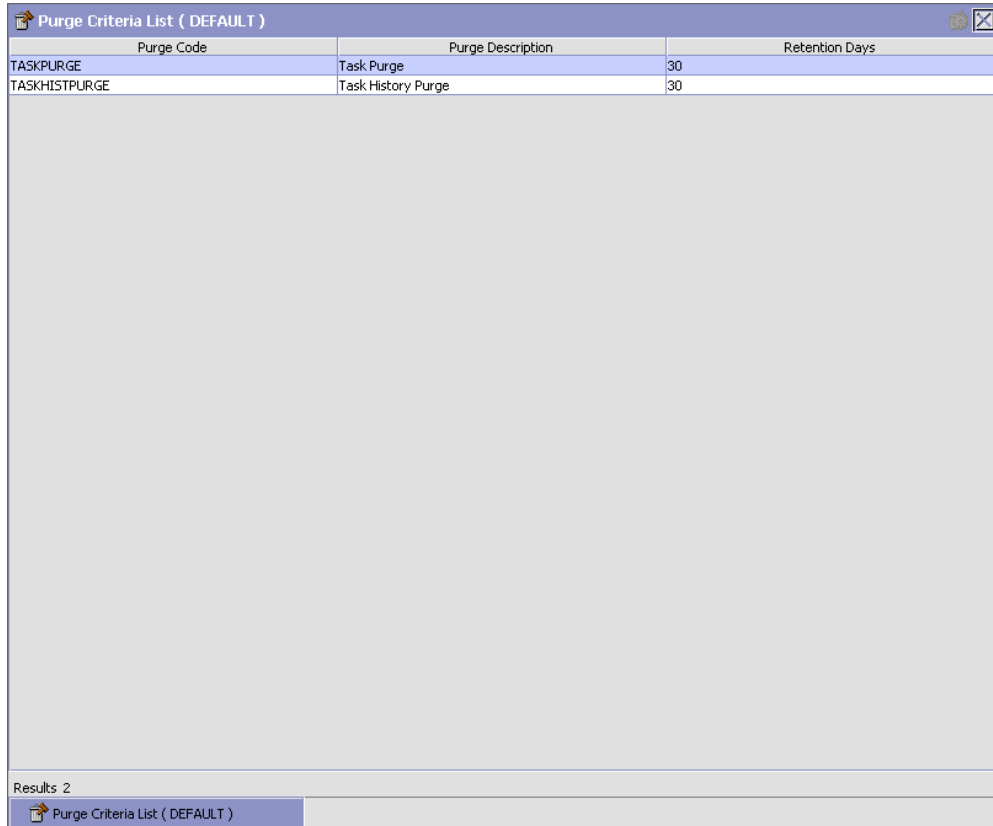

Purge Code	Purge Description	Retention Days
TASKPURGE	Task Purge	30
TASKHISTPURGE	Task History Purge	30

Results 2



2. In the Purge Criteria List window, choose Purge Criteria to be set up.
3. Choose . The Purge Criteria Details pop-up window displays.
4. Enter information in the applicable fields. Refer [Table 12–11](#) for field value descriptions.
5. Choose .

Table 12–11 Purge Criteria Details Pop-up Window

Field	Description
Purge Code	Identifies a purge program. This is a system defined code.
Description	Description of the purge.
Rollback Segment	Defines the rollback segment that should be explicitly used for the purge transaction qualified by the purge code. This is useful when there are huge logical data sets that have to be purged. This is optional and used for order related purges.
Retention Days	Enter the number of days of data to be retained in the database (going backwards from the time the program runs). Make sure that your table size takes into account the number of retention days entered here.



Table 12–11 Purge Criteria Details Pop-up Window

Field	Description
Write To Log File	Check this box if you want purged data written to a log. The log can be backed up and used as a journal at a later date.
Log File Name	<p>Enter a log file name. This is applicable only if 'Write To Log File' is checked. This file consists records of the specific table that is purged.</p> <p>The log file is created in the directory specified in the <code>yfs.purge.path</code> property. If this is not passed, it defaults to the value specified in the <code>yfs.properties</code> file. If a variable is introduced, then the <code>yfs.purge.path</code> is ignored. To modify this property, add an entry for it in the <code><INSTALL_DIR>/properties/customer_overrides.properties</code> file. For additional information about modifying properties and the <code>customer_overrides.properties</code> file, see the <i>Selling and Fulfillment Foundation: Properties Guide</i>.</p> <p>For information about file name limitations relating to internationalization, see the <i>Selling and Fulfillment Foundation: Localization Guide</i>.</p>

12.9 Defining Aisle-Level User Constraints

Aisle-level configuration allows a warehouse to specify the number of users allowed to work in a particular aisle or aisle section at a time. The application does not suggest a task for a new user if the number of users already working in an aisle matches the number of users allowed to work simultaneously in that aisle.

To define aisle-level user constraints:

1. From the tree in the application rules side panel, choose Task Management > Aisle User Constraints. The Aisle User Constraints window displays.
2. When you choose , the Aisle User Constraints pop-up window, it displays details pertaining to an aisle's user.
3. When you choose , the Aisle User Constraints pop-up window. Enter an aisle number and aisle section and specify the maximum

number of users who will be allowed to work simultaneously in that aisle.

4. Choose .

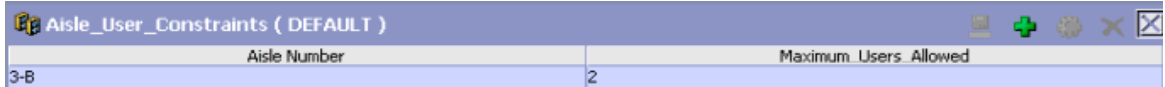

Aisle Number	Maximum Users Allowed
3-B	2

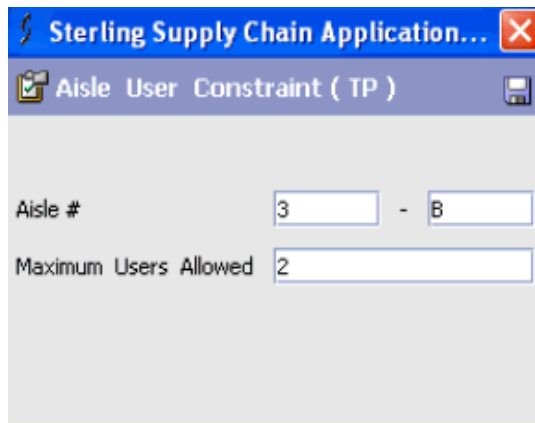

Aisle # -

Maximum Users Allowed

Table 12–12 Aisle User Constraints

Fields	Description
Aisle Number	Enter the aisle number.
Maximum Users Allowed	Enter the maximum number of users allowed to work simultaneously in an aisle.

Configuring Consigned Inventory

Consigned Inventory allows the vendor to own inventory for enterprises. The basic premise of Consigned Inventory is to delay the transfer of ownership and the related financial transactions until the last possible point in Selling and Fulfillment Foundation.

This reduces the cost of carrying the inventory and the lead time.

13.1 Defining Consumption Share

This section provides information about configuring the consumption share among the consumable inventory organizations.

13.1.1 Defining Percentage Share at the Item Classification Level for an Inventory Organization

Perform the following steps to define the percentage share at the item classification level for an inventory organization:

1. From the tree in the application rules side panel, choose Warehouse Management > Consigned Inventory. The Consumption Share window displays.
2. Select the Item Classification tab.
3. Enter the applicable criteria and choose . See [Table 13–1, "Item Classification Consumption Search Window"](#) for field value descriptions.

Consumption Share (SS-INV-ORG / TP)

Organization Code

Organization Name

Item Classification **Item**

Item Classification Consumption Search (SS-INV-ORG / TP)

Item Classification

Item Type Effective From Date

Item Classification Consumption List

Item Classification	Effective From Date

Results 0 of 0

Table 13–1 *Item Classification Consumption Search Window*

Field	Description
Organization Code	The organization code of the consuming inventory organization.
Organization Name	The name of the consuming inventory organization.
Item Type	The relevant item type associated to the classification values.
Effective From Date	The date from which the percentage share of the consumable inventory organizations is valid for this item classification.

4. Choose  to create a new Item Classification Consumption, by entering the Item Type and Effective Date.

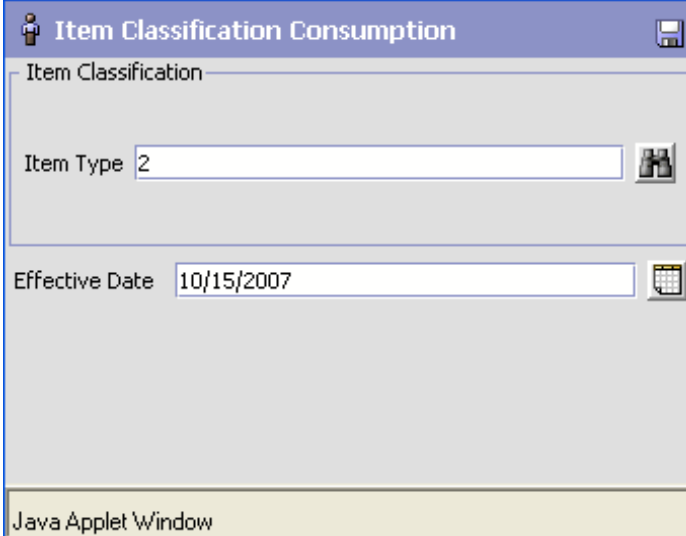



Item Classification Consumption

Item Classification

Item Type 2

Effective Date 10/15/2007

Java Applet Window

5. Choose .
6. Choose . The Item Classification Consumption Details window is displayed.
7. Enter information in the applicable fields. See [Table 13–2, "Item Classification Consumption Details Window"](#) for field value descriptions.

Consumable Inventory Organization	Percentage Share
V1-INV-ORG	50
V2-INV-ORG	50
*	

Results 2 of 2

Table 13–2 *Item Classification Consumption Details Window*

Field	Description
Consumable Inventory Organization	Inventory organization that owns inventory for the consuming inventory organization.
Percentage Share	Percentage share assigned to the inventory organization.

8. Choose .

13.1.2 Defining Percentage Share at the Item Level for an Inventory Organization

Perform the following steps to define the percentage share at the item level for an inventory organization:

1. From the tree in the application rules side panel, choose Warehouse Management > Consigned Inventory. The Consumption Share window displays.
2. In the Item tab of Consumption Share, enter the applicable criteria and choose . See [Table 13–3, "Item Consumption Search Window"](#) for field value descriptions.

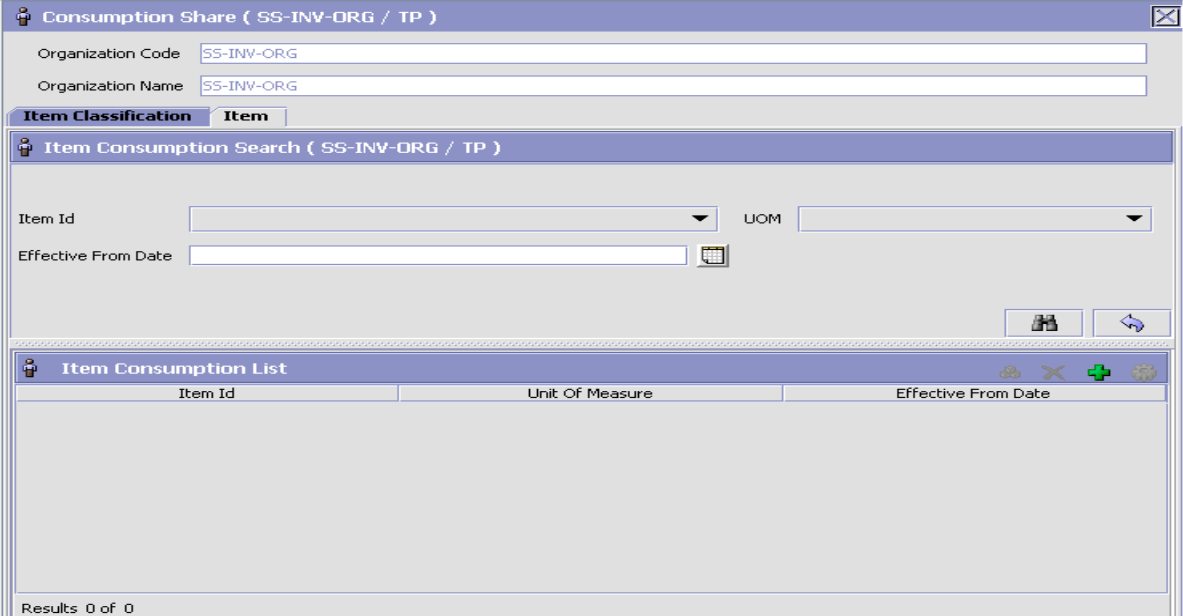

Consumption Share (SS-INV-ORG / TP)

Organization Code



Organization Name

Item Classification **Item**

Item Consumption Search (SS-INV-ORG / TP)

Item Id UOM

Effective From Date 

 

Item Consumption List



Item Id	Unit Of Measure	Effective From Date
Results 0 of 0		

Table 13–3 Item Consumption Search Window

Field	Description
Item ID	Item ID of the consuming inventory organization.
UOM	Unit of measure of the consuming inventory organization.
Effective From Date	The date from which the percentage share of the consumable inventory organizations is valid for this item.

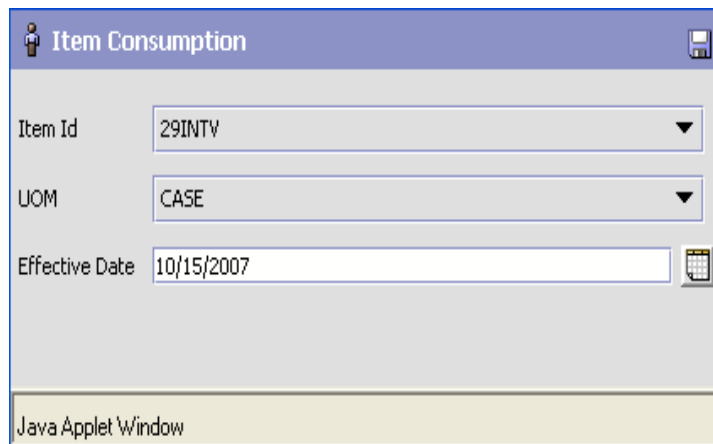
3. Choose  to create a new Item Consumption. See [Table 13–3](#) for field value descriptions.



4. Choose .
5. Choose . The Item Consumption Details window is displayed.
6. Enter information in the applicable fields. See [Table 13–4, "Item Consumption Details Window"](#) for field value descriptions.

Consumable Inventory Organization	Percentage Share
V1-INV-ORG	50
V2-INV-ORG	50

*
Results 2 of 2

Table 13–4 *Item Consumption Details Window*

Field	Description
Consumable Inventory Organization	The inventory organization that owns the inventory for the consuming inventory organization.
Percentage Share	Percentage share assigned to the inventory organization.

7. Choose .s

Configuring System Administration

System Administration configuration defines the common codes for, and set up the Devices, Bar Codes, and Prints.

Use System Administration for:

- [Defining Devices](#)
- [Defining Bar Codes](#)
- [Defining Prints](#)

14.1 Defining Devices

A warehouse consists of a number of hand-held and stationary devices. These devices have their unique definitions and sometimes are associated specifically to stations or equipment. Examples of devices include printer, RF scanner and weighing scale.

Each individual group of devices is represented as a device type and sub-type combination. A device and its unique communication requirements are represented when each device is configured.

Use Devices to set-up:

- [Defining a Device Type](#)
- [Defining a Device Sub Type](#)
- [Defining a Device](#)

14.1.1 Defining a Device Type

All the devices are grouped in the Sterling WMS to a Device Type. An individual unit is defined as a sub type for a device type.

For example, device types include RF scanners, printers, and weighing scale.

Use Device Type for:



- [Creating a Device Type](#)
- [Modifying a Device Type](#)
- [Deleting a Device Type](#)

14.1.1.1 Creating a Device Type

To create a device type:

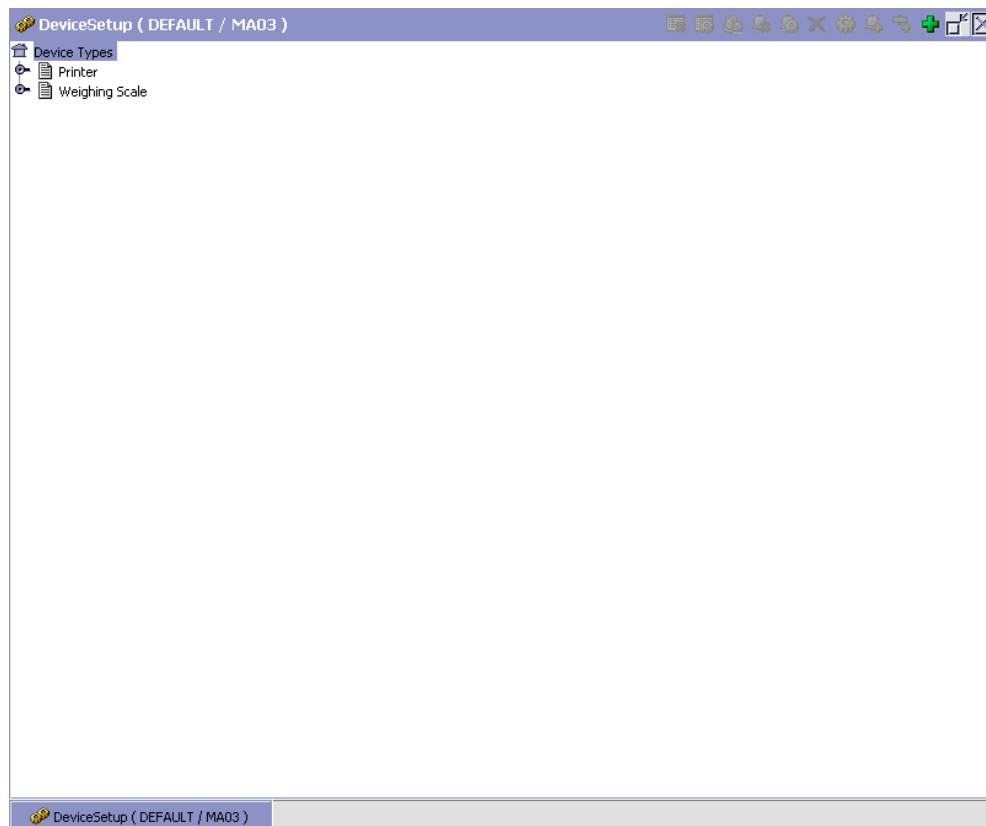
1. From the tree in the application rules side panel, choose System Administration > Devices. The Device Setup window displays.



2. In the Device Setup window, choose . The Device Type pop-up window displays.
3. Enter information in the applicable fields. Refer [Table 14–1](#) for field value descriptions.
4. Choose .

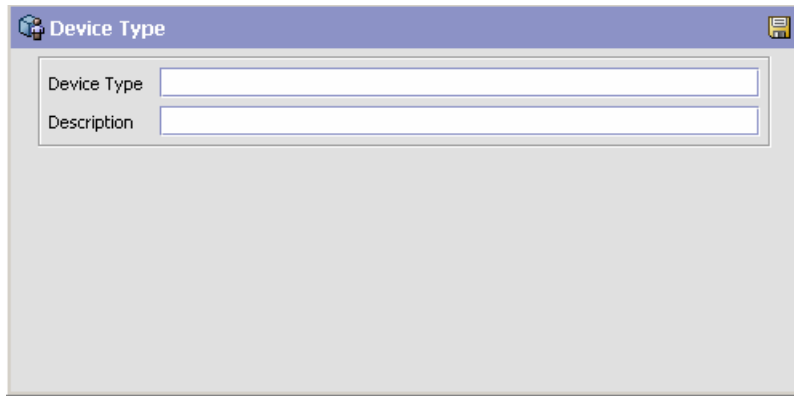



Table 14–1 *Device Type Pop-up Window*

Field	Description
Device Type	Enter a name for the device type. This helps in identifying the type of device. For example, device type may be weighing scale or printer.
Description	Enter a brief description for the device type.

14.1.1.2 Modifying a Device Type

Once a Device Type has been created, it can be modified.

To modify a device type:

1. From the tree in the application rules side panel, choose System Administration > Devices.
2. The Device Setup window displays with the list of Device Types.
3. Select the Device Type to be modified. Choose .
4. The Device Type pop-up window displays.
5. Enter information in the applicable fields. Refer [Table 14–1](#) for field value descriptions.
6. Choose .

14.1.1.3 Deleting a Device Type

To delete a device type:

1. From the tree in the application rules side panel, choose System Administration > Devices.
2. The Device Setup window displays with the list of Device Types.
3. Select the Device Type to be deleted. Choose .

14.1.2 Defining a Device Sub Type

A Device Sub Type categorizes a device type.

For example, a device type of Printers is further categorized or sub-typed into HP LaserJet 5P, and Zebra 170. Each individual sub-type allows for device configuration and its respective parameters.



Other examples include sub types of hand-held scanner models and equipment mounted models used under a device type of RF Scanners. For more information about setting up a device sub-type for a weighing scale, see [Appendix F, "Setting Up a Weighing Scale"](#).

Use Device Sub Type for:

- [Creating a Device Sub Type](#)
- [Modifying a Device Sub Type](#)
- [Deleting a Device Sub Type](#)

14.1.2.1 Creating a Device Sub Type

To create a device sub type:

1. From the tree in the application rules side panel, choose System Administration > Devices. The Device Setup window displays.
2. In the Device Setup window, select Device Type whose Device Sub Type is to be created.
3. Choose . The Device Sub Type pop-up window displays.
4. Enter information in the applicable fields. Refer [Table 14–2](#) for field value descriptions.
5. Choose .

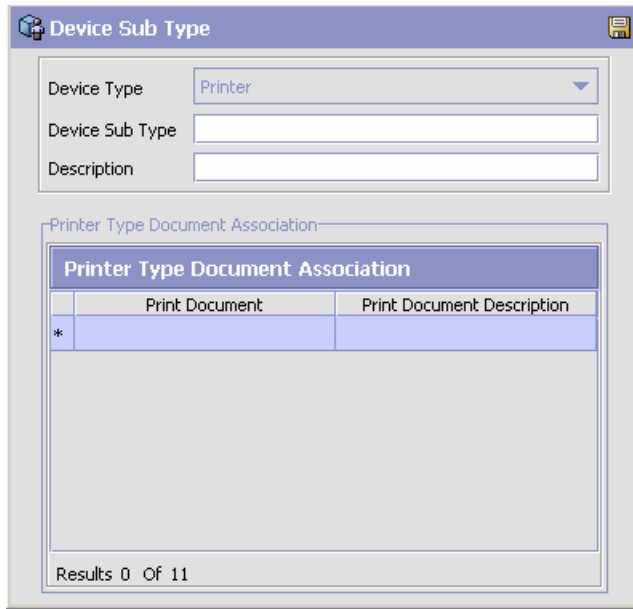

Table 14–2 *Device Sub Type Pop-up Window*



Field	Description
Device Type	Device Type indicates the device type for which the device sub type is being created. This is populated by the system, based on the selection of device type in the Device Setup window.
Device Sub Type	Enter a name for the device sub type.
Description	Enter a brief description for the device sub type.
Printer Type Document Association	
Note: This panel is available when the value of the Device Type is set to "Printer."	
Printer Type Document Association	Select which print documents you would like to associate with the selected printer.

Note: If you are configuring a new Device Sub Type for printing the FedEx Carrier Label, ensure that you map the value of the new Device Sub Type in the YCS Mapping table. Default mapping has been provided in YCS Mapping table for Device Sub Type such as Zebra and Eltron. For more information about the YCS Mapping table, see the *Parcel Carrier: Adapter Guide*.

14.1.2.2 Modifying a Device Sub Type

Once a Device Sub Type has been created, it can be modified.

To modify a device sub type:

1. From the tree in the application rules side panel, choose System Administration > Devices. The Device Setup window displays.
2. In the Device Setup window, select the Device Type whose Device Sub Type is to be modified. The list of Device Sub Type is now displays.
3. Select the Device Sub Type to be modified. Choose .
4. The Device Sub Type pop-up window displays.
5. Enter information in the applicable fields. Refer [Table 14–2](#) for field value descriptions.
6. Choose .

14.1.2.3 Deleting a Device Sub Type

To delete a device sub type:

1. From the tree in the application rules side panel, choose System Administration > Devices. The Device Setup window displays.
2. In the Device Setup window, select the Device Type whose Device Sub Type is to be deleted. The list of Device Sub Type is now displays.
3. Select the Device Sub Type to be deleted.
4. Choose .

14.1.3 Defining a Device

A device represents an actual device existing on the network, or directly connected to a station or equipment. All instances of a device type and sub-type combination require to be defined as devices.

For example, a warehouse that has five HP LaserJet 5P printers and four Zebra R140 printers has all the nine printers configured as devices.

One or more devices can be associated with equipment and/or station.

For more information about associating a device with equipment, see [Section 3.10.5, "Setting Up an Equipment Device Association"](#) on page 87.

For more information about associating a device with station, see [Section 3.11.5, "Setting Up a Station Device Association"](#) on page 99.

Use Device for:



- [Creating a Device](#)
- [Creating a New Device from a Device](#)
- [Modifying a Device](#)
- [Deleting a Device](#)

14.1.3.1 Creating a Device

To create a device:

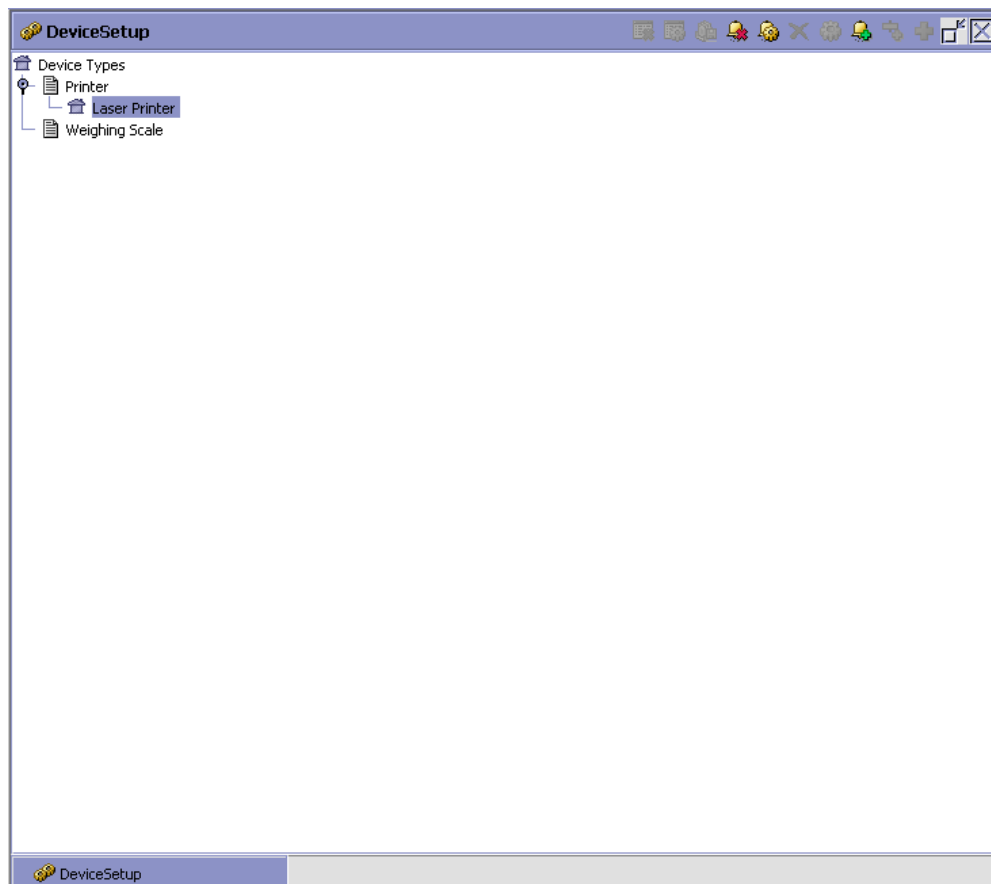
1. From the tree in the application rules side panel, choose System Administration > Devices. The Device Setup window displays.
2. In the Device Setup window, select the relevant Device Type and Device Sub Type whose Device is to be created.



3. Choose . The Device pop-up window displays.
4. Enter information in the applicable fields. Refer [Table 14–2](#) for field value descriptions.
5. Choose .

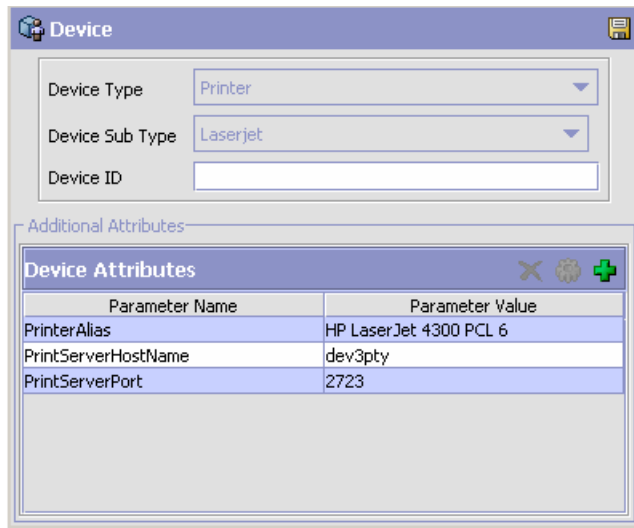

Table 14–3 Device Pop-up Window

Field	Description
Device Type	Device Type indicates the device type for which the device is being created. This is populated by the system, based on the selection of device type in the Device Setup window.
Device Sub Type	Device Sub Type indicates the device sub type for which the device is being created. This is populated by the system, based on the selection of device sub type in the Device Setup window.
Device ID	Enter the name for the device. This identifies the device throughout the system.
Device Attributes	This indicates the additional attributes of the device. For more information about setting up a device attribute, refer to Section 14.1.3.1.1, "Setting Up a Device Attribute" on page 966.

The Sterling WMS supplies a list of standard device type, sub type and individual devices that is supported. The definition of a new device type, sub type and resultant device requires the creation of the appropriate attributes that define the communication with the device.

The list of attributes that control communication to a printer are:

- **DropDirectory** - The directory where the print files are 'dropped'. The Software Print Server keeps polling this directory to pick up print requests.

When mentioning the directory structure you can use the full path name or replace the path name with a variable. For more information about this directory, including this variable, see the *Selling and Fulfillment Foundation: Application Platform Configuration Guide*.

Note: The DropDirectory attribute appears in the Applications Manager only if the `yfs.software.tcpip.sockets` property is set to `N` and the `<INSTALL_DIR>/properties/customer_overrides.properties` file. For additional information about overriding properties using the `customer_overrides.properties` file, see the *Selling and Fulfillment Foundation: Properties Guide*.

- **PrinterAlias** - The printer alias as configured in the Software printer setup.

Note: While setting up a Printer device in the Sterling WMS, ensure that the Printer Alias is exactly the same as that specified in the Software printer set-up.

In instances where a network printer is used, ensure that the Printer Alias on the Sterling WMS does NOT contain the prefix "\\". However, Software may require the printer to be defined by prefixing "\\".

- `PrinterServerHostName` - The host name for the Software Print Server. While IP Address may be sufficient, the use of host name is recommended for ease of maintenance.
- `PrintServerPort` - The port on which Software Print Server listens for print requests. By default, the print server port for Software Print Server is 2723.

Note: The `PrinterServerHostName` and `PrintServerPort` attributes appear in the Applications Manager only if the `yfs.loftware.tcpip.sockets` property is set to `Y` in the `<INSTALL_DIR>/properties/customer_ overrides.properties` file. For additional information about overriding properties using the `customer_ overrides.properties` file, see the *Selling and Fulfillment Foundation: Properties Guide*.

The list of attributes that control communication to a weighing scale are:

- `ClassName`
- `PortId`
- `BaudRate`
- `DataBits`
- `StopBits`
- `Parity`
- `FlowIn`
- `FlowOut`



Note: The `ClassName` for the Mettler Toledo Weighing Scale is `com.yantra.ycp.ui.io.YCPToledoPSImpl`. For specifications pertaining to the other attributes, refer the weighing scale user manual.

14.1.3.1.1 Setting Up a Device Attribute

Device attributes define the method of communication with the appropriate device. An HP LaserJet printer has a different parameter list in comparison to a weighing scale. Each individual brand of printer also has its own unique set of parameters and values.

For example, a weighing scale connected through a serial port has specific device attributes including stop bits, parity.

To set up a device attribute:

1. In Device Attributes panel of the Device pop-up window, choose .
2. The Criteria Parameter Details pop-up window displays.
3. Enter information in the applicable fields. Refer [Table 14–4](#) for field value descriptions.
4. Choose .

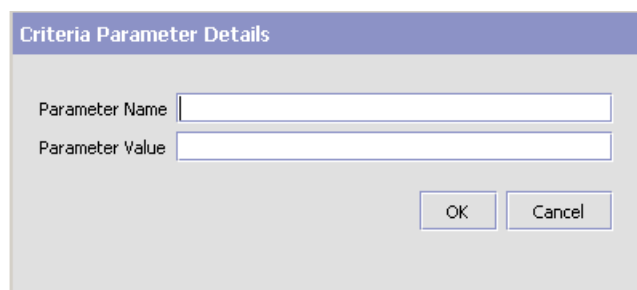



Table 14–4 *Criteria Parameter Details Pop-up Window*

Field	Description
Parameter Name	Enter the parameter name for the device attribute.
Parameter Value	Enter the parameter value for the device attribute.

14.1.3.2 Creating a New Device from a Device

To create a new device from a device:

1. From the tree in the application rules side panel, choose System Administration > Devices. The Device Setup window displays.

2. In the Device Setup window, select the relevant Device Type and Device Sub Type whose Device is to be copied.
3. The list of Devices displays. Select the Device to be copied to create a new device.
4. Choose . The Device pop-up window displays.
5. Enter information in the applicable fields. Refer to [Table 14–2](#) for field value descriptions.
6. Choose .

The Sterling WMS supplies a list of standard device type, sub type and individual devices that is supported. The definition of a new device type, sub type and resultant device requires the creation of the appropriate attributes that define the communication with the device.

The list of attributes that control communication to a printer are:

- DropDirectory - The directory where the print files are 'dropped'. The Loftware Print Server keeps polling this directory to pick up print requests.
When mentioning the directory structure you can use the full path name or replace the path name with a variable. For more information on including this variable, see the *Selling and Fulfillment Foundation: Application Platform Configuration Guide*.

-

Note: The DropDirectory attribute appears in the Applications Manager only if the `yfs.loftware.tcpip.sockets` property is set to `N` in the `<INSTALL_DIR>/properties/customer_overrides.properties` file. For additional information about overriding properties using the `customer_overrides.properties` file, see the *Selling and Fulfillment Foundation: Properties Guide*.

- PrinterAlias - The printer alias as configured in the Loftware printer setup.

Note: While setting up a Printer device in the Sterling WMS, ensure that the Printer Alias is exactly the same as that specified in the Loftware printer setup.

In instances where a network printer is used, ensure that the Printer Alias on the Sterling WMS does NOT contain the prefix "\\". However, Loftware may require the printer to be defined by prefixing "\\\".

- PrinterServerHostName - The host name for the Loftware Print Server. While IP Address may be sufficient, the use of host name is recommended for ease of maintenance.
- PrintServerPort - The port on which Loftware Print Server listens for print requests. By default, the print server port for Loftware Print Server is 2723.

Note: The PrinterServerHostName and PrintServerPort attributes appear in the Applications Manager only if the `yfs.ftware.tcpip.sockets` property is set to `Y` in the `<INSTALL_DIR>/properties/customer_ overrides.properties` file. For additional information about overriding properties using the `customer_ overrides.properties` file, see the *Selling and Fulfillment Foundation: Properties Guide*.

The list of attributes that control communication to a weighing scale are:

- ClassName
- PortId
- BaudRate
- DataBits
- StopBits
- Parity

- FlowIn
- FlowOut



For more information about creation of the appropriate attributes, see [Section 14.1.3.1.1, "Setting Up a Device Attribute"](#) on page 966.

Note: The ClassName for the Mettler Toledo Weighing Scale is `com.yantra.ycp.ui.io.YCPToledoPSImpl`. For specifications pertaining to the other attributes, please refer the weighing scale user manual.

14.1.3.3 Modifying a Device

Once a Device has been created, it can be modified.

To modify a device:

1. From the tree in the application rules side panel, choose System Administration > Devices. The Device Setup window displays.
2. In the Device Setup window, select the relevant Device Type and Device Sub Type whose Device is to be modified.
3. The list of Devices displays. Select the Device to be modified.
4. Choose . The Device pop-up window displays.
5. Enter information in the applicable fields. Refer to [Table 14–2](#) for field value descriptions.
6. Choose .

14.1.3.4 Deleting a Device

To delete a device:

1. From the tree in the application rules side panel, choose System Administration > Devices. The Device Setup window displays.
2. In the Device Setup window, select the relevant Device Type and Device Sub Type whose Device is to be deleted.
3. The list of Devices displays. Select the Device to be deleted.
4. Choose .

14.2 Defining Bar Codes

Bar codes are machine-readable symbols comprising black-and-white patterns of bars and stripes, or in some cases checkerboard-like grids. The different styles of bar codes are called symbologies. Code 39, UPC, ISBN and Code 128 are examples of different symbologies.

Bits of information are encoded within bar codes. This data is read by bar code scanners, and often used in conjunction with databases. Bar codes don't require human input. They can be read by automated machines, and are virtually error-free.

A UPC bar code is used in North America and Japan on retail items. EAN is used in Europe. ISBN bar codes are used for books. Code 39 is one of the most popular in areas of warehousing, for tracking purposes.

A bar code can be either single dimensional or 2 dimensional (2D). Parcel and truckload carriers use 2D symbologies like PDF417 code or MAXICODE, to represent a large amount of information.

The Sterling WMS supports all bar code symbologies through the use of RF scanners. The bar code data captured through the RF is compared to a data source in the WMS for validation. This is achieved in the Sterling WMS through the use of a bar code type and translation definition.

The subsequent sections describe the following tasks:

- [Defining Bar Code Types](#)
- [Defining Bar Code Translation](#)

14.2.1 Defining Bar Code Types

A bar code type is associated to a data field for validation and translation purposes. For example, a bar code type of Location is defined for locations.

A bar code type in the Sterling WMS has translation defined to data sources. These translations act as a validation for the data scanned or entered into the field.

For example, entry of 1-PR-A1-B1-L1 into the location field in a console or a RF, causes the translation and validations of data sources against the associated bar code type of Location. It results in the user being allowed to continue with the activity being performed or being informed of an invalid data entry.

The Sterling WMS provides a default set of bar code types. They are:

- Batch
- Cart Build
- Cart Location
- Case or Pallet
- Equipment Id
- Inventory Case
- Inventory Container
- Inventory Inquiry
- Inventory Pallet
- Item
- Item or Case
- Item or Inventory Case
- Item or Inventory Container
- Item or Shipping Container
- Item Tag
- Location
- Location Barcode
- Location Or Inventory Container
- Manifest Scan Initiation
- Adhoc Move Location
- Adhoc Move Pick
- New PrePrinted License Plate
- Outbound Container
- Pack Scan Initiation
- Pack SKU Initiation
- Pack Shipping Carton

- Pack Shipping Pallet
- Pallet Build
- Pick Initiation
- Pick Into Inventory Case
- Pick Into Inventory Pallet
- Serial Or Inventory Container
- Serial Scan
- Shipment
- Shipping Carton
- Shipping Container
- Shipping Or Inventory Container
- Shipping Pallet
- Task Reference
- Tote Id
- Work Order Confirmation
- Zone Id

The Sterling WMS allows the addition of new bar code types.

Use the bar code types setup to create and delete these custom bar code types.

The subsequent sections describe the following tasks:



- [Creating a Bar Code Type](#)
- [Deleting a Bar Code Type](#)

14.2.1.1 Creating a Bar Code Type

To create a bar code type:

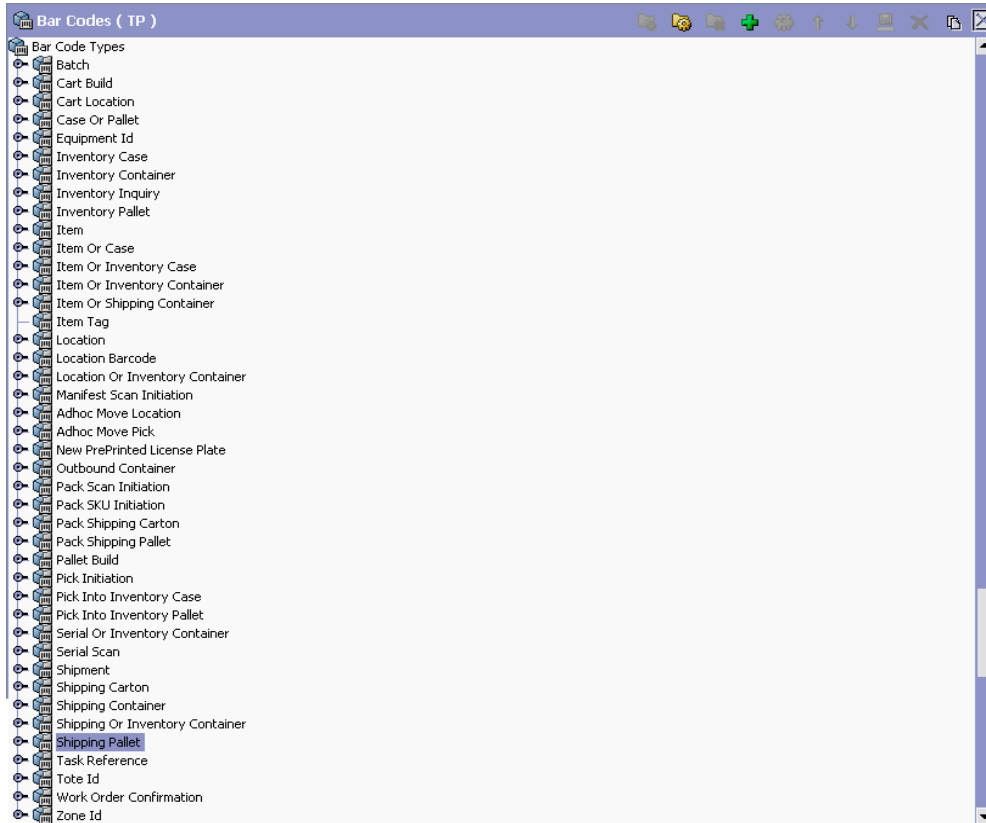
1. From the tree in the application rules side panel, choose System Administration > Bar Codes. The Bar Codes window displays with the existing Bar Code Types.



2. In the Bar Codes window, choose . The Bar Code Type pop-up window displays.
3. Enter information in the applicable fields. Refer [Table 14-5](#) for field value descriptions.
4. Choose .

The screenshot shows a dialog box titled "Bar Code Type". It contains two text input fields. The first field is labeled "Bar Code Type" and the second is labeled "Description".

Table 14–5 Bar Code Type Pop-up Window

Field	Description
Bar Code Type	Enter the name of the bar code type. This identifies the data type of the field being scanned in the user interface.
Description	Enter a brief description for the bar code type.

The new bar code type is associated directly to the data field through a dictionary.

14.2.1.2 Deleting a Bar Code Type

To delete a bar code type:

1. From the tree in the application rules side panel, choose System Administration > Bar Codes. The Bar Codes window displays with the existing Bar Code Types.
2. In the Bar Codes window, choose the Bar Code Type to be deleted.
3. Choose .

Default bar code types provided by the Sterling WMS cannot be deleted.

14.2.2 Defining Bar Code Translation

Bar Code Translation defines how a bar code is validated.



In addition to the default bar code validation sources provided in the Sterling WMS, additional validations can be created using the Service Definition Framework.

Use Bar Code Translations for:

- [Creating a New Bar Code Translation Association](#)
- [Creating a New Bar Code Translation Association from an Existing Bar Code Translation Association](#)
- [Modifying a Bar Code Translation Association](#)
- [Moving a Bar Code Translation Association](#)
- [Deleting a Bar Code Translation Association](#)

14.2.2.1 Creating a New Bar Code Translation Association

To create a new bar code translation association:

1. From the tree in the application rules side panel, choose System Administration > Bar Codes. The Bar Codes window displays with the existing Bar Code Types.
2. Choose the Bar Code Type for which you want to create a new Bar Code Translation.
3. Choose . The Bar Codes pop-up window displays.
4. Enter information in the applicable fields. Refer [Table 14–6](#) for field value descriptions.
5. Choose .

The screenshot shows a 'Bar Codes' configuration window. The 'Bar Code Type' is 'Location Barcode'. The 'Description' and 'Translation Sequence' fields are empty. The 'Variable Length Code' checkbox is unchecked. The 'Application Identifier' field is empty. The 'Fixed Length Bar Code Attributes' section has empty fields for 'Code Length', 'Start Position', and 'End Position'. The 'Bar Code Validation Source', 'Alias Type', and 'Validation Service' are all set to empty dropdown menus.

Table 14–6 Bar Codes Pop-up Window

Field	Description
Bar Code Type	<p>The bar code type is populated automatically based on the bar code type selected.</p> <p>Note: For a bar code translation to be successful for Barcode Type 'Item' and Barcode Translation Source 'UPCCaseCode', the packaging indicator for UOM 'Case' should be defined.</p> <p>In addition, an alias 'UPCCode' should be defined, and a value for this alias should be provided in 'Other Attributes' tab in 'Item Details' screen.</p>
Description	Enter a description for the bar code translation being created.

Table 14–6 Bar Codes Pop-up Window

Field	Description
Translation Sequence	<p>Enter a translation sequence number for the bar code translation.</p> <p>Translation sequence defines the sequence of translations of a bar code for a given bar code type.</p> <p>For example, a bar code data type 'Item ID' has Item, UPC, and UPC Case Code defined as translations, with sequence numbers 2, 3, and 1 respectively. The translation sequence now is to first validate against UPC Case Code, Item, and finally UPC.</p>
Variable Length Code	<p>Select if the bar code length is not fixed</p> <p>This indicates that the bar code length is fixed or not fixed. For example, while scanning an item bar code, the item ID could be of different lengths.</p>
Application Identifier	<p>Enter the application identifier.</p> <p>Application identifier is an alphanumeric string used to identify the data source. For example, in EIA compliance scanning for a pallet and carton labels, a prefix of K indicates a purchase order, P indicates an item, and Q indicates the quantity.</p> <p>The remainder of the bar code is used to validation against the source specified.</p>
Fixed Length Bar Code Attributes	
Code Length	<p>Enter the length of the bar code. Code length is the length of the entire stream that is scanned.</p> <p>Consider for example, a barcode "K6789". The length of this barcode is 5. This is because the Start Position is the one where the application identifier, "K", is located, and the End Position is the one where the last digit of the bar code, "9", is located.</p> <p>Code length is used to identify a bar code when validating scanned data. This is, however, not applicable for bar codes having variable lengths.</p>

Table 14–6 Bar Codes Pop-up Window

Field	Description
Start Position	<p>Enter the Start Position of the bar code. This is not applicable for bar codes having variable lengths. As mentioned earlier, the length that is to be configured is inclusive of the application identifier. For example, for barcode "K6789", the Start Position should be entered as 1 because "K" is the application identifier here, and the Start Position is considered to be the position in which "K" is placed.</p> <p>However, the application identifier is not displayed as part of the Case/Pallet ID. When taken in the context of this example, it means that on scanning "K6789", only "6789" is displayed.</p>
End Position	<p>Enter the End Position of the bar code. This defines the section of the bar code that is to be validated. For example, for barcode "K6789", the End Position should be entered as 5. This is because the last digit's position is considered to be the End Position.</p>
Bar Code Validation Source	<p>Choose the validation source for the bar code.</p> <p>Bar code validation source represents the data to be validated against. For example, a bar code representing a UPC Case code for an item has a data source of UPC Case Code. A location bar code being scanned has location id as its data source or a distinct location bar code.</p> <p>The list of values although extensive also provides for additional sources to be added through the use of 'External Source' data source. The externally translated source is implemented using the Service Definition Framework.</p>

Table 14–6 Bar Codes Pop-up Window

Field	Description
Alias Type	Choose the alias type for the bar code. This applies when the validation source is 'ItemAlias'. A list of defined item alias displays here from the catalog. An example is UPC Code.
Validation Service	Choose the validation service for external validation of the barcode. This applies when a validation source of 'External Source' is chosen. A list of service flows defined in Service Definition Framework are displayed. Note: This service needs to support the same input and output XML structure as the translateBarCode API. For more information, see the <i>Selling and Fulfillment Foundation: Javadocs</i> .

Note: For a bar code translation to be successful when 'UPCCaseCode' is selected as a validation source, an alias type called 'UPCCode' should exist in the corresponding catalog organizations of all enterprises participating with the node.



When validation source is 'Item,' the translation verifies if the item is allowed to transact against (status being 'published'). For more information on item status, refer to the *Catalog Management: Configuration Guide*.

For container SCM, the UCC128 validation source checks compliance against the industry standards.

14.2.2.2 Creating a New Bar Code Translation Association from an Existing Bar Code Translation Association

To create a new bar code translation association from an existing bar code translation association:



1. From the tree in the application rules side panel, choose System Administration > Bar Codes. The Bar Codes window displays with the existing Bar Code Types.
2. Choose the Bar Code Type you want to modify.

3. The list of Bar Code Translations belonging to the Bar Code Type selected displays.
4. Choose the Bar Code Translation to be copied. Choose .
5. The Bar Code Translations pop-up window displays.
6. Enter information in the applicable fields. Refer [Table 14–6](#) for field value descriptions.
7. Choose .

14.2.2.3 Modifying a Bar Code Translation Association

Once a Bar Code Translation Association has been created, it can be modified.

To modify a bar code translation association:



1. From the tree in the application rules side panel, choose System Administration > Bar Codes. The Bar Codes window displays with the existing Bar Code Types.
2. Choose the Bar Code Type you want to modify.
3. The list of Bar Code Translations belonging to the Bar Code Type selected displays.
4. Choose the Bar Code Translation to be modified. Choose .
5. The Bar Code Translations pop-up window displays.
6. Enter information in the applicable fields. Refer [Table 14–6](#) for field value descriptions.
7. Choose .

It is recommended that you use the "Save As"  feature to re-create new translations from the Sterling WMS-supplied translations, and modify these translations.

14.2.2.4 Moving a Bar Code Translation Association

A Bar Code Translation Association can be moved up or moved down depending on the requirements.

To move a bar code translation association:

1. From the tree in the application rules side panel, choose System Administration > Bar Codes. The Bar Codes window displays with the existing Bar Code Types.
2. Choose the Bar Code Type you want to modify.
3. The list of Bar Code Translations belonging to the Bar Code Type selected displays.
4. Choose the Bar Code Translation to be moved.
5. Choose  to move the Bar Code Translation up.
6. Choose  to move the Bar Code Translation down.

The translation sequence of each translation sequence is exchanged, when it is moved up and down. The relevance of the sequence is to order the validations in the best hit list for a warehouse.

For example, warehouses using UPC Codes primarily. A few items have the bar code being the Item ID. The sequencing for better performance would have first UPC Code being validated and then Item ID being validated.

14.2.2.5 Deleting a Bar Code Translation Association

To delete a bar code translation association:

1. From the tree in the application rules side panel, choose System Administration > Bar Codes. The Bar Codes window displays with the existing Bar Code Types.
2. Choose the Bar Code Type you want to modify.
3. The list of Bar Code Translations belonging to the Bar Code Type selected displays.
4. Choose the Bar Code Translation to be deleted.
5. Choose .

It is recommended that you do not delete the Sterling WMS supplied translations. The translations may instead be moved to the end of the translation sequence.

14.3 Defining Prints

The operation of a warehouse requires numerous documents, be it labels or reports, to be printed daily. The printing of the documents is either initiated by the occurrence of specific events or is requested ad-hoc by a user.

For example, carrier labels being printed at a manifest station after carton is scanned or a truck manifest (MBOL) being requested when a trailer loading is complete and truck is ready to close.

Documents are printed either individually or in a set or group. A document set consists of multiple documents that are related to individual activity that is performed.

For example, the release of a wave triggers print of wave summary report, carton content labels, batch sheets, and packing slips.

Examples of documents printed in a warehouse include packing lists, BOL, carrier labels, SKU labels, and UCC128 SCM labels.

The Sterling WMS provides standard documents that include:

- Batch Sheet for picking
- Cart Manifest for picking
- Packing Slip
- VICS Bill Of Lading (BOL)
- UCC-128 compliant 4x6 Shipping Labels including WALMART® compliance
- UPS Standard carrier labels
- Wave release prints document set consisting of one or more of the above prints

The Sterling WMS provides standard documents that include:

A specific document has a label format and printer sub type associated to it.

The association of a print document to the printer sub type (for example, packing slips on HP LaserJet printers) is done through Setting up a Printer Sub Type. For more information about setting up a Printer Sub Type, see [Section 14.1.2, "Defining a Device Sub Type"](#) on page 959.

The association of a specific printer to an equipment is done through Associate Devices to Equipment ID. For more information about associating a device with equipment, see [Section 3.10.5, "Setting Up an Equipment Device Association"](#) on page 87.

The association of a specific printer to a station is done through Associate Devices to Station ID. For more information about associating a device with station, see [Section 3.11.5, "Setting Up a Station Device Association"](#) on page 99.

The association of a document to a label format and name is done here.

Use Prints for:

- [Defining Print Documents](#)
- [Defining Label Formats](#)
- [Defining User Printer Preferences](#)
- [Defining Participant Print Preferences](#)

14.3.1 Defining Print Documents

A document is assigned a name and a corresponding label format here. the Sterling WMS provides a standard list of documents for the prints supported.

For example, VICS BOL is associated with the VICS BOL label format.

Print documents and label formats created are at the HUB level.

Use Print Documents set-up for:

- [Creating a Print Document](#)
- [Modifying a Print Document](#)
- [Deleting a Print Document](#)

14.3.1.1 Creating a Print Document

To create a print document:

1. From the tree in the application rules side panel, choose System Administration > Prints > Print Documents. The Print Documents window displays with the Sterling WMS default print documents.

2. Enter information in the applicable fields. Refer [Table 14–7](#) for field value descriptions.
3. Choose .

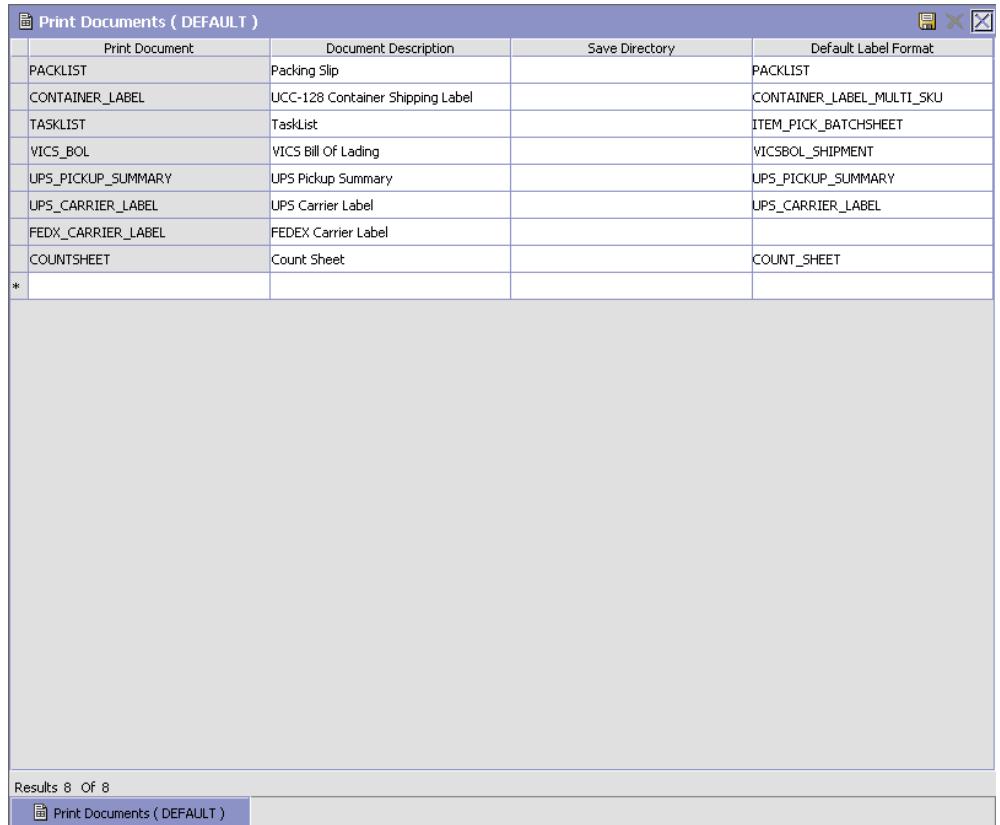

Print Document	Document Description	Save Directory	Default Label Format
PACKLIST	Packing Slip		PACKLIST
CONTAINER_LABEL	UCC-128 Container Shipping Label		CONTAINER_LABEL_MULTI_SKU
TASKLIST	TaskList		ITEM_PICK_BATCHSHEET
VICS_BOL	VICS Bill Of Lading		VICSBOL_SHIPMENT
UPS_PICKUP_SUMMARY	UPS Pickup Summary		UPS_PICKUP_SUMMARY
UPS_CARRIER_LABEL	UPS Carrier Label		UPS_CARRIER_LABEL
FEDX_CARRIER_LABEL	FEDEX Carrier Label		
COUNTSHEET	Count Sheet		COUNT_SHEET
*			

Results 8 Of 8

Print Documents (DEFAULT)

Table 14–7 Print Documents Window

Field	Description
Print Document	Enter name of the document to be printed.
Document Description	Enter a brief description of the print document.

Table 14–7 Print Documents Window

Field	Description
Save Directory	Enter the directory path where the print document is saved. This is used for documents that are pre-generated but printed on demand at a later time. Typical example is a packing list that is pre-generated, but printed when last carton is scanned.
Default Label Format	Choose the default label format for printing. This indicates the default label format for this document across all organizations. Label format is the name of the label design file (.LWL) created using Loftware Label Manager™.

14.3.1.2 Modifying a Print Document

Once a Print Document has been created, it can be modified.

To modify a print document:

1. From the tree in the application rules side panel, choose System Administration > Prints > Print Documents. The Print Documents window displays with a list of print documents.
2. Enter information in the applicable fields. Refer [Table 14–7](#) for field value descriptions.
3. Choose .

It is recommended that the Sterling WMS-provided standard print documents is not modified.

14.3.1.3 Deleting a Print Document

To delete a print document:

1. From the tree in the application rules side panel, choose System Administration > Prints > Print Documents. The Print Documents window displays with a list of print documents.
2. Choose the Print Document to be deleted.
3. Choose .

It is recommended that the Sterling WMS-provided standard print documents is not deleted.

14.3.2 Defining Label Formats

Label formats corresponding to the documents are defined here. This allows association of a Label format to the Loftware™ label format and the mapping XML file.

The Loftware™ label format associated here is created using Loftware™ tools. The mapping XML file is created using the Sterling WMS-supplied toolkit. The field binding between the fields in the label and the field in the standard XML published are specified in the mapping XML.

Refer to the *Selling and Fulfillment Foundation: Installation Guide* for further information on installing and configuring the Loftware Label Manager™.

The Sterling WMS provides standard label formats and mapping files for all standard documents supported. A print is run through a service flow defined in the Service Definition Framework (SDF). The Sterling WMS provides data flow for the standard documents provided.

To create, modify, or delete a Label Format, from the tree in the application rules side panel, choose System Administration > Prints > Label Formats. The Label Formats window displays with the Sterling WMS default label formats. For more information about defining label formats, refer to the *Selling and Fulfillment Foundation: Application Platform Configuration Guide*.

14.3.3 Defining User Printer Preferences

User Printer Preferences configures printers that are associated with a group of users or a specific user. This preference is used to determine the printer to use when a user prints a document.

For example, receiving office associates all its users to the HP LaserJet 5P located in the office.

The association of a printer to a station overrides the group preference of the specified user. The station is a static location where devices may be directly attached to a station.

It is recommended that User Printer Preferences be configured at the group level for easier administration.

Note: Printer preferences are configured using Application Platform. For more information about this, see the *Selling and Fulfillment Foundation: Application Platform Configuration Guide*.

Use Printer Preferences for:



- [Setting Up Printer Preferences for a Group](#)
- [Setting Up Printer Preferences for a User](#)

14.3.3.1 Setting Up Printer Preferences for a Group

To set up printer preferences for a group:

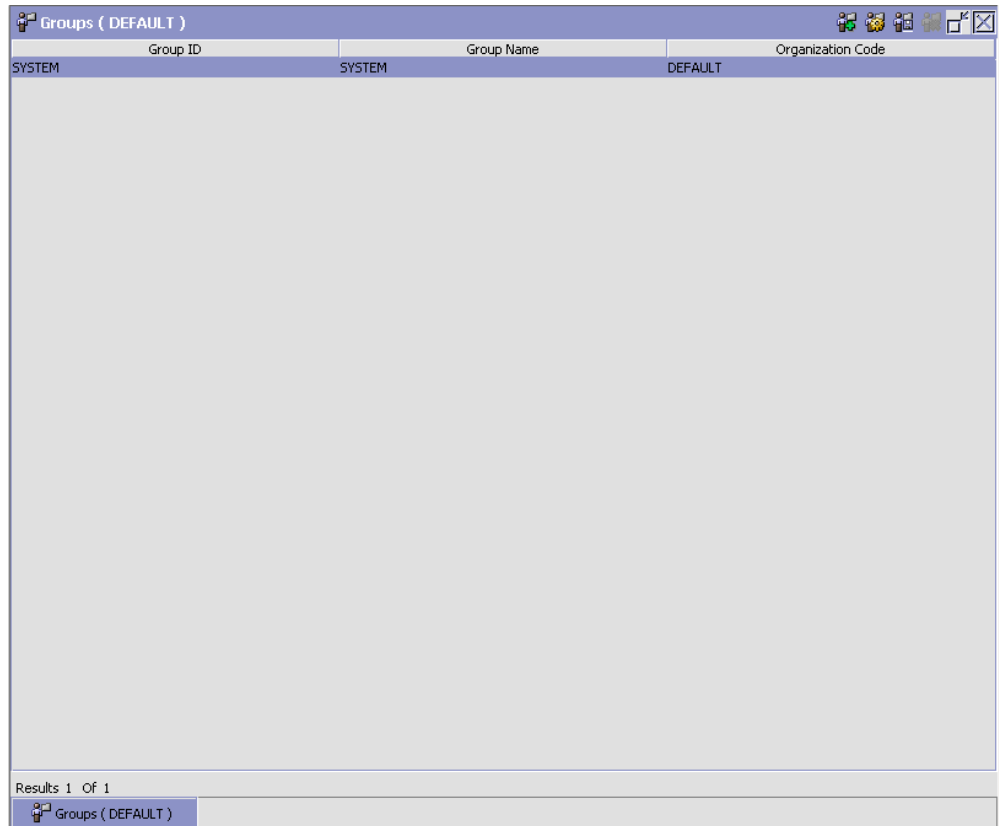
1. From the menu bar, choose Applications > Application Platform. The Application Platform tree displays in the side panel.
2. From the tree in the application rules side panel, choose Security > Groups. The Groups window displays with a list of groups.



3. In the Groups window, choose the Group whose Printer Preferences are to be set up.
4. Choose . The Group Details window displays.
5. In the Group Details window, choose the Printer Preferences tab. The Printer Preferences tab window displays.
6. Enter the information in the applicable fields. Refer [Table 14–8](#) for field value descriptions.
7. Choose .

For more information about Setting Up a Group (Creating, Modifying, or Deleting a Group), see the *Selling and Fulfillment Foundation: Application Platform Configuration Guide*.

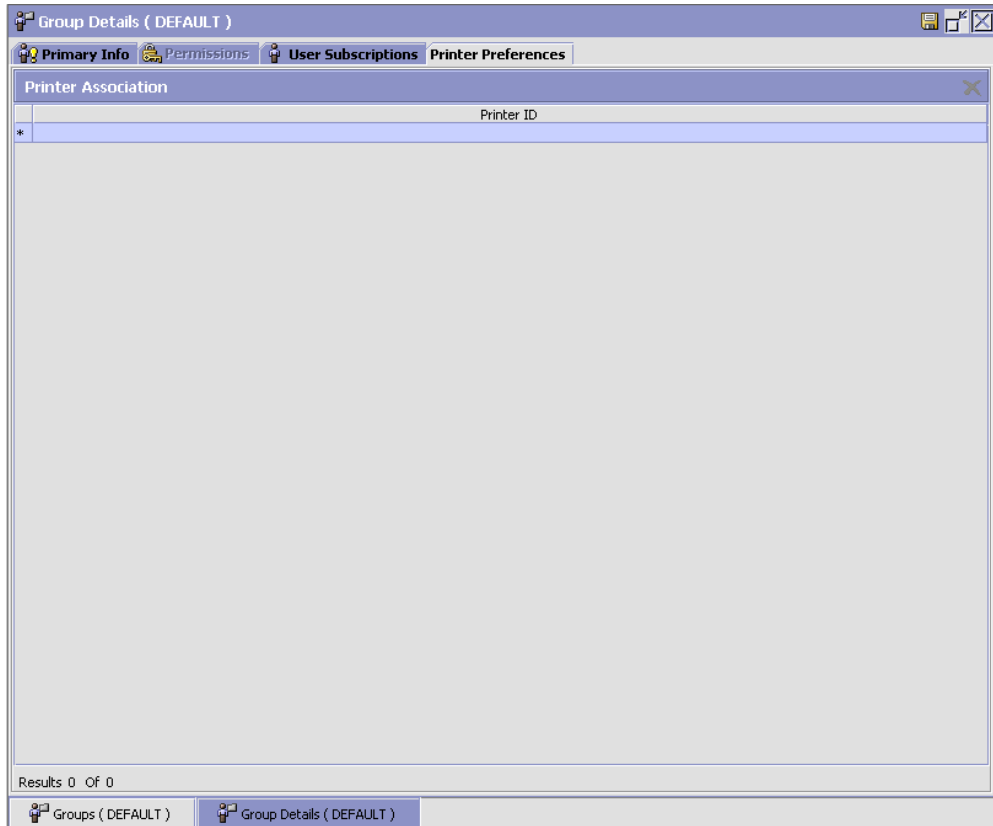

Table 14–8 Printer Preferences Tab Window

Field	Description
Printer Association	
Printer ID	Choose the printer ID to be associated with the group.

The printer at the packing station is associated to the station and not to the packing group or the individual packer. This is also recommended for warehouses that have only a single pack station.

14.3.3.2 Setting Up Printer Preferences for a User



Note: It is recommended that User Printer Preferences be configured at a group level for easier administration.

To set up printer preferences for a user:

1. From the menu bar, choose Applications > Application Platform. The Application Platform tree displays in the side panel.
2. From the tree in the application rules side panel, choose Security > Users. The User Search window displays.
3. In the User Search window, enter applicable search criteria.
4. Choose . The list of users displays in the Search Results panel of the User Search window.

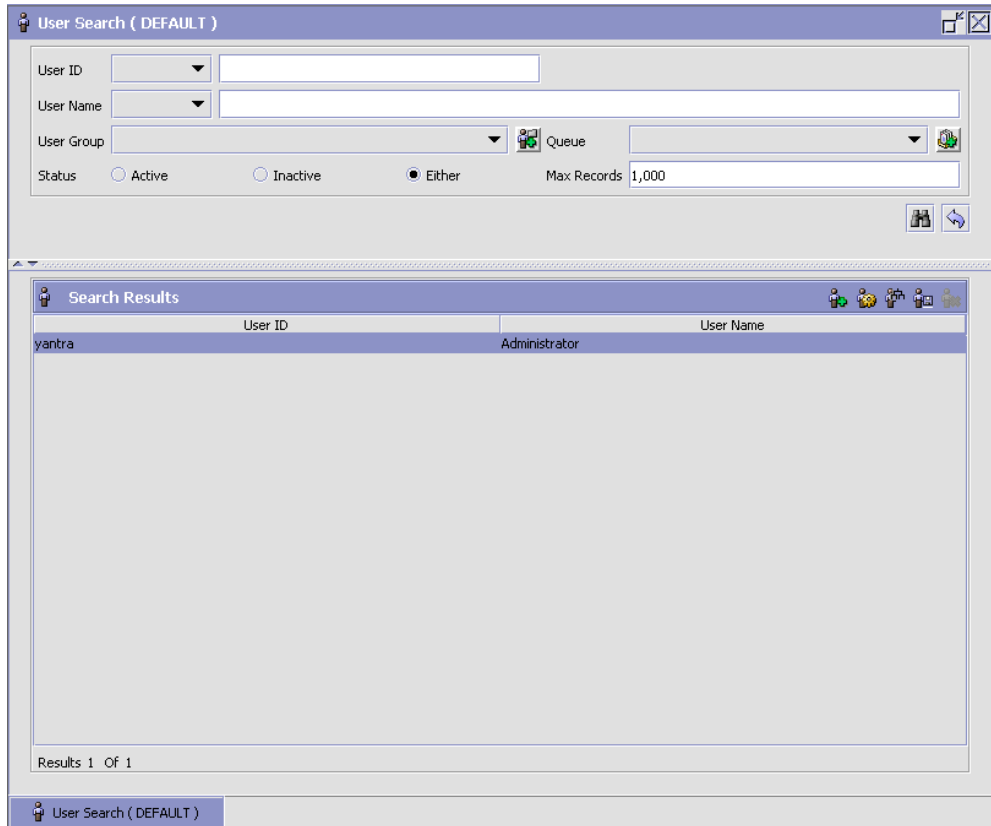
For more information about Creating a New User, see the *Selling and Fulfillment Foundation: Application Platform Configuration Guide*.



5. In the Search Results panel of the User Search window, choose the User whose Printer Preferences are to be set up.
6. Choose . The User Details window displays.
7. In the User Details window, choose the Printer Preferences tab. The Printer Preferences tab window displays.
8. Enter the information in the applicable fields. Refer [Table 14–9](#) for field value descriptions.
9. Choose .

For more information about Setting Up a User (Creating, Modifying, or Deleting a User), see the *Selling and Fulfillment Foundation: Application Platform Configuration Guide*.

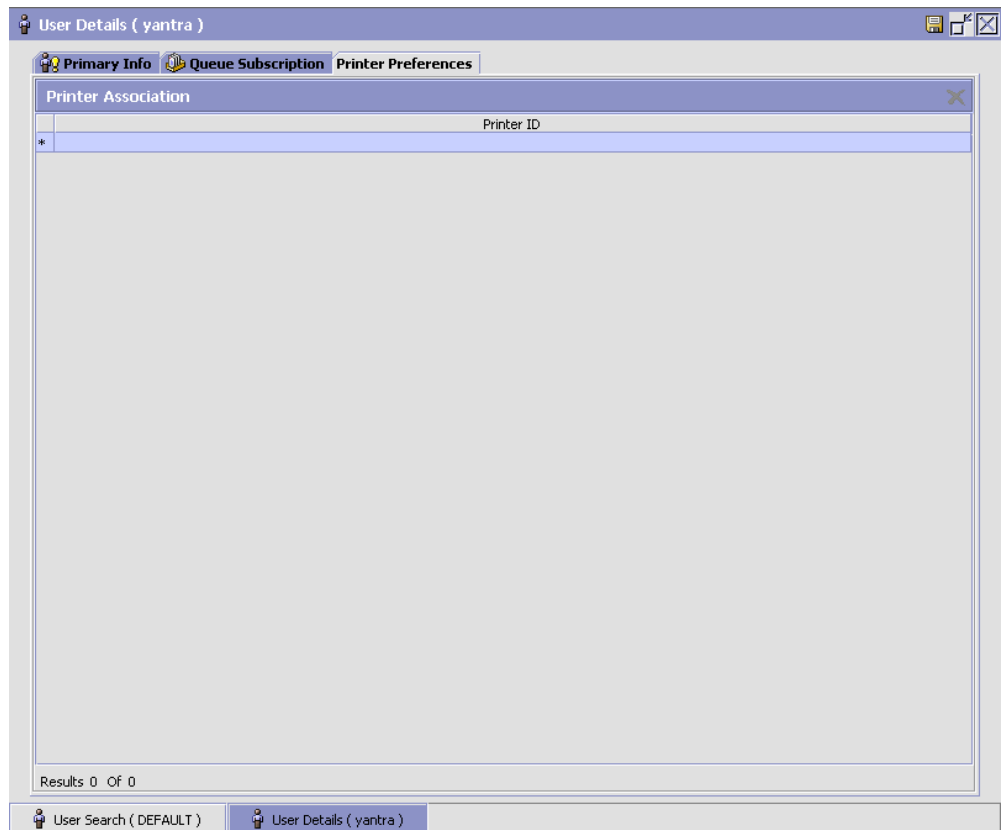

Table 14–9 Printer Preferences Tab Window

Field	Description
Printer Association	
Printer ID	Choose the printer ID to be associated with the user.

14.3.4 Defining Participant Print Preferences

Participant Print Preferences configures the list of devices that are printers at a participant level. This limits the printers being eligible for documents for the participant organization.

Note: Participant print preferences are configured using Application Platform. For more information about this, see the *Selling and Fulfillment Foundation: Application Platform Configuration Guide*.

A participant is associated with a role. For example, the ship node, enterprise, buyer, sellers, carriers are participants in the warehouse. A participant can also be associated with multiple roles. For example, a manufacturer who is both a seller and buyer.

The preferences specified in this document are generic for all participants in the warehouse.

Use Participant Print Preferences for:

- [Setting Up Print Format Preferences](#)

14.3.4.1 Setting Up Print Format Preferences

To set up print format preferences for a participant:

1. From the menu bar, choose Applications > Application Platform. The Application Platform tree displays in the side panel.
2. From the tree in the application rules side panel, choose Participant Modeling > Participant Setup. The Organization Search window displays.
3. In the Organization Search window, enter applicable search criteria.
4. Choose . The list of organizations displays in the Search Results panel of the Organization Search window.

For more information about Creating a New Organization, see the *Selling and Fulfillment Foundation: Application Platform Configuration Guide*.

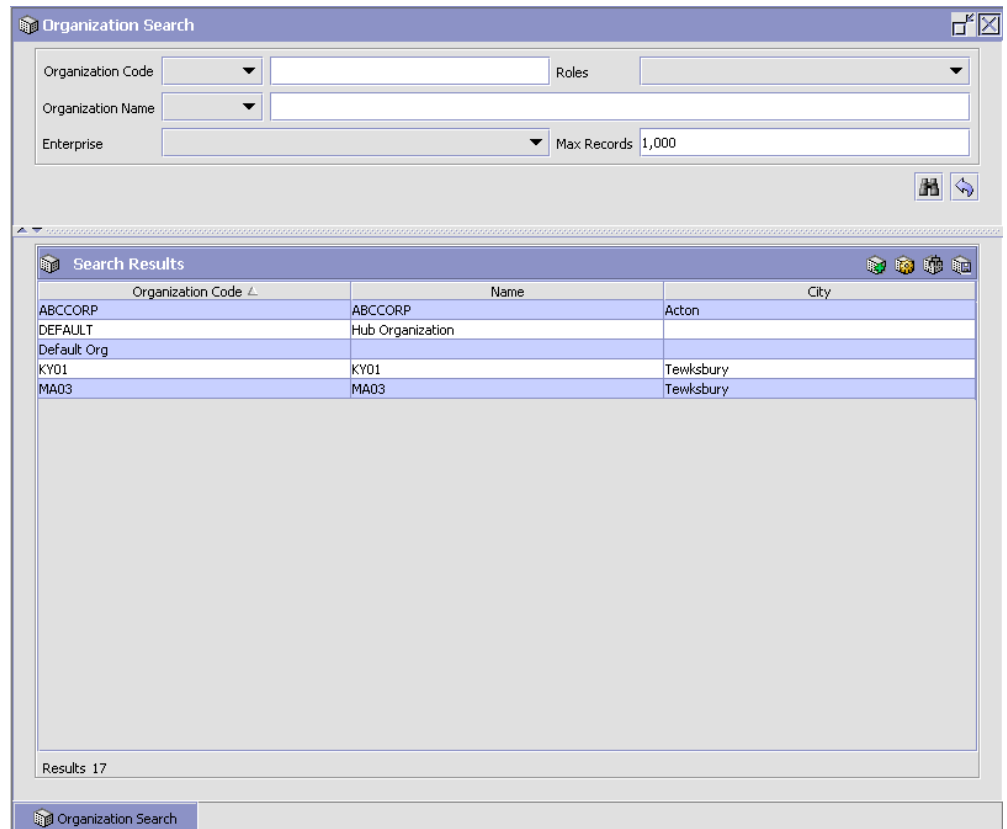

5. In the Search Results panel of the Organization Search window, choose the Organization whose Printer Preferences are to be set up.
6. Choose . The Organization Details window displays.
7. In the Organization Details window, choose the Roles & Participation tab. The Roles & Participation tab window displays.
8. In the Roles & Participation tab window, choose the Print Format Preferences tab.
9. The Print Format Preferences list displays in the Node Attributes tab.
10. Enter the information in the applicable fields. Refer [Table 14–10](#) for field value descriptions.

11. Choose .

For more information about Setting Up an Organization (Creating, Modifying, or Deleting an Organization), see the *Selling and Fulfillment Foundation: Application Platform Configuration Guide*.

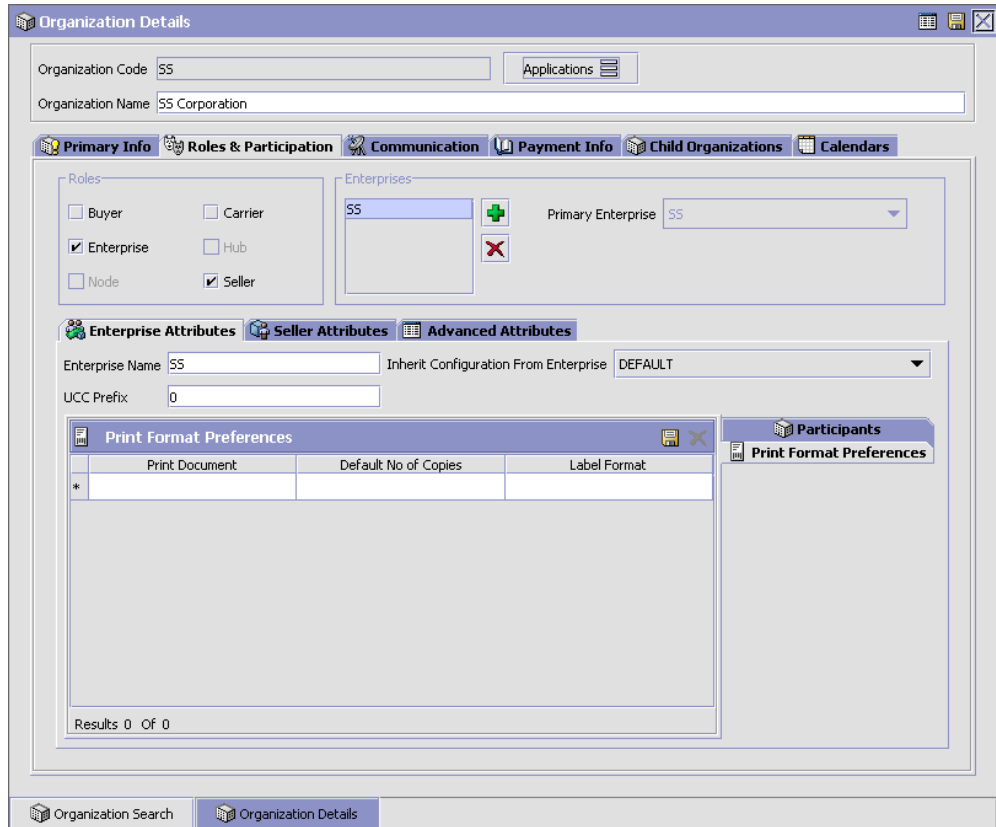

Table 14–10 Node Attributes Tab

Field	Description
Print Format Preference	
Print Document	Choose the name of the document to be printed. For more information about creating a print document, see Section 14.3.1.1, "Creating a Print Document" on page 984.
Default No. of Copies	Enter the number of copies to be printed as default.
Label Format	Choose the label format to be used. Label format is the name of the .lwl (Label Design) file created using Loftware Label Manager™. For more information about label formats, see Section 14.3.2, "Defining Label Formats" on page 952.

The Sterling WMS supplies a list of default documents. These documents are pre-configured to consider specific participant(s) when determining the appropriate printer and its attributes.

For example,

- Carton and Pallet shipping label print considers buyer at the ship node.
- Cart Manifest batch sheet considers the type of batch (sort while pick, pick and sort) along with the type of equipment used.
- Packing list/slip considers the enterprise, seller and buyer organization at the ship node.
- Bill of Lading considers the carrier (SCAC).
- Manifest print considers the carrier (SCAC).

15

Configuring Permissions to Access Multiple Nodes

The Sterling Warehouse Management System enables users to access multiple nodes and perform various warehouse operations.

Permission to access multiple nodes is based on the teams associated to the users in the Applications Manager.

Note: The data access functionalities described in this chapter will not be honored if you have selected the Use Old Data Access Policy Functionality check box under the Installation Rules window, in Selling and Fulfillment Foundation. Therefore, ensure that this check box is cleared by performing the following tasks:

1. Navigate to Application Platform > System Administration > Installation Rules.
2. The Installation Rules window is displayed. In the Backward Compatibility panel, clear the Use Old Data Access Policy Functionality check box, and click .

15.1 Configuring Data Access Policy Rule

The access permissions of users belonging to an organization are governed by data access policy rules. These rules must be configured to honor the users' team definitions for the users to access multiple enterprises and multiple nodes:

- If the user's organization is an enterprise, the data access policy rule for an enterprise user must be set to Data Access As Per User's Team Definition.
- If the user's organization is a node, the data access policy rule for a node user must be set to Data Access As Per User's Team Definition.

It is recommended that teams are created for an organization that is modeled as an Enterprise in order to enable the users belonging to a team to access multiple nodes, and perform various warehouse operations.

Note: Clearing of the database cache is required to take into effect the changes made to this configuration.



For more information about data access policies, refer to the *Selling and Fulfillment Foundation: Application Platform Configuration Guide*.

15.2 Configuring Team Definition

A team is a collection of users who have common data access requirements. Teams can have access to specific enterprises and nodes.

An administrator configures a team for a particular node or enterprise, and associates the users to the team.

Perform the following steps to display the Team Details window:

1. Open the Applications Manager, and navigate to Applications > Application Platform.
2. The application rules side panel is displayed. Click .
3. The Load Organization For Configuration dialog box is displayed. From the organization field, select the organization for which you want to create the team, and click OK.
4. The organization's rule display in the application rule side panel. Select Security > Teams.
5. The Teams window is displayed. Click .

The Team Details window is displayed. The following sections explain the tasks that can be performed from this window.

Notes:

- Access that is provided to a team depends on the access of the creator of the team, and not on the creator's organization. After a team is created, the team's permissions do not change when the administrative power of the organization is transferred to another organization (this occurs when the value of the Administered By field in Organization Details screen is changed).
Following is an example of this scenario:
Organization E1 is administered by Organization A1. A1's user creates a team for E1. The team that is created for E1 can access everything that A1's user can access. E1 is now administered by Organization A2. A2's user has a different set of access. However, the accessibility of the team created for E1 by A1's user remains unchanged.
- Clearing of the database cache is required to take into effect the changes made to this configuration.

15.2.1 Enterprise Access

From the Team Details window, select the Enterprise Access tab and perform one of the following tasks to configure enterprise access for a team:

- Select the Default Enterprise Access radio button to restrict users belonging to a team to be able to view only the enterprises in the default enterprise access list.
- Select the Inherited Enterprise Access radio button to restrict users belonging to a team to be able to view only the enterprises based on the access configuration of the corresponding parent team.
- Select the Restrict Access To A Specific List Of Enterprises radio button to select a list of enterprises that users who are associated to a team can view.

For more information about configuring enterprise access, refer to the *Selling and Fulfillment Foundation: Application Platform Configuration Guide*.

Note: If the enterprise does not maintain its inventory organization, permission should be granted to the inventory organization to allow a user to perform inventory-related warehouse activities.

Note: If an enterprise wants to consume a vendor's inventory, but does not have access to the vendor's enterprise, the enterprise user will not be able to view or transfer the vendor's inventory. In order to perform the warehouse operations in the Vendor Managed Inventory (VMI) scenario, the enterprise user must have access to the corresponding vendor's enterprise. This access must be configured under the Enterprise Access tab. For more information about VMI and consigned inventory, refer to [Chapter 13, "Configuring Consigned Inventory"](#).

15.2.2 Ship Node Access

From the Team Details window, select the Ship Node Access tab and perform one of the following tasks to configure the ship node access for a team:

- Select the All Nodes radio button to allow the team to access all the ship nodes. However, this radio button is not available for an organization whose role is Node.
- Select the User's Node radio button to allow the team to access the node to which the node user belong. If the user is an enterprise user, selecting this radio button allows the team to access all the nodes whose parent organization is the user's enterprise, an enterprise that is hierarchically lower than the user's enterprise, or both.
- Select the Restrict Access To Specific Nodes radio button to restrict the access for the team to only specific nodes.
- Select the Nodes Accessible To Team Creator radio button to allow the team to access all the nodes that are accessible to the creator of the team. However, if the creator's access to certain nodes changes, the team's access to those nodes will also change

automatically. Also, the team's access to the nodes ceases when the creator is deleted from the Applications Manager.

Note: A hub user has access to all the nodes in the Sterling Warehouse Management System.

For more information about configuring ship node access, refer to the *Selling and Fulfillment Foundation: Application Platform Configuration Guide*.

Figure 15–1 illustrates the hierarchy of organizations. In this illustration, E1, E2, and E3 are organizations that are modeled as enterprises. N1, N2, N3, N4, N5, and N6 are organizations that are modeled as nodes.

Figure 15–1 Organizational Hierarchy

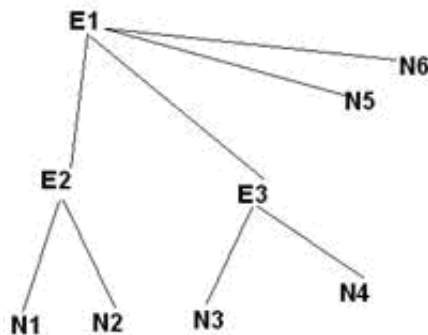

Enterprise E1 is the parent organization of nodes N5 and N6, and enterprises E2 and E3. Enterprise E2 is the parent organization of nodes N1 and N2. Enterprise E3 is the parent organization of nodes N3 and N4.

Figure 15–2 illustrates the hierarchy of organizations that are administered by other organizations.

Figure 15–2 Administered By Organizations

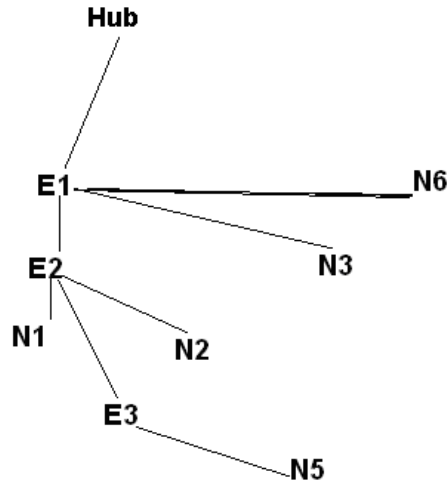

Nodes N1 and N2 are administered by enterprise E2. Nodes N3 and N6 are administered by enterprise E1. Node N5 is administered by enterprise E3. Enterprise E3 is administered by enterprise E2, and enterprise E2 is administered by enterprise E1.

The following examples explain the ship node access policy based on the Organization Hierarchy and Administered By Organization illustrations. Assume that for each organization, the administrator has created a team.

Example 1:

When ship node access is configured to User's Node in all the team configurations.

Organization	E1	E2	E3	N1	N2	N3	N4	N5	N6
Nodes accessible to the users associated to a team	N1	N1	N3	N1	N2	N3	N4	N5	N6
	N2	N2	N4						
	N3								
	N4								
	N5								
	N6								

Users of Enterprise E1 will have access to nodes N1 through N6 because the parent organization of these nodes are either the user's enterprise or an enterprise that is hierarchically lower than the user's enterprise.

Users of Enterprise E2 will have access to nodes N1 and N2.

Node users will have access to only their own organizations.

Example 2:

The following organizations' ship node access is configured as mentioned here:

- E1 - Restrict Access to Nodes N1 and N5
- E2 - Nodes Accessible To Team Creator
- E3 - All Nodes
- N1, N3 - Nodes Accessible To Team Creator
- N2, N4 - User's Node
- N5 - Restrict Access to Nodes N1 and N4
- N6 - Restrict Access to Nodes N2 and N3

Organization	E1	E2	E3	N1	N2	N3	N4	N5	N6
Nodes accessible to the users associated to a team	N1	N1	N1	N1	N2	N1	N4	N1	N2
	N5	N5	N2	N5		N5		N4	N3
			N3						
			N4						
			N5						
			N6						

The ship node access for the users of enterprise E1 is limited to nodes N1 and N5.

Users of enterprise E2 have access to nodes N1 and N5 because they are the only nodes that are accessible to the creator of the team, who belongs to enterprise E1.

Users of enterprise E3 have access to all the nodes because the team configurations is set to All Nodes.

Users of node N1 have access to those nodes that are accessible to users belonging to enterprise E2. Similarly, users of node N3 have access to those nodes that are accessible to users of enterprise E1.

15.3 Configuring Users

A user is assigned certain tasks in a warehouse depending on the user's role in the organization.

Perform the following steps to configure a user who can access multiple nodes in a warehouse:

1. Open the Applications Manager, and navigate to Applications > Application Platform.
2. The application rules side panel is displayed. Click .
3. The Load Organization For Configuration dialog box is displayed. From the Organization drop-down list, select the organization for which you want to create the user, and click OK.
4. The organization's rule display in the application rules side panel. Select Security > Users.

5. The User Search window is displayed. Click  in the Search Results panel to create a new user. For more information about creating a user, refer to the *Selling and Fulfillment Foundation: Application Platform Configuration Guide*.
6. The User Details window in which information about the new user is to be entered is displayed. Select the Primary Info tab, and configure the following:
 - From the Menu Group drop-down list, select the corresponding Warehouse Management System menu group.
 - From the Team drop-down list, select the team to which you want to associate the user.

Note: A user cannot create a node unless the node that is being created will be automatically accessible to the user after creation.

The newly created node will be automatically accessible to the user in the following scenarios:

- The user who creates the node is an Enterprise user, and
 - no team is associated to the user
 - the user's team's ShipNode access is set to "All Nodes"
 - the user's team's ShipNode access is set to "Nodes Accessible to Team Creator", and the user who has created the team has automatic access to the newly created node
- The user who creates the node is a Node user, the user's team's ShipNode access is set to "Nodes Accessible to Team Creator", and the user who has created the team has automatic access to the newly created node.

Any user who has access to a restricted set of nodes in the user's team configuration cannot create a ship node. Also, if the user is a Node user, and no team is associated to that user, the user cannot create a ship node.

Note: An Enterprise user cannot perform the following tasks:

- create a count request across enterprises in a node.
 - create a physical count plan without enterprise in a node.
 - view the count requests that are created across enterprises in a node by a node user.
 - view the physical count plans that are created without enterprise in a node by a node user.
 - view the manual count requests that are created through the Mobile Application in a node.
-
-

For more information about configuring users, refer to the *Selling and Fulfillment Foundation: Application Platform Configuration Guide*.

15.4 Configuring the User Interface for Select Node

You can configure the `yfs.wms.console.show.node.lookup` property and display the node selection criteria in the Console either as a drop-down list or a search icon:

- To display a drop-down list against the Select Node field, set the value of the `yfs.wms.console.show.node.lookup` property to N.
- To display a search icon against the Select Node field, set the value of the `yfs.wms.console.show.node.lookup` property to Y.

16

Resource Planning

The Resource Planning tool provides warehouses the ability to plan for expected workload and determine the number of resources required to complete the activity. Having visibility to expected resources enables a warehouse to accurately plan for overtime, temporary staffing, and so forth, thus optimizing the resource costs.

This chapter explains how to configure resources, their resource pools, and warehouse timings. This aids the warehouse in planning their resources and fulfilling demands for all outbound activities. The demand may be placed on resource pools in the form of Orders, Shipments, Work Orders, and so forth. As an example, configuring these for outbound activities helps you understand how to perform resource planning for outbound shipments. The common activities involved in outbound activities are:

- Replenishment
- Picking
- Packing
- Manifesting
- Shipping

The configurations that need to be done before creating resource pools are:

- [Enabling Resource Planning for a Node](#)
- [Configuring a Node for Planning](#)

Defining resources includes:

- [Defining Resource Pools](#)

- Creating Resource Pools
- Associating Resources to Resource Pools
- Assigning Shifts to Resources
- Setting Resource Efficiency
- Defining Task Type Associations
 - Creating Task Type Resource Pool Associations
 - Creating Condition Sets

16.1 Enabling Resource Planning for a Node

If you select Node as a role for the organization, specify its primary information, sourcing, scheduling, carrier preferences, and calendars. The primary information of a node determines how it is identified throughout the system.

To configure the primary node attributes:

1. Log in to the application console as an administrator.
2. From the Console menu bar, choose Configuration > Launch Applications Manager. The Applications Manager opens in a new window.
3. From the Selling and Fulfillment Foundation Applications Manager menu bar, choose Applications > Application Platform.
4. From the tree in the application rules side panel, choose Participant Modeling > Participant Setup. The Organization Search window displays in the work area.
5. In the Organization Details window, choose the Roles and Participation tab > Node Attributes.
6. Enter information in the applicable fields. Refer to [Table 16–1](#) for field value descriptions.

Table 16–1 Node Attributes

Field	Description
GLN	Enter the global location number.
Node Type	Select the node type for this node from the drop-down list.
Identified By Parent As	Enter the name the node's parent uses to identify it.
Agent Criteria Group	Select an agent criteria group from the drop-down list.
Export License Number	Enter the license number of the node used to export shipments.
License Expiration Date	Enter the date on which the export license expires.
BOL Prefix	Enter the label the node uses as a prefix on the Bill Of Lading (BOL) it creates, if applicable.
Default Declared Value	Enter the default price for Declared Value in the Application Consoles. This price is typically used by parcel carriers for computing insurance.
Resource Planning Enabled	Check this box to enable the planning of resources and activities.

Table 16–1 Node Attributes

Field	Description
Work Day Hours	<p>The standard number of working hours per resource or person in a day.</p> <p>This is used to convert hours to days.</p>
Requires Serial Number Tracking	<p>Check this box if the node requires inventory to be tracked using serial numbers.</p>
Third Party Logistics Node	<p>Check this box if the node is a part of a third-party logistics business model. Chained orders are not created for nodes marked as a third-party logistics node.</p>
Maintain Inventory Cost	<p>Check this box if the node maintains its own inventory costs. If you select this option, you must enter the cost for inventory that is adjusted at this node. The inventory adjustments made for this node need to be approved. Adjustments awaiting approval are called pending adjustments. The actual adjustments do not occur until the pending adjustment has been approved.</p>
Execution in Node Using	
External Application	<p>Choose this option to have order releases interface through events. For more information about events, see the section entitled "Defining Transactions" in the <i>Selling and Fulfillment Foundation: Application Platform Configuration Guide</i>.</p>
Sterling Order Management	<p>Choose this option to have order releases interface through the Sterling Order Management.</p>
Sterling WMS	<p>Choose this option to have order releases interface through the Sterling Warehouse Management System.</p>

Table 16–1 Node Attributes

Field	Description
WMS 6.2	Choose this option to have order releases interface through a version of the Sterling WMS prior to and including Release 6.2.
Action Name	<p>If you chose External Application, select the action to associate with it. For more information about actions, refer to the <i>Selling and Fulfillment Foundation: Application Platform Configuration Guide</i>.</p> <p>Note: Only those actions linked to the Primary Enterprise of this Node or Organization is available in this drop-down list. Any actions created from this screen are linked to the Primary Enterprise of the User's Organization. As a result, they may not be available for the Node or Organization being created.</p> <p>In a multi-enterprise environment, ensure that actions are first created for appropriate Enterprises (when logged in as that Enterprise user). Subsequently, mapping nodes to actions can be done when logged in either as an Enterprise user or as a Hub user.</p>

16.2 Configuring a Node for Planning

Configuring a node for planning is the initial step of resource planning. This enables you to set up the planning calendar, shifts, and work days for a ship node.

To configure a node for resource planning:

1. Log in to the application console as an Administrator.
2. From the Console menu bar, select Configuration > Launch Applications Manager. The Selling and Fulfillment Foundation Applications Manager opens in a new window.
3. From the Selling and Fulfillment Foundation Applications Manager menu bar, choose Applications > Warehouse Management.
4. From the tree in the applications rule side panel, choose Resource Planning > Node Planning Attributes. The Node Attributes for Planning screen displays.
5. Enter information in the applicable fields. Refer to [Table 16–2, "Node Attributes for Planning"](#) for field value descriptions.

Node Attributes for Planning

Day Starts at (HH:MM) Ends at (HH:MM)

Work Day Hours

Preferred UOM for Planning

Planning Calendar

Difference between Capacity and Demand within % does not require resolution

Service Slot Description	Start Time	End Time
Morning	07:00	14:59
Evening	15:00	22:59
Night	23:00	06:59
*		

Table 16–2 Node Attributes for Planning

Field	Description
Day Starts At	Enter the time of the day at work at a warehouse begins.
Ends At	Enter the time of the day at work at a warehouse ends.
Work Day Hours	Enter the standard number of working hours per resource or person in each day. This is used to convert the hours to days.
Preferred UOM for Planning	Select the appropriate UOM from the drop-down list: <ul style="list-style-type: none"> Hours—UOM in terms of Hour. Work Day—UOM in terms of days.

Table 16–2 Node Attributes for Planning

Field	Description
Planning Calendar	<p>Select the appropriate calendar from the drop-down list.</p> <p>This calendar is used for all resource planning operations in a warehouse. For example, each resource inherits this calendar for defining its own calendar.</p> <p>For more information about configuring and defining calendars for an organization, see the <i>Selling and Fulfillment Foundation: Application Platform Configuration Guide</i>.</p>
Difference between Capacity and Demand within _% does not require resolution	<p>Enter the value in percentage of capacity. When the difference between capacity and demand is more than the percentage specified, you can decide to resolve the mismatch.</p> <ul style="list-style-type: none"> • Red—This color indicates that the demand is more than the capacity. • Green—This color indicates that the capacity is more than the demand.
Service Slots	The service slots are equivalent to shifts in a warehouse. The capacity of a warehouse to perform different activities is exposed in each time slot defined.
Service Slot Description	Enter a brief description of each service slot.
Start Time	Specify the start time for the service slot.
End Time	Specify the end time for the service slot.

16.3 Defining Resource Pools

A resource pool defines a set of resources that performs similar operations in the warehouse. The different resource pools in a warehouse include:



- Replenishment
- Picking
- Packing
- Manifesting

- Shipping

Each resource pool owns a certain type of activities. Each resource pool has one or multiple resources associated with it. A single operation may necessitate the need of different resource pools. For example, to pick inventory for a shipment requires pickers and forklifts.

16.3.1 Creating Resource Pools

To create a resource pool:

1. Log in to the application console as an administrator.
2. From the Console menu bar, choose Configuration > Launch Applications Manager. The Selling and Fulfillment Foundation Applications Manager opens in a new window.
3. From the Selling and Fulfillment Foundation Applications Manager menu bar, choose Applications > Warehouse Management.
4. From the tree in the applications rule side panel, choose Resource Planning > Resource Pools. The Resource Pool Search screen displays.
5. In the Resource Pool window, choose . The Resource Pool Details screen displays.
6. Enter information in the applicable fields. Refer to [Table 16–3, "Creating Resource Pools"](#) for field value descriptions.
7. Choose .

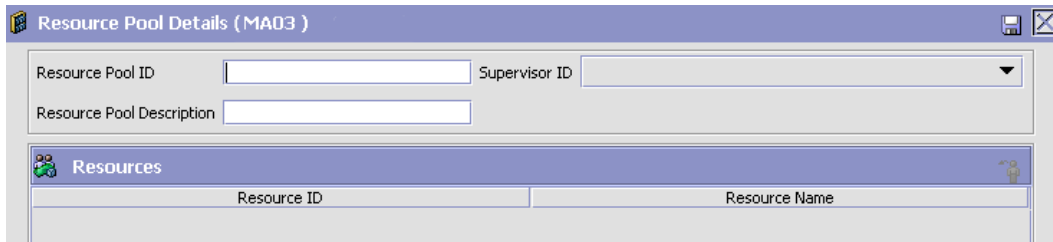

Resource ID	Resource Name
-------------	---------------

Table 16–3 Creating Resource Pools

Field	Description
Resource Pool ID	Enter the identifier of the resource pool.
Supervisor ID	Enter the identifier of the supervisor for the resource pool.
Resource Pool Description	Enter a brief description for the resource pool.
Resources	
Resource ID	The identifier of the resource for the resource pool.
Resource Name	The name of the resource within the resource pool.

16.3.2 Associating Resources to Resource Pools

Resources are assigned to resource pools based on the requirement.

To associate resources with resource pools:

1. From the Selling and Fulfillment Foundation Applications Manager menu bar, choose Applications > Warehouse Management.
2. From the tree in the applications rule side panel, choose Resource Planning > Resource Pools. The Resource Pool Search screen displays.
3. Select a resource pool. The Resource Pool Details screen displays.
4. Choose  to add users to that resource pool. The Find User to Add to Resource Pool screen displays.
5. Choose  icon to select users.
6. Choose  to add selected users to the resource pool.

16.3.2.1 Assigning Shifts to Resources

To assign shifts to resources:

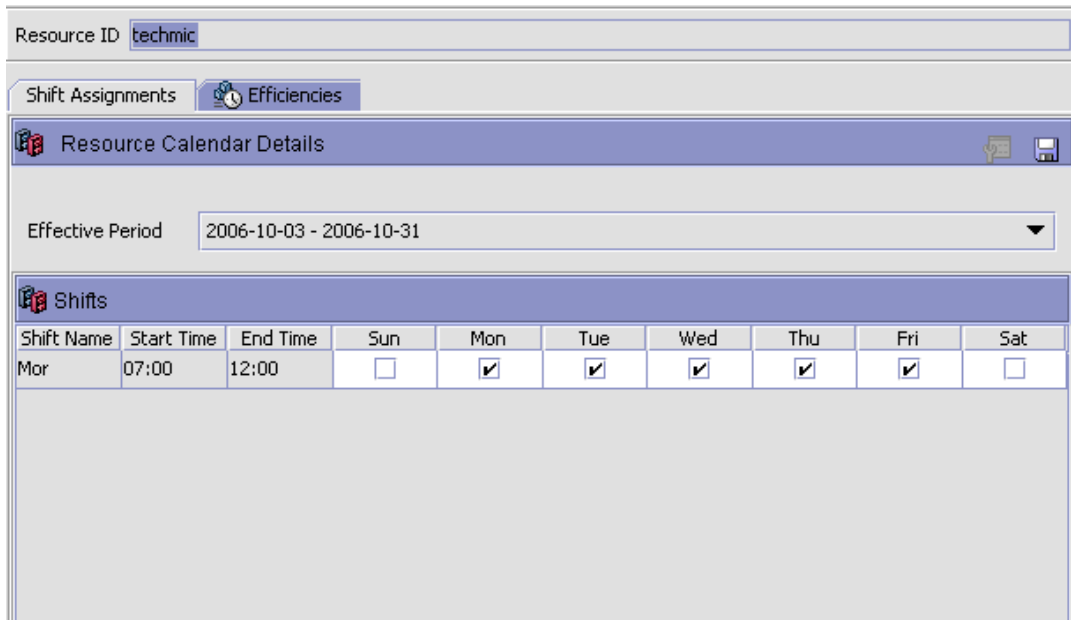

1. From the Selling and Fulfillment Foundation Applications Manager menu bar, choose Applications > Warehouse Management.
2. From the tree in the applications rule side panel, choose Resource Planning > Resource Pools. The Resource Pool Search screen displays.
3. Select a resource pool. The Resource Pool Details screen displays.

4. Select a particular resource. The Resource Details screen displays.
5. Choose the Shift Assignments tab.
6. Enter information in the applicable fields. Refer to [Table 16–4, "Shift Assignments"](#) for field value descriptions.
7. Choose .



Resource ID

Shift Assignments  Efficiencies

Resource Calendar Details  

Effective Period

Shifts

Shift Name	Start Time	End Time	Sun	Mon	Tue	Wed	Thu	Fri	Sat
Mor	07:00	12:00	<input type="checkbox"/>	<input checked="" type="checkbox"/>	<input checked="" type="checkbox"/>	<input checked="" type="checkbox"/>	<input checked="" type="checkbox"/>	<input checked="" type="checkbox"/>	<input type="checkbox"/>

Table 16–4 Shift Assignments

Field	Description
Resource Calendar Details	
Effective Period	Select the date range through which you want the shifts to be effective. The effective period is obtained from the planning calendar configured for the node planning attributes. For more information about defining and creating calendars, see the <i>Selling and Fulfillment Foundation: Application Platform Configuration Guide</i> .
Shifts	

Table 16–4 Shift Assignments

Field	Description
Shift Name	Displays the name of the shift for the days to assign to a resource for the selected effective period.
Start Time	Displays the start time for each shift as defined in the planning calendar.
End Time	Displays the end time for each shift as defined in the planning calendar.
Sunday	Check this box if the user is working in the defined shift on this day.
Monday	Check this box if the user is working in the defined shift on this day.
Tuesday	Check this box if the user is working in the defined shift on this day.
Wednesday	Check this box if the user is working in the defined shift on this day.
Thursday	Check this box if the user is working in the defined shift on this day.
Friday	Check this box if the user is working in the defined shift on this day.
Saturday	Check this box if the user is working in the defined shift on this day.

16.3.2.2 Setting Resource Efficiency

You can set efficiencies for a resource within a particular resource pool. This aids in tracking efficiency of each resource against various resource pools.

To set efficiencies for a resource:

1. From the Selling and Fulfillment Foundation Applications Manager menu bar, choose Applications > Warehouse Management.
2. From the tree in the applications rule side panel, choose Resource Planning > Resource Pools. The Resource Pool Search screen displays.
3. Select a resource pool. The Resource Pool Details screen displays.
4. Select a particular resource. The Resource Details screen displays.

5. Choose the Efficiencies tab.
6. Enter information in the applicable fields. Refer to [Table 16–5, "Resource Details, Efficiencies"](#) for field value descriptions.
7. Choose .

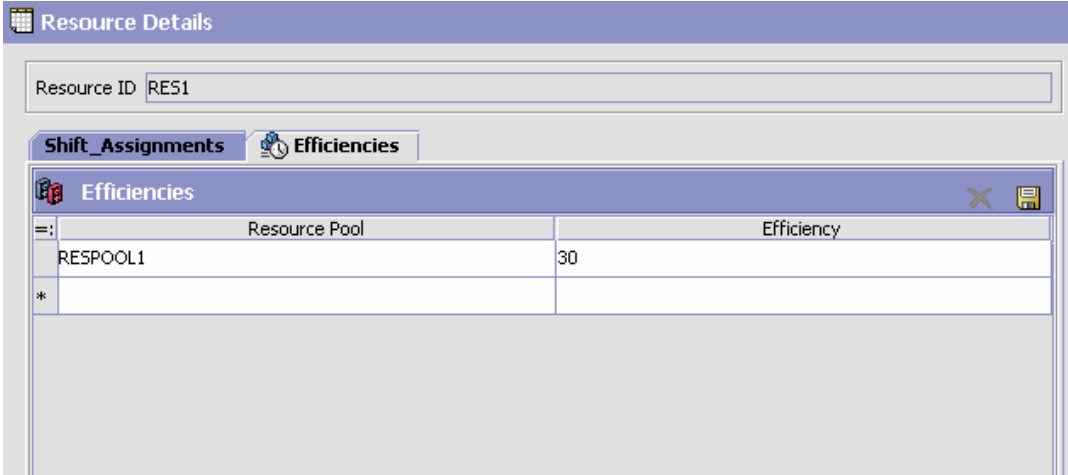

The screenshot shows the 'Resource Details' window with the 'Efficiencies' tab selected. The 'Resource ID' field contains 'RES1'. Below the tabs, there is a table titled 'Efficiencies' with two columns: 'Resource Pool' and 'Efficiency'. The table contains one data row with 'RESPOOL1' in the 'Resource Pool' column and '30' in the 'Efficiency' column. There is also a row with an asterisk (*) in the first column, likely representing a new entry.

Table 16–5 Resource Details, Efficiencies



Field	Description
Efficiencies	
Resource Pool	Select the resource pool from the drop-down list for which you want to set efficiency of the resource or user.
Efficiency	Enter the efficiency of the resource or user for the selected resource pool.

16.3.3 Modifying Resource Pools

You can modify a resource pool.



To modify a resource pool:

1. From the Selling and Fulfillment Foundation Applications Manager menu bar, choose Applications > Warehouse Management.

2. From the tree in the applications rule side panel, choose Resource Planning > Resource Pools. The Resource Pool Search screen displays.
3. Choose . A list of resource pools display.
4. Select the appropriate resource pool from the list.
5. Choose  to modify the resource pool details. Refer to [Table 16–3, "Creating Resource Pools"](#) for field value descriptions.
6. Choose .

16.3.4 Deleting Resource Pools

To delete a resource pool:

1. From the Selling and Fulfillment Foundation Applications Manager menu bar, choose Applications > Warehouse Management.
2. From the tree in the applications rule side panel, choose Resource Planning > Resource Pools. The Resource Pool Search screen displays.
3. Choose . A list of all resource pools display.
4. Select the appropriate resource pool from the list.
5. Choose .

16.4 Defining Task Type Associations



Task types are associated with a set of resource pools that are required to perform a particular task. You can define conditions on various attributes of a demand and associate a set of task types to this condition. You can define a list of conditions within a condition set. Logically, each condition represents related activities involved in fulfilling a demand. The estimated capacity for fulfilling a demand is evaluated from the SAM definitions associated with a task type.

16.4.1 Creating Task Type Resource Pool Associations

You can create a new task type resource pool association.

To create a task type resource pool association:

1. Log in to the application console as an administrator.

2. From the Console menu bar, choose Configuration > Launch Applications Manager. The Selling and Fulfillment Foundation Applications Manager opens in a new window.
3. From the Selling and Fulfillment Foundation Applications Manager menu bar, choose Applications > Warehouse Management.
4. From the tree in the applications rule side panel, choose Resource Planning > Task Type Associations. The Task Type screen displays.
5. Choose the Task Type Resource Pool Association Tab.
6. Choose . The Task Type Resource Pool Association screen displays.
7. Enter information in the applicable fields. Refer to [Table 16–6, "Task Type Resource Pool Association"](#) for field value descriptions.
8. Choose .

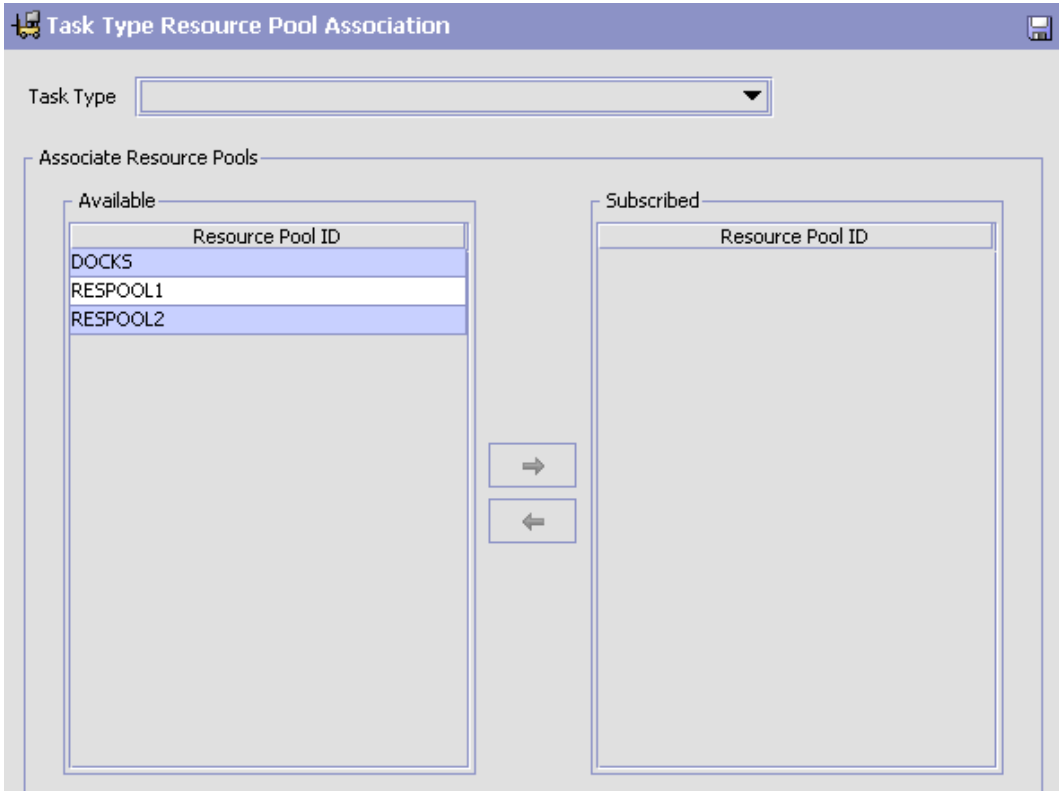



Table 16–6 Task Type Resource Pool Association

Field	Description
Task Type	Select the task type from the drop-down list with which you need to associate the resource pool.
Associate Resource Pools	
Available	Displays the list of resource pools that are created within a warehouse.
Subscribed	Displays the list of resource pools that are to be associated with the defined task type.

16.4.2 Modifying Task Type Resource Pool Associations

To modify the task type resource pool association:

1. Log in to the application console as an administrator.
2. From the Console menu bar, choose Configuration > Launch Applications Manager. The Selling and Fulfillment Foundation Applications Manager opens in a new window.
3. From the Selling and Fulfillment Foundation Applications Manager menu bar, choose Applications > Warehouse Management.
4. From the tree in the applications rule side panel, choose Resource Planning > Task Type Resource Pool Association. The Task Type Resource Pool Association screen displays.
5. Select the appropriate task type and choose . The Associate Resource Pool screen displays.
6. Modify the information as needed. Refer to [Table 16–6, "Task Type Resource Pool Association"](#) for field value descriptions.
7. Choose .

16.4.3 Deleting Task Type Resource Pool Associations

To delete a task type resource pool association:

1. Log in to the application console as an administrator.
2. From the menu bar, choose Configuration > Launch Applications Manager. The Selling and Fulfillment Foundation Applications Manager opens in a new window.
3. From the Selling and Fulfillment Foundation Applications Manager menu bar, choose Applications > Warehouse Management.
4. From the tree in the applications rule side panel, choose Resource Planning > Task Type Resource Pool Association. The Task Type Resource Pool Association screen displays.
5. Select the appropriate task type and choose .

16.4.4 Creating Condition Sets

To create a condition set:

1. Log in to the application console as an administrator.



2. From the Console menu bar, choose Configuration > Launch Applications Manager. The Selling and Fulfillment Foundation Applications Manager opens in a new window.
3. From the Selling and Fulfillment Foundation Applications Manager menu bar, choose Applications > Warehouse Management.
4. From the tree in the applications rule side panel, choose Resource Planning > Task Type Associations. The Task Type Association screen displays.
5. Choose the Condition Task Type tab. The Condition Task Type Association screen displays.
6. Choose . The condition set screen displays.
7. Enter information in the applicable fields. Refer to [Table 16–7, "Creating Condition Set"](#) for field value descriptions.
8. Choose .



Table 16–7 *Creating Condition Set*



Field	Description
Sequence#	Enter the sequence number of the condition set you want to define. The condition sets appear in the order of the sequence number.
Condition Set	Enter the name of the condition set.

16.4.5 Creating Planned Task Conditions

The planned task conditions are created within a condition set.

To create a planned task condition:

1. From the Selling and Fulfillment Foundation Applications Manager menu bar, choose Applications > Warehouse Management.

2. From the tree in the applications rule side panel, choose Resource Planning > Task Type Associations. The Task Type Association screen displays.
3. Choose the Condition Task Type tab. The Condition Task Type Association screen displays.
4. Select the appropriate condition set and choose . The Planned Task Condition screen displays.
5. Enter information in the applicable fields. Refer to [Table 16–8, "Planned Task Condition"](#) for field value descriptions.
6. Choose .

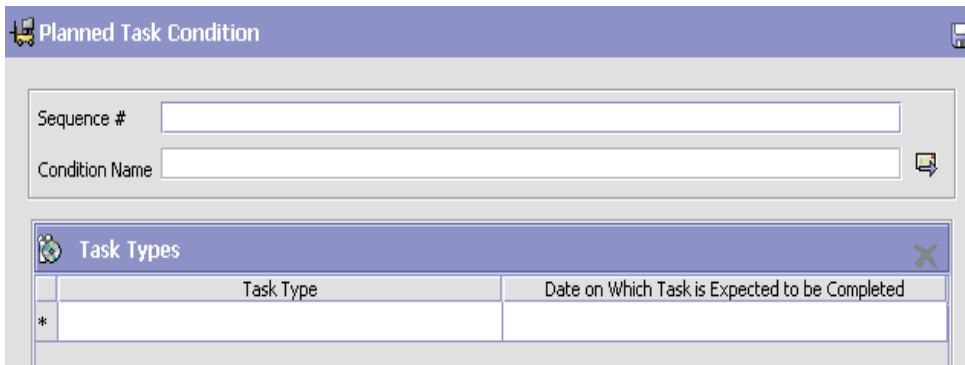

The screenshot shows the 'Planned Task Condition' dialog box. It features a title bar with a save icon. Below the title bar are two text input fields: 'Sequence #' and 'Condition Name'. To the right of the 'Condition Name' field is a small icon representing a task type. Below these fields is a table titled 'Task Types'. The table has two columns: 'Task Type' and 'Date on Which Task is Expected to be Completed'. The first row of the table has an asterisk (*) in the 'Task Type' column.

Table 16–8 Planned Task Condition

Field	Description
Sequence#	Enter the sequence number of the task condition.
Condition Name	Enter the name of the condition. This is obtained when you choose  located next to the condition name. For more information about condition names, see Section 16.4.5.1, "Creating Condition Names" .
Task Types	

Table 16–8 Planned Task Condition



Field	Description
Task Type	Select the appropriate task type from the drop-down list for a defined condition.
Date on Which Task is Expected to be Completed	Select the appropriate date on which you expect the task to be completed.

Note: Define the UOM-specific conditions within the condition set in the descending order of the UOM quantity. The highest priority must be assigned to the UOM that contains the highest number of units.

16.4.5.1 Creating Condition Names

You can create condition names.

To create a condition name:

1. From the tree in the applications rule side panel, choose Resource Planning > Task Type Associations. The Task Type Association screen displays.
2. Choose the Condition Task Type tab. The Condition Task Type Association screen displays.
3. Select the appropriate condition set and choose . The Planned Task Condition screen displays.
4. Choose  next to the condition value. The Condition Detail screen displays.
5. Enter information in the applicable fields. Refer to [Table 16–9, "Creating Condition Name"](#) for field value descriptions.
6. Choose .

Condition Detail: New (Resource Planning)

Condition ID

Condition Name

Condition Group

Static Dynamic Advanced XML

Condition Value

Table 16–9 *Creating Condition Name*

Field	Description
Condition ID	Enter the identifier of the condition.
Condition Name	Enter the name of the condition.



Table 16–9 Creating Condition Name

Field	Description								
Condition Group	<p>Enter the name of the condition group, if applicable. The condition group enables you to group related conditions within the condition tree.</p> <table border="1" data-bbox="686 404 1276 774"> <thead> <tr> <th colspan="2" data-bbox="686 404 1276 447">Fields</th> </tr> </thead> <tbody> <tr> <td data-bbox="686 447 982 522">Static</td> <td data-bbox="982 447 1276 522">Choose this if applicable.</td> </tr> <tr> <td data-bbox="686 522 982 647">Dynamic</td> <td data-bbox="982 522 1276 647">This field is always disabled as it is not applicable to resource planning.</td> </tr> <tr> <td data-bbox="686 647 982 774">Advanced XML</td> <td data-bbox="982 647 1276 774">This field is always disabled as it is not applicable to resource planning.</td> </tr> </tbody> </table>	Fields		Static	Choose this if applicable.	Dynamic	This field is always disabled as it is not applicable to resource planning.	Advanced XML	This field is always disabled as it is not applicable to resource planning.
Fields									
Static	Choose this if applicable.								
Dynamic	This field is always disabled as it is not applicable to resource planning.								
Advanced XML	This field is always disabled as it is not applicable to resource planning.								
Condition Value (If "Is Dynamic" is not checked)	<p>Enter the value of the condition you want to set. You can set it up in a formulaic readout using the available symbols.</p> <p>You can enter the value by choosing  (process condition icon). For more information about conditions, see Section 16.4.5.1.1, "Creating Condition Values".</p> <p>For more information about the condition builder, refer to the <i>Selling and Fulfillment Foundation: Application Platform Configuration Guide</i>.</p>								

16.4.5.1.1 Creating Condition Values

You can create a condition value.

To create a condition value:

1. From the condition detail screen, next to the condition value, choose . The resource planning condition builder screen displays.
2. Select the appropriate field and enter the value of the field.
3. Choose .
4. Choose OK.

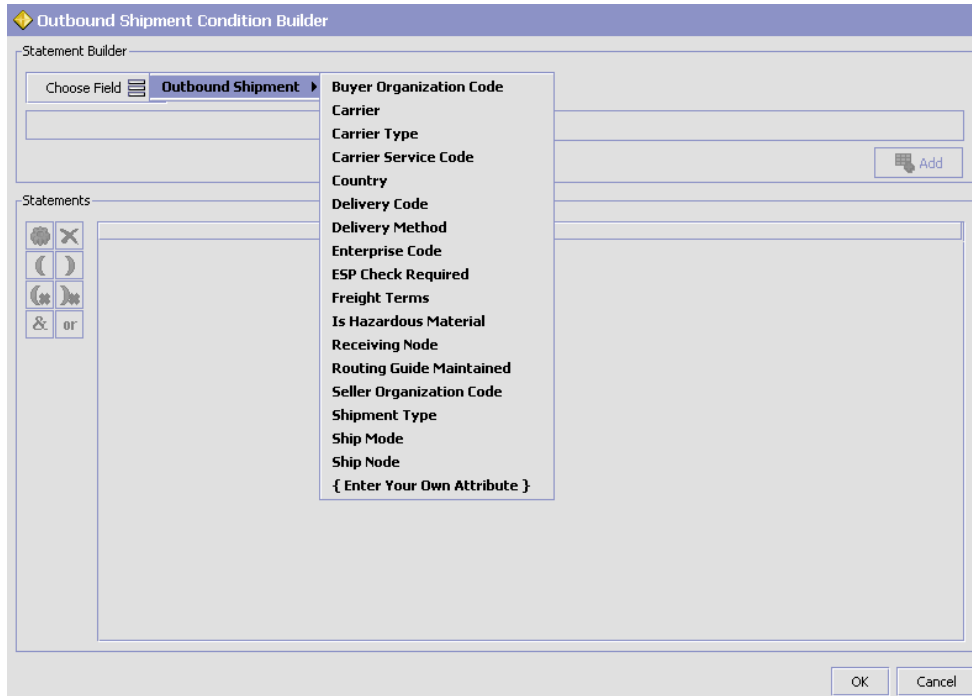

16.5 Wave Planning

When the resource planning is enabled, you can configure different attributes such as:

- [Wave Size Constraints](#)
- [Shipment Selectors](#)

16.5.1 Wave Size Constraints

You can configure various attributes for resource planning within the wave size constraint. For more information about defining wave size constraints, see [Section 7.2.2, "Defining Wave Size Constraints"](#).

16.5.2 Shipment Selectors

You can configure various attributes for resource planning within the shipment selector. For more information about defining shipment groups, see [Section 7.2.1, "Defining Shipment Groups"](#).

16.6 Defining a Transaction Repository

A repository is a logical collection of entities that define the business process workflow. The Transaction Repository includes the following entities:

- Transactions
- Conditions
- Actions
- Services

Selling and Fulfillment Foundation provides a base repository for each of the system-defined process types. Some of the entities within a repository are copied when creating a new document type. For more information about creating a new document type, see the *Selling and Fulfillment Foundation: Application Platform Configuration Guide*.

For more information about defining the process type details, see the *Selling and Fulfillment Foundation: Application Platform Configuration Guide*.

16.6.1 Transactions

Every process type has a set of base transactions defined for it. A transaction is a logical unit of work that is necessary for performing an activity within Selling and Fulfillment Foundation. Base transactions are predefined transactions that contain information about the transaction behavior such as how many copies of a transaction can be kept in a process type and whether it can have configurable base pick and drop statuses. Base transactions can be used to create new transactions. These transactions can be changed within the limits defined in the base transaction.

For more information about transactions, see the *Selling and Fulfillment Foundation: Application Platform Configuration Guide*.

To view the transaction repository details for Resource Planning:

1. Log in to the application console as an administrator.
2. From the Console menu bar, choose Configuration > Launch Applications Manager. The Selling and Fulfillment Foundation Applications Manager opens in a new window.
3. From the Selling and Fulfillment Foundation Applications Manager menu bar, choose Applications > Application Platform.
4. From the tree in the application rules side panel, choose Process Modeling > General > Resource Planning. The Resource Planning Repository window displays.
5. In the Resource Planning Repository window, choose .
6. The Transactions tab window displays.

For more information about creating and modifying transactions, see the *Selling and Fulfillment Foundation: Application Platform Configuration Guide*.

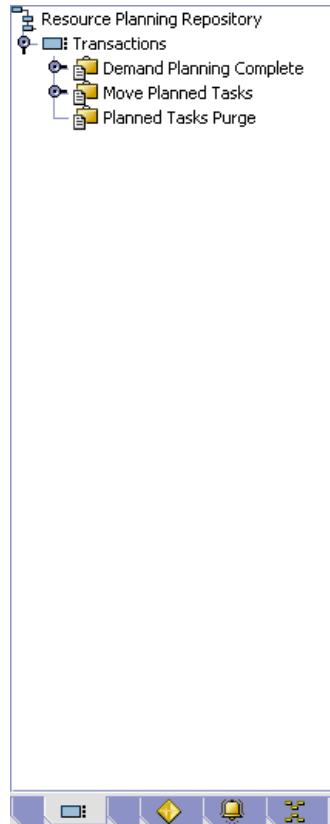

Table 16–10 *Resource Planning - Transactions Tab Window*

Field	Description
Demand Planning Complete	This transaction represents the completion of planning demand and capacity for a day.
Move Planned Tasks	This transaction represents the movement of planned tasks to a different day.
Planned Tasks Purge	This transaction represents a planned task that may be purged.

16.6.2 Conditions

A condition matches document type attributes against decision points and routes documents to different paths based on the specified attribute and value combinations. The document type attributes against which conditions can be created are predefined in Selling and Fulfillment Foundation. You can use these attributes in any combination or create conditions that run the appropriate application logic for specific circumstances.

For more information about Conditions, see the *Selling and Fulfillment Foundation: Application Platform Configuration Guide*.

To view the condition repository details for Resource Planning:

1. From the Selling and Fulfillment Foundation Applications Manager menu bar, choose Applications > Application Platform.
2. From the tree in the application rules side panel, choose Process Modeling > General > Resource Planning. The Resource Planning Repository window displays.
3. Choose . The Conditions tab window displays.

For more information about creating and modifying conditions, see the *Selling and Fulfillment Foundation: Application Platform Configuration Guide*.

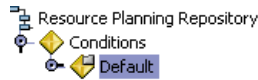

The Sterling Warehouse Management System default transaction repository does not have any conditions specified.

16.6.3 Actions

An action is a process or program that is triggered by an event. These processes and programs send user alert notifications and automatically resolve issues.

For example, when a variance task is created (event), you can set an action to send the enterprise user an e-mail.

For more information about Actions, see the *Selling and Fulfillment Foundation: Application Platform Configuration Guide*.

To view the action repository details for Resource Planning:

1. From the tree in the application rules side panel, choose Process Modeling > General > Resource Planning. The Resource Planning Repository window displays.
2. Choose . The Actions tab window displays.

For more information about creating and modifying actions, see the *Selling and Fulfillment Foundation: Application Platform Configuration Guide*.

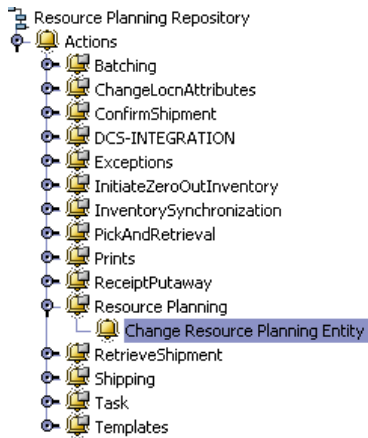

Table 16–11 WMS Inventory - Actions Tab Window

Field	Description
Batching	Default settings are provided for: Print Move Tickets – Invokes the batch printing service for printing move tickets. Print Task Sheets – Invokes the batch print service for printing task sheets.
ChangeLocnAttributes	Default settings are provided for: ChangeLocationDimensions – Invokes the change location dimensions service to update the available weight and volume in a location.
ConfirmShipment	Default settings are provided for: ConfirmShipment – Invokes the confirmShipment flow to confirm the shipment.
DCS-Integration	Default settings are provided for: InventoryDownload – Invokes the YantraWMSInventoryDownloadService service to download the inventory information from Selling and Fulfillment Foundation to DCS. PODownload – Invokes the YantraWMSPODownloadService service to download the Purchase Order information from Selling and Fulfillment Foundation to DCS.
Exceptions	Default settings are provided for: ShortagesDetected – Invokes the LogWavePlaFailure exception service when shortage of inventory occurs during wave release.
InitiateZeroOutInventory	Default settings are provided for: ZeroOutLocationInventory – Invokes the zero out location inventory service to clean the accounting bins.
InventorySynchronization	Default settings are provided for: CollectInventoryMismatch – This service collects the inventory mismatch information between an external system and Selling and Fulfillment Foundation. This is typically caused when some inventory updates at a node or a warehouse are not reported to Selling and Fulfillment Foundation.

Table 16–11 WMS Inventory - Actions Tab Window

Field	Description
PickAndRetrieval	Default settings are provided for: ConfirmEmptyLocationAfterPick – Invokes the GenerateCountRequest flow which creates a count request.
Prints	Default settings are provided for: PickList Print – Invokes the print service for printing the Pick List. LTL Manifest – Invokes the print service for printing the Less-than Truck Load Manifest. Print Load BOL – Invokes the print service for printing the Load Bill of Lading. Print PackList – Invokes the print service for printing the Pack List. Print Post Pick Container Labels – Invokes the print service for printing UCC-128 container labels for containers, when system defined packing process is used. Print Shipment BOL – Invokes the print service for printing the Shipment Bill of Lading. Print Shipping Label – Invokes the print service for printing the UCC-128 container labels. Print Wave – Invokes the Print service for printing a Wave.
ReceiptPutaway	Putaway products on receipt closure – Indicates the default action provided to automatically initiate putaway of purchase order receipts.
Resource Planning	Default settings are provided for: Change Resource Planning Entity – Invokes the ProcessRPEntityMessage service to change the Expected Pick Date/Expected Shipment Date of the Shipment.
RetrieveShipment	Retrieve Requested Serial – This service invokes the retrieveShipment API to retrieve the requested serials to the specified location.

Table 16–11 WMS Inventory - Actions Tab Window

Field	Description
Shipping	<p>Default settings are provided for:</p> <p>Load Left Origin – Invokes the doLoadLeftOriginUpdates service to mark that the load has left the origin.</p> <p>Stop Shipping – Invokes the RaiseStopShippingAlert service to raise an alert to stop the processing of the shipment.</p>
Task	<p>Default settings are provided for:</p> <p>On Task Complete – Invokes the Enqueue Release Task Agent Message service to release tasks which are on hold due to capacity constraints or non availability of inventory.</p> <p>– Invokes the PrintTaskSheets service for printing the task sheets.</p> <p>On Task Progress – Invokes the Enqueue Release Task Agent Message service to release tasks which are on hold due to capacity constraints or non availability of inventory.</p> <p>Tasks Released – Invokes Print Batch Sheet On Task Release service for printing the batch sheet.</p>
Templates	<p>Default settings are provided for:</p> <p>Log Exception – Logs the reasons due to which a count request could not be created for a Count Program.</p> <p>Publish Data – Sends data to external queue or internal tables.</p> <p>Raise Exception – Raises an alert using Event Management from the published information.</p> <p>Send Email – Raises an email action to create an email in the template format from the published information.</p> <p>Send Email-HTML format – Raises an email action to create an email in HTML format from the published information.</p>

16.6.4 Service Definitions

Service definitions are a representation of the logic that regulates document workflow services. The Service Builder is a graphical user interface that enables you to create a graphical representation of these *services*.

For more information about Service Definitions, see the *Selling and Fulfillment Foundation: Application Platform Configuration Guide*.

To view the service definition repository details for Resource Planning:

1. From the tree in the application rules side panel, choose Process Modeling > General > Resource Planning. The Resource Planning Repository window displays.
2. The Transactions tab window displays.
3. In the Resource Planning window, choose .
4. The Service Definitions tab window displays.

For more information about creating and modifying Service Definitions, see the *Selling and Fulfillment Foundation: Application Platform Configuration Guide*.

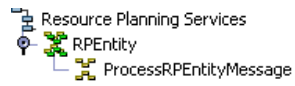

Table 16–12 Resource Planning - Service Definitions Tab Window

Field	Description
RPEntity	
ProcessRPEntityMessage	<p>This service calls the changeShipment API to change shipment attributes.</p> <p>To implement the resource planning move, configure the following JMS properties in the <code>yfs.properties_wms_ext.in</code> file:</p> <pre>yfs.wms.resourceplanning.QueueName=DefaultAgentQueue yfs.wms.resourceplanning.ProviderURL=t3://localhost:7001 yfs.wms.resourceplanning.QCFLookUp=AGENT_QCF</pre>

Time-Triggered Transaction Reference

The Sterling WMS provides a collection of time-triggered transactions, which are utilities that perform a variety of individual functions, automatically and at specific time intervals.

Time-triggered transactions perform repetitive actions on a scheduled basis, typically performing database updates, raising events, or calling APIs. In one type of transaction, monitors are designed to watch for processes or circumstances that are out of bounds and then raise alerts. Often, but not always, they retrieve tasks from the task queue or work off the pipeline.

Some transactions enable you to collect statistical data regarding the application's health. This data is collected periodically, using the value specified for the `yantra.statistics.persist.interval` attribute in the `yfs.properties` file. By default, statistics collection set to "on."

For more information about statistics persistence, see the *Selling and Fulfillment Foundation: Performance Management Guide*. For more information about the specific statistics parameters used, see the applicable time-triggered transactions.

The time-triggered transactions described in this appendix are unique transactions, that may or may not be document type specific. For document specific transactions, the nomenclature helps define which unique transaction it is based on: a transaction ID is in the format `Unique_Transaction_ID.Document_Type_Code`. For example, the transaction ID for Purge Return is `PURGE.0003`, indicating that it is based on the unique transaction `PURGE`, for document type `0003`, which is Return Order. Therefore, in order to be able to configure Purge Return, you should look for the `PURGE` transaction ID in this appendix, which is Order Purge.

Selling and Fulfillment Foundation provides the following types of time-triggered transactions:

- [Business Process Time-Triggered Transactions](#) - responsible for processing
- [Purge Time-Triggered Transactions](#) - clear out data that may be discarded after having been processed

A.1 Running Time-Triggered Transactions

All time-triggered transactions can run on multiple threads. This means that you can run multiple instances of a transaction within a single process. For information about running time-triggered transactions, see the *Selling and Fulfillment Foundation: Installation Guide*. For information about fine-tuning system performance while running them concurrently, see the *Selling and Fulfillment Foundation: Performance Management Guide*.

A.2 Business Process Time-Triggered Transactions

This section provides an alphabetical list of all business process transactions.

The business process time-triggered transactions are:

- [Accept Wave](#)
- [Allocate Task](#)
- [Assign Lane](#)
- [Auto Accept Variance](#)
- [Containerize Wave](#)
- [Create Batch](#)
- [Create Count Task](#)
- [Create Third Count Task](#)
- [Create Variance Task](#)
- [Create Wave](#)

- Create Wave For a Shipment Group
- Execute Count Program
- Location Inventory Monitor
- Mine Productivity
- Print Wave
- Release Task
- Release Wave
- Reopen Task
- Request Batch Completion
- Cancel Wave
- Cancel Move
- Re-Calculate Location Dimensions
- PopulateOwnershipTransferSummary

A.2.1 Accept Wave

This time-triggered transaction is used to accept waves. If this transaction is called for a node, all of the shipment groups belonging to the node are processed.

Attributes

The following are the attributes for this time-triggered transaction:

Table A-1 Accept Wave Attributes

Attribute	Value
Transaction Name	Accept Wave
Transaction ID	ACCEPT_WAVE.4001
Base Process Type	Outbound Picking
Base Document Type	Outbound Picking
Abstract Transaction	No

Table A–1 Accept Wave Attributes

Attribute	Value
APIs Called	None
User Exits Called	None

Criteria Parameters

The following are the criteria parameters for this transaction:

Table A–2 Accept Wave Criteria Parameters

Parameter	Description
Action	Required. Triggers the transaction. If left blank, it defaults to Get, the only valid value.
Number of Records To Buffer	Optional. Number of records to retrieve and process at one time. If left blank or specified as 0 (zero), it defaults to 5000.
Node	Required. The warehouse management ship node for which records are being processed.
ShipmentGroupId	Optional. If passed, waves are accepted only for the specified 'ShipmentGroupId'.
AgentCriteriaGroup	Optional. Used to classify nodes. This value can be accepted by WMS time-triggered transactions that only perform their tasks on the nodes with a matching node transactional velocity value. Valid values are: LOW, HIGH, and any additional values defined by the Hub from Application Platform > System Administration > Agent Criteria Groups.
ColonyID	Required in a multischema deployment where a table may exist in multiple schemas. Runs the agent for the colony.

Statistics Tracked

The following statistics are tracked for this transaction:

Table A–3 Accept Wave Statistics

Statistic Name	Description
NumWavesAccepted	Number of waves accepted.

Pending Job Count

For this transaction the pending job count is the number of records available to be processed by the transaction with the AVAILABLE_DATE value less than or equal to (<=) the current date value in the YFS_Task_Q table.

Events Raised

The following events are raised by this time-triggered transaction:

Table A–4 Events Raised by the Accept Wave Transaction

Transaction/Event	Key Data	Data Published	Template Support?
ON_SUCCESS	wave_dbd.txt	WMS_ACCEPT_WAVE.ON_SUCCESS.xml	Yes

A.2.2 Allocate Task

To create tasks as Draft, set the flag "Delayed Inventory Allocation Support" at the node level to "Y". This flag is available in the "Wave Release Schedule" for pick planning.

Selling and Fulfillment Foundation provides draft status support for outbound picking, retrieval, and putaway tasks. When tasks are created in large numbers as a part of wave or move request release, locks are held for longer durations (for creating all tasks). In such situations, Sterling Commerce recommends that you enable the draft status support to allocate tasks in a multi-threaded fashion by the Allocate Task agent. This reduces the lock holding time.

Attributes

The following are the attributes for this time-triggered transaction:

Table A-5 Allocate Task Attributes

Attribute	Value
Transaction Name	Allocate Task
Transaction ID	ALLOCATE_TASK
Base Process Type	Task Execution
Base Document Type	Task Execution
Abstract Transaction	No
APIs Called	None
User Exits Called	None

Criteria Parameters

Note:

- When configuring criteria, ensure that there are at least two threads configured for each criteria.
- Sterling Commerce recommends that you have some threads of this agent in the same agent server as the one running the ReleaseWave agent. This is to prevent the wave release from waiting for tasks to be allocated by another agent server resulting in redundancy in the same agent server.
- Configure the Allocate Task agent to automatically get triggered every 5 or 10 minutes.

The following are the criteria parameters for this transaction:

Table A–6 Allocate Task Criteria Parameters

Parameter	Description
Action	Required. Triggers the transaction. If left blank, it defaults to Get, the only valid value.
Number of Records To Buffer	Optional. Number of records to retrieve and process at one time. If left blank or specified as 0 (zero), it defaults to 5000.
ColonyID	Required in a multischema deployment where a table may exist in multiple schemas. Runs the agent for the colony.

Events Raised

The following events are raised by this time-triggered transaction:

Table A–7 Events Raised by the Allocate Task Transaction

Transaction/Event	Key Data	Data Published	Template Support?
ALLOCATE_TASK / CHILD_ALLOCATION_COMPLETE	task_dbd.txt	ALLOCATE_TASK.ON_CHILD_ALLOCATION_COMPLETE.xml	Yes

Note: The `ALLOCATE_TASK.ON_CHILD_ALLOCATION_COMPLETE` event publishes information of the summary task for which allocation of all child tasks is complete. Use this event to print batch sheets or task lists for picking against move requests. Otherwise, if you do not use the draft status feature, the batch sheets of task lists would be printed on the `RELEASE_MOVE_REQUEST.ON_SUCCESS` event.

Define a custom service which does the following:

1. Calls the `getTaskDetails` API.
2. Using an XSL, prepares input to `getMoveRequestDetails` API by extracting `MoveRequestKey` from the `TaskReferences` node.
3. Calls the `getMoveRequestDetails` API and connect the output to the `PrintMoveTickets` service (provided out-of-the-box).

A.2.3 Assign Lane

This Task Q based time-triggered transaction is used to assign lanes. This time-triggered transaction should be used in scenarios where we need to balance the load on the lanes by distributing the shipments across the various lanes that are available for use.

The Assign Lane time-triggered transaction works off a Wave, and assigns lanes to all shipments in the Wave that have not yet been assigned a lane. Depending on the configuration, it assigns lanes based on `SortByShipment` and `SortByCarrier`.

If any dedicated lanes have been configured, then this time-triggered transaction assigns the dedicated lanes to the shipments that satisfy the criteria configured for the dedicated locations. After assigning the dedicated lanes, if there are still shipments which do not have any lanes assigned, then these shipments are assigned to any non-dedicated locations in a round-robin fashion.

Attributes

The following are the attributes for this time-triggered transaction:

Table A–8 Assign Lane Attributes

Attribute	Value
Transaction Name	Assign Lanes
Transaction ID	ASSIGN_LANE.4001
Base Process Type	Outbound Picking
Base Document Type	Outbound Picking
Abstract Transaction	No
APIs Called	None
User Exits Called	com.yantra.wms.japi.ue.WMSOverrideAssignLaneUE

Criteria Parameters

The following are the criteria parameters for this transaction:

Table A–9 Assign Lane Criteria Parameters

Parameter	Description
Action	Required. Triggers the transaction. If left blank, it defaults to Get, the only valid value.
Number of Records To Buffer	Optional. Number of records to retrieve and process at one time. If left blank or specified as 0 (zero), it defaults to 5000.
Next Task Queue Interval	Optional. Specifies in hours how long a failed task should be suspended before it is considered for reprocessing. Defaults to 5 hours.
Node	Required. The warehouse management ship node for which records are being processed.

Table A–9 Assign Lane Criteria Parameters

Parameter	Description
AgentCriteriaGroup	Optional. Used to classify nodes. This value can be accepted by WMS time-triggered transactions that only perform their tasks on the nodes with a matching node transactional velocity value. Valid values are: LOW, HIGH, and any additional values defined by the Hub from Application Platform > System Administration > Agent Criteria Groups.
ColonyID	Required in a multischema deployment where a table may exist in multiple schemas. Runs the agent for the colony.

Statistics Tracked

The following statistics are tracked for this transaction:

Table A–10 Assign Lane Statistics

Statistic Name	Description
NumShipments	Number of shipments for which lanes have been assigned.

Pending Job Count

For this transaction the pending job count is the number of records available to be processed by the transaction with the AVAILABLE_DATE value less than or equal to (<=) the current date value in the YFS_Task_Q table.

Events Raised

The following events are raised by this time-triggered transaction:

Table A–11 Events Raised by the Assign Lane Transaction

Transaction/Event	Key Data	Data Published	Template Support?
ON_SUCCESS	wave_dbd.txt	WMS_ASSIGN_LANE.ON_SUCCESS.xml	Yes
HAS_EXCEPTIONS		WMS_ASSIGN_LANE.HAS_EXCEPTIONS.xml	Yes

A.2.4 Auto Accept Variance

Auto Accept Variance is a time-triggered transaction that is called to automatically accept variance obtained from the results of a count request. This transaction runs off Task Q. The Task Q uses CountRequestKey as Data key. Once CountRequestKey is obtained, the transaction resolves the variances for this count request.

Depending on the Variance Quantity, inventory is either increased or decreased in the system to match up with physical inventory. Audits are written for the inventory adjustments performed during auto acceptance of variance.

Attributes

The following are the attributes for this time-triggered transaction:

Table A–12 Auto Accept Variance Attributes

Attribute	Value
Base Transaction ID	AUTO_ACCEPT_VARIANCE
Base Document Type	Count
Base Process Type	Count Execution
Abstract Transaction	No
APIs Called	None
User Exits Called	None

Criteria Parameters

The following are the criteria parameters for this transaction:

Table A-13 Auto Accept Variance Parameters

Parameter	Description
Action	Required. Triggers the transaction. If left blank, it defaults to Get, the only valid value.
Number of Records To Buffer	Optional. Number of records to retrieve and process at one time. If left blank or specified as 0 (zero), it defaults to 5000.
ReasonCode	Optional. The reason code is mandatory for accepting variance and adjusting inventory. Reason codes are associated to unique accounting bin location. When inventory adjustment happens in a location, corresponding bin adjustments also happen.
ReasonText	Optional. The Reason Text is provided to give purpose the inventory is adjustment. Some of the reasons are like Theft/Damage etc. The system does not perform any validations for the reason text. Whatever the user provides is updated.
ColonyID	Required in a multischema deployment where a table may exist in multiple schemas. Runs the agent for the colony.

Statistics Tracked

The following statistics are tracked for this transaction:

Table A-14 Auto Accept Variance Statistics

Statistic Name	Description
NumCountRequestsForWhich VarianceAccepted	Statistics for number of count requests for which variance has been accepted.

Pending Job Count

For this transaction the pending job count is the number of records available to be processed by the transaction with the AVAILABLE_DATE

value less than or equal to (<=) the current date value in the YFS_Task_Q table.

Events Raised

The following events are raised by this time-triggered transaction:

Table A-15 Events Raised by the Auto Accept Variance Transaction

Transaction/Event	Key Data	Data Published	Template Support?
ON_SUCCESS	count_dbd.txt	WMS_AUTO_ACCEPT_VARIANCE.ON_SUCCESS.xml	Yes

A.2.5 Containerize Wave

Containerize Wave is a time-triggered transaction which can be invoked to containerize a shipment, batch, or inventory pallet id.

This time-triggered transaction is used to generate the outbound containers used for packing, both for 'pack while pick' and 'pack after pick' processes. The Task Type and Pack Strategy settings define whether the packing is done during picking, or after picking.

Attributes

The following are the attributes for this time-triggered transaction:

Table A-16 Containerize Wave Attributes

Attribute	Value
Transaction Name	Containerize Wave
Transaction ID	CONTAINERIZE_WAVE
Base Process Type	Outbound Picking
Base Document Type	Outbound Picking
Abstract Transaction	No

Table A–16 Containerize Wave Attributes

Attribute	Value
APIs Called	PostPickContainerization
User Exits Called	com.yantra.wms.japi.ue.WMSCircumventLooseContainerizationUE com.yantra.wms.japi.ue.WMSOverrideSuggestedContainerListUE

Criteria Parameters

The following are the criteria parameters for this transaction:

Table A–17 Containerize Wave Criteria Parameters

Parameter	Description
Action	Required. Triggers the transaction. If left blank, it defaults to Get, the only valid value.
Number of Records To Buffer	Optional. Number of records to retrieve and process at one time. If left blank or specified as 0 (zero), it defaults to 5000.
Node	Required. The warehouse management ship node for which records are being processed.
Next Task Queue Interval	Optional. Specifies in hours how long a failed task should be suspended before it is considered for reprocessing. Defaults to 5 hours.
AgentCriteriaGroup	Optional. Used to classify nodes. This value can be accepted by WMS time-triggered transactions that only perform their tasks on the nodes with a matching node transactional velocity value. Valid values are: LOW, HIGH, and any additional values defined by the Hub from Application Platform > System Administration > Agent Criteria Groups.
ColonyID	Required in a multischema deployment where a table may exist in multiple schemas. Runs the agent for the colony.

Statistics Tracked

The following statistics are tracked for this transaction:

Table A–18 Containerize Wave Status Statistics

Statistic Name	Description
NumWavesContainerized	Number of waves containerized.
NumContainersCreated	Number of containers created.

Pending Job Count

For this transaction the pending job count is the number of records available to be processed by the transaction with the AVAILABLE_DATE value less than or equal to (<=) the current date value in the YFS_Task_Q table.

Events Raised

The following events are raised by this time-triggered transaction:

Table A–19 Events Raised by the Containerize Wave Transaction

Transaction/Event	Key Data	Data Published	Template Support?
ON_SUCCESS	wave_dbd.txt	WMS_CONTAINERIZE_WAVE.ON_SUCCESS.xml	Yes
HAS_EXCEPTIONS	wave_dbd.txt	WMS_CONTAINERIZE_WAVE.HAS_EXCEPTIONS.xml	Yes

A.2.6 Create Batch

Create Batch is a time-triggered transaction that creates batches for a given wave.

Attributes

The following are the attributes for this time-triggered transaction:

Table A–20 Create Batches Attributes

Attribute	Value
Transaction Name	Create Batches
Transaction ID	BATCH_WAVE.4001
Base Document Type	Outbound Picking
Base Process Type	Outbound Picking
Abstract Transaction	No
APIs Called	None
User Exits Called	None

Criteria Parameters

The following are the criteria parameters for this transaction:

Table A–21 Create Batches Criteria Parameters

Parameter	Description
Action	Required. Triggers the transaction. If left blank, it defaults to Get, the only valid value.
Number of Records To Buffer	Optional. Number of records to retrieve and process at one time. If left blank or specified as 0 (zero), it defaults to 5000.
Next Task Queue Interval	Optional. Specifies in hours how long a failed task should be suspended before it is considered for reprocessing. Defaults to 5 hours.
Node	Required. The warehouse management ship node for which records are being processed.

Table A–21 Create Batches Criteria Parameters

Parameter	Description
AgentCriteriaGroup	Optional. Used to classify nodes. This value can be accepted by WMS time-triggered transactions that only perform their tasks on the nodes with a matching node transactional velocity value. Valid values are: LOW, HIGH, and any additional values defined by the Hub from Application Platform > System Administration > Agent Criteria Groups.
ColonyID	Required in a multischema deployment where a table may exist in multiple schemas. Runs the agent for the colony.

Statistics Tracked

The following statistics are tracked for this transaction:

Table A–22 Create Batches Statistics

Statistic Name	Description
NumberOfBatchesCreated	Number of batches created.
NumberOfTasksBatched	Number of tasks batched.

Pending Job Count

For this transaction the pending job count is the number of records available to be processed by the transaction with the AVAILABLE_DATE value less than or equal to (<=) the current date value in the YFS_Task_Q table.

Events Raised

ON_SUCCESS.

Table A–23 Events Raised by the Create Batch Transaction

Transaction/Event	Key Data	Data Published	Template Support?
ON_SUCCESS	wave_dbd.txt	WMS_BATCH_WAVE.ON_SUCCESS.xml	Yes

A.2.7 Create Count Task

Create Count Task is a time-triggered transaction that is called to create tasks for a given count request. Tasks are created based on the count request criteria. A summary task is created for the count request criteria, and tasks are created with summary task as parent task. The transaction runs off Task Q.

The count request attributes are used to determine the task type from the Count Strategy, by using the best match algorithm.

A count task is created at a location level for the count request criteria. Additional attributes including specific item or pallet or case LPN may also be specified.

Attributes

The following are the attributes for this time-triggered transaction:

Table A–24 Create Count Task Attributes

Attribute	Value
Transaction Name	Create Count Tasks
Transaction ID	CREATE_COUNT_TASKS
Base Document Type	Count
Base Process Type	Count Execution
Abstract Transaction	No
APIs Called	createCountRequest ()
User Exits Called	None

Criteria Parameters

The following are the criteria parameters for this transaction:

Table A–25 Create Count Task Criteria Parameters

Parameter	Description
Action	Required. Triggers the transaction. If left blank, it defaults to Get, the only valid value.
Number of Records To Buffer	Optional. Number of records to retrieve and process at one time. If left blank or specified as 0 (zero), it defaults to 5000.
TaskGranularity	Required. Granularity for which the Create Count Task needs to be run. The valid values are REQUEST or VARIANCE. Typically, this is set to REQUEST for first count, and VARIANCE for the successive counts.
TaskGenerationLevel	Required. Generation Level for which the Create Count Task needs to be run. The valid values are ALL_LOCATIONS and LOCATIONS_WITH_VARIANCE. Typically, this is set to ALL_LOCATIONS for first count, and LOCATIONS_WITH_VARIANCE for successive counts.
Node	Required. The warehouse management ship node for which records are being processed.
Next Task Queue Interval	Optional. Specifies in hours how long a failed task should be suspended before it is considered for reprocessing. Defaults to 5 hours.

Table A–25 Create Count Task Criteria Parameters

Parameter	Description
AgentCriteriaGroup	Optional. Used to classify nodes. This value can be accepted by WMS time-triggered transactions that only perform their tasks on the nodes with a matching node transactional velocity value. Valid values are: LOW, HIGH, and any additional values defined by the Hub from Application Platform > System Administration > Agent Criteria Groups.
ColonyID	Required in a multischema deployment where a table may exist in multiple schemas. Runs the agent for the colony.

Note: There are no separate Time-triggered Transactions for Create Third Count Task and Create Variance Task.

The Third Count Task and Variance Task is based on Create Count Task Time-Triggered Transaction.

Typically for a Third Count Task or Variance Task, the TaskGranularity is set to VARIANCE, while the TaskGenerationLevel is set to LOCATIONS_WITH_VARIANCE.

Statistics Tracked

The following statistics are tracked for this transaction:

Table A–26 Create Count Task Statistics

Statistic Name	Description
NumCountTasksCreated	Number of count tasks created.

Pending Job Count

For this transaction the pending job count is the number of records available to be processed by the transaction with the AVAILABLE_DATE

value less than or equal to (<=) the current date value in the YFS_Task_Q table.

Events Raised

The following events are raised by this time-triggered transaction:

Table A–27 Events Raised by the Execute Count Program Transaction

Transaction/Event	Key Data	Data Published	Template Support?
NO_REQUESTS_CREATED	count_dbd.txt	WMS_CREATE_COUNT_TASK.NO_REQUEST_CREATED.xml	Yes
ON_SUCCESS	count_dbd.txt	WMS_CREATE_COUNT_TASK.ON_SUCCESS.xml	Yes

A.2.8 Create Count Request For Location Range

Create Count Request For Location Range is a time-triggered transaction that is called to create count requests for a given location range. Requests are created based on the location range criteria.

The CreateCountRequestForLocationRange synchronous service will send a message that contains the criteria entered by a user, to the JMS queue.

This transaction will listen to the JMS queue for messages. The user needs to run the agent server that is associated with the criteria ID.

Attributes

The following are the attributes for this time-triggered transaction:

Table A–28 Create Count Request For Location Range Attributes

Attribute	Value
Transaction Name	Create Count Request For Location Range
Transaction ID	CREATE_REQ_FOR_LOCN_RANGE
Base Document Type	Count

Table A–28 Create Count Request For Location Range Attributes

Attribute	Value
Base Process Type	Count Execution
Abstract Transaction	No
APIs Called	<code>createCountRequest ()</code>
User Exits Called	None

Criteria Parameters

The following are the criteria parameters for this transaction:

Table A–29 Create Count Request For Location Range Parameters

Parameter	Description
Action	Required. Triggers the transaction. If left blank, it defaults to Get, the only valid value.
Enterprise Code	Enterprise for which the count requests need to be created.
Finish No Later Than	The date and the time by which a task should finish. This timestamp is stamped on each task.
From Location	The location from which the count requests need to be created.
Number of Records To Buffer	Optional. Number of records to retrieve and process at one time. If left blank or specified as 0 (zero), it defaults to 5000.
Priority	The priority of the count requests generated.
Request Type	Defines the count strategy for different request types.
Requesting User ID	ID of the user requesting the count
Start No Earlier Than	The date and the time after which a task should start. This timestamp is stamped on each task.
To Location	The location to which the count requests need to be created.

Table A–29 Create Count Request For Location Range Parameters

Parameter	Description
ColonyID	Required in a multischema deployment where a table may exist in multiple schemas. Runs the agent for the colony.
Aisle Number	The Aisle number for which the count requests need to be created.
Bay Number	The Bay number for which the count requests need to be created.
Level Number	The Level number for which the count requests need to be created.

Events Raised

The following event is raised by this time-triggered transaction:

Table A–30 Event Raised by the Create Count Request For Location Range

Transaction/Event	Key Data	Data Published	Template Support?
LOCATIONS_PROCESSED	None	Agent Criteria	No
NO_COUNT_REQ_CREATED	None	Agent Criteria	No

A.2.9 Create Third Count Task

There is no separate Time-triggered Transaction for Create Third Count Task. Create Third Count Task is based on Create Count Task Time-Triggered Transaction.

Typically for a Create Third Count Task, the TaskGranularity is set to VARIANCE, while the TaskGenerationLevel is set to LOCATIONS_WITH_VARIANCE.

For more information, see For more information, see [Section A.2.7, "Create Count Task"](#) on page 1062.

A.2.10 Create Variance Task

There is no separate Time-triggered Transaction for Create Variance Task, and Create Variance Task is based on Create Count Task Time-Triggered Transaction.

Typically for a Variance Task, the TaskGranularity is set to VARIANCE, while the TaskGenerationLevel is set to LOCATIONS_WITH_VARIANCE.

For more information, see [Section A.2.7, "Create Count Task"](#) on page 1062.

A.2.11 Create Wave

This time-triggered transaction is used to create waves. If this transaction is called for a node, all of the shipment groups belonging to the node are processed.

Note: The Create Wave Agent should be externally-triggered at pre-defined times, instead of setting it up as self-triggered.

Create Wave Agent works off a bunch of shipments that are sent to node and creates waves. This agent involves optimization logic. If set as self-triggered, it creates waves even when there are only a handful of shipments sent to node. This results in either very small waves (if configured to automatically accept all the waves) or the agent processing the same shipment repeatedly, and thus wasting machine resources (if configured not to automatically accept all the waves).

The `yfs.solver.iterations.wavecreate` property in the `yfs.properties_wms_ext.in` file is used to define the number of solver iterations for the Create Wave transaction. This setting is used to optimize the wave creation.

The default out-of-the-box shipped property in the `yfs.properties_wms_ext.in` file is: `yfs.solver.iterations.wavecreate = 1`

A wave is created for a shipment group using the following logic:

- Shipments that are not assigned to a shipment group are identified.
- Shipments are assigned to the applicable shipment groups.
- Open waves (waves not yet 'Accepted') for the shipment groups assigned to the shipments are identified. Shipments belonging to these waves are also available to Create Wave time-triggered transaction.
- For each shipment group, process the available shipments applying the wave size constraints specified for the node as well as for the shipment group.
- Waves are created and the wave number stamped on the shipment lines.

Note: In the case of logical kits, the wave number is stamped on the kit components. Therefore, wave release logic only creates pick tasks for the components

Attributes

The following are the attributes for this time-triggered transaction:

Table A-31 Create Wave Attributes

Attribute	Value
Transaction Name	Create Wave
Transaction ID	CREATE_WAVE.4001
Base Process Type	Outbound Picking
Base Document Type	Outbound Picking
Abstract Transaction	No
APIs Called	manageWave ()
User Exits Called	com.yantra.wms.japi.ue.WMSBeforeCreateWaveUE com.yantra.wms.japi.ue.WMSOverrideShipmentGroupUE

Criteria Parameters

The following are the criteria parameters for this transaction:

Table A–32 Create Wave Criteria Parameters

Parameter	Description
Action	Required. Triggers the transaction. If left blank, it defaults to Get, the only valid value.
Number of Records To Buffer	Optional. Number of records to retrieve and process at one time. If left blank or specified as 0 (zero), it defaults to 5000.
Node	Required. The warehouse management ship node for which records are being processed.
ShipmentGroupId	Optional. If passed, waves are created only for the specified 'ShipmentGroupId'.
AgentCriteriaGroup	Optional. Used to classify nodes. This value can be accepted by WMS time-triggered transactions that only perform their tasks on the nodes with a matching node transactional velocity value. Valid values are: LOW, HIGH, and any additional values defined by the Hub from Application Platform > System Administration > Agent Criteria Groups.
SilentPeriod	Optional. The amount of time (in minutes) the Create Wave Agent waits before attempting wave creation after a shipment is sent to node.
MaxIterations	Optional. The maximum number of times the Create Wave Agent is in SilentPeriod before attempting wave creation.

Table A–32 Create Wave Criteria Parameters

Parameter	Description
RedetermineShipment Group	<p>Optional. Valid values are "Y" and "N". If left blank, this value defaults to Y.</p> <ul style="list-style-type: none"> Y - Based on the ForShipmentsModifiedBefore parameter, all shipments that are in the "Sent To Node" status are considered for shipment group redetermination. N - The system does not redetermine the shipment group for any shipment.
ForShipmentsModified Before	<p>Optional. Enter the time (in hours) before which the shipments that are in the "Sent To Node" status must be modified for shipment group redetermination.</p> <p>You can also enter a fractional value. If left blank, this value defaults to 0 (zero) hours.</p>
ColonyID	<p>Required in a multischema deployment where a table may exist in multiple schemas. Runs the agent for the colony.</p>

Statistics Tracked

The following statistics are tracked for this transaction:

Table A–33 Create Wave Statistics

Parameter	Description
NumberOfWavesCreated	Number of waves created.
NumberOfWavesDeleted	Number of waves deleted. Waves that are in created status can be deleted and recreated if there are more shipments for that shipment group.
NumberOfShipmentLinesAssignedWaves	Number of shipment lines which have been included in the created waves.
NumberOfShipmentLinesReassignedWaves	Number of Shipment Lines which need to be reassigned to different waves.

Pending Job Count

For this transaction the pending job count is the number of nodes for which waves have to be processed.

Events Raised

This transaction raises events as specified under the `manageWave()` API in the *Selling and Fulfillment Foundation: Javadocs*.

A.2.12 Create Wave For a Shipment Group

This time-triggered transaction is used to create waves for a shipment group. This is similar to the Create Wave time-triggered transaction, except that this transaction is Task Q based and called for a specific Task Q Request.

Attributes

The following are the attributes for this time-triggered transaction:

Table A–34 Create Wave For a Shipment Group Attributes

Attribute	Value
Transaction Name	Create Wave For a Shipment Group
Transaction ID	CREATE_WAVE_FOR_SHIPMENT_GROUP
Base Process Type	Outbound Picking
Base Document Type	Outbound Picking
Abstract Transaction	No
APIs Called	<code>manageWave()</code>
User Exits Called	<code>com.yantra.wms.japi.ue.WMSBeforeCreateWaveUE</code> <code>com.yantra.wms.japi.ue.WMSOverrideShipmentGroupUE</code>

Criteria Parameters

The following are the criteria parameters for this transaction:

Table A–35 Create Wave For a Shipment Group Criteria Parameters

Parameter	Description
Action	Required. Triggers the transaction. If left blank, it defaults to Get, the only valid value.
Number of Records To Buffer	Optional. Number of records to retrieve and process at one time. If left blank or specified as 0 (zero), it defaults to 5000.
Next Task Q Interval	Optional. Specifies in hours how long a failed task should be suspended before it is considered for reprocessing. Defaults to 5 hours.
Node	Required. The warehouse management ship node for which records are being processed.
AgentCriteriaGroup	Optional. Used to classify nodes. This value can be accepted by WMS time-triggered transactions that only perform their tasks on the nodes with a matching node transactional velocity value. Valid values are: LOW, HIGH, and any additional values defined by the Hub from Application Platform > System Administration > Agent Criteria Groups.
RedetermineShipmentGroup	Optional. Valid values are "Y" and "N". If left blank, this value defaults to Y. <ul style="list-style-type: none"> • Y - Based on the ForShipmentsModifiedBefore parameter, all shipments that are in the "Sent To Node" status are considered for shipment group redetermination. • N - The system does not redetermine the shipment group for any shipment.

Table A–35 Create Wave For a Shipment Group Criteria Parameters

Parameter	Description
ForShipmentsModifiedBefore	Optional. Enter the time (in hours) before which the shipments that are in the "Sent To Node" status must be modified for shipment group redetermination. You can also enter a fractional value. If left blank, this value defaults to 0 (zero) hours.
ColonyID	Required in a multischema deployment where a table may exist in multiple schemas. Runs the agent for the colony.

Statistics Tracked

The following statistics are tracked for this transaction:

Table A–36 Create Wave For a Shipment Group Statistics

Parameter	Description
NumberOfWavesCreated	Number of waves created.
NumberOfWavesDeleted	Number of waves deleted. Waves that are in created status can be deleted and recreated if there are more shipments for that shipment group.
NumberOfShipmentLinesAssignedWaves	Number of shipment lines assigned waves.
NumberOfShipmentLinesReassignedWaves	Number of shipment lines belonging to deleted waves.

Pending Job Count

For this transaction the pending job count is the number of records available to be processed by the transaction with the AVAILABLE_DATE value less than or equal to (<=) the current date value in the YFS_Task_Q table.

Events Raised

This transaction raises events specified by the `manageWave()` API in the *Selling and Fulfillment Foundation: Javadocs*.

A.2.13 Execute Count Program

Execute Count Program is a time-triggered transaction that is called to create count requests.

Note: If you run the Execute Count Program time-triggered transaction more than once in a day, the system does not create additional count requests. You can create additional count requests using the Invoke Count Service screen in the Application Consoles. For more information about invoking count service, see the *Sterling Warehouse Management System: User Guide*.

Count Request Generation

You can create count requests at item level, location level and item-classification level.

Cycle count for classifications and performing count at item level

This time-triggered transaction uses the following logic (for each count program condition) to determine the number of count requests that need to be generated for items:

- The time-triggered transaction creates a list of all items that are applicable for the specified classifications. This is filtered to list only those items that satisfy any one of the following conditions:
 - a. The items have inventory.
 - b. The items belong to classifications whose count strategy indicates that these items must be put on count even if there is no inventory.
- The total number of count requests to be generated over the effective period of the count program is projected by multiplying the number of items (ascertained above) with the "times to count" value specified for the count program condition.
- The number of count requests needed to be generated on the day is calculated by dividing the total number of count requests (as calculated above) by the total number of working days left in the effective period of the count program.

- The time-triggered transaction now creates count requests for the required items from the above list of items, sorting items by higher velocity but lesser number of open shipments on that day, and by Item ID. The velocity of an item refers to the number of closed shipments for the item in the last cycle. The time-triggered transaction then picks items from the list that are not counted in the current cycle.

Note: If you have configured to count only a certain percentage of items in the count cycle, the system randomly picks the specified percentage of items to count. When picking the items to count, the system picks 80% of high velocity items and 20% of low velocity items. For example, if you configure to count 70% of total items in a count cycle, 56% of total items to count are high velocity items and 14% are low velocity items.

For example, if you want to count 10 items in a three-day cycle, the first 3 items are counted on the first day, the next 3 items on the second day and the remaining 4 items on the third day.

If you want to count only two items in a three-day cycle, the first item are counted on the first day and the second item on the third day. This count strategy is followed to evenly distribute items that are counted in a cycle.

- If the executeCountProgram agent is run during the shift hours, the StartNoEarlierThan timestamp generated on the count request is the same as the time when the agent was run. If the agent is run before or after the shift hours, then the time is stamped as Next Working Shift. The FinishNoLaterThan timestamp generated on the count request is stamped as end of the current count program cycle.

Cycle count for classifications and performing count at classification level

When a count program specifies that the count should be performed at the classification level, the count request and count tasks are generated for the classifications *per se*, and not for the items. Thus, the count requests are usually not generated daily, but after an interval of days.

While generating count requests, the time-triggered transaction uses the following logic (for each count program condition) to determine if the count request for the classification should be generated on that day:

- The time-triggered transaction verifies whether at least one item for the classification exists in the inventory. If no item is found in the inventory, the time-triggered transaction does not create any count requests for that day, unless the classifications' count strategy indicates that the classification should be put on count even if there is no inventory for them.
- Where at least one item exists in the inventory, the interval between count request generation is projected by dividing the total number of working days left in the effective period of the count program by the number of times still to count (total to count - already counted).
- The time-triggered transaction then checks if the number of working days since the last generation is more than the calculated interval. If yes, it generates a count request for the classification.
- If the executeCountProgram agent is run during the shift hours, the StartNoEarlierThan timestamp generated on the count request is the same as the time when the agent was run. If the agent is run before or after the shift hours, then the time is stamped as Next Working Shift. The FinishNoLaterThan timestamp generated on the count request is stamped as end of the current count program cycle.

Cycle count for classifications and performing count at location level

This time-triggered transaction uses the following logic (for each count program condition) to determine the number of count requests to be generated for locations:

- Based on the conditions configured in the count program, the time-triggered transaction creates a list of all locations that must be counted in the current cycle.
- The system projects the total number of count requests to be generated over the effective period of the count cycle by multiplying the number of locations with the value of number of times to count, which is defined in the count program condition.
- The system calculates the number of count requests that must be generated on a day by dividing the total number of count requests by

the total number of working days left in the effective period of the count program.

- The time-triggered transaction creates count requests for locations specified in the list of locations to count. It then picks up the locations from the list that are not counted in the current cycle.

Note: If you have configured to count only a certain percentage of locations in the count cycle, the system randomly picks the specified percentage of locations to count.

For example, if you want to count 10 locations in a three-day cycle, the first 3 locations are counted on the first day, the next 3 locations are counted on the second day, and the remaining 4 locations on the third day. If you want to count only 2 locations in a three-day cycle, the first 2 locations are counted on the first day and the second location on the third day. This count strategy is followed to evenly distribute locations that are counted in a cycle.

- If the executeCountProgram agent is run during the shift hours, the StartNoEarlierThan timestamp generated on the count request is the same as the time when the agent was run. If the agent is run before or after the shift hours, the time is stamped as Next Working Shift. The FinishNoLaterThan timestamp generated on the count request is stamped as end of the current count program cycle.

Attributes

The following are the attributes for this time-triggered transaction:

Table A–37 *Execute Count-Program Attributes*

Attribute	Value
Transaction Name	Execute Count Program
Transaction ID	EXECUTE_COUNT_PROGRAM
Base Document Type	Count
Base Process Type	Count Execution
Abstract Transaction	No

Table A–37 Execute Count-Program Attributes

Attribute	Value
APIs Called	None
User Exits Called	None

Criteria Parameters

The following are the criteria parameters for this transaction:

Table A–38 Execute Count Program Criteria Parameters

Parameter	Description
Action	Required. Triggers the transaction. If left blank, it defaults to Get, the only valid value.
Number of Records To Buffer	Optional. Number of records to retrieve and process at one time. If left blank or specified as 0 (zero), it defaults to 5000.
AgentCriteriaGroup	Optional. Used to classify nodes. This value can be accepted by WMS time-triggered transactions that only perform their tasks on the nodes with a matching node transactional velocity value. Valid values are: LOW, HIGH, and any additional values defined by the Hub from Application Platform > System Administration > Agent Criteria Groups.
Node	Optional. Node for which the Execute Count Program needs to be run. If not passed, all nodes are monitored.
Enterprise Code	Optional. Enterprise for which the Execute Count Program needs to be run. If not passed, all enterprises are monitored.
CountProgramName	Optional. Count Program Name for which the Execute Count Program needs to be run. If not passed, all count programs are monitored.
ColonyID	Required in a multischema deployment where a table may exist in multiple schemas. Runs the agent for the colony.

Statistics Tracked

The following statistics are tracked for this transaction:

Table A–39 Execute Count-Program Statistics

Statistic Name	Description
NumCountProgramsExecuted	Number of count programs executed.
NumCountRequestsCreated	Number of count requests created for the count program.

Pending Job Count

For this transaction the pending job count is the number of count programs for the node, whose EFFECTIVE_FROM_DATE value less than or equal to (<=) and EFFECTIVE_TO_DATE value greater than or equal to (>=) the current date value.

Events Raised

The following events are raised by this time-triggered transaction:

Table A–40 Events Raised by the Execute Count-Program Transaction

Transaction/Event	Key Data	Data Published	Template Support?
NO_REQUESTS_CREATED	count_dbd.txt	WMS_EXECUTE_COUNT_PROGRAM.NO_REQUEST_CREATED.xml	Yes
ON_SUCCESS	count_dbd.txt	WMS_EXECUTE_COUNT_PROGRAM.ON_SUCCESS.xml	Yes

A.2.14 Location Inventory Monitor

Location Inventory Monitor is the time-triggered transaction that monitors inventory in a location.

Attributes

The following are the attributes for this time-triggered transaction:

Table A–41 Location Inventory Monitor Attributes

Attribute	Value
Base Transaction ID	LOCN_INV_MONITOR
Base Document Type	General
Base Process Type	WMS Inventory
Abstract Transaction	No
APIs Called	None
User Exits Called	None

Criteria Parameters

The following are the criteria parameters for this transaction:

Table A–42 Location Inventory Monitor Criteria Parameters

Parameter	Description
Action	Required. Triggers the transaction. If left blank, it defaults to Get, the only valid value.
Number of Records To Buffer	Optional. Number of records to retrieve and process at one time. If left blank or specified as 0 (zero), it defaults to 5000.
RuleId	Optional. The Location Monitoring Rule ID for which the inventory monitor needs to be run.
Node	Optional. Node for which the Location Inventory Monitor needs to be run. If not passed, then all nodes are monitored.

Table A–42 Location Inventory Monitor Criteria Parameters

Parameter	Description
AgentCriteriaGroup	Optional. Used to classify nodes. This value can be accepted by WMS time-triggered transactions that only perform their tasks on the nodes with a matching node transactional velocity value. Valid values are: LOW, HIGH, and any additional values defined by the Hub from Application Platform > System Administration > Agent Criteria Groups.
ColonyID	Required in a multischema deployment where a table may exist in multiple schemas. Runs the agent for the colony.

Note: While the criteria parameters Node and AgentCriteriaGroup are individually optional fields, both fields cannot be left blank and at least one of them has to be specified.

Statistics Tracked

None.

Events Raised

None.

A.2.15 Mine Productivity

This time-triggered transaction captures the productivity information for all the tasks done within the Sterling Commerce Task Management framework. This information is extracted and consolidated per user. The time-triggered transaction runs at some scheduled intervals, for example as a end-of-day process.

Every individual task in the Sterling WMS captures its start and end time automatically. The time-triggered transaction checks all completed tasks, that have not been mined so far, collecting productivity metrics based on

productivity references relevant for that productivity type. For more information about Productivity Types, see [Section 12.5, "Defining Productivity Types"](#) on page 899.

Attributes

The following are the attributes for this time-triggered transaction:

Table A-43 Mine Productivity Attributes

Attribute	Value
Base Transaction ID	MINE_PRODUCTIVITY
Base Document Type	General
Base Process Type	General
Abstract Transaction	No
APIs Called	None
User Exits Called	None

Criteria Parameters

The following are the criteria parameters for this transaction:

Table A-44 Mine Productivity Criteria Parameters

Parameter	Description
Action	Required. Triggers the transaction. If left blank, it defaults to Get, the only valid value.
Number of Records To Buffer	Optional. Number of records to retrieve and process at one time. If left blank or specified as 0 (zero), it defaults to 5000.
Organization Code	Optional. Organization for which the Mine Productivity needs to be run. If not passed, then all organizations are monitored.
EnterpriseCode	Optional. Enterprise for which the Mine Productivity needs to be run. If not passed, then all enterprises are monitored.

Table A–44 Mine Productivity Criteria Parameters

Parameter	Description
ProductivityType	Optional. Productivity Type for which the Mine Productivity needs to be run. If not passed, then all productivity types are monitored.
UserId	Optional. User for whom the Mine Productivity needs to be run. If not passed, then all users are monitored.
ColonyID	Required in a multischema deployment where a table may exist in multiple schemas. Runs the agent for the colony.

Statistics Tracked

The following statistics are tracked for this transaction:

Table A–45 Mine Productivity Statistics

Statistic Name	Description
NumTasksMined	Number of tasks mined.

Pending Job Count

For this transaction the pending job count is the number of tasks for which productivity is not stamped.

Events Raised

None.

A.2.16 Print Wave

This time-triggered transaction prints the wave.

Attributes

The following are the attributes for this time-triggered transaction:

Table A–46 Print Wave Attributes

Attribute	Value
Transaction Name	Print Wave
Transaction ID	PRINT_WAVE.4001
Base Process Type	Outbound Picking
Base Document Type	Outbound Picking
Abstract Transaction	No
APIs Called	None
User Exits Called	None

Criteria Parameters

The following are the criteria parameters for this transaction:

Table A–47 Print Wave Criteria Parameters

Parameter	Description
Action	Required. Triggers the transaction. If left blank, it defaults to Get, the only valid value.
Number of Records To Buffer	Optional. Number of records to retrieve and process at one time. If left blank or specified as 0 (zero), it defaults to 5000.
Next Task Queue Interval	Optional. Specifies in hours how long a failed task should be suspended before it is considered for reprocessing. Defaults to 5 hours.
Node	Required. The warehouse management ship node for which records are being processed.

Table A-47 Print Wave Criteria Parameters

Parameter	Description
AgentCriteriaGroup	Optional. Used to classify nodes. This value can be accepted by WMS time-triggered transactions that only perform their tasks on the nodes with a matching node transactional velocity value. Valid values are: LOW, HIGH, and any additional values defined by the Hub from Application Platform > System Administration > Agent Criteria Groups.
ColonyID	Required in a multischema deployment where a table may exist in multiple schemas. Runs the agent for the colony.

Statistics Tracked

The following statistics are tracked for this transaction:

Table A-48 Print Wave Statistics

Statistic Name	Description
NumWavesChanged	Number of changed waves.

Pending Job Count

For this transaction the pending job count is the number of records available to be processed by the transaction with the AVAILABLE_DATE value less than or equal to (<=) the current date value in the YFS_Task_Q table.

Events Raised

The following events are raised by this time-triggered transaction:

Table A-49 Events Raised by the Print Wave Transaction

Transaction/Event	Key Data	Data Published	Template Support?
ON_SUCCESS	wave_dbd.txt	WMS_PRINT_WAVE.ON_SUCCESS.xml	Yes

A.2.17 Release Task

This time-triggered transaction releases pick or replenishment tasks that are on hold based on the inventory availability or location capacity.

Note: This transaction can be triggered by the following events:

- IN_PROGRESS_TASK.TASK_IN_PROGRESS
- COMPLETE_TASK.TASK_COMPLETED
- PRINT_WAVE.4001.ON_SUCCESS

The actions are associated to these events. You need to enable these events to trigger this transaction.

Attributes

The following are the attributes for this time-triggered transaction:

Table A-50 Release Task Attributes

Attribute	Value
Transaction Name	Release Task
Transaction ID	RELEASE_TASK
Base Process Type	Task Execution
Base Document Type	Task Execution
Abstract Transaction	None
APIs Called	None
User Exits Called	None

Criteria Parameters

The following are the criteria parameters for this transaction:

Table A-51 Release Task Criteria Parameters

Parameter	Description
Action	Optional. Triggers the transaction. If left blank, it defaults to Get, the only valid value.
OrganizationCode	Required. The warehouse management ship node for which records are being processed.
AgentCriteriaGroup	Optional. Used to classify nodes. This value can be accepted by the Sterling Warehouse Management System time-triggered transactions that only perform their tasks on the nodes with a matching node transactional velocity value. Valid values are LOW, HIGH, and any additional values defined by the Hub from Application Platform > System Administration > Agent Criteria Groups.
ColonyID	Required in a multischema deployment where a table may exist in multiple schemas. Runs the agent for the colony.

Statistics Tracked

None.

Pending Job Count

For this transaction, the pending job count is the number of task records (Incoming Replenishment/ SecondstepPutaway with Task_Status='1400') and (Outgoing Outbound Picking with Task_Status='1400') that are to be opened.

Events Raised

The following events are raised by this time-triggered transaction:

Table A–52 Events Raised by the Release Task Transaction

Transaction/Event	Key Data	Data Published	Template Support?
RELEASE_TASK/HAS_EXCEPTIONS		WMS_RELEASE_TASK.HAS_EXCEPTIONS.xml	Yes
RELEASE_TASK/TASKS_RELEASED	task_dbd.txt	WMS_RELEASE_TASK.TASKS_RELEASED.xml	Yes

A.2.18 Release Wave

This is a Task Q based time-triggered transaction, which works off a wave. It creates pick tasks for the shipment lines included in the wave.

This time-triggered transaction should be used to release a wave.

In the `yfs.properties_wms_ext.in` file, use the `yfs.releaseWave.pickalgorithm` property to select the algorithm to use to determine pick locations for the release wave transaction. For more information about the algorithms supported by the Sterling Warehouse Management System, see [Section 7.2.1.4, "Algorithms Used to Determine Pick Locations"](#).

In the `yfs.properties_wms_ext.in` file, the value of the `yfs.releaseWave.pickalgorithm` property provided out-of-the-box is set to blank.

Attributes

The following are the attributes for this time-triggered transaction:

Table A–53 Release Wave Attributes

Attribute	Value
Transaction Name	Release Wave
Transaction ID	RELEASE_WAVE.4001
Base Process Type	Outbound Picking
Base Document Type	Outbound Picking
Abstract Transaction	No

Table A–53 Release Wave Attributes

Attribute	Value
APIs Called	releaseWave()
User Exits Called	com.yantra.wms.japi.ue.WMSOverridePickLocationAssignmentUE

Criteria Parameters

The following are the criteria parameters for this transaction:

Table A–54 Release Wave Criteria Parameters

Parameter	Description
Action	Required. Triggers the transaction. If left blank, it defaults to Get, the only valid value.
Number of Records To Buffer	Optional. Number of records to retrieve and process at one time. If left blank or specified as 0 (zero), it defaults to 5000.
Next Task Queue Interval	Optional. Specifies in hours how long a failed task should be suspended before it is considered for reprocessing. Defaults to 5 hours.
Node	Required. The warehouse management ship node for which records are being processed.
AgentCriteriaGroup	Optional. Used to classify nodes. This value can be accepted by WMS time-triggered transactions that only perform their tasks on the nodes with a matching node transactional velocity value. Valid values are: LOW, HIGH, and any additional values defined by the Hub from Application Platform > System Administration > Agent Criteria Groups.
ColonyID	Required in a multischema deployment where a table may exist in multiple schemas. Runs the agent for the colony.

Statistics Tracked

The following statistics are tracked for this transaction:

Table A–55 Release Wave Statistics

Statistic Name	Description
NumberOfShipmentsInException	Number of Shipments for which tasks could not be created for the Entire Quantity.
NumberOfTasksCreated	Number of tasks created.

Pending Job Count

For this transaction the pending job count is the number of records available to be processed by the transaction with the AVAILABLE_DATE value less than or equal to (<=) the current date value in the YFS_Task_Q table.

Events Raised

The following events are raised by this time-triggered transaction:

Table A–56 Events Raised by the Release Wave Transaction

Transaction/Event	Key Data	Data Published	Template Support?
ON_SUCCESS	wave_dbd.txt	WMS_RELEASE_WAVE.ON_SUCCESS.xml	Yes

A.2.19 Reopen Task

This transaction enables you to change task statuses from SUGGESTED to OPEN as needed in order to reassign a task to a different user.

For example, if users log out at the end of their shift with tasks in the SUGGESTED status that are assigned to them, you can set these tasks as REOPENED so that they can be reassigned to users who are currently available to complete these tasks.

This transaction also reopens and unassigns all tasks that have been in the SUGGESTED status for more than an hour. However, this agent will not process voice-based tasks as the task completion notifications for the external system are not in real time.

Attributes

The following are the attributes for this time-triggered transaction:

Table A-57 Reopen Task Attributes

Attribute	Value
Base Transaction ID	REOPEN_TASK
Base Document Type	General
Base Process Type	Task Execution
Abstract Transaction	No
APIs Called	changeTask ()

Criteria Parameters

The following are the criteria parameters for this transaction:

Table A-58 Reopen Task Criteria Parameters

Parameter	Description
AgentCriteriaId	Optional. For the specified agent criteria ID, tasks that have been SUGGESTED to a specific user, but that user is no longer logged in, are changed back to the OPEN status and made available for a new user assignment.
OrganizationCode	Optional. For the specified organization code, tasks that have been SUGGESTED to a specific user, but that user is no longer logged in, are changed back to OPEN status and made available for a new user assignment.
ColonyID	Required in a multischema deployment where a table may exist in multiple schemas. Runs the agent for the colony.

Statistics Tracked

The following statistics are tracked for this transaction:

Table A–59 Reopen Task Statistics

Parameter	Description
TotalNumberOfTasksReOpened	Total number of tasks reopened.

Pending Job Count

For this transaction the pending job count is the number of suggested Task Records (with TASK_STATUS='1200') that have to be reopened.

Events Raised

This transaction raises events as specified under the `changeTask()` API in the *Selling and Fulfillment Foundation: Javadocs*.

A.2.20 Request Batch Completion

Request Batch Completion is a time-triggered transaction that completes a batch after completing its tasks.

The `yfs.confirmbatch.online` property in the `yfs.properties_wms_ext.in` file is used to set this time-triggered transaction to work in online or offline mode.

- **Online mode:** In the online mode, the confirm batch transaction runs as usual, completing all tasks of the batch and then completing the batch in one commit boundary.
- **Offline mode:** In the offline mode, the confirm batch transaction triggers an agent and changes the batch status to 'Completion Requested'. When the agent runs, it completes either each task of the batch, or the batch itself, in an execution call.

The mode of operation (online or offline) is decided on the basis of a property defined in the `yfs.properties_wms_ext.in` file:

```
yfs.confirmbatch.online = Y/N
```

The default out-of-the-box shipped property causes the Request Batch Completion transaction to run in online mode.

Note: In instances where the Request Batch Completion transaction is run in offline mode, ensure that all Agent Criteria defined for the transaction are configured properly.

Attributes

The following are the attributes for this time-triggered transaction:

Table A–60 Request Batch Completion Attributes

Attribute	Value
Transaction Name	Request Batch Completion
Transaction ID	REQ_BATCH_COMPLETION
Base Document Type	General
Base Process Type	Task Execution
Abstract Transaction	No
APIs Called	registerBatchCompletion() registerTaskCompletion()
User Exits Called	None

Criteria Parameters

The following are the criteria parameters for this transaction:

Table A–61 Request Batch Completion Criteria Parameters

Parameter	Description
Action	Required. Triggers the transaction. If left blank, it defaults to Get, the only valid value.
Number of Records To Buffer	Optional. Number of records to retrieve and process at one time. If left blank or specified as 0 (zero), it defaults to 5000.
Node	Required. The warehouse management ship node for which records are being processed.

Table A–61 Request Batch Completion Criteria Parameters

Parameter	Description
AgentCriteriaGroup	Optional. Used to classify nodes. This value can be accepted by WMS time-triggered transactions that only perform their tasks on the nodes with a matching node transactional velocity value. Valid values are: LOW, HIGH, and any additional values defined by the Hub from Application Platform > System Administration > Agent Criteria Groups.
ColonyID	Required in a multischema deployment where a table may exist in multiple schemas. Runs the agent for the colony.

Statistics Tracked

The following statistics are tracked for this transaction:

Table A–62 Request Batch Completion Statistics

Statistic Name	Description
NumberOfBatchesCompleted	Number of batches completed.
NumberOfTasksCompleted	Number of tasks completed.

Pending Job Count

For this transaction the pending job count is the number of batches and their tasks that can be completed.

Events Raised

The following events are raised by this time-triggered transaction:

Table A–63 Events Raised by the Request Batch Completion Transaction

Transaction/Event	Key Data	Data Published	Template Support?
BATCH_COMPLETION_REQUESTED	batch_dbd.txt	YCP_REQ_BATCH_COMPLETION.BATCH_COMPLETION_REQUESTED.xml	Yes

A.2.21 Cancel Wave

This time-triggered transaction is used to cancel waves. Waves can be cancelled either in offline or online mode, depending on the values set for the `yfs.cancelwave.offline.taskcount.greaterthan` or `yfs.cancelwave.offline.shipmentcount.greaterthan` variables that are defined in the `yfs.properties_wms_ext.in` file. Waves are cancelled in the offline mode, if a wave is released and the number of wave tasks to be cancelled is greater than the value of the `yfs.cancelwave.offline.taskcount.greaterthan` variable, or the wave is yet to be released and the number of shipments included in the wave to cancel is greater than the value of the `yfs.cancelwave.offline.shipmentcount.greaterthan` variable. Otherwise, waves are cancelled in the online mode.

If waves are cancelled in offline mode, the status of the wave changes to Cancellation Requested (00) on cancel wave operation. On successful cancellation, the wave status changes to Cancelled. If the cancellation fails due to some reason, the status of the wave changes to Cancellation Failed (01).

Attributes

The following are the attributes for this time-triggered transaction:

Table A-64 *Cancel Wave Attributes*

Attribute	Value
Transaction Name	Request Wave Cancellation
Transaction ID	CANCEL_WAVE
Base Document Type	Outbound Picking
Base Process Type	Outbound Picking
Abstract Transaction	None
APIs Called	<code>manageWave ()</code>
User Exits Called	None

Criteria Parameters

The following are the criteria parameters for this transaction:

Table A-65 Cancel Wave Criteria Parameters

Parameter	Description
Action	Required. Triggers the transaction. If left blank, it defaults to Get, the only valid value.
Number of Records To Buffer	Optional. Number of records to retrieve and process at one time. If left blank or specified as 0 (zero), it defaults to 5000.
Node	Required. The warehouse management ship node for which records are being processed.
AgentCriteriaGroup	Optional. Used to classify nodes. This value can be accepted by WMS time-triggered transactions that only perform their tasks on the nodes with a matching node transactional velocity value. Valid values are: LOW, HIGH, and any additional values defined by the Hub from Application Platform > System Administration > Agent Criteria Groups.
ColonyID	Required in a multischema deployment where a table may exist in multiple schemas. Runs the agent for the colony.

Statistics Tracked

No statistics are tracked for this transaction.

Pending Job Count

No pending job counts are present for this transaction.

Events Raised

The following events are raised by this time-triggered transaction:

Table A–66 Events Raised by the Cancel Wave Transaction

Transaction/Event	Key Data	Data Published	Template Support?
WAVE_CANCELLATION_REQUESTED	wave_dbd.txt	WMS_MANAGE_WAVE.ON_SUCCESS.xml	Yes
WAVE_CANCELLATION_FAILED	wave_dbd.txt	CANCEL_WAVE.WAVE_CANCELLATION_FAILED.xml	Yes

A.2.22 Cancel Move

This time-triggered transaction is used to cancel move request. Move request cancellation can happen either in offline or online mode, depending on the values set for the variable `yfs.cancelmove.offline.taskcount.greaterthan` defined in `yfs.properties_wms_ext.in`. Move request cancellation happens in the offline mode, if the number of move request tasks to be cancelled is greater than the value of the variable. Otherwise, cancellation happens in the online mode.

If cancellation happens in the offline mode, the status of the move request changes to `Cancellation Requested` and on successful cancellation, the status changes to `Closed`. If the cancellation fails due to some reason, the status changes to `Cancellation Failed`.

Attributes

The following are the attributes for this time-triggered transaction:

Table A–67 Cancel Move Attributes

Attribute	Value
Transaction Name	Request Move Cancellation
Transaction ID	CANCEL_MOVE_REQUEST
Base Document Type	Move Request Execution
Base Process Type	Move Request Execution
Abstract Transaction	None

Table A–67 Cancel Move Attributes

Attribute	Value
APIs Called	cancelTask()
User Exits Called	None

Criteria Parameters

The following are the criteria parameters for this transaction:

Table A–68 Cancel Move Criteria Parameters

Parameter	Description
Action	Required. Triggers the transaction. If left blank, it defaults to Get, the only valid value.
Number of Records To Buffer	Optional. Number of records to retrieve and process at one time. If left blank or specified as 0 (zero), it defaults to 5000.
Node	Required. The warehouse management ship node for which records are being processed.
AgentCriteriaGroup	Optional. Used to classify nodes. This value can be accepted by WMS time-triggered transactions that only perform their tasks on the nodes with a matching node transactional velocity value. Valid values are: LOW, HIGH, and any additional values defined by the Hub from Application Platform > System Administration > Agent Criteria Groups.
ColonyID	Required in a multischema deployment where a table may exist in multiple schemas. Runs the agent for the colony.

Statistics Tracked

No statistics are tracked for this transaction.

Pending Job Count

No pending job counts are present for this transaction.

Events Raised

The following events are raised by this time-triggered transaction:

Table A–69 Events Raised by the Cancel Move Transaction

Transaction/Event	Key Data	Data Published	Template Support?
MOVE_CANCELLATION_REQUESTED	WMS_cancelMoveRequest_input_dtd_txt	WMS_CANCEL_MOVE_REQUEST.ON_SUCCESS.xml	Yes
MOVE_CANCELLATION_FAILED	None	WMS_CANCELMOVE_REQUEST.MOVE_CANCELLATION_FAILED.xml	Yes

A.2.23 Re-Calculate Location Dimensions

This time-triggered transaction is used to re-calculate the available weight or volume of the locations. This transaction is used in:

- Calculation of available weight or volume of:
 - Locations that have inventory, whose weight or volume has changed.
 - Locations, whose location size code has changed.
 - Locations associated with a location size, whose weight or volume has changed.
- Calculation of weight or volume of cases or pallets having inventory, whose weight or volume has changed.

Attributes

The following are the attributes for this time-triggered transaction:

Table A–70 Relocate Location Dimension Attributes

Attribute	Value
Transaction Name	Recalculate Location Dimensions
Transaction ID	RECALC_LOCN_DIMENSIONS

Table A–70 Relocate Location Dimension Attributes

Attribute	Value
Base Document Type	WMS Layout Definition
Base Process Type	General
Abstract Transaction	None
APIs Called	None
User Exits Called	None

Criteria Parameters

The following are the criteria parameters for this transaction:

Table A–71 Relocate Location Dimension Criteria Parameters

Parameter	Description
Action	Required. Triggers the transaction. If left blank, it defaults to Get.
Zone ID	Optional. Used to get list of locations for which the dimensions have to be re-calculated.
Location ID	Optional. Location for which the dimensions have to be re-calculated.
Node	Optional. The warehouse management ship node for which records are being processed.
RecalcReason	Required. This attribute identifies if the item size or location dimensions are changed. Valid values are LocationSizeChange and ItemSizeChange.
AgentCriteriaGroup	Optional. Used to classify nodes. This value can be accepted by WMS time-triggered transactions that only perform their tasks on the nodes with a matching node transactional velocity value. Valid values are: LOW, HIGH, and any additional values defined by the Hub from Application Platform > System Administration > Agent Criteria Groups.

Table A–71 Relocate Location Dimension Criteria Parameters

Parameter	Description
Location Size Code	Required if RecalcReason is LocationSizeChange and Location ID is not given. Used to get list of locations, which need recalculation of dimensions.
Item ID	Required along with Unit Of Measure and Enterprise Code, if RecalcReason is ItemSizeChange.
Unit Of Measure	Required along with Item ID and Enterprise Code, if RecalcReason is ItemSizeChange. Used to get list of locations, which need recalculation of dimensions.
Enterprise Code	Required with Unit of Measure and Item ID, if RecalcReason is ItemSizeChange. Used to get list of locations, which need recalculation of dimensions.
Old Unit Weight	Optional. Along with Item ID, Unit of Measure and Enterprise Code, if RecalcReason is ItemSizeChange. Used to update the weight of case or pallet which already has the item.
ColonyID	Required in a multischema deployment where a table may exist in multiple schemas. Runs the agent for the colony.

Statistics Tracked

No statistics are tracked for this transaction.

Pending Job Count

No pending job counts are present for this transaction.

Events Raised

No events are raised for this transaction.

A.2.24 PopulateOwnershipTransferSummary

This method updates the YFS_OWNERSHIP_TRANSFER_SUMMARY table.

This transaction updates the YFS_OWNERSHIP_TRANSFER_SUMMARY table by checking the records in YFS_INV_OWN_TRANSFER_RCD table.

It also updates the IS_STATISTICS_UPDATED to 'Y' in YFS_INV_OWN_TRANSFER_RCD table after the record has been used by the transaction.

Attributes

Following are the attributes for this time-triggered transaction:

Table A-72 YFSPopulateOwnershipTransfer Attributes

Attribute	Value
Base Transaction ID	POPULATE_OWN_TRANS_SUMM
Base Document Type	General
Base Process Type	General
Abstract Transaction	No
APIs Called	None

Criteria Parameters

Following are the criteria parameters for this transaction:

Table A-73 YFSPopulateOwnershipTransfer Criteria Parameters

Parameter	Description
Action	Required. Triggers the transaction. If left blank, it defaults to Get, which is the only valid value.
Number of Records To Buffer	Optional. Number of records to retrieve and process at one time. If left blank or specified as 0 (zero), it defaults to 5000.
ColonyID	Required in a multischema deployment where a table may exist in multiple schemas. Runs the agent for the colony.

Statistics Tracked

None

Pending Job Count

None

Events Raised

None

A.3 Purge Time-Triggered Transactions

There are several transactions that you can use to purge your database tables at specific time intervals.

Purge transactions determine when a table should be purged by determining the current date and subtracting the retention days specified by the purge. If the timestamp on the table is less than or equal to (current day - retention days) the table is purged.

Note: In some cases a purge may look at another field other than the table's timestamp. These are pointed out in the documentation.

Note: When purging an entity, take into consideration all of the information that is purged along with it. For example, if a sales order with live shipments is purged, the order does not appear in the order number field in the Outbound Shipment Console.

A.3.1 Purge Strategy

The following recommendations should be taken into consideration when planning a purge strategy for each purge transaction:

- Test purges by setting Live to 'N'.
- Turn on logging to test what is purged.
- Set up purge traces in the System Management Console and analyze the information.

A.3.2 Configuring Purge Transaction Log Files

You can configure purges to write log files to a directory you specify. Each time you run a particular purge, new data is appended to this file. If no file exists, one is created.

To specify purge log file directory:

1. Edit the `<INSTALL_DIR>/properties/yfs.properties` file.
2. Set `yfs.purge.path=<full absolute path of log directory>`.

For example, on UNIX you might specify the log files to be written to the `/app/yfs/logs/purges` directory.

If the value for the `yfs.purge.path` is not passed, it defaults to the value specified in the `yfs.properties` file. If a variable is introduced, then the `yfs.purge.path` is ignored. To modify this property, add an entry for it in the `<INSTALL_DIR>/properties/customer_overrides.properties` file. For additional information about modifying properties and the `customer_overrides.properties` file, see *Selling and Fulfillment Foundation: Properties Guide*.

For information about filename limitations related to internationalization, see *Selling and Fulfillment Foundation: Localization Guide*.

A.3.3 Available Purges

The time-triggered purge transactions are:

- [Activity Demand Purge](#)
- [Count Request Purge](#)
- [Corporate Count Request Purge](#)
- [Dock Appointment Purge](#)
- [Location Inventory Audit Purge](#)
- [Manifest Purge](#)
- [Move Request Purge](#)
- [Productivity Purge](#)
- [Task History Purge](#)
- [Task Purge](#)

- [Planned Task Purge](#)
- [User Activity Purge](#)
- [Wave Purge](#)
- [Execution Exception Audit Purge](#)
- [Global Serial Number Purge](#)

A.3.3.1 Activity Demand Purge

This time-triggered transaction purges all the Satisfied Activity Demand records for a period greater than the retention days specified in the Activity Demand Purge criteria.

Attributes

The following are the attributes for this time-triggered transaction:

Table A–74 Activity Demand Purge Attributes

Attribute	Value
Base Transaction ID	ACTIVITYDEMANDPRG
Base Document Type	General
Base Process Type	WMS Putaway
Abstract Transaction	No
APIs Called	None
User Exits Called	YFSBeforePurgeUE

Criteria Parameters

The following are the criteria parameters for this transaction:

Table A–75 Activity Demand Purge Criteria Parameters

Parameter	Description
Action	Required. Triggers the transaction. If left blank, it defaults to Get, the only valid value.
Number of Records To Buffer	Optional. Number of records to retrieve and process at one time. If left blank or specified as 0 (zero), it defaults to 5000.

Table A–75 Activity Demand Purge Criteria Parameters

Parameter	Description
EnterpriseCode	Optional. Enterprise for which the Activity Demand Purge needs to be run. If not passed, then all enterprises are monitored.
Node	Optional. Node for which the Activity Demand Purge needs to be run. If not passed, then all nodes are monitored.
AgentCriteriaGroup	Optional. Used to classify nodes. This value can be accepted by WMS time-triggered transactions that perform their tasks on the nodes with a matching node transactional velocity value. Valid values are: LOW, HIGH, and any additional values defined by the Hub from Applications > Application Platform > System Administration > Agent Criteria Groups.
PurgeCode	Required. Cannot be modified. Used for internal calculations, such as determining retention days. Corresponds with the PurgeCode used in the Business Rules Purge Criteria.
Live	Optional. Mode in which to run. Defaults to N. <ul style="list-style-type: none"> • Y - Production mode. Deletes records from regular tables. • N - Test mode.
ColonyID	Required in a multischema deployment where the YFS_ACTIVITY_DEMAND table may exist in multiple schemas. Runs the agent for the colony.

Statistics Tracked

The following statistics are tracked for this transaction:

Table A–76 Activity Demand Purge Statistics

Statistic Name	Description
NumActivityDemandsPurged	Number of Activity Demands purged.

Pending Job Count

For this transaction the pending job count is the number of records that can be purged from the YFS_ACTIVITY_DEMAND table.

Events Raised

None.

Tables Purged

YFS_ACTIVITY_DEMAND

A.3.3.2 Count Request Purge

This time-triggered transaction purges all the count requests for a period greater than the retention days specified in the Count Purge criteria and those, which are either in the status of cancelled or completed.

You can use the pseudo-logic of purge codes to benefit in analyzing purges. A count request is picked up for purge if it meets the following conditions:

- The count request should be in pickable status for purge transaction.
- The last modification performed on a count request should fall before the lead time setup.

Attributes

The following are the attributes for this time-triggered transaction:

Table A-77 Count Request Purge Attributes

Attribute	Value
Base Transaction ID	COUNTPRG
Base Document Type	Count
Base Process Type	Count Execution
Abstract Transaction	No
APIs Called	None
User Exits Called	YFSBeforePurgeUE

Criteria Parameters

The following are the criteria parameters for this transaction:

Table A-78 *Count Request Purge Criteria Parameters*

Parameter	Description
Action	Required. Triggers the transaction. If left blank, it defaults to Get, the only valid value.
PurgeCode	Required. Cannot be modified. Used for internal calculations, such as determining retention days. Corresponds with the PurgeCode used in Business Rules Purge Criteria.
Live	Optional. Mode in which to run. Defaults to N. <ul style="list-style-type: none"> • Y - Production mode. Deletes records from regular tables. • N - Test mode.
Number of Records To Buffer	Optional. Number of records to retrieve and process at one time. If left blank or specified as 0 (zero), it defaults to 5000.
AgentCriteriaGroup	Optional. Used to classify nodes. This value can be accepted by WMS time-triggered transactions that only perform their tasks on the nodes with a matching node transactional velocity value. Valid values are: LOW, HIGH, and any additional values defined by the Hub from Application Platform > System Administration > Agent Criteria Groups.
EnterpriseCode	Optional. Enterprise for which the Count Request Purge needs to be run. If not passed, then all enterprises are monitored.
Node	Optional. Node for which the Count Request Purge needs to be run. If not passed, then all nodes are monitored.
ColonyID	Required in a multischema deployment where a table may exist in multiple schemas. Runs the agent for the colony.

Statistics Tracked

The following statistics are tracked for this transaction:

Table A-79 Count Request Purge Statistics

Statistic Name	Description
NumCountRequestsPurged	Number of count requests purged.
NumCountResultsPurged	Number of count results purged.

Pending Job Count

For this transaction the pending job count is the number of records that can be purged from the YFS_COUNT_REQUEST table.

Events Raised

None.

Tables Purged

YFS_COUNT_RESULT_TAG

YFS_COUNT_RESULT

YFS_COUNT_REQUEST

A.3.3.3 Corporate Count Request Purge

Corporate Count Request Purge is the time-triggered transaction that purges the corporate count requests.

Attributes

The following are the attributes for this time-triggered transaction:

Table A-80 Corporate Count Request Purge Attributes

Attribute	Value
Base Transaction ID	COUNTPROGPRG
Base Document Type	Count
Base Process Type	Count Execution
Abstract Transaction	No

Table A–80 Corporate Count Request Purge Attributes

Attribute	Value
APIs Called	None
User Exits Called	None

Criteria Parameters

The following are the criteria parameters for this transaction:

Table A–81 Corporate Count Request Purge Criteria Parameters

Parameter	Description
Action	Required. Triggers the transaction. If left blank, it defaults to Get, the only valid value.
Purge Code	Required. Cannot be modified. Used for internal calculations, such as determining retention days. Corresponds with the PurgeCode used in Business Rules Purge Criteria
Live	Optional. Mode in which to run. Defaults to "N". <ul style="list-style-type: none"> • Y - Production mode. Deletes records from regular tables. • N - Test mode.
CollectPendingJobs	If this parameter is set to "N", the agent does not collect information on the pending jobs for this monitor. This pending job information is used for monitoring the monitor in the System Management Console.
Number of Records To Buffer	Optional. Number of records to retrieve and process at one time. If left blank or specified as 0 (zero), it defaults to 5000.
Node	Optional. Node for which the Corporate Count Request Purge needs to be run. If not passed, then all nodes are monitored.
Enterprise Code	Optional. Enterprise for which the Corporate Count Request Purge needs to be run. If not passed, all the Enterprises are monitored.

Table A–81 Corporate Count Request Purge Criteria Parameters

Parameter	Description
AgentCriteriaGroup	Optional. Used to classify nodes. This value can be accepted by WMS time-triggered transactions that only perform their tasks on the nodes with a matching node transactional velocity value. Valid values are: LOW, HIGH, and any additional values defined by the Hub from Application Platform > System Administration > Agent Criteria Groups.
ColonyID	Required in a multischema deployment where a table may exist in multiple schemas. Runs the agent for the colony.

Note: While the criteria parameters Node and AgentCriteriaGroup are individually optional fields, both fields cannot be left blank and at least one of them has to be specified.

Statistics Tracked

The following statistics are tracked for this transaction:

Table A–82 Corporate Count Request Purge Statistics

Statistic Name	Description
NumOneTimeCountPrograms Purged	Number of corporate count requests purged.

Pending Job Count

For this transaction the pending job count is the number of records that can be purged from the YFS_COUNT_PROGRAM table.

Events Raised

None.

Tables Purged

YFS_CNT_PROG_COND_ATTR
 YFS_CNT_PROG_COND_STATE
 YFS_COUNT_PROGRAM_COND
 YFS_COUNT_PROGRAM

A.3.3.4 Dock Appointment Purge

This time-triggered transaction purges all dock appointment details for a period greater than the retention days specified in the Dock Appointment Purge criteria, and if the resource pool consumption detail do not exist for the specified dock appointment.

Attributes

The following are the attributes for this time-triggered transaction:

Table A–83 Dock Appointment Purge Attributes

Attribute	Value
Base Transaction ID	DOCKAPPOINTMENTPRG
Base Document Type	None
Base Process Type	General
Abstract Transaction	No
APIs Called	None
User Exits Called	YFSBeforePurgeUE

Criteria Parameters

The following are the criteria parameters for this transaction:

Table A–84 Dock Appointment Purge Criteria Parameters

Parameter	Description
Action	Required. Triggers the transaction. If left blank, it defaults to Get, the only valid value.
PurgeCode	Required. Cannot be modified. Used for internal calculations, such as determining retention days. Corresponds with the PurgeCode used in Business Rules Purge Criteria.
Live	Optional. Mode in which to run. Defaults to N. <ul style="list-style-type: none"> Y - Production mode. Deletes records from regular tables. N - Test mode.
AgentCriteriaGroup	Optional. Used to classify nodes. This value can be accepted by WMS time-triggered transactions that only perform their tasks on the nodes with a matching node transactional velocity value. Valid values are: LOW, HIGH, and any additional values defined by the Hub from Application Platform > System Administration > Agent Criteria Groups.
ColonyID	Required in a multischema deployment where the YFS_DOCK_APPOINTMENT table may exist in multiple schemas. Runs the agent for the colony.

Statistics Tracked

The following statistics are tracked for this transaction:

Table A–85 Dock Appointment Purge Statistics

Statistic Name	Description
NumDockAppointmentsPurged	Number of dock appointments purged.

Events Raised

None.

Tables Purged

YFS_DOCK_APPOINTMENT

A.3.3.5 Location Inventory Audit Purge

This time-triggered transaction purges all the Location Inventory Audit details for a period greater than the retention days specified in the Location Inventory Audit Purge criteria.

You can use the pseudo-logic of purge codes to benefit in analyzing purges. A location inventory audit record is picked up for purge if it meets the following condition:

- The last modification performed on the location inventory audit record should fall before the lead time setup.

Note: Number of threads for this purge's agent criteria details must be set to 1. For more information about agent criteria, refer to the *Selling and Fulfillment Foundation: Application Platform Configuration Guide*.

Attributes

The following are the attributes for this time-triggered transaction:

Table A–86 Location Inventory Audit Purge Attributes

Attribute	Value
Base Transaction ID	LOCNINVAUDITPRG
Base Document Type	General
Base Process Type	WMS Inventory
Abstract Transaction	No
APIs Called	None
User Exits Called	YFSBeforePurgeUE

Criteria Parameters

The following are the criteria parameters for this transaction:

Table A–87 Location Inventory Audit Purge Criteria Parameters

Parameter	Description
Action	Required. Triggers the transaction. If left blank, it defaults to Get, the only valid value.
Number of Records To Buffer	Optional. Number of records to retrieve and process at one time. If left blank or specified as 0 (zero), it defaults to 5000.
EnterpriseCode	Optional. Enterprise for which the Location Inventory Audit Purge needs to be run. If not passed, then all enterprises are monitored.
Node	Optional. Node for which the Location Inventory Audit Purge needs to be run. If not passed, then all nodes are monitored.
AgentCriteriaGroup	Optional. Used to classify nodes. This value can be accepted by WMS time-triggered transactions that only perform their tasks on the nodes with a matching node transactional velocity value. Valid values are: LOW, HIGH, and any additional values defined by the Hub from Application Platform > System Administration > Agent Criteria Groups.
PurgeCode	Required. Cannot be modified. Used for internal calculations, such as determining retention days. Corresponds with the PurgeCode used in Business Rules Purge Criteria.
Live	Optional. Mode in which to run. Defaults to N. <ul style="list-style-type: none"> • Y - Production mode. Deletes records from regular tables. • N - Test mode.
ColonyID	Required in a multischema deployment where the YFS_LOCN_INVENTORY_AUDIT table may exist in multiple schemas. Runs the agent for the colony.

Statistics Tracked

The following statistics are tracked for this transaction:

Table A-88 Location Inventory Audit Purge Statistics

Statistic Name	Description
NumLocationInventoryAudits Purged	Number of location inventory audits purged.

Pending Job Count

For this transaction the pending job count is the number of records that can be purged from the YFS_LOCN_INVENTORY_AUDIT table.

Events Raised

None.

Tables Purged

YFS_LOCN_INVENTORY_AUDIT

A.3.3.6 Manifest Purge

This purge picks up all the manifests that have been marked as "Closed" and purges them.

Any enterprise using the Console must schedule purge transactions.

All manifests which do not associate to any shipments and with modify timestamp less than the current date minus the purge criteria's retention days can be configured to be picked up by the Manifest Purge.

You can use the pseudo-logic of purge codes to analyze purges. If the following conditions are met, a manifest is picked up for purge:

- The manifest should be in the "Closed" status.
- The last modification performed on the manifest should fall before the lead time (in days) setup.
- The manifest should not be associated with any shipment and its last modification should be less than current date minus lead time (in days).

Note: All the shipments associated with the manifests should have been purged before running this purge agent.

Attributes

The following are the attributes for this time-triggered transaction:

Table A–89 Manifest Purge Attributes

Attribute	Value
Base Transaction ID	MANIFESTPRG
Base Document Type	General
Base Process Type	General
Abstract Transaction	No
APIs Called	None
User Exits Called	YFSBeforePurgeUE

Criteria Parameters

The following are the criteria parameters for this transaction:

Table A–90 Manifest Purge Parameters

Parameter	Description
Action	Required. Triggers the transaction. If left blank, it defaults to Get, the only valid value.
Number of Records To Buffer	Optional. Number of records to retrieve and process at one time. If left blank or specified as 0 (zero), it defaults to 5000.
Live	Optional. Mode in which to run. Valid values are: <ul style="list-style-type: none"> Y - Default value. Moves qualifying records from the regular tables listed under Tables Purged to the corresponding history tables. N - Test mode. Determines the rows that are moved to history tables without actually moving them.
PurgeCode	Required. Cannot be modified. Used for internal calculations, such as determining retention days. Corresponds with the PurgeCode used in Business Rules Purge Criteria.

Table A–90 Manifest Purge Parameters

Parameter	Description
AgentCriteriaGroup	Optional. Used to classify nodes. This value can be accepted by WMS time-triggered transactions that only perform their tasks on the nodes with a matching node transactional velocity value. Valid values are: LOW, HIGH, and any additional values defined by the Hub from Application Platform > System Administration > Agent Criteria Groups.
ShipNode	Optional. Ship node for which the Manifest Purge needs to be run. If not passed, then all ship nodes are monitored.
ColonyID	Required in a multischema deployment where the YFS_MANIFEST table may exist in multiple schemas. Runs the agent for the colony.

Statistics Tracked

The following statistics are tracked for this transaction:

Table A–91 Manifest Purge Statistics

Statistic Name	Description
NumManifestsPurged	Number of manifests purged.

Pending Job Count

For this transaction, the pending job count is the number of records that can be purged from the YFS_Manifest table.

Events Raised

None.

Tables Purged

YFS_MANIFEST

Note: To purge Manifests, the Shipments related to the manifests should be purged by Shipment Purge, and the Manifests should be in 'Closed' status.

A.3.3.7 Move Request Purge

This time-triggered transaction purges all the Move requests that are in the CLOSED status (having been cancelled or completed), and those that are existing for a period greater than the retention days specified in the Move Request Purge criteria.

You can use the pseudo-logic of purge codes to benefit in analyzing purges. A move request is picked up for purge if it meets the following conditions:

1. The last modification performed on a move request should fall before the lead time setup.
2. The move request should be in the "Closed" status.

Note: If a move request has a cross-dock activity (activity demand) associated with it, the number of retention days specified in the purge criteria should be inclusive of the time required to complete the activity.

Attributes

The following are the attributes for this time-triggered transaction:

Table A-92 *Move Request Purge Attributes*

Attribute	Value
Base Transaction ID	MOVEREQUESTPRG
Base Document Type	General
Base Process Type	General
Abstract Transaction	No

Table A–92 Move Request Purge Attributes

Attribute	Value
APIs Called	None
User Exits Called	YFSBeforePurgeUE

Criteria Parameters

The following are the criteria parameters for this transaction:

Table A–93 Move Request Purge Criteria Parameters

Parameter	Description
Action	Required. Triggers the transaction. If left blank, it defaults to Get, the only valid value.
PurgeCode	Required. Cannot be modified. Used for internal calculations, such as determining retention days. Corresponds with the PurgeCode used in Business Rules Purge Criteria.
Live	Optional. Mode in which to run. Defaults to N. <ul style="list-style-type: none"> Y - Production mode. Deletes records from regular tables. N - Test mode.
Number of Records To Buffer	Optional. Number of records to retrieve and process at one time. If left blank or specified as 0 (zero), it defaults to 5000.
AgentCriteriaGroup	Optional. Used to classify nodes. This value can be accepted by WMS time-triggered transactions that only perform their tasks on the nodes with a matching node transactional velocity value. Valid values are: LOW, HIGH, and any additional values defined by the Hub from Application Platform > System Administration > Agent Criteria Groups.
ColonyID	Required in a multischema deployment where the YFS_MOVE_REQUEST_LINE_TAG table may exist in multiple schemas. Runs the agent for the colony.

Statistics Tracked

The following statistics are tracked for this transaction:

Table A–94 Move Request Purge Statistics

Statistic Name	Description
NumMoveRequestLinesPurged	Number of move request lines purged.
NumMoveRequestsPurged	Number of move requests purged.

Pending Job Count

For this transaction the pending job count is the number of records that can be purged from the YFS_MOVE_REQUEST table.

Events Raised

None.

Tables Purged

YFS_MOVE_REQUEST_LINE_TAG

YFS_MOVE_REQUEST_LINE

YFS_MOVE_REQUEST_STATUS_AUDIT

YFS_MOVE_REQUEST

A.3.3.8 Productivity Purge

This time-triggered transaction purges productivity data for a period greater than the lead_days specified in the Productivity Purge criteria for a specific OrganizationCode.

Attributes

The following are the attributes for this time-triggered transaction:

Table A–95 Productivity Purge Attributes

Attribute	Value
Base Transaction ID	PRODUCTIVITYPRG
Base Document Type	General

Table A–95 Productivity Purge Attributes

Attribute	Value
Base Process Type	General
Abstract Transaction	No
APIs Called	None
User Exits Called	YFSBeforePurgeUE

Criteria Parameters

The following are the criteria parameters for this transaction:

Table A–96 Productivity Purge Criteria Parameters

Parameter	Description
Action	Required. Triggers the transaction. If left blank, it defaults to Get, the only valid value.
PurgeCode	Required. Cannot be modified. Used for internal calculations, such as determining retention days. Corresponds with the PurgeCode used in Business Rules Purge Criteria.
Live	Optional. Mode in which to run. Defaults to N. <ul style="list-style-type: none"> Y - Production mode. Deletes records from regular tables. N - Test mode.
Number of Records To Buffer	Optional. Number of records to retrieve and process at one time. If left blank or specified as 0 (zero), it defaults to 5000.
EnterpriseCode	Optional. Enterprise for which the Productivity Purge needs to be run. If not passed, then all enterprises are monitored.
Organization Code	Optional. Organization for which the Productivity Purge needs to be run. If not passed, then all organizations are monitored.
ColonyID	Required in a multischema deployment where the YFS_PRODUCTIVITY table may exist in multiple schemas. Runs the agent for the colony.

Statistics Tracked

The following statistics are tracked for this transaction:

Table A–97 Productivity Purge Statistics

Statistic Name	Description
NumProductivityRecordsPurged	Number of productivity records purged.

Pending Job Count

For this transaction the pending job count is the number of records that can be purged from the YFS_PRODUCTIVITY table.

Events Raised

None.

Tables Purged

YFS_PRODUCTIVITY

A.3.3.9 Task History Purge

This transaction deletes tasks previously archived by the Task Purge.

You can use the pseudo-logic of purge codes to benefit in analyzing purges. A task from the history table is picked up for purge if it meets the following condition:

- The last modification performed on the task should fall before the lead time setup.

Attributes

The following are the attributes for this time-triggered transaction:

Table A–98 Task History Purge Attributes

Attribute	Value
Base Transaction ID	TASKHISTORYPURGE
Base Document Type	General
Base Process Type	TASK_EXECUTION

Table A-98 Task History Purge Attributes

Attribute	Value
Abstract Transaction	No
APIs Called	None
User Exits Called	YFSBeforePurgeUE

Criteria Parameters

The following are the criteria parameters for this transaction:

Table A-99 Task History Purge Criteria Parameters

Parameter	Description
Action	Required. Triggers the transaction. If left blank, it defaults to Get, the only valid value.
Live	Optional. Mode in which to run. Defaults to N. <ul style="list-style-type: none"> • Y - Production mode. Deletes records from the statistics tables. • N - Test mode. Generates a report that lists the statistics eligible for being purged.
PurgeCode	Required. Cannot be modified. Used for internal calculations, such as determining retention days. Corresponds with the PurgeCode used in Business Rules Purge Criteria.
Organization Code	Optional. Organization for which the Task History purge needs to be run. If not passed, then all organizations are monitored.
AgentCriteriaGroup	Optional. Used to classify nodes. This value can be accepted by WMS time-triggered transactions that only perform their tasks on the nodes with a matching node transactional velocity value. Valid values are: LOW, HIGH, and any additional values defined by the Hub from Application Platform > System Administration > Agent Criteria Groups.
ColonyID	Required in a multischema deployment where a table may exist in multiple schemas. Runs the agent for the colony.

Statistics Tracked

The following statistics are tracked for this transaction:

Table A-100 Task History Purge Statistics

Statistic Name	Description
NumHistoryTasksPurged	Number of history tasks purged.

Pending Job Count

For this transaction the pending job count is the number of records that can be purged from the YFS_TASK_H table.

Events Raised

None.

Tables Purged

YFS_BATCH_H

YFS_BATCH_LOCATION_H

YFS_TASK_H

YFS_TASK_STATUS_AUDIT_H

A.3.3.10 Task Purge

This transaction uses the YFS_Task table to find the tasks (as well as task batches and batch locations) that can be purged and then archives them to history tables. This purge also updates records in YFS_User_Trans_Constraints to inactive if there are no open tasks for the set of references in the YFS_User_Trans_Constraints record.

You can use the pseudo-logic of purge codes to benefit in analyzing purges. A task is picked up for purge if it meets the following conditions:

- The last modification performed on the task should fall before the lead time setup.
- The task should be either in "Completed" or "Canceled" status.
- If the task is associated with a productivity type, the productivity metric should be captured by running the Mine Productivity transaction.
- The shipment should be in Closed status, that is the SHIPMENT_CLOSED_FLAG should be set to 'Y' for the shipment of that particular orderpick.

- All dependent tasks should meet the above conditions.
- If the task is a summary task, then all child tasks should meet the above conditions.

Attributes

The following are the attributes for this time-triggered transaction:

Table A–101 Task Purge Attributes

Attribute	Value
Base Transaction ID	TASKPURGE
Base Document Type	General
Base Process Type	TASK_EXECUTION
Abstract Transaction	No
APIs Called	None
User Exits Called	YFSBeforePurgeUE

Criteria Parameters

The following are the criteria parameters for this transaction:

Table A–102 Task Purge Criteria Parameters

Parameter	Description
Action	Required. Triggers the transaction. If left blank, it defaults to Get, the only valid value.
Number of Records To Buffer	Optional. Number of records to retrieve and process at one time. If left blank or specified as 0 (zero), it defaults to 5000.
Live	Optional. Mode in which to run. Defaults to N. <ul style="list-style-type: none"> • Y - Production mode. Deletes records from the statistics tables. Default. • N - Test mode. Generates a report that lists the statistics eligible for being purged.

Table A–102 Task Purge Criteria Parameters

Parameter	Description
PurgeCode	Required. Cannot be modified. Used for internal calculations, such as determining retention days. Corresponds with the PurgeCode used in Business Rules Purge Criteria.
Organization Code	Optional. Organization for which the Task purge needs to be run. If not passed, then all organizations are monitored.
AgentCriteriaGroup	Optional. Used to classify nodes. This value can be accepted by WMS time-triggered transactions that only perform their tasks on the nodes with a matching node transactional velocity value. Valid values are: LOW, HIGH, and any additional values defined by the Hub from Application Platform > System Administration > Agent Criteria Groups.
ColonyID	Required in a multischema deployment where a table may exist in multiple schemas. Runs the agent for the colony.

Statistics Tracked

The following statistics are tracked for this transaction:

Table A–103 Task Purge Statistics

Statistic Name	Description
NumTasksPurged	Number of tasks purged.

Pending Job Count

For this transaction the pending job count is the number of records that can be purged from the YFS_TASK table.

Events Raised

None.

Tables Purged

YFS_TASK

YFS_TASK_STATUS_AUDIT

YFS_BATCH

YFS_BATCH_LOCATION

YFS_AUTO_USER_CONSTRAINTS (When there are no open tasks for the references in the constraints)

A.3.3.11 Planned Task Purge

This time-triggered transaction purges all the planned tasks whose value of COMPLETED flag is set to Y, and those that are existing for a period greater than the retention days specified in the Planned Task Purge criteria.

A planned task is picked up for purge if it meets the following conditions:

1. The planned task's last modification should fall before the lead time setup.
2. The value of the COMPLETED flag should be set to Y.

Attributes

The following are the attributes for this time-triggered transaction:

Table A–104 Planned Task Purge Attributes

Attribute	Value
Base Transaction ID	PLANNEDTASKPRG
Base Document Type	General
Base Process Type	General
Abstract Transaction	No
APIs Called	None
User Exits Called	YFSBeforePurgeUE

Criteria Parameters

The following are the criteria parameters for this transaction:

Table A–105 *Planned Task Purge Criteria Parameters*

Parameter	Description
Action	Required. Triggers the transaction. If left blank, it defaults to Get, the only valid value.
PurgeCode	Required. Cannot be modified. Used for internal calculations, such as determining retention days. Corresponds with the PurgeCode used in Business Rules Purge Criteria.
Live	Optional. Mode in which to run. Defaults to N. <ul style="list-style-type: none"> • Y - Production mode. Deletes records from regular tables. • N - Test mode.
Number of Records To Buffer	Optional. Number of records to retrieve and process at one time. If left blank or specified as 0 (zero), it defaults to 5000.
AgentCriteriaGroup	Optional. Used to classify nodes. This value can be accepted by WMS time-triggered transactions that only perform their tasks on the nodes with a matching node transactional velocity value. Valid values are: LOW, HIGH, and any additional values defined by the Hub from Application Platform > System Administration > Agent Criteria Groups.
Node	Optional. Ship Node to which the planned task belongs.
ColonyID	Required in a multischema deployment where the YFS_PLANNED_TASK table may exist in multiple schemas. Runs the agent for the colony.

Statistics Tracked

The following statistics are tracked for this transaction:

Table A–106 Planned Task Purge Statistics

Statistic Name	Description
NumPlannedTasksPurged	Number of planned tasks purged.

Pending Job Count

For this transaction the pending job count is the number of records that can be purged from the YFS_PLANNED_TASK table.

Events Raised

None.

Tables Purged

YFS_PLANNED_TASK

A.3.3.12 User Activity Purge

This transactions purges all activity records from the table older than the specified retention days.

This agent should be used whenever user activity records need to be removed, such as after a application server restart.

You can use the pseudo-logic of purge codes to benefit in analyzing purges. A user activity record is picked up for purge if it meets the following condition:

- The last modification performed on the user activity record should fall before the lead time setup.

Attributes

The following are the attributes for this time-triggered transaction:

Table A–107 User Activity Purge Attributes

Attribute	Value
Base Transaction ID	USERACTIVITYPRG
Base Document Type	General
Base Process Type	General

Table A–107 User Activity Purge Attributes

Attribute	Value
Abstract Transaction	No
APIs Called	None
User Exits Called	YFSBeforePurgeUE

Criteria Parameters

The following are the criteria parameters for this transaction:

Table A–108 User Activity Purge Criteria Parameters

Parameter	Description
Action	Required. Triggers the transaction. If left blank, it defaults to Get, the only valid value.
Number of Records To Buffer	Optional. Number of records to retrieve and process at one time. If left blank or specified as 0 (zero), it defaults to 5000.
PurgeCode	Required. Cannot be modified. Used for internal calculations, such as determining retention days. Corresponds with the PurgeCode used in Business Rules Purge Criteria.
BatchDelete	Required. Mode in which the records get deleted from the user activity table. Default to "". <ul style="list-style-type: none"> • Y - Records are deleted in a batch. • N - Records are deleted one by one.
CollectPendingJobs	If this parameter is set to "N", the agent does not collect information on the pending jobs for this monitor. This pending job information is used for monitoring the monitor in the System Management Console.

Table A–108 User Activity Purge Criteria Parameters

Parameter	Description
Live	Optional. Mode in which to run. Defaults to "N". <ul style="list-style-type: none"> Y - Production mode. Deletes records from regular tables. N - Test mode.
ColonyID	Required in a multischema deployment where the YFS_USER_ACTIVITY table may exist in multiple schemas. Runs the agent for the colony.

Statistics Tracked

The following statistics are tracked for this transaction:

Table A–109 User Activity Purge Statistics

Parameter	Description
NumActivitiesPurged	Number of records purged from the User Activity table.

Pending Job Count

For this transaction the pending job count is the number of records that can be purged from the YFS_USER_ACTIVITY table.

Events Raised

None.

Tables Purged

YFS_USER_ACTIVITY

A.3.3.13 Wave Purge

This purge deletes data after a wave has completed its typical lifecycle. This reduces load from the frequently accessed tables. This transaction works on a task queue. It picks up the waves from YFS_TASK_Q table that are available for this transaction. Waves are then purged if they have not been modified within the time specified in the purge criteria configuration.

You can use the pseudo-logic of purge codes to benefit in analyzing purges. The system picks up waves from the YFS_TASK_Q table for the purge transaction. A wave is picked up for purge if it meets the following condition:

- The last modification performed on the wave should fall before the lead time setup.

Note: When a wave is purged, all the audits related to the wave are also purged.

Attributes

The following are the attributes for this time-triggered transaction:

Table A-110 Wave Purge Attributes

Attribute	Value
Base Transaction ID	YFS_Wave
Base Document Type	Outbound Picking
Base Process Type	OUTBOUND_PICKING
Abstract Transaction	No
APIs Called	None
User Exits Called	YFSBeforePurgeUE

Criteria Parameters

The following are the criteria parameters for this transaction:

Table A-111 Wave Purge Criteria Parameters

Parameter	Description
Action	Required. Triggers the transaction. If left blank, it defaults to Get, the only valid value.
PurgeCode	Required. Cannot be modified. Used for internal calculations, such as determining retention days. Corresponds with the PurgeCode used in Business Rules Purge Criteria.

Table A–111 Wave Purge Criteria Parameters

Parameter	Description
Live	Optional. Mode in which to run. Defaults to N. <ul style="list-style-type: none"> Y - Production mode. Deletes records from regular tables. N - Test mode.
Number of Records To Buffer	Optional. Number of records to retrieve and process at one time. If left blank or specified as 0 (zero), it defaults to 5000.
Node	Optional. Node for which the Wave Purge needs to be run. If not passed, then all nodes are monitored.
AgentCriteriaGroup	Optional. Used to classify nodes. This value can be accepted by WMS time-triggered transactions that only perform their tasks on the nodes with a matching node transactional velocity value. Valid values are: LOW, HIGH, and any additional values defined by the Hub from Application Platform > System Administration > Agent Criteria Groups.
ColonyID	Required in a multischema deployment where the YFS_WAVE table may exist in multiple schemas. Runs the agent for the colony.

Statistics Tracked

The following statistics are tracked for this transaction:

Table A–112 Wave Purge Statistics

Statistic Name	Description
NumWavesPurged	Number of waves purged.

Pending Job Count

For this transaction the pending job count is the number of records that can be purged from the YFS_WAVE table.

Events Raised

None.

Tables Purged

YFS_WAVE

A.3.3.14 Execution Exception Audit Purge

This transaction uses the YFS_EXECUTION_EXCEPTION_AUDIT table to find the audits that can be purged, and then deletes them.

Attributes

The following are the attributes for this time-triggered transaction:

Table A–113 Execution Exception Audit Purge Attributes

Attribute	Value
Base Transaction ID	EXECEXECPAUDITPURGE
Base Document Type	General
Base Process Type	TASK_EXECUTION
Abstract Transaction	No
APIs Called	None
User Exits Called	None

Criteria Parameters

The following are the criteria parameters for this transaction:

Table A–114 Execution Exception Audit Purge Criteria Parameters

Parameter	Description
Action	Required. Triggers the transaction. If left blank, it defaults to Get, the only valid value.
Number of Records To Buffer	Optional. Number of records to retrieve and process at one time. If left blank or specified as 0 (zero), it defaults to 5000.

Table A–114 Execution Exception Audit Purge Criteria Parameters

Parameter	Description
Live	Optional. Mode in which to run. Defaults to N. <ul style="list-style-type: none"> Y - Production mode. Deletes records from the statistics tables. Default. N - Test mode. Generates a report that lists the statistics eligible for being purged.
PurgeCode	Required. Cannot be modified. Used for internal calculations, such as determining retention days. Corresponds with the PurgeCode used in the Business Rules purge criteria.
OrganizationCode	Optional. Organization for which the Execution Exception purge needs to be run.
AgentCriteriaGroup	Optional. Used to classify nodes. This value can be accepted by WMS time-triggered transactions that only perform their tasks on nodes with a matching node transactional velocity value. Valid values are LOW, HIGH, and any additional values defined by the Hub from Application Platform > System Administration > Agent Criteria Groups.
ColonyID	Required in a multischema deployment where the YFS_EXECUTION_EXCEPTION_AUDIT table may exist in multiple schemas. Runs the agent for the colony.

Statistics Tracked

The following statistics are tracked for this transaction:

Table A–115 Task Purge Statistics

Statistic Name	Description
NumExceptionAuditsPurged	Number of Execution Exception Audits purged.

Pending Job Count

For a transaction, the Pending Job Count is the number of records that can be purged from the YFS_EXECUTION_EXCEPTION_AUDIT table.

Events Raised

None.

Tables Purged

YFS_EXECUTION_EXCEPTION_AUDIT

A.3.3.15 Global Serial Number Purge

This time-triggered transaction purges all the serial numbers that have not been at a node for a period greater than the retention days specified in the Global Serial Number Purge criteria.

You can use the pseudo-logic of purge codes to analyze purges better. A serial number is picked up for purge if it meets the following conditions:

- The serial number should not be present at node.
- The last modification performed on the serial should fall before the lead time setup.

Attributes

The following are the attributes for this time-triggered transaction:

Table A-116 Global Serial Number Purge Attributes

Attribute	Value
Base Transaction ID	GLOBALSERIALNUMPURGE
Base Document Type	General
Base Process Type	General
Abstract Transaction	No
APIs Called	None
User Exits Called	None

Criteria Parameters

The following are the criteria parameters for this transaction:

Table A–117 Global Serial Number Purge Criteria Parameters

Parameter	Description
Action	Required. Triggers the transaction. If left blank, it defaults to Get, the only valid value.
CollectPendingJobs	If this parameter is set to "N", the agent does not collect information on the pending jobs for this monitor. This pending job information is used for monitoring the monitor in the System Management Console.
NumberofRecordsTo Buffer	Optional. Number of records to retrieve and process at one time. If left blank or specified as 0 (zero), it defaults to 5000.
PurgeCode	Required. Cannot be modified. Used for internal calculations, such as determining retention days. Corresponds to the PurgeCode used in Business Rules Purge Criteria.
Node	Optional. Node for which the Global Serial Number Purge needs to be run. If not passed, then all nodes are monitored.
AgentCriteriaGroup	Optional. Used to classify nodes. This value can be accepted by WMS time-triggered transactions that only perform their tasks on nodes with a matching node transactional velocity value. Valid values are LOW, HIGH, and any additional values defined by the Hub from Application Platform > System Administration > Agent Criteria Groups.
EnterpriseCode	Optional. Enterprise for which the Global Serial Number Purge needs to be run. If not passed, all enterprises are monitored.

Table A–117 Global Serial Number Purge Criteria Parameters

Parameter	Description
Live	Optional. Mode in which to run. Defaults to N. <ul style="list-style-type: none"> Y - Production mode. Deletes records from regular tables. N - Test mode.
ColonyId	Required in a multischema deployment where the YFS_GLOBAL_SERIAL_NUM table may exist in multiple schemas. Runs the agent for the colony.

Statistics Tracked

The following statistics are tracked for this transaction:

Table A–118 Global Serial Number Purge Statistics

Statistic Name	Description
NumGlobalSerialsPurged	Number of global serial numbers purged.

Pending Job Count

For this transaction the pending job count is the number of records that can be purged from the YFS_GLOBAL_SERIAL_NUM table.

Events Raised

None.

Tables Purged

YFS_GLOBAL_SERIAL_NUM

Externally Triggered Transaction Reference

The Sterling WMS provides transactions that are triggered externally. Unlike time-triggered transactions, these transactions may or may not be scheduled.

B.1 ZeroOut Location Inventory

The ZEROOUT_LOC_INV_IS_INITIATED event is used to trigger this transaction.

Attributes

The following are attributes for this externally triggered transaction:

Table B-1 ZeroOut Location Inventory Attributes

Attribute	Value
Base Transaction ID	ZEROOUT_LOCATION_INV
Base Document Type	General
Base Process Type	WMS_INVENTORY
APIs Called	adjustLocationInventory and deleteLPN

Criteria Parameters

The following are the criteria parameters for this transaction:

Table B–2 ZeroOut Location Inventory Criteria Parameters

Parameter	Description
Node	Required. The node in which the inventory needs to be cleaned up.
Location ID	Required. The location in which the inventory needs to be cleaned up.
Reason Code	Required. The reason code for cleaning up the inventory.
Enterprise Code	Optional. The enterprise for which the inventory needs to be cleaned up.
Reason Text	Optional. The reason text associated with the reason code.
ColonyID	Required in a multischema deployment where a table may exist in multiple schemas. Runs the agent for the colony.

Note: You must not configure the ZEROOUT_LOCATION_INV agent criteria fields. The values are obtained when the agent is triggered externally from the console, where the Required/Optional values are passed.

Statistics Tracked

None.

Pending Job Count

None.

Events Raised

The following events are raised by this transaction:

Table B-3 Events Raised by the ZeroOut Location Inventory Transaction

Transaction/Event	Data Published
ZEROOUT_LOC_INV_IS_INITIATED	<pre> <ZeroOutLocationInventory Node="" EnterpriseCode="" > <Source LocationInd="" /> <Audit ReasonCode="" ReasonText="" /> </ZeroOutLocationInventory> </pre>

This event is associated with the `ZeroOutLocationInventory` service that triggers this transaction. For more information about the service invoked by this event, see [Table 4-22](#).

C

Factory Setup for High-Volume Pick Pack Warehouse

The Sterling WMS provides a set of factory defaults for the reference implementation of high-volume pick pack warehouse. The reference implementation enables a rapid deployment of the application, and highlights the capabilities of the product.

This setup is optional, and the configuration of data is specific to the Sterling WMS.

For more information about installing the factory defaults for a high-volume pick pack warehouse, see the *Selling and Fulfillment Foundation: Installation Guide*.

Selling and Fulfillment Foundation provides the following node-level configurations for the default WMS node:

- [Warehouse Layout](#)
- [Requirements - Inbound](#)
- [Requirements - Inventory Control](#)
- [Counts](#)
- [Task Management](#)
- [Requirements - VAS](#)
- [Requirements - Outbound](#)

C.1 Warehouse Layout

The Warehouse Layout related factory defaults are:

- [Zone Definition](#)
- [Location Size Codes](#)
- [Location Storage Code](#)
- [Location Definition](#)
- [Dedicated Locations](#)
- [Equipments](#)
- [Stations](#)

C.1.1 Zone Definition

The following are the factory default settings for zone definition:

Zone	Description	Track Pallet LPN	Track Case LPN	Forward Pick Zone
BULK-1	Bulk Storage 1	Y	Y	N
INTRANSIT	In-Transit Zone	Y	Y	N
A1	Active Pick Zone – Dedicated Locations	N	N	Y
A2	Dynamic Slot Active Pick Locations	N	N	Y
DOCK	Dock Locations	Y	Y	N
PACK	Pack Stations	Y	Y	N
VAS	VAS Stations	Y	Y	N
QC	QC Locations	Y	Y	N
CONSOL	Outbound Consolidation locations	Y	Y	N
ACC-BIN-SHIP	Accounting Bin Locations for Ship	N	N	N

Zone	Description	Track Pallet LPN	Track Case LPN	Forward Pick Zone
ACC-BIN-COUNT	Accounting Bin Locations for Count	Y	Y	N
CROSS-DOCK-STAGING	Cross Dock Staging Locations	Y	Y	N

The following are the defaults settings for all zones:

- Track Inventory is set to "Y"
- Enterprise Constraints – None
- Product Mixing Constraints: Allow if License Plated
- Minimize No. of Locations Per SKU : Set to Y
- Force Location Scan on Visit : Set to Y
- Building Number : 1
- Inventory Status Transition : None
- Forward Pick Zone

C.1.2 Location Size Codes

The following are the factory default settings for location size codes:

Size Code	Description	Infinite Capacity	L	W	H	Max Weight
STAGING	Staging Locations	Y				
1-PALLET	1-Pallet Locations	N	48	40	72	2500
2-PALLET	2-Pallet Locations	N	48	82	72	5000
2-CASE	Case Storage Locations	N	36	12	12	300

Size Code	Description	Infinite Capacity	L	W	H	Max Weight
CART-SLOTS	Cart Location Slots	N	18	12	18	300

C.1.3 Location Storage Code

There are no factory default settings for location storage codes.

C.1.4 Location Definition

The following are the factory default settings for location definition:

Location	Location Type	Zone	Size Code
SHIP-BIN	Virtual	Accounting Bin	Staging
COUNT-BIN	Virtual	Accounting Bin	Staging
PACK-STATION	Staging	PACK	Staging
MANIFEST-STATION	Staging	PACK	Staging
IN-TRANSIT	INTRANSIT	BULK-1	Staging
TURRET-01-A	INTRANSIT	INTRANSIT	Staging
TURRET-01-B	INTRANSIT	INTRANSIT	Staging
QC-STATION	Staging	QC	Staging
DR01	DOCK	DOCK	Staging
DR02	DOCK	DOCK	Staging
SHIP-CONSOL-01	Staging	CONSOL	Staging
SHIP-CONSOL-02	Staging	CONSOL	Staging
SHIP-CONSOL-03	Staging	CONSOL	Staging
SHIP-CONSOL-04	Staging	CONSOL	Staging
SHIP-CONSOL-05	Staging	CONSOL	Staging
SHIP-CONSOL-06	Staging	CONSOL	Staging

Location	Location Type	Zone	Size Code
SHIP-CONSOL-07	Staging	CONSOL	Staging
SHIP-CONSOL-08	Staging	CONSOL	Staging
STAGING-01	Staging	Cross Dick Staging	Staging
VAS-STATION	Staging	VAS	Staging

C.1.5 Dedicated Locations

There are no factory default settings for dedicated locations.

C.1.6 Equipments

The following are the factory default settings for equipments:

Equipment Types

Equipment Type	Description	Modeled As	Equipment Location Type	
FORK-LIFT	Fork Lifts	Location	In-Transit	
PALLET-JACK	Pallet Jacks	Location	In-Transit	
GRAB-TRUCK	Grab Trucks	Location	In-Transit	
TURRET-TRUCK	Turret Trucks	Location	In-Transit	Provide 2 locations in the truck as A and B. All of them mapping to location size code "Staging"
SINGLE-LOC-PICK-CART	Picking Carts	Pallet		

Equipment Type	Description	Modeled As	Equipment Location Type	
MULTI-LOC-PICK-CART	Multi Location Pick Carts	Pallet		Provide 8 locations in the cart as A, B, C,D, E, F, G and H. All of them mapping to location size code "CART-SLOTS"
SHIPPING-SORTER	Shipping Sorter	Location	Staging	Define multiple locations as Chute-1, Chute-2, Chute-3, Chute-4, ... Chute-8

Equipments

Equipments	Equipment Types	Location
FL-01	Fork Lifts	INTRANSIT
FL-02	Fork Lifts	INTRANSIT
PJ-01	Pallet Jack	INTRANSIT
PJ-02	Pallet Jack	INTRANSIT
GT-01	Grab Trucks	INTRANSIT
GT-02	Grab Trucks	INTRANSIT
TURRET-01	Turret Trucks	TURRET-01-A and TURRET-01-B
SHIP-SORTER	Ship Sorter	SHIP-CONSOL-01 through SHIP-CONSOL-08

Equipments	Equipment Types	Location
CART-01	SINGLE-LOC-CART	
CART-02	SINGLE-LOC-CART	
CART-03	MULTI-LOC-CART	
CART-04	MULTI-LOC-CART	

C.1.7 Stations

The following are the factory default settings for stations:

Station Types

Station Type	Description	Location Type	Location Size Code	Location Name
PACK	Pack Station	STAGING	Staging	Pack Location
MANIFEST	Manifest Station	STAGING	Staging	Manifest Station Location
VAS	VAS Station	STAGING	Staging	VAS Station

Stations

Stations	Station Types	Location
PACK-STATION-1	Pack Station - 1	PACK-STATION
PACK-STATION-2	Pack Station - 2	PACK-STATION
VAS-STATION-1	VAS Station 1	VAS-STATION
VAS-STATION-2	VAS Station 2	VAS-STATION
MANIFEST-1	Manifest Station 1	MANIFEST-STATION
MANIFEST-STATION-2	Manifest Station 2	MANIFEST-STATION

C.2 Requirements - Inbound

The Warehouse Layout related factory defaults are:

- [Default Activity Codes](#)
- [Disposition Code Mapping](#)
- [Receiving Strategy](#)

C.2.1 Default Activity Codes

The following are the factory default settings for activity codes:

Activity Code	Description
PRE-RECEIPT	Pre Receiving
RECEIPT	Inbound Receipts
RETURN-RECEIPT	Return Receipts
TRAILER-UNLOAD	Unload Trailer

C.2.2 Disposition Code Mapping

The following are the factory default settings for disposition code mapping:

Disposition Code	Description	Product Class	Inventory Status
STOCK	Good Inventory for Stocking		Good
DAMAGED	Damaged Inventory	DAMAGED	Damaged
REQUIRES-INSPECTION	Requires further Inspection		AWAITING-INSPECTION
SCRAP	Scrap – Do not take to Inventory		SCRAP

C.2.3 Receiving Strategy

The following are the factory default settings for receiving strategy:

Document Type	Shipment Entry Allowed	Build Pallet	Build Case	Disposition Code With QC	Disposition Code Without QC	Preference for Receipt Closure
Purchase Order	Yes	Optional	Optional		STOCK	Received Quantity at least equal to expected quantity
Transfers	Yes	Optional	Optional		STOCK	

C.3 Requirements - Inventory Control

The Inventory Control related factory defaults are:

- [Inventory Status Codes](#)
- [Inventory Adjustment Reason Codes](#)
- [Inventory Transition Rules](#)
- [Storage Preference](#)
- [Putaway Strategy](#)
- [Replenishment Strategy](#)
- [Move Request Cancellation Reason Codes](#)

C.3.1 Inventory Status Codes

The following are the factory default settings for inventory status codes:

Inventory Status	Status Description	Supply Type
Good	Good Inventory	ONHAND

Inventory Status	Status Description	Supply Type
Damaged	Damaged	HELD
Await-Inspection	Awaiting Inspection	HELD
Quality-Hold	Quality Hold	HELD
Putaway-Hold	Putaway Hold	HELD
Shortage	Shortage	HELD
SCRAP	Scrap	

C.3.2 Inventory Adjustment Reason Codes

There are no factory default settings for inventory adjustment reason codes.

C.3.3 Inventory Transition Rules

There are no factory default settings for inventory transition rules.

C.3.4 Storage Preference

The following are the factory default settings for storage preference:

Single SKU

Description	Activity Code	Requesting Activity Group	Segment Type	Inventory Status	Priority	Set of Zones
Putaway of Good Inventory to Storage	STORAGE	Receiving		Good	1	A1
					2	BULK-1

Description	Activity Code	Requesting Activity Group	Segment Type	Inventory Status	Priority	Set of Zones
Putaway of products awaiting inspection to QC	STORAGE	Receiving	MTO	AWAIT-INSPECTION	1	QC
Putaway of segmented inventory to Cross dock staging	STORAGE	Receiving		Good	1	CROSS-DOCK-STAGING

Multi-SKU Pallet

The multi-SKU pallet enables the putaway of each SKU separately.

Multi-SKU Case

Description	Activity Code	Requesting Activity Group	Priority	Set of Zones
Putaway of Multi SKU Cases	STORAGE	Receiving	1	BULK-1

Container with Unknown contents

Description	Activity Code	Requesting Activity Group	Priority	Set of Zones
Putaway of Containers with Unknown Contents	STORAGE	Receiving	1	BULK-1

C.3.5 Putaway Strategy

The following are the factory default settings for putaway strategy:

Source Zone	Target Zone	Container Type	Task Type
DOCK			PUT-001
DOCK		PALLET	PUT-002
	BULK-1	PALLET	PUT-003

C.3.6 Replenishment Strategy

The following are the factory default settings for replenishment strategy:

Description	Zones to Replenish	UOM	Zones to search	Optimize Retrieval	Round Up Quantity	Task Type
Replenish to Dedicated Active Pick Locations	A1,A2	CASE	BULK-1	Pick to Clean	Case	RPL-001

Description	Zones to Replenish	UOM	Zones to search	Optimize Retrieval	Round Up Quantity	Task Type
Replenish to Dedicated Active Pick Locations	A1,A2	PALL ET	BULK-1	Pick to Clean	Pallet	RPL-002

C.3.7 Move Request Cancellation Reason Codes

The following are the factory default settings for move request cancellation reason codes:

Reason	Description
INVENTORY-SHORTAGE	Shortage of Inventory
SYSTEM-CANCELLATION	Auto Cancellation by system
OTHERS	Others
DATA-ENTRY-ERROR	Data Entry error

C.4 Counts

The Counts related factory defaults are:

- [Variance Hold Setup](#)
- [Count Request Cancellation Reason Code](#)
- [Count Strategy](#)

C.4.1 Variance Hold Setup

For all zones, do not put variance on Hold.

C.4.2 Count Request Cancellation Reason Code

The following are the factory default settings for count request cancellation reason code:

Reason	Description
SYSTEM-CANCELLATION	Auto Cancellation by system
DATA-ENTRY-ERROR	Data Entry error
OTHERS	Others

C.4.3 Count Strategy

The following are the factory default settings for count strategy:

Description	Zone	Location Size Code	Transaction ID	Task Granularity	Task Type
Count Entry – Bulk Storage	BULK-1		Create Count Task	Request	CNT-001
Count Entry – Active Area	A1, A2		Create Count Task	Request	CNT-001
Resolve Variance	All Zones		Create Variance Task	Variance	CNT-004

C.5 Task Management

The Task Management related factory defaults are:

- [Modification Reason Codes](#)
- [Task Type - Receipt](#)
- [Task Type - QC](#)

- Task Type - Count
- Task Type - Replenishment
- Task Type - Retrieval
- Task Type - Putaway
- Task Type - VAS
- Task Type - Pack
- Task Type - Shipping
- Task Type - Picking
- Task Execution Exceptions

C.5.1 Modification Reason Codes

The following are the factory default settings for modification reason codes:

Reason	Description
OT	Others
CSR-Request	Customer Request
MANUAL-DISPATCH	Manual dispatch of tasks to users

C.5.2 Task Type - Receipt

The following are the factory default settings for task type - receipt:

Task Type	Task Type Description	Activity Code	Priority	Productivity Type
RECEIPT	Receiving	RECEIVE	10	RECEIPT
PRE-RECEIPT	Pre Receiving	PRE-RECEIVE	10	PRE-RECEIPT
TRLR-UNLD	Trailer Unload	TRAILER-UNLOAD	10	TRAILER-UNLOAD

Task Type	Task Type Description	Activity Code	Priority	Productivity Type
RET-RCPT	Return Receipt	RECEIVE-RETURN	10	RETURN-RECEIPT

C.5.3 Task Type - QC

The following are the factory default settings for task type - QC:

Task Type	Task Type Description	Activity Code	Priority	Productivity Type
INSPECTION	Inspection	INSPECTION	10	INSPECTION

C.5.4 Task Type - Count

The following are the factory default settings for task type - count:

Task Type	Task Type Description	Activity Code	Priority	Dispatch As soon as generated	#Tasks Per Batch	#Tasks Per Batch Maximum #Users per count request	Productivity Type
CNT-001	Count entry using Mobile Terminal	COUNT	10	Yes			COUNT-ENTRY
CNT-002	Count entry using count sheets	COUNT	10	Yes	10		COUNT-ENTRY

Task Type	Task Type Description	Activity Code	Priority	Dispatch As soon as generated	#Tasks Per Batch	#Tasks Per Batch Maximum #Users per count request	Productivity Type
CNT-003	Re-Count	COUNT	10	Yes			COUNT-ENTRY
CNT-004	Count Variance Resolution	COUNT	10	Yes			VARIANCE-RESOLUTION

C.5.5 Task Type - Replenishment

The following are the factory default settings for task type - replenishment:

Task Type	Task Type Description	Summary
RPL-001	Case Replenishment	Product is picked onto inventory Case
		Execute task using Mobile devices
		Dispatch task as soon as possible
		Perform Task in multiple steps
		Limit #users to Zero
		Pick Sequence is "Pick Sequence"
		Drop Sequence is "Putaway Sequence"
		Productivity Type is "CASE-RETRIEVAL"

Task Type	Task Type Description	Summary
RPL-002	Pallet Replenishment	Product is picked directly onto equipment
		Apply LPN while picking
		Execute Task using mobile devices
		Dispatch task as soon as possible
		Limit #users to Zero
		Pick Sequence is "Pick Sequence"
		Drop Sequence is "Putaway Sequence"
		Productivity Type is "PALLET-RETRIEVAL"
RPL-003	Replenishment using Printed Tickets	Product is picked directly into equipment
		Execute Task using Printed Tickets
		Use the Sterling WMS application to plan trips by batching tasks
		Use "TURRET-TRUCK" for picking
		#Requests allowed per location is 1
		Pick Seq is Move Out
		Drop Seq is Move In
		Productivity Type is "CASE-RETRIEVAL"
RPL-004	Final Step Case Replenishment	Product is picked directly into equipment
		Execute Task using Mobile devices
		Dispatch tasks as soon as possible
		Limit #users to zero

Task Type	Task Type Description	Summary
		Pick Sequence is Move Out
		Drop Sequence is Move In
		Productivity Type is "CASE-PUTAWAY"

C.5.6 Task Type - Retrieval

The following are the factory default settings for task type - retrieval:

Task Type	Task Type Description	Summary
RTV-001	Case Retrieval	Product is picked directly into equipment
		Apply LPN while picking
		Execute task using Mobile devices
		Dispatch task as soon as possible
		Perform Task in multiple steps
		Limit #users to Zero
		Pick Sequence is "Pick Sequence"
		Drop Sequence is "Putaway Sequence"
RTV-002	Pallet Retrieval	Product is picked directly onto equipment
		Apply LPN while picking
		Execute Task using mobile devices
		Dispatch task as soon as possible
		Limit #users to Zero
		Pick Sequence is "Pick Sequence"

Task Type	Task Type Description	Summary
		Drop Sequence is "Putaway Sequence"
		Productivity Type is "PALLET-RETRIEVAL"
RTV-003	Retrieval using Printed Tickets	Product is picked directly into equipment
		Execute Task using Printed Tickets
		Use the Sterling WMS application to plan trips by batching tasks
		Use "TURRET-TRUCK" for picking
		#Requests allowed per location is 1
		Pick Seq is Move Out
		Drop Seq is Move In
		Productivity Type is "SKU-RETRIEVAL"
RTV-004	SKU/Unit Retrieval – Pick to Pallet	Product is picked into inventory pallet
		Execute task using Mobile devices
		Dispatch tasks as soon as possible
		Limit #users per request to Zero
		Pick Seq is Move Out
		Drop Sequence is Move In
		Productivity Type is "SKU-RETRIEVAL"

C.5.7 Task Type - Putaway

The following are the factory default settings for task type - putaway:

Task Type	Task Type Description	Summary
PUT-001	SKU Putaway	Execute Task using Mobile Devices
		Dispatch task as soon as possible
		Perform Task in multiple steps
		Limit #users for a shipment to 1
		Pick Sequence is "Pick Sequence"
		Drop Sequence is "Putaway Sequence"
		Productivity Type is "SKU-PUTAWAY"
PUT-002	Pallet Putaway – First Step	Execute Task using Mobile Devices
		Dispatch task as soon as possible
		Perform Task in multiple steps
		Limit #users for a shipment to 1
		Pick Sequence is "Pick Sequence"
		Drop Sequence is "Putaway Sequence"
		Productivity Type is "PALLET-PUTAWAY"
PUT-003	Pallet Putaway – Final Step	Execute Task using Mobile Devices
		Dispatch task as soon as possible
		Limit #users for a shipment to 1
		Pick Sequence is "Pick Sequence"
		Drop Sequence is "Putaway Sequence"
		Productivity Type is "PALLET-PUTAWAY"

Task Type	Task Type Description	Summary
PUT-004	Putaway using Printed Tickets	Execute Tasks using Printed Tickets
		Use the Sterling WMS application to plan trips by batching tasks
		Use SINGLE-LOC-CART as equipment
		Pick Sequence is "Pick Sequence"
		Drop Sequence is "Putaway Sequence"
		Productivity Type is "SKU-PUTAWAY"

C.5.8 Task Type - VAS

The following are the factory default settings for task type - VAS:

Task Type	Task Type Description	Activity Code	Priority	Productivity Type
KITTING	Kitting	KITTING	10	Kitting
KIT-CHT	Assembly of Communication and High Tech products	KIT-CHT	10	KIT-CHT
KIT-CPG	Assembly of Consumer Products	KIT-CPG	10	KIT-CPG
DE-KITTING	DE-KITTING	DE-KITTING	10	DE-KITTING
PRICE-TKT	Price Ticketing	SPECIAL-TICKETING	10	SPECIAL-TICKETING
FREQ-PROG	Frequency Programming	FREQ-PROGRAMMING	10	FREQ-PROGRAMMING

Task Type	Task Type Description	Activity Code	Priority	Productivity Type
UNIT-PACK	Re Pack Unit Boxes	RUBBER-BAN DING	10	RUBBER-BAN DING
RE-PACK	Repack with different UOM	RE-PACK	10	RE-PACK

C.5.9 Task Type - Pack

The following are the factory default settings for task type - pack:

Task Type	Task Type Description	Activity Code	Priority	Productivity Type
PACK-C	Pack Shipping Carton	Pack Carton	10	PACK-CARTO N
PLT-BUILD	Pallet Build	Pallet Build	10	PALLET-BUIL D
PLT-WEIGH	Weight Pallet	WEIGH-PALLE T	10	WEIGH-PALL ET

C.5.10 Task Type - Shipping

The following are the factory default settings for task type - shipping:

Task Type	Task Type Description	Activity Code	Priority	Productivity Type
MANIFEST	Parcel Manifesting	MANIFEST	10	MANIFEST
TRL-LOAD	Trailer Loading	TRL-LOAD	10	Trailer Loading
PLT-BUILD	Shipping Pallet Build	PLT-BUILD	10	PLT-BUILD

C.5.11 Task Type - Picking

The following are the factory default settings for task type - picking:

Task Type	Task Type Description	Activity Code	Summary
PCK-001	Pick into Shipping Carton – System Suggested	Order Pick	Product is Picked into inventory Case
			Pack while Picking
			Use System Containerization
			Execute Task using mobile devices
			Dispatch task as soon as they are generated
			Pick sequence is Move-Out
			Drop Sequence is Move-In
			Productivity type is "PICK-INTO-CARTON"
PCK-002	Pick into Shipping Carton	Order Pick	Product is Picked into inventory Case
			Pack while Picking
			Execute Task using mobile devices
			Dispatch task as soon as they are generated
			Pick sequence is Move-Out
			Drop Sequence is Move-In
			Max# users per shipment is 1

Task Type	Task Type Description	Activity Code	Summary
			Productivity type is "PICK-INTO-CARTON"
PCK-003	Pick into Shipping Pallet	Order Pick	Product is picked into inventory pallet
			Pack while picking
			Execute Task using mobile devices
			Dispatch task as soon as they are generated
			Suggest multiple tasks and allow user to choose
			Pick sequence is Move-Out
			Perform Task in Multiple Steps
			Drop Sequence is Move-In
			Max# users per shipment is 1
			Productivity type is "PICK-INTO-PALLET"
PCK-004	Pick Pallets and apply Shipping Label	Order Pick	Product is picked directly into equipment
			Apply license plate while picking
			Execute Task using mobile devices
			Dispatch task as soon as they are generated
			Pick sequence is Move-Out

Task Type	Task Type Description	Activity Code	Summary
			Perform Task in Multiple Steps
			Drop Sequence is Move-In
			Max# users per shipment is 1
			Productivity type is "PICK-PALLETS"
PCK-005	Pick Cases and apply shipping label	Order Pick	Product is picked directly into equipment
			Apply license plate while picking
			Execute Task using mobile devices
			Dispatch task as soon as they are generated
			Pick sequence is Move-Out
			Perform Task in Multiple Steps
			Drop Sequence is Move-In
			Max# users per shipment is 1
			Productivity type is "PICK-CASES"
PCK-006	Pick Products	Order Pick	Product is picked into inventory Pallet
			Execute task using mobile devices
			Dispatch task as soon as they are generated

Task Type	Task Type Description	Activity Code	Summary
			Pick sequence is Move-Out
			Perform Task in Multiple Steps
			Drop Sequence is Move-In
			Max# users per shipment is 1
			Productivity type is "PICK-CASES"
PCK-007	Batch Pick and Pack – System Sugg. Packing	Batch Pick	Product is picked onto inventory case
			Pack while pick
			Use system containerization
			Execute task using Printed Tickets
			Use the Sterling WMS application to plan trips by batching tasks
			Use "MULTI-LOC-CART" for picking
			Number of containers allowed per cart location is 2
			Pick Seq is Move Out
			Deposit Seq is Move In
			Productivity type is "BATCH-PICK-AND-PACK"

Task Type	Task Type Description	Activity Code	Summary
PCK-008	Batch Pick and Pack – User Sugg. Packing	Batch Pick	Product is picked onto inventory case
			Pack while pick
			Execute task using Printed Tickets
			Use the Sterling WMS application to plan trips by batching tasks
			Use "MULTI-LOC-CART" for picking
			Number of containers allowed per cart location is 2
			Pick Seq is Move Out
			Deposit Seq is Move In
			Minimize #Batches per shipment
			Productivity type is "BATCH-PICK-AND-PACK"
PCK-009	Batch Pick – No Packing	Batch Pick	Product is picked onto inventory case
			Execute task using mobile devices
			Dispatch task as soon as they are generated
			Use the Sterling WMS application to plan trips by batching tasks

Task Type	Task Type Description	Activity Code	Summary
			Use "SINGLE-LOC-CART" for picking
			Number of shipments allowed per cart location is 8
			Pick Seq is Move Out
			Deposit Seq is Move In
			Productivity type is "BATCH-PICK"
PCK-010	Batch Pick – No Packing using Printed Tickets	Batch Pick	Product is picked onto inventory case
			Execute task using Printed Tickets
			Use the Sterling WMS application to plan trips by batching tasks
			Use "SINGLE-LOC-CART" for picking
			Number of shipments allowed per cart location is 8
			Pick Seq is Move Out
			Deposit Seq is Move In
			Productivity type is "BATCH-PICK"
PCK-011	Retrieve Case	Item Pick	Product is picked directly into equipment
			Apply LPN while picking

Task Type	Task Type Description	Activity Code	Summary
			Execute task using Mobile devices
			Dispatch task as soon as possible
			Perform Task in multiple steps
			Limit #users to Zero
			Pick Sequence is "Pick Sequence"
			Drop Sequence is "Putaway Sequence"
			Productivity Type is "CASE-RETRIEVAL"
PCK-012	Retrieve Pallet	Item Pick	Product is picked directly onto equipment
			Apply LPN while picking
			Execute Task using mobile devices
			Dispatch task as soon as possible
			Limit #users to Zero
			Pick Sequence is "Pick Sequence"
			Drop Sequence is "Putaway Sequence"
			Productivity Type is "PALLET-RETRIEVAL"
PCK-013	Retrieve using Printed Tickets	Item Pick	Product is picked directly into equipment

Task Type	Task Type Description	Activity Code	Summary
			Execute Task using Printed Tickets
			Use the Sterling WMS batching algorithm to plan trips
			Use "TURRET-TRUCK" for picking
			#Requests allowed per location is 1
			Pick Seq is Move Out
			Drop Seq is Move In
			Productivity Type is "SKU-RETRIEVAL"
PCK-014	Sort Products Picked	Item Pick	Product is picked directly onto equipment
			Execute Task using mobile devices
			Dispatch task as soon as possible
			Limit #users to Zero
			Pick Sequence is "Pick Sequence"
			Drop Sequence is "Putaway Sequence"
			Productivity Type is "SORT-UNITS"

C.5.12 Task Execution Exceptions

The following are the factory default settings for task execution exceptions:

Deposit Exceptions

Exception Code	Description	Mark Target Location as Full	Request Alternate Location
01	Putaway exception	Yes	Yes

Pick Exceptions

Code	Description	Inventory Status	Hold Task	Suggest Alternate Location
02	Pick exception	Shortage	Yes	Yes

SKIP Exceptions

Code	Description
03	Skip Location suggested

C.6 Requirements - VAS

There are no factory default settings for Requirements - VAS.

C.7 Requirements - Outbound

The Requirements - Outbound related factory defaults are:

- [Catch All Shipment Group](#)
- [Wave Cancellation Reason Codes](#)
- [Pack Planning](#)

C.7.1 Catch All Shipment Group

Create one Shipment Group as follows:

Attribute	Value
Group ID	DEFAULT
Description	Default shipment Group
Seq#	100
Priority	Normal
Effective from	1st Jan 2004
Effective Until	31st Dec 2025
Shipment Selector	All Shipments
Wave Size Constraints	Max #Shipments
Automatically accept every wave	Yes
#Waves Released concurrently	3
Wave Release Schedule	All days of week, from morning 6:00 AM to 11:00 PM

Define Pick Strategy as follows:

- Use ORDER-PICK for LTL/TL shipments.
- For all other shipments, use Batch Picking.

Pick Location Assignment – Active Area Picking

Description	UOM	Task Type – Order Pick	Task Type – Batch Pick	Task Type – Item Pick
Unit/Piece Picks	EACH	PCK-001	PCK-007	PCK-014

First Search in:

Locations with Inventory	Dedicated Locations	Dynamic Slot	Pick Fence	Cross Dock
A1	Yes	Yes	No	No

Pick Location Assignment – Bulk Storage Case Picking

Description	UOM	Task Type – Order Pick	Task Type – Batch Pick	Task Type – Item Pick
Case Picks	CASE	PCK-005	PCK-009	PCK-014

First Search in:

Locations with Inventory	Dedicated Locations	Dynamic Slot	Pick Fence	Cross Dock
BULK-1	No	No	No	No

Then Search in:

Locations with Inventory	Dedicated Locations	Dynamic Slot	Pick Fence	Cross Dock
A1	No	No	No	No

Pick Location Assignment – Bulk Storage Pallet Picking

Description	UOM	Task Type – Order Pick	Task Type – Batch Pick	Task Type – Item Pick
Pallet Picks	PALLET	PCK-004	PCK-009	PCK-014

First Search in:

Locations with Inventory	Dedicated Locations	Dynamic Slot	Pick Fence	Cross Dock
BULK-1	No	No	No	No

Then Search in:

Locations with Inventory	Dedicated Locations	Dynamic Slot	Pick Fence	Cross Dock
A1	No	No	No	No

C.7.2 Wave Cancellation Reason Codes

The following are the factory default settings for wave cancellation reason codes:

Reason Code	Description
DE	Data Entry Error
CSR	Customer Service Request
PLAN	Regular Wave Planning – What if Scenario
OT	Others
INVALID-SG	Incorrect shipment group set up

C.7.3 Pack Planning

The following are the factory default settings for pack planning:

Limit #SKUs per Case	12
Do not Mix	Mark For
Over Pack	For all containerization category with case volume less than 1728 Cubic Inches

For Parcels:

Shipping Container Marking	SCM Required with Content
SCM Label Level	Apply SCM on all cases
Containerization is done by system	Yes
Containerization is performed	During wave release

D

Copy Node Functionality

This appendix lists all configurations that get copied when copying a node.

1. Warehouse Management

a. Warehouse Layout

- Location Size
- Location Capacity
- Location Storage Code
- Zones
- Zone Enterprise Storage Constraints
- Locations

The transaction information such as available capacity is reset to location capacity.

- SKU Dedication
- Equipments and Stations

b. Inventory

- Inventory Status
- Inventory Adjustment Reason
- Inventory Status Transition
- Adjustment Location Sequence
- Count Programs
- Count Strategy

- Location Monitor Rule (and Filter)
- c. Receiving**
 - Putaway Rules
 - Location Preference
 - Node Disposition
- d. Picking**
 - Shipment Group
 - Sort Strategy
 - PLA Activity Determination
 - PLA Upgrade UOM
 - PLA Zone Attributes
 - PLA Retrieval Attribute
 - Shipment Selector Attribute
 - Wave Size Constraint
 - PLA UOM Condition
 - PLA Activity Task Type
 - PLA Condition Attribute
 - PLA Zone Set
- e. VAS**
 - Retrieval Strategy
 - Though retrieval strategy is listed under VAS, it is also copied for other activity groups.
- f. Packing**
 - Pack Strategy
- g. Task Management**
 - Batch Rule
 - Execution Exception
 - Productivity Type

- Task Type
- User Skill Set
- h. System Administration
 - Bar Code Translation
 - Device
 - Device Sub Type
 - Label Preferences
- 2. Application Platform (miscellaneous)
 - Calendar
 - Calendar Shift
 - Calendar Shift Effective Period
 - Calendar Day Exception
 - Common Code
 - Ship Node
 - Team
 - Data Security Enterprise
 - Data Security Doc Type

E

Onboarding Enterprise to Node Functionality

This appendix lists all the configurations that get copied when onboarding an enterprise to a node.

1. Warehouse Management
 - a. Warehouse Layout
 - Location Capacity
 - Zone Enterprise Storage Constraints
 - SKU Dedication
 - b. Inventory
 - Inventory Adjustment Reason
 - Count Strategy
 - Location Monitor Rule (and Filter)
 - c. Receiving
 - Putaway Rules
 - Activity Constraints
 - Receiving Preferences
 - Receiving Disposition
 - d. Packing
 - Pack Strategy
 - e. System Administration

- Label Preferences
- 2. Application Platform (miscellaneous)
 - Organization Enterprise



F







Setting Up a Weighing Scale

A weighing scale is a device that records a container's weight. Weighing scales are typically used in manifest, pack, and weighing stations to record weight.

Important: To set up a weighing scale correctly, install the weighing scale at each pack or manifest station that requires weighing scale integration. For more information about installing the weighing scale, see *Selling and Fulfillment Foundation: Installation Guide*.

To configure and set up a weighing scale:

1. From the tree in the application rules side panel, choose System Administration > Devices. The DeviceSetup window displays.
2. Select Device Types and choose . The Device Type pop-up window displays.
3. In Device Type, enter a name for the device type. For example, Weighing Scale.
4. In Description, enter a brief description of the device type.
5. Choose . The Device Type pop-up window displays. You can view the Weighing Scale device type that you entered.
6. Select Weighing Scale and choose . The Device Sub Type pop-up window displays.
7. In Device Sub Type, enter a name for the device sub type. For example, WeighScale-Desc.
8. In Description, enter a brief description for the device sub type.

9. Choose . The Device Type pop-up window displays. Choose  to view WeighScale-Desc device sub type that you entered.
10. Select the WeighScale-Desc device sub type for which you want to create a device.
11. Choose . The Device pop-up window displays.
12. In Device ID, enter the device identifier. For example, WeighScale-01.
13. In Additional Attributes panel, under Device Attributes, enter the parameter value for the ClassName as
`com.yantra.ycp.ui.io.YCPToledoPSImpl`.
14. Enter the parameter value for the PortId to which the weighing scale is connected, if applicable. For example, COM1.
15. Choose . Now, configure a station for the weighing scale and associate it with a location. For more information on creating and configuring a station, see [Section 3.11, "Defining Stations"](#).
16. To associate the weighing scale to a station identifier, from the tree in the application rules side panel, choose Warehouse Layout > Stations.
17. In the Stations window, choose  to view the Station Id. For example, PACK_STATION_1.
18. Select the PACK_STATION_1 station-id. Choose . The Station Device Association pop-up window displays.
19. In the Device Association panel, select Weighing Scale device type and WeighScale-01 device identifier from the drop-down list.
20. Choose .

Note: The user has to create a new resource by copying the Weigh_Station(YME 125) from the HSDE_Pack(exuipack) and change the Java Server Page parameter from `/wms/wmsmanifest/detail/exuimanifest_detail_anchor.jsp` to `/wms/wmspack/detail/exuipack_pack_container.jsp?AutoWeigh=Y`. Create a new menu and associate the resource to it. Using this menu, the warehouse can pack the items in the container and directly click on Close Container to perform the Weigh, Save, and Close Container actions at the same time.

A

Account Number With Hub field, 428

accounting bin location

creating, 121

Action Name field, 1015

Actions, 719

VAS

viewing, 730

actions

count, 243

viewing, 258

creating, 935, 1038

move request, 209

viewing, 214

outbound picking

viewing, 543

pack

viewing, 822

purchase order receipt

viewing, 337

receipt process type details, 324

return receipt

viewing, 405

task management

viewing, 935, 1038

transfer order receipt

viewing, 372

warehouse layout, 101

viewing, 104

WMS inventory

viewing, 198

activities

pack

defining, 741

receiving, 274

shipping

defining, 837

Activity Code, 291, 447, 453, 618

VAS

creating, 616

deleting, 618

modifying, 618

activity code

creating, 274

deleting, 276

modifying, 276

packing

creating, 742

defining, 742

deleting, 744

modifying, 744

activity codes

quality control

creating, 432

deleting, 434

modifying, 434

shipping

creating, 838

deleting, 840

modifying, 840

transportation

creating, 873

deleting, 875

modifying, 874

Activity Constraints

Shipping

setting up for container pallets, 842

- Activity Group field, 280
- Activity List, 618
- Add Activity, 712
- Add Instruction, 712
- Adhoc Move Location, 972
- Adhoc Move Pick, 972
- adjustment location sequence
 - configuring, 122
 - creating, 123
 - deleting, 125
 - modifying, 124
- adjustment reason code field, 120
- Adjustment Sequence, 122, 124
- adjustment sequence number, 124
- administering an organization, 11
- administering multiple organizations, 11
- administrator organizations, 11
- Agent Criteria Group field, 1013
- Alias Type, 980
- Allocate Work Order, 726
- Application Identifier, 978
- Application menu, 8
- Application rules side panel, 10
 - accessing configuration screens, 11
 - using, 10
- application rules side panel
 - determining inheritance, 11
 - overriding a configuration rule, 14
- Applications, 7
- Applications Manager, 1
 - actions
 - special characters, 30
 - troubleshooting errors, 27
 - using Applications Manager's lookup functionality, 27
 - using lists and list filtering, 27
 - using online help, 27
 - using special characters, 27
 - viewing the user logged into the Applications Manager, 27
 - Application menu, 8
 - Applications, 7
 - layout, 7
 - starting, 7

B

- bar code field, 60
- Bar Code Translations
 - creating, 976
 - creating new from existing, 980
 - defining, 975
 - deleting, 982
 - modifying, 981
 - moving up, moving down, 981
- Bar Code Type, 975, 977
- Bar Code Types
 - creating, 973
 - default set, 972
 - defining, 971
 - deleting, 975
- bar code validation, 976
- Bar Code Validation Source, 979
- Bar Codes
 - Code 128, 971
 - Code 39, 971
 - ISBN, 971
 - MAXICODE, 971
 - PDF417 Code, 971
 - UPC, 971
- bar codes
 - defining, 971
 - setting up, 6
- Batch, 972
- Batch Sheet for picking, 983
- batch statuses
 - defining, 879
 - modifying, 879
- BOL Prefix field, 1013
- Build Case field, 380
- Build Pallet field, 380
- Business models, 2
 - marketplaces, 3
 - multi-divisional corporations, 2
 - third-party logistics models, 2

C

- Cancel Move, 1098
 - Cancellation Failed, 1098

- full, 790
- inventory containers, 793
 - creating, 794
 - defining, 793
 - deleting, 795
 - modifying, 795
- loose, 791
- outbound containers, 793, 799
- post-pick, 791
- pre-pick, 791
- shipping containers, 799
 - activity constraints, 802
 - creating, 799
 - deleting, 801
 - modifying, 801
- Copy Node feature, 19
- Copying a WMS Node, 18
- corporate count requests
 - purge criteria, 271
- count
 - actions, 243
 - viewing, 258
 - conditions, 242
 - viewing, 256
 - count programs
 - creating, 235
 - defining, 235
 - deleting, 239
 - modifying, 239
 - count request
 - cancellation reasons, 231
 - count strategy
 - defining, 264
 - deleting, 268
 - modifying, 267
 - setting up, 264
 - defining, 225
 - modification rules
 - setting up, 240
 - pipeline details
 - viewing, 247
 - pipelines, 242
 - process type details
 - viewing, 243
 - purge criteria, 268
 - service definitions, 243
 - viewing, 262
 - statuses, 242
 - viewing, 253
 - transactions, 242
 - viewing, 249
- count modification rules
 - setting up, 240
- count programs
 - creating, 235
 - defining, 235
 - deleting, 239
 - modifying, 239
- count request cancellation reasons
 - creating, 231
 - creating new from existing, 233
 - defining, 231
 - deleting, 234
 - modifying, 234
- count request cancellation reasons field, 233
- count requests
 - defining, 225
- count strategy
 - defining, 264
 - deleting, 268
 - modifying, 267
 - setting up, 264
- create, 114, 178, 229
- Create Work Order, 726
- customer classifications
 - creating, 830
 - defining, 830
 - deleting, 832
 - modifying, 832
- customer definitions
 - creating, 833
 - defining, 833
 - deleting, 837
 - modifying, 836
- customer masters
 - creating, 833
 - deleting, 837
 - modifying, 836
- customers
 - defining, 829

D

Date on Which Task is Expected to be Completed field, 1029
Day Starts At field, 1016
Decrease Priority, 712
dedicate location
 defining, 72
 deleting, 74
 setting up, 72
dedicated location, 65
 setting up, 66
Default Declared Value field, 1013
Default Label Format, 986
Default No. of Copies, 83, 96, 997
defining, 856
delete, 99, 185, 860, 869
Description, 720
details window, 24
determining inheritance, 11
device attributes, 967
device sub types
 creating, 959
 defining, 959
 deleting, 961
 modifying, 961
Device Type, 958
device types
 creating, 956
 defining, 956
 deleting, 959
 modifying, 958
devices
 creating, 962
 creating new from existing, 967
 defining, 955, 962
 deleting, 970
 device attributes, 967
 setting up, 967
 modifying, 970
 setting up, 6
Difference between Capacity and Demand within _% does not require resolution field, 1017
disposition code field, 353

Dock Scheduling Required field, 62
Document Description, 985
drag and drop window, 25
DUNS Number field, 428

E

Efficiency, 1022
End Position, 979
Ends At field, 1016
enterprise
 creating a participation with a node, 19
 offboarding, 20
 onboarding, 20
 removing a participation with a node, 20
Enterprise field, 67
enterprise organization level, 12
Enterprise-level administrator, 1
environment variable
 INSTALL_DIR, liii
 INSTALL_DIR_OLD, liii
equipment
 cart, 79
 defining, 75
 equipment device association
 deleting, 89
 setting up, 87
 equipment group, 76
 equipment ID
 creating, 84
 creating new from existing, 86
 defining, 84
 deleting, 87
 modifying, 86
 equipment type, 76
 creating, 77
 deleting, 80
 modifying, 79
 location name, 79
 location size code, 79
 modeled as license plates, 76
 modeled as locations, 76
 print format preference
 deleting, 83
 setting up, 82

- sorter, 79
- task type association
 - adding, 80
 - available task types, 80, 81
 - removing, 80
 - setting up, 80
 - subscribed task types, 80, 81
- equipment device association
 - deleting, 89
 - setting up, 87
- Equipment Id, 972
- equipment ID
 - creating, 84
 - creating new from existing, 86
 - defining, 84
 - deleting, 87
 - modifying, 86
- equipment location size code, 79
- equipment location type field, 79
- equipment modeled as field, 78
- equipment type
 - creating, 77
 - deleting, 80
 - modifying, 79
- equipment type field, 78
- error
 - troubleshooting, 29
- execution exceptions
 - defining, 918
 - deposit, 918
 - creating, 923
 - deleting, 927
 - modifying, 926
 - pick, 918
 - creating, 919
 - deleting, 922
 - modifying, 922
 - setting up, 6
 - skip, 918
 - creating, 927
 - deleting, 930
 - modifying, 930
- Export License Number field, 1013
- External Application field, 1014

F

- filtering application rules, 17
- Fixed Length Bar Code Attributes, 978
- full containerization
 - defining, 790

G

- GLN field, 1013

H

- high-volume pick pack warehouse
 - implementing factory set up, 6
 - reference implementation, 6
- Hold Types
 - shipping
 - defining, 870
 - sales order, 870
 - transfer order, 870
- hub organization level, 11, 12
- Hub-level administrator, 1

I

- Identified By Parent As field, 1013
- Include Only Planned Shipments field, 556
- Increase Priority, 712
- inheritance rules, 12
- installation rules
 - batch statuses
 - modifying, 879
 - defining, 877
 - setting up, 6
 - task references
 - adding, 881
 - task statuses
 - modifying, 878
- INSTALL_DIR, liii
- INSTALL_DIR_OLD, liii
- Inventory
 - module introduction, 4
- inventory

- accounting bin location, 121
 - creating, 121
- adjustment location sequence
 - creating, 123
 - deleting, 125
 - modifying, 124
- adjustment reason
 - creating, 118
 - creating new from existing, 125
 - deleting, 126
 - modifying, 125
- adjustment sequence, 122
- adjustment sequence number, 124
- configuring, 111
- count
 - defining, 225
- count requests
 - defining, 225
- host adjustment reason code, 121
 - creating, 121
- inventory transition rule, 126
- purge criteria
 - setting up, 203
- putaway preferences, 276
- receiving, 31, 273
- shipping, 31
- shipping and delivering, 32
- storage preferences, 130
- transition rule
 - creating, 127
 - deleting, 130
 - modifying, 130
- inventory adjustment reason, 122
 - creating, 118
 - creating new from existing, 125
 - defining, 118
 - deleting, 126
 - modifying, 125
- Inventory adjustment reason code, 118
- inventory adjustment sequence
 - defining, 122
- location
 - creating, 124
 - searching, 124
- location ID, 124
 - zone
 - creating, 124
 - searching, 124
 - zone ID, 124
- Inventory Case, 972
- Inventory Container, 972
- inventory containers
 - creating, 794
 - defining, 793
 - deleting, 795
 - modifying, 795
- Inventory Inquiry, 972
- Inventory module, 4
- inventory organization level, 12, 13
- Inventory Pallet, 972
- inventory status
 - creating, 115
 - defining, 115
 - deleting, 117
 - modifying, 117
- inventory status field, 51
- inventory transition rule
 - creating, 127
 - defining, 126
 - deleting, 130
 - modifying, 130
- Item, 972
- Item Classification, 135, 622
- Item or Case, 972
- Item or Inventory Case, 972
- Item or Inventory Container, 972
- Item or Shipping Container, 972
- Item Tag, 972

L

- Label Format, 83, 96, 997
- License Expiration Date field, 1013
- List filtering, 28
- list window, 23
- load modification rules
 - defining, 871
- loading another organization's configuration
 - rules, 16
- Locale field, 429

Location, 972

location

- setting up, 66
- bar code, 60
- capacity tracked, 37
- creating new from existing, 67
- dedicate location, 65
 - defining, 72
 - deleting, 74
 - setting up, 66, 72
- dedicating, 65
- dedication search window, 72
- dedication tab, 66
- defining, 56
- deleting, 71
- Dock Scheduling Attributes, 62
- dock zone, 56
- empty location, 69
- enterprise attributes, 74
- freeze for picking, 61, 70
- freeze for putaway, 61, 70
- freeze for variance, 63
- intransit location, 56
- location type, 60
- modifying, 70
- monitoring rules
 - creating, 186
 - creating new from existing, 192
 - defining, 186
 - deleting, 193
 - modifying, 193
- picking sequence, 65
- primary information
 - setting up, 59
- putaway sequence, 65
- regular location, 56
- search window, 67
- setting up, 57, 59
- single deep, 38
- size code, 60, 69
- staging location, 56, 61, 62
- storage code, 61, 70
- storage code field, 42
- transaction attributes, 63

type, 69

velocity code, 61, 70

virtual location, 56

zone, 49

Location Barcode, 972

Location Or Inventory Container, 972

location search window, 67

location size code, 69

location size code field, 37

location size codes

- capacity constraints, 38

- creating, 35

- defining, 35

- deleting, 39

- modifying, 39

location storage code, 61, 70

location storage codes

- creating, 40

- defining, 40, 430

- deleting, 42

- modifying, 42

location type, 69

locations

- storage codes

- defining, 430

Loftware Label Manager, 986

Log, 739, 944

Log File Name, 739, 944

lookup functionality, 27

lookup icons, 27

loose containerization

- defining, 791

LTL carrier preferences

- creating, 861

- creating new from existing, 869

- defining, 861

- deleting, 869

- modifying, 869

LTL parcel preferences

- check digit determination algorithm

- creating new from existing, 867

- deleting, 868

- modifying, 868

- setting up, 865

M

- made to customer (MTC), 67
- made to order (MTO), 67
- Maintain Inventory Cost field, 1014
- Manifest Scan Initiation, 972
- Marketplaces, 3
- mobile location, 56
- Modification Rules
 - Shipping
 - Sales Order, 870
 - Transfer Order, 870
 - VAS
 - setting up, 710
- modification rules
 - load
 - defining, 871
 - pack
 - setting up, 805
 - shipping
 - load, 871
- modify, 185
- Modify Work Order, 726
- monitoring rules
 - creating, 186
 - creating new from existing, 192
 - defining, 186
 - deleting, 193
 - modifying, 193
- move request
 - actions, 209
 - viewing, 214
 - cancellation reasons
 - creating, 222
 - creating new from existing, 224
 - defining, 222
 - deleting, 225
 - modifying, 225
 - conditions, 209
 - viewing, 212
 - defining, 209
 - purge criteria
 - setting up, 219
 - service definitions, 209
 - viewing, 217

- transactions, 209
 - viewing, 210
- move request cancellation reason field, 224
- move request cancellation reasons
 - creating, 222
 - creating new from existing, 224
 - defining, 222
 - deleting, 225
 - modifying, 225
- MTC, 74
- MTC (made to customer), 67
- MTO, 74
- MTO (made to order), 67
- Multi-divisional corporations, 2

N

- New PrePrinted License Plate, 972
- Node
 - copying a node, 18
- node
 - configuring, 32
 - creating a participation with an enterprise, 19
 - defining, 31
 - defining attributes, 35
 - deleting the current node, 21
 - removing a participation with an enterprise, 20
- node configuration
 - copying an existing node to new node, 18
- node item attribute
 - creating, 206
 - defining, 206
 - deleting, 208
 - modifying, 208
- Node Type field, 1013
- nodes
 - defining attributes, 1012

O

- offboarding an enterprise, 20
- offboarding an enterprise from a node, 20
- offline mode

- cancel move, 1098
- cancel wave, 1096
- onboarding an enterprise, 19
- onboarding an enterprise to a node, 20
- online help
 - using, 29
- order release
 - event, 337
- organization level, 12, 13
- Organization level rules, 12
- organization levels, 11
- organizations rules
 - loading another organization's rules, 11
- Outbound Container, 972
- outbound containers, 799
- outbound pick process model, 533
- outbound picking
 - actions
 - viewing, 543
 - conditions
 - viewing, 541
 - pipelines
 - viewing, 534
 - service definitions
 - viewing, 547
 - statuses
 - viewing, 539
 - transactions
 - viewing, 537
- overriding a configuration rule, 15

P

- pack modification rules
 - setting up, 805
- pack planning
 - containerization
 - defining, 784
 - defining parameters, 785
- Pack Scan Initiation, 972
- Pack Shipping Carton, 972
- Pack Shipping Pallet, 973
- Pack SKU Initiation, 972
- Packing
 - module introduction, 5
- packing
 - activity constraints
 - defining, 744
 - defining, 741
 - putaway preferences
 - defining, 784
 - retrieval strategy
 - defining, 784
- Packing module, 5
- Packing Slip, 983
- Pallet Build, 973
- parcel carrier preferences
 - creating, 856
 - creating new from existing, 859
 - defining, 856
 - deleting, 860
 - modifying, 860
- parcel preferences
 - LTL
 - check digit determination
 - algorithm, 865, 867, 868
- participation between enterprise and node
 - creating, 19
 - removing, 20
- Pick Date is within following hours field, 556
- Pick Date Past Due field, 556
- Pick Initiation, 973
- Pick Into Inventory Case, 973
- Pick Into Inventory Pallet, 973
- Pick Location Assignment
 - defining, 648
- pick location assignment (PLA)
 - defining, 479
- Pick Location Rules
 - assigning for all items, 650
 - assigning for specific items, 656
- pick location rules
 - all items
 - assigning, 568, 577, 586
 - assigning for all items, 481
 - assigning for specific items, 486
 - specific items
 - assigning, 574, 584
- pick planning
 - defining, 549

- shipment group
 - defining, 549
- shipment selectors
 - defining, 552
- pick process
 - batch picking, 560
 - item picking, 560
 - order picking, 560
- pick strategy, 560
 - defining, 560
- Picking
 - module introduction, 5
- picking
 - purge criteria
 - setting up, 610
- Picking module, 5
- picking process, 533
- picking sequence number, 65
- Pipeline
 - VAS
 - viewing, 723
- pipeline, 709
- pipeline details
 - count
 - viewing, 247
 - purchase order receipt
 - viewing, 328
- Pipeline determination
 - condition variables, 722
- pipeline determination
 - condition variables, 246, 327, 361, 396, 534, 811
- Pipelines, 718
- pipelines
 - count, 242
 - outbound picking
 - viewing, 534
 - pack
 - viewing, 813
 - receipt process type details, 324
 - return receipt
 - viewing, 396
- PLA (pick location assignment)
 - defining, 479
- Planning Calendar field, 1017
- post-pick containerization
 - defining, 791
- Preferred UOM for Planning field, 1016
- pre-pick containerization
 - defining, 791
- Print Document, 83, 96, 985, 997
- Print Documents
 - creating, 984
 - defining, 984
 - deleting, 986
 - modifying, 986
- Print Format Preference, 997
- print format preference
 - deleting, 83, 96
 - setting up, 82, 95
- Printer ID, 990, 993
- printers, 959
 - HP LaserJet 5P, 959
 - Zebra 170, 959
- Prints
 - defining, 983
 - Label Formats
 - defining, 987
 - Loftware
 - label format, 987
 - mapping XML file, 987
 - Loftware Label Manager, 987
 - Participant Print Preferences
 - defining, 993, 994
 - participant level, 993
 - participant organization, 993
 - setting up print format preferences, 994
 - printer - station association, 987
 - Printer Preferences
 - defining, 988
 - setting up for group, 988
 - setting up for user, 991
 - User Printer Preferences
 - defining, 987
- prints
 - setting up, 6
- Priority, 447, 454
- PRO number
 - defining, 861
- PRO number generation scheme field, 863

- process model
 - outbound pick, 533
 - pack
 - defining, 810
- Process Models
 - Shipping
 - defining, 871
- process models
 - load
 - defining, 872
 - shipping
 - load, 872
- Process Type, 720
- Process Type Details
 - Shipping
 - defining, 870
 - VAS
 - viewing, 719
- process type details
 - count
 - viewing, 243
 - defining, 325
 - pack
 - defining, 808
 - viewing, 808
 - purchase order receipt
 - viewing, 324
 - receipt
 - defining, 323
 - return order
 - viewing, 393
 - shipping
 - defining, 872
 - load, 871
 - sales order, 870, 871
 - transfer order, 870, 871
 - transfer order
 - viewing, 358
- Process Type Name, 720
- product class
 - creating, 112
 - creating new from existing, 114
 - defining, 112
 - deleting, 115
 - modifying, 114
- Product Class field, 67
- Product Line, 135, 622
- Productivity type
 - equipment types
 - setting up, 910
- productivity types
 - creating, 900
 - defining, 899, 900
 - deleting, 915
 - modifying, 915
 - productivity references
 - setting up, 906
 - SAM definitions
 - setting up, 902
 - setting up, 6
 - task types
 - setting up, 908
- purchase order
 - defining, 320
 - receipt modification rules
 - setting up, 321
- purchase order receipt
 - actions
 - viewing, 337
 - conditions
 - viewing, 335
 - receiving disposition
 - creating, 348
 - creating new from existing, 351
 - defining, 348
 - deleting, 352
 - modifying, 351
 - receiving preferences
 - creating, 343
 - modifying, 347
 - service definitions
 - viewing, 341
 - statuses
 - viewing, 333
 - transactions
 - viewing, 330
- Purge Code, 738
- Purge Criteria
 - VAS
 - setting up, 736

- purge criteria
 - corporate count request, 271
 - count, 268
 - inventory
 - setting up, 203
 - move request
 - setting up, 219
 - picking
 - setting up, 610
 - productivity types
 - setting up, 916
 - retention days, 205
 - setting up, 268, 271
 - task management
 - setting up, 941
- Purge transactions, 1104
- Purge Work Order, 726
- put on variance hold field, 53
- Putaway Preferences
 - VAS
 - creating for container with unknown contents, 686
 - creating for multi-SKU, 670
 - creating for single-SKU, 660
 - creating new for container with unknown contents from existing, 700
 - creating new for multi-SKU from existing, 684
 - creating new for single-SKU from existing, 668
 - defining, 660
 - deleting for container with unknown contents, 701
 - deleting for multi-SKU, 685
 - deleting for single-SKU, 669
 - modifying for container with unknown contents, 701
 - modifying for multi-SKU, 684
 - modifying for single-SKU, 668
 - setting up for container with unknown contents case, 693
 - setting up for container with unknown contents pallet, 687
 - setting up for multi-SKU case, 677
 - setting up for multi-SKU pallet, 671
 - putaway preferences
 - container with unknown content cases
 - setting up putaway strategy, 527
 - container with unknown contents
 - creating, 304, 516
 - creating new from existing, 318, 530
 - defining, 304, 516
 - deleting, 319, 531
 - modifying, 319, 531
 - container with unknown contents - cases
 - setting up putaway strategy, 315
 - container with unknown contents - pallets
 - setting up putaway strategy, 308, 520
 - container with unknown contents cases
 - setting up, 311, 523
 - container with unknown contents pallets
 - setting up, 305, 517
 - defining, 277, 489, 784
 - multi level container
 - creating, 288, 500
 - creating new from existing, 302, 514
 - defining, 288, 500
 - deleting, 303, 515
 - modifying, 303, 515
 - multi level container cases
 - setting up, 295, 507
 - multi level container pallet
 - setting up, 501
 - multi level container pallets
 - setting up, 289
 - multi SKU
 - creating, 288, 500
 - creating new from existing, 302, 514
 - defining, 288, 500
 - deleting, 303, 515
 - modifying, 303, 515
 - multi SKU cases
 - setting up, 295, 507
 - multi SKU pallet
 - setting up, 501
 - multi SKU pallets
 - setting up, 289
 - multi-level containers - cases
 - setting up putaway strategy, 299, 510
 - multi-level containers - pallets

- setting up putaway strategy, 292, 504
- multi-SKU cases
 - setting up putaway strategy, 299, 510
- multi-SKU pallets
 - setting up putaway strategy, 292, 504
- quality control
 - defining, 489
- single SKU
 - creating, 278, 490
 - creating new from existing, 286, 498
 - defining, 278, 489
 - deleting, 287, 499
 - modifying, 286, 498
- single-SKU
 - setting up putaway strategy, 283, 494
- putaway sequence number, 65
- Putaway Strategy
 - setting up, 623, 631, 638, 664, 674, 680, 690, 697
- putaway strategy
 - container cases
 - setting up, 851
 - container pallets
 - setting up, 844
 - defining, 798, 804
 - multi level container pallets
 - setting up, 757
 - multi SKU pallets
 - setting up, 757

Q

- Quality Control
 - module introduction, 5
- quality control
 - activities, 432
 - activity codes
 - creating, 432
 - deleting, 434
 - modifying, 434
 - activity constraints
 - defining, 434
 - defining, 431
 - putaway preferences
 - defining, 489
 - retrieval strategy, 474

- Quality Control module, 5
- quality control process, 431
- queue management, 7

R

- reason code, 702
- reason codes
 - count request cancellation
 - defining, 231
 - defining, 883
 - setting up, 6
 - task modification, 883
 - deleting, 884
 - modifying, 884
 - setting up, 883
- receipt modification rules
 - return order receipt
 - setting up, 390
 - setting up, 321
 - transfer order
 - setting up, 355
- receipt pipeline details
 - transfer order receipt
 - viewing, 362
- receipt process type details
 - actions, 324
 - conditions, 324
 - defining, 323
 - pipelines, 324
 - services, 324
 - statuses, 324
 - transactions, 324
- Receiving
 - module introduction, 4
- receiving
 - activities, 274
 - activity code
 - creating, 274
 - deleting, 276
 - modifying, 276
 - location storage codes
 - defining, 430
 - purchase order
 - defining, 320

- putaway preferences, 276
 - defining, 277
- return order
 - defining, 389
- transfer order
 - defining, 354
- vendors
 - defining, 422
- receiving disposition
 - defining, 415
- purchase order receipt
 - creating, 348
 - creating new from existing, 351
 - defining, 348
 - deleting, 352
 - modifying, 351
- return receipt
 - creating, 416
 - creating new from existing, 419
 - deleting, 420
 - modifying, 419
- transfer order receipt
 - creating, 383
 - creating new from existing, 386
 - defining, 382
 - deleting, 387
 - modifying, 386
- receiving disposition codes
 - purchase order receipt
 - creating, 352
 - defining, 352
 - modifying, 354
 - return receipt
 - creating, 420
 - defining, 420
 - modifying, 422
 - transfer order receipt
 - creating, 387
 - defining, 387
 - modifying, 389
- Receiving module, 4
- receiving preferences
 - purchase order receipt
 - creating, 343
 - modifying, 347
 - return receipt
 - creating, 411
 - modifying, 415
 - transfer order receipt
 - creating, 378
 - modifying, 382
- Release Work Order, 726
- Remove Activity, 712
- removing participation
 - between node and enterprise, 20
- replenishment, 171
- replenishment strategy
 - creating, 178
 - defining, 171
 - deleting, 185
 - modifying, 185
- request types
 - creating, 228
 - creating new from existing, 229
 - defining, 228
 - deleting, 230
 - modifying, 230
- Requesting Activity Group, 447, 454
- Requires Serial Number Tracking field, 1014
- Resequencing Activity, 712
- Resource Planning Enabled field, 1013
- Resource Pool, 1022
- Resource Pool Description, 1019
- Resource Pool ID, 1019
- Retention Days, 738
- Retrieval Strategy
 - defining, 643
 - VAS
 - creating, 643
 - defining target location, 646
 - defining target zone, 647
 - deleting, 658
 - modifying, 658
- retrieval strategy
 - creating, 474
 - defining, 474, 784, 798, 804
 - deleting, 488
 - modifying, 487
 - pick location assignment
 - defining, 479

- pick location rules
 - assigning for all items, 481
 - assigning for specific items, 486
- target location
 - defining, 477
- target zone
 - defining, 478
- return order
 - defining, 389
 - process type details
 - viewing, 393
- return order receipt
 - receipt modification rules
 - setting up, 390
- return receipt
 - actions
 - viewing, 405
 - conditions
 - viewing, 403
 - pipelines
 - viewing, 396
 - receiving disposition
 - creating, 416
 - creating new from existing, 419
 - deleting, 420
 - modifying, 419
 - receiving disposition codes
 - creating, 420
 - defining, 420
 - modifying, 422
 - receiving preferences
 - creating, 411
 - modifying, 415
 - service definitions
 - viewing, 409
 - statuses
 - viewing, 401
 - transactions
 - viewing, 398
- RF Scanners, 959
- Rollback Segment, 738

S

SAM (Standard Allowable Minutes), 899

- Save Directory, 986
- search window, 22
- See Value Added Services, 5
- Sequence# field, 1028
- Serial Or Inventory Container, 973
- Serial Scan, 973
- Service Definitions
 - VAS
 - viewing, 734
- service definitions
 - count, 243
 - viewing, 262
 - creating, 940, 1042
 - move request, 209
 - viewing, 217
 - outbound picking
 - viewing, 547
 - pack
 - viewing, 826
 - purchase order receipt
 - viewing, 341
 - return receipt
 - viewing, 409
 - task management
 - viewing, 939, 1042
 - transfer order receipt
 - viewing, 376
 - warehouse layout, 101
 - viewing, 108
 - WMS inventory
 - viewing, 201
- Services, 719
- services
 - receipt process type details, 324
- set, 59
- Shipment, 973
- Shipment Entry Allowed field, 380
- shipment group
 - defining, 549
- shipment groups
 - advanced parameters
 - defining, 599
 - batch picking parameters
 - determining, 586
 - carrier sorting parameters

- defining, 595
- item pick parameters
 - determining, 564
- order pick parameters
 - specifying, 576
- pick location assignment
 - defining, 567, 577, 586
- pick location rules
 - assigning for all items, 568, 577, 586
 - assigning for specific items, 574, 584
- pick strategy
 - defining, 560
- shipment sorting parameters
 - defining, 597
- sort strategy
 - defining, 595
- wave size constraints
 - defining, 557
- shipment selectors
 - defining, 552, 553
- shipment sorting parameters
 - defining, 597
- Shipping
 - module introduction, 5
- shipping
 - activities
 - defining, 837
 - activity codes, 838, 840
 - activity constraints
 - container, 841
 - container cases, 841, 848, 855
 - defining, 840
 - putaway strategy, 844, 851
 - defining, 829
 - LTL carrier preferences, 861
 - modification rules
 - load, 871
 - parcel carrier preferences, 856
 - PRO number, 861
- Shipping Carton, 973
- Shipping Container, 973
- Shipping Containers, 793
- shipping containers, 799
 - creating, 799
 - defining, 799
 - deleting, 801
 - modifying, 801
- Shipping Labels, 983
- Shipping Modification Rules
 - defining, 870
- Shipping module, 5
- Shipping Or Inventory Container, 973
- Shipping Pallet, 973
- Sign In window, 7
- Standard Allowable Minutes (SAM), 899
- Start Position, 979
- station, 99
 - defining, 89
 - station ID
 - creating, 96
 - creating new from existing, 98
 - defining, 96
 - deleting, 99
 - modifying, 98
 - station type
 - creating, 89
 - defining, 89
 - deleting, 92
 - modifying, 92
- Station Device Association, 99
- station device association
 - deleting, 101
 - setting up, 99
- station ID
 - creating, 96
 - creating new from existing, 98
 - defining, 96
 - deleting, 99
 - modifying, 98
- station device association
 - deleting, 101
 - setting up, 99
- station type
 - creating, 89
 - defining, 89
 - deleting, 92
 - modifying, 92
- print format preference
 - deleting, 96
 - setting up, 95

- task type association
 - adding, 93
 - available task types, 93, 94
 - removing, 93
 - setting up, 93
 - subscribed task types, 93, 94
- Status
- VAS
 - viewing, 726
- Statuses, 718
- statuses
 - count, 242
 - viewing, 253
 - defining, 818
 - outbound picking
 - viewing, 539
 - pack
 - viewing, 818
 - purchase order receipt
 - viewing, 333
 - receipt process type details, 324
 - return receipt
 - viewing, 401
 - transfer order receipt
 - viewing, 368
- Sterling Order Management, 1014
- Sterling Supply Collaboration, 347, 382, 414
- Sterling Warehouse Management System (Sterling WMS), 4
- Sterling WMS, 1014
 - modules
 - Inventory, 4
 - Packing, 4
 - Picking, 4
 - Quality Control, 4
 - Receiving, 4
 - Shipping, 4
 - System Administration, 4
 - Task Management, 4
 - VAS, 4
 - Warehouse Layout, 4
 - receiving, 273
- Sterling WMS field, 1014
- Sterling WMS Sterling Warehouse Management System), 4
- Storage Code, 136, 144, 151, 159, 166, 291
- Storage Code field, 282
- storage preference
 - container with unknown contents
 - creating, 156
 - deleting, 170
 - modifying, 170
 - setting up cases, 163
 - setting up pallets, 157
 - container with unknown contents - cases
 - setting up putaway strategy, 166
 - container with unknown contents - pallets
 - setting up putaway strategy, 160
 - defining, 130
 - multi level container
 - creating, 141
 - deleting, 155
 - modifying, 155
 - setting up cases, 148
 - setting up pallets, 142
 - multi SKU
 - creating, 141
 - deleting, 155
 - modifying, 155
 - setting up cases, 148
 - setting up pallets, 142
 - multi-level container pallets
 - setting up putaway strategy, 145
 - multi-level containers - cases
 - setting up putaway strategy, 151
 - multi-SKU cases
 - setting up putaway strategy, 151
 - multi-SKU pallets
 - setting up putaway strategy, 145
 - single SKU
 - creating, 132
 - creating new from existing, 140
 - deleting, 141
 - modifying, 140
 - single-SKU
 - setting up putaway strategy, 136
- Supervisor ID, 1019
- supply type field, 52
- System Administration
 - module introduction, 6

- setting up
 - bar codes, 6
 - devices, 6
 - prints, 6
- system administration
 - defining, 955
- System Administration module, 6
- system integration, 710

T

- Target Location, 646
- Target Zone, 646
- Task Management
 - module introduction, 6
 - setting up
 - execution exception, 6
 - installation rules, 6
 - productivity types, 6
 - reason codes, 6
 - task types, 6
 - user constraints, 6
- task management
 - defining, 877
 - purge criteria
 - setting up, 941
 - task types
 - creating, 893
 - deleting, 894
 - modifying, 894
 - prioritizing, 894
- Task Management module, 6
- task modification reasons
 - deleting, 884
 - modifying, 884
 - setting up, 883
- Task Reference, 973
- task references
 - adding, 881
 - defining, 881
- Task Status
 - modifying, 878
- task statuses
 - defining, 878
 - modifying, 878
- task type association
 - equipment
 - adding, 80
 - available task types, 80, 81
 - removing, 80
 - setting up, 80
 - subscribed task types, 80, 81
 - station type
 - adding, 93
 - available task types, 93, 94
 - removing, 93
 - setting up, 93
 - subscribed task types, 93, 94
- Task Type field, 1029
- task type logic flow
 - batching subflow, 890
 - count
 - understanding, 886
 - count flow, 887
 - end flow, 892
 - mobile device
 - understanding, 886
 - mobile device subflow, 891
 - outbound picking
 - understanding, 886
 - outbound picking flow, 888
 - start flow, 886
 - task type wizard, 886
- task type wizard
 - defining, 893
- task types
 - creating, 893
 - deleting, 894
 - modifying, 894
 - prioritizing, 894
 - setting up, 6
- Third Party Logistics Node field, 1014
- third-party logistics
 - nodes, 1014
- Third-party logistics models, 2
- Tote Id, 973
- Transactions, 718
 - VAS
 - viewing, 725
- transactions

- count, 242
 - viewing, 249
- creating, 932, 1034
- move request, 209
 - viewing, 210
- outbound picking
 - viewing, 537
- pack
 - viewing, 816
- purchase order receipt
 - viewing, 330
- receipt process type details, 324
- return receipt
 - viewing, 398
- task management
 - viewing, 931, 1034
- transfer order receipt
 - viewing, 364
- warehouse layout, 101
 - viewing, 101
- WMS inventory
 - viewing, 194
- transfer order
 - defining, 354
 - process type details
 - viewing, 358
 - receipt modification rules
 - setting up, 355
- transfer order receipt
 - actions
 - viewing, 372
 - conditions
 - viewing, 370
 - receipt pipeline details
 - viewing, 362
- receiving disposition
 - creating, 383
 - creating new from existing, 386
 - defining, 382
 - deleting, 387
 - modifying, 386
- receiving disposition codes
 - creating, 387
 - defining, 387
 - modifying, 389

- receiving preferences
 - creating, 378
 - modifying, 382
- service definitions
 - viewing, 376
- statuses
 - viewing, 368
- transactions
 - viewing, 364
- Translation Sequence, 978
- transportation
 - activity codes, 873, 874, 875
 - defining, 873
- troubleshooting help, 29

U

- UCC-128, 983
- unit of measure (UOM), 67
- UOM (unit of measure), 67
- UPS Standard carrier labels, 983
- user constraints
 - setting up, 6
- user skills
 - defining, 895
- user task types
 - adding, 896
 - defining, 895
 - deleting, 897
 - modifying, 897
- user zones
 - defining, 895

V

- Validation Service, 980
- Value Added Services
 - defining, 615
- Value Added Services module, 5
- Value Added Services (VAS)
 - module introduction, 5
- Variable Length Code, 978
- variance hold
 - setting up, 63, 226
- VAS Modification Rules, 710

- VAS (Value Added Services)
 - module introduction, 5
- velocity code field, 45, 61, 70
- velocity codes
 - creating, 43
 - creating new from existing, 45
 - defining, 43
 - deleting, 46
 - modifying, 46
- Vendor Classification Code field, 425
- Vendor Classification field, 428
- vendor classifications
 - creating, 423
 - defining, 423
 - deleting, 425
 - modifying, 425
- vendor definitions
 - creating, 426
 - defining, 426
 - deleting, 429
 - modifying, 429
- vendors
 - classifications
 - creating, 423
 - defining, 423
 - deleting, 425
 - modifying, 425
 - defining, 422
 - definitions
 - creating, 426
 - defining, 426
 - deleting, 429
 - modifying, 429
- VICS Bill Of Lading (BOL), 983
- view, 358

W

- Warehouse Layout
 - module introduction, 4
- warehouse layout
 - actions, 101
 - viewing, 104
 - conditions, 101
 - viewing, 103
 - defining, 31
 - service definitions, 101
 - viewing, 108
 - transactions, 101
 - viewing, 101
- Warehouse Layout module, 4
- wave cancellation reasons
 - creating, 609
 - defining, 608
 - deleting, 610
 - modifying, 609
- wave release
 - timelines
 - deleting, 608
 - modifying, 608
- Wave release prints document set, 983
- wave release schedules
 - creating, 605
 - defining, 605
 - deleting, 608
 - modifying, 608
- wave size constraints
 - creating, 601
 - defining, 557, 601
 - deleting, 604
 - modifying, 604
- waves
 - cancellation reasons
 - defining, 608
 - release schedule
 - defining, 605
 - wave size constraints
 - defining, 601
- WMS inventory
 - actions, 193
 - viewing, 198
 - conditions, 193
 - viewing, 196
 - service definitions, 194
 - viewing, 201
 - transactions, 193
 - viewing, 194
- WMS node
 - current node
 - deleting, 21

- WMS 6.2 field, 1015
- work area, 22
 - details window, 24
 - drag and drop window, 25
 - list window, 23
 - search window, 22
- Work Day Hours field, 1016
- Work Order Allocation Considerations
 - creating, 706
 - defining, 706
 - deleting, 709
 - modifying, 709
- Work Order Canceled, 728
- Work Order Cancellation Reason Code
 - creating, 702
 - creating new from existing, 704
 - defining, 702
 - deleting, 705
 - modifying, 705
- Work Order Cancellation Reason Code field, 704
- Work Order Confirmation, 973
- Work Order Confirmed, 728
- Work Order Created, 728
- Write To Log File, 739
- deleting, 55
- inventory status transitions tab, 51
- modifying, 55
- put on variance hold, 53
- task execution preferences tab, 52
- zone constraints tab, 51

Z

- zone
 - constraints, 47
 - forward pick zone, 50
 - primary bulk zone, 50
 - variance hold
 - setting up, 226
- zone constraints
 - adding, 898
 - deleting, 899
 - modifying, 898
- zone constraints tab, 51
- zone field, 49
- Zone Id, 973
- zone level constraints, 47
- zones
 - creating, 47
 - defining, 46

