



DB2 UDB is the
world's fastest database



DB2 FastStart



Announcing:
DB2 UDB
Express Edition
DB2 and the .NET Framework
Available in
DB2 UDB 8.1.2!



DB2. Information Management
Software

Copyright © 2005 Brainware Bvba

Disclaimer

- The information contained in this presentation is based on techniques, algorithms, and documentation published by the several authors and companies, and in addition is the result of research. It is therefore subject to change at any time without notice or warning.
- The information contained in this presentation has not been submitted to any formal tests or review and is distributed on an "As is" basis without any warranty, either expressed or implied.
- The use of this information or the implementation of any of these techniques is a client responsibility and depends on the client's ability to evaluate and integrate them into the client's operational environment.
- While each item may have been reviewed for accuracy in a specific situation, there is no guarantee that the same or similar results will be obtained elsewhere.
- Clients attempting to adapt these techniques to their own environments do so at their own risks.
- Foils, handouts, and additional materials distributed as part of this presentation or seminar should be reviewed in their entirety.

IBM is a registered trademark of International Business Machines Corporation.

DB2 is a trademark of IBM Corp.

DB2. Information Management
Software

Copyright © 2005 Brainware Bvba 2



Agenda

- Overview and Positioning of IBM Information Management Software
- DB2 Database Objects
- Application Enablement Components
- Building the Application
- Deploying the Application
- Running the Application
- Troubleshooting Features
- Migrating to DB2
- Wrap-up



IBM Information Management Software

- **Business intelligence**
 - Gather, manage & analyze data, generating information to develop insight for informed decisions.
- **Content management**
 - Manage volume and capture the value of all information contained within multiple content types.
- **Database servers**
 - Build the foundation for information on demand to meet the full range of your business needs.
- **Database tools**
 - Enhance the performance of IBM IMS and DB2 using tools designed to meet your needs.
- **Information integration**
 - Collect and integrate diverse and distributed information in real time across your enterprise.

IBM Information Management Software

- **DB2 UDB Data Warehouse Enterprise Edition**
 - Represents the latest milestone in the evolution of DB2. The Data Warehouse Enterprise Edition is IBM's complete enterprise level offering for customers building the most demanding Business Intelligence solutions, and is part of the IBM DB2 UDB framework for BI.
- **DB2 UDB Data Warehouse Standard Edition**
 - A powerful business intelligence platform based on DB2 UDB Workgroup Edition and BI applications to build data warehouses and analytic applications, bundled together and attractively priced for mid-market sized businesses.
- **DB2 UDB Data Warehouse Base Edition**
 - provides mid- to large-scale enterprises with a data warehouse and data mart infrastructure that includes DB2 and integrated OLAP capability that can support departmental warehouses or lines of business, or enterprise data warehouses where there is a need for scalability and performance



IBM Information Management Software

- **DB2 Data Warehouse Enterprise Edition**
 - DB2 Universal Database Enterprise Server Edition
 - DB2 Universal Database Database Partitioning Feature (large clustered server support) DB2 Cube Views (OLAP acceleration)
 - DB2 Intelligent Miner Modeling, Visualization, and Scoring (powerful data mining and integration of mining into OLTP applications)
 - DB2 Office Connect Enterprise Web Edition (Spreadsheet integration for the desktop)
 - DB2 Query Patroller (rule-based predictive query monitoring and control) DB2 Warehouse Manager Standard Edition (enhanced extract/transform/load services supporting multiple Agents)
 - DB2 Information Integrator Standard Edition (in conjunction with DB2 Warehouse Manager to provide native connectors for accessing data from Oracle databases, Teradata databases, Sybase databases, and Microsoft SQL server databases)
- **DB2 Data Warehouse Standard Edition**
 - DB2 Universal Database Workgroup Server Unlimited Edition
 - DB2 Cube Views
 - DB2 Intelligent Miner Modeling, Visualization, and Scoring
 - DB2 Office Connect Enterprise Web Edition
- **DB2 Data Warehouse Base Edition**
 - DB2 UDB Enterprise Server Edition, V8.2
 - DB2 Cube Views, V8.2

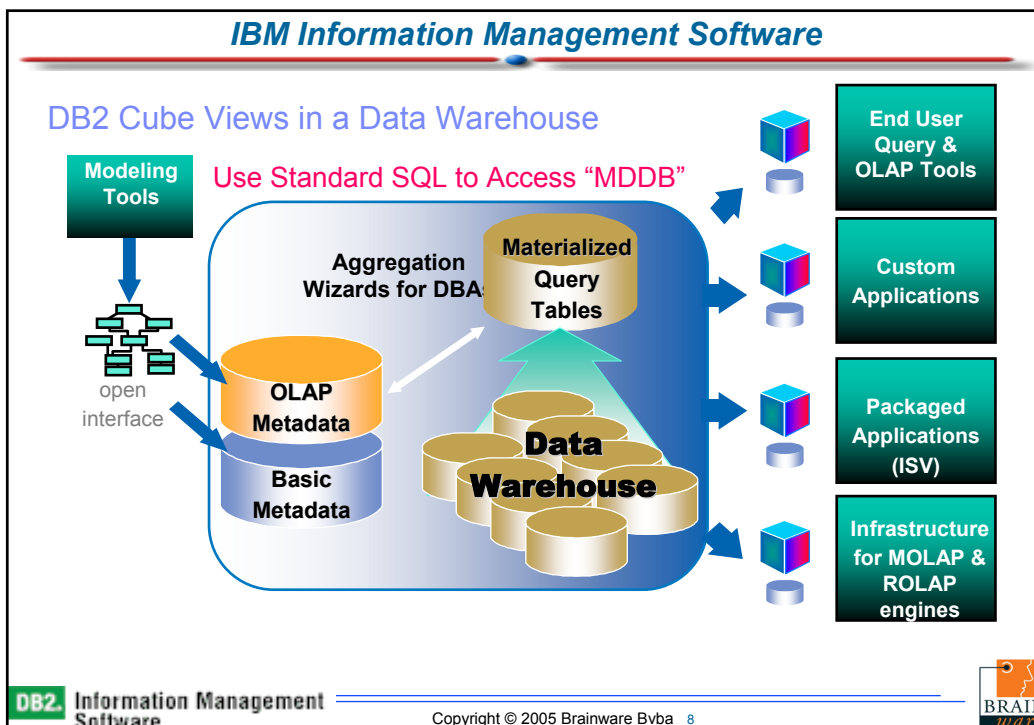
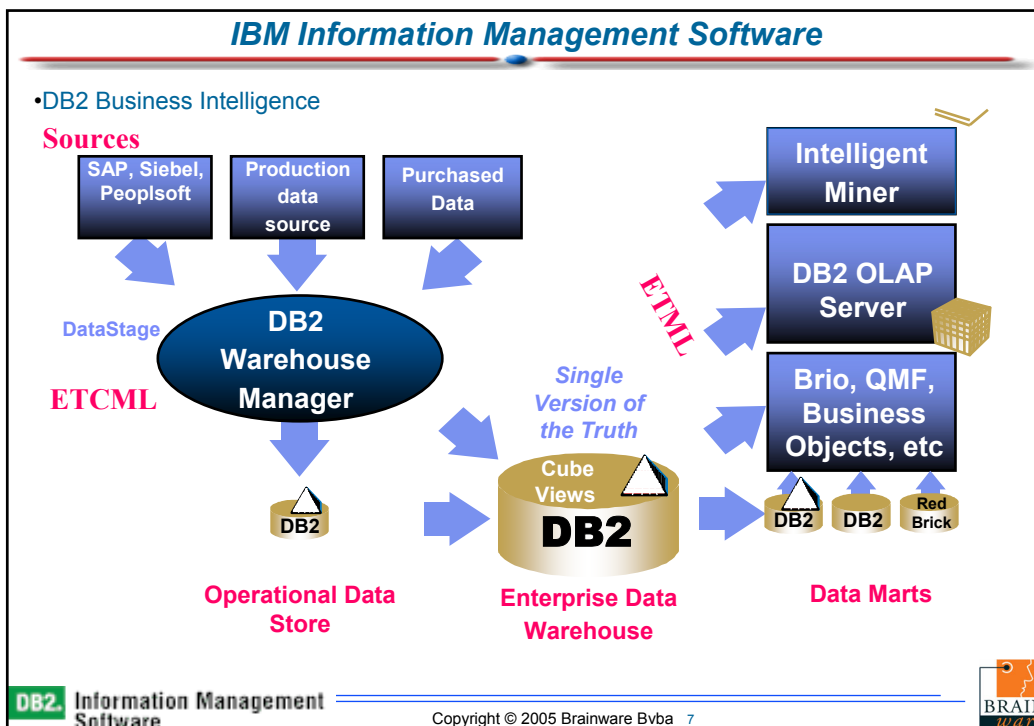

IBM Information Management Software

DB2 Cube Views support Queries & Business Partners

Multi-level Aggregate "Caches"

MQT's for

- ▶ Faster cube load
- ▶ Faster drill-through reports
- ▶ Faster hybrid analysis
- ▶ Faster Ad-hoc analysis
- ▶ Faster Reporting

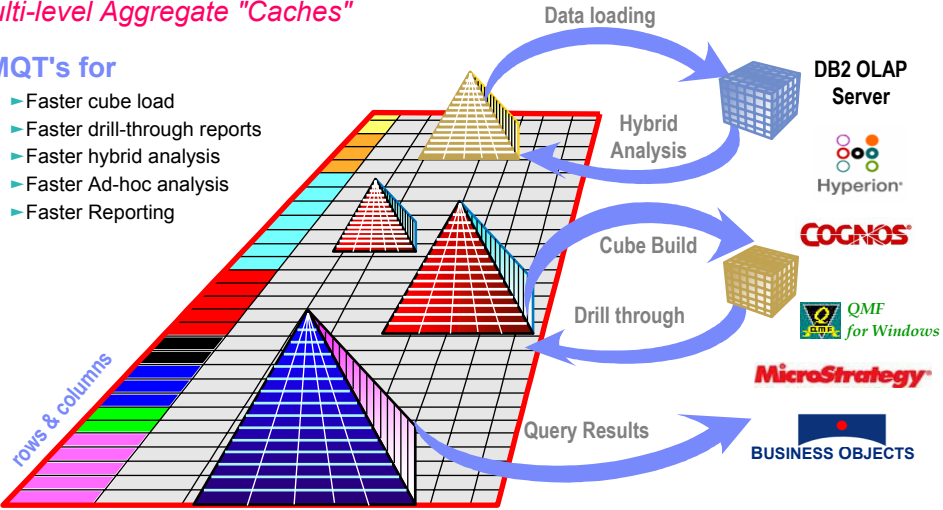

IBM Information Management Software

Performance Advisor of DB2 Cube Views

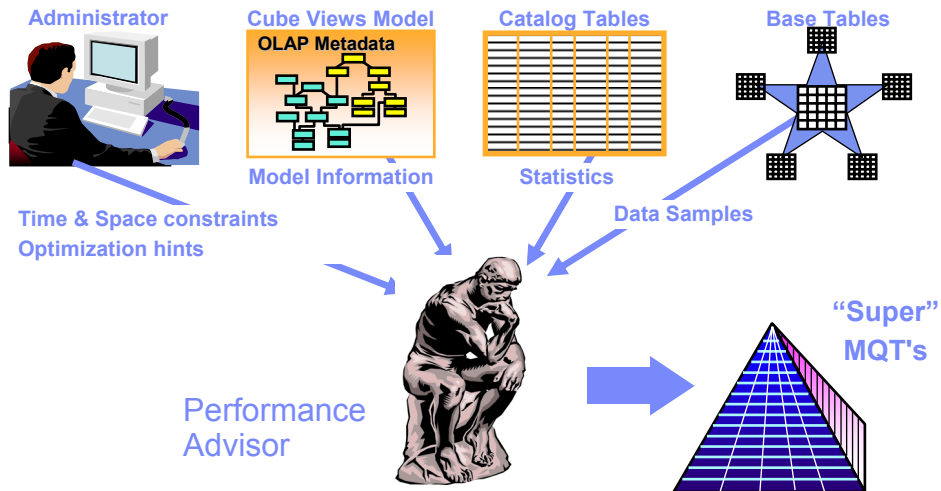

IBM Information Management Software

- **What is content management?**

Information is one of your most valuable assets, and getting information into the hands of the right people easily and efficiently is central to sustaining a competitive advantage. However, with ever-growing volumes of critical information distributed across a variety of systems and in various formats, managing this information effectively is a constant challenge.

- In the past, different forms of information—such as Web content, e-mail, product information or customer data—were kept in separate, disconnected repositories. Today, that's not a viable solution. To thrive in an on demand environment, you need flexible, cost-effective solutions to manage any type of information, including structured data and unstructured content. You need solutions that enable data and content to be integrated with multiple applications and processes—distributed or shared throughout and beyond your organization.

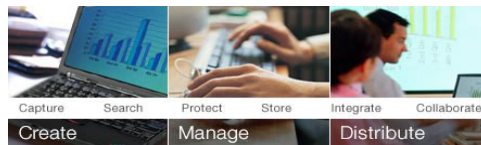

IBM Information Management Software

- **DB2 CommonStore for SAP** archives SAP data.
- **DB2 CommonStore** for Lotus Domino and **DB2 CommonStore for Exchange Server** archive email and attachments.
- **DB2 Records Manager** is an award-winning, certified engine to e-records enable business applications.
- **DB2 Content Manager for Multiplatforms** manages images, documents, web content, multimedia assets and more with built-in workflow and content integration and is also available for iSeries and zSeries.
- **DB2 Content Manager OnDemand for Multiplatforms** provides output/report management and is also available for iSeries and zSeries.
- **DB2 Document Manager** manages the complete lifecycle of business documents.

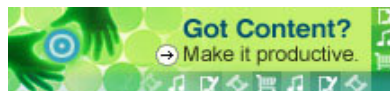

IBM Information Management Software

- **DB2**
 - Database management system that delivers a flexible and cost-effective database platform to build robust on demand business applications.
- **Cloudscape**
 - Provides developers a small footprint, standards-based Java database that can be tightly embedded into any Java based solution.
- **Informix**
 - Delivers superior application performance for transaction intensive environments.
- **U2**
 - High performance, scalable information management environments for embedding in vertical applications.

IBM Information Management Software

- **DB2 Universal Database V8.2**
 - IBM's relational database management system for AIX, Linux, HP-UX, Sun, and Windows.
- **DB2 Universal Database for z/OS**
 - Use DB2 on the mainframe to run powerful enterprise applications, and make e-commerce a reality.
- **DB2 Connect**
 - Make your company's host data directly available to your Personal Computer and LAN-based workstations.
- **DB2 Everyplace**
 - DB2 relational database and enterprise synchronization architecture for mobile and embedded devices.

IBM Information Management Software

- **DB2 Universal Database**

- **Open/flexible** DB2 supports a wide variety of popular platforms and key standards as well as a wide variety of packaging options to match the needs unique to your business.
- **Performance and Scale** A proven leader in the ability to handle millions of transactions or many terabytes of data, DB2 scales to handle any workload on your choice of architectures.
- **Easy to Use** Streamlining and simplifying database administration through self-managing technologies and management tools.
- **Cost Effective** Delivering outstanding TCO through aggressive pricing, industry leading support and numerous efficiencies that deliver more capability with minimum hardware requirements and leverage existing skills.
- **Foundation for information on demand** Reliability, availability, and security are more critical than ever with the dynamics of the global economy. DB2 never sacrifices these fundamentals when embracing new technologies, like web services, necessary for today's challenges.

IBM Information Management Software

- Database servers DB2 Universal Database

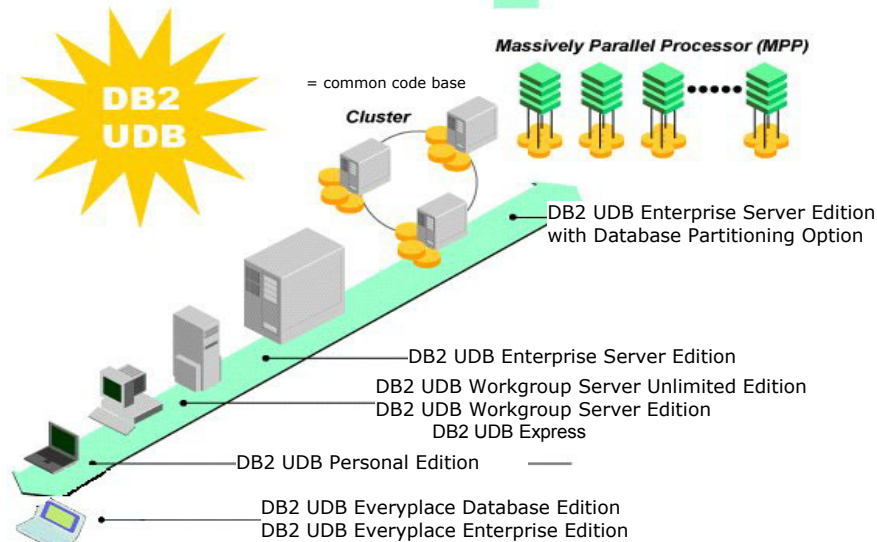

IBM Information Management Software

- **IBM Cloudscape™ V10.0**
 - a pure, open source-based Java relational database management system that can be embedded in Java programs and used for online transaction processing (OLTP). A platform-independent, small-footprint (2MB) database, Cloudscape V10.0 integrates tightly with any Java-based solution.
 - IBM is open sourcing Cloudscape as Derby available on the Apache Incubator Project site.
 - Runs on any standard Java Virtual Machine (JVM), allowing developers to "write once, deploy anywhere."
 - Embeddable inside Java applications on the server, desktop or in pervasive devices.
 - Includes Cloudscape Network Server -- providing multi-user connectivity to IBM Cloudscape databases within a single system or over a network using standard Distributed Relational Database Architecture™ (DRDA®) protocol.
- **Delivers zero-administration functionality to eliminate the need for a dedicated database administrator.**



IBM Information Management Software

- **IBM Cloudscape & Derby**
- **Single code line, at Apache**
 - **IBM Cloudscape is snapshot of Derby**
 - + Service & Support
 - + Windows, Linux or Java installer
 - + Packaging of DB2 Universal JDBC Driver
 - + Translated documentation & error messages
 - + Sample database
 - **IBM Cloudscape team continues development on Derby**

IBM Information Management Software

- IBM Cloudscape DB2 UDB Compatible
- **Compatible at the programming model level**
 - **SQL**
 - Cloudscape's syntax is a subset of the DB2 UDB syntax
 - Application's written against Cloudscape can be migrated to DB2 UDB, when required
 - **JDBC**
 - Built-in embedded driver for Cloudscape
 - DB2's JDBC driver used for network connectivity
 - Cloudscape & DB2's JCC (Java Common Client) teams work together

IBM Information Management Software

- **Informix**
 - Informix Dynamic Server (IDS)
 - Exceptional online transaction processing (OLTP) database for enterprise and workgroup computing.
 - Informix C-ISAM™
 - A library of C-language functions that efficiently manages indexed sequential access method (ISAM) files.
 - Informix Extended Parallel Server (XPS)
 - High-end database server that provides scalable data warehousing for the largest, most demanding, business-critical applications.
 - Informix OnLine Extended Edition
 - Easy-to-use, embeddable, relational database server for low-to-medium workloads.
 - Informix Standard Engine (SE)
 - Embeddable database server designed for developing small- to medium-sized applications that need the power of SQL without any database administration requirements.
 - IBM Red Brick™ Warehouse
 - Database server designed to meet the specialized requirements for business-critical, high-demand data analysis.

IBM Information Management Software

U2

- **UniData®**
 - An extended relational database designed for embedding in vertical applications. UniData simplifies information management and query logic, providing more power for online high-transaction applications.
- **UniVerse®**
 - An extended relational database designed for embedding in vertical applications. This nested relational data model means intuitive data modeling and fewer resulting tables.
- **RedBack®**
 - A scalable, object-based infrastructure for the U2 databases that includes an object-abstraction tool, allowing for development within a variety of technologies such as Java and ASP/JSP.
- **SystemBuilder™**
 - The Rapid Application Development (RAD) tool for IBM U2 databases, providing a structured process-based environment in which to create and maintain enterprise applications.
- **wIntegrate®**
 - Advanced terminal emulation application enhancement tool for IBM U2 databases and other MultiValue databases

IBM Information Management Software

IBM DB2 and IMS Tools

The IBM® DB2 and IMS Tools are specifically designed to enhance the performance of IBM IMS and DB2 Universal Database for z/OS and for Linux, UNIX, and Windows. The tools support the newest versions of the databases right when they are available, making it easy to migrate from version to version and still benefit from tools support. Read the IBM DB2 and IMS Tools Overview for a comprehensive list of products and to learn how the tools are evolving to autonomic computing to help you discover the power of On Demand Business.

Select a DB2 Tool

Select an IMS Tool

Select an Information Integrator Tool

DB2 Tools for Linux, Unix, and Windows

The latest news on DB2 Tools for Multipatforms and for Workgroups. Read the Overview Fact Sheet.

Announced Sept 2004

• DB2 HP Unload, V2.2 *W*

Previously Announced

• DB2 Performance Expert, V2.1 *W*

• DB2 Test Database Generator, V2.1 *New*

• DB2 Recovery Expert, V1.1

• DB2 Table Editor, V4.3 *W*

• DB2 Web Query Tool, V1.3 *W*

W - Also supports Workgroups

Tool categories

• **Database administration tools** help you to administer DB2 and IMS.

• **Utilities management tools** help you to optimize the use of your DB2 and IMS utilities.

New / Enhanced DB2 z/OS Tools

Announced Dec 2004

• DB2 Archive Log Accelerator, V2.2

• DB2 Log Analysis Tool, V2.2

Announced Sept 2004

• DB2 HP Unload, V2.2

• DB2 SQL Perf. Analyzer, V2.2

• Tivoli OMEGAMON XE for DB2 for z/OS

New and Enhanced IMS Tools

Announced Dec 2004

• IMS Queue Control Facility, V2.1

Announced Sept 2004

• IMS Parameter Manager, V1.1 *New*

• IMS HP Fast Path Utilities, V2.1

• IMS HP Load, V2.1

• IMS HP Prefix Resolution, V3.1

• IMS Parallel Reorganization, V3.1

• IMS HP Image Copy, V3.2



Hot New Feature!

Register for Feb 2 Webcast - It's All About Performance!

Highlights

• New / enhanced DB2 and IMS Tools for z/OS announced Dec 7.

• See how DB2 Web Query Tool gives SBC web access.

• Learn how DB2 for z/OS V8 drives business value at Univar.

• Oct 27 Webcast Replay: IBM Information Integration Story

• New and enhanced DB2 and IMS Tools! (Sept, 2004).

• Register now for 2004 Fall/Winter IMS Tech Seminars near you.

• DB2 White Paper: Now is the Time to Migrate.

• Webcast replay: Learn how DB2 Tools Support

IBM Information Management Software

- Why do I care about Information Integration?
 - How many languages and API's do I need to learn
 - Do I consider the rest of the world to be stupid and useless?
 - Should I move all the data into my new database?
- There are several compelling reasons to move to a federated world as it allows you to work with a large diversity of information, explore the unique performance features of your existing systems and yet do all of this through a uniform view of the world.

It's here now
The next generation of
data integration software



IBM Information Management Software

- **Federation**
featuring WebSphere Information Integrator Content Edition for unstructured content and WebSphere Information Integrator Standard Edition for structured data accesses and integrates diverse and distributed stores in real time, regardless of where they reside.
- **Replication**
distributes, consolidates, and synchronizes information across complex, multi-platform, multi-vendor IT environments.
- **Enterprise Search**
featuring WebSphere Information Integrator OmniFind Edition, finds the most relevant corporate information with sub-second response from vast enterprise data sources.
- **Event Publishing**
captures database changes, formats them into XML messages, and publishes them for application integration.



IBM Information Management Software

- Why do I care about Information Integration?
- The UDB V8.2 SQL can be applied to whatever backend is accessed.

A Federated Data Server – Query distributed data as if it were a single source

- Define integrated view across diverse and distributed data
 - ▶ Wide range of data and content sources
 - ▶ Extensible to virtually any data source
- Query as if a single source
 - ▶ Use standard SQL query and SQL expressions
 - ▶ Include text semantics in the search
 - ▶ Surface specialized functions into SQL
 - ▶ Leverage query optimization and caching
- Compose XML documents
 - ▶ Combine diverse sources
 - ▶ Validate against DTDs or schema
- Publish results to a message queue
 - ▶ Familiar DB programming model
- Single source, relational updates

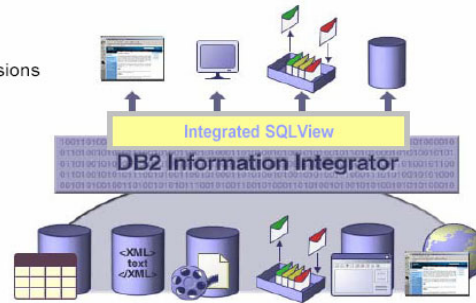

DB2, Oracle, SQL Server, Sybase, Teradata, OLE DB, ODBC, Excel, XML, message queues, Web services, flat files, document repositories, content repositories, LDAP directories, WWW, email databases, and more.

Agenda

- Overview and Positioning of IBM Information Management Software
- DB2 Database Objects
- Application Enablement Components
- Building the Application
- Deploying the Application
- Running the Application
- Troubleshooting Features
- Migrating to DB2
- Wrap-up



DB2 Database Objects

- DB2 Architecture

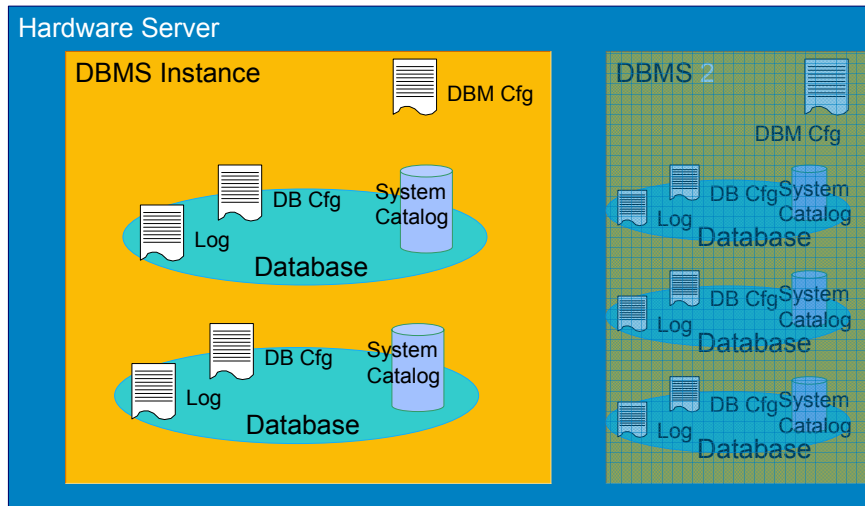

Database Structure

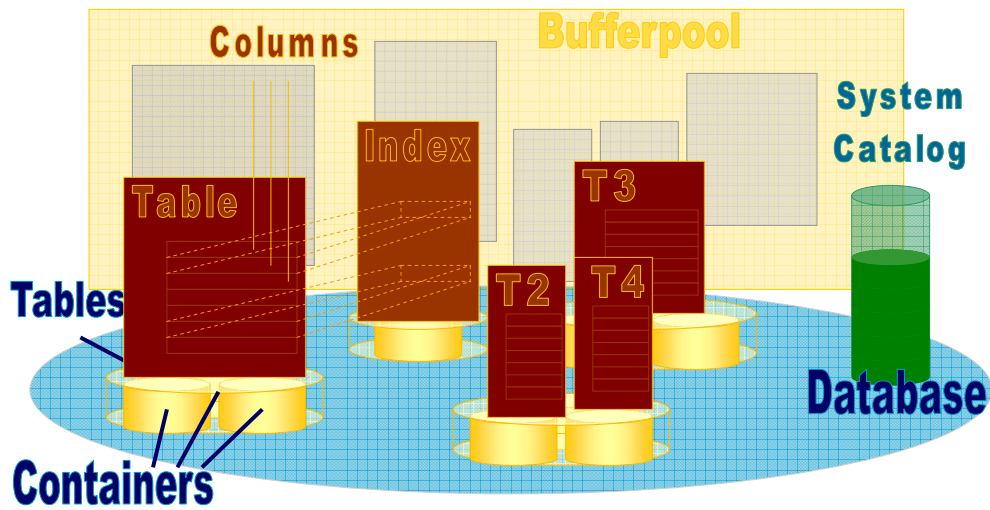

Bufferpools

- The bufferpool is an essential element in managing database performance
- By default each database has one bufferpool
- Each different page size requires a supporting bufferpool
- Each tablespace is assigned to a specific bufferpool

Tablespaces

- DB2 supports two different types of tablespace
 - System Managed (SMS)
 - Database Managed (DMS)
- Consist of containers which map to physical storage
- Page size for tablespaces may vary from 4K (default) to 32K
- By default all new objects are created in the user tablespace
- Most installations require a greater degree of control over physical placement
- Consider performance aspects including
 - Number of containers
 - Prefetch size

SMS Tablespace

Create regular tablespace TS00003
managed by system
using ('c:\U\Databases\F1DB\SMS\
extentsize 16
prefetchsize 16

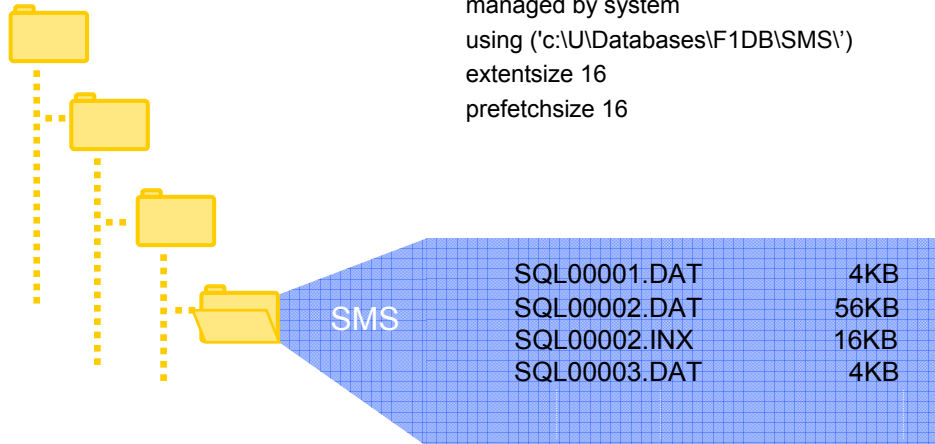

SMS Tablespaces - Characteristics

- New containers cannot be added after an SMS table space has been created
- Size of a container is the amount of disk space available to it.
- Space is not pre-allocated - allocated on-demand (one page at a time by default)
- SMS tablespaces can take advantage of OS file system caching and pre-fetching
- When a table is created in an SMS table space, it is assigned an object ID by DB2 and all objects associated with the table will share the ID
- The different objects associated with a table are stored in their own separate files and the names of these files are determined by the object ID and the object type

DMS Tablespace

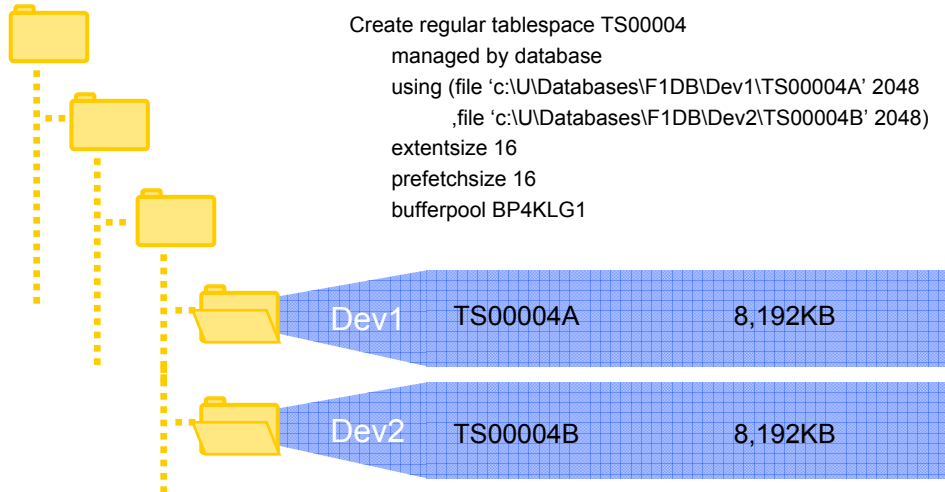

DMS Tablespaces- Characteristics

- DMS table space containers are usually file system files or raw devices
- New containers can be added or existing ones extended using DDL
- All space is pre-allocated at container creation/extension time.
- Table, index, and long objects can be in separate table spaces for a table.
- Space allocation is done a full extent at a time, and striping is done at the extent level

Tablespace Design

- **SMS Table Spaces**
 - Administration is very easy
 - Number of containers cannot be increased
 - Index and Long data of a table cannot be in separate tablespaces
 - Space is not allocated until it is required
 - Pre-fetching and caching done by OS may help performance (especially for LOB/LF objects which are not buffered by DB2)
 - If the table space will hold many small tables, then space overhead cost is less with SMS

Tablespace Design

- **DMS Table Spaces**
 - Space is pre-allocated
 - Space can be added to the table space after it has been created
 - A table can be split across multiple table spaces – that is index and long data can be in separate tablespaces
 - Performance is generally better than SMS as DB2 manages objects and data very well

Agenda

- Overview and Positioning of IBM Information Management Software
- DB2 Database Objects
- Application Enablement Components
 - Client Side and Server Side programming artifacts
 - DB2 Objects
 - Functions
 - Stored Procedures
 - Triggers
 - Integrating the application with non-DB2 information
 - Extended XML Support
 - Wrappers, Nicknames
- Building the Application
- Deploying the Application
- Running the Application
- Troubleshooting Features
- Migrating to DB2
- Wrap-up



Application Enablement Components

- Client Side and Server Side programming artifacts
- DB2 Application Objects
- User Defined Functions
- Stored Procedures
- Triggers

Application Enablement Components

- Client and Server Side Programming artifacts

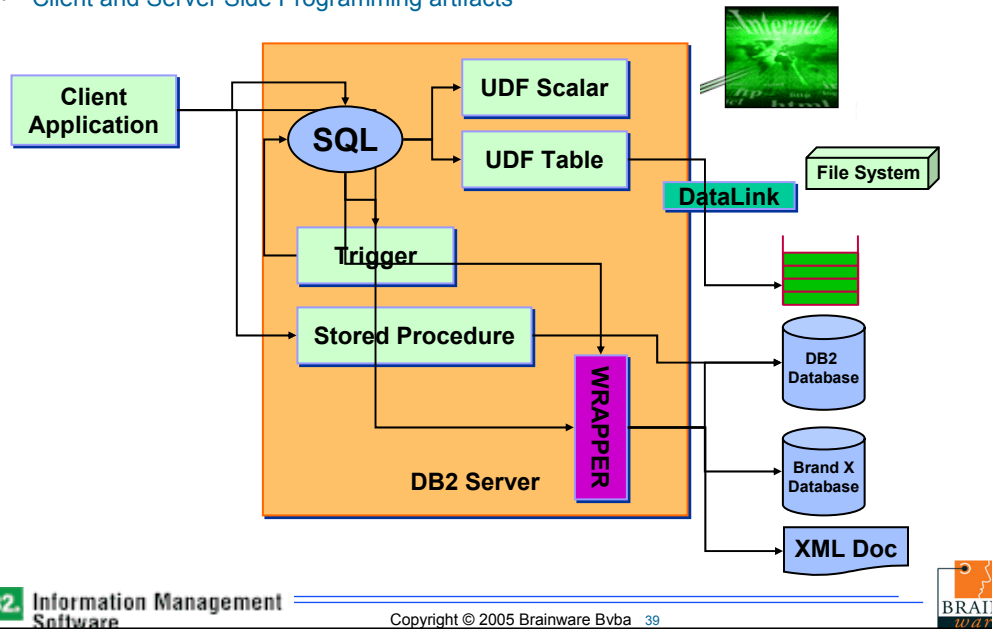

Application Enablement Components

- Application Connections
 - Client application includes UDB modules
 - Connection established between UDB code on client and server sides
 - Data and status information passed using SQLCA and SQLDA
 - User must be identified to UDB and have relevant permissions

SQL Options

- There are various options available for integrating SQL into an application
 - Embedded (Static and Dynamic) SQL
 - CLI
 - ODBC
 - Java (JDBC, SQLJ)
 - APIs
 - Others

Tables

- Tables present data as a series of rows and columns
- Data held in tables has no inherent order
- Tables may be persistent or temporary
- Create table statement has an extensive range of options
- Simplest form defines table name and column specifications
- Create table statement also determines where indexes are created
- Can model new tables on existing tables using the like clause

Create Table Example

```
CREATE TABLE DRIVER
(DRIVER_ID      INTEGER    NOT NULL
,SURNAME       VARCHAR(50)
,FIRSTNAME     VARCHAR(50)
,DATE_OF_BIRTH DATE
,GENDER        CHAR(1)    NOT NULL WITH DEFAULT 'M'
              CHECK (GENDER IN ('M','F'))
,NATIONALITY   CHAR(15)
)
IN TS00004
INDEX IN TS00005
;
```

Table and Tablespaces

```
CREATE TABLE F1TEAM
(Team_ID      INTEGER NOT NULL
,Team_Name    VARCHAR(50)
,Team_Principal_ID SMALLINT
,HQ_City      CHAR(15)
,Country      CHAR(15)
)
```

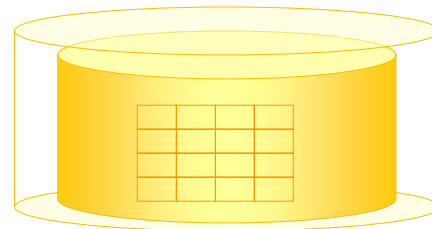

Tablespace

F1TEAM				
TEAM_ID	TEAM_NAME	TEAM_PRINCIPAL_ID	HQ_CITY	COUNTRY

System Catalog

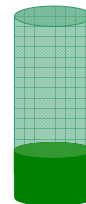

Single-Dimensional Clustering

- **Benefits**
 - Physically cluster data according to order of single clustering index
 - Improves performance of range queries and prefetching
- **Drawbacks**
 - All indexes record-based
 - Clustering in one dimension only
 - Clustering not guaranteed – degrades once free space is:

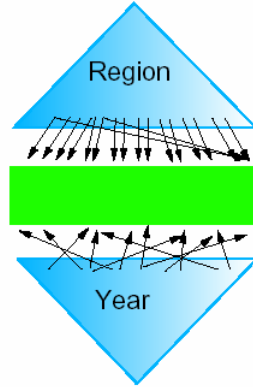

Multi-Dimensional Clustering

Internals

```
CREATE TABLE
SALES (Customer VARCHAR(80),
       Region CHAR(5),
       Year INT)
      ORGANIZE BY DIMENSIONS (Region, Year)
INSERT INTO SALES VALUES ('Sue', 'West', 00)
INSERT INTO SALES VALUES ('George', 'West', 01)
```

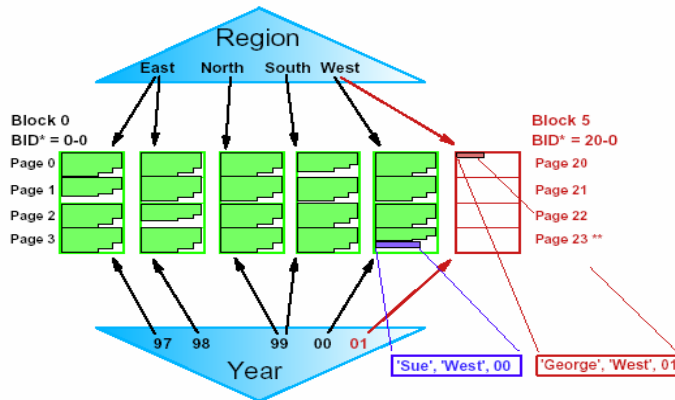

*Block IDs (BIDs) = RID of first slot on first page in block ** Block size (= Extent size) = 4 pages in this example

Other Data Structures

Region, Year

Composite Block Index

- Used to quickly locate candidate blocks for INSERTs
- Can also be used for query processing

Block Map

- Maps out used and free blocks assigned to table
- Used to quickly find blocks for LOAD, and for INSERTs of a new dimension value(s) or existing dimension value(s) where all existing blocks are full
- Shows up as .BMP file in SMS tablespaces

Indexes

- Indexes provide an efficient means of accessing rows in a table
- Constructed using columns from the related table
- Index keys are maintained in order
 - The index may be used to influence order within the data pages
- Indexes can be used to enforce uniqueness

```
CREATE UNIQUE INDEX DRIVERPKI
ON DRIVER
(DRIVER_ID ASC)
INCLUDE (SURNAME, FIRSTNAME)
CLUSTER
ALLOW REVERSE SCANS
```
- Physical characteristics inherited from the tablespace

Columns

- Atomic unit of data
- Datatype specified at this level
- Constraints can be applied to restrict values
- Nullability specified for columns
- Data values can be supplied, generated internally or specified defaults

Datatype	Minima	Maxima	Example
SMALLINT	-32,768	32,767	12
INTEGER	-2,147,483,648	2,147,483,647	39,892
BIGINT	-9.22337E+18	9.22337E+18	7,894,273,932
FLOAT	-1.79769E+308	1.79769E+308	2.17E+17
DECIMAL	(precision of 31)	(precision of 31)	49.99
CHARACTER	1	254	Robert
VARCHAR	1	32,672	Robert
DATE	0001-01-01	9999-12-31	1999-12-31
TIME	00:00:00	24:00:00	11:59:03
TIMESTAMP	0001-01-01-00.00.00.000000	9999-12-31-24.00.00.000000	-
CLOB	-	2GB	Chapter
BLOB	-	2GB	Video

Constraints

- Used to restrict the data values for a column
- Automatically applied at Insert and Update
- Can include range checks, list checks and other rules
- Constraint defined as a formula which must resolve to 'true'

Triggers

- Event driven processing to apply business logic
- Fired on Insert, Update or Delete
- Trigger code can see both the 'before' and 'after' data images
- May reference other tables
- Applied consistently regardless of source of request

Triggers

- Example:
 - We want to maintain the driver_standing table as results are posted for each race

RACE RESULT

- Season
- Race identifier
- Driver identifier
- Position
- Points

DRIVER STANDING

- Season
- Driver identifier
- Points total

Triggers

Sample Code

```
CREATE TRIGGER POINTSUMI
AFTER INSERT ON RACE_RESULT
REFERENCING NEW AS N
FOR EACH ROW MODE DB2SQL
UPDATE DRIVER_STANDING D
SET POINTS_TOTAL = POINTS_TOTAL + N.POINTS
WHERE D.SEASON = N.SEASON
AND D.DRIVER_ID = N.DRIVER_ID
;
```

We are interested in capturing the event when a race result is posted to the database

Update the other table

And make sure we only update the points for the right driver and season

Stored Procedures

- Business logic can be encapsulated in Stored Procedures (SP)
- SPs can be written in many languages
- Execute on the DB2 server, reducing network traffic
- Effective way of modularising code
- Registered in the System Catalog and manipulated using SQL commands

Stored Procedures

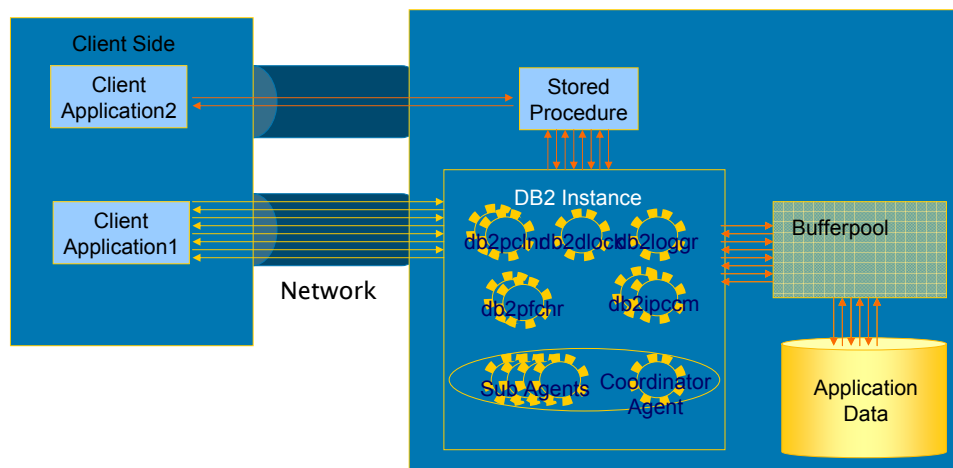

Stored Procedures

- SP Execution
- SPs can run in their own address space (fenced) or with the DB2 code (unfenced)
- Invoked using the CALL statement
- Parameters passed from calling program
- Results received in feedback area
- SQLCODE should be checked by calling program

UDF

- Provides the ability to add application logic to the database
 - Function can be applied inside or outside the database.
- Functions are called through SQL and are therefore reusable by all authorized users, regardless of the interface.
 - IBM ships a lot of additional UDF's through the Extender functionality
- The UDF can be either Scalar or Table.
 - Scalar functions return a value based on the input and the internal processing.
 - Table functions have the ability to return many rows and many columns in a single invocation.
- The UDF has the ability to use non-DB2 resources such as OLEDB, MQ series, or any kind of resource that is accessible from the application you decide to use for the function.
- The Development center provides assistance for building your own UDF.

UDF

- Sample:

```
create function multiply(i int, j int)
returns int
language sql contains sql
return( i * j );

values multiply(multiply(2,3),multiply(2,3));
```

```
create function airports() returns table (city varchar(20), code varchar(4))
fenced parameter style db2sql deterministic no external action
no sql scratchpad no final call language c cardinality 20 disallow parallel
external name '[curdir]\db2demo!airports' ;
```

```
select * from table(airports()) as data
```

UDF

- Sample:

```
CREATE FUNCTION OLEDBRegion ()
RETURNS TABLE ("REGIONID" INTEGER, REGIONDESCRIPTION" VARCHAR(50))
LANGUAGE OLEDB
EXTERNAL NAME '!dbo.Region!Provider=SQLOLEDB; Data Source=brain600; Initial
Catalog=Northwind; User ID=; Password=; Integrated Security=SSPI;'
```

UDF

The screenshot shows the DB2 Development Center interface. The top menu bar includes Project, File, Edit, Debug, Selected, View, Tools, and Help. The Project View pane on the left shows a tree structure with 'User-Defined Functions' expanded to show 'BRAIN1.OLEDBRegion' and 'BRAIN1.FUNCTION1'. The main window displays the configuration for 'sample - SAMPLE - User-Defined Functions - BRAIN1.OLEDBRegion' with the following table:

Name	Schema	Specific Name	Result	Input param...	Language	Fenced
OLEDBReg...	BRAIN1		INTEGER,VARC...		OLEDB	
FUNCTION1	BRAIN1		INTEGER		SQL	

The Output View pane shows a log of actions:

Status	Action	Object Name
Success	Run	OLEDBRegion
Success	Build	OLEDBRegion
Success	Open project	sample

Below the log, the results of the function are displayed in a table:

REGIONID	REGIONDESCRIPTION
1	Eastern
2	Western
3	Northern
4	Southern

At the bottom left, the text reads 'DB2. Information Management Software'. At the bottom center, it says 'Copyright © 2005 Brainware Bvba 59'. At the bottom right is the 'BRAIN WAVE' logo.

UDF

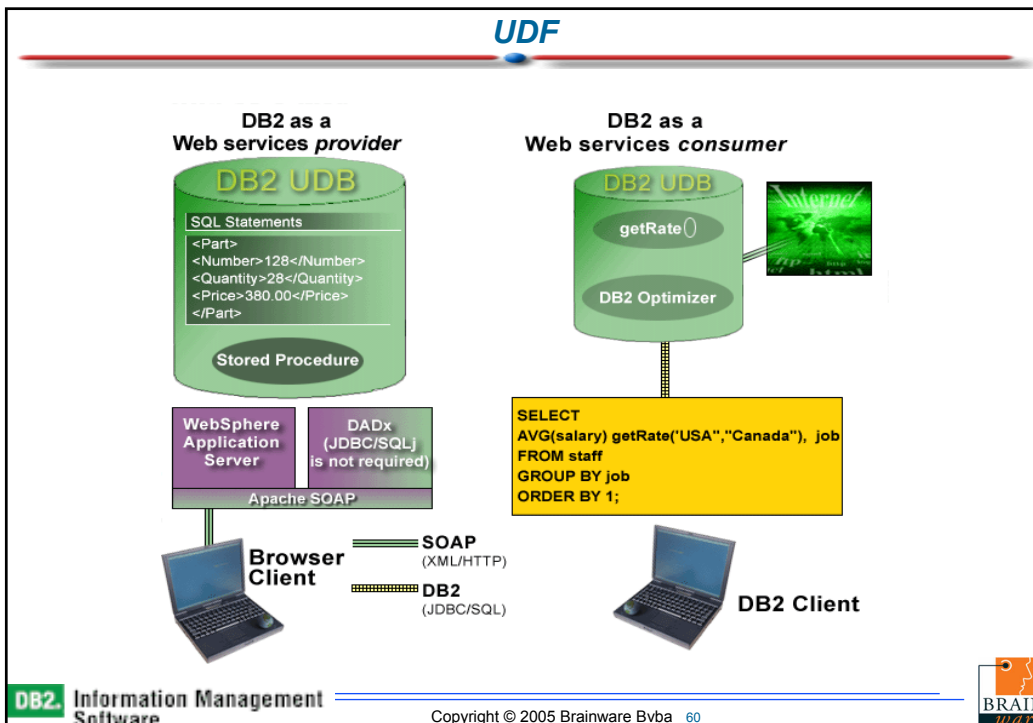

Application Design Alternatives

- Motivation of Managing File Data

- Most of Enterprise Data lives in Files
 - But typically unmanaged
- DBMS is a good manager of Data, but owns small amount of World's Data. Provides
 - Referential Integrity
 - Access Control
 - Backup and Recovery
- World's Unstructured and Semistructured Data lives in Files
 - ➔ Would continue to live there and grow
- Important to Manage File Data
 - ➔ Existing Apps
 - CAD/CAM
 - Content Management
 - Version Control
 - ➔ Emerging Apps
 - DB Extenders
 - WEB Document Management
 - DB Catalog - Need to manage UDFs/Stored Procedures

Application Design Alternatives

What is DataLinks

Datalinks provides management of file data using Database and Filesystems technologies

- Storage Model
 - ➔ Database has
 - Attributes information about files
 - Reference (logical pointer) to the file
 - ➔ File is stored in a File Server
- DataLinks provides
 - ➔ Referential integrity for the file reference
 - ➔ Rule-based access control
 - ➔ Coordinated backup and recovery
- Programming Model
 - ➔ Query metadata in database and get reference(s) to file(s)
 - ➔ "Play" (Open) desired file

Application Design Alternatives

DataLinks - Architecture

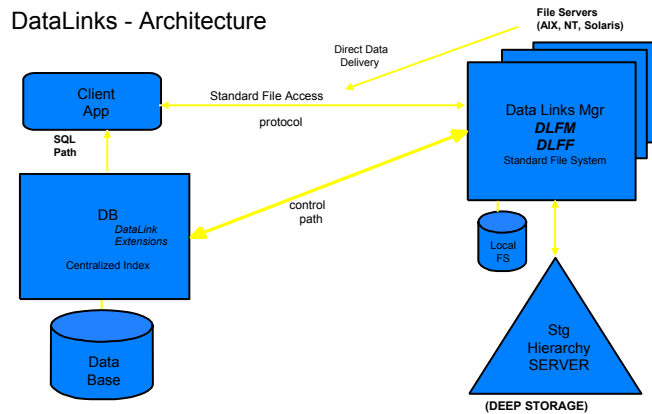

Centralized Database with Multiple Fileservers in a network topology
 Standard APIs for DB access and File access
 Archive Server (e.g., ADSM) used for coordinated backup and recovery
 NO modification of Filesystem which stores files

Application Design Alternatives

- DataLinks Replication
- Engineering Design Supply Chain (SC) common in Auto and Aerospace Industries
 - DataLinks Replication Provides Automated and Integrated solution for Content Sharing between BP's
 - Example: Chrysler outsources 70% of vehicle design
 - Has Significant Engineering Design SC
 - Needs replication of Engine Drawings (files) and metadata (database)
- DataLinks Replication Technology
 - Integrated with DPROPR
 - Replicate files, and then corresponding metadata

XML completes the puzzle

- XML brings data to the web, completing the necessary
- components for 90%+ of e-business applications.



Universal Communication - **Internet**
Universal User Interface - **Browsers**
Universal Programming - **Java**

and now...
Universal Information - **XML**

XML Extender Overview

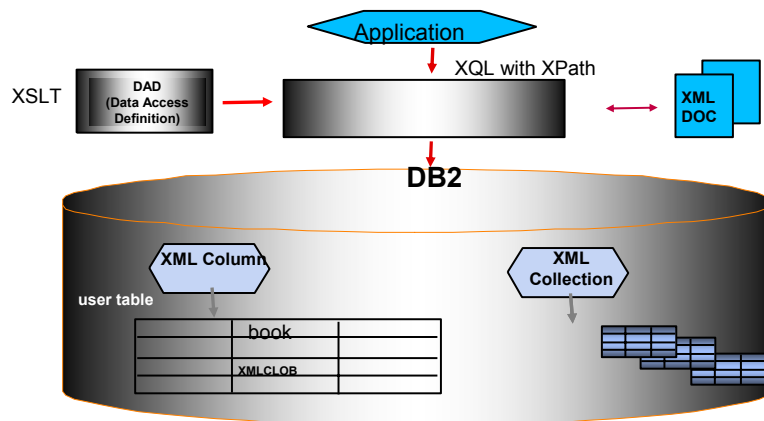

Agenda

- Overview and Positioning of IBM Information Management Software
- DB2 Database Objects
- Application Enablement Components
- Building the Application
 - Development Center
 - IDE Integration
 - .NET
 - Rational
 - Eclipse
- Deploying the Application
- Running the Application
- Troubleshooting Features
- Migrating to DB2
- Wrap-up



Building the Application

- Building the Application
 - Development Center
 - IDE Integration
 - .NET
 - Rational
 - Eclipse



Building the Application

- **Development Center**
 - Evolution of Stored Procedure Builder
 - Equal support for entire DB2 server family
 - Rapid, iterative development of Java / SQL stored procedures, user-defined functions, triggers, ...
 - Multiple concurrent projects development
 - Project view of development objects
 - Server view of live database objects

Building the Application

- **DC - LaunchPad**

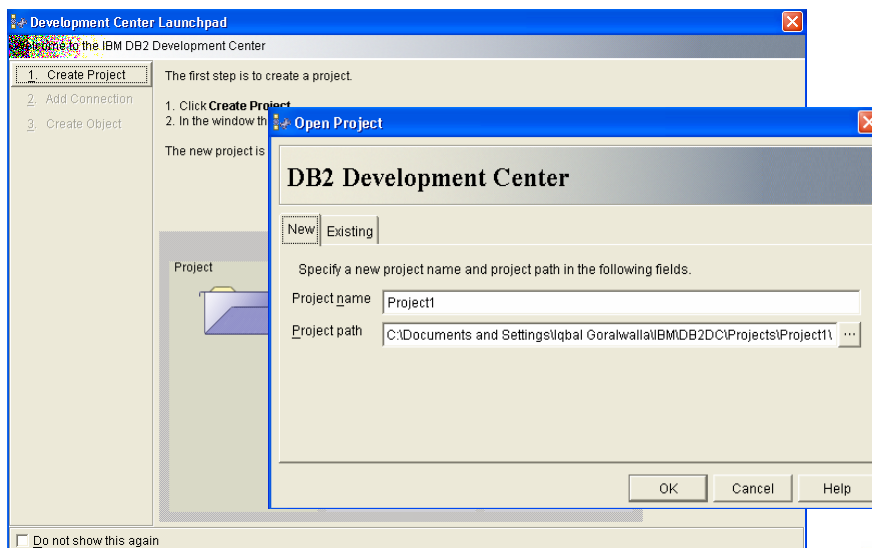

Building the Application

- DC – Database Connections

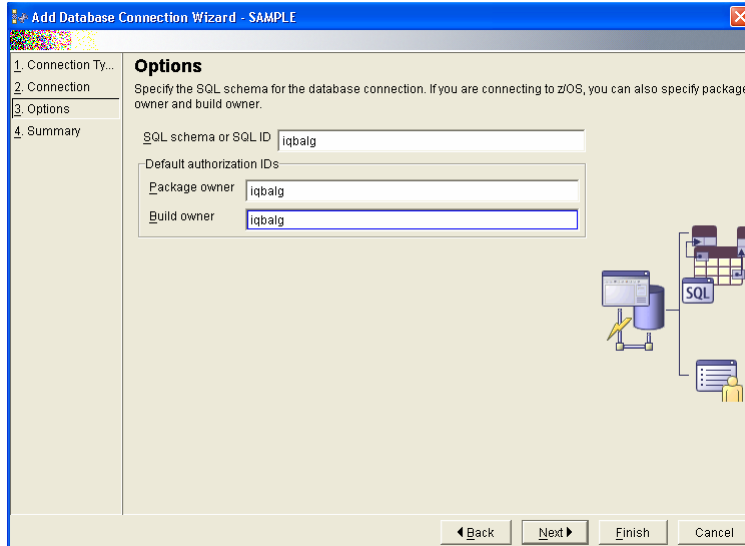

Building the Application

- Creating Objects

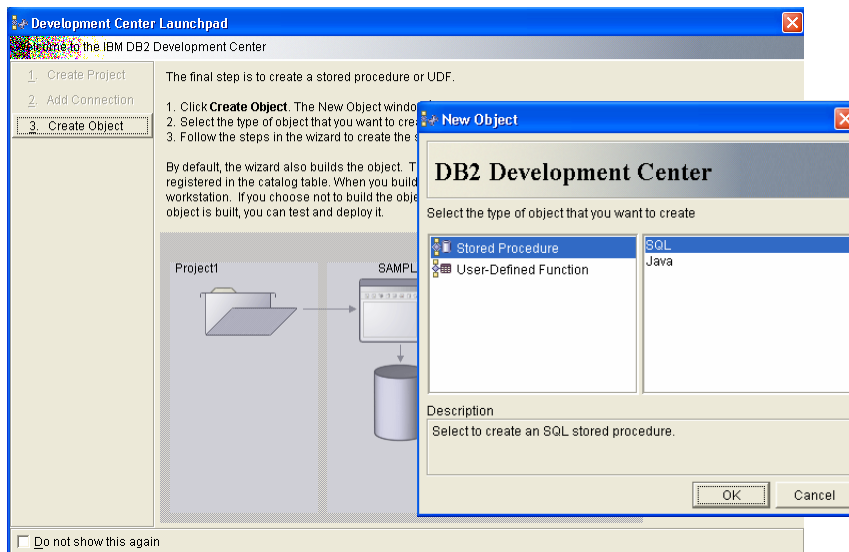

Building the Application

- DC – Stored Procedures

Create SQL Stored Procedure Wizard - IQBALG.PROCEDURE1

1. Name
2. Definition
3. Parameters
4. Options
5. Summary

Definition
Specify the settings to define the stored procedure. You can insert specific code fragments into the generated code.

Setting	Value
Statement	Simple SQL statement
Result set	One
Errors	SQL Exception
Header fragment	...
Variable declaration fragment	...
Exception handlers fragment	...
Pre-return fragment	...

```
SELECT PROCSCHEMA, PROCNAME FROM SYSCAT.PROCEDURES
```

Navigation: Back, Next, Finish, Cancel

Building the Application

- DC - UDFs

Create SQL User-defined Function Wizard - IQBALG.FUNCTION1

1. Name
2. Definition
3. Return Da...
4. Parameters
5. Options
6. Summary

Definition
Specify the settings to define the user-defined function. You can insert specific code fragments into the generated code.

Option	Value
Statement	SQL statement
Output type	Scalar
Header fragment	...
Variable declaration fragment	...
Exception handlers fragment	...
Pre-return fragment	...

```
SELECT count(*) FROM SYSCAT.FUNCTIONS
```

Navigation: Back, Next, Finish, Cancel

Building the Application

- DC – Project View

The screenshot displays the DB2 Development Center interface. The 'Project View' pane on the left shows a tree structure for 'Project1' containing 'Database Connections', 'SAMPLE', 'Stored Procedures', 'User-Defined Functions', and 'Structured Types'. The 'User-Defined Functions' folder is expanded, showing 'IQBALG.FUNCTION1'. The main pane displays a table with the following data:

Name	Schema	Specific Name	Result	Input paramet
FUNCTION1	IQBALG	SQL021119112...	INTEGER	

The 'Output View' pane at the bottom shows a table with the following data:

Status	Action	Object Name
✓ Succ...	Build	FUNCTION1
✗ Error	Build	PROCEDURE1
✓ Succ...	Add	Database Conn...

The output text below the table reads: 'SAMPLE.IQBALG.FUNCTION1() ... IQBALG.FUNCTION1 - Build started. DROP SPECIFIC FUNCTION IQBALG.SQL021119111349400 IQBALG.FUNCTION1 - Drop user-defined function completed. IQBALG.FUNCTION1 - Create user-defined function completed. IQBALG.FUNCTION1 - Build successful.'

DB2 Information Management Software Copyright © 2005 Brainware Bvba 75 BRAIN WAVE

Building the Application

- Development Center –Integrated Debugger
 - Fenced and unfenced stored procedure debugging
 - Nested stored procedures support
 - SQL State, SQL Code, and SQL Exception notification
 - View and modify variable values
 - Variable value change breakpoints
 - Source code line breakpoints
 - Break at Nth occurrence of a breakpoint event
 - Enabling and disabling breakpoints
 - Run, pause, step in, out, over, return, and run to line
 - Application Development and SQL

Building the Application

- SQL Assist

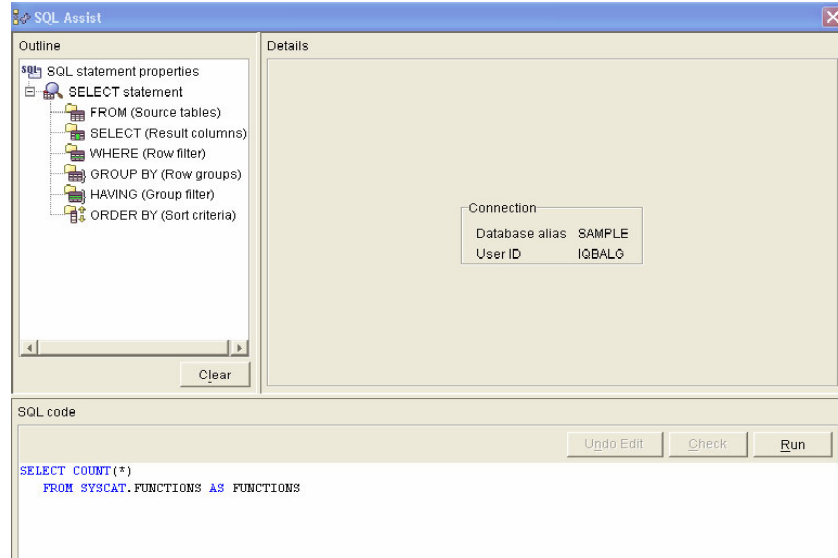

Building the Application

- Building the Application
 - Development Center
 - IDE Integration
 - .NET
 - Rational
 - Eclipse



Microsoft .NET Framework

- A native DB2 for .NET Data Provider that is developed and supported by IBM. No third party drivers or bridge solutions are needed.
- A collection of add-ins for the Visual Studio .NET IDE that simplify creation of the applications that use ADO.NET API.
 - These add-ins also extend the power of the Visual Studio .NET to developing DB2 server-side objects such as stored procedures and user-defined functions.
- Cross-platform support with access to a tremendous volume of data stored in thousands of DB2 databases. Applications that are developed on Windows can access DB2 servers on Windows, UNIX, and Linux. The .NET support is also shipped with DB2 Connect 8.1.2, providing support for DB2 UDB for z/OS and OS/390 V7.

Microsoft .NET Framework

- Microsoft Visual Studio .NET with IBM DB2 Development Add-In extensions

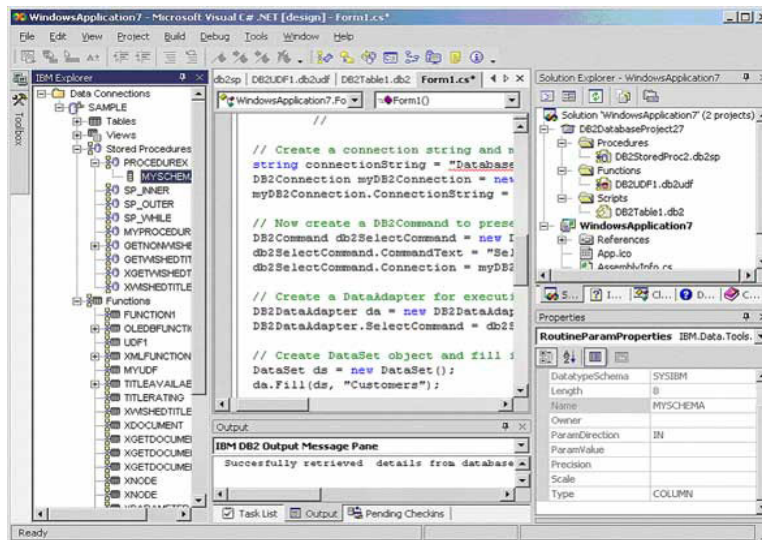

Visual Studio.NET Add-ins

Make Visual Studio .NET “understand” DB2

- IBM Explorer
- IBM Projects (DB2 Database Project)
- DB2 SQL Editor
- DB2 .Net Data Provider tools
- Output Views
- Integrated Help
 - DB2 .NET Data Provider
 - DB2 Add-Ins for VS.NET
- DB2 Tools menu Add-in

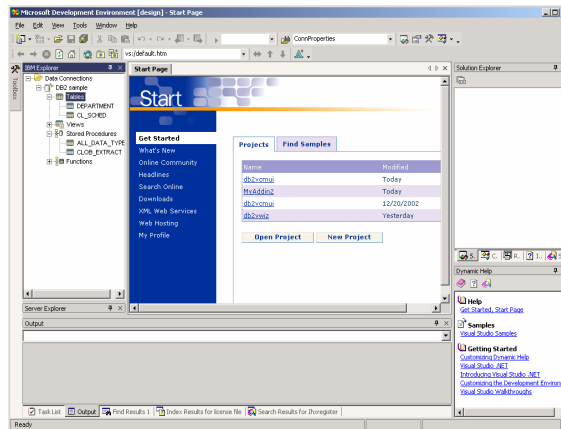

Microsoft .NET Framework

- Solution explorer
 - To enable database developers to build DB2 server-side objects, including routines, triggers, tables, and views, using script files.
- Server explorer –
 - To give application developers access to DB2 server-side objects from any tier of their application, including Win/Web forms in the presentation layer, and class assemblies / Web services in the business and data access layers.
- SQL editor –
 - To enable application developers to use the Visual Studio .NET editor to edit and view DB2 scripts.
- Dynamic help –
 - To provide application developers with fast access to various DB2 Development Add-Ins help topics.
- Output views –
 - To provide a medium for showing the results of compiling or testing the various DB2 script files and server objects.
- Managed provider –
 - To enable application developers to code to the DB2 server side objects using ADO.Net programming model.

Microsoft .NET Framework

- *Sample DB2 ADO.Net code*

```
// Create a connection string and make the connection to a database
string connectionString = "Database=Sample";
DB2Connection myDB2Connection = new DB2Connection();
myDB2Connection.ConnectionString = connectionString;
// Now create a DB2Command to present a SELECT statement
DB2Command db2SelectCommand = new DB2Command();
db2SelectCommand.CommandText = "Select * from Customers";
db2SelectCommand.Connection = myDB2Connection;
// Create a DataAdapter for executing the Select statement
DB2DataAdapter da = new DB2DataAdapter(); DB2DataAdapter.SelectCommand =
db2SelectCommand;
// Create DataSet object and fill it with data
DataSet ds = new DataSet(); da.Fill(ds, "Customers");
// Attach this dataset to a data-bound visual control (DataGrid). DataGrid
dataGrid1 = new DataGrid();
dataGrid1.DataSource = ds.DefaultViewManager;
```

DB2 UDB V8.2

- Offers functionality on Windows ahead of the next major version of Microsoft's own SQL Server database, codenamed Yukon.
- Use integration of DB2 add-ins for
 - Microsoft Visual Studio .net and Rational XDE (eXtended Development Environment) Developer visual .data modeling tools to design applications and databases in a more intuitive fashion.
 - IBM makes DB2 programming a natural extension of Visual Studio.
 - Build .net applications through use of the .net Data Provider, therefore strengthening the .net connection between databases and applications.
 - Using Visual Basic .net and C# skills by building client and DB2 server-side application logic using these programming languages. This is provided through DB2's ability to host the Microsoft Common Language Runtime (CLR).
 - Utilise DB2's native stored procedure capability by developing on the Windows platform and deploying across supported DB2 platforms.
- The enhancements result from a co-operative effort between Microsoft and IBM under the Visual Studio Industry Partner programme.

DB2 Value Proposition for Microsoft Application Programmers

- “in place” access to existing corporate data. No need to build new infrastructure and deal with data replication.
- Supports key Microsoft application development technologies
- Integrates with Microsoft programming tools
- Leaves options open for other platforms and technologies (Java, UNIX, Linux, mainframe etc.)
- All of the other key DB2 attributes that Operation and Architecture teams care about.

.NET Code Execution Model

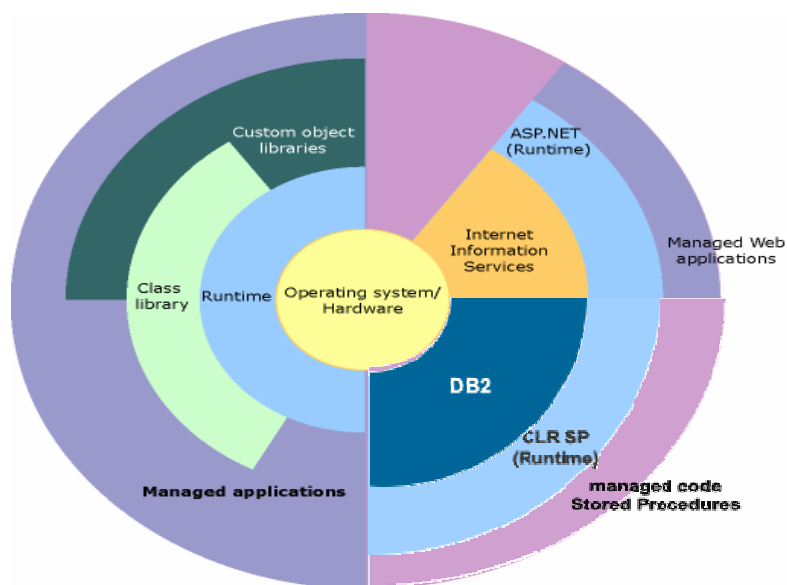

CLR Stored Procedures

- Build DB2 server side logic in any .NET programming language (eg. C#, VB.NET)
- DB2 server-side logic executes as managed code
- Server side logic can include SQL, OS, .NET and other calls
- Use DB2 add-ins for Visual Studio .NET to build, test, debug, and deploy

DB2 .NET Driver

DB2 and ADO.Net Access Methods

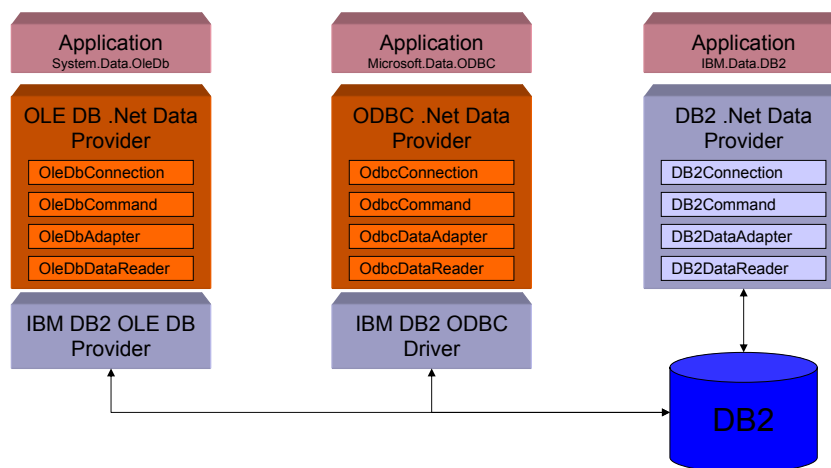

Data Providers for DB2

- **ODBC .NET Data Provider**
 - For .NET Framework v1.0
 - Namespace = Microsoft.Data.Odbc
 - download from MSDN
 - For .NET Framework v1.1
 - Namespace = System.Data.Odbc
 - Built in to the framework i.e. no need to download
- **OLE DB .NET Data Provider**
 - Namespace = System.Data.OleDb
- **IBM DB2 .NET Data Provider**
 - Namespace = IBM.Data.DB2
 - Part of DB2 Run-Time Client V8.1.2 or later

Disconnected Mode

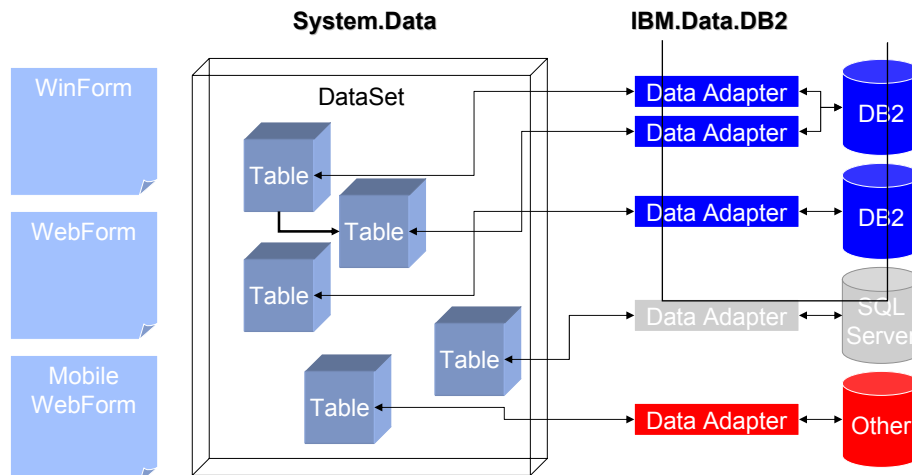

DB2 Everyplace for .NET

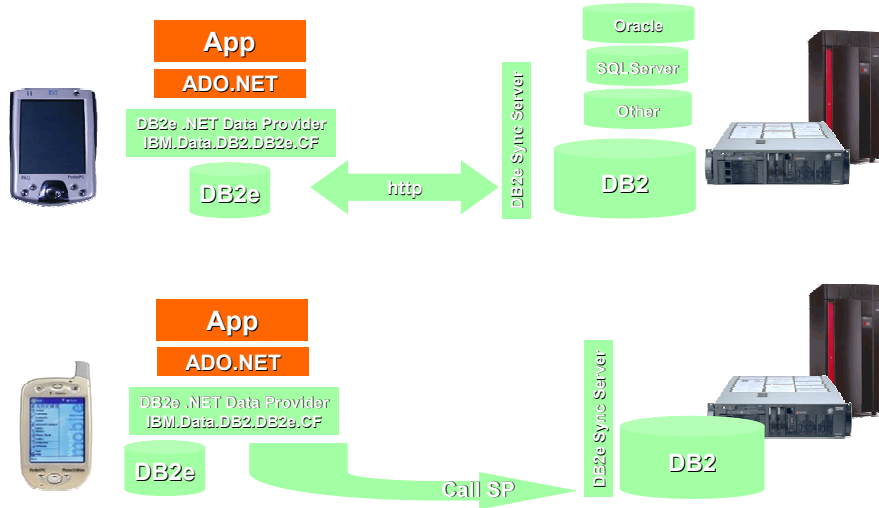

DB2 as a Consumer of Web Services

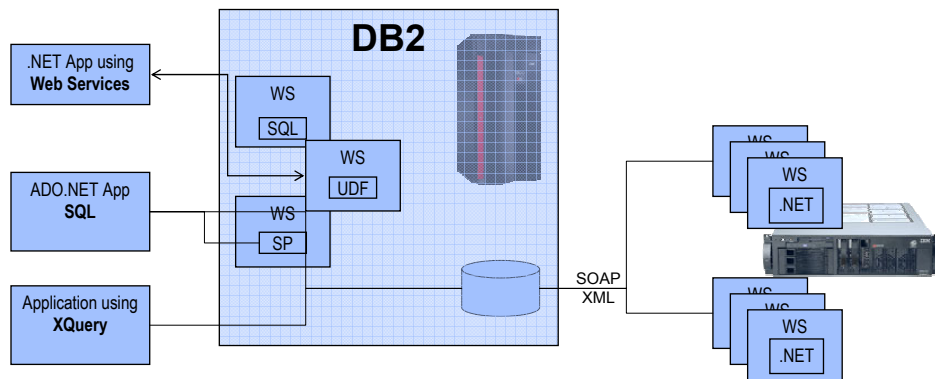

Agenda

- Overview and Positioning of IBM Information Management Software
- DB2 Database Objects
- Application Enablement Components
- Building the Application
- Deploying the Application
 - Moving objects and data
 - Securing the database
- Running the Application
- Troubleshooting Features
- Migrating to DB2
- Wrap-up



Deploying the Application

- Moving objects and data
- Securing the database

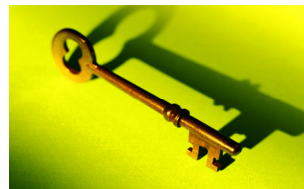

Deploying the Application

Moving Objects

- DDL
 - DB2LOOK will generate the DDL but the output is on LUW format.
 - Ideal for z/OS to LUW migration but the other direction requires you to rework the generated DDL.
 - Export IXF included the table definition and some indexes but this (again) only works when using LUW as a target (regardless of the source)
 - Beware of constraints when also loading the data.
- Stored Procedures
 - This can be easily achieved by using the Development Center.

Moving Data

- Most applications require some form of bulk data movement
 - Native SQL is unsuitable for this type of work
- Data may need to be moved between UDB databases
- Data may need to be moved to/from other non-UDB environments
- DB2 provides three utilities for mass data movement
 - EXPORT
 - IMPORT
 - LOAD
- LOAD executed at the table level
- IMPORT/EXPORT may use views, joins etc (in certain circumstances)

Export

- EXPORT uses SQL syntax to select data from the database
- Writes data to an external file
- SQL can be very versatile and may
 - reference views and aliases
 - include joins
 - filter rows using where clause
 - use columnar functions
 - use group by and order by clauses

Import

- The IMPORT utility uses the SQL processor to bulk load data
- Faster than application programs for large insert volumes
- Can be used to update existing records with matching keys
- Commit frequency can be tuned
- Large objects can be imported into a table from lob files created by the Export utility

```
IMPORT FROM tabddl.ixf OF IXF
CREATE INTO newtab
  IN mytbsp
  INDEX IN myindextbsp
  LONG IN mylongtbsp
```

Load

- Bypasses SQL processing to improve performance
- Pre-formats data pages and populates the table one extent at a time
- Does not fire triggers, invoke constraints or check referential integrity,
 - Unless online
- Utility can collect statistics and take a backup during LOAD processing
- Online Load
 - Existing table data available for read access during LOAD APPEND

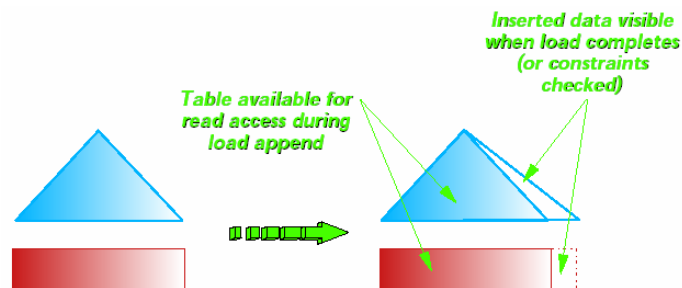

LOAD – more goodies

- X-Loader: LOAD from a SELECT
 - file type – CURSOR
 - Supports arbitrary SELECT statements –
 - single tables, joins, nicknames, etc.
 - CLP: Need to declare cursor, and cursor name provided as the input file name to LOAD
 - API: Supports a SELECT statement directly

```
➤ Create nickname sales for oracledb.salesdata.sales
...
➤ Create nickname employee for oracledb.salesdata.cashier
...
➤ Declare C cursor for select sales.* from sales, employee where
sales.cashierid = employee.id and employee.name = 'John Smith'
...
➤ Load from C of cursor insert into johns_sales
```

Deploying the Application

- SQL Based Replication

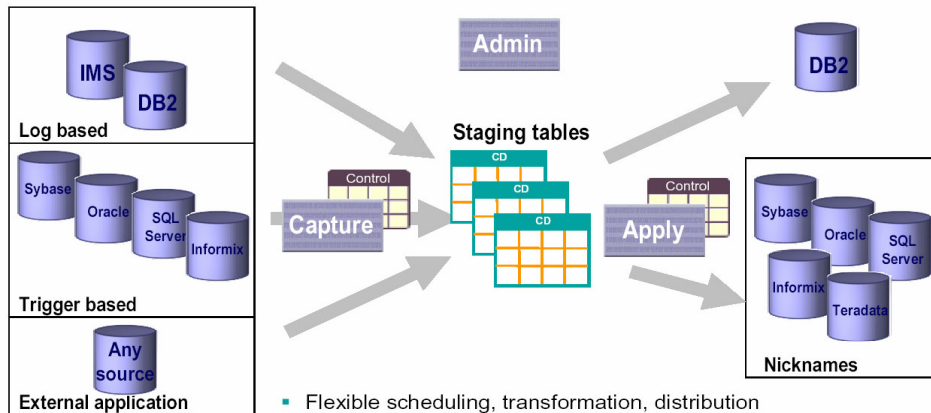

- Flexible scheduling, transformation, distribution
- Typically used for business intelligence, distribution and consolidation, application integration

Deploying the Application

- SQL Based Replication

- Restrictions:

- Performance:** Combine high throughput with low latency
- Capability:** Significantly improve multi-directional replication support
- New function:** Event publishing, table difference utility
- Manageability:** Reduce the number of replication objects to be defined and managed, ease the definition process with new Replication Center wizards

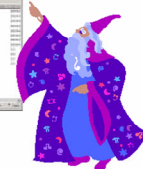
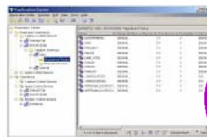
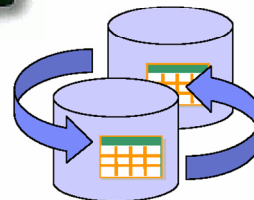

Deploying the Application

- Q Based Replication

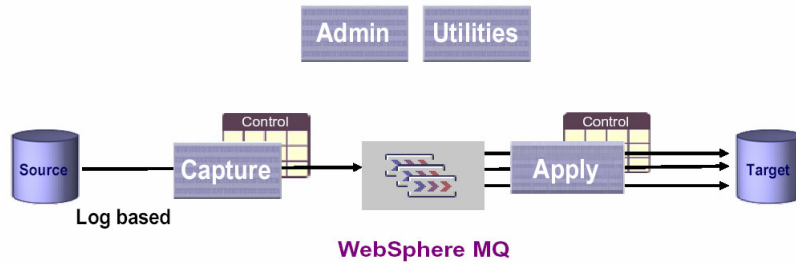

- Each message represents a transaction
- Highly parallel apply process
- Differentiated conflict detection and resolution
- Integrated infrastructure for replication and publishing
- Staged availability of heterogeneous support

Deploying the Application

- Q Based Replication: Processing

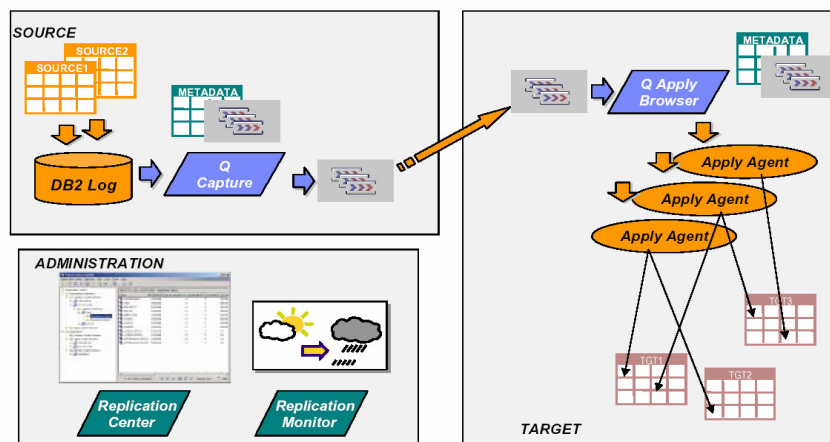

Deploying the Application

- Moving objects and data
- Securing the database

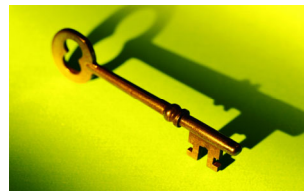

Security

- Essential part of any DBMS
- The 3 W's
 - Who will access the DBMS?
 - Users of the DBMS need to know
 - What will be accessed?
 - Instances? Databases? Tables?
 - What type of access is required?
 - Create? Select? Update? Delete?

Security

- First aspect is authentication
 - Determine that the user is valid and allowed to connect to the database
- Second stage is to determine authorisation and privileges
 - To which objects is this user allowed access and
 - The type of access to these objects
- Privileges can be granted to individual users, groups and 'public'
- Supports high level of security through
 - **Security Plug-in Architecture**
 - **Data Encryption on the Wire**

Authentication

- Database Manager works in cooperation with the operating system
- Validates user id and password
- Allows user to establish a database connection
- Can be done at the Client or Server
- Can be managed by external products
 - **OS and Kerberos plug-ins provided**
 - **DBAs may create their own userid/password or GSS-API based (including Kerberos) plug-in**

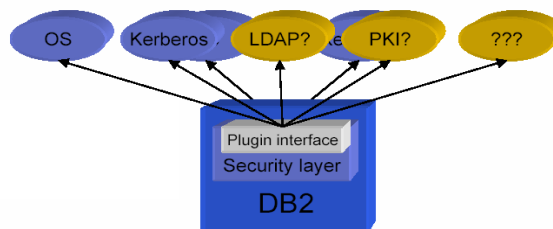

Security

Common Criteria Certification



- **DB2 v8.2 servers are Common Criteria Certified at Evaluation Assurance Level 4 (EAL4) according to the table:**

	Win 2000	SLES 8	AIX 5.2	Solaris 8
ESE (single partition)	Yes (32 bit)	Yes (32 bit)	Yes (64 bit)	Yes (64 bit)
WSE	Yes (32 bit)	Yes (32 bit)	Yes (64 bit)	Yes (64 bit)
Personal	Yes (32 bit)	Yes (32 bit)	N/A	N/A
Express	Yes (32 bit)	Yes (32 bit)	N/A	N/A

– http://niap.nist.gov/cc-scheme/vpl/vpl_type.html#dbms

Authorities

- Required for maintaining databases and instances
- Allow users to perform database level operations, for example, backup, create, connect
- 5 authorities in DB2
 - SYSADM – System Administration Authority
 - SYSCTRL – System Control Authority
 - SYSMANT – System Maintenance Authority
 - LOAD – Load Table Authority
 - DBADM – Database Administration Authority

Authorities - Hierarchy

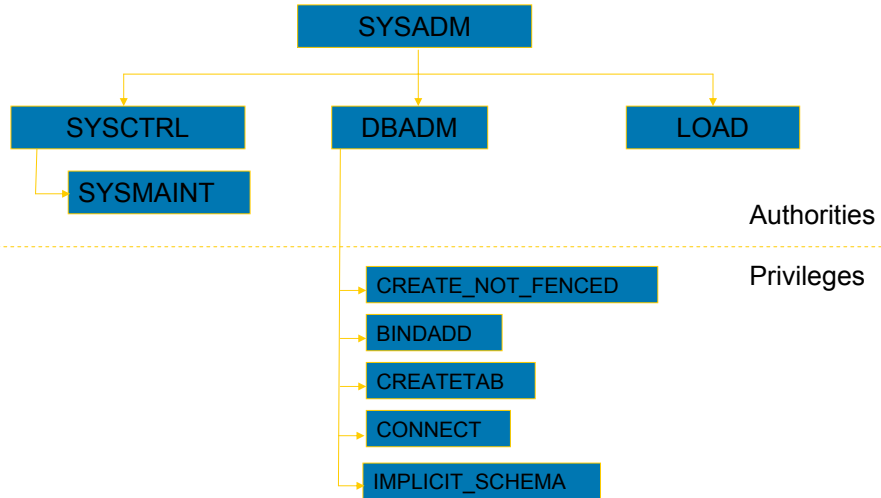

Privileges

- Determine what a user can do within the database
- Maintained using DCL statements
- Privileges held in the system catalog
- Can be granted at either user or group level
- Checked every time a user attempts an action

Types of Privileges

- Control – allows full access to object
 - Automatically granted to creator of object (views are an exception)
- Individual – allows specific operation on a specific object
 - SELECT, DELETE, INSERT, UPDATE
- Implicit – granted when user has already been granted explicit higher level privileges
 - Not revoked when higher level privileges are revoked

Privileges - Hierarchy

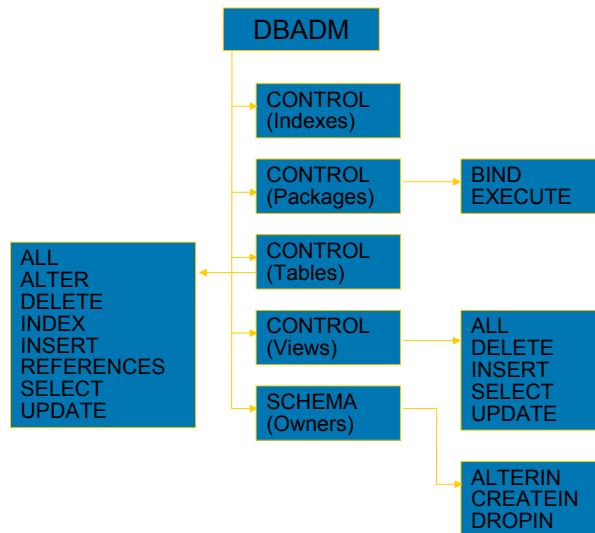

Users and Groups

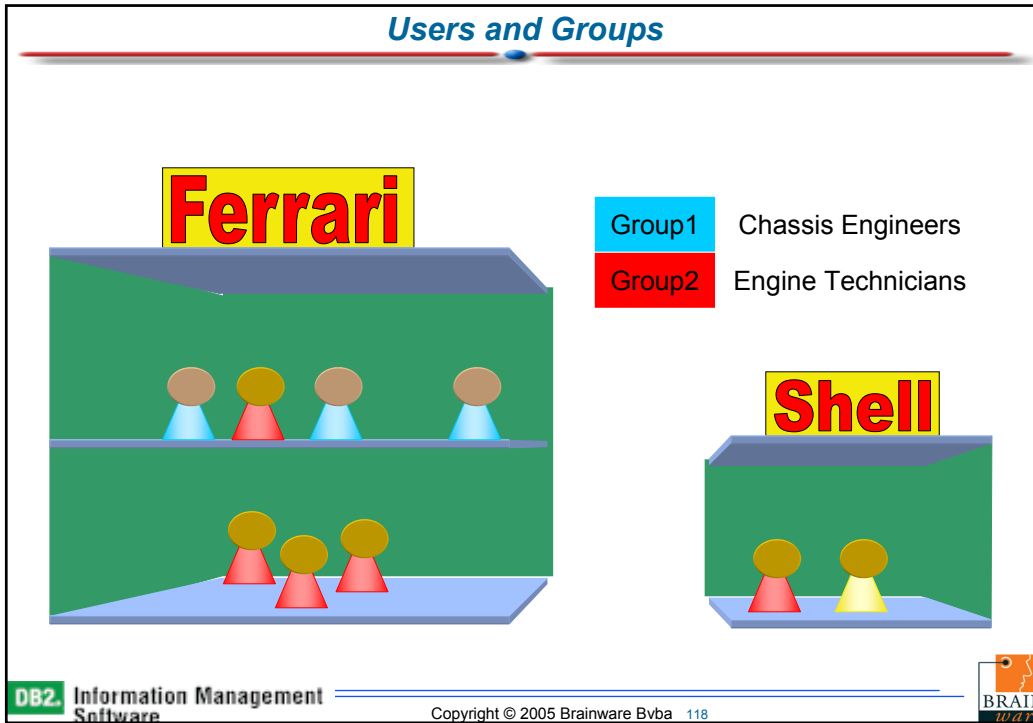

Using SQL (DCL)

```
grant select, insert on table f1team to public;
:
grant update on driver to victor with grant option;
:
grant all privileges on contract to user bob, user sue;
:
:
revoke insert on f1team from public;
:
```

Auditing

- DB2 audit facility (db2audit) allows a DBA to monitor system (ab)use
- db2audit is associated with an instance and databases within it
- Can be active even when instance is inactive
- Can only be used by SYSADMs
- Audit records are written to a binary configuration file in the security directory within the instance directory

Agenda

- Overview and Positioning of IBM Information Management Software
- DB2 Database Objects
- Application Enablement Components
- Building the Application
- Deploying the Application
- Running the Application
 - Storage Management
 - Backup and Recovery
 - Performance Tuning and Management
- Troubleshooting Features
- Migrating to DB2
- Wrap-up



Running the Application

- Storage Management
- Backup and Recovery
- Performance Tuning and Management

Running the Application

- **Storage Manager**
 - Tool available through the Control Center
 - Storage Management view displays storage snapshot of database, database partition group, or tablespace
 - Statistical information can be captured periodically and used to monitor and set thresholds for
 - Space usage for tablespaces
 - Database distribution for database partition groups
 - Cluster ratio of indexes for tablespaces and database partition groups

Storage Manager

- Storage Manager View

The screenshot shows the Storage Manager application with three overlapping dialog boxes:

- Specify Threshold Settings**: A dialog box with a close button and a text area containing the instruction: "e percentage clustering in indexes. If you do not specify".
- Specify Snapshot Schedule**: A dialog box with the following options:
 - Run now without saving task history
 - Create this as a task in the Task Center
 Fields include: Run System (IQBAL-4150), Scheduler System (IQBAL-4150), Task name (snapshot - 10/25/02 10:54:06 AM), and Runtime authorization (User ID and Password).
- Show Command**: A dialog box displaying the following SQL commands:

```
connect to SAMPLE;
call CAPTURE_STORAGEMGMT_INFO(0, '', 'SAMPLE');
connect reset;
```

At the bottom of the slide, there is a footer with "DB2 Information Management Software" on the left, "Copyright © 2005 Brainware Bvba 124" in the center, and the "BRAINWARE" logo on the right.

Running the Application

- Storage Manager View

The screenshot shows the Storage Management application interface. On the left is a tree view of the database structure:

- SAMPLE
 - Table Spaces
 - SYSCATSPACE
 - Tables
 - Indexes
 - USERSPACE1
 - Tables
 - Indexes
 - DB2DEMO
 - Tables
 - Indexes

On the right is a table listing the contents of the selected table space:

Name	Schema	Column Count	Number of Rows	Estimated
SALES	IQBALG	4	41	
CL_SCHED	IQBALG	4	0	
IN_TRAY	IQBALG	4	0	
EMPDATA	IQBALG	3	0	
EXPLAIN_...	IQBALG	24	0	
EXPLAIN_S...	IQBALG	17	0	
EXPLAIN_A...	IQBALG	12	0	
EXPLAIN_O...	IQBALG	45	0	
EXPLAIN_O...	IQBALG	22	0	
EXPLAIN_P...	IQBALG	16	0	
ORG	IQBALG	5	8	
EXPLAIN_S...	IQBALG	22	0	
ADVISE_IN...	IQBALG	44	0	
ADVISE_W...	IQBALG	10	5	
ADVISE_AST	IQBALG	23	0	
TEMPMDC	IQBALG	3	10000	

At the bottom of the slide, there is a footer with "DB2 Information Management Software" on the left, "Copyright © 2005 Brainware Bvba 125" in the center, and the "BRAINWARE" logo on the right.

Backup and Recovery

- Policy Based Recovery
 - *“Take backups frequently enough, and of the right type, to ensure that I can recover from a media failure within X minutes, given these storage resources”*
- Based on
 - Amount of outstanding updates / log data
 - Costed and/or historical rollforward speed
 - Available storage resources
- Policy specifies
 - Backup location
 - Criteria for determining when a backup is required
 - Maximum time between backups
 - Maximum log space used between backups



Backup and Recovery

- Automatic database backups
 - Automatic backup can run
 - **Online or offline**, if the database is enabled for log retain
 - **Offline**, if the database uses circular logging

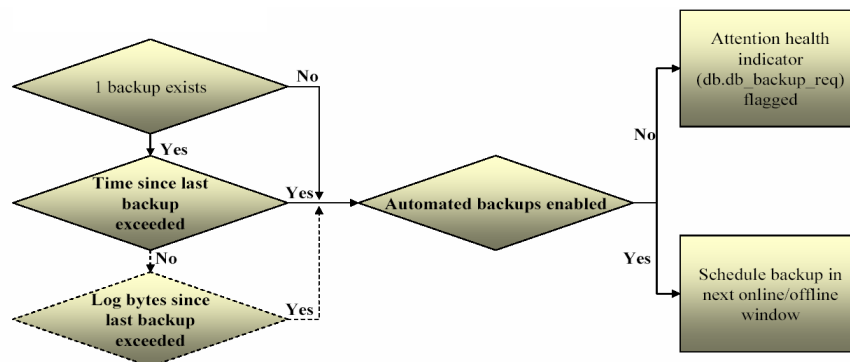

Performance Tuning and Management

- **Configuration Advisor**
- **Tune your database in 2 seconds.**
- Automatic hardware characteristic detection
- User description of basic operational questions
- Combined with mathematical model of each configuration parameter, based on expert heuristics.

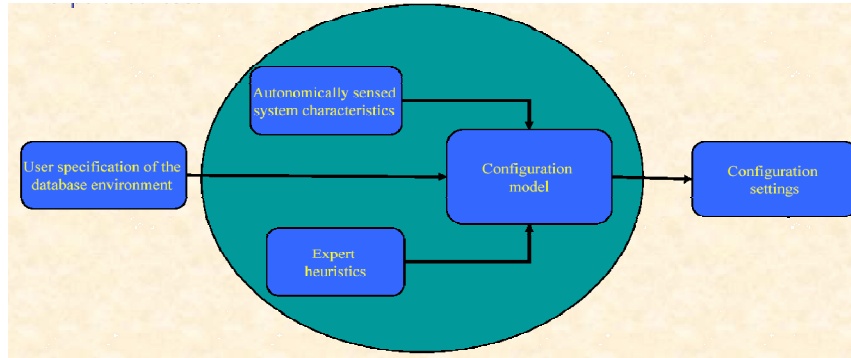

Performance Tuning and Management

- Self-configuring Autonomic Capabilities
 - **Configuration Advisor**
 - **Design Advisor**



"If it's so efficient, why doesn't it fix itself?"

Performance Tuning and Management

- The DB2 Design Advisor
 - **Goals**
 - Select a database design that provides the best workload average response time.
 - Ease of use.
 - **DB2 UDB v8.2**
 - Key feature of DB2's Autono initiative.
 - No additional charge, part of Push button solution.
 - **Given**
 - A workload (user provided o
 - System detected database c
 - System detected system chr
 - Disk constraints (optional)
 - **Design Advisor includes**
 - Index selection
 - Materialized Query Tables s
 - Multidimensional Clustering selection (MDC)
 - Partitioning selection (Partitioning Advisor)
 - Industry leading workload compression
 - Industry leading sampling (statistics, column correlations)



Performance Tuning and Management

- Automatic Table Statistics
 - Removing the manual task of issuing a RUNSTATS command
 - Better access plans, more often.
 - Silent execution
 - online, throttled, and non-contentious
 - Determines
 - What statistics are needed?
 - Column groups
 - enables correlation detection
 - True learning with feedback!

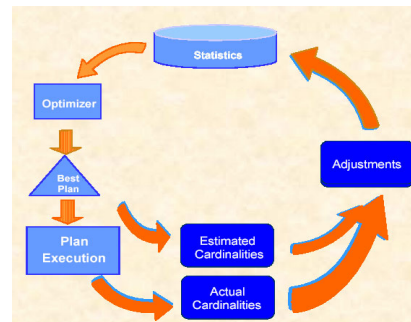

Agenda

- Overview and Positioning of IBM Information Management Software
- DB2 Database Objects
- Application Enablement Components
- Building the Application
- Deploying the Application
- Running the Application
- Troubleshooting Features
 - Self Management
 - Application Debugging
- Migrating to DB2
- Wrap-up



Self Management

Health Monitor Architecture

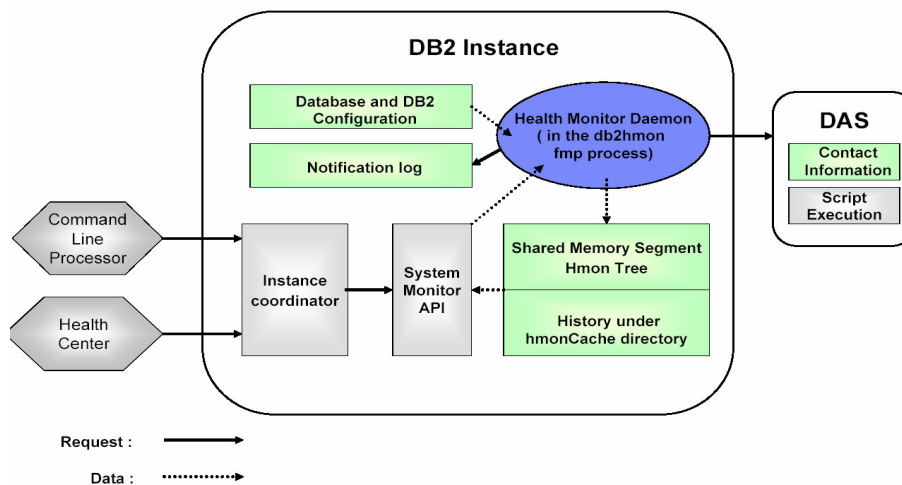

Self Management

Health Center

- Graphical interface that shows the overall state of the database environment and all current alerts.
- Summary of instance states on launch
- Provides a central location to view the roll-up alert status of all instances and their databases catalogued on the client
- Management-by-exception tool; only health indicators in alert state are viewable

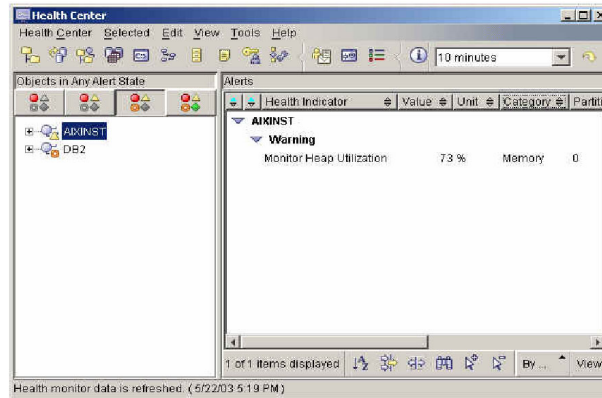

Self Management

Health Center

- Recommendation advisor
- Provides questions, when applicable, to help narrow down recommendation options

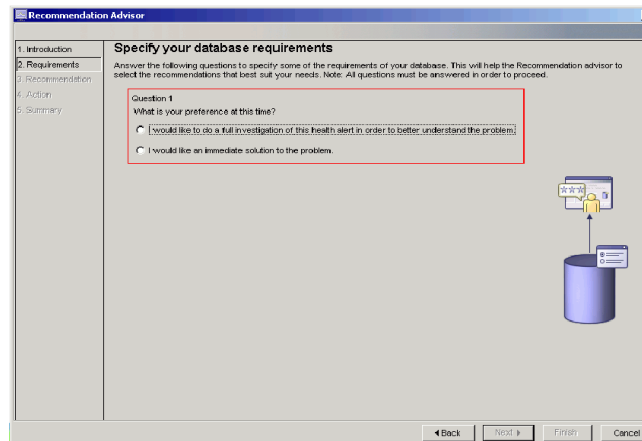

Application Debugging

Activity Monitor

- Real-time application monitoring based on application performance issues
- Uses snapshot monitor to provide sorted reports on applications (eg. Highest CPU usage, Longest time spent on locks)

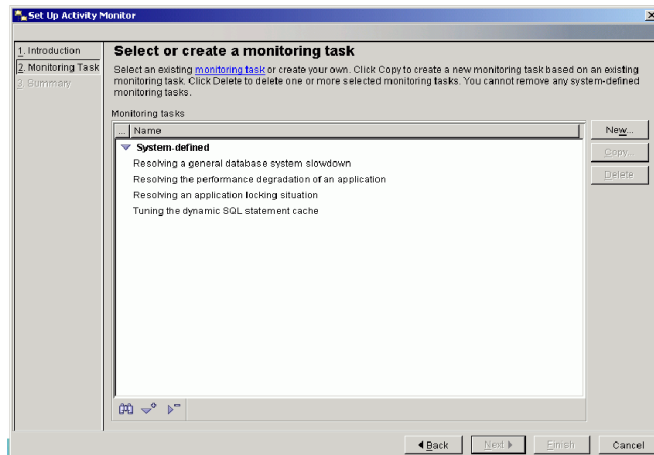

Application Debugging

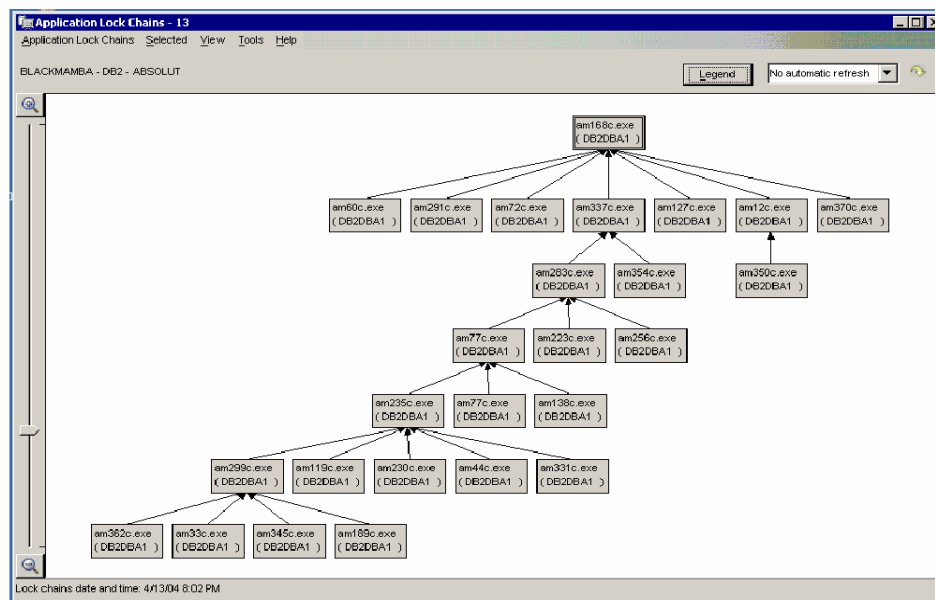

Application Debugging

- **DB2/WebSphere Integrated Log and Trace Analyzer**
 - Eclipse-based –extension of the HyadesEclipse project
 - Single point of operation to analyze and correlate log and tracefiles produced by various components of a deployed system
 - Correlate information from
 - Apache HTTP Server
 - IBM HTTP Server
 - IBM WebSphere® Application Server
 - IBM DB2 Universal Database (JDBC and DB2DIAG.LOG)
<http://www.alphaworks.ibm.com/tech/logandtrace>
- **Business Workload Manager**
 - Open group standard (ARM – Application Response Management) to monitor the performance of transactions across a distributed environment
<http://www.alphaworks.ibm.com/tech/bwlm>

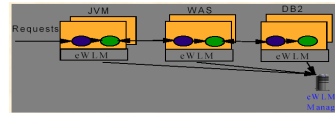

Agenda

- Overview and Positioning of IBM Information Management Software
- DB2 Database Objects
- Application Enablement Components
- Building the Application
- Deploying the Application
- Running the Application
- Troubleshooting Features
- Migrating to DB2
- Wrap-up



Porting to DB2



- <http://www.ibm.com/developerworks/db2/zones/porting>
- **Tools and Documentation**
 - Project Planning tools
 - Porting and migration tools
 - Modeling tools
 - **Porting guides**
 - Education and training
 - Certification
 - Consulting services
 - Documentation



- **Porting Guides and Information**
 - There are a number of DB2 UDB Porting Guides and other documents available to assist you in moving your database and application from its existing DBMS to DB2 UDB.
- **Porting from Oracle to DB2 UDB**
 - Redbook: Oracle to DB2 UDB Version 8.1 Conversion Guide.
 - White Paper
 - IBM DB2 Universal Database Porting Guide: Oracle to DB2 Version 7.2.
 - Converting Oracle Pro*C Programs to DB2 Universal Database
 - Migrating Recursive SQL from Oracle to DB2 UDB
- **Porting from Microsoft to DB2 UDB**
 - Porting Guide
 - Porting to DB2 Universal Database V8 from Microsoft SQL Server 2000 This in-depth article introduces DB2 UDB products and their capabilities, discusses porting databases and applications, and describes the most important aspects of porting applications from Microsoft SQL Server 2000 to DB2 UDB V8. It describes the differences between the two products in database options, data definition language (DDL), data modeling, SQL considerations, data conversion, and application conversion.
 - White Paper
 - Leverage your Microsoft SQL Server 2000 Skills to Learn DB2 UDB Version 8
 - Migrating From Microsoft SQL Server to IBM DB2 UDB Using Borland C#Builder
 - Moving from the BDE and dbExpress to ADO.NET and the Borland Data Provider
- **Porting from Sybase to DB2 UDB**
 - Porting to DB2 Version 8.1 from Sybase Adaptive Server Enterprise This article introduces DB2 UDB products and their capabilities, discusses porting databases and applications, and describes the most important aspects of porting applications from Sybase Adaptive Server Enterprise to DB2 UDB V8. It describes the differences between the two products in database options, data definition language (DDL), data modeling, SQL considerations, data conversion, and application conversion.

Porting to DB2

- DB2 Migration Toolkit for MS SQL Server, Oracle and Sybase
 - Download the toolkit from the IBM website (<http://www.ibm.com/software/data>)
 - This release of MTK is designed to migrate data and the query and procedure language from the following source database management systems to the following target systems.
 - Source:
 - Oracle 8i and partial support for Oracle 9i
 - Microsoft SQL Server, versions 6, 7, and 2000
 - Sybase Enterprise, versions 11 and 12
 - Target:
 - IBM DB2 Universal Database for Workstation platforms Version 7.2 FP 6 or later, with the application development kit installed.
 - IBM DB2 Universal Database for iSeries, Version 5.2 or later.
 - IBM DB2 Universal Database for z/OS, Version 8.



Porting to DB2

- DB2 Migration Toolkit for MS SQL Server, Oracle and Sybase

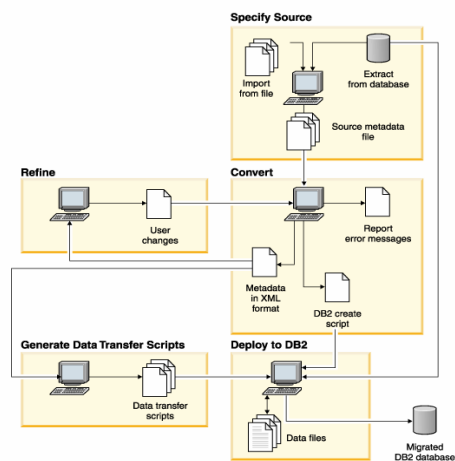

Agenda

- Overview and Positioning of IBM Information Management Software
- DB2 Database Objects
- Application Enablement Components
- Building the Application
- Deploying the Application
- Running the Application
- Troubleshooting Features
- Migrating to DB2
- Wrap-up



Wrap UP



- For a limited time, explore our compelling trade-up program.
 - There's never been a better time to consider IBM DB2 UDB or IBM Informix. Through the end of the year, you can seize an unprecedented opportunity with our trade-up program.





Wrap UP

- Why explore moving to DB2?
 - Lower TCO.
 - An ITG study showed overall costs for Oracle are over four times higher than DB2. Learn more.
 - Better manageability.
 - Solitaire found that on average, DB2 requires 25% less staffing than Oracle. So you can manage and control your crucial data with less time and effort. And spend more time thinking creatively about your company's future needs. Learn more.
 - Better performance.
 - The benchmarks prove it. TPC.org rates DB2 as the overall price/performance leader for TPC-C on Linux, UNIX and Windows, ahead of both Oracle and Microsoft SQL Server1. Learn more.
 - Better scalability.
 - It's proven again. DB2 scales faster and better on all platforms. Indeed, it processes more transactions per second per processor than any other database platform. Learn more.
 - Better availability.
 - A Solitaire study found that Oracle experienced 2.7 times more outages than DB2. Less downtime means your business stays up and running reliably-which is bound to earn the respect of your colleagues, partners, and customers. Learn more.
 - Ready for the grid.
 - Only DB2 is the best database tool for building open grid solutions, allowing you to leverage existing computing resources, no matter what type or location-and take full advantage of today's heterogeneous and open environment.

Thank You

11011100



 **WWW.BRAINWARE.BE**
 **Jan_Henderyckx@brainware.be**

Brainware Bvba
Sparrenlaan 13
2280 Grobbendonk
Belgium

Tel: +32 14 51 92 47
Fax: +32 14 51 92 48