

IBM

IBM Software Group

On Demand access to CICS and IMS Assets
or How to integrate existing 'legacy' applications into
an On Demand infrastructure





@business on demand software

IBM Software Group **IBM**

Agenda

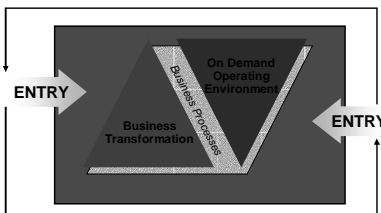
- On Demand Operating Environment Introduction ←
- CICS Assets and Implementations
- IMS Assets and Implementations
- Summary







Page 1

IBM Software Group **IBM**

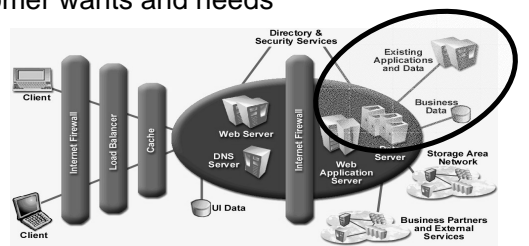
Customer wants and needs



- **Increased return on existing investments**
 - ▶ improved reuse of legacy assets
 - ▶ simplified access & better integration with Websphere Application Server
- **Lower total cost of ownership**
 - ▶ improved AD productivity
 - ▶ easier systems management
- **Solutions which are scalable, available, reliable and secure**



Page 2

IBM Software Group **IBM**

Phases of On Demand Adoption

- Provide static information to a browser
- Provide dynamic information to a browser
 - ▶ with calls to backend systems (eg. CICS or IMS TM)
- New Internet Applications
- Business to business "transactional" processing
- Publishing of Web Services



Access
"Get on the Net"

Enterprise Integration
"Buying, not browsing ...
Working, not surfing"

On Demand
"Optimise operations ...
dynamically respond to
the needs of customers,
employees, partners."

Access
Publish
Transact
Integrate Internally
Integrate Externally
Adopt Dynamically



Page 5

IBM Software Group

Three Styles of Transformation

- Improve**
 - re-face applications to enhance the user experience
- Adapt**
 - re-use applications as part of a larger solution
- Innovate**
 - re-engineer applications to reflect business processes

"To move towards an on-demand business, customers need to transform their technical infrastructure from unique, single purpose applications to shared resources"

The basic business processes have not changed. So all three styles of transformation should exploit existing applications.

Page 6

IBM Software Group

Your Reality: Functional Automation

Historical limitations:

- Monolithic applications can't be reused
- Ad hoc integration creates connections that are difficult to change/maintain
- Lack of standards limits ability to deliver meaningful interoperability

Page 7

IBM Software Group

The Growing Reality: Horizontal Process Integration

Advances that make it possible:

- Standards for creating services and enabling them to communicate are agreed upon by major vendors
- Infrastructure that supports self-defined, loosely coupled services has emerged
- Tools to incorporate existing assets are available
- Automation and virtualization of systems resources readily available

Page 8

IBM Software Group

On Demand Operating Environment and Legacy

On Demand Operating Environment

Integration

Business flexibility through integration of people, processes and information within and beyond the enterprise

Adapters/connectors for legacy

QoS considerations (performance, transactions, security ...)

Services Oriented Architecture

Infrastructure Management

IT simplification through automation and virtualization of resources ...

Automation (availability, security, optimization, provisioning ...)

Consolidated view of legacy and new

Also requires organizational change

Page 9

IBM Software Group

What makes this possible? A service-oriented architecture (SOA)

What is SOA?
SOA enables flexible connectivity of applications or resources by:

- Representing every application or resource as a service with a standard interface
- Enabling them to exchange structured information

Why do you care?
Provides the flexibility to treat business processes and the underlying infrastructure as defined components that can be mixed and matched at will

Page 10

IBM Software Group

What is a Service Oriented Architecture?

■ **An approach for building distributed systems that deliver application functionality as services to either end-user applications or other services**

- ▶ An architecture that leverages open standards to represent software assets as services.
- ▶ Provides a standard way of representing and interacting with software assets
- ▶ Individual software assets become building blocks that can be reused in developing other applications
- ▶ Shifts focus to application assembly rather than implementation details
- ▶ Used externally to integrate with applications outside of the Enterprise

"A system architecture in which application functions are built as components (or services) that are loosely-coupled and well-defined to support interoperability and to improve flexibility and re-use".

Page 11

IBM Software Group

Software Development is Key

Software Development
Integrating & automating horizontal business processes:

- Unique to each business
- Competitive advantage

Partners Partners Partners

Horizontal Process

Business Flexibility

IT Simplification

Page 12

IBM Software Group

Why legacy services ?

■ **Leverage existing assets**
▶ layer of abstraction that wraps existing assets as services that provide business functions

■ **Easier to integrate and manage complexity**
▶ integration point is the service specification and not the implementation

■ **More responsive and faster time-to-market**
▶ ability to compose new services out of existing ones

■ **Reduce cost and increase reuse**
▶ loosely coupled core business services can be more easily used and combined based on business needs

■ **Be ready for what lies ahead**
▶ better flexibility and responsiveness

Service Consumer

Service Provider

Business Process Architecture

Service-Oriented Architecture

Component-Based Architecture

Legacy Systems

Object-oriented Systems

Service Layer

Page 13

IBM Software Group 

The WebSphere Software Platform

- Web infrastructure software that helps companies at each stage of On Demand development
 - from startup,
 - to integrating and exploiting business processes,
 - to handling high volume Web transactions.

WebSphere Application Server

A next-generation application server that simplifies build-to-integrate tasks, accelerates application development, and enables dynamic application flexibility.

Application developers focus on business logic (components)

Containers and connectors conceal complexity and promote portability

Components inherit qualities of service of the underlying platform

Page 14

IBM Software Group 

J2EE - 3-tiered Distributed Computing Architecture

Page 15

IBM Software Group 

WebSphere - Foundation for Integration

Page 16

IBM Software Group 

Web Services

The building blocks of the future

- Service model used by WSADIE**
 - WebSphere Application Developer Integration Edition
- Self-contained, self-describing modular applications**
 - Can be published, located, and invoked across the Web
 - Are reusable building blocks of business functionality
- Use simple, standard interfaces for**
 - Publishing and discovering services
 - Communicating between service provider and service consumer in a platform-independent way (XML and SOAP)
- Web Service is an extension of the EJB enablement**

Page 17

IBM Software Group

CICS and IMS On Demand Strategy

e-business

e-business on demand

Evolution!NOT Revolution

Page 18

IBM Software Group

Agenda

- e-business Introduction
- CICS Assets and Implementations ←
- IMS Assets and Implementations
- Summary

Page 19

IBM Software Group

What assets in CICS can be transformed?

CICS TS

Transaction

client

Client adapter

Business logic

Data access logic

P

B

D

- Best practice in CICS application design is to separate key elements of the application, in particular:
 - ▶ Client adapter or presentation logic
 - ▶ Business logic
 - ▶ Data access logic

Page 20

IBM Software Group

Access to CICS programs – Adapter Style

- Typical e-business clients
 - ▶ Web browser
 - ▶ Java servlet or EJB
 - ▶ Web Services SOAP client
 - ▶ C# client in Microsoft .NET
 - ▶ WebSphere MQ client
- Adapter/connector can be
 - ▶ External (e.g. JavaBean using CICS Transaction Gateway classes)
 - ▶ Internal (e.g. CICS XML-aware program)
 - ▶ Written or generated by tools

3270 terminal

e-business client

P

A

B

D

P Presentation logic

A Adapter/connector

B Business logic

D Data access logic

Page 21

IBM Software Group 

Web-to-Host using HATS

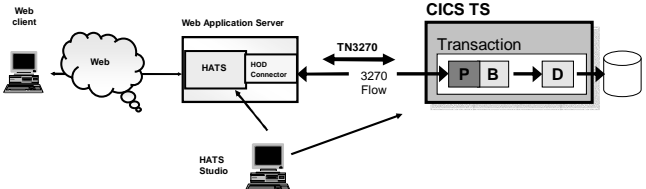

Host Access Transformation Server (HATS)

- ▶ Rules-based Web-to-Host transformation engine which dynamically converts 3270 screens in HTML pages
- ▶ Can generate Web services or other Java objects from host transactions
- ▶ Server based on WebSphere and 3270 HOD Connector
- ▶ HAST Studio based on WebSphere Studio (WSAD)

<http://www.ibm.com/software/webservers/hats>

Page 22

IBM Software Group 

Which architecture should I use to connect to CICS?

■ **Standard architectures provide a choice of options and support in CICS and tools**

- ▶ JCA (J2EE Connector Architecture)
- ▶ SOAP (Simple Object Access Protocol)
- ▶ Java RMI (Remote Method Invocation)
- ▶ JMS (Java Messaging Service)

■ **Lots of factors including ...**

- ▶ Security
- ▶ Transactionality
- ▶ Performance
- ▶ Architectural limits
- ▶ Synchronous or asynchronous invocation

■ **See redbook 'Architecting e-business Access to CICS'**

Page 23

IBM Software Group 

Which architecture should I use to connect to CICS? ...

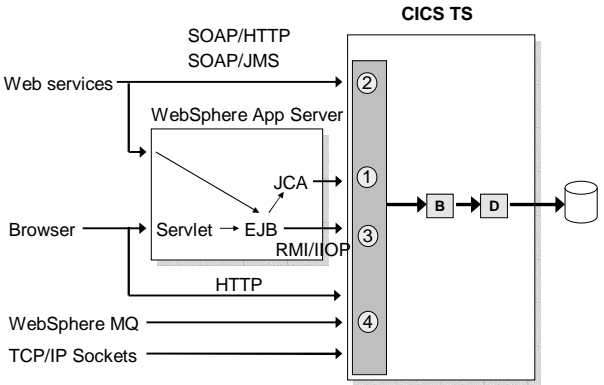

Page 24

IBM Software Group 

J2EE Connector Architecture (JCA) for CICS

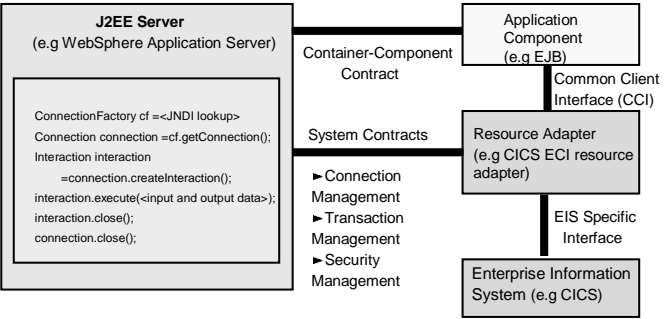

■ **Standard for connecting from J2EE to EIS**

■ **Resource adaptor is provided by EIS**

■ **CICS resource adapters are provided by CICS Transaction Gateway**

Page 25

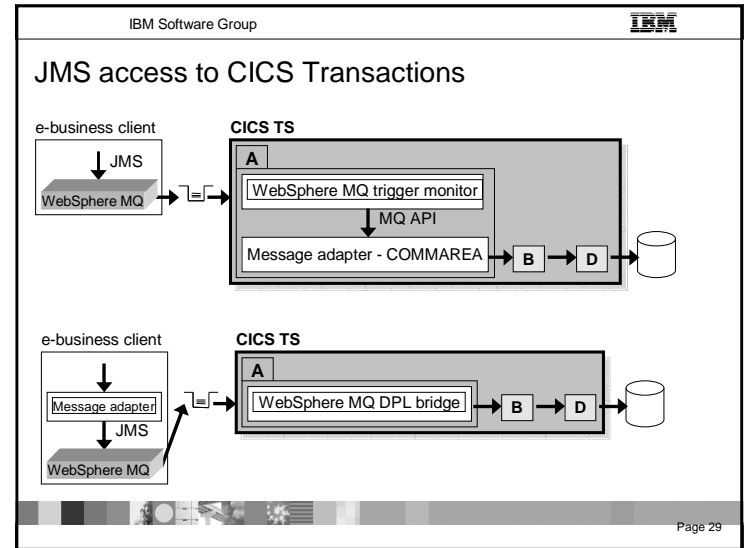
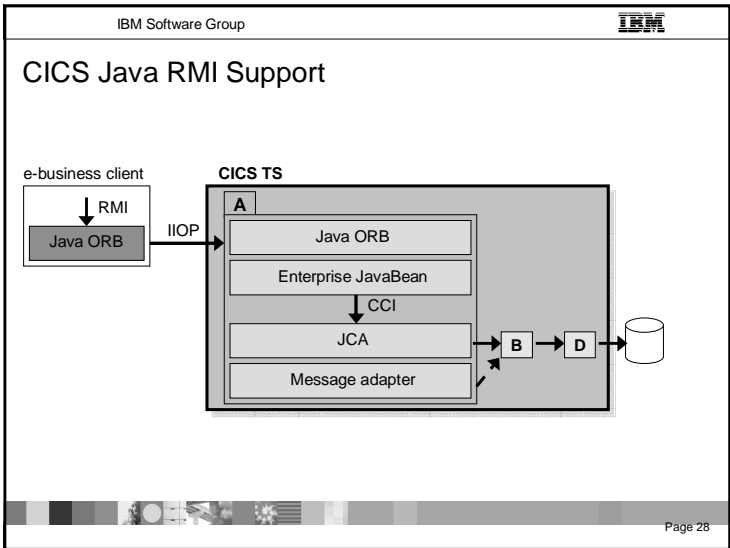
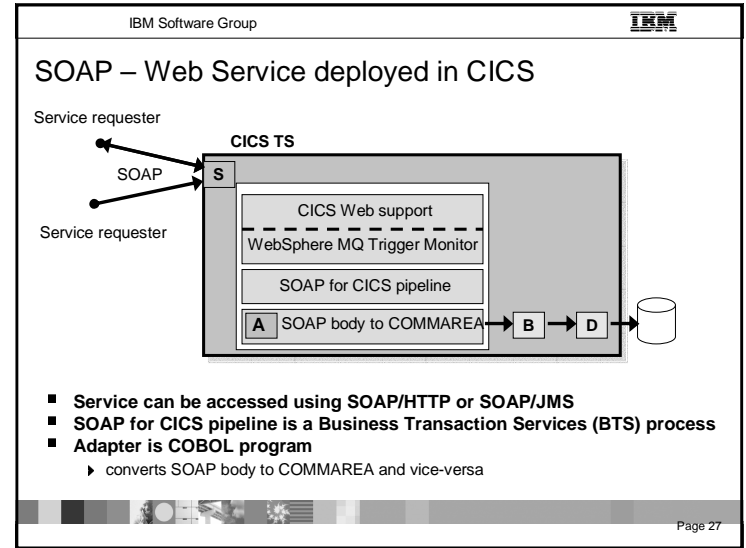
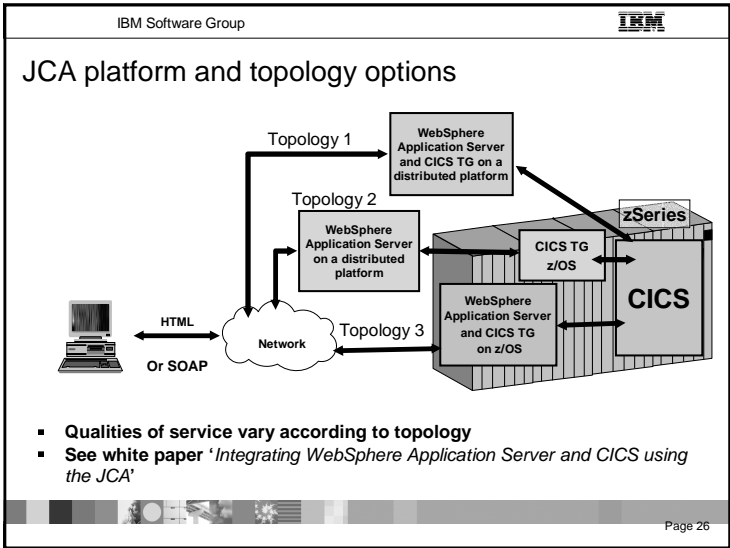

IBM Software Group

CICS Strategic Options Table

Standard architecture	Middleware	Interface
0. 3270 Revamping	HATS or Link3270bridge	3270 flow
1. SOAP	a - CICS SOAP support	XML in a CONTAINER COMMAREA
	b - WAS CT6	COMMAREA
2. JCA	WAS CT6	COMMAREA
3. Java RMI	CICS TS V2	Enterprise JavaBean (session bean)
4. JMS	WMQ	WMQ API or COMMAREA

Page 30

- IBM Software Group
- ### Agenda
- e-business Introduction
 - CICS Assets and Implementations
 - IMS Assets and Implementations ←
 - Summary
- Page 31

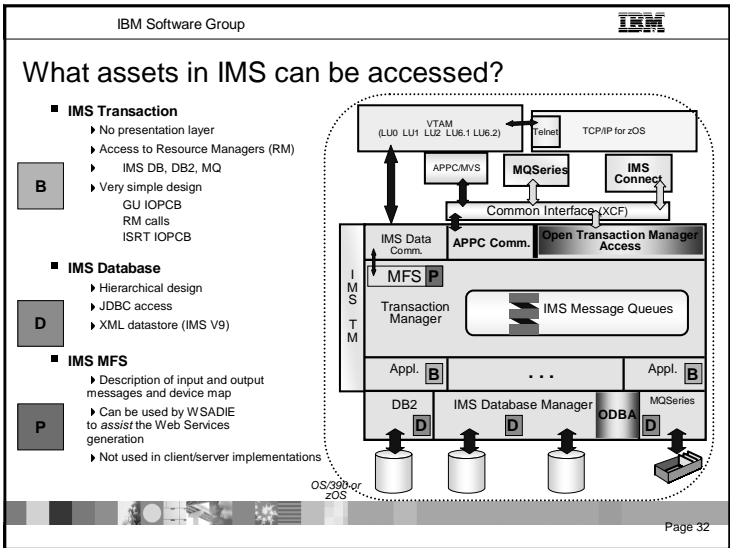

- IBM Software Group
- ### What assets in IMS can be accessed? ...
- **First IMS Asset – IMS Transactions**
 - ▶ Integrating IMS Transactions into an On Demand Application
 - Direct connection model
 - 3270 Emulation
 - JCA Connector
 - Messaging and Queuing model
 - Publishing as a Web Service
 - **Second IMS Asset – IMS Databases**
 - ▶ Integrating IMS Databases into an On Demand Application
 - Direct Connection model
 - ODBA
 - JCA Connector
 - ▶ Integrating IMS Databases in a Data Integration Platform
- Page 33

IBM Software Group

Web-to-Host using HATS

Host Access Transformation Server (HATS)

- Rules-based Web-to-Host transformation engine which dynamically converts 3270 screens in HTML pages
- Can generate Web services or other Java objects from host transactions
- Server based on WebSphere and 3270 HOD Connector
- HAST Studio based on WebSphere Studio (WSAD)

<http://www.ibm.com/software/webservers/hats>

Page 34

IBM Software Group

J2EE Connector Architecture (JCA) for IMS

■ **IMS Connector for Java**

- Provides connectivity to IMS Transactions

IMS Connector for Java

- Development component shipped with WSAD-IE
- zOS Runtime component shipped with IMS Connect
- Distributed Runtime downloadable from the web

Page 35

IBM Software Group

JMS Support, based on WMQ IMS Bridge

JMS access to IMS transaction based on the WMQ IMS Bridge

- Client program (or EJB) does an MQPUT to the application queue.
- WMQ routes the message to the appropriate z/OS Queue Manager.
- The MQ-IMS bridge transfers the message to the IMS input queue using OTMA.
- IMS transaction (XYZ) gets scheduled, issues a GU to retrieve the message, processes the message and issues an ISRT call to send the output message
- Unchanged IMS application – No MQ API calls
- The MQ-IMS bridge transfers the output message to the Reply_To_Queue.

Page 36

IBM Software Group

EJB Access to IMS Transaction

■ **Thru IMS Connect**

- Using IMS Connector for Java (IC4J)
- From any WebSphere platform
- zOS or distributed
- With J2EE Quality of Services

■ **Thru WebSphere MQ**

- Using MQSeries IMS Bridge

Page 37

IBM Software Group

Bridging SOAP and Existing IMS applications

- Development using WSADIE**
 - Import of the input/output message description from IMS COBOL and C applications or from IMS MFS MID/MOD formats
 - Automatic generation of WSDLs
 - Based on IC4J for IMS transaction access
- The IMS transaction, accessed via SOAP, can be "published" as a "Web Service".**

Page 38

IBM Software Group

IMS SOAP Gateway – Coming Soon

- So far ...**
 - IMS provides services for IMS applications using (a) the WebSphere Application Server, (b) IMS Connector for Java, and (c) IMS Connect
 - transform existing IMS transactions into services by using e.g. WSAD-IE to create service definitions for IMS transactions
 - deploy these service definitions to WAS to make the IMS services available as EJB services or SOAP web services
- The IMS SOAP Gateway is an XML based connectivity solution**
 - enable existing/new IMS applications to communicate outside of the IMS environment using SOAP
 - provide the ability for non-WebSphere customers to access IMS-based business logic
 - retrieve IMS WSDL files out of the UDDI directory and fit them into a tool (such as Microsoft .Net tools, or Apache Axis server tools) to generate SOAP messages to be sent to the host to run IMS applications
 - also use the standard APIs, such as Java API for XML-based RPC (JAX-RPC), to create both client and server code out of the generated WSDL files (RYO)

Page 39

IBM Software Group

IMS SOAP Gateway – Coming Soon ...

- Technology preview (demo) available at**
<http://www.ibm.com/ims> (then look for SOAP for IMS)
- This sample demonstrates how the input SOAP message can be sent to the IMS SOAP gateway to drive a back-end IMS transaction and to send output SOAP messages back to the client**

any platform any platform z/OS

Page 40

IBM Software Group

Access to IMS Data - Open Database Access

- Provides a callable interface to IMS databases from any z/OS programs that are not managed by IMS**
 - DB2 Stored Procedures
 - or Any applications that use z/OS Resource Recovery Services (RRS) to manage their syncpoint processing
- Connection to IMS TM or DBCTL**
 - Uses the Database Resource Adapter (DRA)
 - DL/I calls are issued using the Application Interface Block (AIB) interface

Page 41

IBM Software Group

Access to IMS Data - IMS Java

- A new feature in IMS since IMS V7
- A set of classes that...
 - ▶ Offers Java support to access IMS Databases from various environments (IMS, CICS, DB2, WebSphere)
 - ▶ Enables SQL access through the JDBC interface

Rapid Application Development

Extend the life and scope of IMS applications and databases

Leverage existing marketplace, industry-sanctioned standards - they are the lowest changing and most persistent
JDBC and J2EE are standards

Leverage new and abundant skills in the marketplace and mitigate the loss of 390 skills for customers

Page 42

IBM Software Group

EJB Access to IMS Databases

- Using IMS JDBC in WAS z/OS
 - ▶ Since IMS V7
- Using a gateway containing the IMS logic
 - ▶ A CICS application
 - ▶ A DB2 Stored Procedure under RRS control
 - ▶ Same z/OS than the IMS Database Manager
- Using IMS JDBC in a distributed WAS
 - ▶ With IMS V9
 - ▶ Using a WAS for z/OS Gateway
 - ▶ IMS logic in distributed EJB

Page 43

IBM Software Group

DB2 Information Integrator Classic Federation

- Read from and write to mainframe data sources using SQL
- Standards-based access via ODBC, JDBC, or Call Level Interface
- Multi-threaded with native drivers for scalable performance
- Metadata-driven means:
 - ▶ No mainframe programming required
 - ▶ Fast installation & configuration
 - ▶ Ease of maintenance
- Works with existing and new:
 - ▶ Mainframe infrastructure
 - ▶ Application infrastructure
 - ▶ Toolsets

Page 44

IBM Software Group

IMS Strategic Options Table

Standard architecture	Middleware	Interface to IMS transaction
Revamping 3270	WAS + HATS + TCPIP for zOS + VTAM	3270 flow
JCA	WAS + IMS Resource Adapter	IMS Connect
JMS	WMQ	MQSeries IMS Bridge
SOAP	WAS + IMS Resource Adapter	IMS Connect
Data Integration	DB2 II Classic Federation + IMS Transaction Services	APPC/IMS

Standard architecture	Middleware	Interface to IMS database
On demand CICS solution	CICS Transaction	Database Resource Adapter
WAS for zOS EJB + IMS JDBC	WAS for zOS + RRS	ODBA
WAS Distributed EJB + IMS JDBC (before IMS V9)	DB2 Stored Procedure	ODBA
WAS Distributed EJB + IMS JDBC (after IMS V9)	WAS for zOS	ODBA
Data Integration	DB2 II Classic Federation	ODBA

Page 45

Summary

- **Legacy applications are critical to enterprise customers**
 - ▶ On-demand not interesting unless it includes legacy
 - ▶ Maintain forward progress (preserve customer investments)
 - ▶ Ratio of legacy to J2EE developers typically 5x to 10x
 - ▶ Applications must live for a long time!

An on demand business is an enterprise whose business processes — integrated end-to-end across the company and with key partners, suppliers and customers — can respond with speed to any customer demand, market opportunity or external threat.

The Essentials of an On Demand Breakthrough

Where you start depends on YOUR organization's priorities.

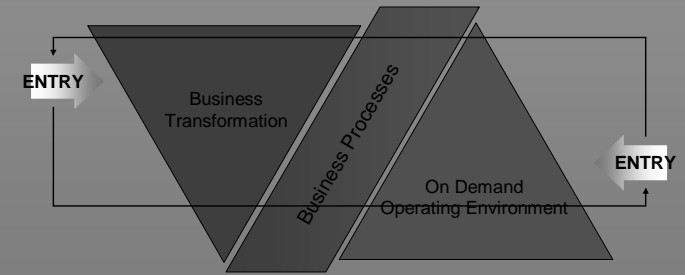

- Increasing flexibility is the key — business models, processes and infrastructure
- Technology acts as an enabler instead of a barrier