

IBM Workplace : Live !



IBM Lotus Notes/Domino v7, fonctionnalités et évolutions



Agenda

- Overview Notes / Domino 7
- Les clients V7
- Le serveur V7
- Démonstrations

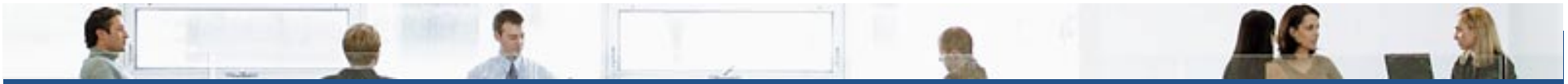

Un peu d'histoire

- 1989 : Notes v1
- 1993 : Notes v3 ... 0,5 million d'utilisateurs
- 1995 : IBM achète Lotus Development S.A.
- 1996 : Notes v4
- 12/1996 : Notes / Domino v4.5 ... au goût du Web
- 1999 : Notes / Domino v5 ... 56 millions d'utilisateurs
- 2000 : 80 millions d'utilisateurs
- 2001 : De Lotus Development SA à Lotus Software
- 2002 : Notes / Domino 6
- 2004 : Notes / Domino 6.5
- 2005 : Notes / Domino V7 ... 110 millions d'utilisateurs

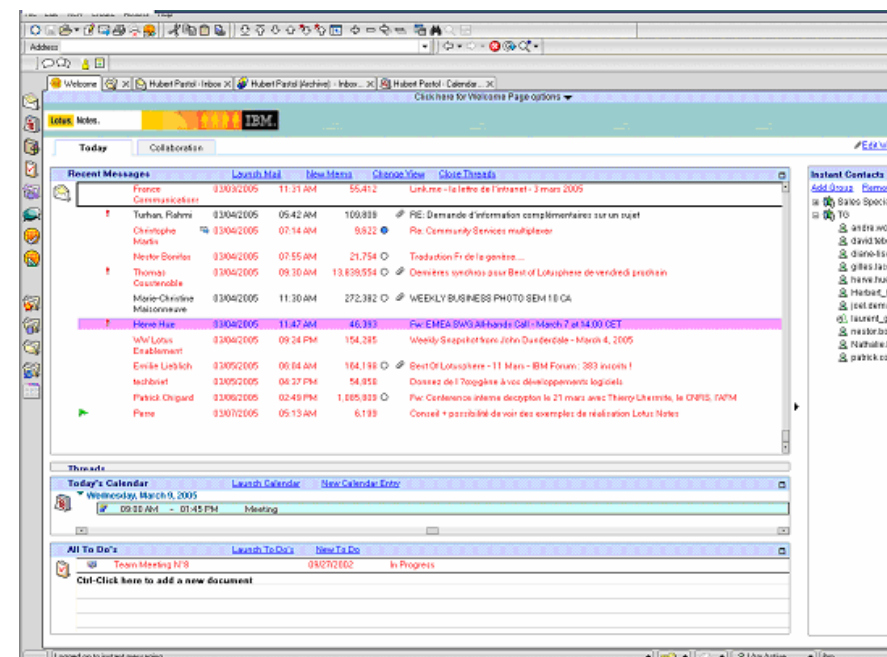

Sans révolution ...



- Forms/Views
- @Formulas

- Forms/Views
- @Formulas
- Agents
- ODBC

- Forms/Views
- @Formulas
- Agents
- ODBC
- LotusScript
- SMTP

- Forms/Views
- @Formulas
- Agents
- ODBC
- LotusScript
- SMTP
- POP/IMAP
- HTML Pages

- Forms/Views
- @Formulas
- Agents
- ODBC
- LotusScript
- SMTP
- POP/IMAP
- HTML Pages
- CORBA
- Java/Javascript

- Forms/Views
- @Formulas
- Agents
- ODBC
- LotusScript
- SMTP
- POP/IMAP
- HTML Pages
- CORBA
- Java/Javascript
- Servlets
- JSPs
- SOAP/XML

- Forms/Views
- @Formulas
- Agents
- ODBC
- LotusScript
- SMTP
- POP/IMAP
- HTML Pages
- CORBA
- Java/Javascript
- Servlets
- JSPs
- SOAP/XML
- DB2
- Web Services

Protection des investissements & Compatibilité



Les atouts IBM Lotus Domino

- Une plate-forme collaborative fortement sécurisée pour échanger des données, relier les communautés et les personnes entre-elles
 - Choix et flexibilité
 - Coût de possession (TCO)
 - Sécurité
 - Qualité de service – Haute disponibilité

Domino 7 améliore ces points forts !

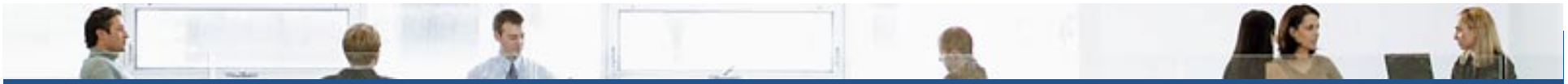

Notes 7.0

Points principaux

- Principales améliorations:
 - La Productivité
 - La Facilité d'usage
 - Le Total cost of ownership
 - L'amélioration de la qualité
 - L'intégration avec Lotus Instant Messaging
 - L'intégration avec Lotus Workplace & Workplace Client Technology



Nouveautés Notes 7.0

Intégration avec Instant Messaging et Web Conferencing

- Généralisation de l'awareness (C&S forms/views, Discussion, and TeamRoom)
- Création de web conférences sécurisées (password / restrict attendance)
- Contrôle de votre détection de présence

The screenshot displays the Notes 7.0 interface. At the top, there's a 'Discussion' section with buttons for 'New Main Topic', 'New Response', 'New Response to Response', and 'Chat with Author'. Below this is a table of discussion topics. The first topic is 'Notes Client presentations (Heidi Votaw)' dated 06/29/2004. A blue box highlights the 'Chat with Author' button and the user icon next to the topic title. Below the discussion board is a 'Calendar' for Heidi Votaw, showing the date 29 June 2004. A blue box highlights the 'Chat' dropdown menu, which is open, showing options like 'Chat with...', 'Show/Hide Instant Contact List', and 'Add to Instant Contact List...'.

Date	Topic
06/29/2004	Notes Client presentations (Heidi Votaw)
	More updates (Heidi Votaw 06/29)
06/29/2004	New Notes 7 features (Heidi Votaw)

5 pm	2 pm	Meeting to review Notes 7 features Location: Conference call
6 pm	3 pm	Chair: Heidi Votaw



Nouveautés Notes 7.0

Intégration avec Instant Messaging et Web Conferencing

- Options supplémentaires pour la buddy list
- Sauvegarde des chats dans la BAL
- Support des URLs Notes
- Interopérabilité avec Workplace Instant Messaging

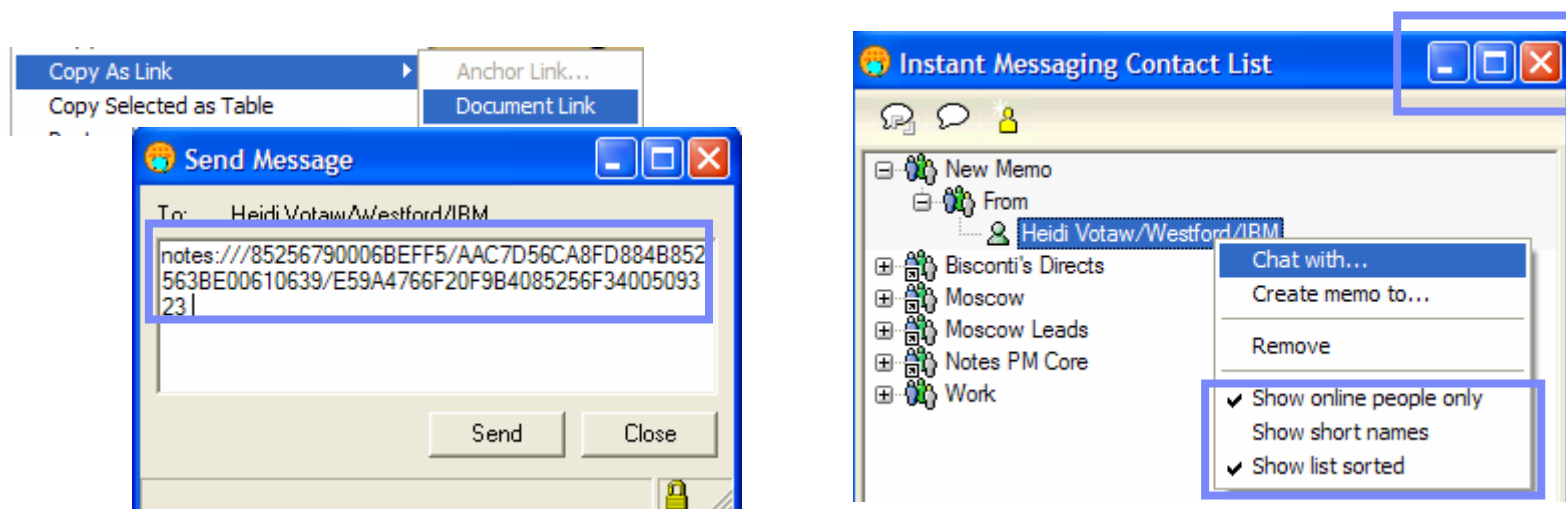

Nouveautés Notes 7.0

autres améliorations ...

- Utilitaire de nettoyage pour l'agenda
- Interface d'archive utilisateur
- Tri par sujet dans la vue Inbox et Tous Documents
- Sauvegarde de toutes les fenêtres actives à la fermeture de Notes
- Fermeture rapide de toutes les fenêtres Notes
- Prompt de confirmation à la fermeture
- Avertissement pour prévenir que l'objet du message est "vide"
- Intégration MSFT (Smart Tags Support)
 - Support d'Office 2003

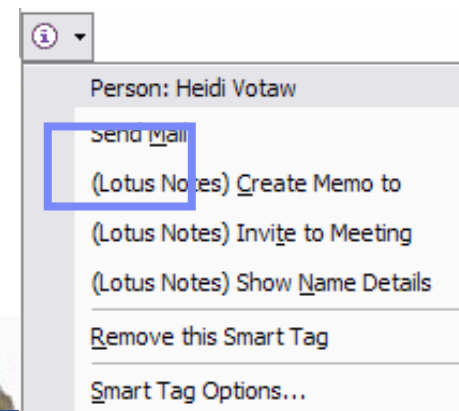
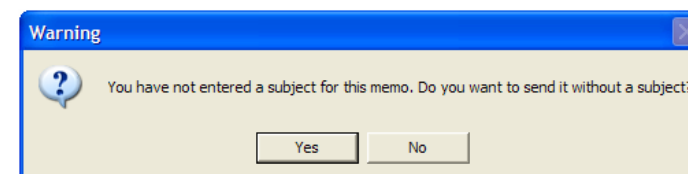
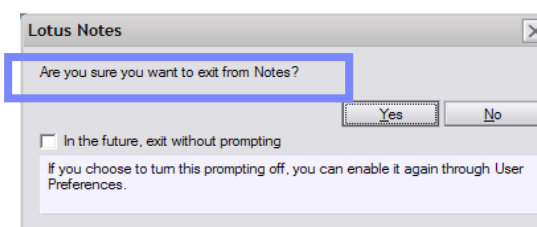
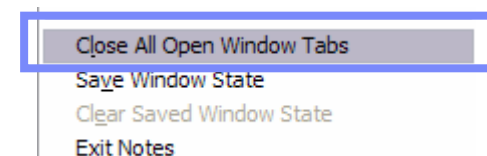

Nouveautés Notes 7.0

autres améliorations ...

- Auto Save
- Ouverture de vue en Asynchrone (non bloquant)
- Mail threads dans le formulaire de Mail
- Indicateurs “pour”, “copie”, ”bcc”

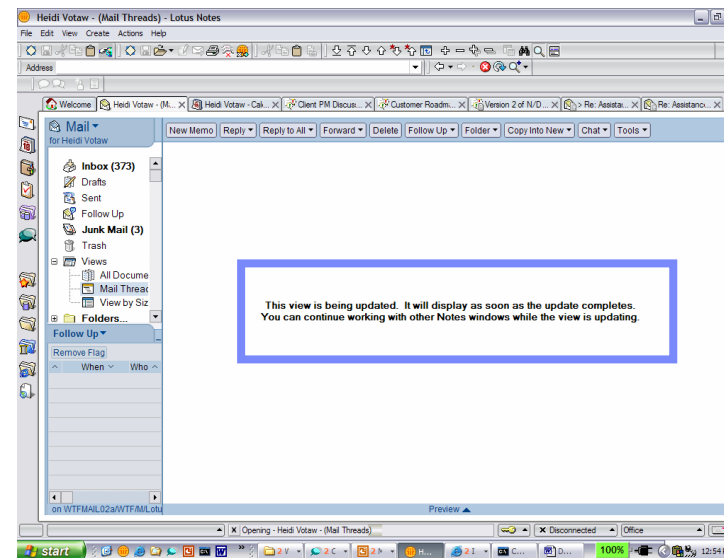

Who ^	Date v	Time	Subject
Jenifer P. Kidder	06/24/2004	03:32 PM	Slides for Monday's project review available
Jenifer P. Kidder	06/25/2004	09:19 AM	Re: Slides for Monday's project review available

Mail | Calendar & To Do | Access & Delegation |

Basics | Letterhead | Signature | Follow Up | Message Marking |

Senders | Recipients |

The following settings will apply to mail addressed to you or any alternate or group name you specify below, but will not apply if you receive mail as a member of a group. Enabling any setting will display a new column in the mail views.

Display a solid circle when I am the only recipient in the To field

Display a half-solid circle when my name is one of UP TO this many names in the To field: 2

Display an empty circle when my name is in the cc field or is one of more than 2 in the To field

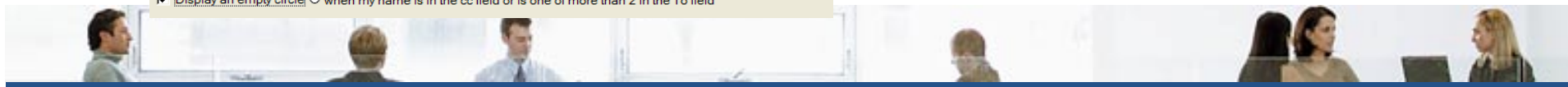

Nouveautés Notes 7.0

autres améliorations ...

- Mail policies : Pour tous les paramètres de messagerie !
 - Préférence de messagerie (online/offline)
 - Règles (serveur/client)
- Desktop Policies : Pour tous les paramètres du bureau !
 - Bookmarks, settings in the location documents, archiving, security/ECL, etc
- Verrouillage des règles

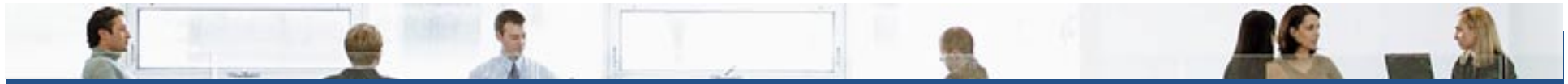

Domino Web Access

Nouveautés V7

- Thème plus proche du Portail et de Notes
- Interface personnalisable
- Police réduite
- Performance
- Intégration Chat
- WebMail Redirect
- Chiffrement / Signature
- Mail Threads (message en lecture)

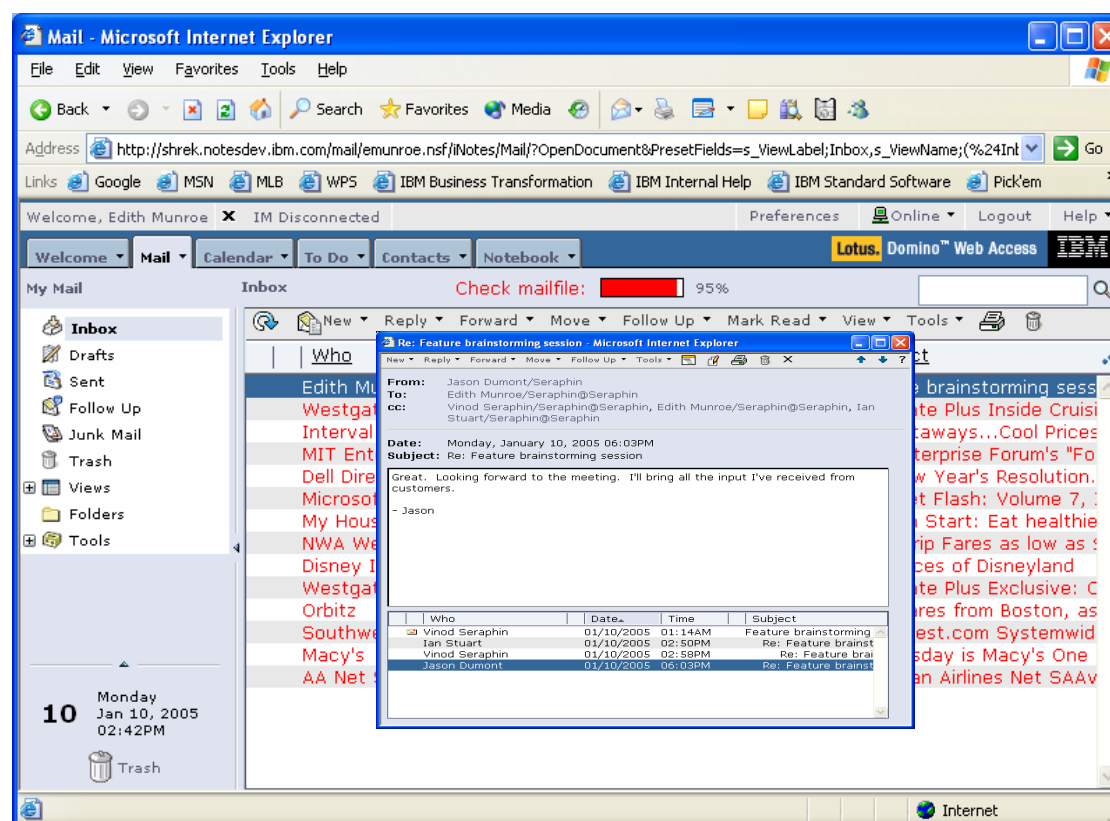

Nouveautés V7

Domino Web Access Configuration Server

- Performance
 - Alarms
 - Mail polling
 - Calendar (PDF) printing
 - Archiving
 - Full text indexing
- Security settings
 - Access to encrypted documents
 - Require SSL
 - Notes ID access
 - Browser cache management

Welcome Page Setup	
Default Welcome Page:	View/Modify...
Allow user to edit the Welcome Page	Enabled
Alarms	
Alarms	Enabled
Minimum alarm polling time	5 minutes
Mail	
Minimum mail polling time	5 minutes
When sending mail, set format to:	Let user decide
Name resolution and validation:	Enabled
Maximum attachment size (kb):	50000
Mail threads:	Enabled
Mail Encryption	
Encrypted mail support:	Enabled
Allow user to delete their Notes ID from their mail database:	Disabled
Allow user to export their Notes ID:	Disabled
Require SSL when reading encrypted mail:	Client
Use JavaScript for SSL-redirect requests:	Enabled
Allow untrusted Internet certificates to be used for S/MIME encryption:	Disabled



Les autres clients de Domino 7

Domino Access for Microsoft Outlook (DAMO)

The screenshot displays the Microsoft Outlook calendar interface. The window title is "Calendar - Microsoft Outlook". The menu bar includes File, Edit, View, Go, Tools, Synchronize, Actions, and Help. The toolbar shows various calendar navigation options like New, Today, Day, Work Week, Week, and Month. The main area shows a calendar for Tuesday, October 05, 2004, with a time slot from 8 am to 8 pm. Several events are visible, including "Outlook Connector weekly call", "Update: Outlook Connector post DCUT project review meeting", "Update: Lotus Workplace 2.5: Weekly Development Managers' Meeting", "Lotus Marketplace Assessment 'Lunch & Learn'", "Ken & Brendan", "Update: Outlook Connector review", and "Lend Lease Internal Prep Call". The left sidebar shows navigation options like Mail, Calendar, Contacts, Tasks, Notes, Folder List, and Shortcuts. The bottom taskbar shows the Start button, system tray with battery level at 14%, and several open applications including DominoFor... and Lotus Note... The system clock shows 10:24 PM on Tuesday, 10/5/2004.

Domino Mail & WebSphere Portal

Nouvelle *Portlet de messagerie*

Common PIM Portlet

- Portlet native de messagerie et Agenda
- Disponible avec WebSphere Portal Server 5.1

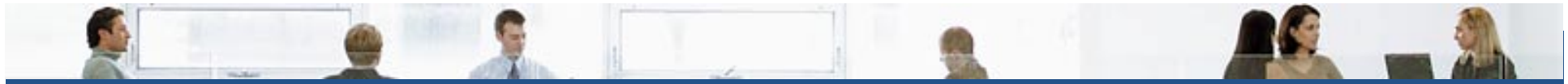
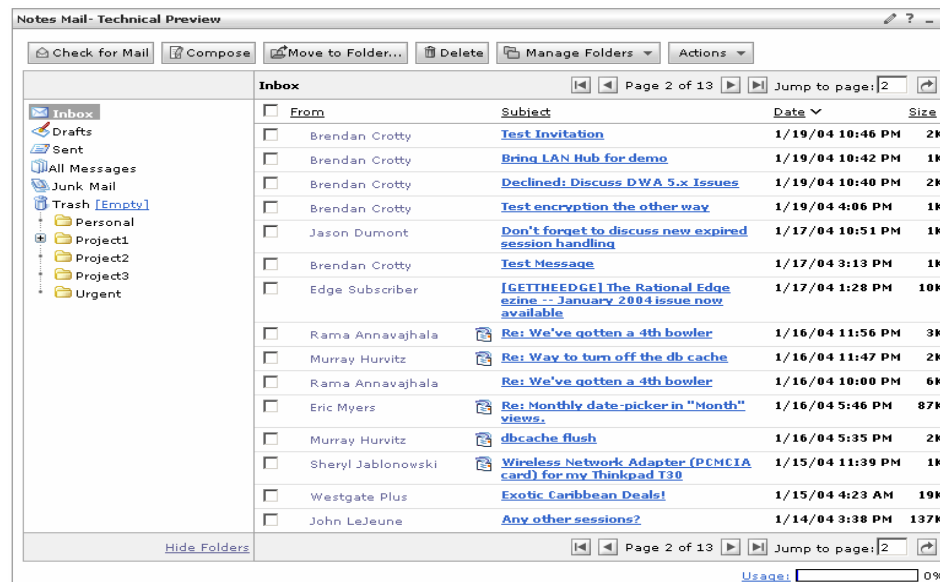

IBM Workplace : Live !



IBM Lotus Domino v7



Rappel : Domino 6.5

- **Déploiement / upgrade**

- Smart upgrade
- Politique d'administration

- **Utilisateur, desktop et annuaire**

- Annuaire central vs annuaire de configuration
- Active Directory Sync
- Politique d'archive

- **Mail Management**

- SPAM: DNS blacklist

- **Server Monitoring/
Troubleshooting**

- Fault Recovery et Diagnostic automatique
- Tivoli Analyzer

- **Autres améliorations**

- Transaction Logging
- Gestion des Quotas
- Statistic/Event Monitoring & Reporting
- Activity Logging
- License Tracking
- AdminP (Administration Process)

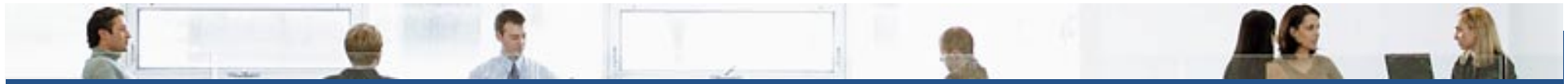

Domino 7.0

Nouveautés

- Réduire les coûts de déploiement et de support
 - Upgrade automatique du client
 - Amélioration des politiques d'administration
 - Mail policy management
 - Client policy lockdown
- Réduire le temps d'analyse d'un problème serveur
 - Domino Domain Monitoring (DDM)
 - Intégration de Tivoli Analyzer
 - Script d'Administration
- E-mail Management
 - Archive (par date de création)
 - Amélioration du support Anti-SPAM
- Solution complète Domino sur Linux
 - Web Admin avec Linux/Mozilla
- Support de DB2

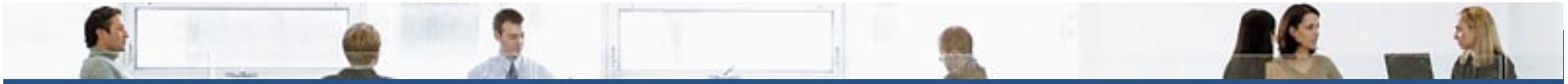

Domino 7.0

Notes Smart Upgrade

Smart Upgrade réduit le coût de gestion
du client Notes (upgrade)

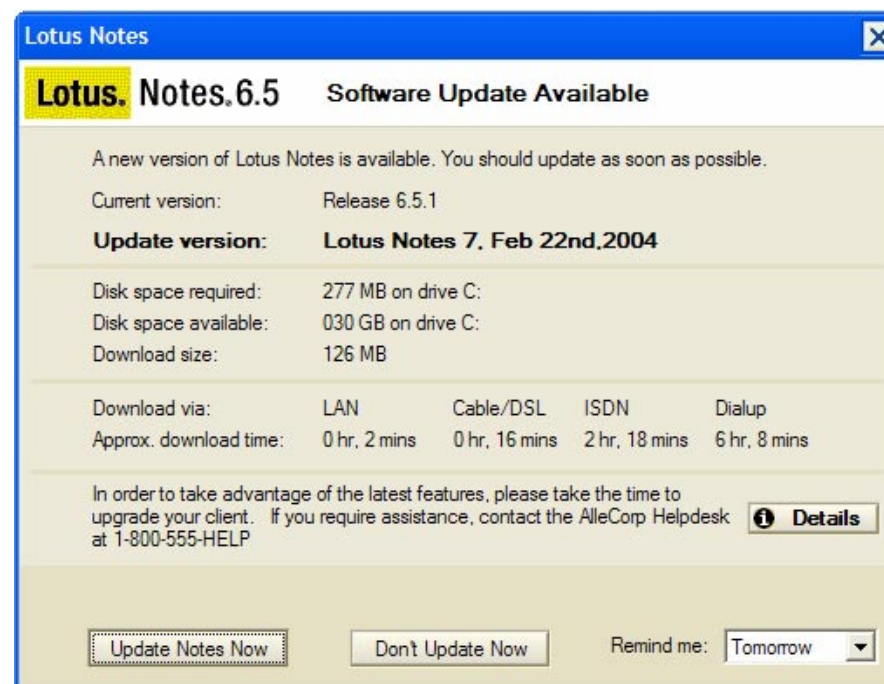
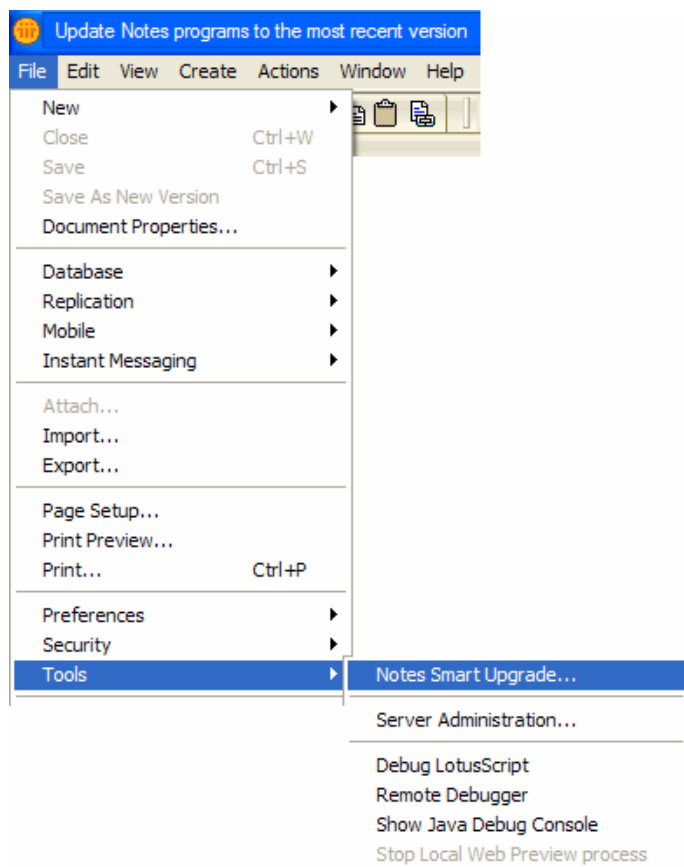

Domino 7.0

Notes Smart Upgrade, comment ça marche ?

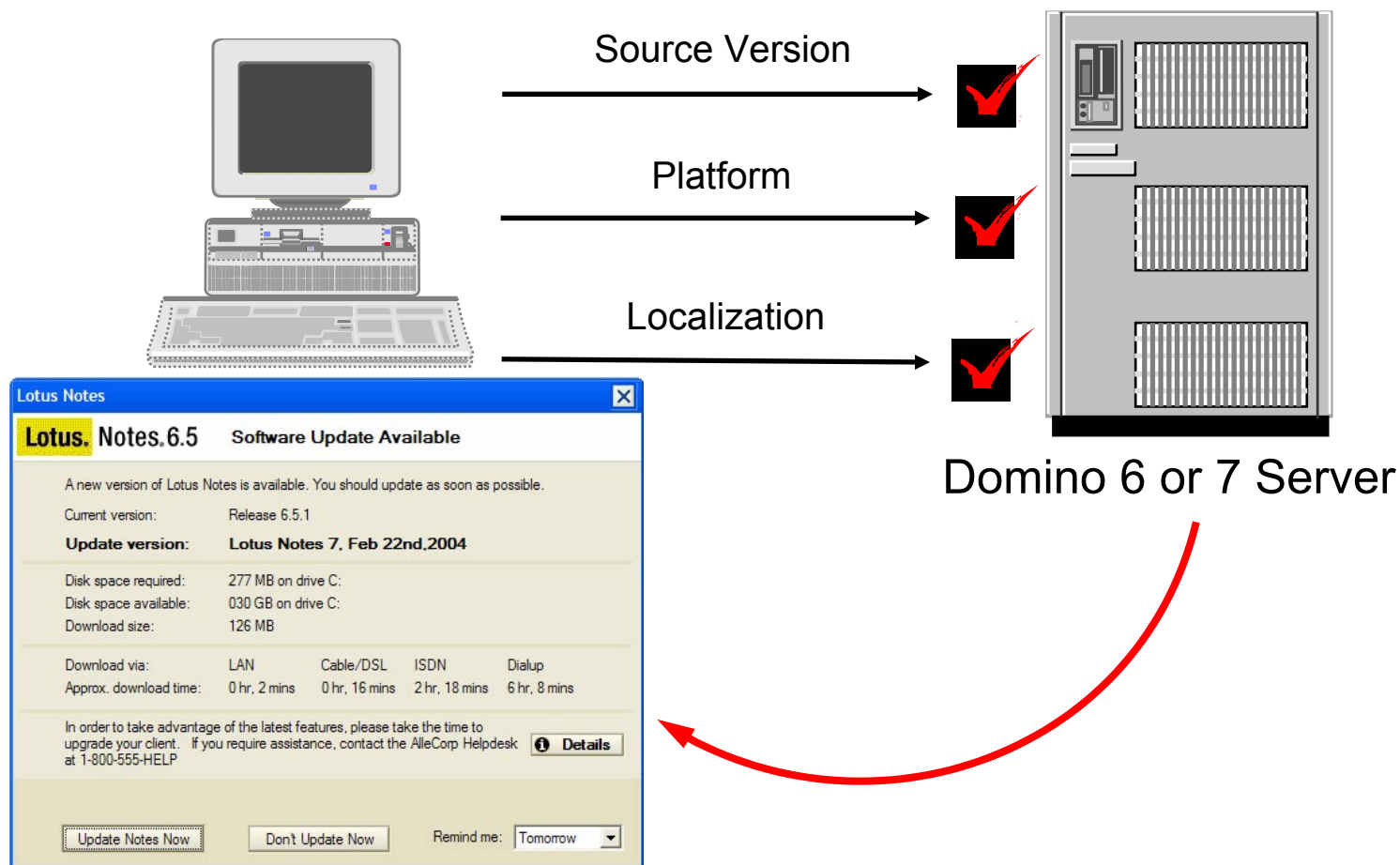

Domino 7.0

Gestion à base des politiques d'administration

- Application des paramètres de configuration
 - Basée sur la structure de l'organisation
 - Explicite, organisationnelle
- Bénéfices:
 - Plus de contrôle --> Moins de problèmes de support
 - Simplicité d'utilisation
 - Réduction du TCO
- 6.0.x & 6.5.x
 - Notes Client setup
 - Desktop settings
 - Security
 - Registration
 - Archiving
- 7.0
 - Verrouillage des politiques d'administration
 - Nouvelles politiques messagerie et agenda

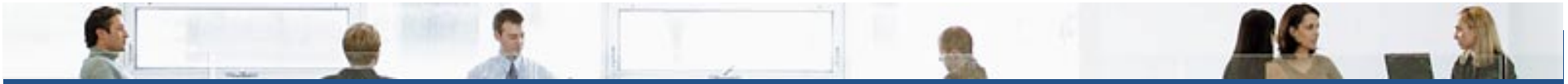

Lotus Notes

File Edit View Create Actions Window Help

Welcome Domino Directory - Policies\Setti... Configuration for SMTP Router... Alan Lepofsky - Inbox Final Details for Opening... Product Catalog - by Title

Domino Directory

Add Settings... Edit Settings Delete Settings

Type	Setting Name ^	Description
Archive Settings		
	1 Year archiving	Remove all messages older than 1 year
	3 Year archiving	Remove all messages older than 3 years
	90 Day ARCHIVING	Remove all messages older than 90 days
Desktop Settings		
	Standard Client Configuration	Preferences and notes.ini, Sametime Server, local mail,
	WELCOME PAGE AND BOOKMARKS	Default desktop look and feel for all employees
	Welcome Page for Marketing	Notes start up for marketing teams
	Welcome Page for Sales	Notes start up for sales teams
Registration Settings		
	Group assignments for Finance	Adds people to all the appropriate groups
	Group assignments for Human Resources	Adds people to all the appropriate groups
	IBM Executive MAILFILE QUOTAS	Enforces the mail file size restriction for senior staff
	IBM standard mailfile quotas	Enforces the corporate mail file size restriction
Security Settings		
	Execution Control List - Developers	control the execution of code based on signer name
	Execution Control List - Standard	control the execution of code based on signer name
	PW Length and Quality - Admin	set how strong PWs are for administrators
	PW Length and Quality - Standard	set how strong PWs are for general users
	Synch HTTP PW with Notes ID PW	Used for divisions that don't require multiple PWs
Setup Settings		
	Create Local Mailfile Replica	used for mobile workers
	Location and Connection Documents	define standard configuration for user workstation
	Sametime Server for AP	Assign ST server to AP employees
	Sametime Server for NA	Assign ST server to NA employees

Domino Directory

IBM Workplace : Live !



Domino 7.0 - Intégration avec DB2



Domino 7

Quel est l'intérêt d'intégrer Domino avec DB2 ?

- Permettre de développer des applications Domino mixant des services de collaboration avec des données structurées en utilisant le langage SQL
- Utiliser la capacité de stockage de DB2 pour Domino
- Permettre aux entreprises de consolider leurs données dans DB2 et de les intégrer plus facilement avec d'autres applications

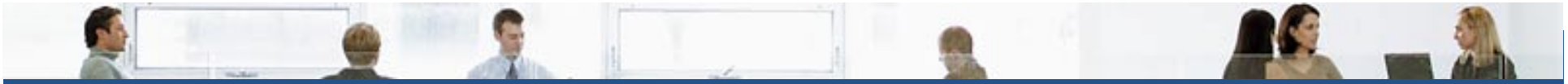

Domino 7

Le support de DB2 dans Domino 7

- Domino 7 supporte DB2 comme une *option* de stockage
 - Pas un remplacement du NSF
- Fonctionnellement transparent pour les applications
 - APIs compatibles
- Nouvelles fonctions
 - DB2 access views
 - Query views – SQL based queries as views

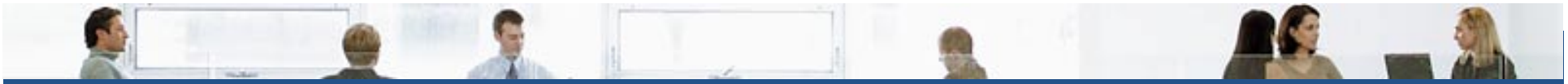
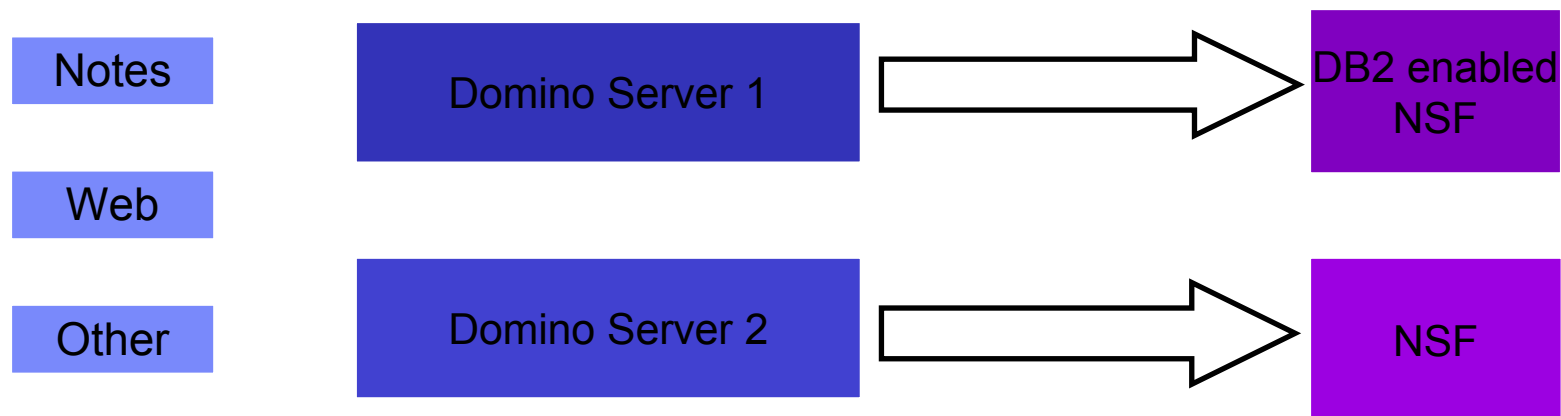

Domino 7

Le support de DB2 dans Domino 7

- Les serveurs Domino / DB2 peuvent gérer simultanément des bases NSF traditionnelles et des bases DB2

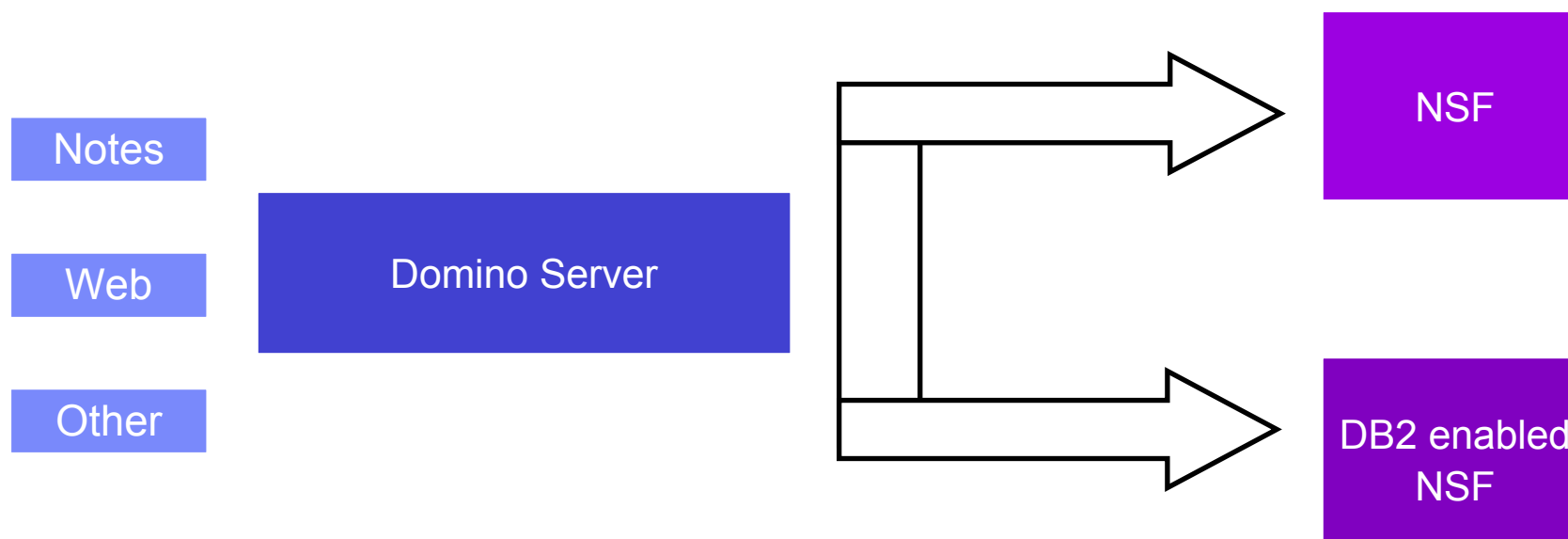

Intégration DB2

Architecture

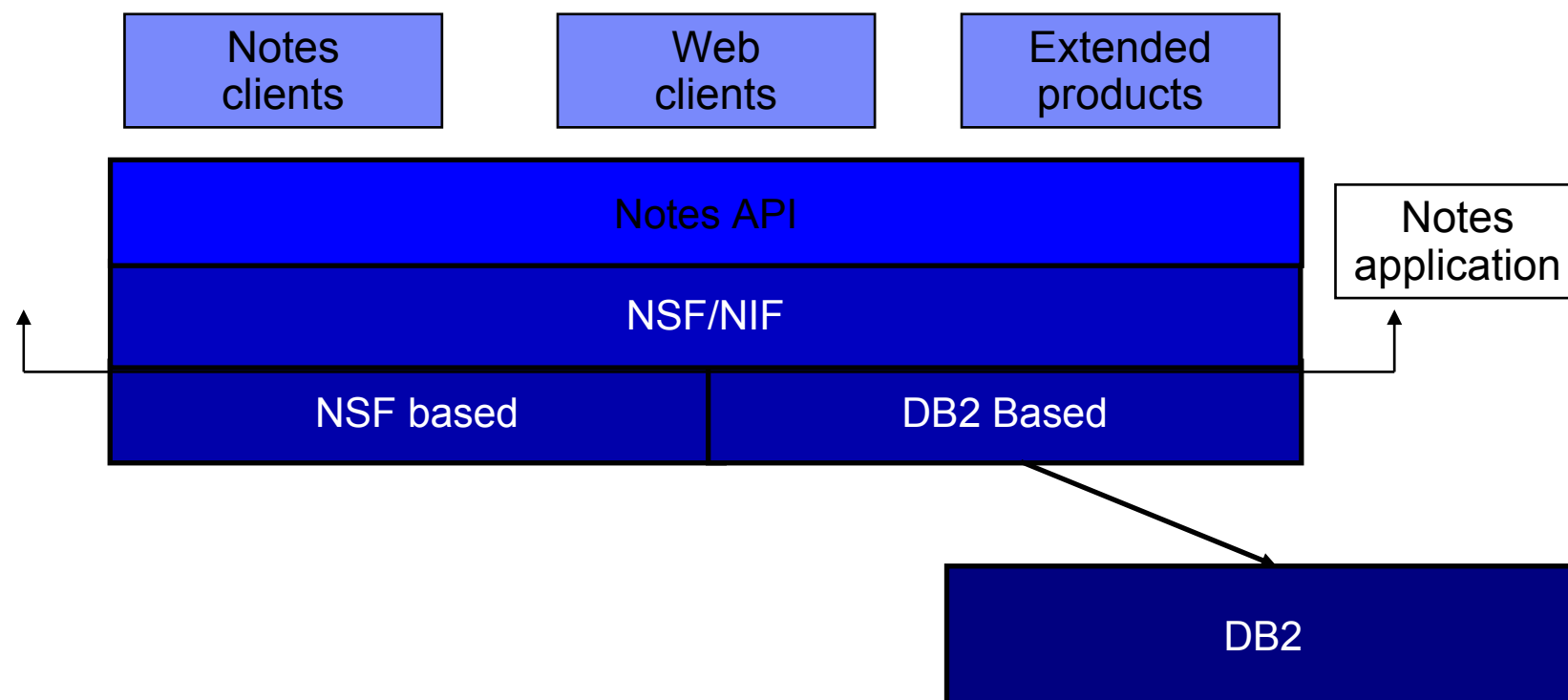

Intégration DB2

Développement d'application

- DB2 Access View (Nouvel élément de design)
 - organise vos champs en tables
 - utilise des requêtes SQL au lieu de données Domino
 - expose les données Notes aux applications DB2
- DB2 Query views (Nouveau type de vue)
 - La sélection de vue se fait par une requête SQL
 - Données calculées, puissance du SQL (joins, etc.)

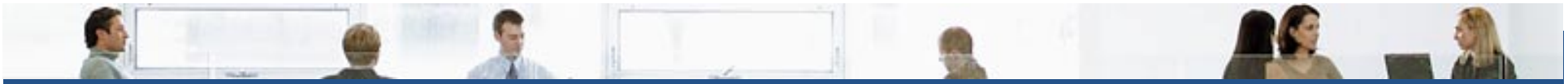
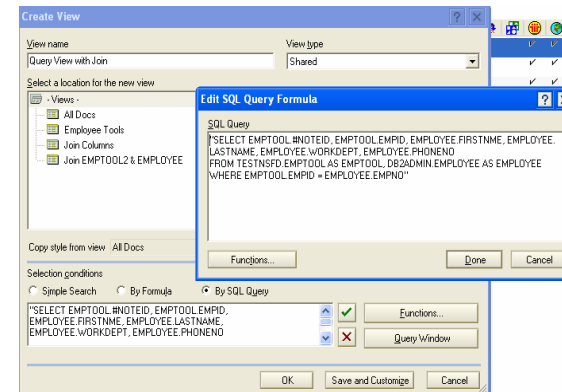
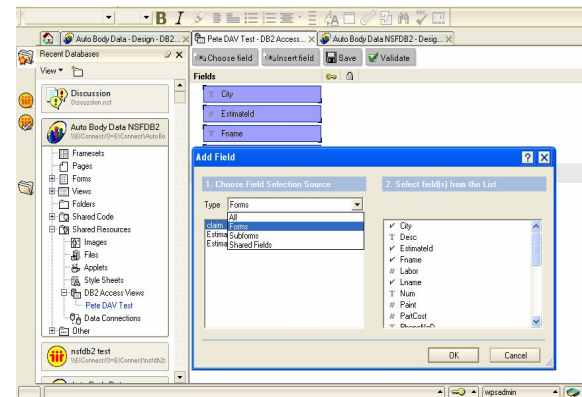

Intégration DB2

DB2 access View

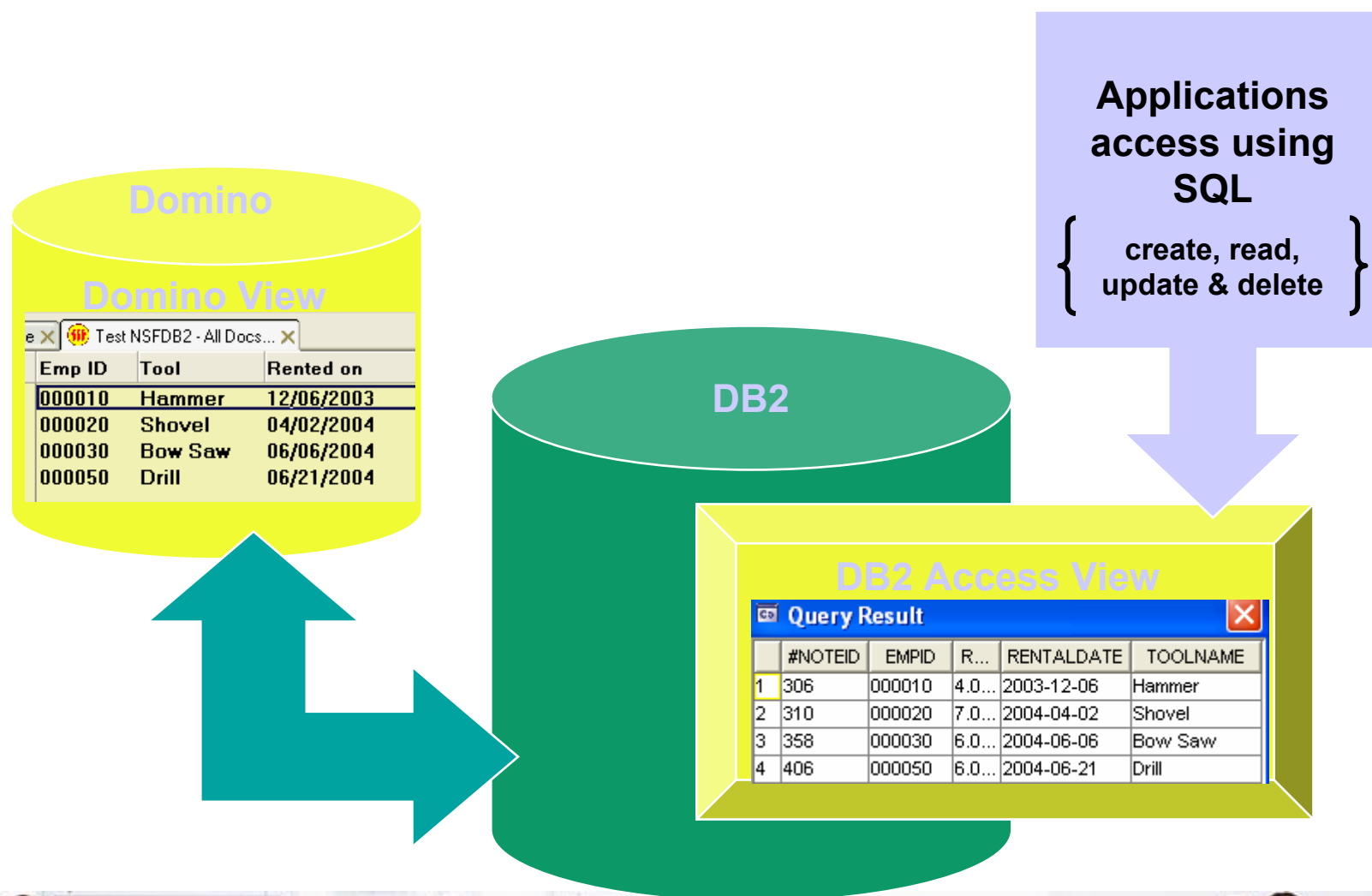

Intégration DB2

DB2 access View

Design element holds definition for DB2 Access view. Need to click action button to create view in DB2

Name	Last Modified	Last Modified By	Comment
Estimate DAV	01/06/2005 12:50:05 PM	db2admin/EIConnect	Customer repair estimates

Access View Element



Intégration DB2

DB2 access View

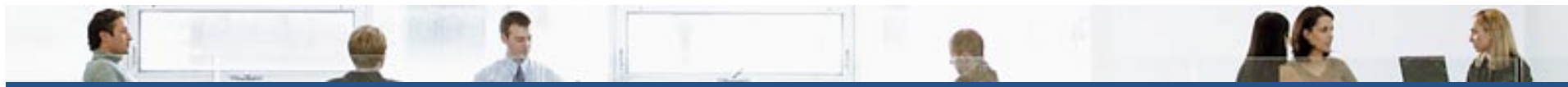
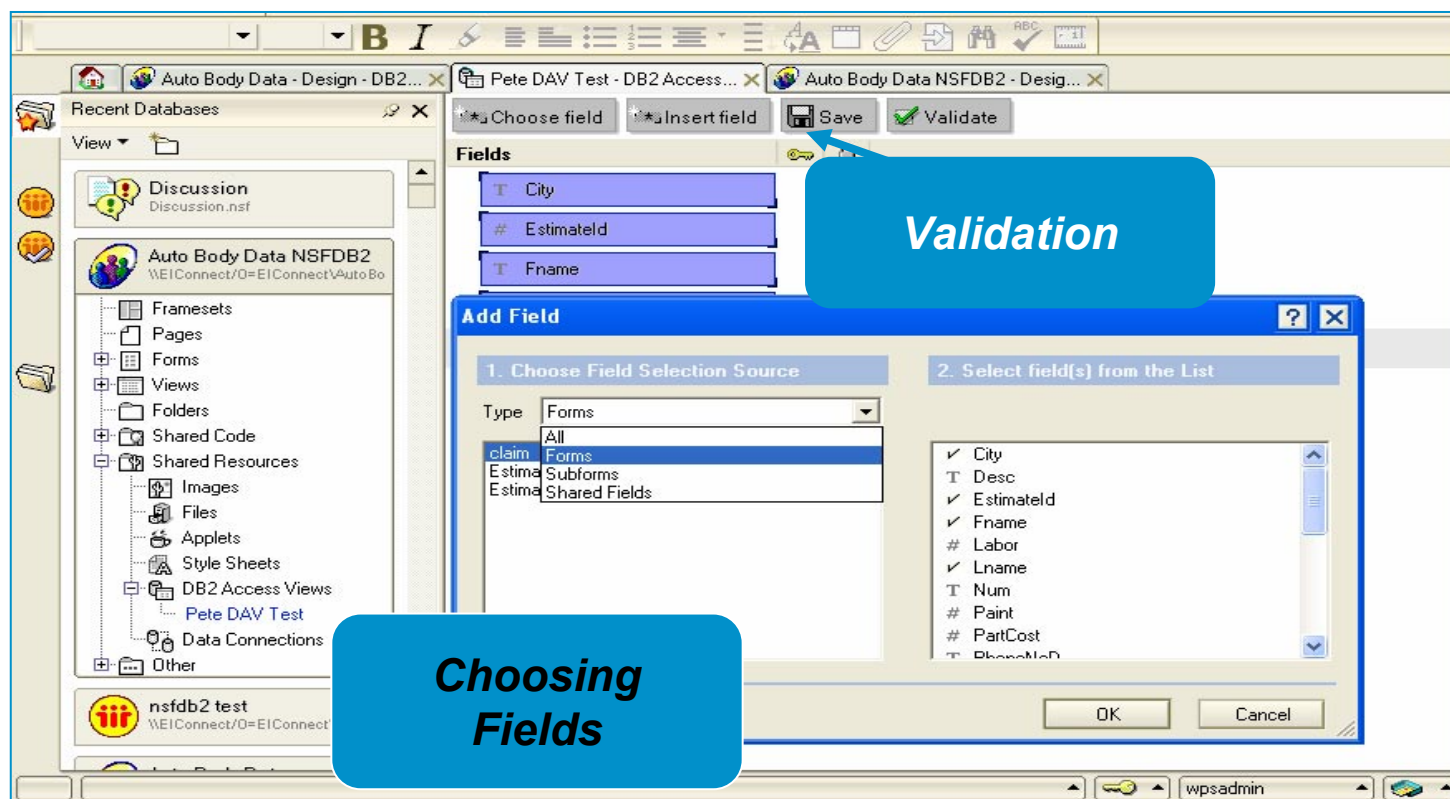

Intégration DB2

DB2 Query view



Create View

View name: Query View with Join View type: Shared

Select a location for the new view

- Views -
 - All Docs
 - Employee Tools
 - Join Columns
 - Join EMPTOOL2 & EMPLOYEE

Copy style from view: All Docs

Selection conditions:

Simple Search By Formula By SQL Query

SQL Query:

```
"SELECT EMPTOOL.#NOTEID, EMPTOOL.EMPID, EMPLOYEE.FIRSTNME, EMPLOYEE.LASTNAME, EMPLOYEE.WORKDEPT, EMPLOYEE.PHONENO FROM TESTNSFD.EMPTOOL AS EMPTOOL, DB2ADMIN.EMPLOYEE AS EMPLOYEE WHERE EMPTOOL.EMPID = EMPLOYEE.EMPNO"
```

Buttons: Functions..., Done, Cancel

Buttons: OK, Save and Customize, Cancel



Intégration DB2

DB2 Query view

The screenshot shows a Lotus Notes window titled "Test NSFDB2 - Join EMPTOOL2 & EMPLOYEE - Lotus Notes". The window displays a table with the following data:

Emp ID	Tool	Rented on	First Name	Last Name	Phone #	Department
00010	Hammer	12/06/2003	CHRISTINE	HAAS	3978	A00
00020	Shovel	04/02/2004	MICHAEL	THOMPSON	3476	B01
00030	Bow Saw	06/06/2004	SALLY	KWAN	4738	C01
00050	Drill	06/21/2004	JOHN	GEYER	6789	E01

Two callouts point to the data in the table:

- Data from DB2 Access View**: Points to the first row (Emp ID 00010).
- Data from Different DB2 App**: Points to the second row (Emp ID 00020).



Domino 7

Domino Domain Monitoring (DDM)

- Moyen efficace pour analyser et déterminer les problèmes d'un domaine Notes depuis une seule interface
- Comment?
 - Automatisation de la détermination des problèmes (analyse par fonction)
 - Remonte et analyse des problèmes entre les serveurs
 - Détails masqués
 - Configuration simple
 - Prépare des initiatives "autonomic computing"

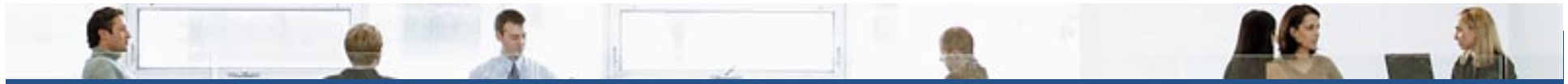

Domino 7

Domino Domain Monitoring (DDM) , Data Collection Hierarchy

- CS = Collection Server
- DDM.nsf (output and UI) sur chaque serveur
- L'information est remontée via réplication sélective

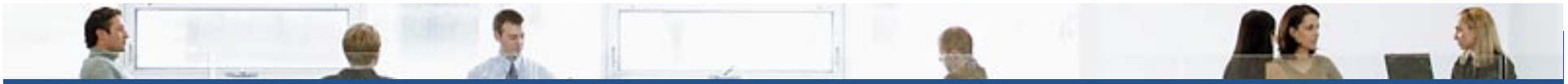
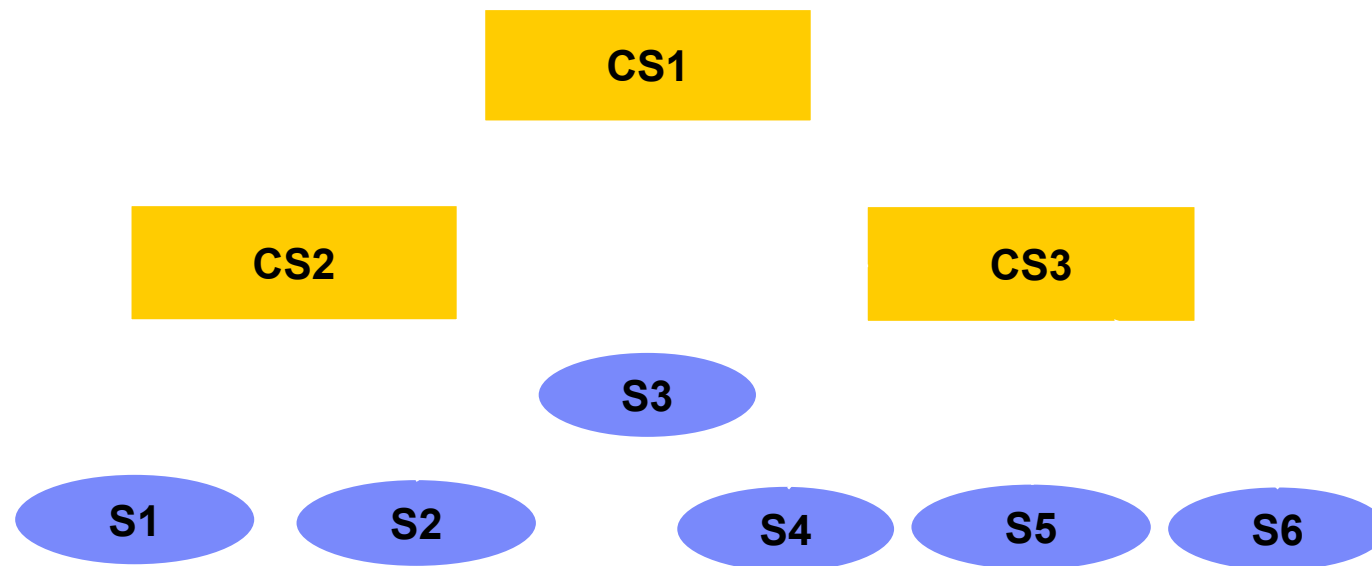

Domino 7

Autres nouveautés

- Tivoli Analyzer - Activity Trends
 - Outil de planification / équilibrage de charge
- Anti Spam - Blacklist/Whitelist Support
 - DNS whitelists
 - Private whitelists
 - Private blacklists
- Message Disclaimers
- Domino 7.0 Web Admin Client for Linux/Mozilla
- Performance

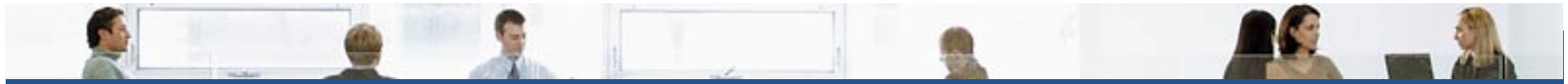

IBM Workplace : Live !



Roadmap Domino



Poursuite des investissements Domino

Rôle clé dans la stratégie Workplace

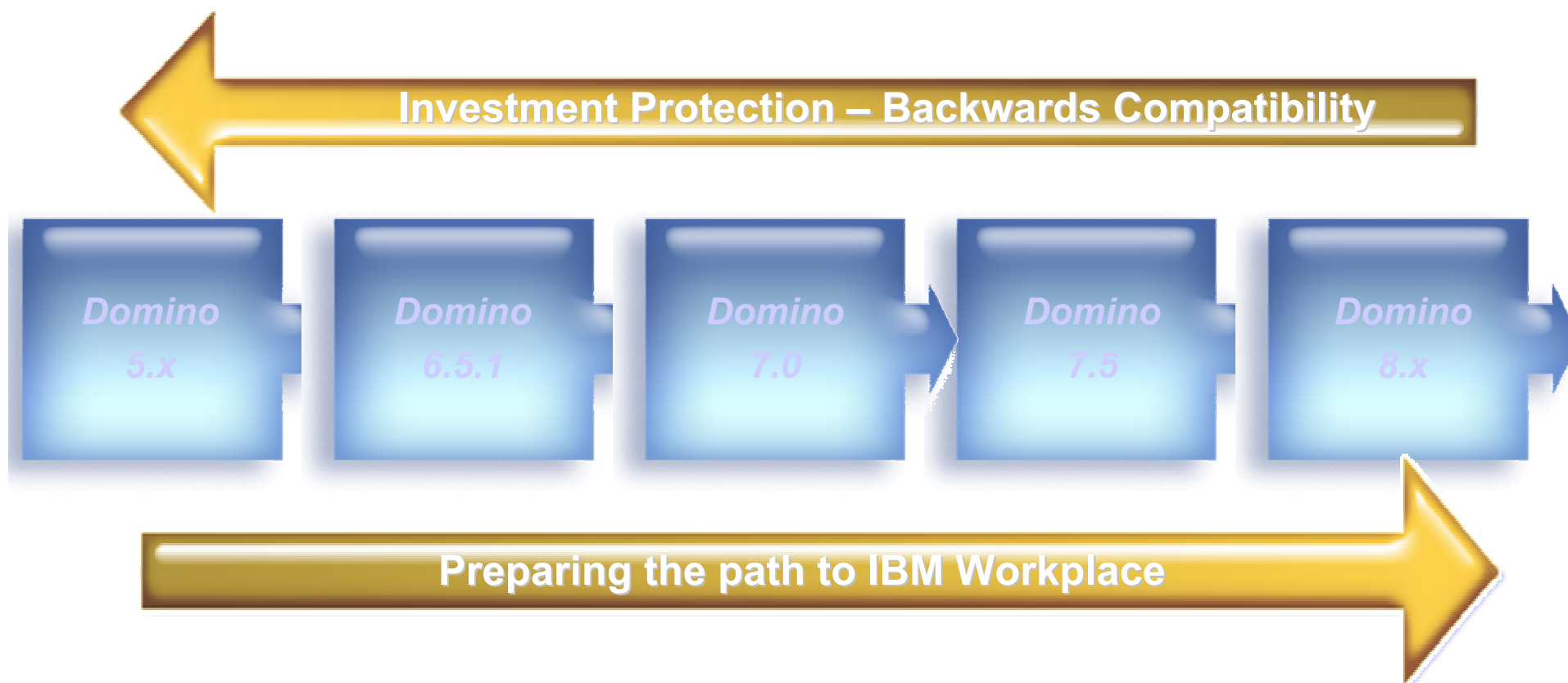

Soyez prêts pour Domino 7 !!

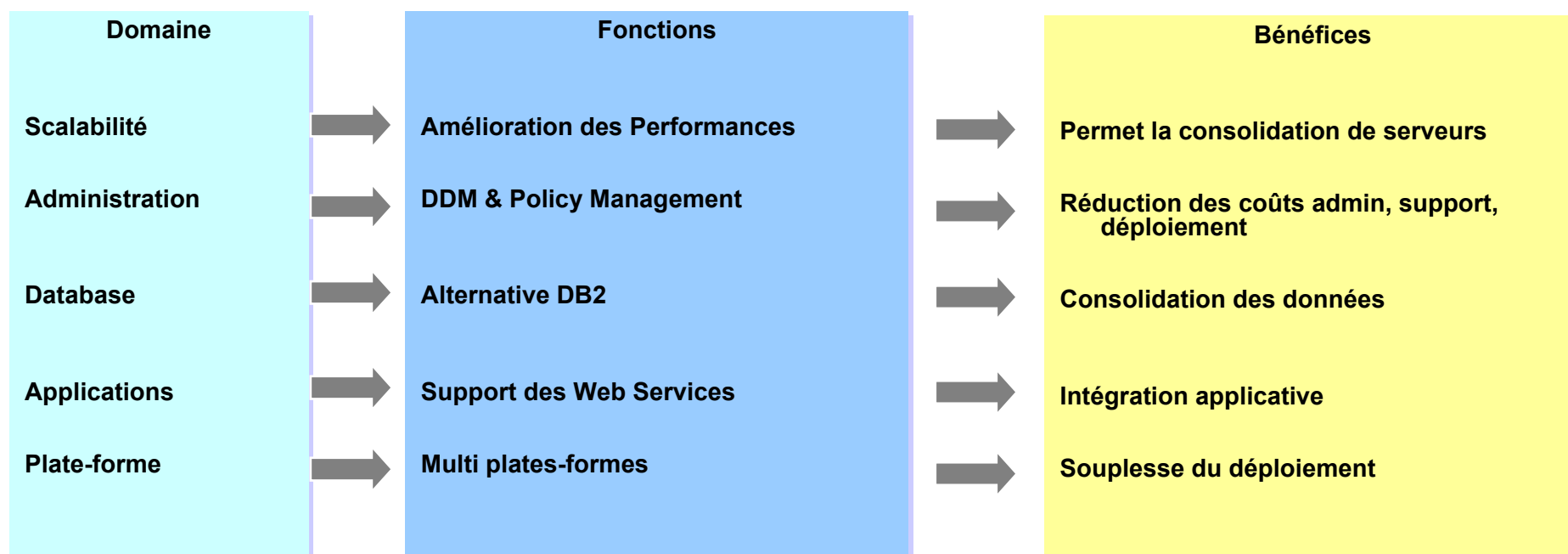

Informations & ressources

- Notes / Domino 7 Public beta site
www-10.lotus.com/ldd/beta/nd7pubbeta.nsf
- Feedback forum for Notes / Domino 7
www-10.lotus.com/ldd/beta/nd7pubbeta.nsf/DateAllThreadedWeb?OpenView

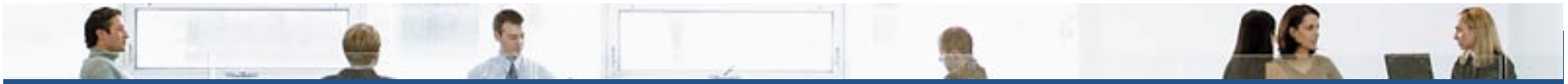

IBM Workplace : Live !



Merci !

