

*IBM MobileFirst Platform Foundation
for iOS V7.0.0*

IBM

Note

Before you use this information and the product it supports, read the information in "Notices" on page A-1.

IBM MobileFirst Platform Foundation for iOS V7.0.0

This edition applies to version V7.0.0 of IBM MobileFirst Platform Foundation for iOS and to all subsequent releases and modifications until otherwise indicated in new editions.

This edition was updated last on 25 Jan 2017.

This PDF document is made available for convenience and on an "as is" basis only. The master and controlling document can be found in Knowledge Center at http://ibm.biz/knowctr#SSHSCD_7.0.0/wl_welcome.html. This PDF document may contain uncontrollable formatting errors or differences from the master version in Knowledge Center.

© Copyright IBM Corporation 2006, 2016.

US Government Users Restricted Rights – Use, duplication or disclosure restricted by GSA ADP Schedule Contract with IBM Corp.

Contents

IBM MobileFirst Platform Foundation for iOS V7.0.0 documentation 1-1

Product overview 2-1

Introduction to mobile application development	2-1
Product main capabilities	2-1
Product components	2-4
Product editions	2-7
System requirements	2-7
Matrix of features and platforms	2-8

Release notes 3-1

What's new	3-1
Efficient and scalable app data storage	3-1
Standards-based integration and authentication	3-2
Core value features	3-3
Improved MobileFirst API	3-5
Tutorials and samples	3-6
What's new in V7.0.0 interim fixes	3-6
iOS 9 support	3-7
Exporting and importing custom chart definitions for analytics	3-8
Deprecated and removed features	3-8
Deprecated features and API elements	3-8
Removed features	3-9
Known issues	3-10
Known limitations	3-10

Troubleshooting 4-1

Tutorials, samples, and additional resources 5-1

Installing and configuring 6-1

Installation overview	6-1
Installing command-line tools for developers	6-2
Uninstalling command-line tools for developers	6-2
Installing MobileFirst Server	6-2
Planning the installation of MobileFirst Server	6-3
Tutorial for a basic installation of MobileFirst Server	6-23
Running IBM Installation Manager	6-29
Installing the MobileFirst Server administration	6-43
Installing a server farm	6-97
Configuring MobileFirst Server	6-105
Backup and recovery	6-105
Optimization and tuning of MobileFirst Server	6-105
Optimization of MobileFirst Server project databases	6-108
Testing MobileFirst Server performance	6-111
Security configuration	6-117
Protecting your mobile application traffic by using IBM WebSphere DataPower as a security gateway	6-122

Configuring MobileFirst Server to enable TLS V1.2	6-133
Configuring SSL between MobileFirst adapters and back-end servers by using self-signed certificates	6-135
Configuring SSL by using untrusted certificates	6-136
Handling MySQL stale connections	6-143
Managing the DB2 transaction log size	6-144
Installing the IBM MobileFirst Platform Operational Analytics	6-145
Installing IBM MobileFirst Platform Operational Analytics for WebSphere Application Server Liberty	6-146
Installing IBM MobileFirst Platform Operational Analytics for WebSphere Application Server	6-147
IBM MobileFirst Platform Operational Analytics installation for Tomcat	6-151
Configuring the MobileFirst Server for the IBM MobileFirst Platform Operational Analytics	6-151
Installing the MobileFirst Data Proxy	6-152
Planning the installation of MobileFirst Data Proxy	6-152
Installing and configuring the MobileFirst Data Proxy	6-153
Installing and configuring the Application Center	6-162
Installing Application Center with IBM Installation Manager	6-162
Manual installation of Application Center	6-168
Configuring the Application Center after installation	6-188
Configuring WebSphere Application Server full profile	6-189
Configuring WebSphere Application Server Liberty profile	6-191
Configuring Apache Tomcat	6-192
Configuring properties of DB2 JDBC driver in WebSphere Application Server	6-192
Configuring WebSphere Application Server to support applications in public app stores	6-193
Managing users with LDAP	6-194
Defining the endpoint of the application resources	6-214
Configuring Secure Sockets Layer (SSL)	6-219
Managing the DB2 transaction log size	6-222
List of JNDI properties for the Application Center	6-223
Predefining MobileFirst Server configuration for several deployment environments	6-227
Creating the property file	6-228
Using a property file in the file system	6-229
Using property files injected into a web archive file	6-232
Using a shared library of JNDI properties	6-235

Typical topologies of a MobileFirst instance in an extranet infrastructure	6-239	Developing applications for iOS	8-4
Setting up IBM MobileFirst Platform Foundation for iOS in WebSphere Application Server cluster environment	6-241	Developing native applications for iOS	8-4
Setting up an IBM HTTP Server in an IBM WebSphere Application Server Liberty profile farm	6-252	Updating mobile apps with IBM MobileFirst Platform Foundation for iOS and the Application Center	8-14
Integrating IBM WebSphere DataPower with a cluster of instances of MobileFirst Server	6-260	MobileFirst Platform Command Line Interface for iOS	8-15
Endpoints of the IBM MobileFirst Platform Server production server	6-272	CLI commands usage	8-16
HTTP Interface of the production server	6-275	Commands	8-16
Troubleshooting IBM MobileFirst Platform Server	6-280	Developing the server side of a MobileFirst application	8-85
Troubleshooting to find the cause of installation failure	6-280	MobileFirst Java adapters	8-85
Troubleshooting failure to create the DB2 database	6-280	MobileFirst JavaScript adapters	8-94
Troubleshooting a MobileFirst Server upgrade with Derby as the database	6-281	USSD Support	8-151
Troubleshooting failure to authenticate to Application Center and applications that use the basic registry element.	6-281	Deploying adapters.	8-156
Troubleshooting server farm configuration issues	6-282	Testing adapters.	8-157
		Client access to adapters	8-158
		JSONStore	8-161
		JSONStore overview	8-161
		General JSONStore terminology	8-162
		JSONStore API concepts	8-165
		Troubleshooting JSONStore	8-168
		JSONStore examples	8-174
		JSONStore advanced topics	8-178
		JSONStore security utilities	8-184
		Storing mobile data in Cloudant	8-186
		Configuring access to Cloudant.	8-188
		Obtaining the IMFData SDK.	8-190
		Creating databases	8-191
		Setting user permissions	8-192
		Modeling data	8-193
		Performing CRUD operations	8-196
		Creating indexes.	8-199
		Querying data	8-200
		Supporting offline storage and synchronization	8-201
		Push notification	8-203
		Possible MobileFirst push notification architectures	8-204
		Setting up push notifications	8-206
		Broadcast notifications.	8-207
		Event source-based notifications	8-208
		Interactive notifications	8-209
		Tag-based notification	8-210
		Silent notifications	8-211
		Unicast notifications	8-212
		Web-based SMS subscription	8-212
		Sending push notifications	8-214
		Sending SMS push notifications	8-215
		Sending push notifications from WebSphere Application Server – IBM DB2	8-216
		Configuring a polling event source to send push notifications	8-216
		Using two-way SMS communication	8-219
		Troubleshooting push notification problems	8-220
		MobileFirst security framework.	8-221
		OAuth-based security model	8-221
		Classic security model.	8-242
		Simple data sharing	8-253
		Simple data sharing overview	8-253
		Simple data sharing general terminology	8-254
Upgrading to IBM MobileFirst Platform Foundation for iOS V7.0.0	7-1		
Version compatibility	7-1		
Migrating projects to V7.0.0 using MobileFirst Platform Command Line Interface for iOS	7-3		
Migrating IBM SmartCloud Analytics Embedded to IBM MobileFirst Platform Operational Analytics	7-3		
Upgrading to MobileFirst Server V7.0.0 in a production environment	7-4		
Overview of the upgrade to MobileFirst Server V7.0.0 process	7-5		
Preparation for upgrades to MobileFirst Server	7-7		
Starting the MobileFirst Server V7.0.0 upgrade process	7-20		
Running IBM Installation Manager and completing the Application Center upgrade	7-25		
Upgrading the MobileFirst runtime environment for MobileFirst Server V7.0.0	7-31		
Additional MobileFirst Server V7.0.0 upgrade information.	7-43		
Updating deployment scripts	7-52		
Rolling upgrade procedure to apply a fix pack to IBM MobileFirst Platform Foundation for iOS V7.0.0.	7-53		
Planning the rolling upgrade procedure	7-54		
Overview of the rolling upgrade procedure	7-55		
Performing a rolling upgrade to install a fix pack	7-55		
Applying a fix pack to the MobileFirst Data Proxy	7-62		
Developing MobileFirst applications	8-1		
Artifacts produced during development cycle.	8-1		
MobileFirst projects	8-2		
Integrating with source control systems.	8-2		

Enabling the Simple Data Sharing feature	8-254	Associate beacons and triggers (PUT)	9-59
Simple data sharing API concepts	8-255	Beacon Trigger (DELETE)	9-64
Troubleshooting simple data sharing	8-256	Beacon Trigger (GET)	9-67
Simple data sharing limitations and special considerations	8-256	Beacon Triggers (GET)	9-69
Authenticators and login modules	8-257	Beacon Triggers (POST)	9-71
Mobile device authentication	8-257	Beacon Triggers (PUT)	9-76
The authentication configuration file	8-260	Beacons (DELETE)	9-80
Configuring authenticators and realms	8-262	Beacons (GET)	9-83
Implementing basic authenticators	8-263	Beacons (PUT)	9-86
Implementing form-based authenticators	8-265	Device Application Status (PUT)	9-90
Implementing custom authenticators	8-269	Device (DELETE)	9-94
Header authenticator	8-274	Device Status (PUT)	9-97
Persistent cookie authenticator	8-274	Devices (GET)	9-100
Implementing adapter-based authenticators	8-274	Event Source (GET)	9-104
LTPA authenticator	8-281	Event Sources (GET)	9-105
Configuring login modules	8-282	Farm topology members (GET)	9-107
Non-validating login module	8-283	Farm topology members (DELETE)	9-109
Single identity login module	8-284	GCM Credentials (DELETE)	9-111
Header login module	8-284	GCM Credentials (GET)	9-113
WASLTPAModule login module	8-285	GCM Credentials (PUT)	9-114
LDAP login module	8-285	Mediator (GET)	9-117
Configuring device auto provisioning	8-288	Mediators (GET)	9-118
Configuring and implementing custom device provisioning	8-289	MPNS Credentials (DELETE)	9-120
Device single sign-on (SSO)	8-294	MPNS Credentials (GET)	9-122
Configuring device single sign-on	8-295	MPNS Credentials (PUT)	9-124
Developing accessible applications	8-300	Push Device Registration (DELETE)	9-126
Client-side log capture	8-300	Push Device Registration (GET)	9-128
Server preparation for uploaded log data	8-304	Push Device Subscription (DELETE)	9-130
Client-side log capture configuration from MobileFirst Operations Console	8-305	Push Device Subscription (GET)	9-132
MobileFirst Filtered Export	8-306	Push Devices Registration (GET)	9-134
		Push Enabled Applications (GET)	9-136
		Push Tags (DELETE)	9-138
		Push Tags (GET)	9-140
		Push Tags (POST)	9-142
		Push Tags (PUT)	9-144
		Runtime (DELETE)	9-146
		Runtime (GET)	9-147
		Runtime Lock (DELETE)	9-155
		Runtime Lock (GET)	9-156
		Runtimes (GET)	9-158
		Send Bulk Messages (POST)	9-160
		Send Message (POST)	9-165
		Transaction (GET)	9-170
		Transactions (GET)	9-172
		Unsubscribe SMS (POST)	9-175
		WNS Credentials (DELETE)	9-177
		WNS Credentials (GET)	9-179
		WNS Credentials (PUT)	9-181
		MobileFirst Cloudant API reference	9-183
		Objective-C API for MobileFirst Cloudant extensions	9-183
API reference	9-1		
MobileFirst client-side API	9-1	Deploying MobileFirst projects	10-1
Objective-C client-side API for iOS apps	9-2	Deploying MobileFirst applications to test and production environments	10-1
MobileFirst server-side API	9-2	Deploying an application from development to a test or production environment	10-1
JavaScript server-side API	9-3	Building a project WAR file with Ant	10-4
Java server-side API	9-4	Deploying the project WAR file	10-5
MobileFirst OAuth TAI API	9-4	Configuration of MobileFirst applications on the server	10-48
REST Services API	9-4		
Adapter Binary (GET, HEAD)	9-4		
Adapter (DELETE)	9-5		
Adapter (GET)	9-8		
Adapter (POST)	9-12		
Adapters (GET)	9-15		
Adobe Air Application Binary (GET)	9-19		
APNS Credentials (DELETE)	9-21		
APNS Credentials (GET)	9-23		
APNS Credentials (PUT)	9-24		
App Version Access Rule (PUT)	9-27		
App Version (DELETE)	9-31		
App Version Lock (PUT)	9-35		
Application Binary (GET, HEAD)	9-37		
Application (DELETE)	9-38		
Application (GET)	9-41		
Application (POST)	9-45		
Applications (GET)	9-49		
Associate beacons and triggers (DELETE)	9-53		
Associate beacons and triggers (GET)	9-57		

Ant tasks for building and deploying applications and adapters	10-69
Deploying applications and adapters to MobileFirst Server	10-76
Administering adapters and apps in MobileFirst Operations Console	10-77
MobileFirst security overview	10-79
High availability.	10-95
Updating MobileFirst apps in production	10-97

Administering MobileFirst applications. 11-1

Administering MobileFirst applications with MobileFirst Operations Console	11-2
Locking an application	11-3
Remotely disabling application connectivity	11-3
Displaying a notification message on application startup	11-5
Defining administrator messages from MobileFirst Operations Console in multiple languages	11-5
Error log of operations on runtime environments	11-8
Audit log of administration operations.	11-9
Administering MobileFirst applications through Ant	11-11
Calling the wladm Ant task	11-12
Commands for adapters	11-15
Commands for apps	11-18
Commands for beacons	11-23
Commands for devices	11-29
Commands for troubleshooting.	11-32
A complex example of a wladm Ant task	11-35
Administering MobileFirst applications through the command line	11-36
Calling the wladm program	11-37
Commands for adapters	11-42
Commands for apps	11-44
Commands for beacons	11-50
Commands for devices	11-57
Commands for troubleshooting.	11-59
Administering push notifications with the MobileFirst Operations Console.	11-63
Application Center	11-65
Concept of the Application Center.	11-65
Specific platform requirements	11-66
General architecture	11-66
Preliminary information	11-68
Preparations for using the mobile client	11-69
Push notifications of application updates	11-72
The Application Center console.	11-76
Command-line tool for uploading or deleting an application	11-99
The mobile client	11-105
Federal standards support in IBM MobileFirst Platform Foundation for iOS	11-123
FDCC and USGCB support.	11-123
FIPS 140-2 support	11-124

Monitoring and mobile operations 12-1

Logging and monitoring mechanisms	12-1
Vitality queries for checking server health	12-2
Setting logging and tracing for Application Center on the application server	12-4
Analytics	12-6
Comparison of operational analytics and reports features	12-7
Operational analytics	12-8
Reports database	12-74
Mobile application management	12-95
User to device mapping and control	12-96
Device access management in the MobileFirst Operations Console.	12-96
Enabling the device access management features.	12-98
Performance implications for the server	12-99
User certificate authentication	12-100
User certificate authentication overview	12-100
User certificate authentication on the server	12-102
User certificate authentication on the client	12-112
Troubleshooting the User Certificate Authentication feature	12-114
License tracking	12-115
Configuring your license tracking details	12-115
License Tracking report	12-116
Integration with IBM License Metric Tool	12-117

Integrating with other IBM products 13-1

Introduction to MobileFirst integration capabilities	13-1
Integration with Cast Iron	13-2
Integration and authentication with a reverse proxy.	13-3
Integration with IBM Endpoint Manager	13-5
IBM Endpoint Manager for Mobile Devices	13-5
End-point management with IBM Endpoint Manager.	13-7
Integration with IBM Tealeaf	13-8
IBM Tealeaf client-side integration	13-8
IBM Tealeaf server-side integration	13-9
Integration with IBM Trusteer	13-9
Integrating IBM Trusteer for iOS.	13-9
Using WebSphere DataPower as a push notification proxy	13-10
More about integration	13-11

Reference 14-1

Ant configuredatabase task reference	14-1
Customizing the database connection with JDBC properties	14-8
Encrypting database password with Ant tasks for Liberty	14-9
Ant tasks for installation of MobileFirst Operations Console and Administration Services .	14-10
Ant tasks for installation of MobileFirst runtime environments.	14-16
Ant tasks for installation of MobileFirst Data Proxy	14-27
Internal runtime database tables	14-32
Sample configuration files	14-35

Glossary	15-1
A	15-1
B	15-2
C	15-2
D	15-4
E	15-4
F	15-4
G	15-5
H	15-5
I	15-5
J	15-5
K	15-6
L	15-6
M	15-7
N	15-7
O	15-8
P	15-8

R	15-9
S	15-9
T	15-10
U	15-11
V	15-11
W	15-11
X	15-11

Support and comments. 16-1

Notices A-1

Trademarks	A-3
Terms and conditions for product documentation	A-3
IBM Online Privacy Statement	A-4

Index X-1

IBM MobileFirst Platform Foundation for iOS V7.0.0 documentation

Welcome to the IBM MobileFirst™ Platform Foundation for iOS V7.0.0 documentation, where you can find information about how to install, maintain, and use the IBM MobileFirst Platform Foundation for iOS.

Getting started

Product overview

Product legal notices

Release notes

Tutorials, samples, and additional resources

Installation overview

Configuring MobileFirst Server

System requirements

Common tasks

Developing MobileFirst applications

Deploying MobileFirst projects

Administering MobileFirst applications

Using the Application Center

Troubleshooting and support

Troubleshooting

Known issues

 [IBM Software Support home page](#)

More information

 [PDF file for this documentation](#)

 [Mobile Application Developer skills](#)

 [IBM MobileFirst Platform blogs](#)

 [developerWorks blogs and articles](#)

 [IBM Redbooks](#)

Product overview

IBM MobileFirst Platform Foundation for iOS is an integrated platform that helps you extend your business to mobile devices.

IBM MobileFirst Platform Foundation for iOS includes a comprehensive development environment, mobile-optimized runtime middleware, a private enterprise application store, and an integrated management and analytics console, all supported by various security mechanisms.

With IBM MobileFirst Platform Foundation for iOS, your organization can efficiently develop, connect, run, and manage rich mobile applications (apps) that can access the full capabilities of your target mobile devices. IBM MobileFirst Platform Foundation for iOS can help reduce time-to-market, cost, and complexity of development, and enables an optimized customer and employee user experience across multiple environments.

As part of this comprehensive mobile solution, IBM MobileFirst Platform Foundation for iOS can be integrated with application lifecycle, security, management, and analytics capabilities to help you address the unique mobile needs of your business.

Introduction to mobile application development

With IBM MobileFirst Platform Foundation for iOS, you can develop mobile applications by using native development.

IBM MobileFirst Platform Foundation for iOS provides capabilities to help you respond to the fast-paced development of mobile devices.

Pure native development

With the pure native development approach, you can create applications that are written for a specific platform and run on that platform only. Your applications achieve great performance and can fully leverage all platform functions such as accessing the camera or contact list, enabling gestures, or interacting with other applications on the device.

Product main capabilities

With IBM MobileFirst Platform Foundation for iOS, you can use capabilities such as development, testing, back-end connections, push notifications, offline mode, update, security, analytics, monitoring, and application publishing.

Development

IBM MobileFirst Platform Foundation for iOS provides a framework that enables the development, integration, and management of secure mobile applications (apps). IBM MobileFirst Platform Foundation for iOS does not introduce a proprietary programming language or model that users must learn.

You can write native code (Objective-C and Swift). IBM MobileFirst Platform Foundation for iOS provides an SDK that includes libraries that you can access from native code.

Back-end connections

Some mobile applications run strictly offline with no connection to a back-end system, but most mobile applications connect to existing enterprise services to provide the critical user-related functions. For example, customers can use a mobile application to shop anywhere, at any time, independent of the operating hours of the store. Their orders must still be processed by using the existing e-commerce platform of the store. To integrate a mobile application with enterprise services, you must use middleware such as a mobile gateway. IBM MobileFirst Platform Foundation for iOS can act as this middleware solution and make communication with back-end services easier.

Push notifications

With push notifications, enterprise applications can send information to mobile devices, even when the application is not being used. IBM MobileFirst Platform Foundation for iOS includes a unified notification framework that provides a consistent mechanism for such push notifications.

Offline mode

In terms of connectivity, mobile applications can operate offline, online, or in a mixed mode. IBM MobileFirst Platform Foundation for iOS uses a client/server architecture that can detect whether a device has network connectivity, and the quality of the connection. Acting as a client, mobile applications periodically attempt to connect to the server and to assess the strength of the connection. An offline-enabled mobile application can be used when a mobile device lacks connectivity but some functions can be limited. When you create an offline-enabled mobile application, it is useful to store information about the mobile device that can help preserve its functionality in offline mode. This information typically comes from a back-end system, and you must consider data synchronization with the back end as part of the application architecture. IBM MobileFirst Platform Foundation for iOS includes a feature that is called JSONStore for data exchange and storage. With this feature, you can create, read, update, and delete data records from a data source. Each operation is queued when operating offline. When a connection is available, the operation is transferred to the server and each operation is then performed against the source data.

Update

IBM MobileFirst Platform Foundation for iOS simplifies version management and mobile application compatibility. Whenever a user starts a mobile application, the application communicates with a server. By using this server, IBM MobileFirst Platform Foundation for iOS can determine whether a newer version of the application is available, and if so, give information to the user about it. The server can also force an upgrade to the latest version of an application to prevent continued use of an outdated version.

Security

Protecting confidential and private information is critical for all applications within an enterprise, including mobile applications. Mobile security applies at various

levels, such as mobile application, mobile application services, or back-end service. You must ensure customer privacy and protect confidential data from being accessed by unauthorized users. Dealing with privately owned mobile devices means giving up control on certain lower levels of security, such as the mobile operating system.

IBM MobileFirst Platform Foundation for iOS provides secure, end-to-end communication by positioning a server that oversees the flow of data between the mobile application and your back-end systems. With IBM MobileFirst Platform Foundation for iOS, you can define custom security handlers for any access to this flow of data. Because any access to data of a mobile application has to go through this server instance, you can define different security handlers for mobile applications, web applications, and back-end access. With this kind of granular security, you can define separate levels of authentication for different functions of your mobile application. You can also prevent mobile applications from accessing sensitive information.

Analytics

The operational analytics feature enables searching across apps, services, devices, and other sources to collect data about usage, or to detect problems.

In addition to reports that summarize app activity, IBM MobileFirst Platform Foundation for iOS includes a scalable operational analytics platform accessible in the MobileFirst Operations Console. The analytics feature enables enterprises to search across logs and events that are collected from devices, apps, and servers for patterns, problems, and platform usage statistics. You can enable analytics, reports, or both, depending on your needs.

Monitoring

IBM MobileFirst Platform Foundation for iOS includes a range of operational analytics and reporting mechanisms for collecting, viewing, and analyzing data from your IBM MobileFirst Platform Foundation for iOS applications and servers, and for monitoring server health.

Application publishing

IBM MobileFirst Platform Foundation for iOS Application Center is an enterprise application store. With the Application Center, you can install, configure, and administer a repository of mobile applications for use by individuals and groups across your enterprise. You can control who in your organization can access the Application Center and upload applications to the Application Center repository, and who can download and install these applications onto a mobile device. You can also use the Application Center to collect feedback from users and access information about devices on which applications are installed.

The concept of the Application Center is similar to the concept of the Apple public App Store , except that it targets the development process.

The Application Center provides a repository for storing the mobile application files and a web-based console for managing that repository. The Application Center also provides a mobile client application to allow users to browse the catalog of applications that are stored by the Application Center, install applications, leave feedback for the development team, and expose production applications to IBM® Endpoint Manager. Access to download and install applications from the

Application Center is controlled by using access control lists (ACLs).

Product components

IBM MobileFirst Platform Foundation for iOS consists of the following components: MobileFirst Platform Command Line Interface for iOS, MobileFirst Server, client-side runtime components, MobileFirst Operations Console, MobileFirst Platform Cloudant® Local, and Application Center.

Component overview

The following figure shows the components of IBM MobileFirst Platform Foundation for iOS:

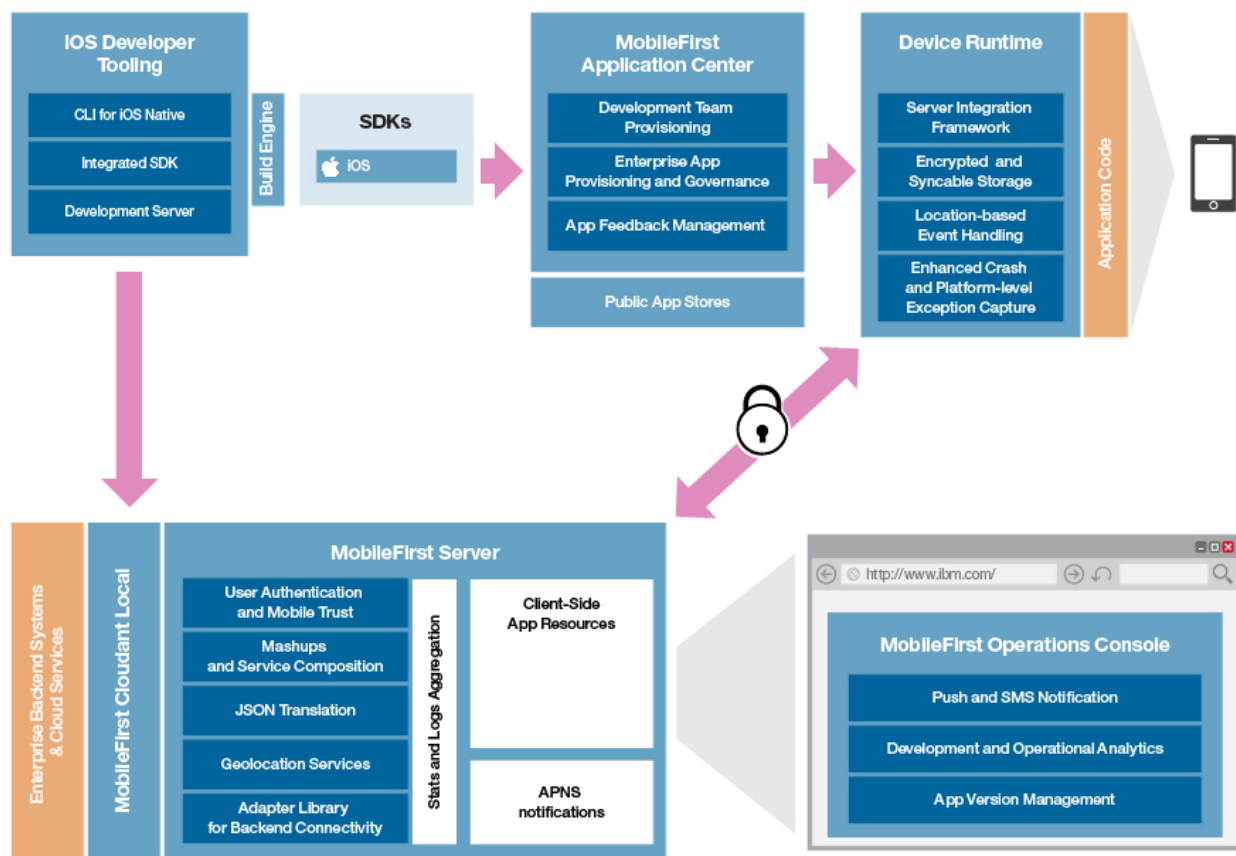

Figure 2-1. IBM MobileFirst Platform Foundation for iOS architecture

MobileFirst Server

The MobileFirst Server is a runtime container for the mobile applications you develop by using MobileFirst tooling. It is not an application server in the Java™ Platform, Enterprise Edition (Java EE) sense. It acts as a container for IBM MobileFirst Platform Foundation for iOS application packages, and is in fact a collection of web applications, optionally packaged as an EAR (enterprise archive) file that run on top of traditional application servers.

MobileFirst Server integrates into your enterprise environment and uses existing resources and infrastructure. This integration is based on adapters that are server-side software components responsible for channeling back-end enterprise systems and cloud-based services to the user device. You can use adapters to retrieve and update data from information sources, and to allow users to perform transactions and start other services and applications.

You can use MobileFirst Server for the following tasks:

- Empower hundreds of thousands of users with transactional capabilities and enable their direct access to back-end systems and cloud-based services.
- Configure, test, and deploy descriptive XML files to connect to various back-end systems by using standard MobileFirst tools.
- Automatically convert hierarchical data to JSON format for optimal delivery and consumption.
- Enhance user interaction with a uniform push notification architecture.
- Define complex mashups of multiple data sources to reduce overall traffic.
- Integrate with the existing security and authentication mechanisms of your organization.

MobileFirst Platform Cloudant Local

MobileFirst Platform Cloudant Local is an advanced NoSQL database that is capable of handling a wide variety of data types, such as JSON, full-text, and geospatial data.

As a JSON document store, MobileFirst Platform Cloudant Local is ideal for managing multi-structured or unstructured data. With advanced indexing, you can enrich applications with location-based, geospatial services, full-text search, and real-time analytics.

MobileFirst Cloudant extensions include an SDK and proxy.

The SDK extends the Cloudant APIs with support for native language objects for iOS developers, offline access, and online remote access. For more information, see “Storing mobile data in Cloudant” on page 8-186.

Authentication with OAuth is available through integration with the MobileFirst Data Proxy. For more information, see “Installing the MobileFirst Data Proxy” on page 6-152.

Client-side runtime components

IBM MobileFirst Platform Foundation for iOS provides client-side runtime code that embeds server functionality within the target environment of deployed apps. These runtime client APIs are libraries that are integrated into the locally stored app code. They complement MobileFirst Server by defining a predefined interface for apps to access native device functions.

The client-side runtime components provide the following functions:

- Mobile data integration: connectivity and authentication APIs
- Security features: on-device encryption, offline authentication, and remote disablement of the ability to connect to MobileFirst Server
- Mobile client functionality: access to device APIs and push notification registration

MobileFirst Operations Console

The MobileFirst Operations Console is used for the control and management of the mobile applications.

You can use the MobileFirst Operations Console for the following tasks:

- Monitor all deployed applications, adapters, and push notification rules from a centralized, web-based console.
- Assign device-specific identifiers (IDs) to ensure secure application provisioning.
- Remotely disable the ability to connect to MobileFirst Server by using preconfigured rules of app version and device type.
- Customize messages that are sent to users on application launch.
- Collect user statistics from all running applications.
- Generate built-in, pre-configured reports about user adoption and usage (number and frequency of users that are engaging with the server through the applications).
- Configure data collection rules for application-specific events.
- Export raw reporting data to be analyzed by the business intelligence systems of your organization.

IBM MobileFirst Platform Operational Analytics

IBM MobileFirst Platform Foundation for iOS includes a scalable operational analytics feature that is accessible from the MobileFirst Operations Console. The analytics feature enables enterprises to search across logs and events that are collected from devices, apps, and servers for patterns, problems, and platform usage statistics.

The data for operational analytics includes the following sources:

- Crash events of an application on iOS devices (crash events for native code errors).
- Interactions of any application-to-server activity (anything that is supported by the MobileFirst client/server protocol, including push notification).
- Server-side logs that are captured in traditional MobileFirst log files.

Application Center

With the Application Center, you can share mobile applications that are under development within your organization in a single repository of mobile applications. Development team members can use the Application Center to share applications with members of the team. This process facilitates collaboration between all the people who are involved in the development of an application.

Your company can typically use the Application Center as follows:

1. The development team creates a version of an application.
2. The development team uploads the application to the Application Center, enters its description, and asks the extended team to review and test it.
3. When the new version of the application is available, a tester runs the Application Center installer application, which is the mobile client. Then, the tester locates this new version of the application, installs it on their mobile device, and tests it.

4. After the tests, the tester rates the application and submits feedback, which is visible to the developer from the Application Center console.

The Application Center is aimed for private use within a company, and you can target some mobile applications to specific groups of users. You can use the Application Center as an enterprise application store.

MobileFirst Platform Command Line Interface for iOS

To help you get a better tools experience, IBM MobileFirst Platform Foundation for iOS provides a command-line interface (CLI) tool to easily create and manage apps. The CLI lets you use your preferred text editors or alternative IDEs to create mobile applications.

The commands support tasks such as creating, adding, and configuring with the API library, adding the client-side properties file and performing the build and deploy of the application. From the command-line, you can create and deploy adapters, and test them locally. You can administer your project from CLI or REST services, or the Console, where you can control the local server and observe the logs.

Product editions

IBM MobileFirst Platform Foundation for iOS is available in one edition.

This edition contains the following components:

- IBM MobileFirst Platform Command Line Interface for iOS, which is available as an installable download.
- IBM MobileFirst Platform Server component, which is available as an IBM Installation Manager package.

System requirements

System requirements for IBM MobileFirst Platform Foundation for iOS include operating systems, SDKs, and other software.

IBM MobileFirst Platform Foundation for iOS has a number of system requirements that must be met for you to install and configure the product successfully. The system requirements include the following items:

- Operating systems that support IBM MobileFirst Platform Foundation for iOS, including mobile device operating systems
- Required hardware configuration
- Supported software development kits (SDKs)
- Application servers, database management systems, and other software that are required or supported by IBM MobileFirst Platform Foundation for iOS

System requirements by type (high-level)

The requirements in the following links are organized by high-level categories:

- Operating systems
- Software
- Hardware

System requirements by platform (detail)

The requirements in the following links are organized by installation target platform:

- AIX®
- Linux
- Mac OS
- Mobile OS
- Solaris
- Windows

System requirements by component (detail)

The requirements in the following links are organized by product component:

- IBM MobileFirst Platform Application Center
- IBM MobileFirst Platform Cloudant Data Layer Local Edition
- IBM MobileFirst Platform Foundation Application Patterns
- IBM MobileFirst Platform Operational Analytics
- IBM MobileFirst Platform Server
- IBM MobileFirst Platform Command Line Interface for iOS
- IBM MobileFirst Platform Studio
- IBM MobileFirst Platform Test Workbench
- IBM MobileFirst Platform Device Runtime

Matrix of features and platforms

IBM MobileFirst Platform Foundation for iOS provides many features and supports many platforms.

The Mobile OS feature mapping for IBM MobileFirst Platform Foundation for iOS technote on the IBM Support Portal lists the features that are available on each of the platforms that IBM MobileFirst Platform Foundation for iOS supports.

Consider compatibility with prior releases before you decide what version of each product component to install. For more information, see “Version compatibility” on page 7-1.

Release notes

You can identify the latest information about this product release and all its fix packs.

What's new

Discover the new features and changes in IBM MobileFirst Platform Foundation for iOS V7.0.0 compared to the previous version of this product.

Efficient and scalable app data storage

Store your app data with a simplified programming model that supports offline access, scalable storage, and enterprise integration. Choose to store your data on premises or in the cloud.

IBM MobileFirst Platform Cloudant Data Layer Local Edition overview

The IBM MobileFirst Platform Cloudant Data Layer Local Edition, powered by Cloudant Local, provides an advanced NoSQL database with easy-to-use administration and management capabilities, rich developer support, and powerful mobile and web capabilities.

As a JSON document store, Cloudant Local is ideal for managing multi-structured or unstructured data. With indexing, you can enrich applications with location-based, geospatial services, full-text search, and real-time analytics.

Native APIs

The MobileFirst Cloudant extensions extend the Cloudant Local APIs with support for native language objects for iOS developers, offline access, and online remote access.

For more information about the APIs, see “Storing mobile data in Cloudant” on page 8-186.

Security

OAuth authentication is available through integration with the MobileFirst Data Proxy. For more information, see “Installing the MobileFirst Data Proxy” on page 6-152.

Licensing options

Single node license

A single node license is included with MobileFirst Platform Cloudant Local. This single node enables development and test with full API support and tools. This license can be used for production with appropriate planning for availability, performance, and backup.

IBM Cloudant Data Layer Local Edition V1.0

Upgrade to Cloudant Data Layer Local Edition to support clustered nodes and gain horizontal and geographic scalability, fault tolerance, and

continuous availability. Cloudant Data Layer Local Edition is designed with applications in mind that require the availability, elasticity, and reach of possibly massive amounts of mobile data and devices. It is best suited for apps that require an operational data store to handle a massively concurrent mix of low-latency reads and writes.

Off premises

If you do not want to manage local installations, you can use off-premises options, including the Cloudant.com database instance or the Cloudant NoSQL DB service on IBM Bluemix®. Both services have separate charging and licensing.

JSONStore and Cloudant comparison

Use the Cloudant Toolkit when you are storing data on a device that needs to be synchronized to a Cloudant database. The Cloudant Toolkit provides the most efficient means for synchronizing data to and from a Cloudant database. The Cloudant Toolkit is available for native mobile applications for iOS in Swift or Objective-C.

You can also access Cloudant data through the Cloudant REST APIs by configuring a MobileFirst HTTP adapter. With this approach, you can synchronize data from a Cloudant database to an encrypted JSONStore database on the device. However, you add the performance expense of introducing the adapter layer in the middle.

You might consider using JSONStore instead of Cloudant in the following scenarios:

- When you are storing data on the mobile device that needs to be encrypted. JSONStore can also be enabled for FIPS 140-2 encryption.
- When you need to synchronize data between the device and the enterprise. JSONStore can be connected to the MobileFirst adapter layer to synchronize data to or from an enterprise source.

For more information about JSONStore, see “JSONStore” on page 8-161.

Standards-based integration and authentication

New features enable app developers with back end domain-specific knowledge to securely integrate a mobile app with any enterprise system by using industry standard technologies such as REST and OAuth.

Authentication and SSO using standard-based authentication (OAuth)

Prior to V7.0.0, MobileFirst security was based entirely on a proprietary model. Starting with V7.0.0, a new security model has been added to support the standard OAuth 2.0 specification.

To support backward compatibility, the classic (pre-V7.0.0) security model can be used in the flows that are based on the existing MobileFirst APIs (for example, invokeProcedure) in Java. MobileFirst V7.0.0 provides seamless integration between the two security models. The platform allows you to combine classic and new APIs in the same application, while keeping a consistent security context on the server side.

In addition, the protected resources can report analytic events to IBM MobileFirst Platform Operational Analytics such as authentication successes and failures.

For more information, see “OAuth-based security model” on page 8-221.

With the new security model, you can enforce MobileFirst security on external resources written in Java, Node.js, or any other language. For more information, see “Protecting external resources” on page 8-230.

Adapters

Starting with V7.0.0, the following new adapter features were introduced to IBM MobileFirst Platform Foundation for iOS:

Java adapters

Java adapters are based on the JAX-RS specification and expose a full REST API to the client. For more information, see “MobileFirst Java adapters” on page 8-85.

RESTful access to JavaScript adapters

It is possible to call existing JavaScript adapter procedures over HTTP via REST URLs from the /adapters endpoint. For more information, see “RESTful access to JavaScript adapters” on page 8-159.

Service discovery for IBM BPM

You can now use IBM MobileFirst Platform Foundation for iOS V7.0.0 to discover IBM BPM back-end services.

Service discovery with REST

You can describe a RESTful resource to access your back-end service. You can describe URL segments that are dynamic parameters to generate MobileFirst adapters.

SAP JCo adapters

Starting with V7.0.0, you can use the SAP Java Connector (SAP JCo) adapters to develop SAP-compatible components and applications in Java. For more information, see “SAP JCo adapters” on page 8-147.

CLI commands

Starting with V7.0.0, there are new CLI commands.

- The **adapter call** command: call an adapter's procedure on the MobileFirst Server. For more information, see adapter call.
- The **adapter add** and **add adapter** commands: both create a new adapter. For more information, see “Commands” on page 8-16.

Core value features

IBM MobileFirst Platform Foundation for iOS enables enterprise application developers to use the latest supported mobile OS software and tools, strengthens the security of apps against hacking and tampering and makes reverse engineering more difficult, and provides an enhanced and more efficient user experience of operations and deployment.

Mobile operating system currency

Upgraded version of Liberty

IBM MobileFirst Platform Foundation for iOS V7.0.0 uses an upgraded version of Liberty. With V7.0.0, Liberty 8.5.5.4 is bundled with MobileFirst Platform Command Line Interface for iOS.

Versions of Apache Cordova components

The version of Apache Cordova included in IBM MobileFirst Platform Foundation for iOS V7.0.0 is composed of the following components:

Platforms

- cordova-android: 3.6.4
- cordova-blackberry10: 3.6.3
- cordova-ios: 3.7.0
- cordova-windows: 3.7.1
- cordova-wp8: 3.7.0

Plugins

- org.apache.cordova.battery-status: 0.2.12
- org.apache.cordova.camera: 0.3.4
- org.apache.cordova.console: 0.2.12
- org.apache.cordova.contacts: 0.2.15
- org.apache.cordova.device-motion: 0.2.11
- org.apache.cordova.device-orientation: 0.3.10
- org.apache.cordova.device: 0.2.13
- org.apache.cordova.dialogs: 0.2.11
- org.apache.cordova.file: 1.3.2
- org.apache.cordova.file-transfer: 0.4.8
- org.apache.cordova.geolocation: 0.3.11
- org.apache.cordova.globalization: 0.3.3
- org.apache.cordova.inappbrowser: 0.5.4
- org.apache.cordova.media-capture: 0.3.5
- org.apache.cordova.media: 0.2.15
- org.apache.cordova.network-information: 0.2.14
- org.apache.cordova.splashscreen: 0.3.5
- org.apache.cordova.statusbar: 0.1.9
- org.apache.cordova.vibration: 0.3.12

Secure integration and app security

Continuous delivery (operations and deployment)

New design of MobileFirst Operations Console

The redesigned MobileFirst Operations Console provides an enhanced user experience, is compatible with tablets, and is accessible. For examples of the new design and to follow enhanced interactions with MobileFirst Operations Console, see, for example:

- “Administering push notifications with the MobileFirst Operations Console” on page 11-63
- “Device access management in the MobileFirst Operations Console” on page 12-96

- “Error log of operations on runtime environments” on page 11-8

Scalable deployment of MobileFirst applications by using a server farm

IBM MobileFirst Platform Foundation for iOS now offers an easy way to deploy applications by replicating management operations to all instances of a runtime configured in a server farm. You can automatically add or remove servers to scale the capacity of the farm up or down. This capability is available on WebSphere® Application Server Liberty profile, WebSphere Application Server full profile, and Apache Tomcat.

For more information about this topology, see “Installing a server farm” on page 6-97.

Miscellaneous improvements

Application Center: self-signed CA certificates

You can use self-signed certificate authority (CA) certificates in test environments, when the administrator might not have a real Secure Sockets Layer (SSL) certificate available, to install applications with Application Center on a mobile device from a secured server. Such certificates work if they get installed on the device as root certificate. For more information, see “Managing and installing self-signed CA certificates in an Application Center test environment” on page 6-221.

New debug option for CLI

Starting with V7.0.0, you can use the new debug option to produce verbose log output. For more information, see “CLI commands usage” on page 8-16.

Database password encryption for WebSphere Application Server Liberty profile

Starting with V7.0.0, the Ant tasks, the server installer, and the Server Configuration Tool encrypt database passwords by default for WebSphere Application Server Liberty profile. For more information, see “Encrypting database password with Ant tasks for Liberty” on page 14-9.

New internal database tables

The following database tables are new in V7.0.0:

CLIENT_INSTANCES

Stores instances of client applications that have registered with the OAuth server.

FARM_CONFIG

Stores the configuration of farm nodes if a server farm is used.

For more information, see “Internal runtime database tables” on page 14-32.

Improved MobileFirst API

New features improve and extend the APIs that you can use to develop mobile applications.

Updated Objective-C client-side API for iOS

IBM MobileFirst Platform Foundation for iOS V7.0.0 includes updates in its Objective-C client-side API to develop native apps on iOS, as follows:

New API classes:

WLAuthorizationManager

The WLAuthorizationManager class manages the entire OAuth flow, from client registration to token generation.

For more information, see the WLAuthorizationManager class.

WLResourceRequest

The WLResourceRequest class encapsulates a resource request and provides several send methods with different inputs for the body of a request.

WLResourceRequest can also be used to access the Java adapters with a relative URL.

For more information, see the WLResourceRequest class.

Updated API classes:

WLResponse

The WLResponse class now provides access to the server JSON response through a property. The getResponseJson method is deprecated.

For more information, see the WLResponse class.

WLCClient

The HTTPCookieStorage method has been added to enhance cookie management.

MobileFirst Cloudant extensions APIs

You can store data for your mobile application in a Cloudant database, which is an advanced NoSQL database that is capable of handling a wide variety of data types, such as JSON, full-text, and geospatial data. The SDK is available for Objective-C.

For more information about the Objective-C APIs, see “MobileFirst Cloudant API reference” on page 9-183.

Tutorials and samples

New and updated tutorials, and their associated sample files, are available, on the Developer Center web site.

For more information, see the Mobile First Platform Developer Center web site.

What's new in V7.0.0 interim fixes

Interim fixes provide patches and updates to correct problems and keep IBM MobileFirst Platform Foundation for iOS current for new releases of mobile operating systems.

Interim fixes are cumulative. When you download the latest V7.0.0 interim fix, you get all of the fixes from earlier interim fixes.

Download and install the latest interim fix to obtain all of the fixes that are described in the following sections. If you install earlier fixes, you might not get all of the fixes described here.

iOS 9 support

If you use Xcode 7 to compile your apps, or if you use extended authenticity protection for your apps, install the latest interim fix and review the following sections to ensure that your apps continue to work on iOS 9.

If you build your apps with Xcode 6.4 and do not use extended authenticity protection, you can rebuild your apps with iOS 9 support without installing the latest IBM MobileFirst Platform Foundation for iOS interim fix.

Extended authenticity checking for apps that undergo app thinning

App thinning was introduced by Apple in iOS 9 for apps that are compiled with Xcode 7. App thinning reduces the size of files that are downloaded from the App Store. The feature might affect the extended authenticity features of IBM MobileFirst Platform Foundation for iOS apps because the binary file in the App Store might differ from the one that is downloaded to the client device.

After you apply latest interim fix, the app thinning feature is available for any app that uses iOS 9 and later and Xcode 7 and later and that was created by using IBM MobileFirst Platform Foundation for iOS V7.0.0 and later.

For more information, see “Enabling extended authenticity checking for apps that undergo app thinning” on page 10-52.

Disabling bitcode-enabled Xcode builds

Starting with Xcode 7, bitcode is a default, but optional option for iOS apps. The bitcode option is not currently supported in IBM MobileFirst Platform Foundation for iOS. To use the MobileFirst SDK in any project that uses Xcode 7, you must disable bitcode.

Applications that are based on Apple watchOS 2 require the bitcode to be enabled and are currently not supported in IBM MobileFirst Platform Foundation for iOS.

For more information, see “Disabling bitcode in Xcode builds” on page 8-14.

Support for dynamic .tbd libraries in Xcode 7

Xcode 7 replaces dynamic .dylib libraries with more lightweight .tbd files. Up to now, IBM MobileFirst Platform Foundation for iOS projects link with .dylib libraries such as: libc++.dylib, libstdc.dylib, and libz.dylib. These libraries must be replaced with the corresponding .tbd libraries.

For guidelines, see the following topics:

- “Copying files of iOS applications” on page 8-7
- Adding Mobilefirst web capabilities to an existing native app

Enforcing TLS-secure connections in iOS apps

Apple's App Transport Security (ATS) is a new feature of iOS 9 that enforces best practices for connections between the app and the server. By default, this feature enforces some connection requirements that improve security. These include

client-side HTTPS requests and server-side certificates and connection ciphers that conform to Transport Layer Security (TLS) version 1.2 using forward secrecy.

For **development purposes**, you can override the default behavior by specifying an exception in the `Info.plist` file in your app. However, in a full **production environment**, all iOS apps must enforce TLS-secure connections for them to work properly.

By applying the latest interim fix, the apps that you develop in IBM MobileFirst Platform Foundation for iOS V6.0.0 and later automatically turn off transport security to allow all non-secure connections to the IBM MobileFirst Platform Foundation for iOS development server.

For more information, see “Enforcing TLS-secure connections in iOS apps” on page 8-13.

Exporting and importing custom chart definitions for analytics

If you are using the latest interim fix of IBM MobileFirst Platform Foundation for iOS, you can export and import your custom chart definitions programmatically or in the IBM MobileFirst Platform Operational Analytics Console.

For more information, see “Exporting and importing custom chart definitions” on page 12-47.

Deprecated and removed features

If you are migrating from an earlier release of the product, be aware of the various features that have been deprecated or removed in this and earlier releases.

Deprecated features

Definition: Pertaining to an entity, such as a programming element or feature, that is supported but no longer recommended and that might become obsolete.

For a list of deprecated features, see “Deprecated features and API elements”

Removed features

Definition: Pertaining to a feature that is no longer included in a product.

For a list of removed features, see “Removed features” on page 3-9

Deprecated features and API elements

The following API elements are deprecated from this release.

Features deprecated in V7.0.0

Table 3-1. Features deprecated in V7.0.0.

Category	Deprecation	Recommended Action
Analytics Reports database	The Reports database, often referenced as WLREPORT in the documentation, is deprecated in IBM MobileFirst Platform Foundation for iOS V7.0.0.	Use IBM MobileFirst Platform Operational Analytics instead. Note that setting up the Reports database is optional in this release and prior releases. Also note that the use of the Reports database is redundant with MobileFirst Operational Analytics in this release and recent prior releases.
Analytics BIRT predefined reports	The predefined BIRT reports are deprecated.	Use IBM MobileFirst Platform Operational Analytics console and custom chart support instead.
The JAR files and JavaScript libraries that enable SSO between IBM MobileFirst Platform Foundation for iOS and other external services	The external-server-libraries directory and its contents are deprecated. The following API URLs are also deprecated: <application root context>/oauth/*	Use the MobileFirst OAuth-based security model instead. For more information about this model, see "OAuth-based security model" on page 8-221.

API elements deprecated in V7.0.0

Table 3-2. API elements deprecated in V7.0.0.

Category	Deprecation	Recommended Action
WLClient	[WLClient lastAccessToken]	Use [WLAAuthorizationManager cachedAuthorizationHeader] instead.
	[WLClient lastAccessTokenForScope]	Use [WLAAuthorizationManager cachedAuthorizationHeader] instead.
	[WLClient obtainAccessTokenForScope]	Use [WLAAuthorizationManager obtainAuthorizationHeaderForScope] instead.
WLResponse	[WLResponse getResponse]son]	Use the response]son property instead.

Removed features

The following features are removed from this and earlier releases of this product.

Features removed in V7.0.0

Table 3-3. Features removed in V7.0.0.

Feature
The JAR files and JavaScript libraries that enable SSO between IBM MobileFirst Platform Foundation for iOS and other external services are removed. Use the MobileFirst OAuth-based security model instead. For more information about the OAuth-based security model, see "OAuth-based security model" on page 8-221.
The "shake to refresh" feature is removed in IBM MobileFirst Platform Foundation for iOS V7.0.0.

Known issues

You can identify the latest known issues and their resolutions, for this product release and all its fix packs, by browsing this dynamic list of documents.

Click the following link to receive a dynamically generated list of documents for this specific release and all its fix packs, including known issues and their resolutions, and relevant downloads: <http://www.ibm.com/support/search.wss?tc=SSHSCD&atrn=SWVersion&atr=7.0>

The following websites provide helpful community resources:

- Developer Center for IBM MobileFirst Platform (Help page), where you can post questions to Stack Overflow website, and get answers, by using the following tags:
 - mobilefirst
 - worklight for past releases
- dW Answers website, where you can post questions and get answers, by using the following tags:
 - mobilefirst
 - worklight for past releases

Known limitations

General limitations apply to IBM MobileFirst Platform Foundation for iOS as detailed here. Limitations that apply to specific features are explained in the topics that describe these features.

In this documentation, you can find the description of IBM MobileFirst Platform Foundation for iOS known limitations in different locations:

- When the known limitation applies to a specific feature, you can find its description in the topic that explains this specific feature. You can then immediately identify how it affects the feature.
- When the known limitation is general, that is, applies to different and possibly not directly related topics, you can find its description here.

Note: For more information about product known limitations or issues, see "Known issues."

Globalization

If you are developing globalized apps, notice the following restrictions:

- Part of the product IBM MobileFirst Platform Foundation for iOS V7.0.0, including its documentation, is translated in the following languages: Simplified Chinese, Traditional Chinese, French, German, Italian, Japanese, Korean, Portuguese (Brazil), Russian, and Spanish. Only user-facing text is translated.
- The MobileFirst Platform Command Line Interface for iOS and MobileFirst Operations Console provide only partial support for bidirectional languages.
- The applications that are generated by IBM MobileFirst Platform Foundation for iOS are not fully bidirectional enabled. Mirroring of the graphic user interface (GUI) elements and the control of the text direction are not provided by default. However, there is no hard dependency from the generated applications on this limitation. It is possible for the developers to achieve full bidi compliance by manual adjustments in the generated code.
- Although translation into Hebrew is provided for IBM MobileFirst Platform Foundation for iOS core functionality, some GUI elements are not mirrored.
- In MobileFirst Platform Command Line Interface for iOS and MobileFirst Operations Console, dates and numbers might not be formatted according to the locale.
- Names of projects, apps, and adapters must be composed only of the following characters:
 - Uppercase and lowercase letters (A-Z and a-z)
 - Digits (0-9)
 - Underscore (_)
- There is no support for Unicode characters outside the Basic Multilingual Plane.

The Server Configuration Tool has the following restrictions:

- The descriptive name of a server configuration can contain only characters that are in the system character set. On Windows, it is the ANSI character set.
- Passwords that contain single quotation mark or double quotation mark characters might not work correctly.
- The console of the Server Configuration Tool has the same globalization limitation as the Windows console to display strings that are out of the default code page.

IBM MobileFirst Platform Operational Analytics has the following limitations in terms of globalization:

- Language sensitivity and Unicode Normalization Forms: The search function in Analytics Console does not consider language sensitivity such as normal matching, accent-insensitive, case-insensitive, and 1-to-2 mapping to run the search correctly in different languages. The search on data also does not use Normalization Form C (NFC).
- In Analytics Console, the format for dates and times do not follow the International Components for Unicode (ICU) rules.
- In Analytics Console, the format for numbers does not follow the International Components for Unicode (ICU) rules.
- In Analytics Console, the numbers do not use the user's preferred number script.
- When you create a custom filter for a custom chart, the numerical data must be in base 10, Western, or European numerals, such as 0, 1, 2, 3, 4, 5, 6, 7, 8, 9.

- The numbers that represent the page numbers in the pagination elements of the MobileFirst Operations Console are limited to Western or European numerals.
- The Analytics page of the MobileFirst Operations Console does not work in the following browsers:
 - Microsoft Internet Explorer version 8 or earlier
 - Apple Safari on iOS version 4.3 or earlier

You might also experience restrictions or anomalies in various aspects of globalization because of limitations in other products, such as browsers, database management systems, or software development kits in use. For example:

- You must define the user name and password of the Application Center with ASCII characters only. This limitation exists because IBM WebSphere Application Server (full or Liberty profiles) does not support non-ASCII passwords and user names. See Characters that are valid for user IDs and passwords.
- In Java 7.0 Service Refresh 4-FP2 and previous versions, you cannot paste Unicode characters that are not part of the Basic Multilingual Plane into the input field. To avoid this issue, create the path folder manually and choose that folder during the installation.
- Custom title and button names for the alert, confirm, and prompt methods must be kept short to avoid truncation at the edge of the screen.
- The applications that are developed with MobileFirst Application Framework running in Portuguese (Portugal) will see runtime messages in Portuguese (Brazil).
- JSONStore does not handle normalization. The Find functions for the JSONStore API do not take account of language sensitivity such as accent insensitive, case insensitive, and 1 to 2 mapping.
- The sorted results of JSONStore Find API are not language-specific and not compliant with Common Locale Data Repository (CLDR) rules.

Application authenticity

Extended application authenticity for iOS

Extended application-authenticity validation is not supported for iOS apps that are installed from the Apple app store. You can still use basic application-authenticity validation for such apps. For more information, see Note About Application Authenticity Failures in Applications Downloaded from the Apple App Store. For information about the different types of MobileFirst application-authenticity validations, see “MobileFirst application authenticity overview” on page 8-247.

Application Center mobile client

The Application Center mobile client follows the cultural conventions of the running device, such as the date formatting. It does not always follow the stricter International Components for Unicode (ICU) rules.

Application Center requires MobileFirst Studio for importing and building the IBMAppCenter project

MobileFirst Studio is not part of IBM MobileFirst Platform Foundation for iOS, but if you purchased this product, you are entitled to the full cross-platform version of the product as well. You can install MobileFirst Studio from the Eclipse Marketplace, or download the full MobileFirst Platform Command Line Interface

for iOS from IBM MobileFirst Developer Center to perform the build of the Application Center mobile client for iOS.

JSONStore resources for iPhone and iPad

When you develop apps for iPhone and iPad, the JSONStore resources are always packaged in the application, regardless of whether you enabled JSONStore or not in the application descriptor. The application size is not reduced even if JSONStore is not enabled.

Analytics page of the MobileFirst Operations Console

Response times in the Analytics page of the MobileFirst Operations Console depend on several factors, such as hardware (RAM, CPUs), quantity of accumulated analytics data, and IBM MobileFirst Platform Operational Analytics clustering. Consider testing your load before integrating IBM MobileFirst Platform Operational Analytics into production.

Installation on a cluster of IBM WebSphere Application Servers Liberty profile that you administer with a collective controller

The following limitations apply if you install MobileFirst Server on a cluster of IBM WebSphere Application Servers, Liberty profile, that you administer with a collective controller:

- The Application Center installation with the MobileFirst Server installer does not use the collective controller. You must install MobileFirst Server on each server separately.
- The MobileFirst Operations Console installation with the `<configureApplicationServer>` Ant task does not use the collective controller. You must run the `<configureApplicationServer>` Ant task for each server separately.

No white space with Eclipse workspace path

The MobileFirst Development Server (an instance of the WebSphere Application Server Liberty profile server) cannot handle an Eclipse workspace path with white space. As a result, a simple app cannot be deployed or previewed. In MobileFirst Operations Console, an error message is displayed:

Server error. Contact the server administrator.

In the log file, the following error messages are logged:

```
[12/11/14 10:27:57:376 IST]
0000002f m.ibm.ws.container.service.app.deploy.ManifestClassPathUtils W SRVE9967W:
The manifest class path jaxb-api.jar can not be found in jar file
wsjar:file:/home/administrator/.ibm/mobilefirst/6.3.0/server/wlp/usr/servers/
worklight/apps/worklightconsole.war!/
WEB-INF/lib/jaxb-impl-2.1.12.osgi.jar or its parent.
[12/11/14 10:27:57:376 IST]
0000002f m.ibm.ws.container.service.app.deploy.ManifestClassPathUtils W SRVE9967W:
The manifest class path activation.jar can not be found in jar file
wsjar:file:/home/administrator/.ibm/mobilefirst/6.3.0/server/wlp/usr/servers/
worklight/apps/worklightconsole.war!/
WEB-INF/lib/jaxb-impl-2.1.12.osgi.jar or its parent.
[12/11/14 10:27:57:376 IST]
0000002f m.ibm.ws.container.service.app.deploy.ManifestClassPathUtils W SRVE9967W:
The manifest class path jsr173_1.0_api.jar can not be found in jar file
wsjar:file:/home/administrator/.ibm/mobilefirst/6.3.0/server/wlp/usr/servers/
worklight/apps/worklightconsole.war!
```

```
/WEB-INF/lib/jaxb-impl-2.1.12.osgi.jar or its parent.  
[12/11/14 10:27:57:377 IST]  
0000002f m.ibm.ws.container.service.app.deploy.ManifestClassPathUtils W SRVE9967W:  
The manifest class path jaxb1-impl.jar can not be found in jar file  
wsjar:file:/home/administrator/.ibm/mobilefirst/6.3.0/server/wlp/usr/servers/  
worklight/apps/worklightconsole.war!  
/WEB-INF/lib/jaxb-impl-2.1.12.osgi.jar or its parent.  
[12/11/14 10:27:57:637 IST]  
00000029 com.ibm.ws.webcontainer.osgi.webapp.WebGroup I SRVE0169I:  
Loading Web Module: IBMJMXConnectorREST.
```

Do not use an Eclipse workspace path with white space.

Installation of a fix pack or interim fix to the Application Center or the MobileFirst Server

When you apply a fix pack or an interim fix to Application Center or MobileFirst Server, manual operations are required, and you might have to shut down your applications for some time. For more information, see “Upgrading to IBM MobileFirst Platform Foundation for iOS V7.0.0” on page 7-1 or “Upgrading to MobileFirst Server V7.0.0 in a production environment” on page 7-4.

FIPS 140-2 feature limitations

The following known limitations apply when you use the FIPS 140-2 feature in IBM MobileFirst Platform Foundation for iOS:

- This FIPS 140-2 validated mode applies only to the protection (encryption) of local data that is stored by the JSONStore feature and protection of HTTPS communications between the MobileFirst client and the MobileFirst Server.
 - For HTTPS communications, only the communications between the MobileFirst client and the MobileFirst Server use the FIPS 140-2 libraries on the client. Direct connections to other servers or services do not use the FIPS 140-2 libraries.
- On iOS, this feature is supported on **i386**, **armv7**, and **armv7s** architectures. FIPS is not yet supported on 64-bit architecture even though MobileFirst library does support 64-bit architecture. Therefore, FIPS must not be enabled on 64-bit target platform when XCode Build Setting (Architecture) is also set to 64 bit.
- This feature works with hybrid applications only (not native).
- The use of the user enrollment feature on the client is not supported by the FIPS 140-2 feature.
- The Application Center client does not support the FIPS 140-2 feature.

For more information about this feature, see “FIPS 140-2 support” on page 11-124.

LTPA token limitations

An SESN0008E exception occurs when an LTPA token expires before the user session expires.

An LTPA token is associated with the current user session. If the session expires before an LTPA token expires, a new session is created automatically. However, when an LTPA token expires before a user session expires, the following exception occurs:

```
com.ibm.websphere.servlet.session.UnauthorizedSessionRequestException: SESN0008E:  
A user authenticated as anonymous has attempted to access a session owned by {user name}
```

To resolve this limitation, you must force the user session to expire when the LTPA token expires.

- On WebSphere Application Server Liberty, set the `httpSession` attribute `invalidateOnUnauthorizedSessionRequestException` to `true` in the `server.xml` file.
- On WebSphere Application Server, add the session management custom property `InvalidateOnUnauthorizedSessionRequestException` with the value `true` to fix the issue.

Note: On certain versions of WebSphere Application Server or WebSphere Application Server Liberty, the exception is still logged, but the session is correctly invalidated. For more information, see APAR PM85141.

Support of Oracle 12c by MobileFirst Server

The installation tools of the MobileFirst Server (Installation Manager, Server Configuration Tool, and Ant tasks) support installation with Oracle 12c as a database.

The users and tables can be created by the installation tools but the database, or databases, must exist before you run the installation tools.

Liberty server limitations

If you use the Liberty studio server on a 32-bit JDK 7, Eclipse might not start, and you might receive the following error: Error occurred during initialization of VM. Could not reserve enough space for object heap. Error: Could not create the Java Virtual Machine. Error: A fatal exception has occurred. Program will exit.

To fix this issue, use the 64-bit JDK with the 64-bit Eclipse and 64-bit Windows. If you use the 32-bit JDK on a 64-bit machine, you might configure JVM preferences to `mx512m` and `-Xms216m`.

Application servers restrictions for MobileFirst Data Proxy

You cannot install MobileFirst Data Proxy on the following application servers:

- Apache Tomcat
- Versions of WebSphere Application Server Liberty profile earlier than V8.5.5.0.

Physical iOS device required for testing extended app authenticity

The testing of the extended app authenticity feature requires a physical iOS device, because an IPA cannot be installed on an iOS simulator.

Troubleshooting

You can find advice on how to troubleshoot problems, and more information about known limitations and technotes (Troubleshooting).

The following links point to troubleshooting topics in other parts of this user documentation. To navigate from there back to this topic, click **Back** in your Web browser.

- “Troubleshooting IBM MobileFirst Platform Server” on page 6-280
- “Troubleshooting IBM HTTP Server startup” on page 6-259
- “Troubleshooting to find the cause of installation failure” on page 6-280
- “Troubleshooting a Cast Iron adapter – connectivity issues” on page 8-149
- “Troubleshooting JSONStore” on page 8-168
- “Troubleshooting simple data sharing” on page 8-256.
- “Troubleshooting a corrupt login page (Apache Tomcat)” on page 11-77
- “Troubleshooting failure to authenticate to Application Center and applications that use the basic registry element” on page 6-281
- “Troubleshooting push notification problems” on page 8-220
- “Troubleshooting JMX configuration for Liberty profile” on page 6-49

For more information about known limitations or issues in the product, and removed or deprecated features, see “Release notes” on page 3-1.

Important: If you have to contact IBM Support for help, see the information in Collect troubleshooting data. This document details how to gather the necessary information about your environment so that IBM Support can help diagnose and resolve your problem.

Tutorials, samples, and additional resources

Tutorials and samples help you get started with and learn about IBM MobileFirst Platform Foundation for iOS. Use them to evaluate what the product can do for you.

Tutorials and associated samples

For you to learn the most important features of IBM MobileFirst Platform Foundation for iOS, tutorials are available on the Getting Started page of the Developer Center for IBM MobileFirst Platform Foundation for iOS.

Tutorials are organized in categories.

Each tutorial is composed of web pages to learn the steps and one or two companion samples to practice and reuse. The samples are provided as compressed files and contain pieces of code or script files that support the step-by-step instructions. When a tutorial includes some exercises, a companion sample provides the solutions to these exercises.

The same page provides links for you to download compressed files that contain the materials for the tutorials and samples.

Sample applications

Demonstrations are available from the Starter application samples page of the Developer Center for a collection of features.

Additional documentation

The Additional documentation page of the Developer Center provides more useful links, including a guide to scalability and hardware sizing.

Terms and conditions

Before you use the IBM MobileFirst Platform Foundation for iOS Getting Started modules, exercises, and code samples that are available from Getting Started pages, you must agree on the terms and conditions that are set forth here:

This information contains sample code provided in source code form. You may copy, modify, and distribute these sample programs in any form without payment to IBM for the purposes of developing, using, marketing or distributing application programs conforming to the application programming interface for the operating platform for which the sample code is written. Notwithstanding anything to the contrary, IBM PROVIDES THE SAMPLE SOURCE CODE ON AN "AS IS" BASIS AND IBM DISCLAIMS ALL WARRANTIES, EXPRESS OR IMPLIED, INCLUDING, BUT NOT LIMITED TO, ANY IMPLIED WARRANTIES OR CONDITIONS OF MERCHANTABILITY, SATISFACTORY QUALITY, FITNESS FOR A PARTICULAR PURPOSE, TITLE, AND ANY WARRANTY OR CONDITION OF NON-INFRINGEMENT. IBM SHALL NOT BE LIABLE FOR ANY DIRECT, INDIRECT, INCIDENTAL, SPECIAL, EXEMPLARY OR ECONOMIC CONSEQUENTIAL DAMAGES ARISING OUT OF THE USE OR OPERATION OF THE SAMPLE SOURCE CODE. IBM SHALL NOT BE LIABLE FOR LOSS OF, OR

DAMAGE TO, DATA, OR FOR LOST PROFITS, BUSINESS REVENUE, GOODWILL, OR ANTICIPATED SAVINGS. IBM HAS NO OBLIGATION TO PROVIDE MAINTENANCE, SUPPORT, UPDATES, ENHANCEMENTS OR MODIFICATIONS TO THE SAMPLE SOURCE CODE.

The resources might include applicable third-party licenses. Review the third-party licenses before you use any of the resources. You can find the third-party licenses that apply to each sample in the `notices.txt` file that is included with each sample.

Installing and configuring

This topic is intended for IT developers and administrators who want to install and configure IBM MobileFirst Platform Foundation for iOS.

This topic describes the tasks required to install and configure the different components of IBM MobileFirst Platform Foundation for iOS. It also contains information about installing and configuring database and application server software that you need to support the runtime database.

For more information about how to size your system, see the Scalability and Hardware Sizing document and the hardware calculator spreadsheet at the Developer Center website for IBM MobileFirst Platform Foundation.

Consider compatibility with prior releases before you decide what version of each product component to install. For more information, see “Version compatibility” on page 7-1.

Installation overview

IBM MobileFirst Platform Foundation for iOS provides the following installable components: MobileFirst Platform Command Line Interface for iOS, and MobileFirst Server. This section gives an overview of the installation process.

Installing MobileFirst Server with IBM Installation Manager

To ensure the correct installation of MobileFirst Server, see “Installation prerequisites” on page 6-4.

You must install IBM Installation Manager 1.6.3 or later separately before installing IBM MobileFirst Platform Foundation for iOS. For more information, see “Running IBM Installation Manager” on page 6-29.

Note: IBM Installation Manager is sometimes referred to as *IBM Rational® Enterprise Deployment* on the eXtreme Leverage, Passport Advantage® sites, and on the distribution disks. The file names for the images take the form *IBM Rational Enterprise Deployment <version number><hardware platform> <language>*; for example, *IBM Rational Enterprise Deployment V1.6.3.1Windows Multilingual*.

You then use IBM Installation Manager to install MobileFirst server-side components on your application server, and to create databases on your database management system. Some application server and database configuration is required. For actual instructions, see “Installing MobileFirst Server” on page 6-2.

Upgrading from earlier versions

The preceding sections provide an overview of IBM MobileFirst Platform Foundation for iOS “first time” installations. For information about upgrading existing installations of MobileFirst Server to a newer version, see “Upgrading to IBM MobileFirst Platform Foundation for iOS V7.0.0” on page 7-1.

Consider compatibility with prior releases before you decide what version of each product component to install. For more information about compatibility between

releases, see “Version compatibility” on page 7-1.

Installing command-line tools for developers

Follow these instructions to install IBM MobileFirst Platform Command Line Interface for iOS (CLI).

Procedure

1. Download the IBM MobileFirst Platform Command Line Interface for iOS with the rest of IBM MobileFirst Platform Foundation for iOS from IBM Passport Advantage.
2. In the Finder, double-click the `mobilefirst_ios_cli_installer_7.0.0.zip` package. The CLI is packaged as a single compressed file, which contains installation executable files for each platform, as listed:
 - Readme file
 - `install_mac.app`
 - `resources/`
3. From the Finder, right-click the `install_mac.app` file and select **Open**. A GUI appears which guides you through the installation of IBM MobileFirst Platform Command Line Interface for iOS. Follow the instructions to complete your installation.
4. On completion of your installation, log out and then log back in. This action ensures that the `mobilefirst` and `mfp` commands are on your system path.

Uninstalling command-line tools for developers

Follow these instructions to uninstall the IBM MobileFirst Platform Command Line Interface for iOS.

Before you begin

Open your command-line terminal to the path where you installed the IBM MobileFirst Platform Command Line Interface for iOS, and change the directory to the Uninstaller folder.

Procedure

GUI Uninstallation: Select and run the `uninstall`. A GUI appears which guides you through the uninstallation of the IBM MobileFirst Platform Command Line Interface for iOS. Follow the instructions to complete your uninstallation.

Installing MobileFirst Server

IBM installations are based on an IBM product called IBM Installation Manager. Install IBM Installation Manager 1.6.3.1 or later separately before you install IBM MobileFirst Platform Foundation for iOS.

Important: Ensure that you use IBM Installation Manager 1.6.3.1 or later. This version contains an important fix for an issue identified in IBM Installation Manager 1.6.3. See <http://www.ibm.com/support/docview.wss?uid=swg24035049>.

The MobileFirst Server installer copies onto your computer all the tools and libraries that are required for deploying a MobileFirst project or the IBM MobileFirst Platform Application Center in production, and IBM SmartCloud® Analytics Embedded.

MobileFirst Server can also automatically deploy the Application Center at installation time. In this case, a database management system and an application server are required as prerequisites and must be installed before you start the MobileFirst Server installer.

The installer can also help with upgrading an existing installation of MobileFirst Server to the current version. See “Upgrading to IBM MobileFirst Platform Foundation for iOS V7.0.0” on page 7-1.

Before you install, take the time to consider the server topology in which you will deploy the administration components and the runtimes. The supported topologies are introduced in “Planning deployment of administration components and runtimes” on page 6-7.

The following topics describe the installation of MobileFirst Server, installation prerequisites, and the procedures for a manual installation and configuration of Application Center. After MobileFirst Server is installed, a MobileFirst project must be deployed to an application server. This deployment installs a IBM MobileFirst Platform Operations Console that can be used to upload applications and adapters. The instructions in “Tutorial for a basic installation of MobileFirst Server” on page 6-23 are based on a simple installation scenario. For a complete description of the process of deploying a MobileFirst project, see “Deploying MobileFirst projects” on page 10-1.

Planning the installation of MobileFirst Server

You must plan your installation and choose one installation scenario. You must also plan the creation of your databases and the topology of the application server.

To install the MobileFirst Server, you can choose one of the following scenarios:

- With the Server Configuration Tool.

The Server Configuration Tool is a graphical tool and is available for Windows, Linux on x86, and Mac OS. With this tool, you get easily started, but expect some limitations when you maintain an application in production, in particular for some upgrade scenarios. This tool can export Ant files.

Restriction:

- The Server Configuration Tool does not support server farms. Therefore, you cannot use it to define, install, upgrade, or uninstall server farms. For server farms, use the provided Ant script or follow manual steps in your application server. For more information, see “Installing a server farm” on page 6-97.
- The Server Configuration Tool for Mac OS is available for development and test purposes only.
- Ant tasks: Ant command-line files automate the process of creating or upgrading a database, either automatically or as a complement of a database preparation by a database administrator. The Ant tasks also automate the process of installing or upgrading the Administration Services and the MobileFirst Operations Console in an application server. Ant tasks provide a high level of control for individual operations on the database or on the application server.
- Manual installation.

Installation prerequisites

For smooth installation of MobileFirst Server, ensure that you fulfill all required environment setup and software prerequisites before you attempt installation.

You can find a complete list of supported hardware together with prerequisite software in “System requirements” on page 2-7.

Important: If a version of MobileFirst Server is already installed, review “Upgrading to IBM MobileFirst Platform Foundation for iOS V7.0.0” on page 7-1 before you install MobileFirst Server and deploy a MobileFirst project on the same application server or databases. Failure to do so can result in an incomplete installation and a non-functional MobileFirst Server.

Download the IBM MobileFirst Platform Foundation for iOS package from IBM Passport Advantage.

Ensure that you have the latest fix packs for the IBM MobileFirst Platform Foundation for iOS product. If you are connected to the Internet during the installation, IBM Installation Manager can download the latest fix packs for you.

The package contains an Install Wizard that guides you through the MobileFirst Server installation.

MobileFirst Server requires an application server and relies on a database management system.

You can use any of the following application servers:

- WebSphere Application Server Liberty Core
- WebSphere Application Server
- Apache Tomcat

You can use any of the following database management systems:

- IBM DB2[®]
- MySQL
- Oracle
- Apache Derby in embedded mode. Included in the installation image.

Verify that the application server you selected provides support for your database.

Note: Apache Derby is supplied for evaluation and testing purposes only and is not supported for production-grade MobileFirst Server.

The MobileFirst installer can install the IBM MobileFirst Platform Application Center and deploy it to your application server. In this case, the application server and the database management system (if different from Apache Derby) must be installed before you start the MobileFirst Server installer. If you do not need the Application Center or decide to install it manually, you do not need to install the application server and database management system before you start the MobileFirst Server installer. However, you need them before you deploy IBM MobileFirst Platform Foundation for iOS projects.

The IBM MobileFirst Platform Foundation for iOS packages include the following installers:

- IBM DB2 Workgroup Server Edition

- IBM DB2 Enterprise Server Edition (on Linux for System z[®] only)
- IBM WebSphere Application Server Liberty Core

File system prerequisites

To install IBM MobileFirst Platform Foundation for iOS to an application server, the MobileFirst installation tools must be run by a user that has specific file system privileges.

The installation tools include:

- IBM Installation Manager
- The Server Configuration Tool
- The Ant tasks to deploy the MobileFirst Server

For WebSphere Application Server Liberty profile, you must have the right to perform the following actions:

- Read the files in the Liberty installation directory.
- Create files in the configuration directory of the Liberty server, which is typically `usr/servers/<servername>`, to create backup copies and modify `server.xml` and `jvm.options`.
- Create files and directories in the Liberty shared resource directory, which is typically `usr/shared`.
- Create files in the Liberty server apps directory, which is typically `usr/servers/<servername>/apps`.

For WebSphere Application Server full profile and WebSphere Application Server Network Deployment, you must have the right to perform the following actions:

- Read the files in the WebSphere Application Server installation directory.
- Read the configuration file of the selected WebSphere Application Server full profile or of the Deployment Manager profile.
- Run the `wsadmin` command.
- Create files in the `profiles` configuration directory. The installation tools put resources such as shared libraries or JDBC drivers in that directory.

For Apache Tomcat, you must have the right to perform the following actions:

- Read the configuration directory.
- Create backup files and modify files in the configuration directory, such as `server.xml`, and `tomcat-users.xml`.
- Create backup files and modify files in the `bin` directory, such as `setenv.bat`.
- Create files in the `lib` directory.
- Create files in the `webapps` directory.

For all these application servers, the user who runs the application server must be able to read the files that were created by the user who ran the MobileFirst installation tools.

Introduction to the MobileFirst Server components

The MobileFirst Server is composed of one or more runtime environments, an administration console and administration services, an enterprise application store, and an operational analytics feature.

MobileFirst Server components run as web applications on an application server. To set up MobileFirst Server, you must first choose which of the following supported application servers you want to use:

- WebSphere Application Server
- WebSphere Application Server Liberty
- Apache Tomcat

For implementations that require several servers, you might want to set up one of the following topologies:

- A server cluster that is defined by using the WebSphere Application Server Network Deployment solution. (Use the hardware-sizing tool on developerWorks® to decide on the number of servers and the size of the database.)
- A farm of individual application servers. Specific installation steps must be taken. See “Installing a server farm” on page 6-97.

The following sections describe each of the following MobileFirst Server components:

- “MobileFirst runtime environments.”
- “IBM MobileFirst Platform Operations Console and Administration Services”
- “IBM MobileFirst Platform Application Center” on page 6-7
- “MobileFirst Operational Analytics” on page 6-7

MobileFirst runtime environments

The MobileFirst runtime environment is a mobile-optimized server-side component that runs the server side of your mobile applications (back-end integration, version management, security, unified push notification).

Each runtime environment is packaged as a web application (WAR file), which is created by using IBM MobileFirst Platform Command Line Interface for iOS. Each runtime environment can host one or more MobileFirst applications.

Each runtime environment requires a database to host information such as the list of devices that connect to it. Different runtime environments (different project WAR files) cannot share database tables. If you have multiple runtime environments, the tables must be in different schemas or different databases, depending on your database management system. Similar runtime environments (project WAR files) that run in the same cluster of farm must use the same database unless you implement a disaster recovery topology with replication and conflict management as described in Active/Active topology for the MobileFirst Platform Foundation Server. You can also optionally set up a report database to host data for simple usage reports of a particular runtime environment.

IBM MobileFirst Platform Operations Console and Administration Services

The MobileFirst Administration component consists of two applications that are used for the administration of the runtime environments:

- The MobileFirst Operations Console application.
- The MobileFirst Administration Services application.

The MobileFirst Operations Console is the web-based interface that an IT administrator uses to run administration tasks on the mobile application such as application deployment, management, version enforcement, and management of push notifications.

The MobileFirst Operations Console is supported by the MobileFirst Administration Services application. This application acts as host for all the REST services and administration tasks. Both the MobileFirst Operations Console and the Administration Services can be secured through standard Java Platform, Enterprise Edition security. Several administration user roles are available to cover different administration scenarios.

One MobileFirst Operations Console can be used for the administration of several runtime environments. The administration tasks are run through standard JMX (Java Management Extension) calls.

Note: Since V6.2.0, the MobileFirst runtime environment registers an MBean called `com.worklight.core.jmx.ProjectManagementMXBean` and exposes the JMX API with this MBean. This MBean is exposed with all other MBeans that are registered in the application server. It is used by the runtime environment for such things as the management of deployed applications and adapters, devices, and push services. This MBean is intended to be used only by the MobileFirst Administration Services, so methods in this MBean are private and are not meant to be accessed directly.

A database is required for the MobileFirst Operations Console and Administration Services.

IBM MobileFirst Platform Application Center

The Application Center is a private application store that developers can use to get feedback about their mobile applications from testers and stakeholders. The Application Center is used to distribute private or public applications to employees and partners. The Application Center is an optional component that can be installed separately from the other MobileFirst Server components.

The Application Center consists of two web applications:

- The Application Center console application that provides the user interface.
- The Application Center services application that provides the REST services.

A database is required for the Application Center. For more information, see “Application Center” on page 11-65.

MobileFirst Operational Analytics

The operational analytics feature enables searching across apps, services, devices, and other sources to collect data about usage or to detect problems.

The feature is packaged as a web application. To enable the collection of analytics information, you must configure the runtime environment with the URL of the analytics platform. For more information, see “Analytics” on page 12-6.

Planning deployment of administration components and runtimes

Plan the deployment of MobileFirst administration components and runtimes depending on the server topology that you use.

See “Introduction to the MobileFirst Server components” on page 6-5 for an introduction to the administration components and runtimes.

You can use the following topologies of application servers:

- Stand-alone server: WebSphere Application Server Liberty profile, Apache Tomcat, or WebSphere Application Server full profile
- Server farm: WebSphere Application Server Liberty profile, Apache Tomcat, or WebSphere Application Server full profile
- WebSphere Application Server Network Deployment cell

Depending on the application server topology that you use, you can deploy either symmetrically or asymmetrically. In symmetrical deployment, you must install runtimes and administration components on the same application server. In asymmetric deployment, you can install the runtimes on different application servers from the administration components.

Modes of deployment

Two modes are available to deploy the MobileFirst administration components and the runtimes in the application server infrastructure.

- Symmetric deployment: the MobileFirst administration components (MobileFirst Operations Console and administration service applications) are deployed in the same Java Virtual Machine (JVM) as the runtimes.
- asymmetric deployment: The administration components are deployed in a different JVM from the runtimes.

Asymmetric deployment is only supported for WebSphere Application Server Network Deployment cell topology.

Stand-alone server topology:

You can configure a stand-alone topology for WebSphere Application Server full profile, WebSphere Application Server Liberty profile, and Apache Tomcat.

In this topology, all the administration components and the runtimes are deployed in a single Java Virtual Machine (JVM).

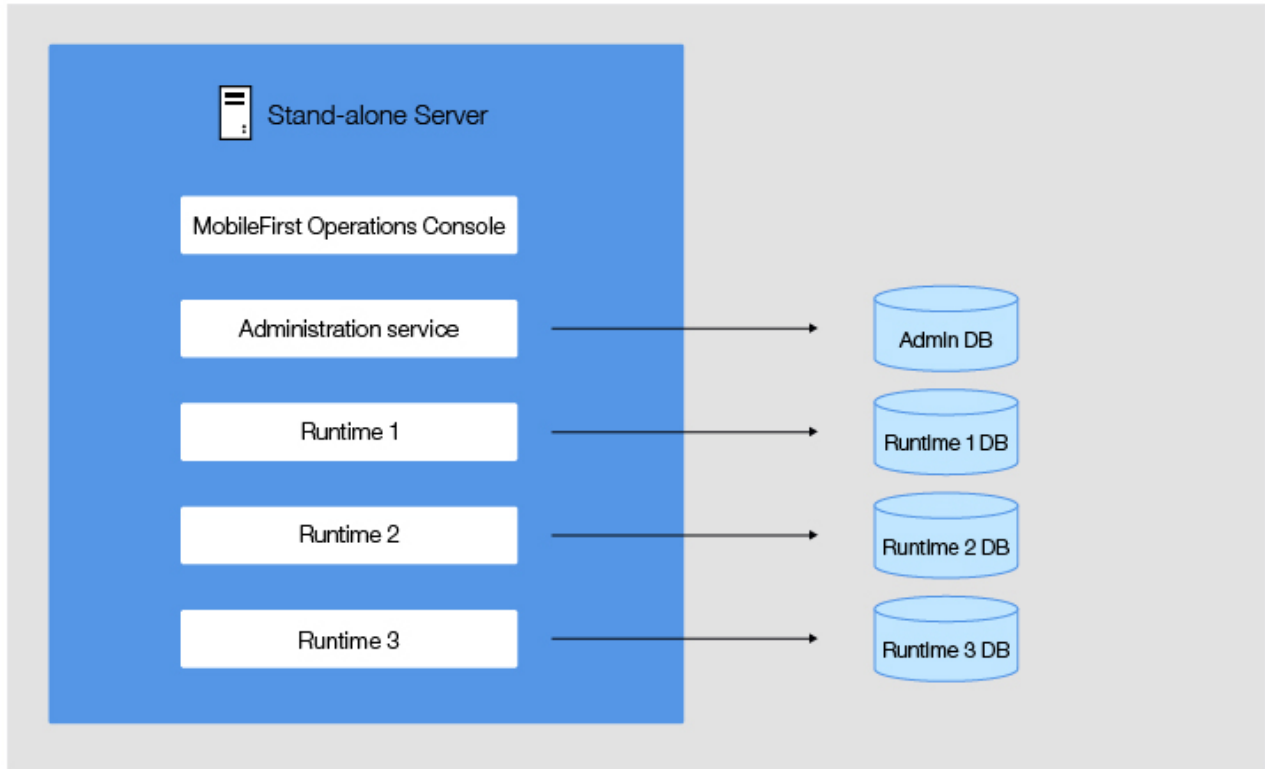

Figure 6-1. Topology of a stand-alone server

With one JVM, only symmetric deployment is possible with the following characteristics:

- One or several administration components can be deployed. Each MobileFirst Operations Console communicates with one administration service.
- One or several runtimes can be deployed.
- One MobileFirst Operations Console can manage several runtimes.
- One runtime is managed by only one MobileFirst Operations Console.
- Each administration service uses its own administration database schema.
- Each runtime uses its own runtime database schema.

Configuration of JNDI properties

Some JNDI properties are required to enable Java Management Extensions (JMX) communication between the administration service and the runtime, and to define the administration service that manages a runtime. For details about these properties, see “List of JNDI properties for MobileFirst Server administration” on page 6-86 and “Configuring a MobileFirst project in production by using JNDI environment entries” on page 10-60.

Stand-alone WebSphere Application Server Liberty profile server

The following global JNDI properties are required for the administration services and for the runtimes.

Table 6-1. Global JNDI properties for administration services and runtimes in WebSphere Application Server Liberty stand-alone topology

JNDI properties	Values
ibm.worklight.topology.platform	"Liberty"
ibm.worklight.topology.clustermode	"Standalone"
ibm.worklight.admin.jmx.host	Hostname of the WebSphere Application Server Liberty profile server
ibm.worklight.admin.jmx.port	Port of the REST connector that is the port of the httpsPort attribute declared in the <httpEndpoint> element of the server.xml file of WebSphere Application Server Liberty profile server. This property has no default value.
ibm.worklight.admin.jmx.user	The user name of the WebSphere Application Server Liberty administrator, which must be identical to the name defined in the <administrator-role> element of the server.xml file of the WebSphere Application Server Liberty profile server.
ibm.worklight.admin.jmx.pwd	Password of the WebSphere Application Server Liberty administrator user.

Several administration components can be deployed to enable the same JVM to run on separate administration components that manage different runtimes.

When you deploy several administration components, you must specify:

- On each administration service, a unique value for the local **ibm.worklight.admin.environmentid** JNDI property.
- On each runtime, the same value for the local **ibm.worklight.admin.environmentid** JNDI property as the value defined for the administration service that manages the runtime.

Stand-alone Apache Tomcat server

The following local JNDI properties are required for the administration services and for the runtimes.

Table 6-2. Local JNDI properties for administration services and runtimes in Apache Tomcat stand-alone topology

JNDI properties	Values
ibm.worklight.topology.platform	"Tomcat"
ibm.worklight.topology.clustermode	"Standalone"

JVM properties are also required to define Java Management Extensions (JMX) Remote Method Invocation (RMI). For more information, see "Configuring Apache Tomcat" on page 6-47.

If the Apache Tomcat server is running behind a firewall, the **ibm.worklight.admin.rmi.registryPort** and **ibm.worklight.admin.rmi.serverPort** JNDI properties are required for the administration service. See "Configuring Apache Tomcat" on page 6-47.

Several administration components can be deployed to enable the same JVM to run on separate administration components that manage different runtimes.

When you deploy several administration components, you must specify:

- On each administration service, a unique value for the local **ibm.worklight.admin.environmentid** JNDI property.
- On each runtime, the same value for the local **ibm.worklight.admin.environmentid** JNDI property as the value defined for the administration service that manages the runtime.

Stand-alone WebSphere Application Server

The following local JNDI properties are required for the administration services and for the runtimes.

Table 6-3. Local JNDI properties for administration services and runtimes in WebSphere Application Server stand-alone topology

JNDI properties	Values
ibm.worklight.topology.platform	"WAS"
ibm.worklight.topology.clustermode	"Standalone"
ibm.worklight.admin.jmx.connector	The JMX connector type; the value can be "SOAP" or "RMI".

Several administration components can be deployed to enable the same JVM to run on separate administration components that manage different runtimes.

When you deploy several administration components, you must specify:

- On each administration service, a unique value for the local **ibm.worklight.admin.environmentid** JNDI property.
- On each runtime, the same value for the local **ibm.worklight.admin.environmentid** JNDI property as the value defined for the administration service that manages the runtime.

Server farm topology:

You can configure a farm of WebSphere Application Server full profile, WebSphere Application Server Liberty profile, or Apache Tomcat application servers.

A farm is a set of individual servers where the same components are deployed and where the same administration database and runtime database are shared between the servers. The farm topology enables the load of MobileFirst applications to be distributed across several servers. Each server in the farm must be a Java Virtual Machine (JVM) of the same type of application server; that is, a homogeneous server farm.

In this topology, all the administration components and the runtimes are deployed on every server in the farm.

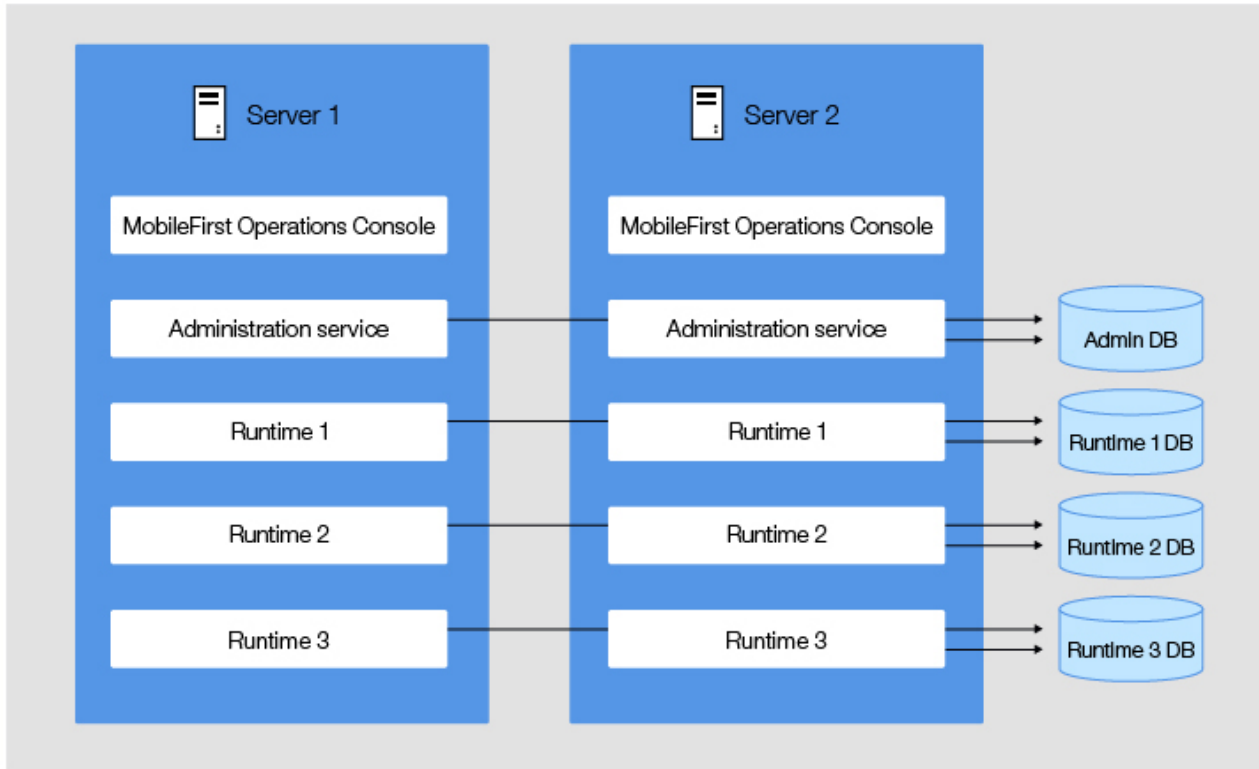

Figure 6-2. Topology of a server farm

This topology supports only symmetric deployment. The runtimes and the administration components must be deployed on every server in the farm. The deployment of this topology has the following characteristics:

- One or several administration components can be deployed. Each instance of MobileFirst Operations Console communicates with one administration service.
- The administration components must be deployed on all servers in the farm.
- One or several runtimes can be deployed.
- The runtimes must be deployed on all servers in the farm.
- One MobileFirst Operations Console can manage several runtimes.
- One runtime is managed by only one MobileFirst Operations Console.
- Each administration service uses its own administration database schema. All deployed instances of the same administration service share the same administration database schema.
- Each runtime uses its own runtime database schema. All deployed instances of the same runtime share the same runtime database schema.

Configuration of JNDI properties

Some JNDI properties are required to enable JMX communication between the administration service and the runtime of the same server, and to define the administration service that manages a runtime. For convenience, the tables in this section list these properties. For instructions about how to install a server farm, see “Installing a server farm” on page 6-97. For details about the JNDI properties, see “List of JNDI properties for MobileFirst Server administration” on page 6-86 and “Configuring a MobileFirst project in production by using JNDI environment entries” on page 10-60.

WebSphere Application Server Liberty profile server farm

The following global JNDI properties are required in each server of the farm for the administration services and for the runtimes.

Table 6-4. Global JNDI properties for administration services and runtimes in server farm topology of WebSphere Application Server Liberty profile

JNDI properties	Values
ibm.worklight.topology.platform	"Liberty"
ibm.worklight.topology.clustermode	"Farm"
ibm.worklight.admin.jmx.host	Hostname of the WebSphere Application Server Liberty profile server
ibm.worklight.admin.jmx.port	Port of the REST connector that must be identical to the value of the httpsPort attribute declared in the <httpEndpoint> element of the server.xml file of the WebSphere Application Server Liberty profile server. <pre><httpEndpoint id="defaultHttpEndpoint" httpPort="9080" httpsPort="9443" host="*" /></pre>
ibm.worklight.admin.jmx.user	The user name of the WebSphere Application Server Liberty administrator that is defined in the <administrator-role> element of the server.xml file of the WebSphere Application Server Liberty profile server. <pre><administrator-role> <user>WorklightRESTUser</user> </administrator-role></pre>
ibm.worklight.admin.jmx.pwd	Password of the WebSphere Application Server Liberty administrator user.

The **ibm.worklight.admin.serverid** JNDI property is required for the administration service to manage the server farm configuration. Its value is the server identifier, which must be different for each server in the farm.

Several administration components can be deployed to enable the same JVM to run on separate administration components that manage different runtimes.

When you deploy several administration components, you must specify:

- On each administration service, a unique value for the local **ibm.worklight.admin.environmentid** JNDI property.
- On each runtime, the same value for the local **ibm.worklight.admin.environmentid** JNDI property as the value defined for the administration service that manages the runtime.

Apache Tomcat server farm

The following global JNDI properties are required in each server of the farm for the administration services and for the runtimes.

Table 6-5. Global JNDI properties for administration services and runtimes in server farm topology of Apache Tomcat

JNDI properties	Values
ibm.worklight.topology.platform	"Tomcat"
ibm.worklight.topology.clustermode	"Farm"

JVM properties are also required to define Java Management Extensions (JMX) Remote Method Invocation (RMI). For more information, see "Configuring Apache Tomcat" on page 6-47.

The **ibm.worklight.admin.serverid** JNDI property is required for the administration service to manage the server farm configuration. Its value is the server identifier, which must be different for each server in the farm.

Several administration components can be deployed to enable the same JVM to run on separate administration components that manage different runtimes.

When you deploy several administration components, you must specify:

- On each administration service, a unique value for the local **ibm.worklight.admin.environmentid** JNDI property.
- On each runtime, the same value for the local **ibm.worklight.admin.environmentid** JNDI property as the value defined for the administration service that manages the runtime.

WebSphere Application Server full profile server farm

The following global JNDI properties are required on each server in the farm for the administration services and for the runtimes.

Table 6-6. Global JNDI properties for administration services and runtimes in server farm topology of WebSphere Application Server full profile

JNDI properties	Values
ibm.worklight.topology.platform	"WAS"
ibm.worklight.topology.clustermode	"Farm"
ibm.worklight.admin.jmx.connector	"SOAP"

The following JNDI properties are required for the administration service to manage the server farm configuration.

JNDI properties	Values
ibm.worklight.admin.jmx.user	The user name of WebSphere Application Server. This user must be defined in the WebSphere Application Server user registry.
ibm.worklight.admin.jmx.pwd	The password of the WebSphere Application Server user.
ibm.worklight.admin.serverid	The server identifier, which must be different for each server in the farm and identical to the value of this property used for this server in the server farm configuration file.

Several administration components can be deployed to enable the same JVM to run on separate administration components that manage different runtimes.

When you deploy several administration components, you must specify the following values:

- On each administration service, a unique value for the local **ibm.worklight.admin.environmentid** JNDI property.
- On each runtime, the same value for the local **ibm.worklight.admin.environmentid** JNDI property as the value defined for the administration service that manages the runtime.

WebSphere Application Server Network Deployment topologies:

The administration components and the runtimes are deployed in servers or clusters of the WebSphere Application Server Network Deployment cell.

Examples of these topologies support either asymmetric or symmetric deployment, or both. You can, for example, deploy the administration components in one cluster and the runtimes managed by these components in another cluster.

Symmetric deployment in the same server or cluster

Figure 6-3 shows symmetric deployment where the runtimes and the administration components are deployed in the same server or cluster.

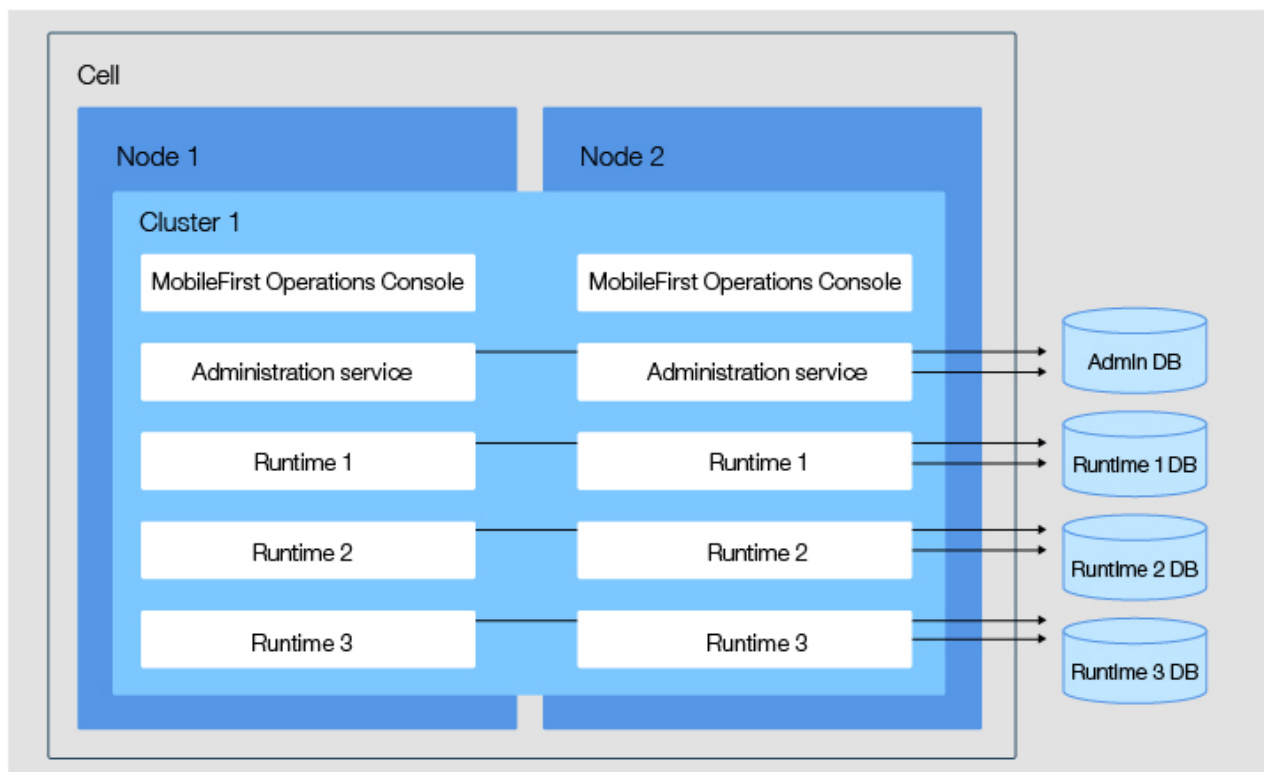

Figure 6-3. Symmetric deployment, same server or cluster

The deployment of this topology has the following characteristics:

- One or several administration components can be deployed in one or several servers or clusters of the cell. Each instance of MobileFirst Operations Console communicates with one administration service.

- One or several runtimes can be deployed in the same server or cluster as the administration components that manage them.
- One runtime is managed by only one MobileFirst Operations Console.
- Each administration service uses its own administration database schema.
- Each runtime uses its own runtime database schema.

Asymmetric deployment with runtimes and administration services in different server or cluster

Figure 6-4 shows a topology where the runtimes are deployed in a different server or cluster from the administration services.

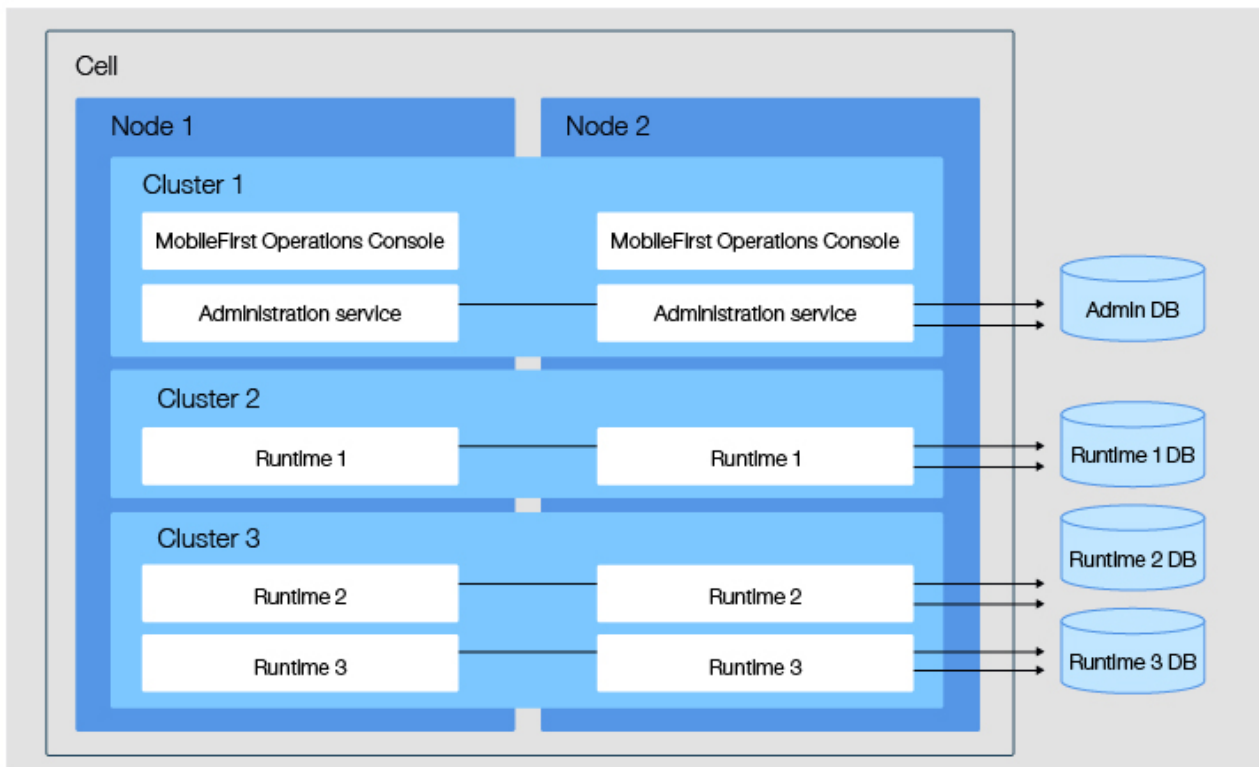

Figure 6-4. Asymmetric deployment, different server or cluster

The deployment of this topology has the following characteristics:

- One or several administration components can be deployed in one or several servers or clusters of the cell. Each instance of MobileFirst Operations Console communicates with one administration service.
- One or several runtimes can be deployed in other servers or clusters of the cell.
- One MobileFirst Operations Console manages several runtimes deployed in the other servers or clusters of the cell.
- One runtime is managed by only one MobileFirst Operations Console.
- Each administration service uses its own administration database schema.
- Each runtime uses its own runtime database schema.

This topology is advantageous, because it enables the runtimes to be isolated from the administration components and from other runtimes. It can be used to provide

performance isolation, to isolate critical applications, and to enforce Service Level Agreement (SLA).

Symmetric and asymmetric deployment

Figure 6-5 shows an example of symmetric deployment in Cluster1 and of asymmetric deployment in Cluster2, where Runtime2 and Runtime3 are deployed in a different cluster from the administration components. MobileFirst Operations Console manages the runtimes deployed in Cluster1 and Cluster2.

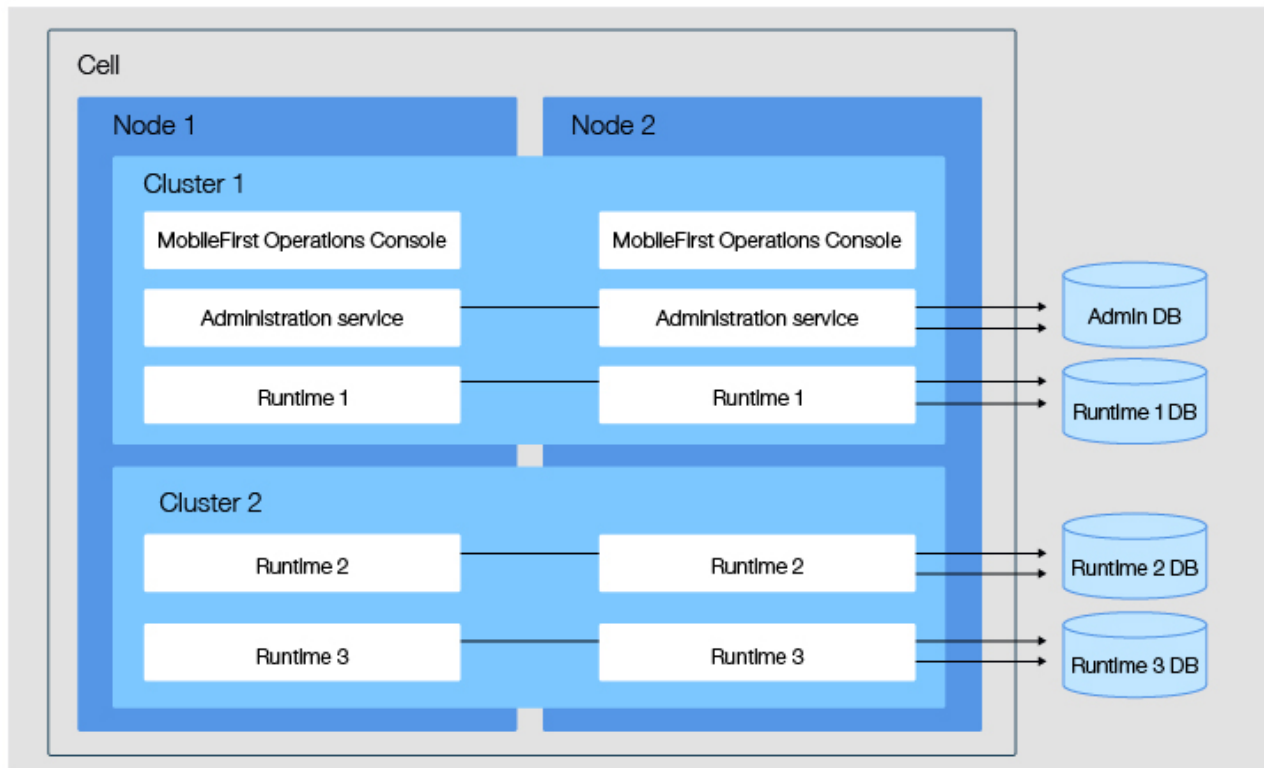

Figure 6-5. Symmetric and asymmetric deployment in different clusters of a cell

The deployment of this topology has the following characteristics:

- One or several administration components can be deployed in one or several servers or clusters of the cell. Each instance of MobileFirst Operations Console communicates with one administration service.
- One or several runtimes can be deployed in one or several servers or clusters of the cell.
- One MobileFirst Operations Console can manage several runtimes deployed in the same or other servers or clusters of the cell.
- One runtime is managed by only one MobileFirst Operations Console.
- Each administration service uses its own administration database schema.
- Each runtime uses its own runtime database schema.

Configuration of JNDI properties

Some JNDI properties are required to enable JMX communication between the administration service and the runtime, and to define the administration service that manages a runtime. For details about these properties, see “List of JNDI

properties for MobileFirst Server administration” on page 6-86 and “Configuring a MobileFirst project in production by using JNDI environment entries” on page 10-60.

The following local JNDI properties are required for the administration services and for the runtimes:

Table 6-7. Local JNDI properties for administration services and runtimes in WebSphere Application Server Network Deployment topologies

JNDI properties	Values
ibm.worklight.topology.platform	“WAS”
ibm.worklight.topology.clustermode	“Cluster”
ibm.worklight.admin.jmx.connector	The JMX connector type to connect with the Deployment Manager. The value can be “SOAP” or “RMI”. “SOAP” is the default and preferred value. “RMI” must be used if the SOAP port is disabled
ibm.worklight.admin.jmx.dmgr.host	The host name of the Deployment Manager.
ibm.worklight.admin.jmx.dmgr.port	The RMI or the SOAP port used by the Deployment Manager, depending on the value of ibm.worklight.admin.jmx.connector .

Several administration components can be deployed to enable you to run the same server or cluster with separate administration components managing each of the different runtimes.

When several administration components are deployed, you must specify:

- On each administration service, a unique value for the local **ibm.worklight.admin.environmentid** JNDI property.
- On each runtime, the same value for the local **ibm.worklight.admin.environmentid** as the value defined for the administration service that manages that runtime.

Using a reverse proxy with server farm and WebSphere Application Server Network Deployment topologies:

You can use a reverse proxy with distributed topologies. If your topology uses a reverse proxy, configure the required JNDI properties for the administration service.

See the Glossary for the definition of a reverse proxy.

You can use a reverse proxy, such as IBM HTTP Server, to front server farm or WebSphere Application Server Network Deployment topologies. In this case, you must configure the administration components appropriately.

You can call the reverse proxy from:

- The browser when you access MobileFirst Operations Console.
- The runtime when it calls the administration service.
- The MobileFirst Operations Console component when it calls the Administration services.

If the reverse proxy is in a DMZ (a firewall configuration for securing local area networks) and a firewall is used between the DMZ and the internal network, this firewall must authorize all incoming requests from the application servers.

When a reverse proxy is used in front of the application server infrastructure, the following JNDI properties must be defined for the administration service.

Table 6-8. JNDI properties for reverse proxy

JNDI properties	Values
ibm.worklight.admin.proxy.protocol	The protocol used to communicate with the reverse proxy, which can be HTTP or HTTPS.
ibm.worklight.admin.proxy.host	The host name of the reverse proxy.
ibm.worklight.admin.proxy.port	The port number of the reverse proxy.

The **ibm.worklight.admin.endpoint** property that references the URL of the reverse proxy is also required for MobileFirst Operations Console. See “Defining the endpoint of the MobileFirst Administration services” on page 6-78.

For detailed instructions to configure an IBM HTTP Server or a Data Store, see “Typical topologies of a MobileFirst instance in an extranet infrastructure” on page 6-239.

Planning the creation of the databases

You must plan the creation of the three databases that are needed for the Administration Services and the MobileFirst runtime environments.

Note: The Reports database, referenced below as `WorklightReports` and `WLREPORT`, is deprecated in V7.0.0. You should use “Operational analytics” on page 12-8 instead. Note that setting up the Reports database is optional in this release and prior releases.

The installation of the MobileFirst Server requires the following three databases:

- For the Administration Services, an administration database.
- For each MobileFirst runtime environment:
 - a runtime database
 - a reports database

Note: By default, the databases have the following names and kind attributes, as defined in table 1 of “Ant **configuredatabase** task reference” on page 14-1:

- The default name of the administration database is `WLADMIN`, and its kind is `WorklightAdmin`.
- The default name of the runtime database is `WRKLGHT`, and its kind is `Worklight`.
- The default name of the reports database is `WLREPORT`, and its kind is `WorklightReports`.

Optionally, the Application Center can be installed. The Application Center also requires a database.

An installation of MobileFirst Server includes at least one MobileFirst runtime environment, which is the web application that is in contact with the mobile devices, but might contain more than one MobileFirst runtime environment.

The databases can be instantiated automatically by the Server Configuration Tool or by the Ant tasks. In these two installation scenarios, it is also possible that a database administrator creates the database beforehand. For more information about the creation of these databases, see “Optional creation of the administration database” on page 6-43. For more information about the MobileFirst runtime environments, see “Optional creation of databases” on page 10-5.

For DB2, the administration, the runtime database, and the reports database can be in the same database, but they must be in different schemas.

For Oracle, these databases must be created for a different user.

For each database, it is possible to restrict the privileges of the database user that uses the data source at run time.

Restricting database user permissions for IBM MobileFirst Platform Server runtime operations:

When the databases are operational, you can decide to create a database user with restricted privileges. You use this database user to perform database underlying operations from the MobileFirst administration and runtime components. The user credentials appear in the application server configuration.

MobileFirst Server data is stored in three databases, which are described in “Introduction to the MobileFirst Server components” on page 6-5. The database administrator might require you to provide specific permissions that you need when you access those databases at run time. The connection to the MobileFirst Server databases at run time, which is established in the data source credentials, and any subsequent requests to the databases, are handled through a single database user or one distinct user per database. Using different users that can access only one kind of database, and especially to separate the databases of the MobileFirst runtime environment from the database of the MobileFirst administration component, improves security. These database users have no relation to the standard MobileFirst Server groups. The following table shows the minimal permissions that the database administrator must define on the MobileFirst Server databases for these users:

Table 6-9. Minimal permissions defined by the database administrator

Database permission	Use MobileFirst Server Operation
ALTER TABLE	Not required
CREATE INDEX	Not required
CREATE ROLE	Not required
CREATE SEQUENCE	Not required
CREATE TABLE	Not required
CREATE VIEW	Not required
DROP INDEX	Not required
DROP SEQUENCE	Not required
DROP TABLE	Not required
DROP VIEW	Not required
SELECT TABLE	Required
INSERT TABLE	Required

Table 6-9. Minimal permissions defined by the database administrator (continued)

Database permission	Use MobileFirst Server Operation
UPDATE TABLE	Required
DELETE TABLE	Required
SELECT SEQUENCE	Required

These minimal permissions also apply to the database user of the (optional) Application Center database.

Using complex Oracle connection descriptors:

For some topologies of the Oracle DBMS, for example Oracle Real Application Clusters (RAC), you might have to use complex Oracle Net connection descriptors. In that case, review the following steps.

Procedure

1. You must create the databases manually for the Application Center, the MobileFirst Server administration, and the MobileFirst project WAR file. This step is mandatory and cannot be performed with the Ant tasks or Server Configuration Tool. See the following links for instructions on how to create these databases.
 - For installing the Application Center, see “Creating the Oracle database for Application Center” on page 6-164.
 - For installing the MobileFirst Server administration, see “Creating the Oracle database for MobileFirst Server administration” on page 6-45.
 - For deploying the MobileFirst project WAR file, see “Creating the Oracle databases” on page 10-8.
2. In IBM Installation Manager, or in the Server Configuration Tool, you must use a generic Oracle JDBC URL instead of the host name and port.

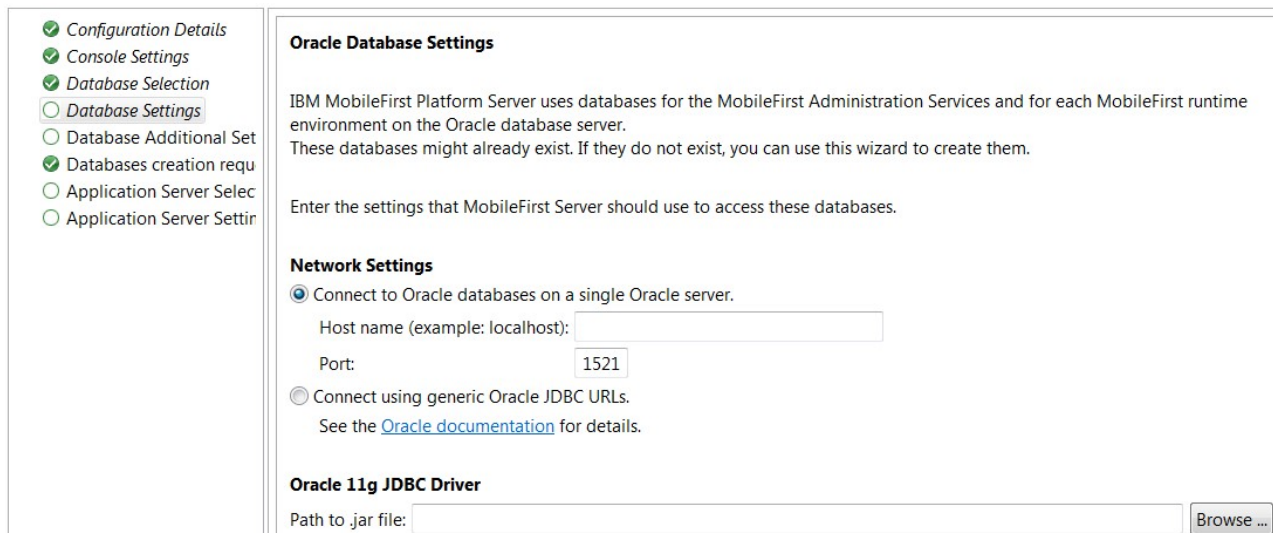

Figure 6-6. Oracle Database Settings window

3. For Ant tasks, you must use the alternative attributes for the <oracle> element. For more information, see “Ant **configuredatabase** task reference” on page 14-1, table 19.

Note: The example files in “Sample configuration files” on page 14-35 do not use the alternative attributes for the <oracle> element. If you use an example file, you must modify the <oracle> elements in the file so that they use the alternative attributes.

4. The URL must be a URL for the Oracle thin driver. It must not include the user name and password, for example: jdbc:oracle:thin:@(DESCRIPTION= [Oracle Net connection descriptor]).

Configuring DB2 HADR seamless failover for MobileFirst Server and Application Center data sources:

You must enable the seamless failover feature with WebSphere Application Server Liberty profile and WebSphere Application Server. With this feature, you can manage an exception when a database fails over and gets rerouted by the DB2 JDBC driver.

Note: DB2 HADR failover is not supported for Apache Tomcat.

By default with DB2 HADR, when the DB2 JDBC driver performs a client reroute after detecting that a database failed over during the first attempt to reuse an existing connection, the driver triggers `com.ibm.db2.jcc.am.ClientRerouteException`, with `ERRORCODE=-4498` and `SQLSTATE=08506`. WebSphere Application Server maps this exception to `com.ibm.websphere.ce.cm.StaleConnectionException` before it is received by the application.

In this case, the application would have to catch the exception and execute again the transaction. The MobileFirst and Application Center runtime environments do not manage the exception but rely on a feature that is called seamless failover. To enable this feature, you must set the **enableSeamlessFailover** JDBC property to "1".

WebSphere Application Server Liberty profile configuration

You must edit the `server.xml` file, and add the **enableSeamlessFailover** property to the `properties.db2.jcc` element of the MobileFirst and Application Center data sources. For example:

```
<dataSource jndiName="jdbc/WorklightAdminDS" transactional="false">
  <jdbcDriver libraryRef="DB2Lib"/>
  <properties.db2.jcc databaseName="WLADMIN" currentSchema="WLADMSC"
    serverName="db2server" portNumber="50000"
    enableSeamlessFailover= "1"
    user="worklight" password="worklight"/>
</dataSource>
```

WebSphere Application Server configuration

From the WebSphere Application Server administrative console for each MobileFirst and Application Center data source:

1. Go to **Resources > JDBC > Data sources > DataSource name**.
2. Select **New** and add the following custom property, or update the values if the properties already exist:
enableSeamlessFailover : 1
3. Click **Apply**.
4. Save your configuration.

For more information about how to configure a connection to an HADR-enabled DB2 database, see *Setting up a connection to an HADR-enabled DB2 database*.

Planning the topology of the application server

You must install MobileFirst Server in an application server, and decide which topology to use.

For more information about the choice of topology, see “Typical topologies of a MobileFirst instance in an extranet infrastructure” on page 6-239.

Tutorial for a basic installation of MobileFirst Server

Learn about the MobileFirst Server installation process by walking through a simple configuration that creates a functional MobileFirst Server for demonstration purposes or tests.

Before you begin

1. Install IBM MobileFirst Platform Command Line Interface for iOS on your computer, if you have not already done so.
2. Use MobileFirst Platform Command Line Interface for iOS to create a project, which you can then run on MobileFirst Server.

About this task

This task shows how to install MobileFirst Server, based on a tutorial of a simple configuration. It is designed as an overview, to show you where to find the following tools and information:

- Tools to install a MobileFirst Server and the Application Center, and tools to deploy a MobileFirst project.
- Information about configuring MobileFirst Server and the Application Center.
- Information about manual MobileFirst Server installation.

Note: Manual installation provides greater flexibility, but can make the diagnosis of issues more complex, and make the subsequent description of your configuration to IBM Support more difficult.

For this task, install the following components:

- An IBM WebSphere Application Server Liberty Core application server.
- A database management system (DBMS): IBM DB2, Oracle, or MySQL.
- The Application Center.
- A simple MobileFirst project and its console.

Procedure

1. Install WebSphere Application Server Liberty Core. The installer for WebSphere Application Server Liberty Core is provided as part of the package for IBM MobileFirst Platform Foundation for iOS.
 - a. Load the repository for WebSphere Application Server Liberty Core in IBM Installation Manager and install the product.

Note: IBM Installation Manager is sometimes referred to as *IBM Rational Enterprise Deployment* on the eXtreme Leverage, Passport Advantage sites, and on the distribution disks. The file names for the images take the form

IBM Rational Enterprise Deployment *<version number><hardware platform> <language>*; for example, IBM Rational Enterprise Deployment V1.6.3.1Windows Multilingual.

For more information about loading repositories with IBM Installation Manager, see step 4a of this procedure. See also the IBM Installation Manager user documentation at https://www.ibm.com/support/knowledgecenter/SSDV2W_1.7.0/com.ibm.cic.agent.ui.doc/helpindex_imic.html.

- b. During the installation process, take note of the installation directory of Liberty.

You need this information later on in the procedure.

2. Create a server for Liberty.

You use this server to install the Application Center and to deploy a MobileFirst project and its console.

- a. Go to the installation directory of Liberty. For example, on Windows, if the product is installed with administrator rights, it is located by default in C:\Program Files\IBM\WebSphere\Liberty.
- b. Type the command that creates a server.
In this scenario, the server name is simpleServer.

On UNIX and Linux systems:

```
bin/server create simpleServer
```

On Windows systems:

```
bin\server.bat create simpleServer
```

The server is created with all default settings. For more information about configuring a Liberty server, read the file README.txt in the Liberty installation directory. Default settings are sufficient for this tutorial.

3. Install the database management system.

You use this DBMS to install the Application Center and to deploy a MobileFirst project and its console.

- If you use IBM DB2, the installer for IBM DB2 is provided as part of the package for IBM MobileFirst Platform Foundation for iOS.
 - a. Run the installer and follow the instructions.
 - b. On Windows, when you are asked whether to install the IBM Secure Shell Server for Windows, say Yes.
 - c. In the following steps, you must have a Secure Shell server installed and running so that the MobileFirst tools can create the required databases.
 - On Windows, the IBM Secure Shell Server for Windows or the Cygwin openssh package, as described at http://docs.oracle.com/cd/E25178_01/install.1111/e22624/preinstall_req_cygwin_ssh.htm
 - On UNIX, the sshd daemon
 - d. Take note of the user name and password for the DB2 administrator role.
- If you use MySQL:
 - a. Install MySQL on your computer.
 - b. Take note of the user name and password for the administrator.
 - By default for some installations, the administrator is root and there is no password.
 - If there is no password for the MySQL administrator in your installation, set a password for the administrator, following the instructions from the MySQL documentation.

- If you use Oracle:
 - a. Install the Oracle database on your computer.
 - b. Install an ssh shell on your computer. On Windows, install cygwin and the openssh package.
 - c. Start the ssh server. On Windows, you need administrator rights.
 - d. In subsequent steps, you must have that Secure Shell server running.
- 4. Install MobileFirst Server.
 - a. Add the MobileFirst Server repository in IBM Installation Manager:
 - 1) Download the **Installation Manager Repository for IBM MobileFirst Platform Server** from Passport Advantage.
 - 2) Extract the file on your disk.
 - 3) Start IBM Installation Manager.
 - 4) Open the **File > Preferences** menu.
 - 5) In the Preferences dialog, click **Add Repositories**.
 - 6) Select the file `disk1/diskTag.inf` from the repository directory you extracted.
 - 7) Click **OK** and close the Preferences dialog.
 - b. Load the repository for MobileFirst Server in IBM Installation Manager and install the product.
 - 1) In the **Configuration Choice** panel, select the first choice. This option installs Application Center.
 - 2) In the **Database Choice** panel, select the name of the database management system you installed.

Restriction: Apache Derby is not supported by the Server Configuration Tool , which is used later in this tutorial.

- 3) In the following database panels of the installer:
 - If you use IBM DB2:
 - In the **Database Server Properties** panel:
 - Enter `localhost` as the **host name**.
 - Select the `db2jcc4.jar` JAR file in the JDBC driver directory (in `<DB2InstallDir>/Java`).
 - In the **Database Server Additional Properties** panel:
 - Select **Simple Mode**.
 - Enter a database user and password. This user must already exist.
 - In the **Create Database** panel:
 - Enter the name and password of a user account on the database server that has DB2 privilege SYSADM or SYSCTRL.
 - The installer creates the database.
 - If you use MySQL:
 - In the **Database Server Properties** panel:
 - Enter `localhost` as the **host name**.
 - Enter the name of the JDBC JAR file for MySQL.
 - In the **Database Server Additional Properties** panel:
 - Select **Simple Mode**.

- Enter a database user and password. This user is already created by the installer.
 - In the **Create Database** panel:
 - Enter the name and password of a superuser account in your MySQL database server. The default superuser account is root.
 - The installer creates the database.
 - If you use Oracle:
 - In the **Database Server Properties** panel:
 - Enter localhost as the **host name**.
 - Enter the name of the JDBC JAR file for Oracle.
 - In the **Database Server Additional Properties** panel:
 - Select **Simple Mode**.
 - Enter a password for the user APPCENTER. This user is created by the installer.
 - The installer creates a database if it does not already exist.
 - In the **Create Database** panel:
 - For **Administrator Login Name and Passwords**, enter an administrator login name and password that can be used to run an ssh session. The default Oracle Administrator Login name is oracle.
 - If the database already exists, provide the password of the SYSTEM user that is used to create the user APPCENTER. If the database does not already exist, enter the passwords for the SYS and SYSTEM users that are created to manage the database.
- 4) In the **Application Server Selection** panel, select **WebSphere Application Server**.
 - 5) In the **Application Server Configuration** panel, select the installation directory for IBM WebSphere Application Server Liberty Core that is installed in step 2.
 - 6) Select **simpleServer** as the server name.
 - 7) Install the product.

The files that are described in “Distribution structure of MobileFirst Server” on page 6-39 are installed on your computer.

5. Explore Application Center. Application Center is now functional. The artifacts of the Application Center are deployed into the Liberty server, which now includes the features that Application Center requires, and a demonstration user account exists. The required database also exists.
 - a. To test the Application Center, start the Liberty server.

On UNIX and Linux systems:

```
bin/server start simpleServer
```

On Windows systems:

```
bin\server.bat start simpleServer
```

- b. Open the Application Center by using the program shortcut that the installer creates: **IBM MobileFirst Platform Server > Application Center**. Alternatively, you can enter the URL for the Application Center into a browser window. When a Liberty server is created with default settings, the default URL for Application Center is `http://localhost:9080/appcenterconsole/`.

- c. Log in to the Application Center with the demonstration account credentials (login: demo, password: demo)
 - d. Explore further by using any of the following resources:
 - See “Configuring the Application Center after installation” on page 6-188.
 - See “Distribution structure of MobileFirst Server” on page 6-39 for a list of MobileFirst applications that you can compile and upload to the Application Center. These applications provide access to the Application Center for mobile devices.
 - If you are considering a manual installation of Application Center, see “Manual installation of Application Center” on page 6-168. In some cases, manual installations can make the diagnosis of issues more complex, and can make the description of a configuration to IBM Support more difficult.
6. Install the MobileFirst Server administration components: Administration Services and MobileFirst Operations Console.
- a. Start the Server Configuration Tool.
 - On Linux:
 - Click the desktop menu **IBM MobileFirst Platform Server > Server Configuration Tool**.
 - On Windows:
 - Click the **Start** menu **IBM MobileFirst Platform Server > Server Configuration Tool**.
 - On Mac OS X:
 - In the Finder, double-click the file `mf_server_install_dir/shortcuts/configuration-tool.sh`.

Restriction: MobileFirst Server is not supported for production use on Mac OS X.

mf_server_install_dir is the directory where you install MobileFirst Server.
mf_server is the shortcut for MobileFirst Server.

- b. Select **Create a MobileFirst Server Configuration**.
- c. Name the configuration Hello MobileFirst Server.
- d. Do not change the default entries in the **Configuration Description** panel.
- e. Do not change the default entries in the **Console Settings** panel.
- f. In the **Database Properties** panel:
 - 1) Select your database.
 - 2) Proceed as described in the *Install MobileFirst Server* section when you entered data to create the database for Application Center.
- g. In the **Application Server** panel:
 - Proceed as described in the *Install MobileFirst Server* section when you entered data to create the database for Application Center.
 - Take note of the default password and login: demo (for both).
- h. When all the data is entered, click **Deploy**.
 - The log of the deployment operations appears in the console.
 - The **Configuration** appears in the tree view.
 - After the database operation is completed, a log file that is named databases appears in the tree view, under the **Configuration**.

- After the deployment to the application server is complete, a log file that is named `install` appears in the tree view, under the **Configuration**.
7. Create a simple MobileFirst project. You create a MobileFirst runtime environment.
 - a. Install command-line tools for developers on your computer. See “Installing command-line tools for developers” on page 6-2.
 - b. Use the **Create** command to create a MobileFirst project. Assign the name `simpleProject`, and name the application `simpleApp`.
 - c. Use the **Build** command to build the application.
 8. Deploy a MobileFirst runtime environment with the Server Configuration Tool.
 - a. In the Server Configuration Tool, select **File/Add MobileFirst runtime environment**
 - b. In the dialog box, select the **Hello MobileFirst Server** configuration created in step 6.
 - c. In **Enter the name of the new runtime**, enter `First Runtime`.
 - d. In the **MobileFirst runtime environment Configuration Description** panel:
 - Load the WAR file that you created in the previous step.
 - e. In the **Database Properties** panel:
 - 1) Select your database.
 - 2) Proceed as described in the *Install MobileFirst Server* section when you entered data to create the database for Application Center.
 - f. When all the data is entered, click **Deploy**.
 - The log of the deployment operations appears in the console.
 - The **Runtime** appears in the tree view.
 - After the database operation is completed, a log file that is named `databases` appears in the tree view, under the **Configuration**.
 - After the deployment to the application server is complete, a log file that is named `install` appears in the tree view, under the **Configuration**.
 9. Restart the Liberty server and open the MobileFirst Operations Console.
 - a. Go to the Liberty installation directory. Type the following command:
 - On Linux and UNIX systems:
`bin/server stop simpleServer`
 - On Windows systems:
`bin\server.bat stop simpleServer`
 - b. Restart the server with the following command:
 - On Linux and UNIX systems:
`bin/server start simpleServer`
 - On Windows systems:
`bin\server.bat start simpleServer`
 - c. In the shortcut directory that you specified in the **MobileFirst runtime environment Configuration Description** panel of the Server Configuration Tool:
 - On Linux and UNIX systems:
Run the `mobilefirst-console.sh` script.
 - On Windows systems:
Double-click the file `mobilefirst-console.url`. (On Windows 7, this shortcut can appear as `mobilefirst-console`, with a file type of Internet Shortcut.)

You see the MobileFirst Operations Console. You can log in with the default user login and password that you created in step 6 (by default demo/demo).

What to do next

For more information about the Server Configuration Tool, see “Deploying, updating, or undeploying MobileFirst Server by using the Server Configuration Tool” on page 10-9.

If you want to explore the MobileFirst Operations Console further, you can complete the following tasks:

- Deploy an application as described in “Deploying applications and adapters to MobileFirst Server” on page 10-76.
- Review “Administering MobileFirst applications” on page 11-1.
- Review “Deploying the project WAR file” on page 10-5.
- Review “Configuration of MobileFirst applications on the server” on page 10-48 and “Configuring a MobileFirst project in production by using JNDI environment entries” on page 10-60
- Review the options to deploy an IBM MobileFirst Platform Foundation for iOS project manually. In some cases, manual installations can make the diagnosis of issues more complex, and can make the description of a configuration to IBM Support more difficult. See “Deploying a project WAR file and configuring the application server manually” on page 10-39.

Running IBM Installation Manager

IBM Installation Manager installs the IBM MobileFirst Platform Foundation for iOS files and tools on your computer.

IBM Installation Manager helps you install, update, modify, and uninstall packages on your computer. The installer for MobileFirst Server does not support rollback operations and updates from one version to another cannot be undone.

The way that you use IBM Installation Manager to upgrade from a previous release depends on your upgrade path.

You can use IBM Installation Manager to install IBM MobileFirst Platform Foundation for iOS in several different modes, including single-user and multi-user installation modes.

You can also use silent installations to deploy IBM MobileFirst Platform Foundation for iOS to multiple systems, or systems without a GUI interface.

For more information about Installation Manager, see the IBM Installation Manager user documentation.

Note: IBM Installation Manager is sometimes referred to as *IBM Rational Enterprise Deployment* on the eXtreme Leverage, Passport Advantage sites, and on the distribution disks. The file names for the images take the form *IBM Rational Enterprise Deployment <version number><hardware platform> <language>*; for example, *IBM Rational Enterprise Deployment V1.6.3.1Windows Multilingual*.

Installation of the Application Center with IBM Installation Manager

Run IBM Installation Manager. If you plan to install the Application Center with IBM Installation Manager, verify that the user who runs IBM Installation Manager has the privileges that are described in “File system prerequisites” on page 6-5, then see “Installing and configuring the Application Center” on page 6-162 and install the Application Center before you proceed to the installation of MobileFirst Operations Console. For more information, see “Installing the MobileFirst Server administration” on page 6-43.

If you do not plan to install the Application Center with IBM Installation Manager, or if you plan to install the Application Center manually, answer **No** to the question **Install IBM Application Center**.

Single-user versus multi-user installations

You can install MobileFirst Server in two different IBM Installation Manager modes.

Administrator installation

It is an administrator installation when IBM Installation Manager is installed through the **install** command. In this case, it requires administrator privileges to run, and it produces multi-user installations of products.

When you have chosen an administrator installation of MobileFirst Server, it is advisable to run the application server from a non-administrator user account. Running it from an administrator or root user account is dangerous in terms of security risks.

Because of this, during an administrator installation of MobileFirst Server, you can choose an operating system user or an operating system user group. Each of the users in this group can:

- Run the specified application server (if WebSphere Application Server Liberty, or Apache Tomcat).
- Modify the Application Center Derby database (if Apache Derby is chosen as your database management system).

In this case, the MobileFirst Server installer sets restrictive access permissions on the Liberty or Tomcat configuration files, so as to:

1. Allow the specified users to run the application server.
2. At the same time, protect the database or user passwords that these files contain.

Nonadministrator (single-user) installation

It is a nonadministrator (single-user) installation when IBM Installation Manager is installed through the **userinst** command. In this case, only the user who installed this copy of IBM Installation Manager can use it.

The following constraints regarding user accounts on UNIX apply:

- If the application server is owned by a non-root user, you can install MobileFirst Server in either of two ways:
 - Through a nonadministrator (single-user) installation of IBM Installation Manager, as the same non-root user.
 - Through an administrator installation of IBM Installation Manager, as root, and afterward change the owner of all files and directories added or modified during the installation to that user. The result is a single-user installation.

- If the application server is owned by root, you can install MobileFirst Server only through an administrator installation of IBM Installation Manager; a single-user installation of IBM Installation Manager does not work, because it lacks the necessary privileges.

Note: MobileFirst Server does not support the group mode of IBM Installation Manager.

Installing a new version of MobileFirst Server

Create a fresh installation of IBM MobileFirst Platform Server by creating a new package group in IBM Installation Manager.

Procedure

1. Start IBM Installation Manager.
2. On the IBM Installation Manager main page, click **Install**.
3. In the panel that prompts for the package group name and the installation directory, select **Create a new package group**.
4. Complete the installation by following the instructions that are displayed.

Upgrading MobileFirst Server from a previous release

The way that you use IBM Installation Manager to upgrade to the latest version of MobileFirst Server depends on your upgrade path.

Before you begin

Before you apply these instructions, see “Upgrading to IBM MobileFirst Platform Foundation for iOS V7.0.0” on page 7-1. It describes important steps to upgrade MobileFirst applications, or to upgrade a production server in a production environment.

Procedure

1. Start the IBM Installation Manager.
2. Depending on your upgrade path, take one of the following actions:
 - To upgrade from Worklight[®] Server to MobileFirst Server:
 - a. Click **Install**.
 - b. In the panel that prompts for the package group name and the installation directory, select **Use the existing package group**. In this situation, installation MobileFirst Server automatically removes a Worklight Server installation that was installed in the same directory.
 - To upgrade from MobileFirst Server to a newer version, click **Update**.

Command-line installation with XML response files (silent installation)

With IBM Installation Manager, you can complete a command-line installation of MobileFirst Server with XML response files, on multiple computers, or on computers where a GUI interface is not available. In the following documentation, this installation is referred to as silent installation.

About this task

Silent installation uses predetermined answers to wizard questions, rather than presenting a GUI that asks the questions and records the answers. Silent installation is useful when:

- You want to install MobileFirst Server on a set of computers that are configured in the same way.
- You want to install MobileFirst Server on a computer where a GUI is not readily available. For example, a GUI might not be available on a production server behind a firewall that prevents the use of VNC, RDP, remote X11, and ssh -X.

Silent installations are defined by an XML file that is called a response file. This file contains the necessary data to complete installation operations silently. Silent installations are started from the command line or a batch file.

You can use IBM Installation Manager to record preferences and installation actions for your response file in user interface mode. Alternatively, you can create a response file manually by using the documented list of response file commands and preferences.

You can use one response file to install, update, or uninstall multiple products.

You can use a response file to do almost anything that is possible by using IBM Installation Manager in wizard mode. For example, with a response file you can specify the location of the repository that contains the package, the package to install, and the features to install for that package. You can also use a response file to apply updates or interim fixes or to uninstall a package.

Silent installation is described in the IBM Installation Manager user documentation, see *Working in silent mode*.

There are two ways to create a suitable response file:

- Working with sample response files provided in the MobileFirst user documentation.
- Working with a response file recorded on a different computer.

Both of these methods are documented in the following sections.

In addition, for a list of the parameters that are created in the response file by the IBM Installation Manager wizard, see “Command-line (silent installation) parameters” on page 6-35.

Working with sample response files for IBM Installation Manager:

Instructions for working with sample response files for IBM Installation Manager to facilitate creating a silent MobileFirst Server installation.

Procedure

Sample response files for IBM Installation Manager are provided in the `Silent_Install_Sample_Files.zip` compressed file. The following procedures describe how to use them.

1. Pick the appropriate sample response file from the compressed file. The `Silent_Install_Sample_Files.zip` file contains one subdirectory per release.

Important: For an installation that does not install Application Center on an application server, use the file named `install-no-appcenter.xml`.

For an installation that installs Application Center, pick the sample response file from the following table, depending on your application server and database.

Table 6-10. Sample installation response files in the *Silent_Install_Sample_Files.zip* file to install the Application Center

Application server where you install the Application Center	Derby	IBM DB2	MySQL	Oracle
WebSphere Application Server Liberty profile	install-liberty-derby.xml	install-liberty-db2.xml	install-liberty-mysql.xml (See Note)	install-liberty-oracle.xml
WebSphere Application Server full profile, stand-alone server	install-was-derby.xml	install-was-db2.xml	install-was-mysql.xml (See Note)	install-was-oracle.xml
WebSphere Application Server Network Deployment	n/a	install-wasnd-cluster-db2.xml install-wasnd-server-db2.xml install-wasnd-node-db2.xml install-wasnd-cell-db2.xml	install-wasnd-cluster-mysql.xml (See Note) install-wasnd-server-mysql.xml (See Note) install-wasnd-node-mysql.xml install-wasnd-cell-mysql.xml (See Note)	install-wasnd-cluster-oracle.xml install-wasnd-server-oracle.xml install-wasnd-node-oracle.xml install-wasnd-cell-oracle.xml
Apache Tomcat	install-tomcat-derby.xml	install-tomcat-db2.xml	install-tomcat-mysql.xml	install-tomcat-oracle.xml

Note: MySQL in combination with WebSphere Application Server Liberty profile or WebSphere Application Server full profile is not classified as a supported configuration. For more information, see WebSphere Application Server Support Statement. You can use IBM DB2 or another DBMS that is supported by WebSphere Application Server to benefit from a configuration that is fully supported by IBM Support.

For uninstallation, use a sample file that depends on the version of MobileFirst Server or Worklight Server that you initially installed in the particular package group:

- MobileFirst Server uses the package group **IBM MobileFirst Platform Server**.
- Worklight Server V6.x, or later, uses the package group **IBM Worklight**.
- Worklight Server V5.x uses the package group **Worklight**.

Table 6-11. Sample uninstallation response files in the *Silent_Install_Sample_Files.zip*

Initial version of MobileFirst Server	Sample file
Worklight Server V5.x	uninstall-initially-worklightv5.xml

Worklight Server V6.x	uninstall-initially-worklightv6.xml
IBM MobileFirst Platform Server V6.x or later	uninstall-initially-mfpserver.xml

- Change the file access rights of the sample file to be as restrictive as possible. Step 4 requires that you supply some passwords. If you must prevent other users on the same computer from learning these passwords, you must remove the read permissions of the file for users other than yourself. You can use a command, such as the following examples:

- On UNIX:

```
chmod 600 <target-file.xml>
```

- On Windows:

```
cacls <target-file.xml> /P Administrators:F %USERDOMAIN%\%USERNAME%:F
```

- Similarly, if the server is a WebSphere Application Server Liberty profile or Apache Tomcat server, and the server is meant to be started only from your user account, you must also remove the read permissions for users other than yourself from the following file:

- For WebSphere Application Server Liberty profile: wlp/usr/servers/<server>/server.xml
- For Apache Tomcat: conf/server.xml

- Adjust the list of repositories, in the <server> element. For more information about this step, see section named *Information about the repositories* in “Become familiar with IBM Installation Manager before you start” on page 7-18 and the IBM Installation Manager documentation at [Repositories](#).

In the <profile> element, adjust the values of each key/value pair.

In the <offering> element in the <install> element, set the version attribute to match the release you want to install, or remove the version attribute if you want to install the newest version available in the repositories.

- Type the following command:

```
<InstallationManagerPath>/eclipse/tools/imcl input <responseFile>  
-log /tmp/installwl.log -acceptLicense
```

Where:

- <InstallationManagerPath> is the installation directory of IBM Installation Manager.
- <responseFile> is the name of the file that is selected and updated in step 1.

For more information, see the IBM Installation Manager documentation at [Installing a package silently by using a response file](#).

Working with a response file recorded on a different machine:

Instructions for working with response files for IBM Installation Manager created on another machine to facilitate creating a silent MobileFirst Server installation.

Procedure

- Record a response file, by running IBM Installation Manager in wizard mode and with option `-record responseFile` on a machine where a GUI is available. For more details, see [Record a response file with Installation Manager](#).
- Change the file access rights of the response file to be as restrictive as possible. Step 4 requires that you supply some passwords. If you must prevent other users on the same computer from learning these passwords, you must remove

the read permissions of the file for users other than yourself. You can use a command, such as the following examples:

- On UNIX:
`chmod 600 response-file.xml`
 - On Windows:
`cacls response-file.xml /P Administrators:F %USERDOMAIN%\%USERNAME%:F`
3. Similarly, if the server is a WebSphere Application Server Liberty or Apache Tomcat server, and the server is meant to be started only from your user account, you must also remove the read permissions for users other than yourself from the following file:
 - For WebSphere Application Server Liberty: `wlp/usr/servers/<server>/server.xml`
 - For Apache Tomcat: `conf/server.xml`
 4. Modify the response file to take into account differences between the machine on which the response file was created and the target machine.
 5. Install MobileFirst Server by using the response file on the target machine, as described in Install a package silently by using a response file.

Command-line (silent installation) parameters:

The response file that you create for silent installations by running the IBM Installation Manager wizard supports a number of parameters.

Table 6-12. Parameters available for silent installation

Key	When necessary	Description	Allowed values
<code>user.appserver.selection2</code>	Always	Type of application server. <code>was</code> means preinstalled WebSphere Application Server 7.0, 8.0, or 8.5. <code>tomcat</code> means Tomcat 7.0 or newer.	<code>was</code> , <code>tomcat</code> , <code>none</code> The value <code>none</code> means that the installer will not install the Application Center. If this value is used, both <code>user.appserver.selection2</code> and <code>user.database.selection2</code> must take the value <code>none</code> .
<code>user.appserver.was.installdir</code>	<code>\${user.appserver.selection2} == was</code>	WebSphere Application Server installation directory.	An absolute directory name.
<code>user.appserver.was.profile</code>	<code>\${user.appserver.selection2} == was</code>	Profile into which to install the applications. For WebSphere Application Server Network Deployment, specify the Deployment Manager profile. Liberty means the Liberty profile (subdirectory <code>wlp</code>).	The name of one of the WebSphere Application Server profiles.
<code>user.appserver.was.cell</code>	<code>\${user.appserver.selection2} == was && \${user.appserver.was.profile} != Liberty</code>	WebSphere Application Server cell into which to install the applications.	The name of the WebSphere Application Server cell.
<code>user.appserver.was.node</code>	<code>\${user.appserver.selection2} == was && \${user.appserver.was.profile} != Liberty</code>	WebSphere Application Server node into which to install the applications. This corresponds to the current machine.	The name of the WebSphere Application Server node of the current machine.

Table 6-12. Parameters available for silent installation (continued)

Key	When necessary	Description	Allowed values
<code>user.appserver.was.scope</code>	<code>\${user.appserver.selection2} == was && \${user.appserver.was.profile} != Liberty</code>	Type of set of servers into which to install the applications. <code>server</code> means a standalone server. <code>nd-cell</code> means a WebSphere Application Server Network Deployment cell. <code>nd-cluster</code> means a WebSphere Application Server Network Deployment cluster. <code>nd-node</code> means a WebSphere Application Server Network Deployment node (excluding clusters). <code>nd-server</code> means a managed WebSphere Application Server Network Deployment server.	<code>server</code> , <code>nd-cell</code> , <code>nd-cluster</code> , <code>nd-node</code> , <code>nd-server</code>
<code>user.appserver.was.serverInstance</code>	<code>\${user.appserver.selection2} == was && \${user.appserver.was.profile} != Liberty && \${user.appserver.was.scope} == server</code>	Name of WebSphere Application Server server into which to install the applications.	The name of a WebSphere Application Server server on the current machine.
<code>user.appserver.was.nd.cluster</code>	<code>\${user.appserver.selection2} == was && \${user.appserver.was.profile} != Liberty && \${user.appserver.was.scope} == nd-cluster</code>	Name of WebSphere Application Server Network Deployment cluster into which to install the applications.	The name of a WebSphere Application Server Network Deployment cluster in the WebSphere Application Server cell.
<code>user.appserver.was.nd.node</code>	<code>\${user.appserver.selection2} == was && \${user.appserver.was.profile} != Liberty && (\${user.appserver.was.scope} == nd-node \${user.appserver.was.scope} == nd-server)</code>	Name of WebSphere Application Server Network Deployment node into which to install the applications.	The name of a WebSphere Application Server Network Deployment node in the WebSphere Application Server cell.
<code>user.appserver.was.nd.server</code>	<code>\${user.appserver.selection2} == was && \${user.appserver.was.profile} != Liberty && \${user.appserver.was.scope} == nd-server</code>	Name of WebSphere Application Server Network Deployment server into which to install the applications.	The name of a WebSphere Application Server Network Deployment server in the given WebSphere Application Server Network Deployment node.
<code>user.appserver.was.admin.name</code>	<code>\${user.appserver.selection2} == was && \${user.appserver.was.profile} != Liberty</code>	Name of WebSphere Application Server administrator.	
<code>user.appserver.was.admin.password2</code>	<code>\${user.appserver.selection2} == was && \${user.appserver.was.profile} != Liberty</code>	Password of WebSphere Application Server administrator, optionally encrypted in a specific way.	
<code>user.appserver.was.appcenteradmin.password</code>	<code>\${user.appserver.selection2} == was && \${user.appserver.was.profile} != Liberty</code>	Password of <code>appcenteradmin</code> user to add to the WebSphere Application Server users list, optionally encrypted in a specific way.	

Table 6-12. Parameters available for silent installation (continued)

Key	When necessary	Description	Allowed values
<code>user.appserver.was.serial</code>	<code>\$(user.appserver.selection2) == was && \$(user.appserver.was.profile) != Liberty</code>	Suffix that distinguishes the applications to be installed from other installations of MobileFirst Server.	String of 10 decimal digits.
<code>user.appserver.was85liberty.serverInstance_</code>	<code>\$(user.appserver.selection2) == was && \$(user.appserver.was.profile) == Liberty</code>	Name of WebSphere Application Server Liberty server into which to install the applications.	
<code>user.appserver.tomcat.installDir</code>	<code>\$(user.appserver.selection2) == tomcat</code>	Apache Tomcat installation directory. For a Tomcat installation that is split between a <code>CATALINA_HOME</code> directory and a <code>CATALINA_BASE</code> directory, here you need to specify the value of the <code>CATALINA_BASE</code> environment variable.	An absolute directory name.
<code>user.database.selection2</code>	Always	Type of database management system used to store the databases.	derby, db2, mysql, oracle, none The value none means that the installer will not install the Application Center. If this value is used, both <code>user.appserver.selection2</code> and <code>user.database.selection2</code> must take the value none.
<code>user.database.preinstalled</code>	Always	true means a preinstalled database management system, false means Apache Derby to install.	true, false
<code>user.database.derby.datadir</code>	<code>\$(user.database.selection2) == derby</code>	The directory in which to create or assume the Derby databases.	An absolute directory name.
<code>user.database.db2.host</code>	<code>\$(user.database.selection2) == db2</code>	The host name or IP address of the DB2 database server.	
<code>user.database.db2.port</code>	<code>\$(user.database.selection2) == db2</code>	The port where the DB2 database server listens for JDBC connections. Usually 50000.	A number between 1 and 65535.
<code>user.database.db2.driver</code>	<code>\$(user.database.selection2) == db2</code>	The absolute file name of <code>db2jcc.jar</code> or <code>db2jcc4.jar</code> .	An absolute file name.
<code>user.database.db2.appcenter.username</code>	<code>\$(user.database.selection2) == db2</code>	The user name used to access the DB2 database for Application Center.	Non-empty.
<code>user.database.db2.appcenter.password</code>	<code>\$(user.database.selection2) == db2</code>	The password used to access the DB2 database for Application Center, optionally encrypted in a specific way.	Non-empty password.
<code>user.database.db2.appcenter.dbname</code>	<code>\$(user.database.selection2) == db2</code>	The name of the DB2 database for Application Center.	Non-empty; a valid DB2 database name.

Table 6-12. Parameters available for silent installation (continued)

Key	When necessary	Description	Allowed values
<code>user.database.oracle.appcenter.isservicename.jdbc.url</code>	Optional	Indicates if <code>user.database.mysql.appcenter.dbname</code> is a Service name or a SID name. If the parameter is absent then <code>user.database.mysql.appcenter.dbname</code> is considered to be a SID name.	true (indicates a Service name) or false (indicates a SID name)
<code>user.database.db2.appcenter.schema</code>	<code>\$(user.database.selection2) == db2</code>	The name of the schema for Application Center in the DB2 database.	
<code>user.database.mysql.host</code>	<code>\$(user.database.selection2) == mysql</code>	The host name or IP address of the MySQL database server.	
<code>user.database.mysql.port</code>	<code>\$(user.database.selection2) == mysql</code>	The port where the MySQL database server listens for JDBC connections. Usually 3306.	A number between 1 and 65535.
<code>user.database.mysql.driver</code>	<code>\$(user.database.selection2) == mysql</code>	The absolute file name of <code>mysql-connector-java-5.*-bin.jar</code> .	An absolute file name.
<code>user.database.mysql.appcenter.username</code>	<code>\$(user.database.selection2) == mysql</code>	The user name used to access the MySQL database for Application Center.	Non-empty.
<code>user.database.mysql.appcenter.password</code>	<code>\$(user.database.selection2) == mysql</code>	The password used to access the MySQL database for Application Center, optionally encrypted in a specific way.	
<code>user.database.mysql.appcenter.dbname</code>	<code>\$(user.database.selection2) == mysql</code>	The name of the MySQL database for Application Center.	Non-empty, a valid MySQL database name.
<code>user.database.oracle.host</code>	<code>\$(user.database.selection2) == oracle</code> , unless <code>\$(user.database.oracle.appcenter.jdbc.url)</code> is specified	The host name or IP address of the Oracle database server.	
<code>user.database.oracle.port</code>	<code>\$(user.database.selection2) == oracle</code> , unless <code>\$(user.database.oracle.appcenter.jdbc.url)</code> is specified	The port where the Oracle database server listens for JDBC connections. Usually 1521.	A number between 1 and 65535.
<code>user.database.oracle.driver</code>	<code>\$(user.database.selection2) == oracle</code>	The absolute file name of <code>ojdbc6.jar</code> .	An absolute file name.
<code>user.database.oracle.appcenter.username</code>	<code>\$(user.database.selection2) == oracle</code>	The user name used to access the Oracle database for Application Center.	A string consisting of 1 to 30 characters: ASCII digits, ASCII uppercase and lowercase letters, '_', '#', '\$' are allowed.
<code>user.database.oracle.appcenter.username.jdbc</code>	<code>\$(user.database.selection2) == oracle</code>	The user name used to access the Oracle database for Application Center, in a syntax suitable for JDBC.	Same as <code>\$(user.database.oracle.appcenter.username)</code> if it starts with an alphabetic character and does not contain lowercase characters, otherwise it must be <code>\$(user.database.oracle.appcenter.username)</code> surrounded by double quotes.

Table 6-12. Parameters available for silent installation (continued)

Key	When necessary	Description	Allowed values
<code>user.database.oracle.appcenter.password</code>	<code>\${user.database.selection2} == oracle</code>	The password used to access the Oracle database for Application Center, optionally encrypted in a specific way.	The password must be a string consisting of 1 to 30 characters: ASCII digits, ASCII uppercase and lowercase letters, '_', '#', '\$' are allowed.
<code>user.database.oracle.appcenter.dbname</code>	<code>\${user.database.selection2} == oracle</code> , unless <code>\${user.database.oracle.appcenter.jdbc.url}</code> is specified	The name of the Oracle database for Application Center.	Non-empty, a valid Oracle database name.
<code>user.database.oracle.appcenter.isservicename.jdbc.url</code>	Optional	Indicates if <code>user.database.oracle.appcenter.dbname</code> is a Service name or a SID name. If the parameter is absent then <code>user.database.oracle.appcenter.dbname</code> is considered to be a SID name.	true (indicates a Service name) or false (indicates a SID name)
<code>user.database.oracle.appcenter.jdbc.url</code>	<code>\${user.database.selection2} == oracle</code> , unless <code>\${user.database.oracle.host}</code> , <code>\${user.database.oracle.port}</code> , <code>\${user.database.oracle.appcenter.dbname}</code> are all specified	The JDBC URL of the Oracle database for Application Center.	A valid Oracle JDBC URL. Starts with "jdbc:oracle:".
<code>user.writable.data.user</code>	Always	The operating system user that is allowed to run the installed server.	An operating system user name, or empty.
<code>user.writable.data.group2</code>	Always	The operating system users group that is allowed to run the installed server.	An operating system users group name, or empty.

Distribution structure of MobileFirst Server

The MobileFirst Server files and tools are installed in the MobileFirst Server installation directory.

Table 6-13. Files and subdirectories in the MobileFirst Server installation directory

Item	Description
shortcuts	Launcher scripts for Apache Ant, the MobileFirst Server Server Configuration Tool, and the <code>wladm</code> command, which are supplied with MobileFirst Server.

Table 6-14. Files and subdirectories in the WorklightServer subdirectory

Item	Description
<code>worklight-jee-library.jar</code>	The MobileFirst Server library for production. For instructions on deploying a MobileFirst project and this library to an Application Server, see "Deploying MobileFirst projects" on page 10-1. The deployment is typically performed by using Ant tasks, but instructions for manual deployment are also provided.

Table 6-14. Files and subdirectories in the WorklightServer subdirectory (continued)

Item	Description
worklight-ant-deployer.jar	A set of Ant tasks that help you deploy projects, applications, and adapters to your MobileFirst Server. For documentation about the Ant tasks that are provided in this library, see “Deploying MobileFirst projects” on page 10-1.
worklight-ant-builder.jar	A set of Ant tasks that help you build projects, applications, and adapters for use in MobileFirst Server. For more information about the Ant tasks that are provided in this library, see Ant tasks for building and deploying applications and adapters.
configuration-samples	Contains the sample Ant files for configuring a database for the MobileFirst Server and deploying a MobileFirst project to an Application Server. For instructions on how to use these Ant projects, see “Sample configuration files” on page 14-35.
databases	SQL scripts to be used for the manual creation of tables for MobileFirst Server and the Administration Services, instead of using Ant tasks for the automatic configuration of these tables. For information about these scripts, see “Creating and configuring the databases manually” on page 10-17.
encrypt.bat and encrypt.sh	Tools to encrypt confidential properties that are used to configure a MobileFirst Server, such as a database password or a certificate. For information about this tool, see “Storing properties in encrypted format” on page 10-56.
report-templates	Report templates to configure BIRT reports for your Application Server. For information about these BIRT reports, see “Manually configuring BIRT Reports for your application server” on page 12-90.
wladm-schemas	XML schemas that describe the format of input and output of the <wladm> Ant task.
worklightadmin.war	The WAR file for the Administration Services web application.
worklightconsole.war	The WAR file for the MobileFirst Operations Console user interface web application.
external-server-libraries	JAR file and manifest file of the OAuth Trust Association Interceptor (TAI) that is used to protect application resources on WebSphere® Application Server or WebSphere Application Server Liberty. For more information, see “Protecting resources on WebSphere Application Server or WebSphere Application Server Liberty” on page 8-232.

Table 6-15. Files and subdirectories in the ApplicationCenter subdirectory

Item	Description
ApplicationCenter/installer/IBMAppCenter	Contains the MobileFirst project for the mobile Client. You must build this project to create the iOS version of the mobile client.
ApplicationCenter/console/	<p>appcenterconsole.war The WAR file for the Application Center console user interface web application.</p> <p>applicationcenter.war The WAR file for the Application Center REST services web application.</p> <p>applicationcenter.ear The enterprise application archive (EAR) file to be deployed under IBM PureApplication® System.</p>
ApplicationCenter/databases	<p>create-appcenter-derby.sql The SQL script to re-create the application center database on derby.</p> <p>create-appcenter-db2.sql The SQL script to re-create the application center database on DB2.</p> <p>create-appcenter-mysql.sql The SQL script to re-create the application center database on MySQL.</p> <p>create-appcenter-oracle.sql The SQL script to re-create the application center database on Oracle.</p> <p>In addition, this directory contains the SQL scripts to upgrade the database from earlier versions of IBM MobileFirst Platform Foundation for iOS.</p>

Table 6-15. Files and subdirectories in the *ApplicationCenter* subdirectory (continued)

Item	Description
ApplicationCenter/tools	<p>applicationcenterdeploytool.jar The JAR file that contains the Ant task to deploy an application to the Application Center.</p> <p>acdeploytool.bat The startup script of the deployment tool for use on Microsoft Windows systems.</p> <p>acdeploytool.sh The startup script of the deployment tool for use on UNIX systems.</p> <p>build.xml Example of an Ant script to deploy applications to the Application Center.</p> <p>dbconvertertool.sh The startup script of the database converter tool for use on UNIX systems.</p> <p>dbconvertertool.bat The startup script of the database converter tool for use on Microsoft Windows systems.</p> <p>dbconvertertool.jar The main library of the database converter tool.</p> <p>lib The directory that contains all Java Archive (JAR) files that are required by the database converter tool.</p> <p>json4j.jar The required JSON4J Java archive file.</p> <p>README.TXT Readme file that explains how to use the deployment tool.</p>

Table 6-16. Files and subdirectories in the *License* subdirectory

Item	Description
Text	License for IBM MobileFirst Platform Foundation

Table 6-17. Files and subdirectories in the *tools* subdirectory

Item	Description
tools/apache-ant-<version>	A binary installation of Apache Ant that can be used to run the Ant tasks. For more information, see “Deploying MobileFirst projects” on page 10-1.

Table 6-18. Files and subdirectories in the Analytics subdirectory

Item	Description
analytics.ear	The IBM MobileFirst Platform Operational Analytics EAR file. Contains the analytics-service.war file for deployment on WebSphere Application Server and WebSphere Application Server Liberty. For installation instructions, see “Installing the IBM MobileFirst Platform Operational Analytics” on page 6-145.
analytics-ui.war	The WAR file for the analytics console user interface web application.
analytics-service.war	The WAR file for the analytics REST services web application.

Table 6-19. Files and subdirectories in the Datastore subdirectory.

Item	Description
imf-data-proxy.war	The WAR file for the MobileFirst Data Proxy.
configuration-samples	Sample Ant files for deploying a MobileFirst Data Proxy to an application server. For more information on how to use these Ant projects, see “Installing the MobileFirst Data Proxy with Ant tasks” on page 6-153.

Installing the MobileFirst Server administration

You must install the Administration Services, and optionally the MobileFirst Operations Console, as part of the MobileFirst Server installation.

Optional creation of the administration database

If you want to activate the option to install the administration database when you run the Ant tasks or the Server Configuration Tool, you must have certain database access rights that entitle you to create the databases, or the users, or both, that are required by the MobileFirst Server administration.

If you have sufficient database administration credentials, and if you enter the administrator user name and password when prompted, or use Ant files with dba tags, the installation tools can create the databases for you. Otherwise, you need to ask your database administrator to create the required database for you. In this case, the database must be created before you start the installation tools.

The following topics describe the procedure for the supported database management systems.

Important: This step is optional if you install IBM MobileFirst Platform Foundation for iOS with the Server Configuration Tool or the Ant tasks because the Server Configuration Tool and the Ant tasks can create the databases automatically.

Creating the DB2 database for MobileFirst Server administration:

During the installation of IBM MobileFirst Platform Foundation for iOS, the installation tools can create the administration database for you.

Before you begin

You perform this procedure to create the databases before you run Ant tasks or the Server Configuration Tool to populate them. For a fully manual database installation, see “Configuring the DB2 database manually for the IBM MobileFirst Platform Server administration” on page 6-56 instead.

About this task

The installation tools can create the administration database for you if you enter the name and password of a user account on the database server that has the DB2 SYSADM or SYSCTRL privilege, and the account can be accessed through SSH. Otherwise, the database administrator can create the administration database for you. For more information, see the DB2 Solution user documentation.

When you create the database manually, you can replace the database name (here WLADMIN) and the password with a database name and password of your choice.

Important: You can name your database and user differently, or set a different password, but ensure that you enter the appropriate database name, user name, and password correctly across the DB2 database setup. DB2 limits:

- Database names: no more than 8 characters on all platforms
- User name and passwords: no more than 8 characters for UNIX and Linux, and no more than 30 characters for Windows

Procedure

1. Create a system user named, for example, wuser in a DB2 admin group such as DB2USERS, by using the appropriate commands for your operating system. Give it a password, for example, wuser.

If you want multiple MobileFirst Server instances to connect to the same database, use a different user name for each connection. Each database user has a separate default schema. For more information about database users, see the DB2 documentation and the documentation for your operating system.

2. Open a DB2 command-line processor, with a user that has SYSADM or SYSCTRL permissions.

- On Windows systems, click **Start > IBM DB2 > Command Line Processor**.
- On Linux or UNIX systems, navigate to ~/sqllib/bin and enter ./db2.

3. To create the administration database, enter database manager and SQL statements similar to the following example.

Replace the user name wuser with your own.

```
CREATE DATABASE WLADMIN COLLATE USING SYSTEM PAGESIZE 32768
CONNECT TO WLADMIN
GRANT CONNECT ON DATABASE TO USER wuser
DISCONNECT WLADMIN
QUIT
```

What to do next

The installation tools can create the database tables and objects for MobileFirst Server administration in a specific schema. You can then use the same database for MobileFirst Server administration and for a MobileFirst project.

- If the IMPLICIT_SCHEMA authority is granted to the user that you created in Step 1, no further action is required. This is the default in the database creation script of Step 2.

- If the user does not have the IMPLICIT_SCHEMA authority, create a SCHEMA for the administration database tables and objects.

Creating the MySQL database for MobileFirst Server administration:

During the MobileFirst installation, the installation tools can create the administration database for you.

Before you begin

You perform this procedure to create the databases before you run Ant tasks or the Server Configuration Tool to populate them. For a fully manual database installation, see “Configuring the MySQL database manually for the IBM MobileFirst Platform Server administration” on page 6-64 instead.

About this task

The installation tools can create the database for you if you enter the name and password of the superuser account. For more information, see Securing the Initial MySQL Accounts on your MySQL database server. Your database administrator can also create the databases for you. When you create the database manually, you can replace the database name (here WLADMIN) and password with a database name and password of your choice.

Attention: On UNIX, MySQL database names are case-sensitive.

Procedure

1. Start the MySQL command-line tool.
2. Enter the following commands:

```
CREATE DATABASE WLADMIN CHARACTER SET utf8 COLLATE utf8_general_ci;  
GRANT ALL PRIVILEGES ON WLADMIN.* TO 'worklight'@'Worklight-host' IDENTIFIED BY 'password';  
GRANT ALL PRIVILEGES ON WLADMIN.* TO 'worklight'@'localhost' IDENTIFIED BY 'password';  
FLUSH PRIVILEGES;
```

Here, you need to replace *Worklight-host* with the name of the host on which IBM MobileFirst Platform Foundation for iOS runs.

Creating the Oracle database for MobileFirst Server administration:

During the installation of IBM MobileFirst Platform Foundation for iOS, the installation tools can create the administration database, except for the Oracle 12c database type, or the user and schema inside an existing database.

Before you begin

You perform this procedure to create the databases before you run Ant tasks or the Server Configuration Tool to populate them. For a fully manual database installation, see “Configuring the Oracle database manually for the IBM MobileFirst Platform Server administration” on page 6-67 instead.

About this task

The installation tools can create the database, except for the Oracle 12c database, or the user and schema inside an existing database, if you enter the name and password of the Oracle administrator on the database server, and the account can be accessed through SSH. Otherwise, the database administrator can create the

database or user and schema for you. When you manually create the database or user, you can use database names, user names, and a password of your choice.

Attention: Lowercase characters in Oracle user names can lead to unwanted results.

Procedure

1. If you do not already have a database named ORCL, use the Oracle Database Configuration Assistant (DBCA) and follow the steps in the wizard to create a new general-purpose database named ORCL:
 - a. Use global database name `ORCL_our_domain`, and system identifier (SID) ORCL.
 - b. On the **Custom Scripts** tab of the step **Database Content**, do not run the SQL scripts because you must first create a user account.
 - c. On the **Character Sets** tab of the step **Initialization Parameters**, select **Use Unicode (AL32UTF8) character set and UTF8 - Unicode 3.0 UTF-8 national character set**.
 - d. Complete the procedure, accepting the default values.
2. Create a database user by using either Oracle Database Control or the Oracle SQLPlus command-line interpreter.
 - Using Oracle Database Control.
 - a. Connect as SYSDBA.
 - b. Go to the **Users** page and click **Server**, then **Users** in the **Security** section.
 - c. Create a user, for example WLADMIN. If you want multiple MobileFirst Server instances to connect to the general-purpose database that you created in Step 1, use a different user name for each connection. Each database user has a separate default schema.
 - d. Assign the following attributes:
 - Profile: **DEFAULT**
 - Authentication: **password**
 - Default tablespace: **USERS**
 - Temporary tablespace: **TEMP**
 - Status: **Unlocked**
 - Add system privilege: **CREATE SESSION**
 - Add system privilege: **CREATE SEQUENCE**
 - Add system privilege: **CREATE TABLE**
 - Add quota: **Unlimited for tablespace USERS**
 - Using the Oracle SQLPlus command-line interpreter.

The commands in the following example create a user named WLADMIN for the database:

```
CONNECT SYSTEM/<SYSTEM_password>@ORCL
CREATE USER WLADMIN IDENTIFIED BY WLADMIN_password
DEFAULT TABLESPACE USERS QUOTA UNLIMITED ON USERS;
GRANT CREATE SESSION, CREATE SEQUENCE, CREATE TABLE TO WLADMIN;
DISCONNECT;
```

Configuration of the application server

IBM MobileFirst Platform Foundation for iOS has some requirements for the configuration of the application server that are detailed in the following topics.

Configuring WebSphere Application Server Liberty profile:

You must configure a secure JMX connection for WebSphere Application Server Liberty profile.

Procedure

MobileFirst Server requires the secure JMX connection to be configured.

- The Server Configuration Tool and the Ant tasks can configure a default secure JMX connection, which includes the generation of a self-signed SSL certificate with a validity period of 365 days. This configuration is not intended for production use.
- To configure the secure JMX connection for production use, follow the instructions from the page Configuring secure JMX connection to the Liberty profile.
- The rest-connector is available for WebSphere Application Server, Liberty Core, and other editions of Liberty, but it is possible to package a Liberty Server with a subset of the available features. To verify that the rest-connector feature is available in your installation of Liberty, enter the following command:
`<libertyInstallDir>/bin/productInfo featureInfo`

Note: Verify that the output of this command contains `restConnector-1.0`.

What to do next

For more information about the optimization of MobileFirst Server, especially the tuning of the JVM memory allocation, see “Optimization and tuning of MobileFirst Server” on page 6-105.

Configuring Apache Tomcat:

You must configure a secure JMX connection for Apache Tomcat application server.

About this task

The Server Configuration Tool and the Ant tasks can configure a default secure JMX connection, which includes the definition of a JMX remote port, and the definition of authentication properties. They modify `<tomcatInstallDir>/bin/setenv.bat` and `<tomcatInstallDir>/bin/setenv.sh` to add these options to `CATALINA_OPTS`:

```
-Djava.rmi.server.hostname=localhost
-Dcom.sun.management.jmxremote.port=8686
-Dcom.sun.management.jmxremote.authenticate=false
-Dcom.sun.management.jmxremote.ssl=false
```

Note: 8686 is a default value. The value for this port can be changed if the port is not available on the computer.

- The `setenv.bat` file is used if you start Apache Tomcat with `<tomcatInstallDir>/bin/startup.bat`, or `<tomcatInstallDir>/bin/catalina.bat`.
- The `setenv.sh` file is used if you start Apache Tomcat with `<tomcatInstallDir>/bin/startup.sh`, or `<tomcatInstallDir>/bin/catalina.sh`.

This file might not be used if you start Apache Tomcat with another command. If you installed the Apache Tomcat Windows Service Installer, the service launcher does not use `setenv.bat`.

Important: This configuration is not secure by default. To secure the configuration, you must manually complete steps 2 and 3 of the following procedure.

Procedure

Manually configuring Apache Tomcat:

1. For a simple configuration, add the following options to CATALINA_OPTS:
 - Djava.rmi.server.hostname=localhost
 - Dcom.sun.management.jmxremote.port=8686
 - Dcom.sun.management.jmxremote.authenticate=false
 - Dcom.sun.management.jmxremote.ssl=false
2. To activate authentication, see the Apache Tomcat user documentation [SSL Support - BIO and NIO and SSL Configuration HOW-TO](#).
3. For a JMX configuration with SSL enabled, add the following options:
 - Dcom.sun.management.jmxremote=true
 - Dcom.sun.management.jmxremote.port=8686
 - Dcom.sun.management.jmxremote.ssl=true
 - Dcom.sun.management.jmxremote.authenticate=false
 - Djava.rmi.server.hostname=localhost
 - Djavax.net.ssl.trustStore=<key store location>
 - Djavax.net.ssl.trustStorePassword=<key store password>
 - Djavax.net.ssl.trustStoreType=<key store type>
 - Djavax.net.ssl.keyStore=<key store location>
 - Djavax.net.ssl.keyStorePassword=<key store password>
 - Djavax.net.ssl.keyStoreType=<key store type>

Note: The port 8686 can be changed.

4. If the Tomcat instance is running behind a firewall, the JMX Remote Lifecycle Listener must be configured. See the Apache Tomcat documentation for [JMX Remote Lifecycle Listener](#).

The following environment properties must also be added to the Context section of the Administration Services application in the `server.xml` file, such as in the following example:

```
<Context docBase="worklightadmin" path="/worklightadmin ">
  <Environment name="ibm.worklight.admin.rmi.registryPort" value="registryPort" type="java.lang.String" override="false"/>
  <Environment name="ibm.worklight.admin.rmi.serverPort" value="serverPort" type="java.lang.String" override="false"/>
</Context>
```

In the previous example:

- *registryPort* must have the same value as the `rmiRegistryPortPlatform` attribute of the JMX Remote Lifecycle Listener.
 - *serverPort* must have the same value as the `rmiServerPortPlatform` attribute of the JMX Remote Lifecycle Listener.
5. If you installed Apache Tomcat with the Apache Tomcat Windows Service Installer instead of adding the options to CATALINA_OPTS, run `<TomcatInstallDir>/bin/Tomcat7w.exe`, and add the options in the **Java** tab of the Properties window.

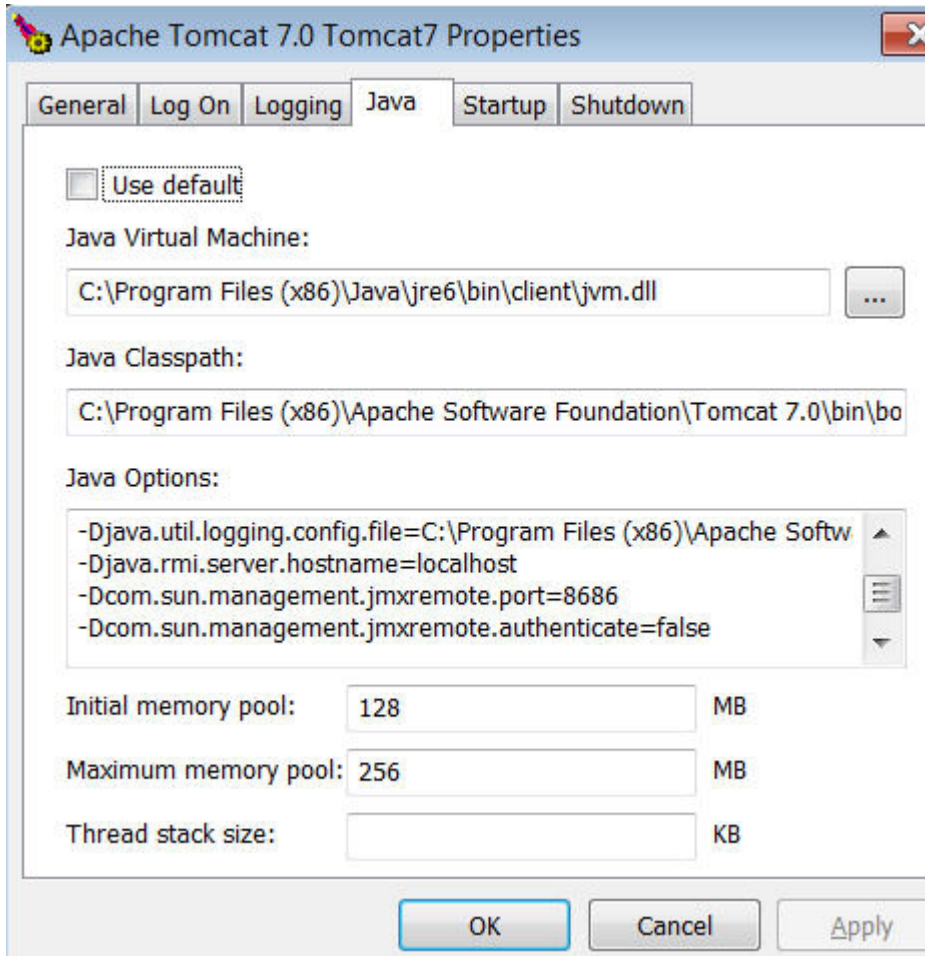

What to do next

For more information about the optimization of MobileFirst Server, especially the tuning of the JVM memory allocation, see “Optimization and tuning of MobileFirst Server” on page 6-105.

Troubleshooting JMX configuration for Liberty profile:

When you start the IBM MobileFirst Platform Foundation for iOS Admin Services and the MobileFirst runtimes, you can encounter several exceptions in the Liberty profile server logs.

Table 6-20. Configuring JMX for Liberty profile: errors. Table that describes multiple errors that you might receive when you try to configure the Liberty profile JMX server.

Message title	Error	Cause	Resolution
Invalid administrator user	Failed to obtain JMX connection to access an MBean. There might be a JMX configuration error: CWVKX0215E: There was a problem with the user name or password provided. The server responded with code 401 and message 'Unauthorized'	The value of the <code>ibm.worklight.admin.jmx.user</code> JNDI property is not an administrative Liberty profile user.	Edit the <code>server.xml</code> file and make sure that the user referenced in <code>ibm.worklight.admin.jmx.user</code> is defined in the <code><administrator-role></code> element.

Table 6-20. Configuring JMX for Liberty profile: errors (continued). Table that describes multiple errors that you might receive when you try to configure the Liberty profile JMX server.

Message title	Error	Cause	Resolution
SSL socket factory not found	Failed to obtain JMX connection to access an MBean. There might be a JMX configuration error: java.lang. ClassNotFoundException: Cannot find the specified class com.ibm.websphere.ssl.protocol.SSLSocketFactory	The IBM JDK cannot be used with the SSL socket factories of WebSphere Application Server Liberty profile.	For information about resolving this issue, see “Configuring Liberty profile when IBM JDK is used” on page 6-193.
No JMX connector configured	Failed to obtain JMX connection to access an MBean. There might be a JMX configuration error: No JMX connector is configured	The host name or the port number that is required for the JMX connection is not configured.	Edit the server.xml file and make sure that both the ibm.worklight.admin.jmx.port and the ibm.worklight.admin.jmx.host JNDI properties are defined.
Read timed out	Failed to obtain JMX connection to access an MBean. There might be a JMX configuration error: Read timed out	The JMX connection times out before the operation completes. By default, the JMX connection times out after one minute.	Edit the Liberty profile jvm.options file and add the following property: -Dcom.ibm.ws.jmx.connector.client.rest.readTimeout= <i>time in milliseconds</i> The default value is 60000. Use a greater value. The following example uses three minutes. -Dcom.ibm.ws.jmx.connector.client.rest.readTimeout=180000
Invalid certification path	Failed to obtain JMX connection to access an MBean. There might be a JMX configuration error: com.ibm.jsse2.util.h: PKIX path building failed: java.security.cert. CertPathBuilderException: unable to find valid certification path to requested target	The SSL configuration of the Liberty profile server is not correct.	For instructions about how to resolve this issue, see Configuring secure JMX connection to the Liberty profile.
Connection exception	java.net.ConnectException: Connection refused: connect	The JMX connection fails.	Edit the server.xml file. Make sure that both the ibm.worklight.admin.jmx.port and the ibm.worklight.admin.jmx.host JNDI properties reference the local host, and that the https port number is defined in the <httpEndpoint> element.

Configuring WebSphere Application Server and WebSphere Application Server Network Deployment:

You must configure a secure JMX connection for WebSphere Application Server and WebSphere Application Server Network Deployment.

Procedure

- IBM MobileFirst Platform Foundation for iOS requires access to the SOAP port, or the RMI port to perform JMX operations. By default, the SOAP port is active

on a WebSphere Application Server. IBM MobileFirst Platform Foundation for iOS uses the SOAP port by default. If both the SOAP and RMI ports are deactivated, IBM MobileFirst Platform Foundation for iOS does not run.

- RMI is only supported with a WebSphere Application Server Network Deployment. RMI is not supported with a stand-alone profile, or with a WebSphere Application Server server farm.
- You must activate Administrative and Application Security.

What to do next

For more information about the optimization of MobileFirst Server, especially the tuning of the JVM memory allocation, see “Optimization and tuning of MobileFirst Server” on page 6-105.

Installing MobileFirst Server administration with the Server Configuration Tool

You can use the Server Configuration Tool to install and configure MobileFirst Server administration.

Before you begin

Verify that the user who runs the Server Configuration Tool has the privileges that are described in “File system prerequisites” on page 6-5.

About this task

Restriction:

- The Server Configuration Tool does not support server farms. Therefore, you cannot use this tool to install, upgrade, or configure a server farm.
- MobileFirst Server is not supported for production use on Mac OS X.

Procedure

1. Start the Server Configuration Tool.
 - On Linux: In the desktop menu, click **IBM MobileFirst Platform Server > Server Configuration Tool**.
 - On Windows: In the **Start** menu, click **IBM MobileFirst Platform Server > Server Configuration Tool**.
 - On Mac OS X: In the **Finder**, double-click the file *mf_server_install_dir/shortcuts/configuration-tool.sh*.

Note: The *mf_server_install_dir* placeholder represents the directory where you install MobileFirst Server. *mf_server* is the shortcut for MobileFirst Server.

2. Select **Create a MobileFirst Server Configuration**.
3. Name your configuration.
4. In the Configuration Description window:
 - a. Enter the context root of the MobileFirst Administration REST service.
The context root is used to create the URL to the MobileFirst REST Administration service. This URL is typically in the form
<URL_TO_APPLICATION_SERVER_HTTPS_PORT>/contextroot or
<URL_TO_APPLICATION_SERVER_HTTP_PORT>/contextroot.
 - b. Enter an **environmentId**.

This ID is optional and is used to distinguish between different deployments of the MobileFirst Server administration components in the same application server environment, for example in the same cell of WebSphere Application Server Network Deployment.

Important: Review carefully this environment ID. It must match the environment ID of all the runtime environments that are managed by this MobileFirst Server administration component. If you install or upgrade the MobileFirst runtime environments with separate Ant files, this verification is particularly important because the **environmentId** attribute must match. For a server farm, all installations must also have the same **environmentId** attribute.

The **environmentId** attribute is an attribute of the following Ant tasks:

- **installworklightadmin**, **updateworklightadmin**, and **uninstallworklightadmin**, which are documented at “Ant tasks for installation of MobileFirst Operations Console and Administration Services” on page 14-10.
 - **configureapplicationserver**, **updateapplicationserver**, **unconfigureapplicationserver**, which are documented at “Ant tasks for installation of MobileFirst runtime environments” on page 14-16.
5. In the Console Settings window, enter the context root of the MobileFirst Operations Console.
 6. In the Database Properties window:
 - a. Select your database type: IBM DB2, MySQL, or Oracle.
 - b. In the next window, enter the details to connect to the database instance.
 - c. In the Database Additional properties window, enter the parameters to connect to the administration database.
 - d. If the database administrator did not create the databases in step “Optional creation of the administration database” on page 6-43, enter database administration credentials in the **database creation request** window.

Note: For IBM DB2 and for Oracle, you must have an SSH access to the host where the database management system (DBMS) is installed.

The Server Configuration Tool creates the database for you.

7. In the Application Server Choice window:
 - a. Select your application server type: WebSphere Application Server, WebSphere Application Server Liberty profile, or Apache Tomcat.
 - b. In the Application Server window, enter the data so that you can deploy IBM MobileFirst Platform Foundation for iOS to that application server.
 - c. Depending on your application server, proceed as follows:
 - If the application server is WebSphere Application Server Liberty profile, or Apache Tomcat, select **Create a default user** if you want to declare a user who can log in to the console as administrator to the MobileFirst Operations Console
 - If the application server is WebSphere Application Server, select **Declare the WebSphere Administrator as an administrator of IBM MobileFirst Platform Operations Console** if you want to allow the WebSphere administrator to log in to the MobileFirst Operations Console.

For more information about further configuration of security roles, see “Configuring user authentication for MobileFirst Server administration” on page 6-82.

8. When all the data is entered, click **Deploy**.

The following effects take place.

- a. If the database administrator did not complete step “Optional creation of the administration database” on page 6-43, the database for the MobileFirst Server administration is created and access rights are granted to the user that is specified in the **database additional properties** window.
 - b. If the tables for MobileFirst administration do not exist in the database, they are created.
 - c. The MobileFirst administration components are installed in the application server and are connected to the database.
9. Restart the application server
 10. If you are in an environment where you must protect the password of the user who can log in to the console as administrator to the MobileFirst Operations Console, follow the steps in “Securing the MobileFirst Server administration” on page 6-117.
 11. Open the console.
If the context root of the console was not changed in the Console Settings window, you find it at `<URL_TO_APPLICATION_SERVER_HTTPS_PORT>/worklightconsole`, or if HTTPS is not supported in your application server, at the unsecured URL `<URL_TO_APPLICATION_SERVER_HTTP_PORT>/worklightconsole`.

What to do next

Install a MobileFirst runtime environment. For more information, see “Deploying, updating, or undeploying MobileFirst Server by using the Server Configuration Tool” on page 10-9.

Using Ant tasks to install MobileFirst Server administration

Learn about the Ant tasks that you can use to install MobileFirst Server administration.

Creating and configuring the database for MobileFirst Server administration with Ant tasks:

If you did not manually create databases, you can use Ant tasks to create and configure your database for MobileFirst Server administration.

Before you begin

Make sure that a database management system (DBMS) is installed and running on a database server, which can be the same computer, or a different computer.

Note: This preliminary step is not required if you plan to use Apache Derby, which is not supported for production use. You can install an Apache Derby database with Ant tasks.

If you want to start the Ant task from a computer on which MobileFirst Server is not installed, you must copy the file `mf_server_install_dir/WorklightServer/worklight-ant-deployer.jar` to that computer.

If you did not create your databases manually as described in “Optional creation of the administration database” on page 6-43, complete the following steps.

Note: The *mf_server_install_dir* placeholder represents the directory where you installed MobileFirst Server.

About this task

Procedure

1. Review the sample configuration files in “Sample configuration files” on page 14-35, and copy the Ant file that corresponds to your database.

The files for creating a database are named after the following pattern:

```
create-database-<database>.xml
```

For more information, see table 1, Table 14-62 on page 14-35, in “Sample configuration files” on page 14-35.

2. See step 4 of the page “Sample configuration files” on page 14-35 to edit the Ant file and replace the placeholder values for the properties at the top of the file.

3. Run the following commands to create the databases.

```
ant -f create-database-database.xml admdatabases
```

You can find the Ant command in *mf_server_install_dir/shortcuts*.

If the databases are created, and you must create only the database TABLES.

4. Edit the Ant script that you use later to create and configure the databases.

5. Review the sample configuration files in “Sample configuration files” on page 14-35, and copy the Ant file that corresponds to your database. The files for configuring an existing database are named after this pattern:

```
configure-appServer-database.xml
```

For more information, see table 1, Table 14-62 on page 14-35, in “Sample configuration files” on page 14-35.

6. See step 4 of the page “Sample configuration files” on page 14-35 to edit the Ant file and replace the placeholder values for the properties at the top of the file.

7. Run the following commands to create the databases.

```
ant -f configure-appServer-database.xml admdatabases
```

You can find the Ant command in *mf_server_install_dir/shortcuts*.

What to do next

Deploy MobileFirst Operations Console and the Administration Services, see “Deploying the MobileFirst Operations Console and Administration Services with Ant tasks” on page 6-55.

See also:

- “Ant **configuredatabase** task reference” on page 14-1
- “Sample configuration files” on page 14-35

Deploying the MobileFirst Operations Console and Administration Services with Ant tasks:

Use Ant tasks to deploy the MobileFirst Operations Console and Administration Services to an application server, and configure data sources, properties, and database drivers that are used by IBM MobileFirst Platform Foundation for iOS.

Before you begin

1. Complete the procedure in “Creating and configuring the databases with Ant tasks” on page 10-13.
2. Run the Ant task on the computer where the application server is installed, or the Network Deployment Manager for WebSphere Application Server Network Deployment. If you want to start the Ant task from a computer on which MobileFirst Server is not installed, you must copy the file `mf_server_install_dir/WorklightServer/worklight-ant-deployer.jar` to that computer.

Note: The `mf_server_install_dir` placeholder represents the directory where you installed MobileFirst Server.

Procedure

1. Edit the Ant script that you use later to deploy the project WAR File.
 - a. Review the sample configuration files in “Sample configuration files” on page 14-35, and copy the Ant file that corresponds to your database. The files for deploying a project WAR file are named after the following pattern:
`configure-appServer-database.xml`

For more information, see table 1, Table 14-62 on page 14-35, in “Sample configuration files” on page 14-35.

Note: If your file name follows the pattern `configure-appServer-database.xml`, you can reuse it for “Creating and configuring the databases with Ant tasks” on page 10-13.

- b. Follow step 4 of the page “Sample configuration files” on page 14-35 to edit the Ant file and replace the placeholder values for the properties at the top of the file. For WebSphere Application Server Liberty profile, the administration services require access to the RESTConnector, which is only accessible with Liberty administrator credentials. If you do not modify the `<jmx/>` tag, a new user named WorklightRESTUser is declared in the basic registry and is given administrator rights by declaring this user in the `<administrator-role/>` tag. You might have to modify the `<jmx/>` tag to define the Liberty administrator credentials for example if the Liberty administrator is identified using LDAP. In the Ant file, replace the empty `<jmx/>` tag by the following line.

```
<jmx libertyAdminUser="demo" libertyAdminPassword="demo" createLibertyAdmin="false"/>
```

Where:

- `libertyAdminUser` is the name of the Liberty administrator.
- `libertyAdminPassword` is the password of the Liberty administrator.

If `createLibertyAdmin` is set to `false`, the Ant task does not attempt to add the user to the basic registry or to declare the user as a Liberty administrator.

2. To deploy the Administration Services and the MobileFirst Operations Console WAR files, run the following command:

```
ant -f configure-appServer-database.xml admininstall
```

You can find the Ant command in `mf_server_install_dir/shortcuts`

What to do next

Install a MobileFirst runtime environment. For more information, see “Using Ant tasks to deploy the project WAR file” on page 10-13.

See also:

- “Ant tasks for installation of MobileFirst Operations Console and Administration Services” on page 14-10
- “Sample configuration files” on page 14-35
- “Encrypting database password with Ant tasks for Liberty” on page 14-9

Manually installing MobileFirst Server administration

You can install the MobileFirst Server administration manually instead of using the Ant task or the Server Configuration Tool. You might also want to reconfigure MobileFirst Server so that it uses a different database or schema from the one that was specified during the first installation of MobileFirst Server. This reconfiguration depends on the type of database and the kind of application server.

Configuring the DB2 database manually for the IBM MobileFirst Platform Server administration:

You configure the DB2 database manually by creating the database, creating the database tables, and then configuring the relevant application server to use this database setup.

Procedure

1. Create the database. This step is described in “Creating the DB2 database for MobileFirst Server administration” on page 6-43.
2. Create the tables in the database. This step is described in “Setting up your DB2 database manually for the MobileFirst Server administration.”
3. Perform the application server-specific setup as the following list shows.

Setting up your DB2 database manually for the MobileFirst Server administration:

You can set up your DB2 database for the MobileFirst Server administration manually.

About this task

Set up your DB2 database for the MobileFirst Server administration by creating the database schema.

Procedure

1. Create a system user, **worklight**, in a DB2 admin group such as **DB2USERS**, by using the appropriate commands for your operating system. Give it the password **worklight**. For more information, see the DB2 documentation and the documentation for your operating system.

Important: You can name your user differently, or set a different password, but ensure that you enter the appropriate user name and password correctly across

the DB2 database setup. DB2 has a user name and password length limit of 8 characters for UNIX and Linux systems, and 30 characters for Windows.

2. Open a DB2 command line processor, with a user that has **SYSADM** or **SYSCTRL** permissions:
 - On Windows systems, click **Start > IBM DB2 > Command Line Processor**.
 - On Linux or UNIX systems, go to `~/sql1lib/bin` and enter `./db2`.
3. Enter the following database manager and SQL statements to create a database that is called **WLADMIN**:

```
CREATE DATABASE WLADMIN COLLATE USING SYSTEM PAGESIZE 32768
CONNECT TO WLADMIN
GRANT CONNECT ON DATABASE TO USER worklight
QUIT
```

4. Run DB2 with the following commands to create the **WLADMIN** tables, in a schema named **WLADMSC**. You can change the name of the schema. This command can be run on an existing database whose page size is compatible with the one defined in step 3.

```
db2 CONNECT TO WLADMIN
db2 SET CURRENT SCHEMA = 'WLADMSC'
db2 -vf product_install_dir/WorklightServer/databases/create-worklightadmin-db2.sql -t
```

Configuring Liberty profile for DB2 manually for MobileFirst Server administration:

You can set up and configure your DB2 database manually for MobileFirst Server administration with WebSphere Application Server Liberty profile.

Before you begin

Complete the DB2 Database Setup procedure before continuing.

Procedure

1. Add the DB2 JDBC driver JAR file to `LIBERTY_HOME/wlp/usr/shared/resources/db2`.

If that directory does not exist, create it. You can retrieve the file in one of two ways:

- Download it from DB2 JDBC Driver Versions.
- Fetch it from the `db2_install_dir/java` on the DB2 server directory.

2. Configure the data source in the `LIBERTY_HOME/wlp/usr/servers/worklightServer/server.xml` file as follows:

In this path, you can replace `worklightServer` by the name of your server.

```
<library id="DB2Lib">
  <fileset dir="{shared.resource.dir}/db2" includes="*.jar"/>
</library>

<!-- Declare the administration database. -->
<dataSource jndiName="jdbc/WorklightAdminDS" transactional="false">
  <jdbcDriver libraryRef="DB2Lib"/>
  <properties.db2.jcc databaseName="WLADMIN" currentSchema="WLADMSC"
    serverName="db2server" portNumber="50000"
    user="worklight" password="worklight"/>
</dataSource>
```

The `worklight` value after `user=` is the name of the system user with `CONNECT` access to the **WLADMIN** database that you have previously created. The `worklight` value after `password=` is this user's password. If you have defined either a different user name, or a different password, or both, replace

worklight accordingly. Also, replace db2server with the host name of your DB2 server (for example, localhost, if it is on the same computer).

DB2 has a user name and password length limit of 8 characters for UNIX and Linux systems, and 30 characters for Windows.

3. You can encrypt the database password with the securityUtility program in <liberty_install_dir>/bin.

Configuring WebSphere Application Server for DB2 manually for MobileFirst Server administration:

You can set up and configure your DB2 database manually for the MobileFirst Server administration with WebSphere Application Server.

About this task

Complete the DB2 database setup procedure before continuing.

Note: The *was_install_dir* and *mf_server_install_dir* placeholders denote the directories where you installed WebSphere Application Server and MobileFirst Server.

Procedure

1. Determine a suitable directory for the JDBC driver JAR file in the WebSphere Application Server installation directory.
 - For a standalone server, you can use a directory such as *WAS_INSTALL_DIR/optionalLibraries/IBM/WorklightAdmin/db2*.
 - For deployment to a WebSphere Application Server Network Deployment cell, use *WAS_INSTALL_DIR/profiles/profile-name/config/cells/cell-name/WorklightAdmin/db2*.
 - For deployment to a WebSphere Application Server Network Deployment cluster, use *WAS_INSTALL_DIR/profiles/profile-name/config/cells/cell-name/clusters/cluster-name/WorklightAdmin/db2*.
 - For deployment to a WebSphere Application Server Network Deployment node, use *WAS_INSTALL_DIR/profiles/profile-name/config/cells/cell-name/nodes/node-name/WorklightAdmin/db2*.
 - For deployment to a WebSphere Application Server Network Deployment server, use *WAS_INSTALL_DIR/profiles/profile-name/config/cells/cell-name/nodes/node-name/servers/server-name/WorklightAdmin/db2*.

If the directory for the JDBC driver JAR file does not exist, you must create it.

2. Add the DB2 JDBC driver JAR file (download it from DB2 JDBC Driver Versions, or fetch it from the directory *db2_install_dir/java* on the DB2 server) to the directory that you determined in step 1.
3. Set up the JDBC provider:
 - a. In the WebSphere Application Server console, click **Resources > JDBC > JDBC Providers**.
 - b. Select the appropriate scope from the **Scope** combination box.
 - c. Click **New**.
 - d. Set **Database type** to **DB2**.
 - e. Set **Provider type** to **DB2 Using IBM JCC Driver**.
 - f. Set **Implementation Type** to **Connection pool data source**.
 - g. Set **Name** to **DB2 Using IBM JCC Driver**.

- h. Click **Next**.
 - i. Set the **Class path** to the set of JAR files in the directory that you determined in step 1, one per line, replacing *WAS_INSTALL_DIR/profiles/profile-name* with the WebSphere Application Server variable reference `${USER_INSTALL_ROOT}`.
 - j. Do not set **Native library path**.
 - k. Click **Next**.
 - l. Click **Finish**.
 - m. The JDBC provider is created.
 - n. Click **Save**.
4. Create a data source for the administration database:
 - a. Click **Resources > JDBC > Data sources**.
 - b. Select the appropriate scope from the **Scope** combination box.
 - c. Click **New** to create a data source.
 - d. Set the **Data source name** to **administration database**.
 - e. Set **JNDI Name** to **jdbc/WorklightAdminDS**.
 - f. Click **Next**.
 - g. Enter properties for the data source, for example:
 - **Driver type:** 4
 - **Database Name:** WLADMIN
 - **Server name:** localhost
 - **Port number:** 50000 (default)
 Leave **Use this data source in (CMP)** selected.
 - h. Click **Next**.
 - i. Create JAAS-J2C authentication data, specifying the DB2 user name and password as its properties. If necessary, go back to the data source creation wizard, by repeating steps 4a to 4h.
 - j. Select the authentication alias that you created in the **Component-managed authentication alias** combination box (not in the **Container-managed authentication alias** combination box).
 - k. Click **Next** and **Finish**.
 - l. Click **Save**.
 - m. In **Resources > JDBC > Data sources**, select the new data source.
 - n. Click **WebSphere Application Server data source properties**.
 - o. Select the **Non-transactional data source** check box.
 - p. Click **OK**.
 - q. Click **Save**.
 - r. Click **Custom properties** for the data source, select property **currentSchema**, and set the value to the schema used to create the MobileFirst Server administration tables (WLADMSC in this example).
 5. Test the data source connection by selecting **Data Source** and clicking **Test Connection**.
 6. For WebSphere Application Server Network Deployment, click **System administration > Nodes**, select the nodes, and click **Full Synchronize**.

Configuring Apache Tomcat for DB2 manually for MobileFirst Server administration:

You can set up and configure your DB2 database manually for IBM MobileFirst Platform Server administration with the Apache Tomcat application server.

About this task

Before you continue, complete the DB2 database setup procedure.

Procedure

1. Add the DB2 JDBC driver JAR file.

You can retrieve this JAR file in one of the following ways:

- Download it from DB2 JDBC Driver Versions.
- Or fetch it from the directory `db2_install_dir/java` on the DB2 server) to `$TOMCAT_HOME/lib`.

2. Prepare an XML statement that defines the data source, as shown in the following code example.

```
<Resource auth="Container"
  driverClassName="com.ibm.db2.jcc.DB2Driver"
  name="jdbc/WorklightAdminDS"
  username="worklight"
  password="password"
  type="javax.sql.DataSource"
  url="jdbc:db2://server:50000/WLADMIN:currentSchema=WLADMSC;" />
```

The **worklight** parameter after **username=** is the name of the system user with "CONNECT" access to the **WLADMIN** database that you previously created. The **password** parameter after **password=** is this user's password. If you defined either a different user name, or a different password, or both, replace these entries accordingly.

DB2 enforces limits on the length of user names and passwords.

- For UNIX and Linux systems: 8 characters
- For Windows: 30 characters

3. Insert this statement in the `server.xml` file, as indicated in "Configuring Apache Tomcat for MobileFirst Server administration manually" on page 6-77.

Configuring the Apache Derby database manually for the IBM MobileFirst Platform Server administration:

You configure the Apache Derby database manually by creating the database and database tables, and then configuring the relevant application server to use this database setup.

Procedure

1. Create the database and the tables within them. This step is described in "Setting up your Apache Derby database manually for the MobileFirst Server administration" on page 6-61.
2. Configure the application server to use this database setup. Go to one of the following topics:
 - "Configuring Liberty profile for Derby manually for MobileFirst Server administration" on page 6-61
 - "Configuring WebSphere Application Server for Derby manually for MobileFirst Server administration" on page 6-62

- “Configuring Apache Tomcat for Derby manually for the MobileFirst Server administration” on page 6-63

Setting up your Apache Derby database manually for the MobileFirst Server administration:

You can set up your Apache Derby database for the MobileFirst Server administration manually.

About this task

Set up your Apache Derby database for the MobileFirst Server administration by creating the database schema.

Procedure

1. In the location where you want the database to be created, run `ij.bat` on Windows systems or `ij.sh` on UNIX and Linux systems.

Note: The `ij` program is part of Apache Derby. If you do not already have it installed, you can download it from Apache Derby: Downloads.

For supported versions of Apache Derby, see “System requirements” on page 2-7.

The script displays `ij` version number.

2. At the command prompt, enter the following commands:

```
connect 'jdbc:derby:WLADMIN;user=WLADMIN;create=true';
run 'product_install_dir/WorklightServer/databases/create-worklightadmin-derby.sql';
quit;
```

Configuring Liberty profile for Derby manually for MobileFirst Server administration:

If you want to manually set up and configure your Apache Derby database for MobileFirst Server administration with WebSphere Application Server Liberty profile, use the following procedure.

About this task

Complete the Apache Derby database setup procedure before continuing.

Procedure

Configure the data source in the `$LIBERTY_HOME/usr/servers/worklightServer/server.xml` file (`worklightServer` may be replaced in this path by the name of your server) as follows:

```
<!-- Declare the jar files for Derby access through JDBC. -->
<library id="derbyLib">
  <fileset dir="C:/Drivers/derby" includes="derby.jar" />
</library>

<!-- Declare the administration database. -->
<dataSource jndiName="jdbc/WorklightAdminDS" transactional="false" statementCacheSize="10">
  <jdbcDriver libraryRef="derbyLib"
    javax.sql.ConnectionPoolDataSource="org.apache.derby.jdbc.EmbeddedConnectionPoolDataSource40"/>
  <properties.derby.embedded databaseName="DERBY_DATABASES_DIR/WLADMIN" user="WLADMIN"
    shutdownDatabase="false" connectionAttributes="upgrade=true"/>
  <connectionManager connectionTimeout="180"
```

```
maxPoolSize="10" minPoolSize="1"
reapTime="180" maxIdleTime="1800"
agedTimeout="7200" purgePolicy="EntirePool"/>
```

</dataSource>

Configuring WebSphere Application Server for Derby manually for MobileFirst Server administration:

You can set up and configure your Apache Derby database manually for the MobileFirst Server administration with WebSphere Application Server.

About this task

Complete the Apache Derby database setup procedure before continuing.

Procedure

1. Determine a suitable directory for the JDBC driver JAR file in the WebSphere Application Server installation directory.
 - For a standalone server, you can use a directory such as `WAS_INSTALL_DIR/optionalLibraries/IBM/WorklightAdmin/derby`.
 - For deployment to a WebSphere Application Server Network Deployment cell, use `WAS_INSTALL_DIR/profiles/profile-name/config/cells/cell-name/WorklightAdmin/derby`.
 - For deployment to a WebSphere Application Server Network Deployment cluster, use `WAS_INSTALL_DIR/profiles/profile-name/config/cells/cell-name/clusters/cluster-name/WorklightAdmin/derby`.
 - For deployment to a WebSphere Application Server Network Deployment node, use `WAS_INSTALL_DIR/profiles/profile-name/config/cells/cell-name/nodes/node-name/WorklightAdmin/derby`.
 - For deployment to a WebSphere Application Server Network Deployment server, use `WAS_INSTALL_DIR/profiles/profile-name/config/cells/cell-name/nodes/node-name/servers/server-name/WorklightAdmin/derby`.

If the directory for the JDBC driver JAR file does not exist, you must create it.

2. Add the Derby JAR file from `product_install_dir/ApplicationCenter/tools/lib/derby.jar` to the directory that you determined in step 1.
3. Set up the JDBC provider.
 - a. In the WebSphere Application Server console, click **Resources > JDBC > JDBC Providers**.
 - b. Select the appropriate scope from the **Scope** combination box.
 - c. Click **New**.
 - d. Set **Database Type** to **User-defined**.
 - e. Set **class Implementation name** to `org.apache.derby.jdbc.EmbeddedConnectionPoolDataSource40`.
 - f. Set **Name** to **Worklight - Derby JDBC Provider**.
 - g. Set **Description** to **Derby JDBC provider for Worklight**.
 - h. Click **Next**.
 - i. Set the **Class path** to the JAR file in the directory that you determined in step 1, replacing `WAS_INSTALL_DIR/profiles/profile-name` with the WebSphere Application Server variable reference `${USER_INSTALL_ROOT}`.
 - j. Click **Finish**.
4. Create the data source for the administration database.

- a. In the WebSphere Application Server, click **Resources > JDBC > Data sources**.
 - b. Select the appropriate scope from the **Scope** combination box.
 - c. Click **New**.
 - d. Set **Data source Name** to **administration database**.
 - e. Set **JNDI name** to jdbc/WorklightAdminDS.
 - f. Click **Next**.
 - g. Select the existing JDBC Provider that is named **Worklight - Derby JDBC Provider**.
 - h. Click **Next**.
 - i. Click **Next**.
 - j. Click **Finish**.
 - k. Click **Save**.
 - l. In the table, click the **administration Database** data source that you created.
 - m. Under **Additional Properties**, click **Custom properties**.
 - n. Click **databaseName**.
 - o. Set **Value** to the path to the WLADMIN database that is created in "Setting up your Apache Derby database manually for the MobileFirst Server administration" on page 6-61.
 - p. Click **OK**.
 - q. Click **Save**.
 - r. At the top of the page, click **administration atabase**.
 - s. Under **Additional Properties**, click **WebSphere Application Server data source properties**.
 - t. Select **Non-transactional datasource**.
 - u. Click **OK**.
 - v. Click **Save**.
 - w. In the table, select the **administration Database** data source that you created.
 - x. Optional: Only if you are not on the console of a WebSphere Application Server Deployment Manager, click **test connection**.
5. For WebSphere Application Server Network Deployment, click **System administration > Nodes**, select the nodes, and click **Full Synchronize**.

Configuring Apache Tomcat for Derby manually for the MobileFirst Server administration:

If you want to manually set up and configure your Apache Derby database for the IBM MobileFirst Platform Server administration with the Apache Tomcat server, use the following procedure.

About this task

Complete the Apache Derby database setup procedure before continuing.

Procedure

1. Add the Derby JAR file from *product_install_dir/WorklightServer/tools/lib/derby.jar* to the directory `$TOMCAT_HOME/lib`.

2. Prepare an XML statement that defines the data source, as shown in the following code example. Insert this statement in the `server.xml` file, as indicated in “Configuring Apache Tomcat for MobileFirst Server administration manually” on page 6-77

```
<Resource auth="Container"
  driverClassName="org.apache.derby.jdbc.EmbeddedDriver"
  name="jdbc/WorklightAdminDS"
  username="WLADMIN"
  password=""
  type="javax.sql.DataSource"
  url="jdbc:derby:DERBY_DATABASES_DIR/WLADMIN"/>
```

Configuring the MySQL database manually for the IBM MobileFirst Platform Server administration:

You configure the MySQL database manually by creating the database, creating the database tables, and then configuring the relevant application server to use this database setup.

Procedure

1. Create the database. This step is described in “Creating the MySQL database for MobileFirst Server administration” on page 6-45.
2. Create the tables in the database. This step is described in “Setting up your MySQL database manually for the MobileFirst Server administration.”
3. Perform the application server-specific setup as the following list shows.

Setting up your MySQL database manually for the MobileFirst Server administration:

You can set up your MySQL database for the MobileFirst Server administration manually.

About this task

Complete the following procedure to set up your MySQL database.

Procedure

1. Create the database schema.
 - a. Run a MySQL command line client with the option `-u root`.
 - b. Enter the following commands:

```
CREATE DATABASE WLADMIN CHARACTER SET utf8 COLLATE utf8_general_ci;
GRANT ALL PRIVILEGES ON WLADMIN.* TO 'worklight'@'Worklight-host' IDENTIFIED BY 'worklight';
GRANT ALL PRIVILEGES ON WLADMIN.* TO 'worklight'@'localhost' IDENTIFIED BY 'worklight';
FLUSH PRIVILEGES;
```

```
USE WLADMIN;
SOURCE product_install_dir/WorklightServer/databases/create-worklightadmin-mysql.sql;
```

Where **worklight** before the "at" sign (@) is the user name, **worklight** after **IDENTIFIED BY** is its password, and **Worklight-host** is the name of the host on which IBM MobileFirst Platform Foundation for iOS runs.

2. Add the following property to your MySQL option file:
`max_allowed_packet=256M`

For more information about option files, see the MySQL documentation at MySQL.

Configuring Liberty profile for MySQL manually for MobileFirst Server administration:

If you want to manually set up and configure your MySQL database for MobileFirst Server administration with WebSphere Application Server Liberty profile, use the following procedure.

Before you begin

Complete the MySQL database setup procedure before continuing.

Procedure

1. Add the MySQL JDBC driver JAR file to \$LIBERTY_HOME/wlp/usr/shared/resources/mysql. If that directory does not exist, create it.
2. Configure the data source in the \$LIBERTY_HOME/usr/servers/worklightServer/server.xml file (worklightServer may be replaced in this path by the name of your server) as follows:

```
<!-- Declare the jar files for MySQL access through JDBC. -->
<library id="MySQLLib">
  <fileset dir="{shared.resource.dir}/mysql" includes="*.jar"/>
</library>

<!-- Declare the administration database. -->
<dataSource jndiName="jdbc/WorklightAdminDS" transactional="false">
  <jdbcDriver libraryRef="MySQLLib"/>
  <properties databaseName="WLADMIN"
    serverName="mysqlserver" portNumber="3306"
    user="worklight" password="worklight"/>
</dataSource>
```

where **worklight** after **user=** is the user name, **worklight** after **password=** is this user's password, and **mysqlserver** is the host name of your MySQL server (for example, localhost, if it is on the same machine).

3. You can encrypt the database password with the securityUtility program in <liberty_install_dir>/bin.

Configuring WebSphere Application Server for MySQL manually for MobileFirst Server administration:

If you want to manually set up and configure your MySQL database for MobileFirst Server administration with WebSphere Application Server, use the following procedure.

About this task

Complete the MySQL database setup procedure before continuing.

Note: MySQL in combination with WebSphere Application Server Liberty profile or WebSphere Application Server full profile is not classified as a supported configuration. For more information, see WebSphere Application Server Support Statement. We suggest that you use IBM DB2 or another database supported by WebSphere Application Server to benefit from a configuration that is fully supported by IBM Support.

Procedure

1. Determine a suitable directory for the JDBC driver JAR file in the WebSphere Application Server installation directory.

- For a standalone server, you can use a directory such as `WAS_INSTALL_DIR/optionalLibraries/IBM/WorklightAdmin/mysql`.
- For deployment to a WebSphere Application Server Network Deployment cell, use `WAS_INSTALL_DIR/profiles/profile-name/config/cells/cell-name/WorklightAdmin/mysql`.
- For deployment to a WebSphere Application Server Network Deployment cluster, use `WAS_INSTALL_DIR/profiles/profile-name/config/cells/cell-name/clusters/cluster-name/WorklightAdmin/mysql`.
- For deployment to a WebSphere Application Server Network Deployment node, use `WAS_INSTALL_DIR/profiles/profile-name/config/cells/cell-name/nodes/node-name/WorklightAdmin/mysql`.
- For deployment to a WebSphere Application Server Network Deployment server, use `WAS_INSTALL_DIR/profiles/profile-name/config/cells/cell-name/nodes/node-name/servers/server-name/WorklightAdmin/mysql`.

If the directory for the JDBC driver JAR file does not exist, you must create it.

2. Add the MySQL JDBC driver JAR file that you downloaded from Download Connector/J to the directory determined in step 1.
3. Set up the JDBC provider:
 - a. In the WebSphere Application Server console, click **Resources > JDBC > JDBC Providers**.
 - b. Select the appropriate scope from the **Scope** combination box.
 - c. Click **New**.
 - d. Create a **JDBC provider** named **MySQL**.
 - e. Set **Database type** to **User defined**.
 - f. Set **Scope** to **Cell**.
 - g. Set **Implementation class** to **com.mysql.jdbc.jdbc2.optional.MysqlConnectionPoolDataSource**.
 - h. Set the **Class path** to the JAR file in the directory that you determined in step 1, replacing `WAS_INSTALL_DIR/profiles/profile-name` with the WebSphere Application Server variable reference `${USER_INSTALL_ROOT}`.
 - i. Save your changes.
4. Create a data source for the administration database:
 - a. Click **Resources > JDBC > Data sources**.
 - b. Select the appropriate scope from the **Scope** combination box.
 - c. Click **New**.
 - d. Type any name (for example, Worklight administration Database).
 - e. Set **JNDI Name** to `jdbc/WorklightAdminDS`.
 - f. Use the existing **JDBC Provider MySQL**, defined in the previous step.
 - g. Set **Scope** to **New**.
 - h. On the **Configuration** tab, select **Non-transactional data source**.
 - i. Click **Next** a number of times, leaving all other settings as defaults.
 - j. Save your changes.
5. Set the custom properties of the new data source.
 - a. Select the new data source.
 - b. Click **Custom properties**.
 - c. Set the following properties:

```

portNumber = 3306
relaxAutoCommit=true
databaseName = WLADMIN
serverName = the host name of the MySQL server
user = the user name of the MySQL server
password = the password associated with the user name

```

6. Set the WebSphere Application Server custom properties of the new data source.
 - a. In **Resources > JDBC > Data sources**, select the new data source.
 - b. Click **WebSphere Application Server data source properties**.
 - c. Select **Non-transactional data source**.
 - d. Click **OK**.
 - e. Click **Save**.
7. For WebSphere Application Server Network Deployment, click **System administration > Nodes**, select the nodes, and click **Full Synchronize**.

Configuring Apache Tomcat for MySQL manually for MobileFirst Server administration:

If you want to manually set up and configure your MySQL database for IBM MobileFirst Platform Server administration with the Apache Tomcat server, use the following procedure.

About this task

Complete the MySQL database setup procedure before continuing.

Procedure

1. Add the MySQL Connector/J JAR file to the \$TOMCAT_HOME/lib directory.
2. Prepare an XML statement that defines the data source, as shown in the following code example. Insert this statement in the server.xml file, as indicated in “Configuring Apache Tomcat for MobileFirst Server administration manually” on page 6-77.

```

<Resource name="jdbc/WorklightAdminDS"
  auth="Container"
  type="javax.sql.DataSource"
  maxActive="100"
  maxIdle="30"
  maxWait="10000"
  username="worklight"
  password="worklight"
  driverClassName="com.mysql.jdbc.Driver"
  url="jdbc:mysql://server:3306/WLADMIN"/>

```

Configuring the Oracle database manually for the IBM MobileFirst Platform Server administration:

You configure the Oracle database manually by creating the database, creating the database tables, and then configuring the relevant application server to use this database setup.

Procedure

1. Create the database. This step is described in “Creating the Oracle database for MobileFirst Server administration” on page 6-45.
2. Create the tables in the database. This step is described in “Setting up your Oracle database manually for the MobileFirst Server administration” on page 6-68.

3. Perform the application server-specific setup as the following list shows.

Setting up your Oracle database manually for the MobileFirst Server administration:

You can set up your Oracle database for the MobileFirst Server administration manually.

About this task

Complete the following procedure to set up your Oracle database.

Procedure

1. Ensure that you have at least one Oracle database.

In many Oracle installations, the default database has the SID (name) ORCL. For best results, specify **Unicode (AL32UTF8)** as the character set of the database.

If the Oracle installation is on a UNIX or Linux computer, make sure that the database is started next time the Oracle installation is restarted. To this effect, make sure that the line in `/etc/oratab` that corresponds to the database ends with a Y, not with an N.

2. Create the user WLADMIN, either by using Oracle Database Control, or by using the Oracle SQLPlus command-line interpreter.

- Create the user for the runtime database/schema, by using Oracle Database Control, proceed as follows:

- a. Connect as SYSDBA.
- b. Go to the Users page.
- c. Click **Server**, then **Users** in the Security section.
- d. Create a user, named WLADMIN with the following attributes:

```
Profile: DEFAULT
Authentication: password
Default tablespace: USERS
Temporary tablespace: TEMP
Status: Unlocked
Add system privilege: CREATE SESSION
Add system privilege: CREATE SEQUENCE
Add system privilege: CREATE TABLE
Add quota: Unlimited for tablespace USERS
```

- To create the user by using Oracle SQLPlus, enter the following commands:

```
CONNECT SYSTEM/<SYSTEM_password>@ORCL
CREATE USER WLADMIN IDENTIFIED BY password DEFAULT TABLESPACE USERS QUOTA UNLIMITED ON USERS;
GRANT CREATE SESSION, CREATE SEQUENCE, CREATE TABLE TO WLADMIN;
DISCONNECT;
```

3. Create the database tables for the runtime database and reports database:

- a. Using the Oracle SQLPlus command-line interpreter, create the tables for the IBM administration database by running the `create-worklightadmin-oracle.sql` file:

```
CONNECT WLADMIN/WLADMIN_password@ORCL
@product_install_dir/WorklightServer/databases/create-worklightadmin-oracle.sql
DISCONNECT;
```

4. Download and configure the Oracle JDBC driver:

- a. Download the JDBC driver from the Oracle website at Oracle: JDBC, SQLJ, Oracle JPublisher and Universal Connection Pool (UCP):
- b. Ensure that the Oracle JDBC driver is in the system path. The driver file is `ojdbc6.jar`.

Configuring Liberty profile for Oracle manually for MobileFirst Server administration:

If you want to manually set up and configure your Oracle database for MobileFirst Server administration with WebSphere Application Server Liberty profile, use the following procedure.

Before you begin

Complete the Oracle database setup procedure before continuing.

Procedure

1. Add the Oracle JDBC Driver JAR file to \$LIBERTY_HOME/wlp/usr/shared/resources/oracle. If that directory does not exist, create it.
2. If you are using JNDI, configure the data sources in the \$LIBERTY_HOME/wlp/usr/servers/worklightServer/server.xml file (worklightServer may be replaced in this path by the name of your server) as shown in the following JNDI code example:

```
<!-- Declare the jar files for Oracle access through JDBC. -->
<library id="OracleLib">
  <fileset dir="{shared.resource.dir}/oracle" includes="*.jar"/>
</library>

<!-- Declare the administration database. -->
<dataSource jndiName="jdbc/WorklightAdminDS" transactional="false">
  <jdbcDriver libraryRef="OracleLib"/>
  <properties.oracle driverType="thin"
                    serverName="oserver" portNumber="1521"
                    databaseName="ORCL"
                    user="WLADMIN" password="WLADMIN_password"/>
</dataSource>
```

where **WLADMIN** after **user=** is the user name, **WLADMIN_password** after **password=** is this user's password, and **oserver** is the host name of your Oracle server (for example, localhost, if it is on the same machine).

Note: For more information on how to connect the Liberty server to the Oracle database with a service name, or with a URL, see the WebSphere Application Server Liberty Core 8.5.5 documentation, section **properties.oracle**.

3. You can encrypt the database password with the securityUtility program in <liberty_install_dir>/bin.

Configuring WebSphere Application Server for Oracle manually for the MobileFirst Server administration:

If you want to manually set up and configure your Oracle database for the MobileFirst Server administration with WebSphere Application Server, use the following procedure.

About this task

Complete the Oracle database setup procedure before continuing.

Procedure

1. Determine a suitable directory for the JDBC driver JAR file in the WebSphere Application Server installation directory.
 - For a standalone server, you can use a directory such as `WAS_INSTALL_DIR/optionalLibraries/IBM/WorklightAdmin/oracle`.

- For deployment to a WebSphere Application Server Network Deployment cell, use `WAS_INSTALL_DIR/profiles/profile-name/config/cells/cell-name/WorklightAdmin/oracle`.
- For deployment to a WebSphere Application Server Network Deployment cluster, use `WAS_INSTALL_DIR/profiles/profile-name/config/cells/cell-name/clusters/cluster-name/WorklightAdmin/oracle`.
- For deployment to a WebSphere Application Server Network Deployment node, use `WAS_INSTALL_DIR/profiles/profile-name/config/cells/cell-name/nodes/node-name/WorklightAdmin/oracle`.
- For deployment to a WebSphere Application Server Network Deployment server, use `WAS_INSTALL_DIR/profiles/profile-name/config/cells/cell-name/nodes/node-name/servers/server-name/WorklightAdmin/oracle`.

If the directory for the JDBC driver JAR file does not exist, you must create it.

2. Add the Oracle `ojdbc6.jar` file downloaded from JDBC and Universal Connection Pool (UCP) to the directory determined in step 1.
3. Set up the JDBC provider:
 - a. In the WebSphere Application Server console, click **Resources > JDBC > JDBC Providers**.
 - b. Select the appropriate scope from the **Scope** combination box.
 - c. Click **New**.
 - d. Complete the JDBC Provider fields as indicated in the following table:

Table 6-21. JDBC Provider field values

Field	Value
Database type	Oracle
Provider type	Oracle JDBC Driver
Implementation type	Connection pool data source
Name	Oracle JDBC Driver

- e. Click **Next**.
 - f. Set the **Class path** to the JAR file in the directory that you determined in step 1, replacing `WAS_INSTALL_DIR/profiles/profile-name` with the WebSphere Application Server variable reference `${USER_INSTALL_ROOT}`.
 - g. Click **Next**.
The JDBC provider is created.
4. Create a data source for the administration database:
 - a. Click **Resources > JDBC > Data sources**.
 - b. Select the appropriate scope from the **Scope** combination box.
 - c. Click **New**.
 - d. Set **Data source name** to **Oracle JDBC Driver DataSource**.
 - e. Set **JNDI name** to `jdbc/WorklightAdminDS`.
 - f. Click **Next**.
 - g. Click **Select an existing JDBC provider** and select **Oracle JDBC driver** from the list.
 - h. Click **Next**.
 - i. Set the URL value to `jdbc:oracle:thin:@oserver:1521:ORCL`, where **oserver** is the host name of your Oracle server (for example, localhost, if it is on the same machine).
 - j. Click **Next** twice.

- k. Click **Resources > JDBC > Data sources > Oracle JDBC Driver DataSource > Custom properties**.
 - l. Set **oracleLogPackageName** to **oracle.jdbc.driver**.
 - m. Set **user** = **WLADMIN**.
 - n. Set **password** = **WLADMIN_password**.
 - o. Click **OK** and save the changes.
 - p. In **Resources > JDBC > Data sources**, select the new data source.
 - q. Click **WebSphere Application Server data source properties**.
 - r. Select the **Non-transactional data source** check box.
 - s. Click **OK**.
 - t. Click **Save**.
5. For WebSphere Application Server Network Deployment, click **System administration > Nodes**, select the nodes, and click **Full Synchronize**.

Configuring Apache Tomcat for Oracle manually for MobileFirst Server administration:

If you want to manually set up and configure your Oracle database for IBM MobileFirst Platform Server administration with the Apache Tomcat server, use the following procedure.

About this task

Complete the Oracle database setup procedure before continuing.

Procedure

1. Add the Oracle JDBC driver JAR file to the directory `$TOMCAT_HOME/lib`.
2. Prepare an XML statement that defines the data source, as shown in the following code example. Insert this statement in the `server.xml` file, as indicated in "Configuring Apache Tomcat for MobileFirst Server administration manually" on page 6-77

```
<Resource name="jdbc/WorklightAdminDS"
  auth="Container"
  type="javax.sql.DataSource"
  driverClassName="oracle.jdbc.driver.OracleDriver"
  url="jdbc:oracle:thin:@oserver:1521:ORCL"
  username="WLADMIN"
  password="WLADMIN_password"/>
```

Where **WLADMIN** after **username=** is the name of the system user with "CONNECT" access to the **WLADMIN** database that you have previously created, and **WLADMIN_password** after **password=** is this user's password. If you have defined either a different user name, or a different password, or both, replace these values accordingly.

Deploying the Administration Services and MobileFirst Operations Console and configuring the application server manually:

The procedure to deploy the Administration services and IBM MobileFirst Platform Operations Console manually to an application server depends on your application server.

These manual instructions assume that you are familiar with your application server.

Note: Using the MobileFirst Server installer to install MobileFirst Server administration is more reliable than installing manually and should be used whenever possible.

If you prefer to use the manual process, follow these steps to configure your application server for MobileFirst Server administration. You must deploy the `worklightconsole.war` and `worklightadmin.war` files to your MobileFirst Server administration. The files are located in `product_install_dir/WorklightServer`.

Configuring WebSphere Application Server Liberty profile for MobileFirst Server administration manually:

To configure WebSphere Application Server Liberty profile for MobileFirst Server administration manually, you must modify the `server.xml` file.

About this task

In addition to modifications for the databases, which are described in “Manually installing MobileFirst Server administration” on page 6-56, you must make the following modifications to the `server.xml` file.

Note: In the following procedure, when the example uses the `worklight.war` file name, use the name of your MobileFirst project, for example, `myProject.war`.

Procedure

1. Ensure that the `<featureManager>` element contains at least the following `<feature>` elements:

- For WebSphere Application Server Liberty profile V8.5.0.x:

```
<feature>ssl-1.0</feature>
<feature>servlet-3.0</feature>
<feature>jdbc-4.0</feature>
<feature>jndi-1.0</feature>
<feature>restConnector-1.0</feature>
<feature>appSecurity-1.0</feature>
```

- For WebSphere Application Server Liberty profile V8.5.5.0 and later:

```
<feature>jdbc-4.0</feature>
<feature>appSecurity-2.0</feature>
<feature>restConnector-1.0</feature>
```

2. Follow the instructions from the IBM WebSphere Application Server Liberty Core user documentation to configure the secure JMX connection.

3. Add the following global JNDI entries in the `server.xml` file:

```
<jndiEntry jndiName="ibm.worklight.admin.jmx.host" value="localhost"/>
<jndiEntry jndiName="ibm.worklight.admin.jmx.port" value="9443"/>
<jndiEntry jndiName="ibm.worklight.admin.jmx.user" value="WorklightRESTUser"/>
<jndiEntry jndiName="ibm.worklight.admin.jmx.pwd" value="WorklightRESTUserPassword"/>
<jndiEntry jndiName="ibm.worklight.topology.platform" value="Liberty"/>
<jndiEntry jndiName="ibm.worklight.topology.clustermode" value="Standalone"/>
```

Where:

- **ibm.worklight.admin.jmx.host** is the host name for the JMX REST connection.
- **ibm.worklight.admin.jmx.port** is the HTTPS port. You can find its value in the `httpEndpoint` element of the `server.xml` file.
- **ibm.worklight.admin.jmx.user** is a user with the `<administrator-role>` that you created in step 2.

- **ibm.worklight.admin.jmx.pwd** is the password of that user.
4. Modify the web container definition with the following values:
`<webContainer invokeFlushAfterService="false" deferServletLoad="false"/>`
 5. Declare a thread pool: Add the following `<executor>` declaration, or if the `server.xml` file has an `<executor>` declaration already, modify its `coreThreads` and `maxThreads` values accordingly.

```
<!-- Thread pool -->
<executor name="LargeThreadPool" id="default"
    coreThreads="200" maxThreads="400" keepAlive="60s"
    stealPolicy="STRICT" rejectedWorkPolicy="CALLER_RUNS"/>
```

6. Copy the following WAR files to the apps directory of the liberty server: `product_install_dir/WorklightServer/worklightadmin.war` and `product_install_dir/WorklightServer/worklightconsole.war`.

Note: the apps directory is in the same directory as the `server.xml` file.

7. Declare the Administration Services and MobileFirst Operations Console applications:

```
<!-- Declare the Administration Services application. -->
<application id="worklightadmin" name="worklightadmin" location="worklightadmin.war" type="war">
  <application-bnd>
    <security-role name="worklightadmin">
      <!-- This example adds a user to the worklightadmin security-role <user name="worklightUser"/> -->
    </security-role>
    <security-role name="worklightdeployer">
    </security-role>
    <security-role name="worklightmonitor">
    </security-role>
    <security-role name="worklightoperator">
    </security-role>
  </application-bnd>
  <classloader delegation="parentLast">
    <commonLibrary>
      <!-- Important: the version number of the following cryptographic JAR file might change
according to the version of WebSphere Application Server Liberty profile, or its fix packs -->
      <fileset dir="{wlp.install.dir}/lib" includes="com.ibm.ws.crypto.passwordutil_*.jar"/>
    </commonLibrary>
  </classloader>
</application>
```

```
<!-- Declare the MobileFirst Operations
Console application. -->
<application id="worklightconsole" name="worklightconsole" location="worklightconsole.war" type="war">
  <application-bnd>
    <security-role name="worklightadmin">
      <!-- This example adds a user to the worklightadmin security-role <user name="worklightUser"/> -->
    </security-role>
    <security-role name="worklightdeployer">
    </security-role>
    <security-role name="worklightmonitor">
    </security-role>
    <security-role name="worklightoperator">
    </security-role>
  </application-bnd>
</application>

<jndiEntry jndiName="worklightconsole/ibm.worklight.admin.endpoint" value="*:/*:*/worklightadmin"/>
```

Note: For more information about how to configure a user registry for Liberty profile, see [Configuring a user registry for the Liberty profile](#).

The JNDI property **worklightconsole/ibm.worklight.admin.endpoint** is prefixed by the context root of the MobileFirst Operations Console application, in this example `worklightconsole`. The value of this property is the end point to the MobileFirst administration.

The syntax `"*://*:*/worklightadmin"` means that the URL is the same as the one that is used to contact the MobileFirst Operations Console. However, the context root of the MobileFirst Operations Console is replaced by `worklightadmin`.

You might also specify the full endpoint, for example: `http://myhostname.mydomain.com:9080/worklightadmin`.

8. If the database is Oracle, add the **commonLibraryRef** attribute to the class loader of the `worklightadmin` application.

```
...
<classloader delegation="parentLast" commonLibraryRef="OracleLib">
  <commonLibrary>
...

```

The name of the library reference (`OracleLib` in this example) must be the ID of the library that contains the JDBC JAR file. This ID is declared in the procedure that is documented in “Configuring Liberty profile for Oracle manually for MobileFirst Server administration” on page 6-69.

Configuring WebSphere Application Server for MobileFirst Server administration manually:

To configure WebSphere Application Server for IBM MobileFirst Platform Server administration manually, you must configure variables, custom properties, and class loader policies.

Before you begin

These instructions assume that a stand-alone profile exists with an application server named “Worklight” and that the server is using the default ports.

Procedure

1. Log on to the WebSphere Application Server administration console for your MobileFirst Server.
The address is of the form `http://server.com:9060/ibm/console`, where *server* is the name of the server.
2. Enable application security.
 - a. Click **Security > Global Security**.
 - b. Ensure that **Enable administrative security** is selected. Application security can be enabled only if administrative security is enabled.
 - c. Ensure that **Enable application security** is selected.
 - d. Click **OK**.
 - e. Save the changes.

For more information, see Enabling security in WebSphere Application Server user documentation.

3. Review the server class loader policy: Click **Servers > Server Types > WebSphere application servers**, and select the server used for IBM MobileFirst Platform Foundation for iOS.
 - If the class loader policy is set to **Multiple**, do nothing.

- If the class loader policy is set to **Single** and the class loading mode is set to **parent-last**, do nothing.
 - If the class loader policy is set to **Single** and the class loading mode is set to **parent-first**, change the class loader policy to **Multiple**, and set the class loader order of all applications other than MobileFirst applications to **parent-first**.
4. Create the MobileFirst Server administration JDBC data source and provider. See the instructions in the appropriate subsection in “Manually installing MobileFirst Server administration” on page 6-56.
 5. If you install on WebSphere Application Server Network Deployment, find the SOAP port of the deployment manager by clicking System Administration/Deployment manager.
 - a. In **Additional properties**, open **Ports**.
 - b. Take note of the value SOAP_CONNECTOR_ADDRESS, because you need it to set the value of the `ibm.worklight.admin.jmx.dmgr.port` environment entry for the Administration Services.
 6. Install the Administration Services WAR file:
 - a. Depending on your version of WebSphere Application Server, click one of the following options:
 - **Applications > New > New Enterprise Application**
 - **Applications > New Application > New Enterprise Application**
 - b. Go to the MobileFirst Server installation directory `product_install_dir/WorklightServer`.
 - c. Select **worklightadmin.war**, and then click **Next**.
 - d. On the How do you want to install the application? page, click **Detailed**, and then click **Next**.
 - e. On the Application Security Warnings page, click **Continue**.
 - f. Click **Next** until you reach the Map resource references to resources page, and enter the JNDI name of the data source that you created in step 4.
 - g. Click **Next** until you reach the Map context roots for web modules page.
 - h. In the **Context Root** field, type `/worklightadmin`.
 - i. Click **Next**.
 - j. In Map environment entries for web modules:
 - If you install by using the Deployment Manager in the WebSphere Application Server Network Deployment product, enter the following values:
 - For the entry `ibm.worklight.admin.jmx.dmgr.host`, enter the host name of the deployment manager.
 - For the entry `ibm.worklight.admin.jmx.dmgr.port`, enter the SOAP port of the deployment manager that you noted in step 5.b.
 - For the entry `ibm.worklight.topology.platform`, enter WAS.
 - For the entry `ibm.worklight.topology.clustermode`, enter Cluster.
 - If you install on a stand-alone server:
 - For the entry `ibm.worklight.topology.platform`, enter WAS.
 - For the entry `ibm.worklight.topology.clustermode`, enter Standalone.
 - k. Click **Next** until you reach the last step, and click **Finish**.
 - l. Click **Save**.
 7. Configure the class loader policies for the Administration Services and then start the application:

- a. Click the **Manage Applications** link, or click **Applications > Applications Types > WebSphere enterprise applications**.
 - b. From the list of applications, click **worklightadmin_war**.
 - c. In the **Detail Properties** section, click the **Class loading and update detection** link.
 - d. In the **Class loader order** pane, click **Classes loaded with local class loader first (parent last)**.
 - e. Click **OK**.
 - f. In the **Detail Properties** section, click the **Startup behavior** link.
 - g. In **Startup Order**, enter 1, and click **OK**.
 - h. In the **Modules** section, click **Manage Modules**.
 - i. From the list of modules, click the **Worklight Administration Services** module.
 - j. In the **Class loader order** pane, click **Classes loaded with local class loader first (parent last)**.
 - k. Click **OK** twice.
 - l. Click **Save**.
 - m. Select **worklightadmin_war** and click **Start**.
8. Install the IBM MobileFirst Platform Operations Console WAR file.
 - a. Depending on your version of WebSphere Application Server, click one of the following options:
 - **Applications > New > New Enterprise Application**
 - **Applications > New Application > New Enterprise Application**
 - b. Go to the MobileFirst Server installation directory *product_install_dir/WorklightServer*.
 - c. Select **worklightconsole.war**, and then click **Next**.
 - d. On the How do you want to install the application? page, click **Detailed**, and then click **Next**.
 - e. On the Application Security Warnings page, click **Continue**.
 - f. Click **Next** until you reach the Map context roots for web modules page.
 - g. In the **Context Root** field, type `/worklightconsole`.
 - h. Click **Next**.
 - i. In Map environment entries for web modules, enter the value `*://*:*/worklightadmin` for the entry `ibm.worklight.admin.endpoint`.
 - j. Click **Next** until you reach the last step, and click **Finish**.
 - k. Click **Save**.
 9. Configure the class loader policies for the MobileFirst Operations Console and start the application:
 - a. Click the **Manage Applications** link, or click **Applications > Application Types > WebSphere enterprise applications**.
 - b. From the list of applications, click **worklightconsole_war**.
 - c. In the **Detail Properties** section, click the **Class loading and update detection** link.
 - d. In the **Class loader order** pane, click **Classes loaded with local class loader first (parent last)**.
 - e. Click **OK**.
 - f. In the **Detail Properties** section, click the **Startup behavior** link.

- g. In **Startup Order**, enter 1, and click **OK**.
- h. In the **Modules** section, click **Manage Modules**.
- i. From the list of modules, click the **Worklight Console** module.
- j. In the **Class loader order** pane, click **Classes loaded with local class loader first (parent last)**.
- k. Click **OK** twice.
- l. Click **Save**.
- m. Click **Applications > Application Types > WebSphere enterprise applications**.
- n. Select **Select** for **worklightconsole_war** and click **Start**.

Results

You can now access the MobileFirst Server administration at `http://<server>:<port>/worklightconsole`, where *server* is the host name of your server and *port* is the port number (by default 9080).

What to do next

For more steps to configure MobileFirst Server administration, see “Configuring WebSphere Application Server full profile for MobileFirst Server administration” on page 6-84.

Configuring Apache Tomcat for MobileFirst Server administration manually:

To configure Apache Tomcat for the MobileFirst Server administration manually, you must copy JAR and WAR files to Tomcat, add database drivers, edit the `server.xml` file, and then start Tomcat.

Before you begin

Prerequisites:

- Configure the database for MobileFirst Server administration. For more information about various databases configuration, see “Manually installing MobileFirst Server administration” on page 6-56.
- Define the `CATALINA_OPTS` options to enable Java Management Extensions (JMX) as described in “Configuring Apache Tomcat” on page 6-47.

Procedure

1. Edit `tomcat_install_dir/conf/server.xml` file.
 - a. Uncomment the following element, which is initially commented out:
`<Valve className="org.apache.catalina.authenticator.SingleSignOn" />`
 - b. Declare the MobileFirst Operations Console and Administration Services applications and a user registry:

```
<!-- Declare the Administration Services application. -->
<Context docBase="worklightadmin" path="/worklightadmin">

  <!-- Declare the JNDI environment entries for the Administration Services. -->
  <Environment name="ibm.worklight.topology.platform" value="Tomcat" type="java.lang.String" override="false"/>
  <Environment name="ibm.worklight.topology.clusterMode" value="Standalone" type="java.lang.String" override="false"/>

  <!-- Declare the administration database. -->
  <!-- <Resource name="jdbc/WorklightAdminDS" type="javax.sql.DataSource" ... /> -->

</Context>
```

```

<!-- Declare the MobileFirst Platform Operations Console application. -->
<Context docBase="worklightconsole" path="/worklightconsole">

  <!-- Declare the JNDI environment entries for the Operations Console. -->
  <Environment name="ibm.worklight.admin.endpoint" value="*://*/worklightadmin" type="java.lang.String" override="false"/>
</Context>

<!-- Declare the user registry for the MobileFirst Server administration.
The MemoryRealm recognizes the users defined in conf/tomcat-users.xml.
For other choices, see Apache Tomcat "Realm Configuration HOW-TO"
http://tomcat.apache.org/tomcat-7.0-doc/realms-howto.html . -->
<Realm className="org.apache.catalina.realm.MemoryRealm"/>

```

where you must uncomment and complete the <Resource> element to declare the administration database as described in one of the following sections:

- “Configuring Apache Tomcat for DB2 manually for MobileFirst Server administration” on page 6-60
- “Configuring Apache Tomcat for Derby manually for the MobileFirst Server administration” on page 6-63
- “Configuring Apache Tomcat for MySQL manually for MobileFirst Server administration” on page 6-67
- “Configuring Apache Tomcat for Oracle manually for MobileFirst Server administration” on page 6-71

2. Copy the MobileFirst Server administration WAR files to Tomcat.

- On UNIX and Linux systems:

```
cp product_install_dir/WorklightServer/*.war tomcat_install_dir/webapps
```

- On Windows systems:

```
copy /B product_install_dir\WorklightServer\worklightconsole.war tomcat_install_dir\webapps\worklightconsole.war
copy /B product_install_dir\WorklightServer\worklightadmin.war tomcat_install_dir\webapps\worklightadmin.war
```

3. Start Tomcat.

What to do next

For more steps to configure the MobileFirst Server administration, see “Configuring Apache Tomcat for MobileFirst Server administration” on page 6-86.

Defining the endpoint of the MobileFirst Administration services

If circumstances require the parameters of the endpoint definition to be changed, you must configure properties of the web application server appropriately.

MobileFirst Operations Console must be able to locate the MobileFirst Administration REST services and must be able to generate various URI for the entry points of web applications or for the download of audit log files.

By default, the URI protocol, host name, and port are the same as those defined in the web application server used to access MobileFirst Operations Console; the context root of the MobileFirst Administration REST services is `worklightadmin`. When the context root of the MobileFirst Administration REST services is changed or when the internal URI of the web application server is different from the external URI, and the external URI is used to access MobileFirst Operations Console, the externally accessible endpoint (protocol, host name, and port) must be defined by configuring the web application server. Reasons for separating internal and external URI could be, for example, a firewall or a secured reverse proxy that uses HTTP redirection.

The following figure shows a configuration with a secured reverse proxy that hides the internal address (192.168...) when MobileFirst Operations Console is accessed with the external address (wrklght.net).

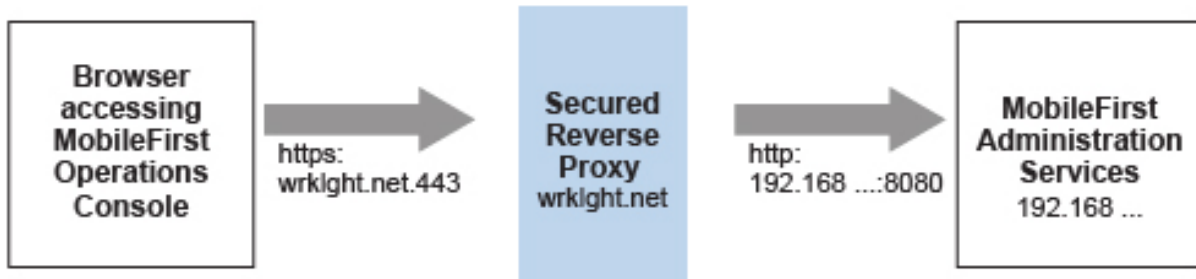

Figure 6-7. Configuration with secured reverse proxy

Table 6-22. The endpoint properties

Property name	Purpose	Example
ibm.worklight.admin.endpoint	This property enables MobileFirst Operations Console to locate the MobileFirst Administration REST services. The value of this property must be specified as the external address and context root of the worklightadmin.war web application. You can use the asterisk (*) character as wildcard for specifying that the MobileFirst Administration services use the same value as MobileFirst Operations Console. For example: <code>*://*:*/wladmin</code> means use the same protocol, host, and port as MobileFirst Operations Console, but use wladmin as context root. This property must be specified for the MobileFirst Operations Console application.	<code>https://wrklght.net:443/worklightadmin</code>
ibm.worklight.admin.proxy.protocol	If external access is required, this property specifies the protocol for external browsers to access the MobileFirst Administration services. This property must be specified for the MobileFirst Administration services application.	<code>https</code>
ibm.worklight.admin.proxy.host	If external access is required, this property specifies the host name for external browsers to access the MobileFirst Administration services. This property must be specified for the MobileFirst Administration services application.	<code>wrklght.net</code>

Table 6-22. The endpoint properties (continued)

Property name	Purpose	Example
ibm.worklight.admin.proxy.port	If external access is required, this property specifies the port for external browsers to access the MobileFirst Administration services. This property must be specified for the MobileFirst Administration services application.	443

Configuring the endpoint (WebSphere Application Server full profile):

Configure the endpoint of the application resources in the environment entries of MobileFirst Operations Console and the MobileFirst Administration services application.

About this task

Follow this procedure when you must change the endpoint of the MobileFirst Administration services.

Procedure

1. Log in to the WebSphere Application Server console.
2. Select **Applications > Application Types > WebSphere enterprise applications**.
3. Click **Worklight Administration Services**.
4. In the “Web Module Properties” section, select “Environment entries for Web modules”.
5. Assign the appropriate values for the following environment entries:
 - a. For **ibm.worklight.admin.proxy.host**, assign the host name.
 - b. For **ibm.worklight.admin.proxy.port**, assign the port number.
 - c. For **ibm.worklight.admin.proxy.protocol**, assign the external protocol.
6. Click **OK** and save the configuration.
7. Select **Applications > Application Types > WebSphere enterprise applications**.
8. Click **Worklight Console**.
9. In the “Web Module Properties” section, select “Environment entries for Web modules”.
10. For **ibm.worklight.admin.endpoint**, assign the full URI of the MobileFirst Administration services; That is, the URI of the `worklightadmin.war` file.
 - In a scenario with a firewall or a secured reverse proxy, this URI must be the external URI and not the internal URI inside the local LAN.
 - You can use the asterisk (*) character as wildcard for specifying that the MobileFirst Administration services use the same value as MobileFirst Operations Console. For example, `*://*/*/wladmin` means use the same protocol, host, and port as MobileFirst Operations Console, but use `wladmin` as context root.
11. Click **OK** and save the configuration. For a complete list of JNDI properties that you can set, see “List of JNDI properties for MobileFirst Server administration” on page 6-86.

Configuring the endpoint (Liberty profile):

For the Liberty profile, configure the endpoint of the application resources through the JNDI environment.

About this task

Follow this procedure when you must change the endpoint of MobileFirst Administration services. The appropriate entries in the `server.xml` file must be correctly defined.

Procedure

1. Ensure that the `<feature>` element in the `server.xml` file is correctly defined to be able to define JNDI entries.

```
<feature>jndi-1.0</feature>
```

2. In the `<server>` section of the `server.xml` file, add an entry for each required property. Each such entry should have the following syntax:

```
<jndiEntry jndiName="JNDI_property_name" value="property_value"/>
```

Where:

- `JNDI_property_name` is the name of the property that you are adding.
- `property_value` is the value of the property that you are adding.

For a complete list of JNDI properties that you can set, see “List of JNDI properties for MobileFirst Server administration” on page 6-86.

Example of setting properties for configuring the endpoint

This example shows the settings of the properties in the `server.xml` file that are required for configuring the endpoint of the application resources.

```
<jndiEntry jndiName="worklightconsole/ibm.worklight.admin.endpoint"
  value="https://wrklght.net:443/worklightadmin" />
<jndiEntry jndiName="worklightadmin/ibm.worklight.admin.proxy.protocol"
  value="https" />
<jndiEntry jndiName="worklightadmin/ibm.worklight.admin.proxy.host"
  value="wrklght.net" />
<jndiEntry jndiName="worklightadmin/ibm.worklight.admin.proxy.port"
  value="443" />
```

In this example, assume that the context root of MobileFirst Operations Console is `worklightconsole` and that the context root of the Administration Services is `worklightadmin`. You can prefix the JNDI properties with the context root of the corresponding web application. If multiple instances of MobileFirst Server are running in the same web application server, this technique is particularly useful. If you have only one instance of MobileFirst Server, you can omit the context root prefix; for example:

```
<jndiEntry jndiName="ibm.worklight.admin.endpoint"
  value="https://wrklght.net:443/worklightadmin" />
<jndiEntry jndiName="ibm.worklight.admin.proxy.protocol"
  value="https" />
<jndiEntry jndiName="ibm.worklight.admin.proxy.host"
  value="wrklght.net" />
<jndiEntry jndiName="ibm.worklight.admin.proxy.port"
  value="443"/>
```

For `ibm.worklight.admin.endpoint`, you can use the asterisk (*) character as wildcard for specifying that the MobileFirst Administration services use the same value as MobileFirst Operations Console. For example, `*://*:*/w/admin` means use

the same protocol, host, and port as MobileFirst Operations Console, but use wladmin as context root.

Configuring the endpoint (Apache Tomcat):

For the Apache Tomcat server, configure the endpoint of the application resources in the `server.xml` file.

About this task

Follow this procedure when you must change the endpoint of the MobileFirst Administration services. You must edit the `server.xml` file in the `conf` directory of your Apache Tomcat installation.

Procedure

In the `server.xml` file in the `conf` directory of your Apache Tomcat installation, add an entry for each property in the `<context>` section of the corresponding application. Each entry should have the following syntax:

```
<Environment name="JNDI_property_name" value="property_value" type="property_type" override="false"/>
```

Where:

- `JNDI_property_name` is the name of the property that you are adding.
- `property_value` is the value of the property that you are adding.
- `property_type` is the value of the type of property that you are adding.

For a complete list of JNDI properties that you can set, see “List of JNDI properties for MobileFirst Server administration” on page 6-86.

Example of setting `server.xml` properties for configuring the endpoint

This example shows the settings of the properties in the `server.xml` file that are required for configuring the endpoint of the application resources.

In the `context` section of the MobileFirst Operations Console application:

```
<Environment name="ibm.worklight.admin.endpoint" value="https://wrklight.net:443/worklightadmin" type="java.lang.String" override="false"/></p>
```

For **`ibm.worklight.admin.endpoint`**, you can use the asterisk (*) character as wildcard for specifying that the MobileFirst Administration services use the same value as MobileFirst Operations Console. For example, `*://*:*/*/wladmin` means use the same protocol, host, and port as MobileFirst Operations Console, but use wladmin as context root.

In the `<context>` section of the MobileFirst Administration Services application, you can write:

```
<Environment name="ibm.worklight.admin.proxy.protocol" value="https" type="java.lang.String" override="false"/>
<Environment name="ibm.worklight.admin.proxy.host" value="wrklight.net" type="java.lang.String" override="false"/>
<Environment name="ibm.worklight.admin.proxy.port" value="443" type="java.lang.Integer" override="false"/>
```

Configuring user authentication for MobileFirst Server administration

You configure user authentication and choose an authentication method. Configuration procedure depends on the web application server that you use.

The MobileFirst Server administration requires user authentication.

You must perform configuration after the installer deploys the MobileFirst Server administration web applications in the web application server.

The MobileFirst Server administration has the following Java Platform, Enterprise Edition (Java EE) security roles defined:

worklightadmin

worklightdeployer

worklightoperator

worklightmonitor

You must map the roles to the corresponding sets of users. The **worklightmonitor** role can view data but cannot change any data. The purpose of the roles is illustrated by the following table.

Table 6-23. MobileFirst Roles and Functionality - Production Server

	Administrator	Deployer	Operator	Monitor
Java EE security role.	worklightadmin	worklightdeployer	worklightoperator	worklightmonitor
Deployment				
Deploy an application.	Y	Y		
Deploy an adapter.	Y	Y		
MobileFirst Server Management				
Configure runtime settings.	Y	Y		
Application Management				
Upload new MobileFirst application.	Y	Y		
Remove MobileFirst application.	Y	Y		
Upload new MobileFirst adapter.	Y	Y		
Remove MobileFirst adapter.	Y	Y		
Turn on or off application authenticity testing for an application.	Y	Y		
Change properties on MobileFirst application status: Active, Active Notifying, and Disabled.	Y	Y	Y	

Table 6-23. MobileFirst Roles and Functionality - Production Server (continued)

	Administrator	Deployer	Operator	Monitor
Lock an application so the new artifacts cannot be used for a version.	Y	Y	Y	
Notifications				
Unsubscribe a device from SMS notification.	Y		Y	
Configure Push.	Y	Y		
Logging				
Enable and disable device logging remotely.	Y	Y	Y	
Configure log levels.	Y	Y	Y	
Disable the specific device, marking the state as lost or stolen so that access from any of the applications on that device is blocked.	Y	Y	Y	
Disable a specific application, marking the state as disabled so that access from the specific application on that device is blocked.	Y	Y		

If you choose to use an authentication method through a user repository such as LDAP, you can configure the MobileFirst Server administration so that you can use users and groups with the user repository to define the Access Control List (ACL) of the MobileFirst Server administration. This procedure is conditioned by the type and version of the web application server that you use.

Configuring WebSphere Application Server full profile for MobileFirst Server administration:

Configure security by mapping the MobileFirst Server administration Java EE roles to a set of users for both web applications.

Procedure

You define the basics of user configuration in the WebSphere Application Server console. Access to the console is usually by this address:
<https://localhost:9043/ibm/console/>

1. Select **Security > Global Security**.
2. Select **Security Configuration Wizard** to configure users.

You can manage individual user accounts by selecting **Users and Groups > Manage Users**.

3. Map the roles **worklightadmin**, **worklightdeployer**, **worklightmonitor**, and **worklightoperator** to a set of users.
 - a. Select **Servers > Server Types > WebSphere application servers**.
 - b. Select the server.
 - c. In the **Configuration** tab, select **Applications > Enterprise applications**.
 - d. Select **IBM_Worklight_Administration_Services**.
 - e. In the **Configuration** tab, select **Details > Security role to user/group mapping**.
 - f. Perform the necessary customization.
 - g. Click **OK**.
 - h. Repeat steps c to g to map the roles for the console web application. In step d, select **IBM_Worklight_Console**.
 - i. Click **Save** to save the changes.

Configuring WebSphere Application Server Liberty profile for MobileFirst Server administration:

Configure the Java EE security roles of the MobileFirst Server administration and the data source in the `server.xml` file.

Before you begin

In WebSphere Application Server Liberty profile, you configure the roles of **worklightadmin**, **worklightdeployer**, **worklightmonitor**, and **worklightoperator** in the `server.xml` configuration file of the server.

About this task

To configure the security roles, you must edit the `server.xml` file. In the `<application-bnd>` element of each `<application>` element, create `<security-role>` elements. Each `<security-role>` element is for each role: **worklightadmin**, **worklightdeployer**, **worklightmonitor**, and **worklightoperator**. Map the roles to the appropriate user group name, in this example: **worklightadmingroup**, **worklightdeployergroup**, **worklightmonitorgroup**, or **worklightoperatorgroup**. These groups are defined through the `<basicRegistry>` element. You can customize this element or replace it entirely with an `<ldapRegistry>` element or a `<safRegistry>` element.

Then, to maintain good response times with a large number of installed applications, for example with 80 applications, you should configure a connection pool for the administration database.

Procedure

1. Edit the `server.xml` file.

For example:

```
<security-role name="worklightadmin">
  <group name="worklightadmingroup"/>
</security-role>
<security-role name="worklightdeployer">
  <group name="worklightdeployergroup"/>
</security-role>
<security-role name="worklightmonitor">
  <group name="worklightmonitorgroup"/>
</security-role>
<security-role name="worklightoperator">
```

```

    <group name="worklightoperatorgroup"/>
</security-role>

<basicRegistry id="worklightadmin">
  <user name="admin" password="admin"/>
  <user name="guest" password="guest"/>
  <user name="demo" password="demo"/>
  <group name="worklightadmingroup">
    <member name="guest"/>
    <member name="demo"/>
  </group>
  <group name="worklightdeployergroup">
    <member name="admin" id="admin"/>
  </group>
  <group name="worklightmonitorgroup"/>
  <group name="worklightoperatorgroup"/>
</basicRegistry>

```

2. Edit the server.xml file to define the **AppCenterPool** size.

```
<connectionManager id="AppCenterPool" minPoolSize="10" maxPoolSize="40"/>
```

3. In the <dataSource> element, define a reference to the connection manager:

```

<dataSource id="WLADMIN" jndiName="jdbc/WorklightAdminDS" connectionManagerRef="AppCenterPool">
  ...
</dataSource>

```

Configuring Apache Tomcat for MobileFirst Server administration:

You must configure the Java EE security roles for the MobileFirst Server administration on the Apache Tomcat web application server.

Procedure

1. If you installed the MobileFirst Server administration manually, declare the following roles in the conf/tomcat-users.xml file.

```

<role rolename="worklightadmin"/>
<role rolename="worklightmonitor"/>
<role rolename="worklightdeployer"/>
<role rolename="worklightoperator"/>

```

2. Add roles to the selected users, for example:

```
<user name="demo" password="demo" roles="worklightadmin"/>
```

3. You can define the set of users as described in the Apache Tomcat documentation, Realm Configuration HOW-TO.

List of JNDI properties for MobileFirst Server administration

When you configure MobileFirst Server Administration Services and MobileFirst Operations Console for your application server, you set optional or mandatory JNDI properties, in particular for Java Management Extensions (JMX).

JNDI properties for MobileFirst Administration Services

The following properties can be set on the Administration Services web application worklightadmin.war.

Table 6-24. JNDI properties for Administration Services: JMX

Property	Optional or mandatory	Description	Restrictions
ibm.worklight.admin.jmx.connector	Optional	The Java Management Extensions (JMX) connector type. The possible values are SOAP and RMI. The default value is SOAP.	WebSphere Application Server only.
ibm.worklight.admin.jmx.host	Optional	Host name for the JMX REST connection.	Liberty profile only.
ibm.worklight.admin.jmx.port	Optional	Port for the JMX REST connection.	Liberty profile only.
ibm.worklight.admin.jmx.user	Optional	User name for the JMX REST connection.	WebSphere Application Server Liberty profile: User name for the JMX REST connection. WebSphere Application Server Farm: User name for the SOAP connection.
ibm.worklight.admin.jmx.pwd	Optional	User password for the JMX REST connection.	WebSphere Application Server Liberty profile: User password for the JMX REST connection. WebSphere Application Server Farm: User password for the SOAP connection.
ibm.worklight.admin.rmi.registryPort	Optional	RMI registry port for the JMX connection through a firewall.	Tomcat only.
ibm.worklight.admin.rmi.serverPort	Optional	RMI server port for the JMX connection through a firewall.	Tomcat only.
ibm.worklight.admin.jmx.dmgr.host	Mandatory	Deployment manager host name.	WebSphere Application Server Network Deployment only.
ibm.worklight.admin.jmx.dmgr.port	Mandatory	Deployment manager RMI or SOAP port.	WebSphere Application Server Network Deployment only.

Table 6-25. JNDI properties for Administration Services: time out

Property	Optional or mandatory	Description
ibm.worklight.admin.actions.prepareTimeout	Optional	Timeout in milliseconds to transfer data from the management service to the runtime during a deployment transaction. If the runtime cannot be reached within this time, an error is raised and the deployment transaction ends. Default value: 1800000 ms (30 min)

Table 6-25. JNDI properties for Administration Services: time out (continued)

Property	Optional or mandatory	Description
ibm.worklight.admin.actions.commitRejectTimeout	Optional	Timeout in milliseconds, when a runtime is contacted, to commit or reject a deployment transaction. If the runtime cannot be reached within this time, an error is raised and the deployment transaction ends. Default value: 120000 ms (2 min)
ibm.worklight.admin.lockTimeoutInMillis	Optional	Timeout in milliseconds for obtaining the transaction lock. Because deployment transactions run sequentially, they use a lock. Therefore, a transaction must wait until a previous transaction is finished. This timeout is the maximal time during which a transaction waits. Default value: 1200000 ms (20 min)
ibm.worklight.admin.maxLockTimeInMillis	Optional	The maximal time during which a process can take the transaction lock. Because deployment transactions run sequentially, they use a lock. If the application server fails while a lock is taken, it can happen in rare situations that the lock is not released at the next restart of the application server. In this case, the lock is released automatically after the maximum lock time so that the server is not blocked forever. Set a time that is longer than a normal transaction. Default value: 1800000 (30 min)

Table 6-26. JNDI properties for Administration Services: logging

Property	Optional or mandatory	Description
ibm.worklight.admin.logging.formatjson	Optional	Set this property to true to enable pretty formatting (extra blank space) of JSON objects in responses and log messages. Setting this property is helpful when you debug the server. Default value: false.
ibm.worklight.admin.logging.tosystemerror	Optional	Specifies whether all logging messages are also directed to System.Error. Setting this property is helpful when you debug the server.

Table 6-27. JNDI properties for Administration Services: proxies

Property	Optional or mandatory	Description
ibm.worklight.admin.proxy.port	Optional	If the MobileFirst Administration server is behind a firewall or reverse proxy, this property specifies the address of the host. Set this property to enable a user outside the firewall to reach the MobileFirst Administration server. Typically, this property is the port of the proxy, for example 443. It is necessary only if the protocol of the external and internal URIs are different.
ibm.worklight.admin.proxy.protocol	Optional	If the MobileFirst Administration server is behind a firewall or reverse proxy, this property specifies the protocol (HTTP or HTTPS). Set this property to enable a user outside the firewall to reach the MobileFirst Administration server. Typically, this property is set to the protocol of the proxy. For example, w1.net. This property is necessary only if the protocol of the external and internal URIs are different.
ibm.worklight.admin.proxy.scheme	Optional	This property is just an alternative name for ibm.worklight.admin.proxy.protocol .
ibm.worklight.admin.proxy.host	Optional	If the MobileFirst Administration server is behind a firewall or reverse proxy, this property specifies the address of the host. Set this property to enable a user outside the firewall to reach the MobileFirst Administration server. Typically, this property is the address of the proxy.

Table 6-28. JNDI properties for Administration Services: topologies

Property	Optional or mandatory	Description
ibm.worklight.admin.audit	Optional.	Set this property to false to disable the audit feature of the MobileFirst Operations Console. The default value is true.
ibm.worklight.admin.environmentid	Optional.	Environment identifier for the registration of the MBeans. Use this identifier when different instances of the MobileFirst Server are installed on the same application server. The identifier determines which Administration Services, which console, and which runtimes belong to the same installation. The Administration Services manage only the runtimes that have the same environment identifier.
ibm.worklight.admin.serverid	Optional.	Server identifier. Must be different for each server in the farm. For server farms only.
ibm.worklight.admin.hsts	Optional.	Set to true to enable HTTP Strict Transport Security according to RFC 6797.

Table 6-28. JNDI properties for Administration Services: topologies (continued)

Property	Optional or mandatory	Description
ibm.worklight.topology.platform	Mandatory	<p>Server type. Valid values:</p> <ul style="list-style-type: none"> • Liberty • WAS • Tomcat <p>If you do not set the value, the application tries to guess the server type.</p>
ibm.worklight.topology.clustermode	Mandatory	<p>In addition to the server type, specify here the server topology. Valid values:</p> <ul style="list-style-type: none"> • Standalone • Cluster • Farm <p>The default value is Standalone.</p>
ibm.worklight.admin.lock.master	Optional	<p>In cluster and farm topologies, this property determines which server is the lock master when the Cloudant database is used.</p> <p>For synchronization, the system requires a locking mechanism that works across all servers in the farm or cluster.</p> <p>SQL data bases have native locking facilities, but Cloudant has none. Therefore, with Cloudant only one of the servers in the farm or cluster provides the locking mechanism. This server is called the lock master.</p> <p>Alternative ways of using this property are available:</p> <ul style="list-style-type: none"> • You set this property to auto on all servers. The locking master is chosen and updated dynamically, depending on server availability. • You set this property to true on one server only and to false on all the other servers. In this configuration, the server where the property has the value true is the lock master. <p>In WebSphere Application Server Network Deployment topologies, setting the property to true must be done through a JVM property of the server.</p> <p>Note: This use creates a single point of failure. When the lock master is unavailable, MobileFirst Administration does not function.</p> <p>The default value is auto.</p>

Table 6-28. JNDI properties for Administration Services: topologies (continued)

Property	Optional or mandatory	Description
ibm.worklight.admin.lock.master.detection.delay	Optional	<p>This property determines the time in milliseconds to wait on startup until Cloudant is ready, before any locking operation can take place. This property is only needed in cluster or farm topology when the database is Cloudant. For synchronization, the system requires a locking mechanism that works across all servers in the farm or cluster.</p> <p>SQL databases have native locking facilities, but Cloudant has none. Therefore, with Cloudant one of the servers in the farm or cluster provides the locking mechanism.</p> <p>This lock master server can be selected automatically with the help of the database. This automatic selection requires a small delay, similar to the setting of mfp.db.cloudant.afterWrite.delay, to ensure that the Cloudant database is in a consistent state. This delay occurs only once when the server starts. Reasonable values are between 1 and 10 seconds. Negative values are ignored. The default value is 3000 (three seconds).</p>
ibm.worklight.admin.lock.master.detection.timeout	Optional	<p>This property determines the timeout in seconds for the detection of the lock master. This property is only needed in cluster or farm topology when the database is Cloudant. For synchronization, the system requires a locking mechanism that works across all servers in the farm or cluster.</p> <p>SQL databases have native locking facilities, but Cloudant has none. Therefore, with Cloudant one of the servers in the farm or cluster provides the locking mechanism.</p> <p>During startup, the lock master server must come alive before all the other servers. Therefore, the other servers wait for this server before they complete their startup.</p> <p>This timeout value specifies the maximum time another server waits for the lock master to come alive. Negative values are ignored. The default value is 120 (two minutes).</p>

Table 6-28. JNDI properties for Administration Services: topologies (continued)

Property	Optional or mandatory	Description
ibm.worklight.admin.lock.master.connect.timeout	Optional	<p>This property determines the timeout in seconds for the connection to the lock master. This property is only needed in cluster or farm topology when the database is Cloudant. For synchronization, the system requires a locking mechanism that works across all servers in the farm or cluster.</p> <p>SQL databases have native locking facilities, but Cloudant has none. Therefore, with Cloudant one of the servers in the farm or cluster provides the locking mechanism. That server is called the lock master.</p> <p>The timeout value specifies the maximum time another server waits for the lock master to respond to requests to take a lock. Negative values are ignored. The default value is 10 (seconds).</p>
ibm.worklight.admin.farm.heartbeat	Optional	<p>This property enables you to set in minutes the heartbeat rate that is used in server farm topologies.</p> <p>The default value is 2 minutes.</p> <p>In a server farm, all members must use the same heartbeat rate. If you set or change this JNDI value on one server in the farm, you must also set the same value on every other server in the farm.</p> <p>For more information, see “Lifecycle of a server farm node” on page 6-103.</p>
ibm.worklight.admin.farm.missed.heartbeats.timeout	Optional	<p>This property enables you to set the number of missed heartbeats of a farm member before the status of the farm member is considered to be failed or down.</p> <p>The default value is 2.</p> <p>In a server farm all members must use the same missed heartbeat value. If you set or change this JNDI value on one server in the farm, you must also set the same value on every other server in the farm.</p> <p>For more information, see “Lifecycle of a server farm node” on page 6-103.</p>

Table 6-28. JNDI properties for Administration Services: topologies (continued)

Property	Optional or mandatory	Description
ibm.worklight.admin.cloudant.dashboard.url	Optional	This property defines the URL of the Cloudant dashboard, such as the dashboard of the Cloudant account that you use for the MobileFirst data proxy. If this property is set, a link will be displayed in the header of MobileFirst Operations Console.

Table 6-29. JNDI properties for Administration Services: relational database

Property	Optional or mandatory	Description
ibm.worklight.admin.db.jndi.name	Optional	The JNDI name of the database. This parameter is the normal mechanism to specify the database. The default value is <code>java:comp/env/jdbc/WorklightAdminDS</code> .
ibm.worklight.admin.db.openjpa.ConnectionDriverName	Optional Conditionally mandatory	The fully qualified name of the database connection driver class. Mandatory only when the data source that is specified by the ibm.worklight.admin.db.jndi.name property is not defined in the application server configuration.
ibm.worklight.admin.db.openjpa.ConnectionURL	Optional Conditionally mandatory	The URL for the database connection. Mandatory only when the data source that is specified by the ibm.worklight.admin.db.jndi.name property is not defined in the application server configuration.
ibm.worklight.admin.db.openjpa.ConnectionUserName	Optional Conditionally mandatory	The user name for the database connection. Mandatory only when the data source that is specified by the ibm.worklight.admin.db.jndi.name property is not defined in the application server configuration.
ibm.worklight.admin.db.openjpa.ConnectionPassword	Optional Conditionally mandatory	The password for the database connection. Mandatory only when the data source that is specified by the ibm.worklight.admin.db.jndi.name property is not defined in the application server configuration.
ibm.worklight.admin.db.openjpa.Log	Optional	This property is passed to OpenJPA and enables JPA logging. For more information, see the Apache OpenJPA User's Guide.
ibm.worklight.admin.db.type	Optional	This property defines the type of database. The default value is inferred from the connection URL.

Table 6-30. JNDI properties for Administration Services: IBM Cloudant database

Property	Optional or mandatory	Description
mfp.db.cloudant.url	Optional	This property defines the URL of the Cloudant account used to store the database. The default value is <code>https://username.cloudant.com</code> .
mfp.db.cloudant.username	Optional Conditionally mandatory	This property defines the user name of the Cloudant account used to store the database. If this property is not defined, a relational database is used.
mfp.db.cloudant.password	Optional Conditionally mandatory	This property defines the password of the Cloudant account used to store the database. This property must be set when mfp.db.cloudant.username is set.
mfp.db.cloudant.ssl.authentication	Optional	This property specifies whether the SSL certificate chain validation and host name verification are enabled for HTTPS connections to the Cloudant database. The value is a Boolean value (true or false). The default value is true. Note: Setting this property to false creates security risks.
mfp.db.cloudant.ssl.configuration	Optional	This property applies to WebSphere Application Server full profile only. For HTTPS connections to the Cloudant database, it specifies the name of an SSL configuration in the WebSphere Application Server configuration to use when no configuration is specified for the host and port.
mfp.db.cloudant.proxyHost	Optional	This property defines the host name of an HTTP proxy for the connection to the Cloudant database server.
mfp.db.cloudant.proxyPort	Optional	This property defines the port of an HTTP proxy for the connection to the Cloudant database server.
mfp.db.cloudant.adminDbName	Optional	This property defines the name of the database for MobileFirst Administration Services in the Cloudant account. The name must start with a lowercase letter and contain only lowercase letters and any of the following characters: 0-9 , \$ - _ The default name is <code>mfp_admin_db</code> .

Table 6-30. JNDI properties for Administration Services: IBM Cloudant database (continued)

Property	Optional or mandatory	Description
mfp.db.cloudant.connectTimeout	Optional	This property defines the timeout in milliseconds for establishing a network connection for Cloudant. A value of zero means an infinite timeout. A negative value means the default value (no override).
mfp.db.cloudant.socketTimeout	Optional	This property defines the timeout in milliseconds for detecting the loss of a network connection for Cloudant. A value of zero means an infinite timeout. A negative value means the default value (no override).
mfp.db.cloudant.maxConnections	Optional	This property defines the maximum number of simultaneous connections to the Cloudant database.
mfp.db.cloudant.afterWrite.fullCommit	Optional	This property specifies whether an "ensure full commit" operation is used after every write operation to the Cloudant database. The possible values are: true, false. The default value is false.
mfp.db.cloudant.afterWrite.delay	Optional	This property specifies in milliseconds how long to wait after every write operation to the Cloudant database. A value of zero means no wait. The default value is 0.
mfp.db.cloudant.retry.count	Optional	This property specifies the number of times to retry a Cloudant database query operation until it satisfies the expectations known from the context. The default value is 2.
mfp.db.cloudant.retry.delay	Optional	This property specifies in milliseconds how long to wait before retrying a Cloudant database query operation. A value of 0 means no wait. The default value is 0.
mfp.db.cloudant.documentOperation.timeout	Optional	This property specifies in seconds the timeout for the completion of operations on Cloudant documents. A value of zero means an infinite timeout. A negative value means the default value (no override). The default value is 30 seconds.
mfp.db.cloudant.attachmentOperation.timeout	Optional	This property specifies in seconds the timeout for the completion of operations on Cloudant attachments. A value of zero means an infinite timeout. A negative value means the default value (no override). The default value is 600 seconds (10 minutes).

JNDI properties for MobileFirst Operations Console

The following properties can be set on the web application (`worklightconsole.war`) of MobileFirst Operations Console.

Table 6-31. JNDI properties for the MobileFirst Operations Console

Property	Optional or mandatory	Description
<code>ibm.worklight.admin.endpoint</code>	Optional	Enables the MobileFirst Operations Console to locate the MobileFirst Server Administration REST services. Specify the external address and context root of the <code>worklightadmin.war</code> web application. In a scenario with a firewall or a secured reverse proxy, this URI must be the external URI and not the internal URI inside the local LAN. For example, <code>https://wl.net:443/worklightadmin</code> .
<code>ibm.worklight.admin.global.logout</code>	Optional	Clears the WebSphere user authentication cache during the console logout. This property is useful only for WebSphere Application Server V7. The default value is <code>false</code> .
<code>ibm.worklight.admin.hsts</code>	Optional	Set this property to <code>true</code> to enable HTTP Strict Transport Security according to RFC 6797. For more information, see the W3C Strict Transport Security page. The default value is <code>false</code> .
<code>ibm.worklight.admin.ui.cors</code>	Optional	The default value is <code>true</code> . For more information, see the W3C Cross-Origin Resource Sharing page.
<code>ibm.worklight.admin.ui.cors.strictssl</code>	Optional	Set to <code>false</code> to allow CORS situations where the MobileFirst Operations Console is secured with SSL (HTTPS protocol) while the MobileFirst Server Administration services are not, or conversely. This property takes effect only if the <code>ibm.worklight.admin.ui.cors</code> property is enabled.

Configuring the JNDI properties

For more information about how to configure the JNDI properties, see the topic “Configuring a MobileFirst project in production by using JNDI environment entries” on page 10-60.

To configure the properties with Ant tasks, you must use the Ant task `installworklightadmin`, instead of `configureapplicationserver`.

For the console, the property element should be under the console element.

For more information, see “Ant tasks for installation of MobileFirst Operations Console and Administration Services” on page 14-10.

Related tasks:

JNDI environment entries for MobileFirst projects in production

When you deploy a MobileFirst project to a MobileFirst Server, you can configure the project’s WAR file with JNDI environment entries to set product environment properties.

Verifying the installation of MobileFirst Server administration

You must log in to the MobileFirst Operations Console to verify that the installation was successful.

Procedure

1. Open a web browser.
2. Enter the following URL in the address bar: `http://hostname:9083/worklightconsole/`.

Note:

- In this URL, *hostname* is the host name of the computer that runs your application server.
 - You must replace *9083* by the HTTP port of your application server.
3. Log in with a **worklightadmin** user role.
 4. The console displays the following message: **No runtime can be found..** To install a MobileFirst runtime environment that you can manage with the MobileFirst Operations Console, see “Installing the MobileFirst runtime environment.”

Note: If the Application Center and MobileFirst Operations Console are installed in the same Tomcat instance, you cannot log in to the Application Center console and to the MobileFirst Operations Console at the same time in the same browser. If you try to log in at the same time, you get a 404 Page Not Found error message.

For example, you get this error message if you open your browser, successfully log in to the Application Center console, open a new tab in the browser, and log in to the MobileFirst Operations Console.

This is a technical limitation of Tomcat. The implementation of single sign-on in Tomcat does not allow to use the same browser to log in to the Application Center console and to the MobileFirst Operations Console at the same time. But the Application Center and MobileFirst Server require single sign-on. You must exit the browser after your work is done in the Application Center console and restart the browser to log in to the MobileFirst Operations Console. You can then successfully log in to the MobileFirst Operations Console.

Installing the MobileFirst runtime environment

About this task

For more information about the MobileFirst runtime environment, see “Deploying the project WAR file” on page 10-5.

Installing a server farm

MobileFirst Server provides a specific plug-in so that instances of application servers can become server farm nodes. After you have prepared the installation depending on your work environment, you can install your server farm manually or by running Ant tasks.

Planning the configuration of a server farm

To plan the configuration of a server farm, choose the application server, write the configuration file, and deploy the WAR files.

When you intend to plan a server farm installation, you should first see “Planning deployment of administration components and runtimes” on page 6-7, and in particular see “Server farm topology” on page 6-11.

In IBM MobileFirst Platform Foundation for iOS, a server farm is composed of multiple stand-alone application servers that are not federated or administered by a managing component of an application server. MobileFirst Server internally provides a farm plug-in as the means to enhance an application server so that it can be part of a server farm.

When to declare a server farm

Declare a server farm in the following cases:

- MobileFirst Server is installed on multiple Tomcat application servers.
- MobileFirst Server is installed on multiple WebSphere Application Server servers but not on WebSphere Application Server Network Deployer.
- MobileFirst Server is installed on multiple WebSphere Application Server Liberty servers.

Do not declare a server farm in the following cases:

- Your application server is stand-alone.
- Multiple application servers are federated by WebSphere Application Server Network Deployment.

Why it is mandatory to declare a farm

Each time a management operation is performed through the MobileFirst Operations Console or through the MobileFirst Administration Services application, the operation needs to be replicated to all instances of a runtime environment. Examples of such management operations are the uploading of a new version of a wlap or of an adapter. The replication is done via JMX calls performed by the MobileFirst Administration Services application instance that handles the operation. The Administration Service needs to contact all runtime instances in the cluster. In environments listed under “When to declare a server farm,” the runtime can be contacted through JMX only if a farm is configured. If a server is added to a cluster without proper configuration of the farm, the runtime in that server will be in an inconsistent state after each management operation, and until it is restarted again.

Configuring a server farm

You must configure each server in the farm according to the requirements of the single type of application server used for each member of the server farm.

About this task

When you plan a server farm, first create stand-alone servers that communicate with the same database instance. Then modify the configuration of these servers to make them members of a server farm.

Procedure

1. Choose the type of application server to use to configure the members of the server farm. IBM MobileFirst Platform Foundation for iOS supports these application servers in server farms:
 - WebSphere Application Server full profile.

Note: In a farm topology, you cannot use the RMI JMX connector. In this topology, IBM MobileFirst Platform Foundation for iOS supports only the SOAP connector.

- WebSphere Application Server Liberty profile.
- Apache Tomcat.

To know which versions of application servers are supported, see “System requirements” on page 2-7.

Note: IBM MobileFirst Platform Foundation for iOS supports only homogeneous server farms. A server farm is homogeneous when it connects application servers of the same type. Attempting to associate different types of application servers could lead to unpredictable behavior at run time. For example, a farm with a mix of Apache Tomcat servers and WebSphere Application Server full profile servers is an invalid configuration.

2. Decide which database that you want to use. You can choose from:

- DB2
- MySQL
- Oracle

MobileFirst databases are shared between the application servers in a farm, which means:

- You create the database only once, whatever the number of servers in the farm.
- You cannot use the Derby database in a farm topology, because the Derby database allows only a single connection at a time.

For more information about databases, see “Planning the creation of the databases” on page 6-19.

3. Set up as many stand-alone servers as the number of members that you want in the farm. Each of these stand-alone servers must communicate with the same database. You must make sure that any port used by any of these servers is not also used by another server configured on the same machine. This constraint applies to the ports used by http, https, REST, SOAP, and RMI protocols.

To set up the servers, you can choose one of the following methods of installation:

- Install them by using the Server Configuration Tool.
- Install them by using configuration Ant scripts.
- Install them manually.

Each of these servers must have the MobileFirst Administration Services and one or more MobileFirst runtime environments deployed on it.

For more information about setting up a server, see “Planning the installation of MobileFirst Server” on page 6-3.

When each of these servers is working properly in a stand-alone topology, you can transform them into nodes of a server farm.

4. Stop all the servers intended to become members of the farm.

5. Configure each server appropriately for the type of application server. You must set some JNDI properties correctly. For Apache Tomcat, you must also check that the JVM arguments are properly defined.

- **WebSphere Application Server Liberty profile**

In the `server.xml` file, set the JNDI properties shown in the following sample code.

```

<jndiEntry jndiName="ibm.worklight.topology.clustermode" value="Farm"/>
<jndiEntry jndiName="ibm.worklight.admin.serverid" value="farm_member_1"/>
<jndiEntry jndiName="ibm.worklight.admin.jmx.user" value="myRESTConnectorUser"/>
<jndiEntry jndiName="ibm.worklight.admin.jmx.pwd" value="password-of-rest-connector-user"/>
<jndiEntry jndiName="ibm.worklight.admin.jmx.host" value="93.12.0.12"/>

```

These properties must be set with appropriate values:

- **ibm.worklight.admin.serverid**: The identifier that you defined for this farm member. This identifier must be unique across all farm members.
- **ibm.worklight.admin.jmx.user** and **ibm.worklight.admin.jmx.pwd**: These values must match the credentials of a user as declared in the `<administrator-role/>` element.
- **ibm.worklight.admin.jmx.host**: Set this parameter to the IP or the host name that is used by remote members to access this server. Therefore, do not set it to `localhost`. This host name is used by the other members of the farm and must be accessible to all farm members.
- **ibm.worklight.admin.jmx.port**: Set this parameter to the server HTTPS port that is used for the JMX REST connection. You can find the value in the `<httpEndpoint>` element of the `server.xml` file.

• Apache Tomcat

Modify the `conf/server.xml` file to set the following JNDI properties in the MobileFirst administration context and in every MobileFirst runtime context.

```

<Environment name="ibm.worklight.topology.clustermode" value="Farm" type="java.lang.String" overr
<Environment name="ibm.worklight.admin.serverid" value="farm_member_1" type="java.lang.String"

```

The **ibm.worklight.admin.serverid** property must be set to the identifier that you have chosen for this farm member. This identifier must be unique across all farm members.

You must make sure that the `-Djava.rmi.server.hostname` JVM argument is set to the IP or the host name used by remote members to access this server. Therefore, it must not be set to `localhost`. This argument is set in the `CATALINA_OPTS` environment variable.

• WebSphere Application Server full profile

You must declare the following environment variables in the MobileFirst Administration Services and in every MobileFirst runtime application deployed on the server.

- `"ibm.worklight.topology.clustermode"`
- `"ibm.worklight.admin.serverid"`

- a. In the WebSphere Application Server console, select **Applications > Application Types > WebSphere Enterprise applications**.
- b. Select the MobileFirst Administration Service application.
- c. In “Web Module Properties”, click **Environment entries for Web Modules** to display the JNDI properties.
- d. Set the values of the following properties.
 - Set `"ibm.worklight.topology.clustermode"` to `Farm`.
 - Set `"ibm.worklight.admin.serverid"` to the identifier that you chose for this farm member.
 - Set `"ibm.worklight.admin.jmx.user"` to a user name that has access to the SOAP connector.
 - Set `"ibm.worklight.admin.jmx.pwd"` to the password of the user declared in `"ibm.worklight.admin.jmx.user"`.
- e. Verify that `"ibm.worklight.admin.jmx.connector"` is set to `SOAP`.
- f. Click **OK** and save the configuration.

- g. Make similar changes for every MobileFirst runtime application deployed on the server.
6. Exchange the server certificates in their truststores. Exchanging the server certificates in their truststores is mandatory for farms that use WebSphere Application Server full profile and WebSphere Application Server Liberty profile, because in these farms communication between the servers is secured by SSL.

- **WebSphere Application Server Liberty profile**

You can configure the truststore by using IBM utilities such as Keytool or iKeyman.

- For more information about Keytool, see Keytool in the IBM SDK, Java Technology Edition.
 - For more information about iKeyman, see iKeyman in the IBM SDK, Java Technology Edition.
- a. Import the public certificates of the other servers in the farm into the truststore referenced by the `server.xml` configuration file of the server. If the `server.xml` file does not specify the location of a truststore, it is usually the `Liberty_install_dir/usr/servers/servername/resources/security/key.jks` file. If you are unsure and want to find the location of the truststore, you can do so by adding the following declaration to the `server.xml` file:

```
<logging traceSpecification="SSL=all:SSLChannel=all"/>
```

Then, start the server and look for lines containing `com.ibm.ssl.trustStore` in the `Liberty_install_dir/usr/servers/servername/logs/trace.log` file.

- b. Restart each instance of WebSphere Application Server Liberty profile to make the security configuration take effect.
- The following steps are required for single sign on (SSO) to work.
- c. Start one member of the farm. In the default LTPA configuration, after the Liberty server has started successfully, it generates an LTPA keystore as `Liberty_install_dir/servers/server_name/resources/security/ltpa.keys`.
 - d. Copy the `ltpa.keys` file to the `Liberty_install_dir/servers/server_name/resources/security` directory of each farm member to replicate the LTPA keystores across the farm members.

For more information about LTPA configuration, see *Configuring LTPA on the Liberty profile*.

- **WebSphere Application Server full profile**

Configure the truststore in the WebSphere Application Server administration console.

- a. Log in to the WebSphere Application Server administration console.
- b. Select **Security > SSL certificate and key management**.
- c. In “Related Items”, select **Keystores and certificates**.
- d. In the “Keystore usages” field, make sure that **SSL keystores** is selected. You can now import the certificates from all the other servers in the farm.
- e. Click **NodeDefaultTrustStore**.
- f. In “Additional Properties”, select **Signer certificates**.
- g. Click **Retrieve from port**. You can now enter communication and security details of each of the other servers in the farm. Follow the next steps for each of the other farm members.
- h. In the “Host” field, enter the server host name or IP address.

- i. In the “Port” field, enter the HTTPS transport (SSL) port.
- j. In “SSL configuration for outbound connection”, select **NodeDefaultSSLSettings**.
- k. In the “Alias” field, enter an alias for this signer certificate,
- l. Click **Retrieve signer information**.
- m. Review the information that is retrieved from the remote server and then click **OK**.
- n. Click **Save**.
- o. Restart the server.

What to do next

If you have created a farm whose members use WebSphere Application Server Liberty profile, you can now set up an IBM HTTP Server for Liberty. For more information, see “Setting up an IBM HTTP Server in an IBM WebSphere Application Server Liberty profile farm” on page 6-252.

Verifying a farm configuration

To verify a server farm configuration, start all the servers, deploy an application to one of the servers of the farm, and then check the log files of each server to confirm that all servers have been updated.

About this task

The purpose of this task is to verify that a farm is configured properly and that administration operations are propagated on all servers of a farm.

Procedure

1. Start all the servers of the farm.
2. Deploy a MobileFirst application to one of the servers of the farm. You can use the MobileFirst Operations Console or the wladm program with the deploy app command. For more information about the deploy app command, see “Commands for apps” on page 11-44.
3. Once the operation is completed, review the log file of the application server and search for the entries of class BaseTransaction. Verify that all servers have been updated.

This is the example of a Liberty log file:

```
$ grep BaseTransaction messages.log
```

```
[9/22/14 1:03:17:032 CEST] 0000006d com.ibm.worklight.admin.actions.BaseTransaction
[9/22/14 1:03:17:251 CEST] 0000006e com.ibm.worklight.admin.actions.BaseTransaction
[9/22/14 1:03:19:123 CEST] 00000072 com.ibm.worklight.admin.actions.BaseTransaction
[9/22/14 1:03:19:123 CEST] 00000072 com.ibm.worklight.admin.actions.BaseTransaction
[9/22/14 1:03:19:138 CEST] 00000071 com.ibm.worklight.admin.actions.BaseTransaction
[9/22/14 1:03:19:138 CEST] 00000071 com.ibm.worklight.admin.actions.BaseTransaction
```

Troubleshooting

- If you use an environment ID (see “List of JNDI properties for MobileFirst Server administration” on page 6-86 and “Configuring a MobileFirst project in production by using JNDI environment entries” on page 10-60), for each server, verify that the **environmentId** value for the MobileFirst Administration Service is the same as the **environmentId** value for the runtime.
- If you have several servers on the same computer, you must verify that all servers are using a different JMX port:

- For WebSphere Application Server, the port that is used for JMX is the SOAP port.
- For WebSphere Application Server Liberty, the port that is used for JMX is the HTTPS port.
- For Apache Tomcat, the port that is used for JMX is the RMI port, which is specified in the Ant tasks or in the setenv file for a manual installation.

If the JMX port is not available for a server, the MobileFirst runtime environment cannot start.

Lifecycle of a server farm node

You can configure heartbeat rate and timeout values to indicate possible server problems among farm members by triggering a change in status of an affected node.

When a server configured as a farm node is started, the Administration Service on that server automatically registers it as a new farm member.

When a farm member is shut down, it automatically unregisters from the farm.

A heartbeat mechanism exists to keep track of farm members that might become unresponsive, for example, because of a power outage or a server failure. In this heartbeat mechanism, MobileFirst runtimes send periodically at a given rate a heartbeat to MobileFirst administration services. If the MobileFirst administration services register that too long a time has elapsed since a farm member sent a heartbeat, then the farm member is considered to be down.

Farm members considered to be down do not serve any more requests to mobile applications.

Having one or more nodes down does not prevent the other members of the farm from:

- Serving requests correctly to mobile applications
- Accepting new management operations triggered through MobileFirst Operations Console

Configuring the heartbeat rate and timeout values

You can configure the heartbeat rate and timeout values by defining the following JNDI properties:

- **ibm.worklight.admin.farm.heartbeat**
- **ibm.worklight.admin.farm.missed.heartbeats.timeout**

For more information, see “List of JNDI properties for MobileFirst Server administration” on page 6-86

You can check the status of farm members from MobileFirst Operations Console by clicking **Server Farm Nodes**.

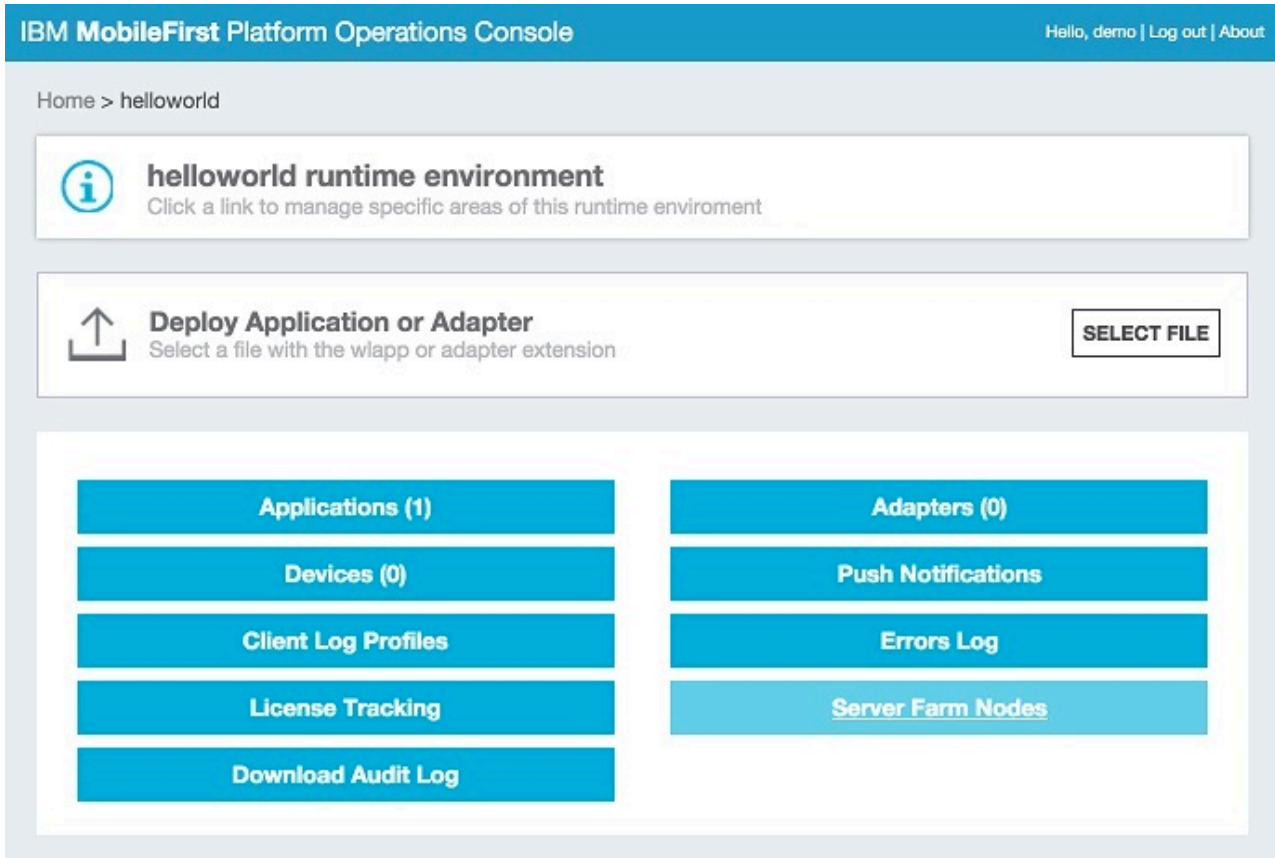

Figure 6-8. Checking the status of farm nodes

Clicking **Server Farm Nodes** enables you to access the list of registered farm members and their status.

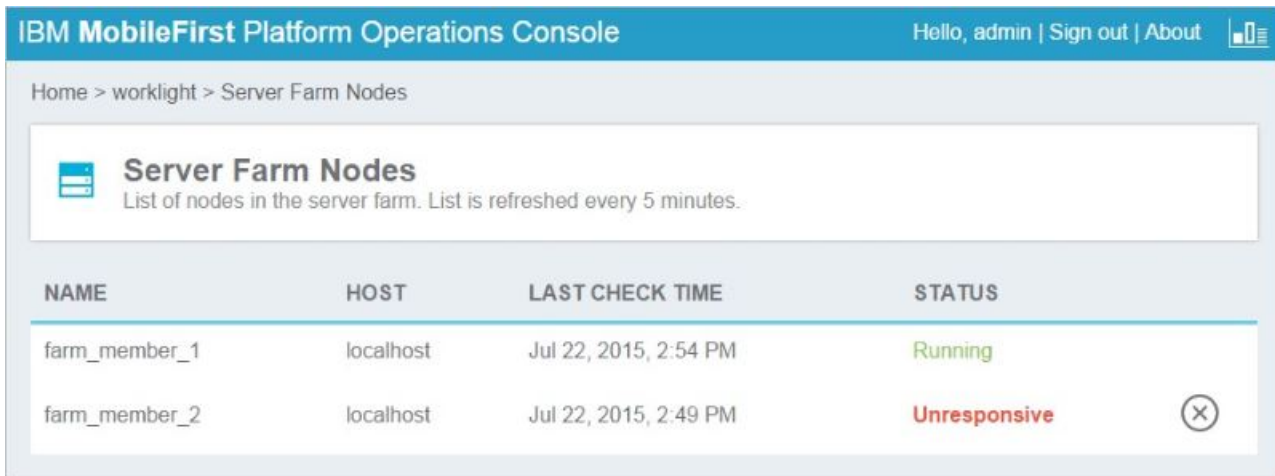

Figure 6-9. List of server farm nodes

The node identified as “farm_member_2” is considered to be down, which indicates that this server has probably failed and requires some maintenance.

Configuring MobileFirst Server

Consider your backup and recovery policy, optimize your MobileFirst Server configuration, and apply access restrictions and security options.

Backup and recovery

You can back up the customization and the content (adapters and applications) outside the MobileFirst instance, for example in a source control system.

It is advisable to back up the runtime database as-is. When reports are enabled, the database can become quite large. Consider the benefits of backing them up separately. Report tables can be configured to be stored on a different database instance.

Optimization and tuning of MobileFirst Server

Optimize the MobileFirst Server configuration by tuning the allocation of Java virtual machine (JVM) memory, HTTP connections, back-end connections, and internal settings.

The MobileFirst Server works with three application servers: Apache Tomcat, WebSphere Application Server and Liberty profile. For best results, install MobileFirst Server on a 64-bit operating system, and use only 64-bit software.

JDK

The MobileFirst Server can run on IBM JDK or Oracle JDK.

JVM memory allocation

The Java instance of the application server allocates memory. Consider the following general guidelines for JVM memory allocations:

- Set the JVM memory to at least 2 GB. This means you can not use less than 2GB, but that might not be enough and you will have to specify more, based on the requirements.
- For a production environment, setting the minimum heap size and maximum heap size to the same value can provide the best performance, as it avoids heap expansion and contraction.
- Set the required memory size of the application server:
 - Liberty: See the `jvm.options` section in Customizing the Liberty profile environment. You must create this file if it does not exist.
 - WebSphere Application Server: proceed as follows.
 1. Log in to the administration console.
 2. Go to **Servers > Server types > WebSphere application servers**.
 3. Select each server and set Java memory settings under **Java Process definition > JVM arguments**.
 - Apache Tomcat: find the `catalina` script and set **JAVA_OPTS** to inject memory.

For information about how to calculate memory size, see the Scalability and Hardware Sizing document and the hardware calculator spreadsheet at the Developer Center website for IBM MobileFirst Platform Foundation.

Tuning HTTP connections

This configuration defines threading and execution settings for the application server.

Each incoming request requires a thread for the duration of that request. If more simultaneous requests are received than can be handled by the currently available request processing threads, then additional threads will be created up to the configured maximum.

Specific application server configuration:

- Liberty: See the executor section in Liberty profile: Configuration elements in the `server.xml` file.

By default, the maximum number of threads is unlimited.

- WebSphere Application Server: Proceed as follows:

1. Log in to the administration console.
2. Go to **Servers > Server types > WebSphere application servers > `server_name` > Web container.**

By default, the maximum number of threads is 50.

- Apache Tomcat: See The HTTP Connector page in the Apache Tomcat website.

By default, the maximum number of threads is 200.

Bear in mind the following points when you configure HTTP threads:

- If, for example, the longest call takes 500 milliseconds and you configure a maximum of 50 threads, you can handle approximately 100 requests per second.
- If your environment includes a back-end system that runs slowly, increase the number of default threads. In addition, increase the number of back-end connection threads. For more information, see “Tuning database connections.”
- If you expect a high number of concurrent users, increase the number of default threads.
- Liberty specific: Even though the maximum number of threads is unlimited, the executor service makes informed choices whether adding another thread will actually be useful.

Tuning database connections

In tuning database connections, the most important parameter is the number of connection threads from the server to the database. This configuration is made in the data source. There are two IBM MobileFirst Platform Foundation for iOS features that rely heavily on the database: SSO (single sign-on) and reports. When using these features, you must ensure that you have enough database connection threads. The only limitation is that each node in the MobileFirst Server cluster can have no more than **MAX_DB_INCOMING_CONNECTIONS/NUM_OF_CLUSTER_NODES** connection threads, where **MAX_DB_INCOMING_CONNECTIONS** is the maximum incoming connections defined in the database server and **NUM_OF_CLUSTER_NODES** is the number of MobileFirst Server nodes in the cluster. A rough rule of thumb is to set the number of database connections to be the number of HTTP threads in the application server, as long as you maintain the limitation above.

Each incoming request uses a thread. If more simultaneous requests are received than can be handled by the currently available request-processing threads, more threads are created up to the configured maximum.

For data source configuration, check the following topics:

- WebSphere Application Server: See Connection pool settings.
- Apache Tomcat: See JNDI Datasource HOW-TO.
- Liberty Server: See the Datasource section in Liberty profile: Configuration elements in the server.xml file.

Tuning back-end connections

maxConcurrentConnectionsPerNode

The **maxConcurrentConnectionsPerNode** parameter defines the maximum number of concurrent calls to the back-end service from the MobileFirst Server node. This **maxConcurrentConnectionsPerNode** parameter is set in the **<connectionPolicy>** element of the adapter XML file.

Starting from IBM MobileFirst Platform Foundation for iOS V6.3, all requests to the back-end remain on the HTTP thread. The MobileFirst Server does NOT allocate a new thread for the backend request. The only use of **maxConcurrentConnectionsPerNode** is for blocking the number of connections to the HTTP back-end. The implication is that you can specify a large value for **maxConcurrentConnectionsPerNode** (for example, 5000), so as not to limit the back-end calls.

Handling slow backend servers

If your backend server is slow, increase the values for your server settings, in particular the following values:

- Number of HTTP threads in the application server: For a backend that responds in 750 ms, for example, 3000 HTTP threads is recommended.
- **maxConcurrentConnectionsPerNode** in the adapter XML file: For a backend that responds in 750 ms, for example, 3000 is recommended.
- OS settings: Increase the number of open files. 4096 is the recommended number.
- Clients threads: A good rule of thumb is 2900 JMETER clients threads.
- Backend server: 3000 threads is recommended.

Push Notifications

For push notification information see the Push Notification section in the Scalability and Hardware Sizing document and the hardware calculator spreadsheet at the Developer Center website for IBM MobileFirst Platform Foundation.

Analytics

For Analytics Server configuration see the Analytics section in the Scalability and Hardware Sizing document and the hardware calculator spreadsheet at the Developer Center website for IBM MobileFirst Platform Foundation.

MobileFirst Server internal configuration

Consider the following factors:

- The **serverSessionTimeout** property defines client inactivity timeout, after which the session is invalidated. A session is an object stored in the server memory for each connecting device. Among other data, it stores authentication information. Active sessions are determined by the number of sessions opened versus the

sessions timing out due to lack of activity. The default session timeout is 10 minutes, but it can and should be configured. Users typically set the timeout to anywhere from 5 to 10 minutes. This parameter affects the server memory consumption.

- In addition, the mobile client has a “heartbeat” property that allows the mobile client to ping the server while the app is in the foreground, so that the server session will not time out.

Note:

When a mobile app has moved into the background, it no longer interacts with the server, nor sends a “heartbeat”. The result is that the server session drops after the specified server session timeout.

- For example, suppose every minute 1,000 users start a session against the server. Even if they exit the application after 3 minutes, their sessions will remain active on the server for 10 minutes, leaving $10 \times 1,000 = 10,000$ sessions.

Intervals for background tasks

The following **worklight.properties** parameters control the intervals at which background tasks. Background tasks perform several actions on the database and/or file system:

sso.cleanup.taskFrequencyInSeconds

The SSO (single sign-on) mechanism stores session data in a database table. This parameter is the interval for the SSO cleanup task to check if there are inactive accounts in the SSO table. If any are found, it deletes them. The default value is 5 seconds, meaning that every 5 seconds, the database is checked for inactive accounts. An inactive account is one that has remained idle for longer than the value of the **serverSessionTimeout** property.

push.cleanup.taskFrequencyInSeconds

Deletes inactive push notification subscriptions. The default is 60 minutes. This parameter is currently implemented only for Apple APNS.

Optimization of MobileFirst Server project databases

You can improve the performance of the project databases or schemas that support MobileFirst Server.

Note: The Reports database and the associated APP_ACTIVITY_REPORT table described below are deprecated in IBM MobileFirst Platform Foundation for iOS V7.0.0. Use “Operational analytics” on page 12-8 instead. Note that setting up the Reports database is optional in this release and prior releases.

The following sections provide general information about database tuning, and techniques you can use to optimize your database performance for IBM MobileFirst Platform Foundation for iOS. In the following sections, the examples that are provided are for the IBM DB2 database. If you use MySQL or Oracle, consult that vendor's documentation for the corresponding procedures.

Database disks

You can find some overview information about the MobileFirst Server project databases in the **Database usage and size** section of the Scalability and Hardware Sizing document and its accompanying hardware calculator spreadsheet at the Developer Center website for IBM MobileFirst Platform Foundation. The

spreadsheet can aid you in computing the hardware configuration that is best suited to your planned server environment.

When you compute your hardware needs, consider servers that offer multiple disks because performance increases significantly if you use disks correctly when you set up your MobileFirst Server project databases. For example, whether you use DB2, MySQL, or Oracle, you can almost always speed up database performance by configuring the database to use separate disks to store database logs, index, and data. Multidisk configuration results in faster access to your data with every transaction because there is no contention resulting from the same disk attempting to write to its log files or access its index at the same time it processes the data transaction.

Database compression

By using the compression feature set by your database vendor, you can decrease database size and input/output (I/O) time.

For example, in tests that were performed on IBM DB2, adding `COMPRESS YES` to the SQL that creates the `APP_ACTIVITY_REPORT` table decreased the size of that table on the disk by a factor of 3 and decreased its I/O time by a factor of 2.

CPU time might increase as a result of this compression, but it was not observed in the tests on the `APP_ACTIVITY_REPORT` table, possibly because most of the activity was INSERTs and the aggregation task was not monitored deeply.

On DB2, LOB data size

If your database is DB2, consider using the `INLINE_LENGTH` option when you create tables for SSO information. This option is also appropriate for tables that contain data that is stored as large objects (LOBs), but that are only a few kilobytes in size. To improve performance of LOB data access, you can constrain the LOB size by placing the LOB data within the formatted rows on data pages rather than in the LOB storage object. For more information about this technique, see [Inline LOBs improve performance](#).

Database table partitions

A partition is a division of a logical database table into distinct independent parts. You can improve performance and the purging accumulated data by mapping each table partition to a different table space. This suggestion applies only to the `APP_ACTIVITY_REPORT` table, which holds most of the row data.

Note: Partitioned tables are different from a partitioned database (DPF) environment, which is not suggested for use with IBM MobileFirst Platform Foundation for iOS.

To show how to use database partitions can be used, here is an example from DB2:

- A partition is defined on the `ACTIVITY_TIMESTAMP` column in the `APP_ACTIVITY_REPORT` table.
- Each partition contains the data for one day.
- The number of partitions is the number of days of data that you want to save.
- Each partition is created in a different table space.
- Thus in the SQL example that follows, you create seven partitions in DB2:

```

CREATE TABLESPACE app_act_rep_1;
CREATE TABLESPACE app_act_rep_2;
CREATE TABLESPACE app_act_rep_3;
CREATE TABLESPACE app_act_rep_4;
CREATE TABLESPACE app_act_rep_5;
CREATE TABLESPACE app_act_rep_6;
CREATE TABLESPACE app_act_rep_7;

CREATE TABLE "APP_ACTIVITY_REPORT" (
    "ID" BIGINT NOT NULL ,
    "ACTIVITY" CLOB(1048576) LOGGED NOT COMPACT ,
    "ACTIVITY_TIMESTAMP" TIMESTAMP ,
    "ADAPTER" VARCHAR(254) ,
    "DEVICE_ID" VARCHAR(254) ,
    "DEVICE_MODEL" VARCHAR(254) ,
    "DEVICE_OS" VARCHAR(254) ,
    "ENVIRONMENT" VARCHAR(254) ,
    "GADGET_NAME" VARCHAR(254) ,
    "GADGET_VERSION" VARCHAR(254) ,
    "IP_ADDRESS" VARCHAR(254) ,
    "PROC" VARCHAR(254) ,
    "SESSION_ID" VARCHAR(254) ,
    "SOURCE" VARCHAR(254) ,
    "USER_AGENT" VARCHAR(254) )
    IN app_act_rep_1, app_act_rep_2, app_act_rep_3, app_act_rep_4,
    app_act_rep_5, app_act_rep_6, app_act_rep_7
    PARTITION BY RANGE (ACTIVITY_TIMESTAMP)
    (STARTING FROM ('2013-02-25-00.00.00.000000')
    ENDING AT ('2013-03-04-00.00.00.000000') EXCLUSIVE
    EVERY (1 DAY)
);

```

Database purge

After high-volume data is allocated to separate table spaces, the task of periodically purging the data is simplified. This suggestion is also primarily relevant only to the APP_ACTIVITY_REPORT table that holds most of the row data. The process in this DB2 example is as follows:

- Aggregate data either with a MobileFirst process or with a client external process.
- When the data is no longer needed (the aggregation task should successfully process the data), it can be deleted.
- The most effective way to delete the data is to delete the partition. In DB2, you purge the data by detaching the partition to a temp table, then truncating that temp table and attaching a new day to the partition. You can implement the process as a scheduled stored procedure in the database, as in the following example:

```

ALTER TABLE "APP_ACTIVITY_REPORT"
    DETACH PARTITION part0
    INTO temptable;

TRUNCATE TABLE temptable;

ALTER TABLE "APP_ACTIVITY_REPORT"
    ATTACH PARTITION part0
    STARTING FROM ('2013-02-25-00.00.00.000000')
    ENDING AT ('2013-03-26-00.00.00.000000') EXCLUSIVE
    FROM temptable;

```

Testing MobileFirst Server performance

You can run performance tests on the different features of the MobileFirst Server. This section describes how to run the Apache jMeter performance test tool, but the procedure is similar for other tools.

Note: The procedures described in this page apply only to a scenario that involves a propriety JavaScript adapter that is running in session-dependent mode. It is not applicable in a scenario that involves the OAuth security framework.

The following features can have an impact on MobileFirst Server performance:

- Authentication flow
- Back-end invocation
- Database reporting
- Single sign-on (SSO)
- Direct update
- Push notification
- Geolocation

This section focuses on testing the impact of authentication flow and back-end invocation on MobileFirst Server performance.

Testing authentication flow performance

The following realm, which is part of the default security test for iOS, is tested:

Remote disable realm

Check on every request that the application is not blocked.

AntiXSRF realm

Check on every request that WL-Instance-Id is equal to the one sent in the init response.

Anonymous User realm

Generate a random user ID that is used for such things as reports and identifying the user.

Device no provisioning

Check that the token value inside the authorization header is equal to the one sent in the initialization response.

For more information about the realms, see “The authentication configuration file” on page 8-260.

When you run a performance test, your first step is to complete the authentication flow. If you do not do so, security challenges are raised and your requests are rejected with “401” errors. This step involves sending an init request to the MobileFirst Server and extracting the relevant data from the response. The init request has the following structure: `http://{Host}:{Port}/{Context}/apps/services/api/{AppName}/{environment}/init`

Table 6-32. Initialization parameters

Parameter	Description
x-wl-app-version	Application version.
x-wl-platform-version	Version of the product that built the application.

This is an example of a jMeter test:

```
Request URL: http://192.168.1.104:10080/worklight/apps/services/api/DummyApp/common/init
Request Method: POST
Status Code: 401 Unauthorized
Request Headers
Accept: text/javascript, text/html, application/xml, text/xml, */*
Accept-Encoding: gzip, deflate, sdch
Accept-Language: en-US
Cache-Control: max-age=0
Connection: keep-alive
Content-Length: 65
Content-type: application/x-www-form-urlencoded; charset=UTF-8
Cookie: WL_PERSISTENT_COOKIE=9b52c92f-20ee-4c39-b346-f7d2d3f5e135; JSESSIONID=0000sGn4zIi5S7LbsL5Mh5uAyTH:0c75f839-48c4-4f6b-87b2-d36dc2b52d60; testcookie=oreo
Host: 192.168.1.104:10080
Origin: http://192.168.1.104:10080
Referer: http://192.168.1.104:10080/worklight/apps/services/preview/DummyApp/common/0/default/DummyApp.html
User-Agent: Mozilla/5.0 (Windows NT 6.1; WOW64) AppleWebKit/537.36 (KHTML, like Gecko) Chrome/32.0.1700.107 Safari/537.36
X-Requested-With: XMLHttpRequest
x-wl-app-version: 1.0
x-wl-platform-version: 6.0.0
Form Data
skinLoaderChecksum:
isAjaxRequest: true
x: 0_9003859923991412
```

The dynamic parameters in the Form Data (skinLoaderChecksum, isAjaxRequest, and x) are appended to the URL. During performance testing, the skin and skinLoaderChecksum parameters are not needed because jMeter does not really run the app: jMeter only simulates the client app. The parameter x aims to prevent response data from being returned from cache. As a result, you do not need to append the parameters during performance testing or you can generate a random value for the dynamic parameter x. A better option is always to clean cookies in your performance testing tool before you start loading test threads.

Response data from MobileFirst initialization service

The response data from the MobileFirst init request differs depending on the security test you apply on your MobileFirst application environment. By default, if you have no additional security test, the response data structure for the common and iPhone environment are shown in the following figures.

```
Request
URL: http://192.168.1.104:10080/worklight/apps/services/api/DummyApp/common/init
POST
Content to Send
Headers
Parameters
Name: Value
Add/Change
Name Value
x-wl-platform-version 6.0.0
x-wl-app-version 1.0
Response
POST on http://192.168.1.104:10080/worklight/apps/services/api/DummyApp/common/init
Status: 401 Unauthorized
View raw transaction
/*-secure-
{"challenges":{"wl_antiXSRFRealm":{"WL-Instance-Id":"1uoa8e671cafab942s414q9pfq"}}}*/
```

Figure 6-10. Response data from common environment

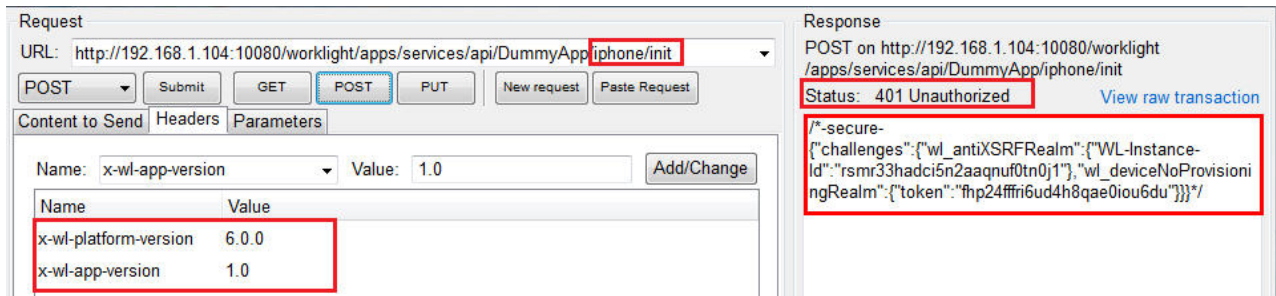

Figure 6-11. Response data from iPhone environment

The difference between the common and iPhone environment data structures is that the common environment has no `wl_deviceNoProvisioningRealm` challenge by default.

Extracting the init response data

You need to extract the `WL-Instance-Id` and the `token` from the `init` response and send them as headers in all requests to the MobileFirst Server. If you do not do so, the authentication check fails and the request is rejected. Challenge data is different for each session, so you need to extract and store the challenge data for each thread. For more information, see “Testing back-end invocation” later in this section.

Changing the response status to HTTP 200

When the performance testing thread runs the initialization for the first time, MobileFirst Server responds to challenge data with an HTTP 401 status. This is to be expected, so the performance tool should treat this HTTP status as a success. The HTTP status can be changed to HTTP 200 by using the performance testing tool's script. In this way, the performance testing tool will record the request as a success, otherwise the performance testing report might mark this request as having failed and might record it as an error. This would greatly impact the performance testing report.

Testing back-end invocation

You should start testing back-end invocation only after you have finished testing authentication flow. You can choose any type of back end that you want. The request for the back-end invocation has the following structure:

```
http://{Host}:{Port}/{Context}/apps/services/api/{AppName}/{environment}/query.
```

Table 6-33. Backend invocation parameters

Parameter	Description
adapter	MobileFirst Adapter name.
procedure	MobileFirst procedure name
parameters	Procedure parameters should be an array.

The following figure shows an example array of parameters:

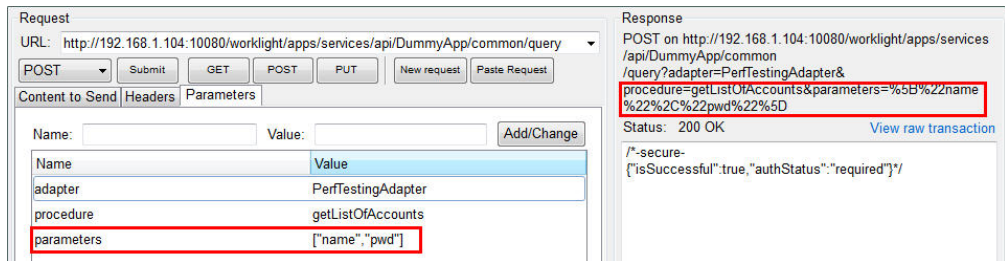

The following figure shows an example of request headers:

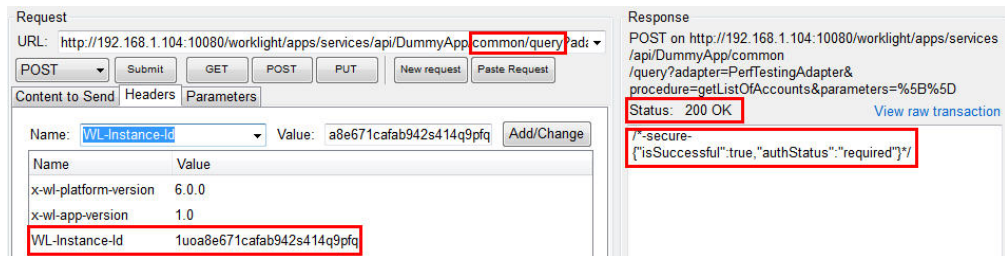

By default, the jMeter tool encodes the URL. If your performance testing tool does not support URL encoding, you must use encoded parameter values.

For the iPhone environment, since it contains `wl_deviceNoProvisioningRealm` by default, you need to send the Authorization header. The format for HTTP Authorization header is shown as follows. You need to replace `/${device-token}` with the token you extracted in the initialization phase.

```
{\"wl_deviceNoProvisioningRealm\":{\"device\":{\"id\":\"1234567890\",\"os\":\"5.0\",
\"model\":\"testModel\",\"environment\":\"iphone\"},\"app\":{\"id\":\"testId\",\"version\":\"1.0\"},
\"token\":\"${device-token}\",\"custom\":{}}}
```

When the response data `isSuccessful` is true, this indicates that the response data from the MobileFirst Adapter procedure was successfully received and now you can continue with your back-end testing.

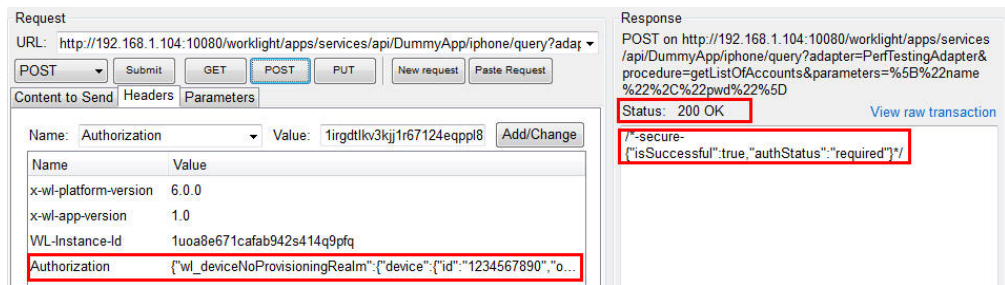

Logging in

When the MobileFirst adapter procedure is protected by a security test or the `connectAs` property is set to `endUser`, you need to log in to the MobileFirst Server before calling this procedure. To check if the MobileFirst adapter procedure needs a login, you can call the procedure followed by the steps described earlier, and check the response data from the MobileFirst Server. If the response data includes `isSuccessful:true` and `authStatus:required`, you should log in to the MobileFirst Server first, otherwise the requests to this procedure are rejected by MobileFirst

Server. The way you log in to the MobileFirst Server depends on the authentication type. If the app is protected by form-based authentication or adapter-based authentication, you can call the login procedure after successfully completing initialization. In general, the login procedure should not be protected by a security test; it can be directly called after initialization is completed. For other authentication types, you can capture the network traffic on MobileFirst Server by using network traffic capture tools (for example, Fiddler or Wireshark). The network traffic data shows the detailed URL and parameters that you can use to log in to the MobileFirst Server. The following screen image shows an example of a login function that calls the `setActiveUser` API with the supplied user ID and password:

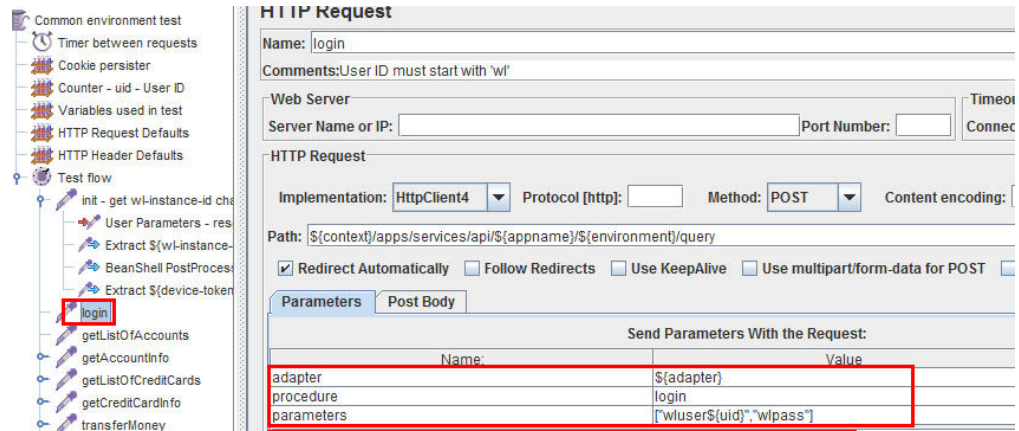

Logging out

The following options are available for logging out of the MobileFirst Server:

Not logging out for each iteration

MobileFirst Server automatically logs the user out when the session times out. This option consumes more memory than logging out, but is useful if you want to maximize memory usage during performance testing. To adopt this option, you need to clean cookies for each iteration in the performance testing tool.

Logging out after each iteration by using the MobileFirst logout service

It is recommended to clean cookies for each iteration to avoid sharing data between iterations. The logout request has the following structure:
`http://{Host}:{Port}/{Context}/apps/services/api/{AppName}/
 {environment}/logout`

For more information about the parameters, see “HTTP Interface of the production server” on page 6-275.

Database reporting

To activate database reporting, you need to specify `reports.exportRowData=true` in your `worklight.properties` file. You also need to set up the reports database. For more information, see “Reports database” on page 12-74. After you enable database reporting, you can use the back-end invocation step described earlier. See the database reporting section in the Scalability and Hardware Sizing document at the Developer Center website for IBM MobileFirst Platform Foundation.

Single sign-on (SSO), direct update, push notification, and geolocation

See the relevant section in the Scalability and Hardware Sizing document at the Developer Center website for IBM MobileFirst Platform Foundation.

General example: Using jMeter as a performance testing tool

HTTP cookie management

Cleaning the cookies on every thread iteration ensures that no data and user information is being cached during this iteration. If you want to keep cookie information, you need to clean the user information at the end of the iteration to avoid unexpected errors during load testing. For example, if the user does not log out during the previous iteration, the next iteration might be affected by that user.

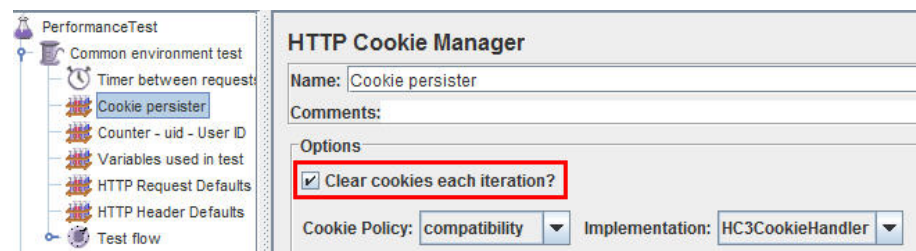

HTTP Header Management

The necessary x-wl-platform-version and x-wl-app-version that were described earlier can be defined here; you can also define the WL-Instance-Id and WL_deviceNoProvisioningRealm token placeholders. You can use a jMeter script to extract the real challenge data and replace the placeholders for each thread iteration as shown in the following image:



Initialization phase

1. Extract and replace the WL-Instance-Id placeholder:

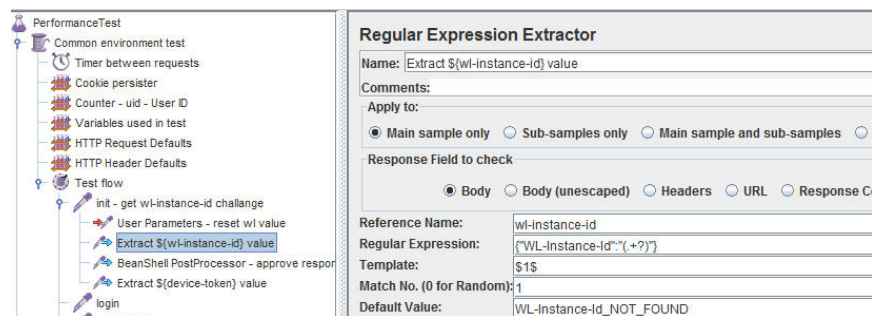

2. Extract and replace the WL_deviceNoProvisioningRealm token placeholder:

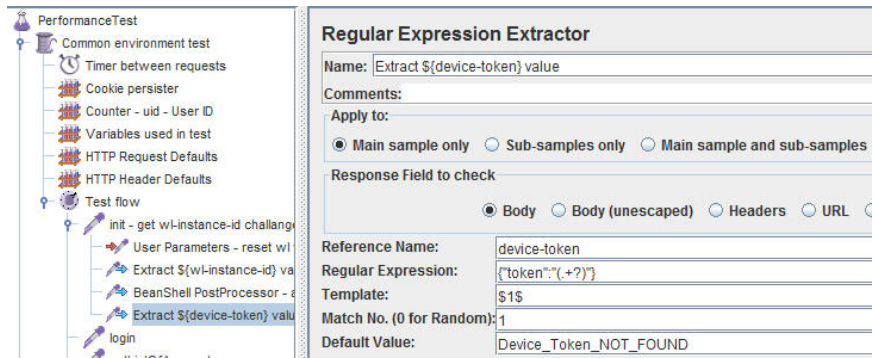

3. Change initialization HTTP status 401 and 403 to HTTP status 200:

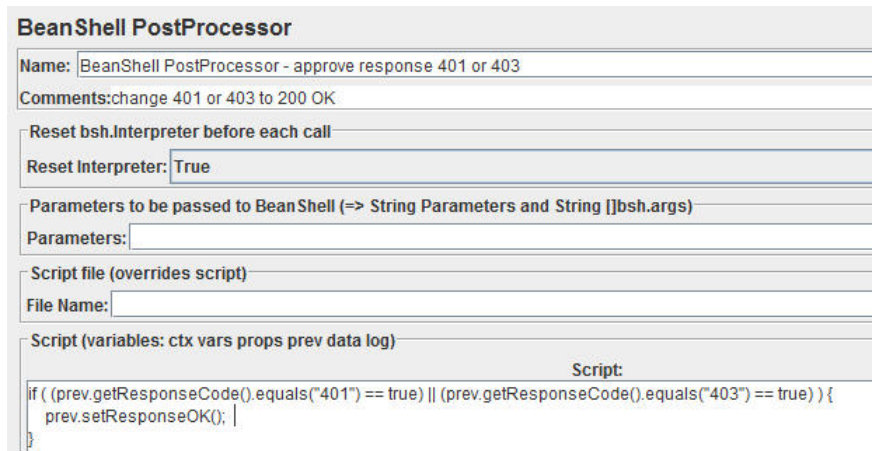

Security configuration

Configure the security of the MobileFirst Server as detailed here.

Securing the MobileFirst Server administration

This section helps ensure that no unauthorized person can perform MobileFirst Server administration operations. This is particularly important in a production environment.

The security threat is that any person who can install mobile applications in a production environment is able to modify the behavior of these apps on the mobile devices. The apps are served to the clients through the MobileFirst runtime environments, which get these apps from the Administration Services through JMX. The Administration Services fetch these apps from the administration database. The Administration Services and the IBM MobileFirst Platform Operations Console allow any user in the roles of `worklightadmin` or `worklightdeployer` to deploy applications. A similar threat exists for adapters.

Enabling https in the application server

The ability to use https with the application server is a prerequisite.

For WebSphere Application Server Liberty profile:

- Verify that the `server.xml` file contains either `<feature>ssl-1.0</feature>` or `<feature>restConnector-1.0</feature>`, or both features. The `restConnector-1.0` feature implies that the `ssl-1.0` feature is enabled.

- Verify that the HTTPS port is enabled, by ensuring that the `server.xml` file does not have an `<httpEndpoint>` element with a `httpsPort` attribute that is negative. If the HTTPS port is disabled, SSL is also disabled, and the JMX connections that the MobileFirst Server requires do not work.
- Verify that the `server.xml` file contains `<keyStore id="defaultKeyStore" .../>`, or an equivalent declaration, otherwise the JMX connections that the MobileFirst Server requires do not work. For more information, see Liberty profile: SSL configuration attributes.

For Apache Tomcat:

- Enable an https port as documented in SSL support and SSL Configuration HOW-TO.

Enabling application security in the application server

Without this step, anyone can connect to the web applications without credentials.

For WebSphere Application Server full profile:

- Verify that Administrative Security is enabled.
- Verify that Application Security is enabled.

For WebSphere Application Server Liberty profile:

- Verify that the `server.xml` file contains `<feature>appSecurity-1.0</feature>`.

Protecting the passwords of users in the roles `worklightadmin` and `worklightdeployer`

If the password of any user who is mapped to the roles `worklightadmin` or `worklightdeployer` is compromised, that is, becomes potentially known to an unauthorized person, unauthorized MobileFirst administration operations are possible. Here are steps to mitigate this risk.

- Minimize the number of users that you map to the roles `worklightadmin` and `worklightdeployer`.
- Map different users to the roles `worklightadmin` or `worklightdeployer` in development and test environments than you do in the production environment. If the password of the administrator of the development or test environment is compromised (for example, by use of `secure="false"`), this helps secure the password of the administrator of the production environment.
- If these users are authenticated through LDAP, secure the connection to the LDAP server.
- Never use the MobileFirst Operations Console or the MobileFirst Administration REST services over http. Always use https. There are two ways to guarantee this:
 - Configure the application server to respond only to an https port, not to an http port.
 - Modify the `worklightconsole.war` and `worklightadmin.war` files to activate the Java EE 6 transport security of type `CONFIDENTIAL`. This setting performs a redirect from http to https before the application server requests a user and password.
 1. Unpack `worklightconsole.war` (as a .zip file).
 2. Edit its `WEB-INF/web.xml` file, changing `<transport-guarantee>NONE</transport-guarantee>` to `<transport-guarantee>CONFIDENTIAL</transport-guarantee>`.

3. Repack `worklightconsole.war`.
 4. Unpack `worklightadmin.war` (as a `.zip` file).
 5. Edit its `WEB-INF/web.xml` file, changing `<transport-guarantee>NONE</transport-guarantee>` to `<transport-guarantee>CONFIDENTIAL</transport-guarantee>`.
 6. Repack `worklightadmin.war`.
 7. Redeploy these WAR files, either manually, or through the Ant task `<installworklightadmin>` or `<updateworklightadmin>`. For more information, see “Deploying the MobileFirst Operations Console and Administration Services with Ant tasks” on page 6-55.
- Never use the `<wladm>` Ant task with the attribute `secure="false"`, and never use the `wladm` command with the option `-secure=false`. To achieve this, you must:
 - Ensure that your application server uses an SSL certificate signed by a CA, not a self-signed certificate, and that the host name mentioned in this certificate matches the host name of the application server machine.
 - Ensure that this SSL certificate is contained in the truststore of the JVM that runs the `<wladm>` Ant task or the `wladm` command.
 - Change the file access permissions of the file that contains the password that is used by the `<wladm>` Ant task or the `wladm` command to be as restrictive as possible. To do this, you can use a command, such as the following examples:
 - On UNIX: `chmod 600 adminpassword.txt`
 - On Windows: `cacls adminpassword.txt /P Administrators:F %USERDOMAIN%\%USERNAME%:F`
 - Additionally, you might want to obfuscate the password, to hide it from an occasional glimpse. To do so, use the `wladm config password` command to store the obfuscated password in a configuration file. Then you can copy and paste the obfuscated password to the Ant script or to the password file that you want.
 - In the configuration of the MobileFirst Operations Console web application, set the JNDI property `ibm.worklight.admin.ui.cors.strictssl` to `true`. This property helps rejecting unsecure SSL certificates.
 - In the configuration of the MobileFirst Operations Console web application, set the JNDI property `ibm.worklight.admin.hsts` to `true`. This property implements HTTP Strict Transport Security and helps the administrator's browser remember to access the MobileFirst Operations Console through `https` instead of `http`.

Protecting the administration database

If the password of the administration database (or of the user who owns the corresponding schema of that database) is compromised, that is, becomes potentially known to an unauthorized person, unauthorized deployments of apps and adapters are possible. Here are steps to mitigate this risk.

- Do not host other services than the database management system on the machines that serve this database.
- If you use Ant tasks to configure the MobileFirst Server administration (see “Using Ant tasks to install MobileFirst Server administration” on page 6-53), you must do one of the following actions:
 - Change the file access rights of the Ant XML file to be as restrictive as possible before you store passwords in it. For more information, see step 2 in “Sample configuration files” on page 14-35.

- Write ***** (12 asterisks) in place of the password, so the Ant XML file does not contain the password. Instead, the Ant task queries the password interactively when it is invoked.
- Minimize the number of users who have login access to the machines that run MobileFirst Server.
- Change the file access rights of the application server configuration files that contain the jdbc/WorklightAdminDS data source password to be as restrictive as possible. For more information, see step 3 in “Sample configuration files” on page 14-35.

Protecting the JMX communication

If the JMX communication between Administration Services and the MobileFirst runtime environments are not secured, unauthorized persons who have local access to the MobileFirst Server machines can play man-in-the-middle attacks and thus activate tampered apps and adapters. Here are steps to mitigate this risk.

- For WebSphere Application Server Liberty, follow the procedure of Configuring secure JMX connection to the Liberty profile.
- For Apache Tomcat, use a JMX configuration with SSL, as described in “Configuring Apache Tomcat” on page 6-47.

Protecting the apps and adapters to deploy

If the source from which the MobileFirst administrator receives apps and adapters is not secured, tampered apps and adapters can be submitted to the MobileFirst administrator, who then deploys them. Here are steps to mitigate this risk.

- Ensure that the MobileFirst administrator receives apps and adapters only through channels which guarantee the integrity of the sender and of the sent artifacts. For example, use emails with digital signature, or web-based tools with the need to log in through https.
- Ensure that the development teams that create these apps and adapters use a Version Control System that guarantees the integrity of each modification and disallows modifications by unauthorized persons. Examples of VCS systems in this category are RTC/jazz and Git. An example of a VCS not in this category is CVS.

Protecting against attacks from the internet

Attackers from the internet might attempt to search for security flaws in the MobileFirst Operations Console and Administration Services and try to circumvent the security measures. Here is a tip to mitigate this risk. It assumes that mobile application users connect to MobileFirst Server from the internet, but all legitimate uses of the MobileFirst Operations Console Console and Administration Services are from an intranet.

- Configure your internet gateway or firewall (for example, IBM DataPower®) to block access to URLs under the context roots of the MobileFirst Operations Console (default: /worklightconsole) and of the Administration Services (default: /worklightadmin). At the same time, keep the access to the MobileFirst runtime web applications open.

Database and certificate security passwords

When you configure a MobileFirst Server, you must typically configure database and certificate passwords for security.

Configuration of a IBM MobileFirst Platform Server typically includes the following credentials:

- User name and password to the runtime database
- User name and password to other custom databases
- User name and password to certificates that enable the stamping of apps

All credentials are stored in the in JNDI properties of the application server. Defaults can be stored in the `worklight.properties` file. See “Configuration of MobileFirst applications on the server” on page 10-48 for information about individual properties.

You can encrypt any or all of these passwords. For more information, see “Storing properties in encrypted format” on page 10-56.

Apache Tomcat security options

An optimal Apache Tomcat security balances ease of use and access with strengthening of security and hardening of access.

You must harden the Tomcat Server according to your company policy. Information on how to harden Apache Tomcat is available on the Internet. All other out-of-the-box services provided by Apache Tomcat are unnecessary and can be removed.

Running MobileFirst Server in WebSphere Application Server with Java 2 security enabled

You can run IBM MobileFirst Platform Server in WebSphere Application Server with Java 2 security enabled.

About this task

To enable Java 2 security in WebSphere Application Server, complete the following procedure to modify the `app.policy` file and then restart WebSphere Application Server for the modification to take effect.

Procedure

1. Install MobileFirst Server on a WebSphere Application Server instance. The installation contains all the necessary libraries to support WebSphere Application Server security.
2. Enable Java 2 security in WebSphere Application Server.
 - a. In the WebSphere Application Server console, click **Security > Global security**
 - b. Select **Use Java 2 security to restrict application access to local resources**.
3. Modify the `app.policy` file, `<ws.install.root>/profiles/<server_name>/config/cells/<cell_name>/node/<node_name>/app.policy`.

The `app.policy` file is a default policy file that is shared by all of the WebSphere Application Server enterprise applications. For more information, see *app.policy file permissions* in the WebSphere Application Server documentation.

Add the following content into the `app.policy` file.

```
grant codeBase "file:${was.install.root}/worklight-jee-library-xxx.jar" {
    permission java.security.AllPermission;
};
```

```
// The war file is your WL server war.
```

```

grant codeBase "file:worklight.war" {
    //permission java.security.AllPermission;
    //You can use all permission for simplicity, however, it might
    // cause security problems.
    permission java.lang.RuntimePermission "*";
    permission java.io.FilePermission "${was.install.root}${/}-", "read,write,delete";
    // In Linux need to set TEMP folder of Linux.
    permission java.io.FilePermission "C:/Windows/TEMP/${/}-", "read,write,delete";
    permission java.util.PropertyPermission "*", "read, write";
    permission java.lang.reflect.ReflectPermission "suppressAccessChecks";
    permission com.ibm.tools.attach.AttachPermission "createAttachProvider";
    permission com.ibm.tools.attach.AttachPermission "attachVirtualMachine";
    permission com.sun.tools.attach.AttachPermission "createAttachProvider";
    permission com.sun.tools.attach.AttachPermission "attachVirtualMachine";
    permission java.net.SocketPermission "*", "accept,resolve";
};

```

4. Restart WebSphere Application Server for the modification of the app.policy file to take effect.

Protecting your mobile application traffic by using IBM WebSphere DataPower as a security gateway

You can use IBM WebSphere DataPower in the Data Management Zone (DMZ) of your enterprise to protect MobileFirst mobile application traffic.

Before you begin

1. Ensure that IBM MobileFirst Platform Command Line Interface for iOS is installed.
2. Establish your stand-alone server environment on Liberty or WebSphere Application Server.

About this task

Protecting mobile application traffic that comes into your network from customer and employee devices involves preventing data from being altered, authenticating users, and allowing only authorized users to access applications. To protect mobile application traffic that is initiated by a client MobileFirst application, you can use the security gateway features of IBM WebSphere DataPower.

Enterprise topologies are designed to include different zones of protection so that specific processes can be secured and optimized. You can use IBM WebSphere DataPower in different ways in the DMZ and in other zones within your network to protect enterprise resources. When you start to build out MobileFirst applications to be delivered to the devices of your customers and employees, you can apply these methods to mobile traffic.

You can use IBM WebSphere DataPower as a front-end reverse proxy and security gateway. DataPower uses a multiprotocol gateway (MPGW) service to proxy and secure access to MobileFirst mobile applications. Two authentication options are demonstrated: HTTP basic authentication and HTML forms-based login between the mobile client and DataPower.

Consider adopting the following phased approach to establishing IBM WebSphere DataPower as a security gateway:

1. Install and configure a MobileFirst environment and test the installation with a simple application without DataPower acting as the reverse proxy.
2. Test that your application logic works.

3. Configure an MPGW on DataPower to proxy the mobile application or the MobileFirst Operations Console. Select one of the following authentication options:
 - Use basic authentication for end-user authentication with AAA and generate a single sign-on (SSO) LTPA token for MobileFirst Server running on WebSphere Application Server if the user successfully authenticates.
 - Use HTML form-based login with AAA and generate a single sign-on (SSO) LTPA token for MobileFirst Server, running on WebSphere Application Server if the user successfully authenticates.
4. Test the reverse proxy:
 - Update the MobileFirst configuration on the server with the reverse proxy configuration (see Step 1).
 - Update the mobile security test configuration of each mobile application to use form-based authentication so that the application requests the user to authenticate immediately when the application starts. Either HTTP basic authentication or HTML form-based login is supported before the application starts. For web widgets, widget resources are accessible to the browser only after a user authenticates successfully.

Procedure

1. Set up a MobileFirst configuration.
 - a. For each app that you are configuring, modify the authenticationConfig.xml file on the server to include the following security test, realm, and login module declarations:

```

<securityTests>
  <mobileSecurityTest name="WASTest-securityTest">
    <testDeviceId provisioningType="none"/>
    <testUser realm="WASLTPARealm"/>
  </mobileSecurityTest>
  <webSecurityTest name="WASTest-web-securityTest">
    <testUser realm="WASLTPARealm"/>
  </webSecurityTest>
</securityTests>

<realms>
  <!-- For websphere -->
  <realm name="WASLTPARealm" loginModule="WASLTPAModule">
    <className>com.worklight.core.auth.ext.WebSphereFormBasedAuthenticator</className>
    <parameter name="login-page" value="/login.html"/>
    <parameter name="error-page" value="/loginError.html"/>
  </realm>
</realms>

<loginModules>
  <!-- For websphere -->
  <loginModule name="WASLTPAModule">
    <className>com.worklight.core.auth.ext.WebSphereLoginModule</className>
  </loginModule>
</loginModules>

```

By default, the authenticationConfig.xml file is usually available in this directory: `<WAS_INSTALL_DIR>/profiles/<WAS_PROFILE>/installedApps/<WAS_CELL>/IBM_Worklight_Console.ear/worklight.war/WEB-INF/classes/conf.`

- b. Restart the MobileFirst Operations Console enterprise application.
2. Update your client mobile app.
 - a. In your client mobile app, add the following JavaScript to your HTML MobileFirst application:

```

function showLoginScreen() {
    $("#index").hide();
    $("#authPage").show();
}

function showMainScreen() {
    $("#authPage").hide();
    $("#index").show();
}

var myChallengeHandler = WL.Client.createChallengeHandler("WASLTPARealm");
var lastRequestURL;

myChallengeHandler.isCustomResponse = function(response) {

    //A normal login form has been returned
    var findError = response.responseText.search("DataPower/Worklight Error");
    if(findError >= 0) {
        return true;
    }

    //A normal login form has been returned
    var findLoginForm = response.responseText.search("DataPower/Worklight Form Login");
    if(findLoginForm >= 0) {
        lastRequestURL = response.request.url;
        return true;
    }

    //This response is a MobileFirst Server response, handle it normally
    return false;
};

myChallengeHandler.handleChallenge = function(response) {
    showLoginScreen();
};

challengeHandler1.handleFailure = function(response) {
    console.log("Error during WL authentication.");
};

myChallengeHandler.submitLoginFormCallback = function(response) {
    var isCustom = myChallengeHandler.isCustomResponse(response);
    if(isCustom) {
        myChallengeHandler.handleChallenge(response);
    }
    else {
        //hide the login screen, you are logged in
        showMainScreen();

        myChallengeHandler.submitSuccess();
    }
};

//When the login button is pressed, submit a login form
$("#loginButton").click(function() {
    var reqURL = "/j_security_check";
    alert(lastRequestURL);
    var options = {method: "POST"};
    options.parameters = {
        j_username: $("#username").val(),
        j_password: $("#password").val(),
        originalUrl : lastRequestURL,
        login: "Login"
    };
});

```

```

options.headers = {};
myChallengeHandler.submitLoginForm(reqURL, options, myChallengeHandler.submitLoginFormCallback);
});

```

- b. To add the authentication test to an application or device, add a **securityTest** attribute to the environment tag in the project application-descriptor.xml file.
Set the value of this attribute to the name of the security test that you declared in the authenticationConfig.xml file in substep 1a.. Here is an iPad example:

```

<ipad bundleId="com.Datapower" securityTest="WASSTest-securityTest" version="1.0">
  <worklightSettings include="false"/>
  <security>
    <encryptWebResources enabled="false"/>
    <testWebResourcesChecksum enabled="false" ignoreFileExtensions="png, jpg, jpeg, gif, mp4, mp3"/>
  </security>
</ipad>

```

- 3. Define a multiprotocol gateway.
 - a. In the IBM DataPower WebGUI, in the search box under Control Panel, enter Multi-Protocol and click **New Multi-Protocol Gateway**.
 - b. On the General Configuration page, pdefine the following settings.

Table 6-34. General Configuration

Field	Description
Multi-Protocol Gateway Name	Provide a name for your gateway.
Response Type	Select Non-XML . With this value, HTTP web application traffic (including JSON, JavaScript, and CSS) passes through the appliance.
Request Type	Select Non-XML . With this value, HTTP web application requests are handled by the appliance.
Front Side Protocol	<p>Select HTTPS (SSL). For this type of interaction in which user credentials are passed between client and server, HTTPS is appropriate. Also provide the following front-side handler details:</p> <p>Name Enter a name for the configuration.</p> <p>Port Number Enter a number for the listening port. This port number must match the port number that you specify if you define an AAA policy that uses HTML form-based authentication. See Table 6-36 on page 6-126.</p> <p>Allowed Methods and Versions Select GET method to enable support for HTTP Get.</p> <p>SSL Proxy Select an SSL Reverse Proxy profile to identify the SSL server.</p>

Table 6-34. General Configuration (continued)

Field	Description
Multi-Protocol Gateway Policy	Click +, and then create rules to define the policies that are listed in the following topics, depending on the type of authentication that you decide to use: <ul style="list-style-type: none"> Policy worklight-basicauth for HTTP basic authentication. See “Rules for HTTP basic authentication” on page 6-127. Policy mpgw-form for HTML form-based login authentication. See “Rules for HTML form-based authentication” on page 6-129.
Backend URL	Specify the address and port of the MobileFirst Server that is hosted on WebSphere Application Server.

4. Create an AAA policy that supports the HTTP basic authentication or HTML form-based login policy that you defined in the previous step.
 - a. In the IBM DataPower WebGUI, in the search box under Control Panel, enter AAA, and then click **Add**.
 - b. Depending on the type of authentication that you want to use, define the following settings.
 - For HTTP basic authentication, specify the settings as listed in the following table.

Table 6-35. AAA policy for HTTP basic authentication

Phase	Description
Extract Identity	In the Methods field, select HTTP Authentication Header .
Authenticate	Choose the authentication method. If WebSphere Application Server is using LDAP, configure LDAP here.
Extract Resource	Select URL Sent by Client .
Post processing	Generate an LTPA token. Specify LTPA Token Expiry , LTPA Key File , and LTPA Key File Password .

- For HTML form-based login, specify the settings as listed in the following table.

Table 6-36. AAA policy for HTML forms-based authentication

Phase	Description
Extract Identity	In the Methods field, select HTML Forms-based Authentication . Select or create an HTML forms-based policy that has the Use SSL for Login option enabled, assigns SSL Port to the port number on which the MPGWS is listening (that was specified in step 3), and has the Enable Session Migration option disabled.
Authenticate	Choose the authentication method. If WebSphere Application Server is using LDAP, configure LDAP here.

Table 6-36. AAA policy for HTML forms-based authentication (continued)

Phase	Description
Extract Resource	Select URL Sent by Client .
Post processing	Generate an LTPA token. Specify LTPA Token Expiry, LTPA Key File, and LTPA Key File Password .

- On the Advanced page, specify the advanced settings as listed in the following table.

Table 6-37. Advanced settings

Field	Value
Persistent Connections	On.
Allow Cache-Control Header	Off
Loop Detection	Off
Follow Redirects	Off. This value prevents the DataPower back-end user agent from resolving redirects from the back end. Web applications typically require a client browser to resolve redirects so that they can maintain the context for “directory” along with setting an LTPA cookie on the client.
Allow Chunked Uploads	Off
MIME Back Header Processing	Off
MIME Front Header Processing	Off

Results

Your MobileFirst mobile application traffic is now protected by an IBM WebSphere DataPower secure gateway. Authentication is enforced on the DataPower device and the credentials (header or LTPA token) are forwarded downstream to MobileFirst Server to establish the user identity as part of the mobile traffic.

Rules for HTTP basic authentication

Add rules to define an HTTP basic authentication policy that is named `worklight-basicauth`.

You create the `worklight-basicauth` policy as part of the process of defining a multiprotocol gateway. See “Protecting your mobile application traffic by using IBM WebSphere DataPower as a security gateway” on page 6-122, Table 6-34 on page 6-125.

Table 6-38. HTTP Basic Authentication properties

Property	Value
Policy Name	<code>worklight-basicauth</code>

Table 6-38. HTTP Basic Authentication properties (continued)

Property	Value
Order of configured rules	<ol style="list-style-type: none"> worklight-basicauth_rule_0: see Table 6-39 worklight-basicauth_rule_3: see Table 6-42 on page 6-129 worklight-basicauth_rule_1: see Table 6-40 worklight-basicauth_rule_2: see Table 6-41

Table 6-39. Properties of *worklight-basicauth_rule_0*. When processing HTML content, skip processing with the icon that is associated with the website or the web page.

Property	Value
Direction	Client to Server or Both Directions.
Match	<ul style="list-style-type: none"> Type = URL Pattern = /favicon.ico
Advanced	"Set Variable" -> var://service/mpgw/skip-backside = 1
Result	Not applicable.

Table 6-40. Properties of *worklight-basicauth_rule_1*. Handle end-user authentication if an LTPA token does not exist.

Property	Value
Direction	Client to Server.
Match	<ul style="list-style-type: none"> Type = URL Pattern = *
AAA	BasicAuth2LTPA <ul style="list-style-type: none"> Output: NULL
Result	Not applicable.

Table 6-41. Properties of *worklight-basicauth_rule_2*. Handle both the redirect and content-type reset on the response side.

Property	Value
Direction	Server to Client.
Match	<ul style="list-style-type: none"> Type = URL Pattern = *
Filter	Provide a custom stylesheet that handles redirect and content-type rewrite. For a sample redirect stylesheet, see "Sample redirect stylesheet" on page 6-132. <ul style="list-style-type: none"> Output: NULL
Result	Not applicable.

Table 6-42. Properties of worklight-basicauth_rule_3. Because the policy is applied to each request, the rules must be ordered such as to ensure that an LTPA token is verified if it exists in the HTTP request. If no token is available, proceed to the next rule and authenticate the user.

Property	Value
Direction	Client to Server.
Match	<ul style="list-style-type: none"> • Type = HTTP • HTTP header tag = Cookie • HTTP value match = *LtpaToken*
AAA	VerifyLTPA <ul style="list-style-type: none"> • Output: NULL
Result	Not applicable.

Rules for HTML form-based authentication

Add rules to define an HTML form-based authentication policy named mpgw-form.

You create the mpgw-form policy as part of the process of defining a multi-protocol gateway. See “Protecting your mobile application traffic by using IBM WebSphere DataPower as a security gateway” on page 6-122, Table 6-34 on page 6-125.

Table 6-43. HTTP Form-Based Login properties

Property	Value
Policy Name	mpgw-form
Order of configured rules	<ol style="list-style-type: none"> 1. mpgw-form_rule_0: see Table 6-44 2. mpgw-form_rule_1: see Table 6-45 3. mpgw-form_rule_2: see Table 6-46 on page 6-130 4. mpgw-form_rule_3: see Table 6-47 on page 6-130 5. mpgw-form_rule_6: see Table 6-48 on page 6-130

Table 6-44. Properties of mpgw-form_rule_0. This rule skips processing with the icon that is associated with the web site or the web page.

Property	Value
Direction	Client to Server or Both Directions.
Match	<ul style="list-style-type: none"> • Type = URL • Pattern = /favicon.ico
Advanced	“Set Variable” -> var://service/mpgw/skip-backside = 1
Result	Not applicable.

Table 6-45. Properties of mpgw-form_rule_1. This rule verifies an LTPA token if it exists in the HTTP request.

Property	Value
Direction	Client to Server.

Table 6-45. Properties of *mpgw-form_rule_1* (continued). This rule verifies an LTPA token if it exists in the HTTP request.

Property	Value
Match	<ul style="list-style-type: none"> Type = HTTP HTTP header tag = Cookie HTTP value match = *LtpaToken*
AAA	VerifyLTPA <ul style="list-style-type: none"> Output: NULL
Result	Not applicable.

Table 6-46. Properties of *mpgw-form_rule_2*. This rule generates the HTML form login page.

Property	Value
Direction	Client to Server.
Match	<ul style="list-style-type: none"> Match with PCRE = on Type = URL Pattern = /(Login Error)Page\.htm(1)?(\?originalUrl=.*)?
Transform	Provide a custom stylesheet that builds either a Login or Error HTML page. For a sample stylesheet, see “Sample form login stylesheet” on page 6-131. Note: The HTML Login Form policy allows you to specify whether you retrieve the login and error pages from DataPower or from the back-end application server.
Advanced	Select the set-var action and specify the service variable: <code>var://service/roving-url</code> and value with the endpoint of your login page.
Result	Not applicable.

Table 6-47. Properties of *mpgw-form_rule_3*. This rule handles end-user authentication if an LTPA token does not exist.

Property	Value
Direction	Client to Server.
Match	<ul style="list-style-type: none"> Type = URL Pattern = *
Advanced	“Convert Query Parameter to XML”. Accept default values for other selections.
AAA	Form2LTPA

Table 6-48. Properties of *mpgw-form_rule_6*. This rule handles both the redirect and content-type reset on the response side.

Property	Value
Direction	Server to Client.
Match	<ul style="list-style-type: none"> Type = URL Pattern = *

Table 6-48. Properties of `mpgw-form_rule_6` (continued). This rule handles both the redirect and content-type reset on the response side.

Property	Value
Filter	Provide a custom stylesheet that handles redirect and content-type rewrite. For a sample redirect stylesheet, see “Sample redirect stylesheet” on page 6-132. <ul style="list-style-type: none"> Output: NULL
Result	Not applicable.

Sample form login stylesheet

You can use this sample stylesheet to generate the HTML form login page or error page when creating rules to define an HTML forms-based authentication policy.

You provide a custom stylesheet when defining rule `mpgw-form_rule_2`. See “Rules for HTML form-based authentication” on page 6-129, Table 6-46 on page 6-130.

```
<?xml version="1.0" encoding="UTF-8" ?>
<xsl:stylesheet xmlns:xsl="http://www.w3.org/1999/XSL/Transform"
  version="1.0"
  xmlns:dp="http://www.datapower.com/extensions"
  xmlns:re="http://exslt.org/regular-expressions"
  extension-element-prefixes="dp re"
  exclude-result-prefixes="dp re">
  <xsl:output method="html" omit-xml-declaration="yes" />
  <xsl:template match="/">
    <xsl:choose>
      <xsl:when test="contains(dp:variable('var://service/URI' ), 'LoginPage.htm')">
        <xsl:variable name="uri_temp" select="dp:decode( dp:variable('var://service/URI' ), 'url')" />
        <xsl:variable name="uri">
          <xsl:choose>
            <xsl:when test="contains($uri_temp, 'originalUrl')">
              <xsl:value-of select="$uri_temp" />
            </xsl:when>
            <xsl:otherwise>
              <xsl:value-of select="dp:decode(dp:http-request-header('Cookie'), 'url')" />
            </xsl:otherwise>
          </xsl:choose>
        </xsl:variable>
        <xsl:variable name="redirect_uri_preprocess">
          <xsl:for-each select="re:match($uri, '(.*)originalUrl=(.*)')">
            <xsl:if test="position()=3">
              <xsl:value-of select="." />
            </xsl:if>
          </xsl:for-each>
        </xsl:variable>
        <xsl:variable name="redirect_uri">
          <xsl:choose>
            <xsl:when test="contains($redirect_uri_preprocess, ';')">
              <xsl:value-of select="substring-before($redirect_uri_preprocess, ';')" />
            </xsl:when>
            <xsl:otherwise>
              <xsl:value-of select="$redirect_uri_preprocess" />
            </xsl:otherwise>
          </xsl:choose>
        </xsl:variable>
        <html>
          <head>
            <meta http-equiv="Pragma" content="no-cache" />
            <title>Login Page</title>
          </head>
          <body>
```

```

<h2>DataPower/Worklight Form Login</h2>
<form name="LoginForm" method="post" action="j_security_check">
  <p>
    <strong>Please enter your user ID and password.</strong>
    <br />
    <font size="2" color="grey">If you have forgotten your user ID or password, please contact
the server administrator.</font>
  </p>
  <p>
    <table>
      <tr>
        <td>User ID:</td>
        <td>
          <input type="text" size="20" name="j_username" />
        </td>
      </tr>
      <tr>
        <td>Password:</td>
        <td>
          <input type="password" size="20" name="j_password" />
        </td>
      </tr>
    </table>
  </p>
  <p>
    <input type="hidden" name="originalUrl">
    <xsl:attribute name="value">
      <xsl:value-of select="$redirect_uri" />
    </xsl:attribute>
    </input>
    <input type="submit" name="login" value="Login" />
  </p>
</form>
</body>
</html>
</xsl:when>
<xsl:otherwise>
  <!-- error -->
  <html>
    <head>
      <meta http-equiv="Pragma" content="no-cache" />
      <title>Error Page</title>
    </head>
    <body>
      <h2>DataPower/Worklight Error</h2>
      You must provide a valid user identity.
    </body>
  </html>
</xsl:otherwise>
</xsl:choose>
<dp:set-response-header name="'Content-Type'" value="'text/html'" />
<dp:set-variable name="'var://service/mpgw/skip-backside'" value="true()" />
</xsl:template>
</xsl:stylesheet>

```

Sample redirect stylesheet

You can use this sample stylesheet to handle redirection and content-type rewriting. You refer to the stylesheet when you create rules to define an HTTP basic authentication policy or an HTML forms-based authentication policy.

You provide a custom stylesheet when you define rule `mpgw-form_rule_6` (see “Rules for HTML form-based authentication” on page 6-129, Table 6-48 on page 6-130), and when you define rule `worklight-basicauth_rule_2` (see “Rules for HTTP basic authentication” on page 6-127, Table 6-41 on page 6-128).

```

<xsl:stylesheet version="1.0"
  xmlns:xsl="http://www.w3.org/1999/XSL/Transform"
  xmlns:dp="http://www.datapower.com/extensions"
  xmlns:re="http://exslt.org/regular-expressions"
  extension-element-prefixes="dp re"
  exclude-result-prefixes="dp">

  <xsl:template match="/">
    <xsl:choose>
      <xsl:when test="dp:responding()">
        <xsl:variable name="code">
          <xsl:choose>
            <xsl:when test="dp:http-response-header('x-dp-response-code') != ''">
              <xsl:value-of select="substring(dp:http-response-header('x-dp-response-code'), 1, 3)"/>
            </xsl:when>
            <xsl:otherwise>
              <xsl:value-of select="substring(dp:variable('var://service/error-headers'), 10, 3)"/>
            </xsl:otherwise>
          </xsl:choose>
        </xsl:variable>

        <xsl:choose>
          <xsl:when test="$code = '302'">
            <xsl:variable name="dphost" select="dp:http-request-header('Host')"/>
            <xsl:variable name="host" select="$dphost"/>
            <xsl:variable name="location" select="dp:http-response-header('Location')"/>
            <xsl:variable name="location_host">
              <xsl:for-each select="re:match($location, '(\w+):\\/(\\/([^\s/]+)')">
                <xsl:if test="position()=3">
                  <xsl:value-of select="." />
                </xsl:if>
              </xsl:for-each>
            </xsl:variable>
            <xsl:variable name="location_final">
              <xsl:value-of select="re:replace($location, $location_host, 'g', $host)"/>
            </xsl:variable>
            <dp:set-http-response-header name="'Location'" value="$location_final" />
          </xsl:when>
          <xsl:otherwise>
            <xsl:variable name="orig-content" select="dp:variable('var://service/original-response-content-type')"/>
            <xsl:if test="$orig-content != ''">
              <dp:set-http-response-header name="'Content-Type'" value='$orig-content' />
            </xsl:if>
          </xsl:otherwise>
        </xsl:choose>

        <!-- the following prevent DataPower from overriding the
           response code coming back from WorkLight Server
        -->
        <dp:set-response-header name="'x-dp-response-code'" value="'-1'"/>

      </xsl:when>
      <xsl:otherwise/>
    </xsl:choose>
  </xsl:template>
</xsl:stylesheet>

```

Configuring MobileFirst Server to enable TLS V1.2

For MobileFirst Server to communicate with devices that support only TLS V1.2, among the SSL protocols, you must complete the following instructions.

About this task

The steps to configure MobileFirst Server to enable Transport Layer Security (TLS) V1.2 depend on how MobileFirst Server connects to devices.

If MobileFirst Server is behind a reverse proxy that decrypts SSL-encoded packets from devices before passing the packets to the application server, you must enable TLS V1.2 support on your reverse proxy. If you are using IBM HTTP Server as your reverse proxy, see *Securing IBM HTTP Server* for instructions.

If MobileFirst Server communicates directly with devices, the steps to configure MobileFirst Server to enable TLS V1.2 depend on the application server that you use. The following sections provide you with the specific instructions for Apache Tomcat, WebSphere Application Server Liberty profile, and WebSphere Application Server full profile.

Apache Tomcat Procedure

1. Confirm that the Java Runtime Environment (JRE) supports TLS V1.2.
Ensure that you use Oracle JRE 1.7.0_75 or later for MobileFirst Server V7.0 or earlier.
2. Edit the `conf/server.xml` file and modify the `<Connector>` element that declares the HTTPS port so that the `sslEnabledProtocols` attribute has the following value:

```
sslEnabledProtocols="TLSv1.2,TLSv1.1,TLSv1,SSLv2Hello"
```

WebSphere Application Server Liberty profile Procedure

1. Confirm that the Java Runtime Environment (JRE) supports TLS V1.2.
 - If you use an IBM Java SDK, ensure that your IBM Java SDK is patched for the POODLE vulnerability. You can find the minimum IBM Java SDK versions that contain the patch for your version of WebSphere Application Server in *Security Bulletin: Vulnerability in SSLv3 affects IBM WebSphere Application Server (CVE-2014-3566)*.

Note: You can use the versions that are listed in the security bulletin or later versions.

 - If you use an Oracle Java SDK, ensure that you use Oracle JRE 1.7.0_75 or later for MobileFirst Server V7.0 or earlier.
2. If you use an IBM Java SDK, edit the `server.xml` file.
 - a. Add the following line:

```
<ssl id="defaultSSLConfig" keyStoreRef="defaultKeyStore" sslProtocol="SSL_TLSv2"/>
```
 - b. Add the `sslProtocol="SSL_TLSv2"` attribute to all existing `<ssl>` elements.

WebSphere Application Server full profile Procedure

1. Confirm that the Java Runtime Environment (JRE) supports TLS V1.2.
Ensure that your IBM Java SDK is patched for the POODLE vulnerability. You can find the minimum IBM Java SDK versions that contain the patch for your version of WebSphere Application Server in *Security Bulletin: Vulnerability in SSLv3 affects IBM WebSphere Application Server (CVE-2014-3566)*.

Note: You can use the versions that are listed in the security bulletin or later versions.

 2. Log in to WebSphere Application Server administrative console, and click **Security > SSL certificate and key management > SSL configurations**.
 3. For each SSL configuration listed, modify the configuration to enable TLS V1.2.

- a. Select an SSL configuration and then, under **Additional Properties**, click **Quality of protections (QoP) settings**.
- b. From the **Protocol** list, select SSL_TLSv2.
- c. Click **Apply** and then save the changes.

Configuring SSL between MobileFirst adapters and back-end servers by using self-signed certificates

You can configure SSL between MobileFirst adapters and back-end servers by importing the server self-signed SSL certificate to the MobileFirst keystore.

Procedure

1. Check the configuration in the `worklight.properties` file. The configuration might look like this example (the password will be different for each project):

```
#####
# MobileFirst SSL keystore
#####
#SSL certificate keystore location.
ssl.keystore.path=conf/mfp-default.keystore
#SSL certificate keystore type (jks or PKCS12)
ssl.keystore.type=jks
#SSL certificate keystore password.
ssl.keystore.password=oW523Mes0b241qAXc5F7
```

2. Make sure that the keystore file exists in the `server/conf` folder of the MobileFirst project.
3. Export the server public certificate from the back-end server keystore.

Note: Export back-end public certificates from the back-end keystore by using `keytool` or `openssl` lib. Do not use the export feature in a web browser.

4. Import the back-end server certificate into the MobileFirst keystore.
5. Restart the MobileFirst Server.

Example

The CN name of the back-end certificate must match what is configured in the `adapter.xml` file. For example, consider an `adapter.xml` file that is configured as follows:

```
<protocol>https</protocol>
<domain>mybackend.com</domain>
```

The back-end certificate must be generated with `CN=mybackend.com`.

As another example, consider the following adapter configuration:

```
<protocol>https</protocol>
<domain>123.124.125.126</domain>
```

The back-end certificate must be generated with `CN=123.124.125.126`.

The following example demonstrates how you complete the configuration by using the `Keytool` program.

1. Create a back-end server keystore with a private certificate for 365 days.

```
keytool -genkey -alias backend -keyalg RSA -validity 365 -keystore backend.keystore -storetype JKS
```

Note: The **First and Last Name** field contains your server URL, which you use in the `theadapter.xml` configuration file, for example `mydomain.com` or `localhost`.

2. Configure your back-end server to work with the keystore. For example, in Apache Tomcat, you change the `server.xml` file:

```
<Connector port="443" SSLEnabled="true" maxHttpHeaderSize="8192"
  maxThreads="150" minSpareThreads="25" maxSpareThreads="200"
  enableLookups="false" disableUploadTimeout="true"
  acceptCount="100" scheme="https" secure="true"
  clientAuth="false" sslProtocol="TLS"
  keystoreFile="backend.keystore" keystorePass="password" keystoreType="JKS"
  keyAlias="backend"/>
```

3. Check the connectivity configuration in the `adapter.xml` file:

```
<connectivity>
  <connectionPolicy xsi:type="http:HTTPConnectionPolicy">
    <protocol>https</protocol>
    <domain>mydomain.com</domain>
    <port>443</port>
    <!-- The following properties are used by adapter's key manager for choosing
a specific certificate from the key store
    <sslCertificateAlias></sslCertificateAlias>
    <sslCertificatePassword></sslCertificatePassword>
    -->
  </connectionPolicy>
  <loadConstraints maxConcurrentConnectionsPerNode="2"/>
</connectivity>
```

4. Export the public certificate from the created back-end server keystore:
`keytool -export -alias backend -keystore backend.keystore -rfc -file backend.crt`
5. Import the exported certificate into your MobileFirst Server `mfp-default.keystore` file in the `server/conf` directory of the MobileFirst project:

```
keytool -import -alias backend -file backend.crt -storetype JKS -keystore mfp-default.keystore
```

6. Check that the certificate is correctly imported in the keystore:

```
keytool -list -keystore mfp-default.keystore
```

Configuring SSL by using untrusted certificates

Making SSL work between instances of IBM MobileFirst Platform Server and clients with certificates that are not signed by a known public certificate authority (CA) can be challenging. Each mobile platform has its own peculiarities and enforces different portions of the transport layer security (TLS) standard at different times.

Support for X.509 certificates comes from the individual platforms, not from IBM MobileFirst Platform Foundation for iOS. For more information about specific requirements for X.509 certificates, see the documentation of each mobile platform.

If you have difficulties with getting your application to access a MobileFirst Server because of SSL-related issues, the likely cause is a bad server certificate. Another likely cause is a client that is not properly configured to trust your server. Many other reasons can cause an SSL handshake to fail, so not all possibilities are covered. Some hints and tips are provided to troubleshoot the most basic issues that are sometimes forgotten or overlooked. These issues are important when you deal with the mobile world and X.509 certificates.

Basic concepts

Certificate authority (CA)

An entity that issues certificates. A CA can issue (sign) other certificates or other CA certificates (intermediate CA certificates).

In a public key infrastructure (PKI), certificates are verified by a hierarchical chain of trust. The topmost certificate in this tree is the root CA certificate.

You can purchase your certificates from a public Internet CA or operate your own private (local) CA to issue private certificates for your users and applications. A CA is meant to be an authority that is well-trusted by your clients. Most commercial CAs issue certificates that are automatically trusted by most web browsers and mobile platforms. Using private CAs means that you must take certain actions to ensure that the client trusts certificates that are signed by your root CA.

A certificate can be signed (issued) by one of the many public CAs that are known by your mobile platforms, a private CA, or by itself.

Self-signed certificate

A certificate that is signed by itself and has no CA that attests to its validity.

Using self-signed certificates is not recommended because most mobile platforms do not support their use.

Self-signed CA

A CA that is signed by itself. It is both a certificate and a CA. Because it is the topmost certificate in a tree, it is also the root CA.

Using certificates that are signed by private CAs is not recommended for production use on external Internet-facing servers because of security concerns. However, they might be the preferred option for development and testing environments due to their low cost. They are also often appropriate for internal (intranet) servers as they can be deployed quickly and easily.

Self-signed certificates versus self-signed CAs

When you are dealing with mobile clients, the use of self-signed certificates is not recommended because mobile platforms do not allow the installation of these types of certificates onto the device truststore. This restriction makes it impossible for the client to ever trust the server's certificate. Although self-signed certificates are often recommended for development and testing purposes, they will not work when the client is a mobile device.

The alternative is to use self-signed CA certificates instead of self-signed certificates. Self-signed CA certificates are as easy to acquire and are also as cost-effective of a solution.

You can create a self-signed CA with most tools. For example, the following command uses the `openssl` tool to create a self-signed CA:

```
openssl req -x509 -nodes -days 365 -newkey rsa:2048 -keyout privateKey.key  
-out certificate.crt -reqexts v3_req -extensions v3_ca
```

Note: X.509 version 1 certificates are not allowed by some mobile platforms. You must use X.509 version 3 certificates instead. If you are generating self-signed CA certificates, ensure that they are of the type X.509 version 3, and have the following extension defined: `basicConstraints = CA:TRUE`. See the appropriate tool's documentation for how to specify the required version and certificate extensions. For `openssl` commands, you can specify the `-reqexts v3_req` flag to indicate version 3 X.509 certificates, and the `-extensions v3_ca` flag to indicate that the certificate is also a CA.

You can check the certificate version and extensions by running the following `openssl` command:

```
openssl x509 -in certificate.crt -text -noout
```

Establishing trust on the client

When you open a web page on your mobile browser or connect directly to your MobileFirst Server on an HTTPS port, a client receives a server certificate in the SSL handshake. The client then evaluates the server certificate against its list of known and trusted CAs to establish trust. Each mobile platform includes a set of trusted CAs that are deemed trustworthy for issuing SSL certificates. Trust is established if your server certificate is signed by a CA that is already trusted by the device. After trust is established, the SSL handshake is successful and you are allowed to open the web page on a browser or connect directly to your server.

However, if your server uses a certificate that is signed by a CA that is unknown to the client, the trust cannot be established, and your SSL handshake fails. To ensure your client device trusts your server's certificate, you must install the trust anchor certificate (root CA) on the client device.

Note: Only the root CA certificate (trust anchor) needs to be installed. You do not need to install any other certificates, such as intermediaries, on the device.

For iOS, see “Installing the root CA on iOS” on page 6-140.

Handling the certificate chain

If you are using a server certificate that is not signed by itself, you must ensure that the server sends the full certificate chain to the client.

For the client to validate the certificate path, it must have access to the full certificate chain. To ensure that the client has access to the full certificate chain, including intermediate certificates, ensure that all the certificates in the chain are in the server-side keystore file.

For the WebSphere Application Server Liberty, see “Updating your keystore and Liberty profile configuration to use a certificate chain” on page 6-142.

Handling certificate extensions

RFC 5280 (and its predecessors) defines a number of certificate extensions that provide extra information about the certificate. Certificate extensions provide a means of expanding the original X.509 certificate information standards.

When an extension is specified in an X.509 certificate, the extension must specify whether it is a critical or non-critical extension. A client that is processing a certificate with a critical extension that the client does not recognize, or which the client cannot process, must reject the certificate. A non-critical extension can be ignored if it is not recognized.

Not all mobile platforms recognize or process certain certificate extensions in the same manner. For this reason, you must follow the RFC as closely as possible. Avoid certificate extensions unless you know that all of your targeted mobile platforms can handle them as you expect.

CRL support

If your certificate supports certificate revocation lists (CRLs), ensure that the CRL URL is valid and accessible. Otherwise, certificate chain validation fails.

Tools to use to verify the server certificate

To debug certificate path validation problems, try the `openssl s_client` command line tool. This tool generates good diagnostic information that is helpful in debugging SSL issues.

The following example shows how to use the `openssl s_client` command line tool:

```
openssl s_client -CApath $HOME/CAdir -connect hostname:port
```

The following example shows how to inspect a certificate:

```
openssl x509 -in certificate.crt -text -noout
```

Troubleshooting problems with server certificates that are not signed by a trusted certificate authority

Table 6-49. Troubleshoot problems with server certificates

Problem	Actions to take
Unable to install the root CA on iOS. Certificate installs, but after installation, iOS shows the certificate as not trusted.	The certificate is not identified as a certificate authority. Ensure that the certificate specifies a certificate extension: <code>basicConstraints = CA:TRUE</code> For more information, see “Self-signed certificates versus self-signed CAs” on page 6-137. Ensure that the certificate is in PEM format. Ensure that the certificate has a <code>.crt</code> file extension.
"errorCode":"UNRESPONSIVE_HOST","errorMsg":"The service is currently not available."	This error usually indicates an SSL handshake failure. The client cannot establish trust for the server certificate. <ol style="list-style-type: none">1. Ensure that you installed the server’s root CA on the client device. For more information, see “Establishing trust on the client” on page 6-138.2. Ensure that the server sends the complete certificate chain and in the right order. For more information, see “Handling the certificate chain” on page 6-138. The server certificate is invalid. <ol style="list-style-type: none">1. Check the validity of the server certificate. For more information, see “Tools to use to verify the server certificate.”2. Ensure that the CRL URL is valid and reachable. For more information, see “CRL support.”3. The server certificate contains a critical certificate extension that is not recognized by the client platform. For more information, see “Handling certificate extensions” on page 6-138.





Table 6-49. Troubleshoot problems with server certificates (continued)

Problem	Actions to take
After installation, the certificate does not show up in the system's trusted credentials or truststore.	<p>Ensure that you did not install the server certificate by accessing the protected resource directly from your browser. This action imports the certificate only into the browser space and not into the device system truststore. The only requirement is that you install the root CA.</p> <p>For more information about how to properly install the root CA on the device, see the following topics.</p> <p>For iOS, see "Installing the root CA on iOS."</p>
SCRIPT7002: XMLHttpRequest: Network Error 0x2ee4, Could not complete the operation due to error 00002ee4	<p>Ensure that you installed the server's root CA on the client device. For more information, see "Establishing trust on the client" on page 6-138.</p> <p>Ensure that the server sends the complete certificate chain and in the right order. For more information, see "Handling the certificate chain" on page 6-138.</p>

Related tasks:

"Configuring SSL for Liberty profile" on page 6-220
 Create a keystore, import the Secure Socket Layer (SSL) certificate, and edit the server.xml file to configure SSL on Liberty profile.

Related information:

-  Security with HTTPS and SSL
-  HTTPS Server Trust Evaluation
-  The Transport Layer Security (TLS) Protocol Version 1.2
-  RFC 5280 - Internet X.509 Public Key Infrastructure Certificate and Certificate Revocation List (CRL) Profile

Installing the root CA on iOS

The root CA must be installed on the client device to ensure that the client trusts server certificates that are signed by your private CAs.

About this task

To establish trust for your server certificate, you must install the trust anchor certificate (root CA) on the client device.

Note: Only the root CA certificate (trust anchor) must be installed. You do not need to install any other certificates, such as intermediaries, on the device.

Procedure

1. Ensure that the root CA is in PEM file format and has a .crt file extension. Convert as needed.
2. Run the following command to view the certificate details.

```
openssl x509 -in certificate.crt -text -noout
```
3. Ensure that the certificate is of version X.509 v3. The certificate details must show Version 3.

Note: The following openssl flag generates X.509 v3 certificates:

-reqexts v3_req

4. Ensure that the certificate is a certificate authority. The certificate details must show X509v3 Basic Constraints: CA:TRUE

Note: The following openssl flag generates the CA extension:

-extensions v3_ca

5. To download the certificate file on the device, send it as an email attachment or host it on a secure website.

Note: Do not install the server certificate by accessing the protected resource directly from your browser. This action imports the certificate only into the browser space and not into the device system truststore.

6. After you have the certificate file on the device, click the file to allow the iOS system to install the certificate.

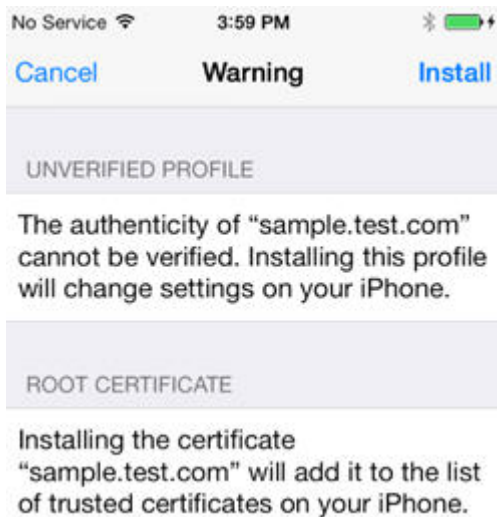
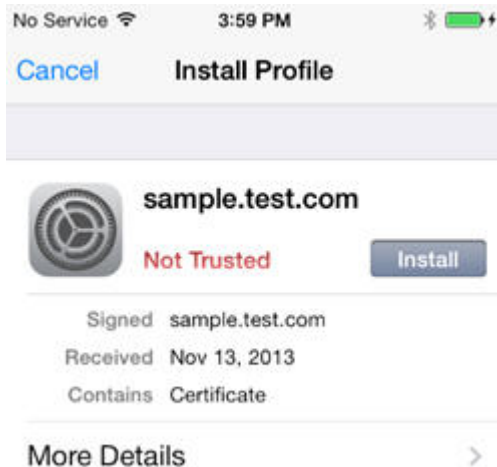

7. Check that the certificate was properly installed under **Settings > General > Profiles > Configuration Profiles**.

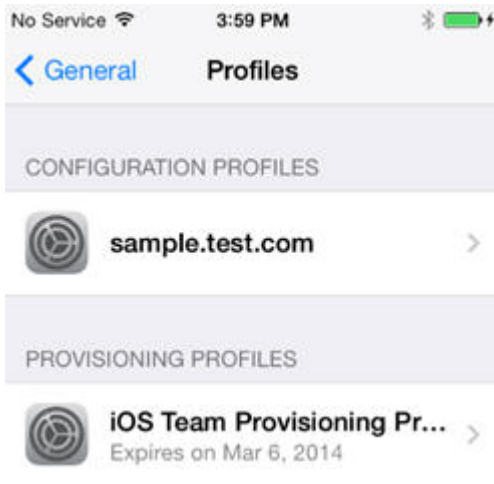

8. Ensure that the iOS device lists the CA as a trusted certificate authority.

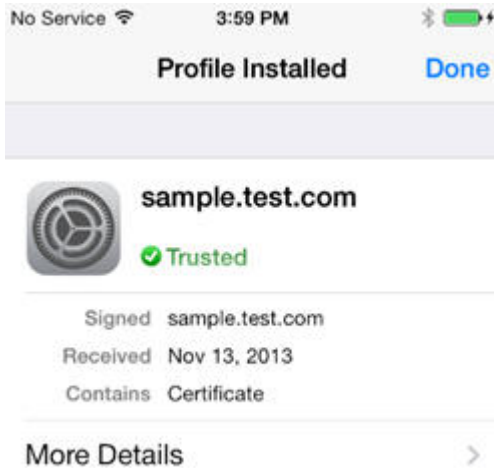

Updating your keystore and Liberty profile configuration to use a certificate chain

You must ensure that your server sends the whole certificate chain to client devices on an SSL handshake.

About this task

For the client to validate the certificate path, it must have access to the full certificate chain. To ensure that the client has access to the full certificate chain (including intermediate certificates), ensure that all the certificates in the chain are in the server-side keystore file.

Assuming that you have a root CA certificate, intermediate certificates, and a server certificate, the whole chain must be sent on the HTTPS connection. These certificates must be concatenated in one file, by concatenating in the following order: server certificate, intermediate CA certificates (if any exist, and if so, in the order in which they were signed), and finally the root CA.

The following example assumes that you have a server certificate (SERVER_IDENTITY_CERT_NAME), one intermediate CA certificate

(`INTERMEDIATE_CA_CERT_NAME`), and a root CA (`ROOT_CA_CERT_NAME`).

Procedure

1. Open a terminal and navigate to a temporary working directory.
2. Concatenate your certificates to form the certificate chain.
 - a. Concatenate the intermediate and the root CA certificates.

```
cat INTERMEDIATE_CA_CERT_NAME ROOT_CA_CERT_NAME > INTERMEDIATE_CA_CHAIN_CERT_NAME
```
 - b. Add the server certificate to the chain.

```
cat .SERVER_IDENTITY_CERT_NAME INTERMEDIATE_CA_CHAIN_CERT_NAME > server_chain.crt
```
3. Export the private key and certificate chain into a `.p12` keystore.

```
openssl pkcs12 -export -in server_chain.crt -inkey server/server_key.pem -out server/server.p12 -passout pass:passServerP12 -passin pass:passServer
```
4. Update your Liberty profile `server.xml` file.
 - a. Enable the SSL feature.

```
<featureManager>
...
  <feature>ssl-1.0</feature>
...
</featureManager>
```
 - b. Create an SSL configuration.

```
<ssl id="mySSLSettings" keyStoreRef="myKeyStore" />
  <keyStore id="myKeyStore"
    location="server/server.p12"
    type="PKCS12"
    password="passServer12" />
```
 - c. Configure your HTTP endpoint to use this SSL configuration or set the configuration as the default.

```
<sslDefault sslRef="mySSLSettings" />
```

What to do next

For more information, see [Enabling SSL communication for the Liberty profile](#).

Handling MySQL stale connections

Instructions for how to configure your application server to avoid MySQL timeout issues.

The MySQL database closes its connections after a period of non-activity on a connection. This timeout is defined by the system variable called `wait_timeout`. The default is 28000 seconds (8 hours).

When an application tries to connect to the database after MySQL closes the connection, the following exception is generated:

```
com.mysql.jdbc.exceptions.jdbc4.MySQLNonTransientConnectionException: No operations allowed after statement closed.
```

The following sections provide the configuration elements specific to each application server you can use to avoid this exception if you use the MySQL database.

Apache Tomcat configuration

Edit the `server.xml` and `context.xml` files, and for every `<Resource>` element add the following properties:

- `testOnBorrow="true"`

- validationQuery="select 1"

For example:

```
<Resource name="jdbc/AppCenterDS"
  type="javax.sql.DataSource"
  driverClassName="com.mysql.jdbc.Driver"
  ...
  testOnBorrow="true"
  validationQuery="select 1"
/>
```

WebSphere Application Server Liberty profile configuration

Note: MySQL in combination with WebSphere Application Server Liberty profile or WebSphere Application Server full profile is not classified as a supported configuration. For more information, see WebSphere Application Server Support Statement. We suggest that you use IBM DB2 or another database supported by WebSphere Application Server to benefit from a configuration that is fully supported by IBM Support.

Edit the server.xml file and for every <dataSource> element (runtime and Application Center databases) add a <connectionManager> element with the agedTimeout property:

```
<connectionManager agedTimeout="timeout"/>
```

For example:

```
<dataSource jndiName="jdbc/AppCenterDS" transactional="false">
  <connectionManager agedTimeout="7h30m"/>
  <jdbcDriver libraryRef="MySQLLib"/>
  ...
</dataSource>
```

WebSphere Application Server full profile configuration

Note: MySQL in combination with WebSphere Application Server Liberty profile or WebSphere Application Server full profile is not classified as a supported configuration. For more information, see WebSphere Application Server Support Statement. We suggest that you use IBM DB2 or another database supported by WebSphere Application Server to benefit from a configuration that is fully supported by IBM Support.

1. Log in to the WebSphere Application Server console.
2. Select **Resources > JDBC > Data sources**.
3. For each MySQL data source:
 - a. Click the data source.
 - b. Select **Connection pool properties** under **Additional Properties**.
 - c. Modify the value of the **Aged timeout** property. The value must be lower than the MySQL wait_timeout system variable to have the connections purged prior to the time that MySQL closes these connections.
 - d. Click OK.

Managing the DB2 transaction log size

When you deploy an application that is at least 40 MB with IBM MobileFirst Platform Operations Console, you might receive a transaction log full error.

About this task

The following system output is an example of the transaction log full error code.

```
DB2 SQL Error: SQLCODE=-964, SQLSTATE=57011
```

The content of each application is stored in the MobileFirst administration database.

The active log files are defined in number by the **LOGPRIMARY** and **LOGSECOND** database configuration parameters, and in size by the **LOGFILSIZ** database configuration parameter. A single transaction cannot use more log space than **LOGFILSZ * (LOGPRIMARY + LOGSECOND) * 4096 KB**.

The **DB2 GET DATABASE CONFIGURATION** command includes information about the log file size, and the number of primary and secondary log files.

Depending on the largest size of the MobileFirst application that is deployed, you might need to increase the DB2 log space.

Procedure

Using the **DB2 update db cfg** command, increase the **LOGSECOND** parameter. Space is not allocated when the database is activated. Instead, the space is allocated only as needed.

Installing the IBM MobileFirst Platform Operational Analytics

The IBM MobileFirst Platform Operational Analytics is delivered as two separate WAR files. For convenience in deploying on WebSphere Application Server or WebSphere Application Server Liberty, the IBM MobileFirst Platform Operational Analytics is also delivered as an EAR file that contains the two WAR files.

When you develop within MobileFirst Platform Command Line Interface for iOS, the WAR files that contain the IBM MobileFirst Platform Operational Analytics are automatically deployed. The MobileFirst Server forwards data to the MobileFirst tools with no additional required configurations.

The analytics WAR and EAR files are included with the MobileFirst Server installation. For more information, see “Distribution structure of MobileFirst Server” on page 6-39.

The following sections describe the required steps for successfully deploying the WAR file to the application server.

When you deploy the WAR file, the analytics console is available at:

```
http://<hostname>:<port>/<context-root>/console
```

Example:

```
http://localhost:9080/analytics/console
```

Installing IBM MobileFirst Platform Operational Analytics for WebSphere Application Server Liberty

You can install the IBM MobileFirst Platform Operational Analytics for WebSphere Application Server Liberty.

About this task

The following steps describe how to install and run the Analytics EAR file on WebSphere Application Server Liberty.

The IBM MobileFirst Platform Operational Analytics is protected with role-based security, so you must bind the security roles to the application to be able to access the console.

Procedure

1. Add the Analytics EAR file to the apps folder of your WebSphere Application Server Liberty application server.
2. Modify the server.xml file to set the class loading delegation and bind the security roles.

```
<basicRegistry id="worklight" realm="worklightRealm">
  <user name="demo" password="demo"/>
  <user name="monitor" password="demo"/>
  <user name="deployer" password="demo"/>
  <user name="operator" password="demo"/>
  <user name="admin" password="admin"/>
</basicRegistry>
```

```
<application location="analytics.ear"
  name="analytics-ear"
  type="ear">
  <application-bnd>
    <security-role name="worklightadmin">
      <user name="admin"/>
    </security-role>
    <security-role name="worklightdeployer">
      <user name="deployer"/>
    </security-role>
    <security-role name="worklightmonitor">
      <user name="monitor"/>
    </security-role>
    <security-role name="worklightoperator">
      <user name="operator"/>
    </security-role>
  </application-bnd>
</application>
```

3. Add the following features to the WebSphere Application Server Liberty server in the feature manager.

```
<feature>jsp-2.2</feature>
<feature>jndi-1.0</feature>
<feature>appSecurity-1.0</feature>
```

4. Start the application server and view the console in the browser.

<http://localhost:9080/analytics/console>

Results

The analytics console is deployed and can now be viewed in the browser.

Installing IBM MobileFirst Platform Operational Analytics for WebSphere Application Server

You can install the IBM MobileFirst Platform Operational Analytics for WebSphere Application Server.

About this task

The following steps describe how to install and run the Analytics EAR file on WebSphere Application Server. If you are installing the individual WAR files on WebSphere Application Server, follow only steps 2 - 6 on the analytics-service WAR file after you deploy both WAR files. The class loading order must not be altered on the analytics-ui WAR file.

Procedure

1. Deploy the EAR file to the application server, but do not start it. For more information about the analytics files, see “Distribution structure of MobileFirst Server” on page 6-39. For more information about how to install an EAR file on WebSphere Application Server, see Installing enterprise application files with the console.
2. Select the **IMF Operational Analytics** application from the **Enterprise Applications** list.

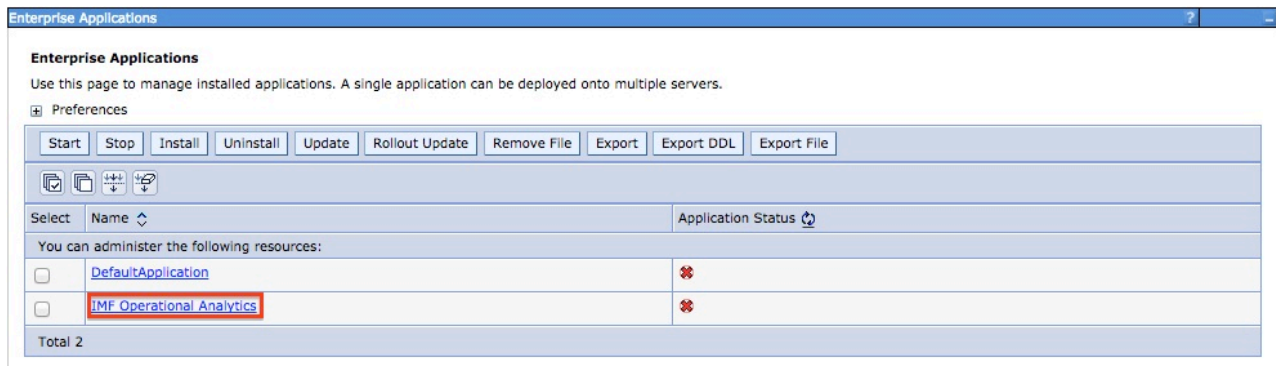

3. Click **Class loading and update detection**.

Enterprise Applications

Enterprise Applications > IMF Operational Analytics

Use this page to configure an enterprise application. Click the links to access pages for further configuring of the application or its modules.

Configuration

General Properties

* Name
IMF Operational Analytics

Application reference validation
Issue warnings

Detail Properties

- [Target specific application status](#)
- [Startup behavior](#)
- [Application binaries](#)
- [Class loading and update detection](#)
- [Request dispatcher properties](#)
- [Security role to user/group mapping](#)
- [JASPI provider](#)
- [Custom properties](#)
- [View Deployment Descriptor](#)
- [Last participant support extension](#)

References

- [Shared library references](#)
- [Shared library relationships](#)

Modules

- [Manage Modules](#)
- [Metadata for modules](#)
- [Display module build Ids](#)

Web Module Properties

- [Session management](#)
- [Context Root For Web Modules](#)
- [Environment entries for Web modules](#)
- [Initialize parameters for servlets](#)
- [JSP and JSF options](#)
- [Virtual hosts](#)

Enterprise Java Bean Properties

- [Default messaging provider references](#)

Client Module Properties

- [Client module deployment mode](#)

Database Profiles

- [SQLJ profiles and pureQuery bind files](#)

Apply OK Reset Cancel

4. Set the class loading order to **parent last**.

General Properties

Class reloading options

Override class reloading settings for Web and EJB modules

Polling interval for updated files
 Seconds

Class loader order

Classes loaded with parent class loader first

Classes loaded with local class loader first (parent last)

WAR class loader policy

Class loader for each WAR file in application

Single class loader for application

Apply

OK

Reset

Cancel

5. Click **Security role to user/group mapping** to map the admin user.

Enterprise Applications

[Enterprise Applications](#) > [IMF Operational Analytics](#) > [Security role to user/group mapping](#)

Security role to user/group mapping

Each role that is defined in the application or module must map to a user or group from the domain user registry. accessIds: The accessIds are required only when using cross realm communication in a multi domain scenario. For all other scenarios the accessId will be determined during the application start based on the user or group name. The accessIds represent the user and group information that is used for Java Platform, Enterprise Edition authorization when using the WebSphere default authorization engine. The format for the accessIds is user:realm/uniqueUserID, group:realm/uniqueGroupID. Entering wrong information in these fields will cause authorization to fail. AllAuthenticatedInTrustedRealms: This indicates that any valid user in the trusted realms be given the access. AllAuthenticated: This indicates that any valid user in the current realm be given the access.

Map Users... Map Groups... Map Special Subjects ▾

Select	Role	Special subjects	Mapped users	Mapped groups
<input type="checkbox"/>	worklightadmin	None	wasadmin	
<input type="checkbox"/>	worklightdeployer	None		
<input type="checkbox"/>	worklightmonitor	None		
<input type="checkbox"/>	worklightoperator	None		

OK Cancel

6. Click **Manage Modules**.

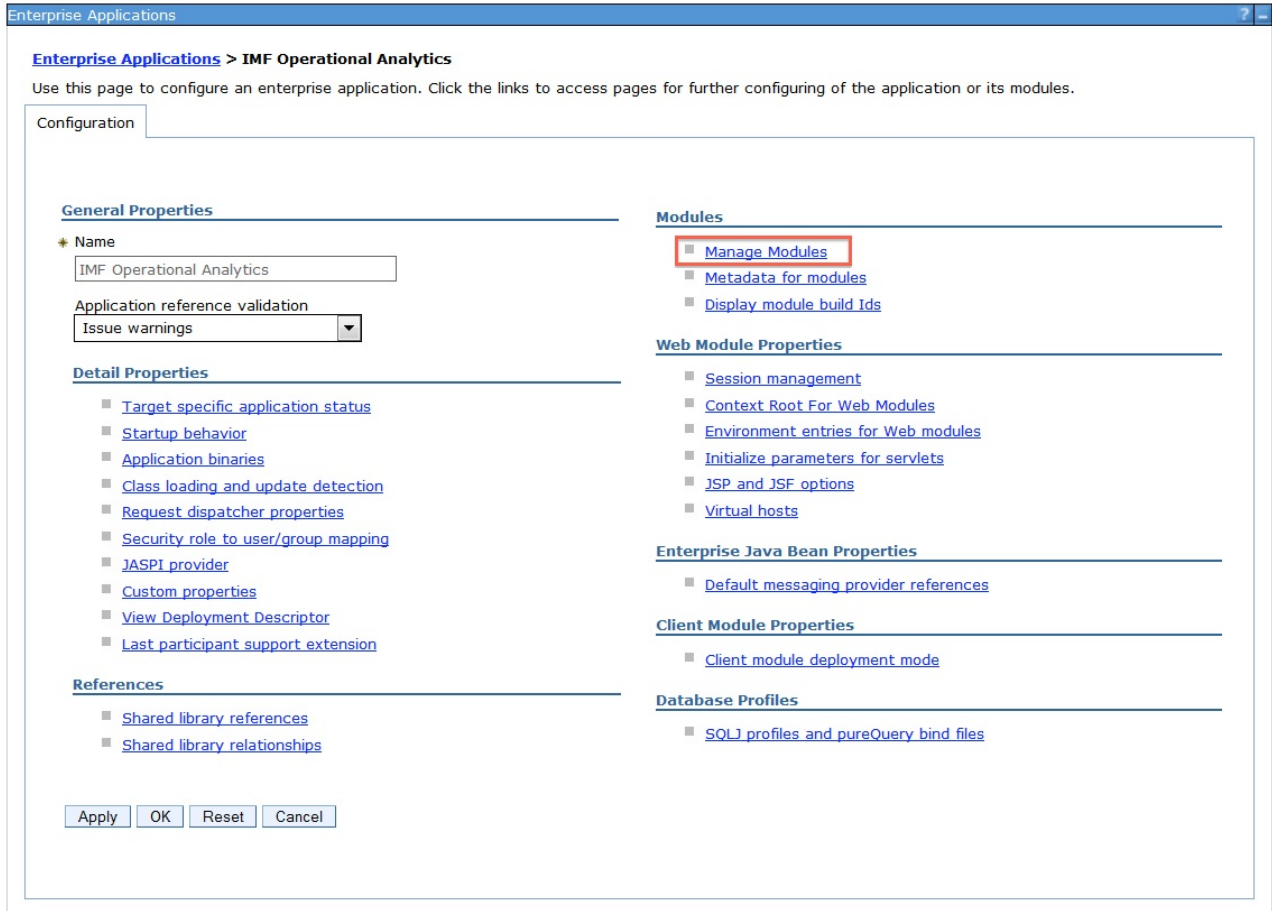

7. Select the **worklight-analytics-service** module and change the class loading order to **parent last**.

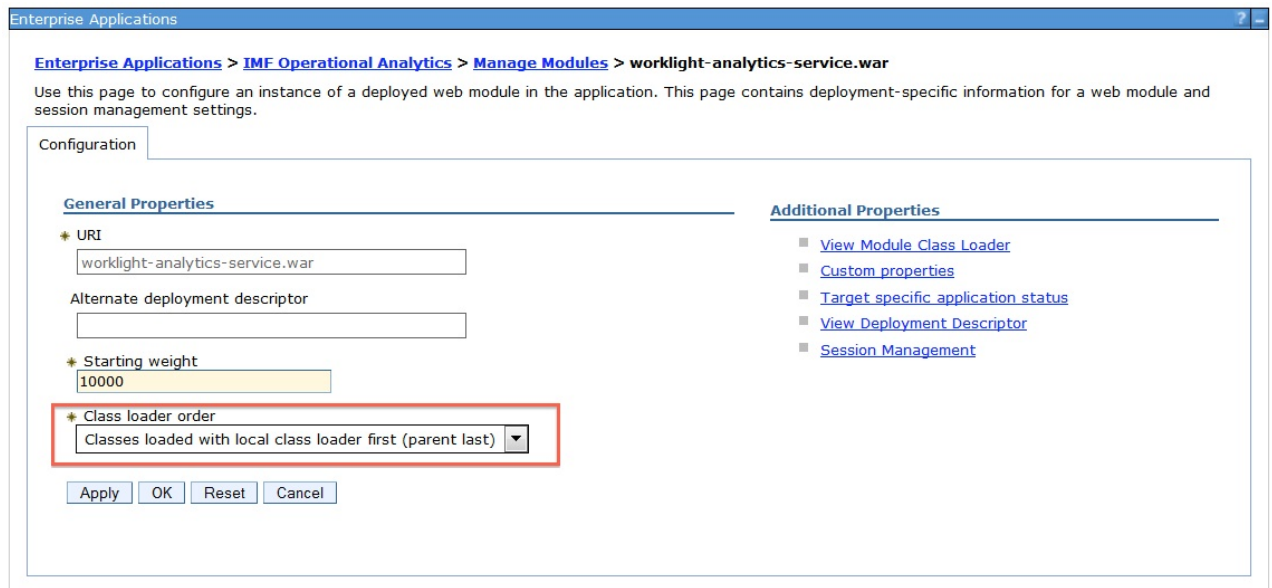

8. Start the **IMF Operational Analytics** application and go to the link in the browser.

`http://<hostname>:<port>/<context-root>/data`

Results

The analytics EAR file is now ready to accept incoming analytics data.

IBM MobileFirst Platform Operational Analytics installation for Tomcat

The individual WAR files that come packaged within the Analytics EAR file are also provided when IBM MobileFirst Platform Foundation for iOS is installed.

`analytics-ui.war`
`analytics-service.war`

For more information, see “Distribution structure of MobileFirst Server” on page 6-39.

Follow the normal procedures for deploying WAR files. No special configurations need to be made for Tomcat.

Configuring the MobileFirst Server for the IBM MobileFirst Platform Operational Analytics

You must configure the MobileFirst Server for the IBM MobileFirst Platform Operational Analytics.

About this task

The following steps describe how to configure the MobileFirst Server for the IBM MobileFirst Platform Operational Analytics.

Procedure

1. In the `worklight.properties` file, set the `wl.analytics.url` property to point to the deployed WAR file.

`wl.analytics.url=http://<hostname>:<port>/analytics-service/data`

For example, if the Liberty server is at `host.ibm.com` on port 8080, then the `wl.analytics.url` property is as follows:

`wl.analytics.url=http://host.ibm.com:8080/analytics-service/data`

2. In the `worklight.properties` file, set the `wl.analytics.username` and the `wl.analytics.password` properties.

3. Optional: If you want to access the Analytics console from the MobileFirst Operations Console, set the `wl.analytics.console.url` property in the `worklight.properties` file.

`wl.analytics.console.url=http://<hostname>:<port>/analytics/console`

For example, if the Liberty server is at `host.ibm.com` on port 8080, then the `wl.analytics.console.url` property is as follows:

`wl.analytics.console.url=http://host.ibm.com:8080/analytics/console`

Results

The MobileFirst Server now forwards data to the IBM MobileFirst Platform Operational Analytics.

Note: All properties in the `worklight.properties` file can also be set by using JNDI. For more information about JNDI settings, see “Configuration of MobileFirst applications on the server” on page 10-48.

Installing the MobileFirst Data Proxy

You install the MobileFirst Data Proxy to serve as a proxy between your MobileFirst Server and your Cloudant database.

Planning the installation of MobileFirst Data Proxy

Before you install the MobileFirst Data Proxy, you must plan your installations and verify the prerequisites for your system.

Installation overview of the MobileFirst Data Proxy

With the MobileFirst Data Proxy, the data from your mobile applications can be saved on the server side.

To develop applications with this feature, use the MobileFirst Data Proxy SDK that is documented at “Storing mobile data in Cloudant” on page 8-186.

The MobileFirst Data Proxy service requires an installed IBM MobileFirst Platform runtime, and access to a Cloudant database.

IBM MobileFirst Platform Foundation for iOS bundles a limited-use Virtual Server entitlement to IBM MobileFirst Platform Cloudant Data Layer Local Edition. This Virtual Server, or node, provides development and test with full API support, and tools. This node can be used for production with appropriate planning for availability, performance, and backup. For more information about the use limitation, see the IBM MobileFirst Platform Foundation for iOS license. By purchasing additional entitlements to IBM MobileFirst Platform Cloudant Data Layer Local Edition, customers can cluster multiple nodes together and gain horizontal and geographic scalability, fault tolerance, and continuous availability. You might want to deploy in a clustered topology for applications that require the availability, elasticity, and reach of possibly massive amounts of mobile data and devices. It is best suited for applications that require an operational data store to handle a massively concurrent mix of low-latency reads and writes.

Attention: You can install only one instance of an MobileFirst Data Proxy in an application server. That instance can authenticate incoming requests with only one MobileFirst project runtime.

Installation prerequisites for the MobileFirst Data Proxy

Review the system requirements, and perform the required installations of MobileFirst Server and the Cloudant database before installing the MobileFirst Data Proxy. Some restrictions apply about the type of application server that you can use.

For more information about the supported hardware and pre-required software, see “System requirements” on page 2-7.

Before installing the MobileFirst Data Proxy, you must perform the following actions:

- Install an instance of MobileFirst Server. For more information about the installation process, see “Installing MobileFirst Server” on page 6-2.

- Deploy a project WAR file. For more information about the deployment process, see “Deploying the project WAR file” on page 10-5.
- Install IBM MobileFirst Platform Cloudant Data Layer Local Edition, or get access to the Cloudant database. For more information about the installation process, see the IBM MobileFirst Platform Cloudant Data Layer Local Edition user documentation.

Application server restrictions

You can install the MobileFirst Data Proxy on the following application servers:

- WebSphere Application Server Liberty profile V8.5.5.0 and later
- WebSphere Application Server full profile
- WebSphere Application Server Network Deployment

You cannot install MobileFirst Data Proxy on the following application server:

- Apache Tomcat
- WebSphere Application Server Liberty profile V8.5.0.x

File System prerequisites for MobileFirst Data Proxy

Review the file system privileges and the specific rights for WebSphere Application Server and WebSphere Application Server Network Deployment that you must have before you install the MobileFirst Data Proxy.

The file system prerequisites are the same as for installing the MobileFirst Server, which are described in “File system prerequisites” on page 6-5.

In addition, to install on WebSphere Application Server or WebSphere Application Server Network Deployment, you must have the right to create files in the WebSphere Application Server installation directory: `<was_install_dir>/lib/ext`.

For WebSphere Application Server Network Deployment, you must do this operation on every node of the WebSphere Application Server Network Deployment cell, even if they do not run the MobileFirst Data Proxy service. This is required to install a Trust Association Interceptor (TAI) that is declared at the cell level.

Installing and configuring the MobileFirst Data Proxy

You can choose to install the MobileFirst Data Proxy with Ant tasks, or manually. For more information about the procedures to follow for each case, see the appropriate topics in this section.

Installing the MobileFirst Data Proxy with Ant tasks

Learn about the Ant tasks that you can use to install the MobileFirst Data Proxy.

Before you begin

Make sure that Cloudant is installed and running. It can be on the same computer, or a different computer. The Ant task verifies the connectivity to Cloudant before proceeding with the installation.

To deactivate that verification, see “Ant tasks for installation of MobileFirst Data Proxy” on page 14-27.

You must install the MobileFirst Server, as described in “Installing MobileFirst Server” on page 6-2, and deploy a project WAR file, as described in “Deploying the project WAR file” on page 10-5.

You must have the URL of the deployed project WAR file to complete the installation of the MobileFirst Data Proxy. If you want to start the Ant task from a computer on which MobileFirst Server is not installed, you must copy the following files on that computer:

- *mf_server_install_dir*/WorklightServer/worklight-ant-deployer.jar
- *mf_server_install_dir*/Datastore/imf-data-proxy.jar
- *mf_server_install_dir*/WorklightServer/external-server-libraries/*

About this task

Procedure

1. On WebSphere Application Server Network Deployment, you must install the Trust Association Interceptor (TAI) manually on every node of the WebSphere Application Server Network Deployment cell. For more information on the installation instructions, see “Installing the MobileFirst OAuth Trust Association Interceptor (TAI)” on page 6-157.
2. Review the sample configuration files in “Sample configuration files” on page 14-35, and copy the Ant file that corresponds to your application server.

The following list of sample configuration files are in *product_install_dir*/Datastore/configuration-samples:

- *configure-liberty.xml*: to install on a Liberty server.
 - *configure-was.xml*: to install on a WebSphere Application Server stand-alone server.
 - *configure-wasnd-cluster.xml*: to install on WebSphere Application Server Network Deployment, on a cluster.
 - *configure-wasnd-server.xml*: to install on WebSphere Application Server Network Deployment, on a managed server.
3. Edit the Ant file and replace the placeholder values for the properties at the top of the file.
 4. Run the following command to install the MobileFirst Data Proxy:

```
ant -f configure-<appserver>.xml install
```

You can find the Ant command in *mf_server_install_dir*/shortcuts.

Note: With these Ant files, you can also:

- Uninstall a MobileFirst Data Proxy, with the target `uninstall`.
- Update a MobileFirst Data Proxy with the target `minimal-update` to apply a fix pack.

Manually installing the MobileFirst Data Proxy

You can install the MobileFirst Data Proxy manually, and configure your application server accordingly.

Configuring WebSphere Application Server Liberty profile for MobileFirst Data Proxy manually:

To configure WebSphere Application Server Liberty profile for MobileFirst Data Proxy manually, you must modify the `server.xml` file. You must also install a feature in the `usr/extension` directory that is shared between servers, and add an

environment variable in a `server.env` file that specifies the MobileFirst runtime, which provides the authentication service for the MobileFirst Data Proxy.

Procedure

1. Install the OAuthTai feature that implements the Trust Association Interceptor (TAI) for IBM MobileFirst Platform Foundation for iOS.
 - a. Ensure that the Liberty `usr` directory (see note) contains a subdirectory `extension/lib`. If this subdirectory does not exist, you must create it.
 - b. Copy the file `product_install_dir/WorklightServer/external-server-libraries/com.ibm.worklight.oauth.tai_1.0.0.jar` to `usr/extension/lib/`.
 - c. Copy the file `product_install_dir/WorklightServer/external-server-libraries/OAuthTai-1.0.mf` to `usr/extension/lib/`.

Note:

Where `usr` is the `usr` directory for WebSphere Application Server Liberty profile. For more information, see the Directory locations and properties page in the WebSphere Application Server Liberty Core user documentation. It is typically in `liberty_install_dir/usr` but its location can be redefined with a variable in `liberty_install_dir/etc/server.env`.

`product_install_dir` is the installation directory for MobileFirst Server.

2. Install the MobileFirst Data Proxy WAR file.
 - a. Copy the following WAR file to the apps directory of the Liberty server: `product_install_dir/Datastore/imf-data-proxy.war`.

Note: the apps directory is in the same directory as the `server.xml` file.

3. Edit the `server.xml` file.
 - a. Ensure that the `<featureManager>` element contains at least the following `<feature>` elements:

```
<feature>jaxrs-1.1</feature>
<feature>restConnector-1.0</feature>
<feature>jndi-1.0</feature>
<feature>appSecurity-2.0</feature>
<feature>usr:OAuthTai-1.0</feature>
```
 - b. Modify the web container definition with the following values:

```
<webContainer invokeFlushAfterService="false" deferServletLoad="false"/>
```
 - c. Configure the Trust Association Interceptor:

```
<usr_OAuthTAI id="myOAuthTAI" cacheSize="1000">
  <securityConstraint securedURLs="/datastore/*"
    scope="cloudant"
    httpMethods="All"/>
</usr_OAuthTAI>
```
 - d. If your server is not configured with a **basicRegistry** or an **ldapRegistry**, add an empty **basicRegistry**:

```
<basicRegistry> </basicRegistry>
```

Note: There can be only one **basicRegistry** per `server.xml` file. You must perform this step only if there is no other **basicRegistry** or **ldapRegistry** defined in your server.

4. Declare the MobileFirst Data Proxy application:

```
<application id="datastore" name="datastore" location="imf-data-proxy.war" type="war">
  <application-bnd>
    <security-role name="TAIUserRole">
```

```

        <special-subject type="ALL_AUTHENTICATED_USERS" />
    </security-role>
</application-bnd>
<classloader delegation="parentLast">
    <commonLibrary id="worklightlib_datastore">
        <fileset dir="{wlp.install.dir}/lib" includes="com.ibm.ws.crypto.passwordutil_*.jar"/>
    </commonLibrary>
</classloader>
</application>

```

```

<!-- Declare the JNDI properties for the MobileFirst Data Proxy. -->
<jndiEntry jndiName="datastore/CloudantProxyDbAccount" value="'hostname'"/>
<jndiEntry jndiName="datastore/CloudantProtocol" value="'http'"/>
<jndiEntry jndiName="datastore/CloudantPort" value="'80'"/>
<jndiEntry jndiName="datastore/CloudantProxyDbAccountUser" value="'cloudantuser'"/>
<jndiEntry jndiName="datastore/CloudantProxyDbAccountPassword" value="'cloudantpassword'"/>

```

Where:

- datastore is the context root for the application. datastore is used in the application name and ID, and as a prefix for the jndiName values, and in the securityConstraint of the MobileFirst Data Proxy.
 - The values for the following parameters correspond to:
 - CloudantProxyDbAccount is the Cloudant database account or host name of the Cloudant Local server.
 - CloudantProtocol is the protocol to connect to the Cloudant HAProxy (http or https).
 - CloudantPort is the port number to connect to the Cloudant HAProxy.
 - CloudantProxyDbAccountUser is the login of the Cloudant user.
 - CloudantProxyDbAccountPassword is the password of the Cloudant user. This password can be encrypted with the securityUtility feature of WebSphere Application Server Liberty profile.
4. Edit or create a file server.env in the Liberty server directory, and add this content:

```
publicKeyServerUrl=http://hostname:9080/worklight
```

Where the value of the **publicKeyServerUrl** environment variable is the URL to the MobileFirst runtime that runs the mobile apps which use the MobileFirst Data Proxy.

Configuring WebSphere Application Server full profile and WebSphere Application Server Network Deployment for MobileFirst Data Proxy manually:

To configure WebSphere Application Server full profile or WebSphere Application Server Network Deployment for MobileFirst Data Proxy manually, you must follow these steps.

About this task

First, you must select a context root for the MobileFirst Data Proxy application. In the following topics, the context root is referred to as /datastore.

Then you must install the MobileFirst OAuth Trust Association Interceptor (TAI). To install this component, you have two choices, which are described in the section “Installing the MobileFirst OAuth Trust Association Interceptor (TAI)” on page 6-157.

Finally, you must install the MobileFirst Data Proxy application, as described in the section “Installing the MobileFirst Data Proxy application” on page 6-159.

Installing the MobileFirst OAuth Trust Association Interceptor (TAI):

It is mandatory to install the MobileFirst OAuth Trust Association Interceptor to run the MobileFirst Data Proxy. You can either install the TAI on the default security domain of a cell, or on a specific security domain.

About this task

There are two options to install MobileFirst OAuth Trust Association Interceptor. Review the following topics to learn about the procedures for each option.

Installing the MobileFirst OAuth Trust Association Interceptor on the default security domain:

You can choose to install the TAI on the default security domain of a cell. This is convenient for a standalone web server, but on WebSphere Application Server Network Deployment, this means that the TAI is active on all servers and clusters of the cell. It must also be installed, and maintained for fix packs, on all nodes of the cell.

Procedure

1. Copy the file `product_install_dir/WorklightServer/external-server-libraries/com.ibm.worklight.oauth.tai_1.0.0.jar` to `${WAS_INSTALL_ROOT}/lib/ext`.

Note: On WebSphere Application Server Network Deployment, you must perform this operation on every node of the WebSphere Application Server cell.

2. Create a configuration file with this content:

```
<?xml version="1.0" encoding="UTF-8"?>

<OAuthTAI >
  <!-- Security constraint. -->
  <securityConstraint securedURLs="/datastore/*" scope="cloudant" httpMethods="A11"/>
</OAuthTAI>
```

Where `datastore` is the context root of the application, as defined in the section *About this task* of the topic “Configuring WebSphere Application Server full profile and WebSphere Application Server Network Deployment for MobileFirst Data Proxy manually” on page 6-156.

3. Copy this configuration file in the `config/cells/<cellName>/com.worklight.oauth.tai.OAuthTAI.conf` directory of the WebSphere Application Server profile, or the WebSphere Application Server Deployment Manager profile for WebSphere Application Server Network Deployment (this directory is synchronized with the nodes). For example:

```
${USER_INSTALL_ROOT}/config/cells/<cellName>/com.worklight.oauth.tai.OAuthTAI.conf
```

Where `USER_INSTALL_ROOT` is the profile directory, and `<cellName>` must be replaced by the actual name of the WebSphere Application Server cell. The directory should already exist.

4. Open the WebSphere Application Server Console.
5. Go to **Security > Global Security > Authentication**, and select **Enable LTPA**.
6. Go to **Security > Global Security > Web and SIP security > Trust association**.
 - a. Enable trust association.
 - b. In the **Interceptors** tab, create a new interceptor by clicking **New**.
 - c. Set the following settings for this interceptor:
 - Interceptor class name: `com.worklight.oauth.tai.OAuthTAI`.

- Custom properties:
 - Name: configFileLocation
 - Value: `${USER_INSTALL_ROOT}/config/cells/<cellName>/com.worklight.oauth.tai.OAuthTAI.conf`

Note: Keep `${USER_INSTALL_ROOT}` as a variable, especially if you install on WebSphere Application Server Network Deployment. The `${USER_INSTALL_ROOT}` variable is defined in WebSphere Application Server.

You must replace `<cellName>` by the actual cell name.

7. From the WebSphere Application Server console, define an environment variable for each server of the cell that points to the MobileFirst project runtime which provides the authentication service.
 - a. From the WebSphere Application Server Console, go to **Servers > Server Types > WebSphere application servers > your_server > Java and Process Management > Process Definition > Environment Entries > New**.
 - b. Create an environment with the following settings:

```
publicKeyServerUrl=url_to_mfp_server
```

Where `url_to_mfp_server` is the URL to the MobileFirst project runtime that provides the public key for decrypting MFP OAuth tokens. For example, it can be `http://localhost:9080/worklight` if a project runtime is installed on the same server, the port is 9080, and the context root is `/worklight`.

The TAI will not be active before you restart the application server. For WebSphere Application Server Network Deployment, the nodes must also be synchronized.

What to do next

Follow the steps in “Installing the MobileFirst Data Proxy application” on page 6-159

Installing the MobileFirst OAuth Trust Association Interceptor on a specific security domain:

You can choose to install the TAI on a specific security domain. In this case, only servers or clusters that use that security domain can run the MobileFirst Data Proxy.

Procedure

1. Open the WebSphere Application Server Console.
 - a. Create a security domain by clicking **Security > Global Security > Security domains > New**.
 - b. Configure the security domain as follows:
 - Name: `MobileFirstOAuthDomain`
 - Description: `Security Domain with MobileFirst Platform Foundation TAI Enabled`
 - c. Click the security domain that you created.
 - d. Go to **Security Attributes > Trust Association**, and select **Enable Trust Association**.
 - e. Go to **Security Attributes > Trust Association > Interceptors** and set the properties as follows:
 - Interceptor class name: `com.worklight.oauth.tai.OAuthTAI`.
 - Custom properties:

- Name: configFileLocation
- Value: `${USER_INSTALL_ROOT}/config/cells/<cellName>/com.worklight.oauth.tai.OAuthTAI.conf`

Note: Keep `${USER_INSTALL_ROOT}` as a variable, especially if you install on WebSphere Application Server Network Deployment. The `${USER_INSTALL_ROOT}` variable is defined in WebSphere Application Server.

You must replace `<cellName>` by the actual cell name.

- f. In **Assigned Scopes**, assign the security domain to the server or cluster that runs the MobileFirst Data Proxy.
2. Copy the file `product_install_dir/WorklightServer/external-server-libraries/com.ibm.worklight.oauth.tai_1.0.0.jar` to `${WAS_INSTALL_ROOT}/lib/ext`.

Note: You must perform this operation on every node that hosts a server with the MobileFirstOAuthDomain security domain.

3. Create the TAI configuration file and copy it in the config directory of the WebSphere Application Server profile. For more information, see steps 1 on page 6-157 and 2 on page 6-157 of “Installing the MobileFirst OAuth Trust Association Interceptor on the default security domain” on page 6-157.
4. From the WebSphere Application Server console, define an environment variable for each server with the MobileFirstOAuthDomain security domain.
 - a. Go to **Servers > Server Types > WebSphere application servers > your_server > Java and Process Management > Process Definition > Environment Entries > New**.

- b. Create an environment with the following settings:

`publicKeyServerUrl=url_to_mfp_server`

Where `url_to_mfp_server` is the URL to the MobileFirst project runtime that provides the public key for decrypting MFP OAuth tokens. For example, it can be `http://localhost:9080/worklight` if a project runtime is installed on the same server, the port is 9080, and the context root is `/worklight`.

The TAI will not be active before you restart the application server. For WebSphere Application Server Network Deployment, the nodes must also be synchronized.

What to do next

Follow the steps in “Installing the MobileFirst Data Proxy application”

Installing the MobileFirst Data Proxy application:

When the previous configuration steps of your application server are done, you must install, then start the MobileFirst Data Proxy application.

Procedure

1. Enable application security.
 - a. Click **Security > Global Security**.
 - b. Ensure that **Enable administrative security** is selected. Application security can be enabled only if administrative security is enabled.
 - c. Click **OK**.

- d. Save the changes.
For more information, see *Enabling security in WebSphere Application Server user documentation*.
2. Review the server class loader policy:
 - a. Click **Servers > Server Types > WebSphere application servers**.
 - b. Select the server that is used for the MobileFirst Data Proxy.
 - If the class loader policy is set to **Multiple**, do nothing.
 - If the class loader policy is set to **Single** and the class loading mode is set to **parent-last**, do nothing.
 - If the class loader policy is set to **Single** and the class loading mode is set to **parent-first**, change the class loader policy to **Multiple**, and set the class loader order of all applications other than MobileFirst applications to **parent-first**.
3. Install the Administration Services WAR file:
 - a. Depending on your version of WebSphere Application Server, click one of the following options:
 - **Applications > New > New Enterprise Application**
 - **Applications > New Application > New Enterprise Application**
 - b. Go to the MobileFirst Server installation directory: `product_install_dir/` `Datastore`.
 - c. Select `imf-data-proxy.war`, and click **Next**.
 - d. On the **How do you want to install the application?** page, click **Detailed**, and then click **Next**.
 - e. On the **Application Security Warnings** page, click **Continue**.
 - f. Click **Next** until you reach the **Map context roots for web modules** page.
 - g. In the **Context Root** field, type `/datastore`. This is defined in the section *About this task* of the topic “Configuring WebSphere Application Server full profile and WebSphere Application Server Network Deployment for MobileFirst Data Proxy manually” on page 6-156
 - h. Click **Next**.
 - i. In **Map environment entries for web modules**, enter the following values:
 - for the `CloudantProxyDbAccount` entry, enter the host name of the Cloudant database.
 - for the `CloudantProtocol` entry, enter the protocol used to connect to Cloudant. The possible values are `http` or `https`.
 - for the `CloudantPort` entry, enter the port of the Cloudant database, which is by default 80 for `http` and 443 for `https`.
 - for the `CloudantProxyDbAccountUser` entry, enter the Cloudant user that can log to Cloudant.
 - for the `CloudantProxyDbAccountPassword` entry, enter the Cloudant user's password.
 - j. Click **Next**.
 - k. In **Map security roles to users or groups**, select **TAIUserRole**.
 - l. Select **Map Special Subjects > All Authenticated Users in Application's Realm**.
 - m. Click **Next** until you reach the last step, and click **Finish**.
 - n. Click **Save**.

4. Configure the class loader policies for the Administration Services and then start the application:
 - a. Click the **Manage Applications** link, or click **Applications > Applications Types > WebSphere enterprise applications**.
 - b. From the list of applications, click `imf-data-proxy_war`.
 - c. In the **Detail Properties** section, click the **Class loading and update detection** link.
 - d. In the **Class loader order** pane, click **Classes loaded with local class loader first (parent last)**.
 - e. Click **OK**.
 - f. In the **Detail Properties** section, click the **Startup behavior** link.
 - g. In **Startup Order**, enter 1, and click **OK**.
 - h. In the **Modules** section, click **Manage Modules**.
 - i. From the list of modules, click the `imfdata` module.
 - j. In the **Class loader order** pane, click **Classes loaded with local class loader first (parent last)**.
 - k. Click **OK** twice.
 - l. Click **Save**.
 - m. Select `imf-data-proxy_war` and click **Start**.

Configuring the application server to access the Cloudant database through HTTPS

Whether you installed the MobileFirst Data Proxy manually or with Ant tasks, if you access the Cloudant database through HTTPS, and your application server is WebSphere Application Server full profile, you must configure your certificates. If your application server is WebSphere Application Server Liberty profile, and a self-signed certificate is used to access the Cloudant database, an extra configuration step is required.

Procedure

For WebSphere Application Server full profile, you must import the Cloudant signer certificate in the WebSphere Application Server truststore to access the Cloudant database through HTTPS. If you connect to Cloudant through the HTTPS protocol, follow steps 1 to 7.

1. Open the WebSphere Application Server console.
2. Go to **Security > SSL Certificates and Key Management**.
3. In **Related Items**, click **Key stores and certificates**.
4. Select `NodeDefaultTrustStore`.
5. Select **Additional Properties > Signer certificates**.
6. Click **Retrieve from port**.
 - a. Enter the Cloudant host name and the port, which is by default 443.
 - b. Select an alias, for example Cloudant trust store.
 - c. Click **Retrieve signer information**.
 - d. Click **OK**.
7. Click **Save**.

For WebSphere Application Server Liberty profile, if you access the Cloudant database through HTTPS with a self-signed certificate, you must import this certificate in the cacerts truststore of the JVM that is used by your Liberty server, which you find in: `JAVA_INSTALL_DIR\jre\lib\security\cacerts`.

8. Use the **keytool** command that is available in both IBM JRE and Oracle JRE, as of Java 6.
9. For more information, see the Keytool section of the IBM SDK, Java Technology Edition user documentation.

Note: The password to access this truststore is `changeit`.

Installing and configuring the Application Center

You install the Application Center as part of the MobileFirst Server installation.

The Application Center is part of MobileFirst Server. To install the Application Center, see the following topics. Optionally, you can install the database of your choice before you install MobileFirst Server with the Application Center.

When you install an IBM MobileFirst Platform Foundation for iOS edition through IBM Installation Manager, the Application Center is installed in the web application server that you designate. You have minimal additional configuration to do. For more information, see “Configuring the Application Center after installation” on page 6-188.

If you chose a manual setup in the installer, see the documentation of the server of your choice.

If you intend to install applications on iOS devices through the Application Center, you must first configure the Application Center server with SSL.

For a list of installed files and tools, see “Distribution structure of MobileFirst Server” on page 6-39.

Installing Application Center with IBM Installation Manager

With IBM Installation Manager, you can install Application Center, create its database, and deploy it on an Application Server.

Before you begin

Verify that the user who runs IBM Installation Manager has the privileges that are described in “File system prerequisites” on page 6-5.

Procedure

To install IBM Application Center with IBM Installation Manager, complete the followings steps.

1. Optional: You can manually create databases for Application Center, as described in “Optional creation of databases” on page 6-163. IBM Installation Manager can create the Application Center databases for you with default settings.
2. Run IBM Installation Manager, as described in “Running IBM Installation Manager” on page 6-29.
3. Select **Yes** to the question **Install IBM Application Center**.

Optional creation of databases

If you want to activate the option to install the Application Center when you run the MobileFirst Server installer, you need to have certain database access rights that entitle you to create the tables that are required by the Application Center.

If you have sufficient database administration credentials, and if you enter the administrator user name and password in the installer when prompted, the installer can create the databases for you. Otherwise, you need to ask your database administrator to create the required database for you. The database needs to be created before you start the MobileFirst Server installer.

The following topics describe the procedure for the supported database management systems.

Creating the DB2 database for Application Center:

During IBM MobileFirst Platform Foundation for iOS installation, the installer can create the Application Center database for you.

About this task

The installer can create the Application Center database for you if you enter the name and password of a user account on the database server that has the DB2 SYSADM or SYSCTRL privilege, and the account can be accessed through SSH. Otherwise, the database administrator can create the Application Center database for you. For more information, see the DB2 Solution user documentation.

When you manually create the database, you can replace the database name (here APPCNTR) and the password with a database name and password of your choosing.

Important: You can name your database and user differently, or set a different password, but ensure that you enter the appropriate database name, user name, and password correctly across the DB2 database setup. DB2 has a database name limit of 8 characters on all platforms, and has a user name and password length limit of 8 characters for UNIX and Linux systems, and 30 characters for Windows.

Procedure

1. Create a system user, for example, named `wluser` in a DB2 admin group such as `DB2USERS`, using the appropriate commands for your operating system. Give it a password, for example, `wluser`. If you want multiple instances of IBM MobileFirst Platform Server to connect to the same database, use a different user name for each connection. Each database user has a separate default schema. For more information about database users, see the DB2 documentation and the documentation for your operating system.
2. Open a DB2 command line processor, with a user that has `SYSADM` or `SYSCTRL` permissions:
 - On Windows systems, click **Start > IBM DB2 > Command Line Processor**
 - On Linux or UNIX systems, navigate to `~/sql1lib/bin` and enter `./db2`.
 - Enter database manager and SQL statements similar to the following example to create the Application Center database, replacing the user name `wluser` with your chosen user names:

```
CREATE DATABASE APPCNTR COLLATE USING SYSTEM PAGESIZE 32768
CONNECT TO APPCNTR
GRANT CONNECT ON DATABASE TO USER w1user
DISCONNECT APPCNTR
QUIT
```

3. The installer can create the database tables and objects for Application Center in a specific schema. This allows you to use the same database for Application Center and for a MobileFirst project. If the IMPLICIT_SCHEMA authority is granted to the user created in step 1 (the default in the database creation script in step 2), no further action is required. If the user does not have the IMPLICIT_SCHEMA authority, you need to create a SCHEMA for the Application Center database tables and objects.

Creating the MySQL database for Application Center:

During the MobileFirst installation, the installer can create the Application Center database for you.

About this task

The installer can create the database for you if you enter the name and password of the superuser account. For more information, see *Securing the Initial MySQL Accounts* on your MySQL database server. Your database administrator can also create the databases for you. When you manually create the database, you can replace the database name (here APPCNTR) and password with a database name and password of your choosing. Note that MySQL database names are case-sensitive on Unix.

Procedure

1. Start the MySQL command-line tool.
2. Enter the following commands:

```
CREATE DATABASE APPCNTR CHARACTER SET utf8 COLLATE utf8_general_ci;
GRANT ALL PRIVILEGES ON APPCNTR.* TO 'worklight'@'Worklight-host' IDENTIFIED BY 'password';
GRANT ALL PRIVILEGES ON APPCNTR.* TO 'worklight'@'localhost' IDENTIFIED BY 'password';
FLUSH PRIVILEGES;
```

Here, you need to replace *Worklight-host* with the name of the host on which IBM MobileFirst Platform Foundation for iOS runs.

Creating the Oracle database for Application Center:

During the installation, the installer can create the Application Center database, except for the Oracle 12c database type, or the user and schema inside an existing database for you.

About this task

The installer can create the database, except for the Oracle 12c database type, or the user and schema inside an existing database if you enter the name and password of the Oracle administrator on the database server, and the account can be accessed through SSH. Otherwise, the database administrator can create the database or user and schema for you. When you manually create the database or user, you can use database names, user names, and a password of your choosing. Note that lowercase characters in Oracle user names can lead to trouble.

Procedure

1. If you do not already have a database named ORCL, use the Oracle Database Configuration Assistant (DBCA) and follow the steps in the wizard to create a new general-purpose database named ORCL:
 - a. Use global database name `ORCL_your_domain`, and system identifier (SID) ORCL.
 - b. On the **Custom Scripts** tab of the step **Database Content**, do not run the SQL scripts, because you must first create a user account.
 - c. On the **Character Sets** tab of the step **Initialization Parameters**, select **Use Unicode (AL32UTF8) character set and UTF8 - Unicode 3.0 UTF-8 national character set**.
 - d. Complete the procedure, accepting the default values.
2. Create a database user either by using Oracle Database Control, or by using the Oracle SQLPlus command-line interpreter.
 - Using Oracle Database Control.
 - a. Connect as SYSDBA.
 - b. Go to the **Users** page: click **Server**, then **Users** in the **Security** section.
 - c. Create a user, for example, named APPCENTER. If you want multiple instances of IBM MobileFirst Platform Server to connect to the same general-purpose database you created in step 1, use a different user name for each connection. Each database user has a separate default schema.
 - d. Assign the following attributes:
 - Profile: **DEFAULT**
 - Authentication: **password**
 - Default tablespace: **USERS**
 - Temporary tablespace: **TEMP**
 - Status: **Unlocked**
 - Add system privilege: **CREATE SESSION**
 - Add system privilege: **CREATE SEQUENCE**
 - Add system privilege: **CREATE TABLE**
 - Add quota: **Unlimited for tablespace USERS**
 - Using the Oracle SQLPlus command-line interpreter.

The commands in the following example create a user named APPCENTER for the database:

```
CONNECT SYSTEM/<SYSTEM_password>@ORCL
CREATE USER APPCENTER IDENTIFIED BY password DEFAULT TABLESPACE USERS QUOTA UNLIMITED ON USERS;
GRANT CREATE SESSION, CREATE SEQUENCE, CREATE TABLE TO APPCENTER;
DISCONNECT;
```

Installing Application Center in WebSphere Application Server Network Deployment

To install Application Center in a set of WebSphere Application Server Network Deployment servers, run IBM Installation Manager on the machine where the deployment manager is running.

Procedure

1. When IBM Installation Manager prompts you to specify the database type, select any option other than **Apache Derby**. IBM MobileFirst Platform Foundation for iOS supports Apache Derby only in embedded mode, and this choice is incompatible with deployment through WebSphere Application Server Network Deployment.

2. In the installer panel in which you specify the WebSphere Application Server installation directory, select the deployment manager profile.
Attention: Do not select an application server profile and then a single managed server: doing so causes the deployment manager to overwrite the configuration of the server regardless of whether you install on the machine on which the deployment manager is running or on a different machine.
3. Select the required scope depending on where you want Application Center to be installed. The following table lists the available scopes:

Table 6-50. Selecting the required scope.

Scope	Explanation
Cell	Installs Application Center in all application servers of the cell.
Cluster	Installs Application Center in all application servers of the specified cluster.
Node (excluding clusters)	Installs Application Center in all application servers of the specified node that are not in a cluster.
Server	Installs Application Center in the specified server, which is not in a cluster.

4. Restart the target servers by following the procedure in “Completing the installation.”

Results

The installation has no effect outside the set of servers in the specified scope. The JDBC providers and JDBC data sources are defined with the specified scope. The entities that have a cell-wide scope (the applications and, for DB2, the authentication alias) have a suffix in their name that makes them unique. So, you can install Application Center in different configurations or even different versions of Application Center, in different clusters of the same cell.

Note: Because the JDBC driver is installed only in the specified set of application servers, the **Test connection** button for the JDBC data sources in the WebSphere Application Server administration console of the deployment manager might not work.

What to do next

You need to complete the following additional configuration:

- If you use a front-end HTTP server, you need to configure the public URL

Completing the installation

When installation is complete, you must restart the web application server in certain cases.

You must restart the web application server in the following circumstances:

- When you are using WebSphere Application Server with DB2 as database type.
- When you are using WebSphere Application Server and have opened it without the application security enabled before you installed IBM MobileFirst Platform Application Center or MobileFirst Server.

The MobileFirst installer must activate the application security of WebSphere Application Server (if not active yet) to install Application Center. Then, for this activation to take place, restart the application server after the installation of MobileFirst Server completed.

- When you are using WebSphere Application Server Liberty or Apache Tomcat.
- After you upgraded from a previous version of MobileFirst Server.

If you are using WebSphere Application Server Network Deployment and chose an installation through the deployment manager:

- You must restart the servers that were running during the installation and on which the MobileFirst Server web applications are installed.

To restart these servers with the deployment manager console, select **Applications > Application Types > WebSphere enterprise applications > IBM_Application_Center_Services > Target specific application status.**

- You do not have to restart the deployment manager or the node agents.

Note: Only the Application Center is installed in the application server. A MobileFirst Operations Console is not installed by default. To install a MobileFirst Operations Console, you need to follow the steps in “Deploying MobileFirst projects” on page 10-1.

Default logins and passwords created by IBM Installation Manager for the Application Center

IBM Installation Manager creates the logins by default for the Application Center, according to your application server. You can use these logins to test the Application Center.

WebSphere Application Server full profile

The login `appcenteradmin` is created with a password that is generated and displayed during the installation.

All users authenticated in the application realm are also authorized to access the `appcenteradmin` role. This is not meant for a production environment, especially if WebSphere Application Server is configured with a single security domain.

For more information about how to modify these logins, see “Configuring WebSphere Application Server full profile” on page 6-189.

WebSphere Application Server Liberty profile

- The login `demo` is created in the `basicRegistry` with the password `demo`.
- The login `appcenteradmin` is created in the `basicRegistry` with the password `admin`.

For more information about how to modify these logins, see “Configuring WebSphere Application Server Liberty profile” on page 6-191.

Apache Tomcat

- The login `demo` is created with the password `demo`.
- The login `guest` is created with the password `guest`.
- The login `appcenteradmin` is created with the password `admin`.

For more information about how to modify these logins, see “Configuring Apache Tomcat” on page 6-192.

Manual installation of Application Center

A reconfiguration is necessary for the MobileFirst Server to use a database or schema that is different from the one that was specified during its installation. This reconfiguration depends on the type of database and on the kind of application server.

Restriction: Whether you install Application Center with IBM Installation Manager as part of the MobileFirst Server installation or manually, remember that "rolling updates" of Application Center are not supported. That is, you cannot install two versions of Application Center (for example, V5.0.6 and V6.0.0) that operate on the same database. See "In-place upgrade or rolling upgrade to MobileFirst Server V7.0.0" on page 7-16.

Configuring the DB2 database manually for IBM MobileFirst Platform Application Center

You configure the DB2 database manually by creating the database, creating the database tables, and then configuring the relevant application server to use this database setup.

Procedure

1. Create the database. This step is described in "Creating the DB2 database for Application Center" on page 6-163.
2. Create the tables in the database. This step is described in "Setting up your DB2 database manually for Application Center."
3. Perform the application server-specific setup as the following list shows.

Setting up your DB2 database manually for Application Center:

You can set up your DB2 database for Application Center manually.

About this task

Set up your DB2 database for Application Center by creating the database schema.

Procedure

1. Create a system user, **worklight**, in a DB2 admin group such as **DB2USERS**, by using the appropriate commands for your operating system. Give it the password **worklight**. For more information, see the DB2 documentation and the documentation for your operating system.

Important: You can name your user differently, or set a different password, but ensure that you enter the appropriate user name and password correctly across the DB2 database setup. DB2 has a user name and password length limit of 8 characters for UNIX and Linux systems, and 30 characters for Windows.

2. Open a DB2 command line processor, with a user that has **SYSADM** or **SYSCTRL** permissions:
 - On Windows systems, click **Start > IBM DB2 > Command Line Processor**.
 - On Linux or UNIX systems, go to `~/sql1lib/bin` and enter `./db2`.
3. Enter the following database manager and SQL statements to create a database that is called **APPCNTR**:

```
CREATE DATABASE APPCNTR COLLATE USING SYSTEM PAGESIZE 32768
CONNECT TO APPCNTR
GRANT CONNECT ON DATABASE TO USER worklight
QUIT
```

4. Run DB2 with the following commands to create the **APPCNTR** tables, in a schema named **APPSCHM** (the name of the schema can be changed). This command can be run on an existing database that has a page size compatible with the one defined in step 3.

```
db2 CONNECT TO APPCNTR
db2 SET CURRENT SCHEMA = 'APPSCHM'
db2 -vf product_install_dir/ApplicationCenter/databases/create-appcenter-db2.sql -t
```

Configuring Liberty profile for DB2 manually for Application Center:

You can set up and configure your DB2 database manually for Application Center with WebSphere Application Server Liberty profile.

Before you begin

Complete the DB2 Database Setup procedure before continuing.

Procedure

1. Add the DB2 JDBC driver JAR file to `$LIBERTY_HOME/wlp/usr/shared/resources/db2`.

If that directory does not exist, create it. You can retrieve the file in one of two ways:

- Download it from DB2 JDBC Driver Versions.
- Fetch it from the `db2_install_dir/java` on the DB2 server directory.

2. Configure the data source in the `$LIBERTY_HOME/wlp/usr/servers/worklightServer/server.xml` file as follows:

In this path, you can replace `worklightServer` by the name of your server.

```
<library id="DB2Lib">
  <fileset dir="{shared.resource.dir}/db2" includes="*.jar"/>
</library>

<!-- Declare the IBM Application Center database. -->
<dataSource jndiName="jdbc/AppCenterDS" transactional="false">
  <jdbcDriver libraryRef="DB2Lib"/>
  <properties.db2.jcc databaseName="APPCNTR" currentSchema="APPSCHM"
    serverName="db2server" portNumber="50000"
    user="worklight" password="worklight"/>
</dataSource>
```

The `worklight` placeholder after `user=` is the name of the system user with `CONNECT` access to the **APPCNTR** database that you have previously created. The `worklight` placeholder after `password=` is this user's password. If you have defined either a different user name, or a different password, or both, replace `worklight` accordingly. Also, replace `db2server` with the host name of your DB2 server (for example, `localhost`, if it is on the same computer).

DB2 has a user name and password length limit of 8 characters for UNIX and Linux systems, and 30 characters for Windows.

3. You can encrypt the database password with the `securityUtility` program in `<liberty_install_dir>/bin`.

Configuring WebSphere Application Server for DB2 manually for Application Center:

You can set up and configure your DB2 database manually for Application Center with WebSphere Application Server.

About this task

Complete the DB2 database setup procedure before continuing.

Procedure

1. Determine a suitable directory for the JDBC driver JAR file in the WebSphere Application Server installation directory.
 - For a stand-alone server, you can use a directory such as `was_install_dir/optionalLibraries/IBM/Worklight/db2`.
 - For deployment to a WebSphere Application Server ND cell, use `was_install_dir/profiles/profile-name/config/cells/cell-name/Worklight/db2`.
 - For deployment to a WebSphere Application Server ND cluster, use `was_install_dir/profiles/profile-name/config/cells/cell-name/clusters/cluster-name/Worklight/db2`.
 - For deployment to a WebSphere Application Server ND node, use `was_install_dir/profiles/profile-name/config/cells/cell-name/nodes/node-name/Worklight/db2`.
 - For deployment to a WebSphere Application Server ND server, use `was_install_dir/profiles/profile-name/config/cells/cell-name/nodes/node-name/servers/server-name/Worklight/db2`.

If this directory does not exist, create it.

2. Add the DB2 JDBC driver JAR file and its associated license files, if any, to the directory that you determined in step 1.

You can retrieve the driver file in one of two ways:

- Download it from DB2 JDBC Driver Versions.
- Fetch it from the `db2_install_dir/java` directory on the DB2 server.

3. Set up the JDBC provider:
 - a. In the WebSphere Application Server console, click **Resources > JDBC > JDBC Providers**.
 - b. Select the appropriate scope from the **Scope** combination box.
 - c. Click **New**.
 - d. Set **Database type** to **DB2**.
 - e. Set **Provider type** to **DB2 Using IBM JCC Driver**.
 - f. Set **Implementation Type** to **Connection pool data source**.
 - g. Set **Name** to **DB2 Using IBM JCC Driver**.
 - h. Click **Next**.
 - i. Set the class path to the set of JAR files in the directory that you determined in step 1, replacing `was_install_dir/profiles/profile-name` with the WebSphere Application Server variable reference `${USER_INSTALL_ROOT}`.
 - j. Do not set **Native library path**.
 - k. Click **Next**.
 - l. Click **Finish**.
 - m. The JDBC provider is created.
 - n. Click **Save**.
4. Create a data source for the Application Center database:
 - a. Click **Resources > JDBC > Data sources**.
 - b. Select the appropriate scope from the **Scope** combination box.

- c. Click **New** to create a data source.
 - d. Set the **Data source name** to **Application Center Database**.
 - e. Set **JNDI Name** to **jdbc/AppCenterDS**.
 - f. Click **Next**.
 - g. Enter properties for the data source, for example:
 - **Driver type:** 4
 - **Database Name:** APPCNTR
 - **Server name:** localhost
 - **Port number:** 50000 (default)
 Leave **Use this data source in (CMP)** selected.
 - h. Click **Next**.
 - i. Create JAAS-J2C authentication data, specifying the DB2 user name and password as its properties. If necessary, go back to the data source creation wizard, by repeating steps 4a on page 6-170 to 4h.
 - j. Select the authentication alias that you created in the **Component-managed authentication alias** combination box (not in the **Container-managed authentication alias** combination box).
 - k. Click **Next** and **Finish**.
 - l. Click **Save**.
 - m. In **Resources > JDBC > Data sources**, select the new data source.
 - n. Click **WebSphere Application Server data source properties**.
 - o. Select the **Non-transactional data source** check box.
 - p. Click **OK**.
 - q. Click **Save**.
 - r. Click **Custom properties** for the data source, select property **currentSchema**, and set the value to the schema used to create the Application Center tables (APPSCHM in this example).
5. Test the data source connection by selecting **Data Source** and clicking **Test Connection**.

Configuring Apache Tomcat for DB2 manually for Application Center:

If you want to manually set up and configure your DB2 database for Application Center with Apache Tomcat server, use the following procedure.

About this task

Before you continue, complete the DB2 database setup procedure.

Procedure

1. Add the DB2 JDBC driver JAR file.
You can retrieve this JAR file in one of the following ways:
 - Download it from DB2 JDBC Driver Versions.
 - Or fetch it from the directory `db2_install_dir/java` on the DB2 server) to `$TOMCAT_HOME/lib`.
2. Prepare an XML statement that defines the data source, as shown in the following code example.

```
<Resource auth="Container"
          driverClassName="com.ibm.db2.jcc.DB2Driver"
          name="jdbc/AppCenterDS"
```

```
username="worklight"  
password="password"  
type="javax.sql.DataSource"  
url="jdbc:db2://server:50000/APPCNTR:currentSchema=APPSCHM;"/>
```

The **worklight** parameter after **username=** is the name of the system user with "CONNECT" access to the **APPCNTR** database that you have previously created. The **password** parameter after **password=** is this user's password. If you have defined either a different user name, or a different password, or both, replace these entries accordingly.

DB2 enforces limits on the length of user names and passwords.

- For UNIX and Linux systems: 8 characters
 - For Windows: 30 characters
3. Insert this statement in the `server.xml` file, as indicated in "Configuring Apache Tomcat for Application Center manually" on page 6-187.

Configuring the Apache Derby database manually for Application Center

You configure the Apache Derby database manually by creating the database and database tables, and then configuring the relevant application server to use this database setup.

Procedure

1. Create the database and the tables within them. This step is described in "Setting up your Apache Derby database manually for Application Center."
2. Configure the application server to use this database setup. Go to one of the following topics:
 - "Configuring Liberty profile for Derby manually for Application Center" on page 6-173
 - "Configuring WebSphere Application Server for Derby manually for Application Center" on page 6-173
 - "Configuring Apache Tomcat for Derby manually for Application Center" on page 6-175

Setting up your Apache Derby database manually for Application Center:

You can set up your Apache Derby database for Application Center manually.

About this task

Set up your Apache Derby database for Application Center by creating the database schema.

Procedure

1. In the location where you want the database to be created, run `ij.bat` on Windows systems or `ij.sh` on UNIX and Linux systems.

Note: The `ij` program is part of Apache Derby. If you do not already have it installed, you can download it from Apache Derby: Downloads.

For supported versions of Apache Derby, see "System requirements" on page 2-7.

The script displays `ij` version number.

2. At the command prompt, enter the following commands:

```
connect 'jdbc:derby:APPCNTR;user=APPCENTER;create=true';
run '<product_install_dir>/ApplicationCenter/databases/create-appcenter-derby.sql';
quit;
```

Configuring Liberty profile for Derby manually for Application Center:

If you want to manually set up and configure your Apache Derby database for Application Center with WebSphere Application Server Liberty profile, use the following procedure.

Before you begin

Complete the Apache Derby database setup procedure before continuing.

Procedure

Configure the data source in the \$LIBERTY_HOME/usr/servers/worklightServer/server.xml file (worklightServer may be replaced in this path by the name of your server) as follows:

```
<!-- Declare the jar files for Derby access through JDBC. -->
<library id="derbyLib">
  <fileset dir="C:/Drivers/derby" includes="derby.jar" />
</library>

<!-- Declare the IBM Application Center database. -->
<dataSource jndiName="jdbc/AppCenterDS" transactional="false" statementCacheSize="10">
  <jdbcDriver libraryRef="derbyLib"
    javax.sql.ConnectionPoolDataSource="org.apache.derby.jdbc.EmbeddedConnectionPoolDataSource40"/>
  <properties.derby.embedded databaseName="DERBY_DATABASES_DIR/APPCNTR" user="APPCENTER"
    shutdownDatabase="false" connectionAttributes="upgrade=true"/>
  <connectionManager connectionTimeout="180"
    maxPoolSize="10" minPoolSize="1"
    reapTime="180" maxIdleTime="1800"
    agedTimeout="7200" purgePolicy="EntirePool"/>
</dataSource>
```

Configuring WebSphere Application Server for Derby manually for Application Center:

You can set up and configure your Apache Derby database manually for Application Center with WebSphere Application Server.

About this task

Complete the Apache Derby database setup procedure before continuing.

Procedure

1. Determine a suitable directory for the JDBC driver JAR file in the WebSphere Application Server installation directory.

If this directory does not exist, create it.

- For a standalone server, you can use a directory such as *was_install_dir/optionalLibraries/IBM/Worklight/derby*.
- For deployment to a WebSphere Application Server ND cell, use *was_install_dir/profiles/profile-name/config/cells/cell-name/Worklight/derby*.
- For deployment to a WebSphere Application Server ND cluster, use *was_install_dir/profiles/profile-name/config/cells/cell-name/clusters/cluster-name/Worklight/derby*.

- For deployment to a WebSphere Application Server ND node, use `was_install_dir/profiles/profile-name/config/cells/cell-name/nodes/node-name/Worklight/derby`.
 - For deployment to a WebSphere Application Server ND server, use `was_install_dir/profiles/profile-name/config/cells/cell-name/nodes/node-name/servers/server-name/Worklight/derby`.
2. Add the Derby JAR file from `product_install_dir/ApplicationCenter/tools/lib/derby.jar` to the directory determined in step 1.
 3. Set up the JDBC provider.
 - a. In the WebSphere Application Server console, click **Resources > JDBC > JDBC Providers**.
 - b. Select the appropriate scope from the **Scope** combination box.
 - c. Click **New**.
 - d. Set **Database Type** to **User-defined**.
 - e. Set **class Implementation name** to `org.apache.derby.jdbc.EmbeddedConnectionPoolDataSource40`.
 - f. Set **Name** to **Worklight - Derby JDBC Provider**.
 - g. Set **Description** to **Derby JDBC provider for Worklight**.
 - h. Click **Next**.
 - i. Set the **Class path** to the JAR file in the directory determined in step 1, replacing `was_install_dir/profiles/profile-name` with the WebSphere Application Server variable reference `${USER_INSTALL_ROOT}`.
 - j. Click **Finish**.
 4. Create the data source for the Worklight database.
 - a. In the WebSphere Application Server console, click **Resources > JDBC > Data sources**.
 - b. Select the appropriate scope from the **Scope** combination box.
 - c. Click **New**.
 - d. Set **Data source Name** to **Application Center Database**.
 - e. Set **JNDI name** to `jdbc/AppCenterDS`.
 - f. Click **Next**.
 - g. Select the existing JDBC Provider that is named **Worklight - Derby JDBC Provider**.
 - h. Click **Next**.
 - i. Click **Next**.
 - j. Click **Finish**.
 - k. Click **Save**.
 - l. In the table, click the **Application Center Database** data source that you created.
 - m. Under **Additional Properties**, click **Custom properties**.
 - n. Click **databaseName**.
 - o. Set **Value** to the path to the APPCNTR database that is created in “Setting up your Apache Derby database manually for Application Center” on page 6-172.
 - p. Click **OK**.
 - q. Click **Save**.
 - r. At the top of the page, click **Application Center Database**.

- s. Under **Additional Properties**, click **WebSphere Application Server data source properties**.
- t. Select **Non-transactional datasource**.
- u. Click **OK**.
- v. Click **Save**.
- w. In the table, select the **Application Center Database** data source that you created.
- x. Optional: Only if you are not on the console of a WebSphere Application Server Deployment Manager, click **test connection**.

Configuring Apache Tomcat for Derby manually for Application Center:

You can set up and configure your Apache Derby database manually for Application Center with the Apache Tomcat application server.

About this task

Complete the Apache Derby database setup procedure before continuing.

Procedure

1. Add the Derby JAR file from *product_install_dir*/ApplicationCenter/tools/lib/derby.jar to the directory \$TOMCAT_HOME/lib.
2. Prepare an XML statement that defines the data source, as shown in the following code example.

```
<Resource auth="Container"
  driverClassName="org.apache.derby.jdbc.EmbeddedDriver"
  name="jdbc/AppCenterDS"
  username="APPCENTER"
  password=""
  type="javax.sql.DataSource"
  url="jdbc:derby:DERBY_DATABASES_DIR/APPCNTR"/>
```

3. Insert this statement in the *server.xml* file, as indicated in “Configuring Apache Tomcat for Application Center manually” on page 6-187.

Configuring the MySQL database manually for Application Center

You configure the MySQL database manually by creating the database, creating the database tables, and then configuring the relevant application server to use this database setup.

Procedure

1. Create the database. This step is described in “Creating the MySQL database for Application Center” on page 6-164.
2. Create the tables in the database. This step is described in “Setting up your MySQL database manually for Application Center.”
3. Perform the application server-specific setup as the following list shows.

Setting up your MySQL database manually for Application Center:

You can set up your MySQL database for Application Center manually.

About this task

Complete the following procedure to set up your MySQL database.

Procedure

1. Create the database schema.
 - a. Run a MySQL command line client with the option `-u root`.
 - b. Enter the following commands:

```
CREATE DATABASE APPCNTR CHARACTER SET utf8 COLLATE utf8_general_ci;
GRANT ALL PRIVILEGES ON APPCNTR.* TO 'worklight'@'Worklight-host' IDENTIFIED BY 'worklight';
GRANT ALL PRIVILEGES ON APPCNTR.* TO 'worklight'@'localhost' IDENTIFIED BY 'worklight';
FLUSH PRIVILEGES;
```

```
USE APPCNTR;
SOURCE product_install_dir/ApplicationCenter/databases/create-appcenter-mysql.sql;
```

Where **worklight** before the "at" sign (@) is the user name, **worklight** after **IDENTIFIED BY** is its password, and **Worklight-host** is the name of the host on which IBM MobileFirst Platform Foundation for iOS runs.

2. Add the following property to your MySQL option file:
`max_allowed_packet=256M`
For more information about option files, see the MySQL documentation at MySQL.
3. Add the following property to your MySQL option file: `innodb_log_file_size = 250M`
For more information about the **innodb_log_file_size** property, see the MySQL documentation, section `innodb_log_file_size`.

Configuring Liberty profile for MySQL manually for Application Center:

If you want to manually set up and configure your MySQL database for Application Center with WebSphere Application Server Liberty profile, use the following procedure.

Before you begin

Complete the MySQL database setup procedure before continuing.

Note: MySQL in combination with WebSphere Application Server Liberty profile or WebSphere Application Server full profile is not classified as a supported configuration. For more information, see WebSphere Application Server Support Statement. You can use IBM DB2 or another database supported by WebSphere Application Server to benefit from a configuration that is fully supported by IBM Support.

Procedure

1. Add the MySQL JDBC driver JAR file to `$LIBERTY_HOME/wlp/usr/shared/resources/mysql`. If that directory does not exist, create it.
2. Configure the data source in the `$LIBERTY_HOME/usr/servers/worklightServer/server.xml` file (`worklightServer` may be replaced in this path by the name of your server) as follows:

```
<!-- Declare the jar files for MySQL access through JDBC. -->
<library id="MySQLLib">
  <fileset dir="{shared.resource.dir}/mysql" includes="*.jar"/>
</library>
```

```
<!-- Declare the IBM Application Center database. -->
<dataSource jndiName="jdbc/AppCenterDS" transactional="false">
  <jdbcDriver libraryRef="MySQLLib"/>
```

```

    <properties databaseName="APPCNTR"
               serverName="mysqlserver" portNumber="3306"
               user="worklight" password="worklight"/>
</dataSource>

```

where **worklight** after **user=** is the user name, **worklight** after **password=** is this user's password, and **mysqlserver** is the host name of your MySQL server (for example, localhost, if it is on the same machine).

3. You can encrypt the database password with the securityUtility program in <liberty_install_dir>/bin.

Configuring WebSphere Application Server for MySQL manually for Application Center:

If you want to manually set up and configure your MySQL database for Application Center with WebSphere Application Server, use the following procedure.

About this task

Complete the MySQL database setup procedure before continuing.

Note: MySQL in combination with WebSphere Application Server Liberty profile or WebSphere Application Server full profile is not classified as a supported configuration. For more information, see WebSphere Application Server Support Statement. We suggest that you use IBM DB2 or another database supported by WebSphere Application Server to benefit from a configuration that is fully supported by IBM Support.

Procedure

1. Determine a suitable directory for the JDBC driver JAR file in the WebSphere Application Server installation directory.
 - For a standalone server, you can use a directory such as WAS_INSTALL_DIR/optionalLibraries/IBM/Worklight/mysql.
 - For deployment to a WebSphere Application Server ND cell, use WAS_INSTALL_DIR/profiles/profile-name/config/cells/cell-name/Worklight/mysql.
 - For deployment to a WebSphere Application Server ND cluster, use WAS_INSTALL_DIR/profiles/profile-name/config/cells/cell-name/clusters/cluster-name/Worklight/mysql.
 - For deployment to a WebSphere Application Server ND node, use WAS_INSTALL_DIR/profiles/profile-name/config/cells/cell-name/nodes/node-name/Worklight/mysql.
 - For deployment to a WebSphere Application Server ND server, use WAS_INSTALL_DIR/profiles/profile-name/config/cells/cell-name/nodes/node-name/servers/server-name/Worklight/mysql.

If this directory does not exist, create it.

2. Add the MySQL JDBC driver JAR file downloaded from Download Connector/J to the directory determined in step 1.
3. Set up the JDBC provider:
 - a. In the WebSphere Application Server console, click **Resources > JDBC > JDBC Providers**.
 - b. Select the appropriate scope from the **Scope** combination box.
 - c. Click **New**.

- d. Create a JDBC provider named **MySQL**.
 - e. Set **Database type** to **User defined**.
 - f. Set **Scope** to **Cell**.
 - g. Set **Implementation class** to **com.mysql.jdbc.jdbc2.optional.MysqlConnectionPoolDataSource**.
 - h. Set **Database classpath** to the JAR file in the directory determined in step 1, replacing `WAS_INSTALL_DIR/profiles/profile-name` with the WebSphere Application Server variable reference `${USER_INSTALL_ROOT}`.
 - i. Save your changes.
4. Create a data source for the IBM Application Center database:
 - a. Click **Resources > JDBC > Data sources**.
 - b. Select the appropriate scope from the **Scope** combination box.
 - c. Click **New** to create a data source.
 - d. Type any name (for example, Application Center Database).
 - e. Set **JNDI Name** to `jdbc/AppCenterDS`.
 - f. Use the existing **JDBC Provider MySQL**, defined in the previous step.
 - g. Set **Scope** to **New**.
 - h. On the **Configuration** tab, select **Non-transactional data source**.
 - i. Click **Next** a number of times, leaving all other settings as defaults.
 - j. Save your changes.
 5. Set the custom properties of the new data source.
 - a. Select the new data source.
 - b. Click **Custom properties**.
 - c. Set the following properties:

```
portNumber = 3306
relaxAutoCommit=true
databaseName = APPCNTR
serverName = the host name of the MySQL server
user = the user name of the MySQL server
password = the password associated with the user name
```
 6. Set the WebSphere Application Server custom properties of the new data source.
 - a. In **Resources > JDBC > Data sources**, select the new data source.
 - b. Click **WebSphere Application Server data source properties**.
 - c. Select **Non-transactional data source**.
 - d. Click **OK**.
 - e. Click **Save**.

Configuring Apache Tomcat for MySQL manually for Application Center:

If you want to manually set up and configure your MySQL database for Application Center with the Apache Tomcat server, use the following procedure.

About this task

Complete the MySQL database setup procedure before continuing.

Procedure

1. Add the MySQL Connector/J JAR file to the `$TOMCAT_HOME/lib` directory.

2. Prepare an XML statement that defines the data source, as shown in the following code example. Insert this statement in the `server.xml` file, as indicated in “Configuring Apache Tomcat for Application Center manually” on page 6-187.

```
<Resource name="jdbc/AppCenterDS"
  auth="Container"
  type="javax.sql.DataSource"
  maxActive="100"
  maxIdle="30"
  maxWait="10000"
  username="worklight"
  password="worklight"
  driverClassName="com.mysql.jdbc.Driver"
  url="jdbc:mysql://server:3306/APPCNTR"/>
```

Configuring the Oracle database manually for IBM MobileFirst Platform Application Center

You configure the Oracle database manually by creating the database, creating the database tables, and then configuring the relevant application server to use this database setup.

Procedure

1. Create the database. This step is described in “Creating the Oracle database for Application Center” on page 6-164.
2. Create the tables in the database. This step is described in “Setting up your Oracle database manually for Application Center.”
3. Perform the application server-specific setup as the following list shows.

Setting up your Oracle database manually for Application Center:

You can set up your Oracle database for Application Center manually.

About this task

Complete the following procedure to set up your Oracle database.

Procedure

1. Ensure that you have at least one Oracle database.
In many Oracle installations, the default database has the SID (name) ORCL. For best results, specify **Unicode (AL32UTF8)** as the character set of the database.
If the Oracle installation is on a UNIX or Linux computer, make sure that the database is started next time the Oracle installation is restarted. To this effect, make sure that the line in `/etc/oratab` that corresponds to the database ends with a Y, not with an N.
2. Create the user APPCENTER, either by using Oracle Database Control, or by using the Oracle SQLPlus command-line interpreter.
 - To create the user for the Application Center database/schema, by using Oracle Database Control, proceed as follows:
 - a. Connect as SYSDBA.
 - b. Go to the Users page.
 - c. Click **Server**, then **Users** in the Security section.
 - d. Create a user, named APPCENTER with the following attributes:
Profile: DEFAULT
Authentication: password
Default tablespace: USERS

```

Temporary tablespace: TEMP
Status: Unlocked
Add system privilege: CREATE SESSION
Add system privilege: CREATE SEQUENCE
Add system privilege: CREATE TABLE
Add quota: Unlimited for tablespace USERS

```

- To create the user by using Oracle SQLPlus, enter the following commands:

```

CONNECT SYSTEM/<SYSTEM_password>@ORCL
CREATE USER APPCENTER IDENTIFIED BY password DEFAULT TABLESPACE USERS QUOTA UNLIMITED ON USERS;
GRANT CREATE SESSION, CREATE SEQUENCE, CREATE TABLE TO APPCENTER;
DISCONNECT;

```

3. Create the tables for the Application Center database:

- a. Using the Oracle SQLPlus command-line interpreter, create the tables for the Application Center database by running the create-appcenter-oracle.sql file:

```

CONNECT APPCENTER/APPCENTER_password@ORCL
@product_install_dir/ApplicationCenter/databases/create-appcenter-oracle.sql
DISCONNECT;

```

4. Download and configure the Oracle JDBC driver:

- a. Download the JDBC driver from the Oracle website at Oracle: JDBC, SQLJ, Oracle JPublisher and Universal Connection Pool (UCP):
- b. Ensure that the Oracle JDBC driver is in the system path. The driver file is ojdbc6.jar.

Configuring Liberty profile for Oracle manually for Application Center:

You can set up and configure your Oracle database manually for Application Center with WebSphere Application Server Liberty profile by adding the JAR file of the Oracle JDBC driver.

Before you begin

Before continuing, set up the Oracle database.

Procedure

1. Add the JAR file of the Oracle JDBC driver to `$LIBERTY_HOME/wlp/usr/shared/resources/oracle`.

If that directory does not exist, create it.

2. If you are using JNDI, configure the data sources in the `$LIBERTY_HOME/wlp/usr/servers/mobileFirstServer/server.xml` file as shown in the following JNDI code example:

Note: In this path, you can replace `mobileFirstServer` with the name of your server.

```

<!-- Declare the jar files for Oracle access through JDBC. -->
<library id="OracleLib">
  <fileset dir="{shared.resource.dir}/oracle" includes="*.jar"/>
</library>

<!-- Declare the IBM Application Center database. -->
<dataSource jndiName="jdbc/AppCenterDS" transactional="false">
  <jdbcDriver libraryRef="OracleLib"/>
  <properties.oracle driverType="thin"
    serverName="oserver" portNumber="1521"
    databaseName="ORCL"
    user="APPCENTER" password="APPCENTER_password"/>
</dataSource>

```

where

- **APPCENTER** after **user=** is the user name,
- **APPCENTER_password** after **password=** is this user's password, and
- **oserver** is the host name of your Oracle server (for example, localhost if it is on the same machine).

Note: For more information on how to connect the Liberty server to the Oracle database with a service name, or with a URL, see the WebSphere Application Server Liberty Core 8.5.5 documentation, section **properties.oracle**.

3. You can encrypt the database password with the securityUtility program in <liberty_install_dir>/bin.

What to do next

For more steps to configure Application Center, see “Deploying the Application Center WAR files and configuring the application server manually” on page 6-183.

Configuring WebSphere Application Server for Oracle manually for Application Center:

If you want to manually set up and configure your Oracle database for Application Center with WebSphere Application Server, use the following procedure.

About this task

Complete the Oracle database setup procedure before continuing.

Procedure

1. Determine a suitable directory for the JDBC driver JAR file in the WebSphere Application Server installation directory.
 - For a standalone server, you can use a directory such as `WAS_INSTALL_DIR/optionalLibraries/IBM/Worklight/oracle`.
 - For deployment to a WebSphere Application Server ND cell, use `WAS_INSTALL_DIR/profiles/profile-name/config/cells/cell-name/Worklight/oracle`.
 - For deployment to a WebSphere Application Server ND cluster, use `WAS_INSTALL_DIR/profiles/profile-name/config/cells/cell-name/clusters/cluster-name/Worklight/oracle`.
 - For deployment to a WebSphere Application Server ND node, use `WAS_INSTALL_DIR/profiles/profile-name/config/cells/cell-name/nodes/node-name/Worklight/oracle`.
 - For deployment to a WebSphere Application Server ND server, use `WAS_INSTALL_DIR/profiles/profile-name/config/cells/cell-name/nodes/node-name/servers/server-name/Worklight/oracle`.

If this directory does not exist, create it.

2. Add the Oracle `ojdbc6.jar` file downloaded from JDBC and Universal Connection Pool (UCP) to the directory determined in step 1.
3. Set up the JDBC provider:
 - a. In the WebSphere Application Server console, click **Resources > JDBC > JDBC Providers**.
 - b. Select the appropriate scope from the **Scope** combination box.
 - c. Click **New**.

d. Complete the JDBC Provider fields as indicated in the following table:

Table 6-51. JDBC Provider field values

Field	Value
Database type	Oracle
Provider type	Oracle JDBC Driver
Implementation type	Connection pool data source
Name	Oracle JDBC Driver

- e. Click **Next**.
- f. Set the class path to the JAR file in the directory determined in step 1, replacing `WAS_INSTALL_DIR/profiles/profile-name` with the WebSphere Application Server variable reference `${USER_INSTALL_ROOT}`
- g. Click **Next**.
The JDBC provider is created.
4. Create a data source for the Worklight database:
 - a. Click **Resources > JDBC > Data sources**.
 - b. Select the appropriate scope from the **Scope** combination box.
 - c. Click **New**.
 - d. Set **Data source name** to **Oracle JDBC Driver DataSource**.
 - e. Set **JNDI name** to `jdbc/AppCenterDS`.
 - f. Click **Next**.
 - g. Click **Select an existing JDBC provider** and select **Oracle JDBC driver** from the list.
 - h. Click **Next**.
 - i. Set the URL value to `jdbc:oracle:thin:@oserver:1521:ORCL`, where **oserver** is the host name of your Oracle server (for example, localhost, if it is on the same machine).
 - j. Click **Next** twice.
 - k. Click **Resources > JDBC > Data sources > Oracle JDBC Driver DataSource > Custom properties**.
 - l. Set **oracleLogPackageName** to `oracle.jdbc.driver`.
 - m. Set **user** = `APPCENTER`.
 - n. Set **password** = `APPCENTER_password`.
 - o. Click **OK** and save the changes.
 - p. In **Resources > JDBC > Data sources**, select the new data source.
 - q. Click **WebSphere Application Server data source properties**.
 - r. Select the **Non-transactional data source** check box.
 - s. Click **OK**.
 - t. Click **Save**.

Configuring Apache Tomcat for Oracle manually for Application Center:

If you want to manually set up and configure your Oracle database for Application Center with the Apache Tomcat server, use the following procedure.

About this task

Complete the Oracle database setup procedure before continuing.

Procedure

1. Add the Oracle JDBC driver JAR file to the directory \$TOMCAT_HOME/lib.
2. Prepare an XML statement that defines the data source, as shown in the following code example. Insert this statement in the server.xml file, as indicated in “Configuring Apache Tomcat for Application Center manually” on page 6-187

```
<Resource name="jdbc/AppCenterDS"
  auth="Container"
  type="javax.sql.DataSource"
  driverClassName="oracle.jdbc.driver.OracleDriver"
  url="jdbc:oracle:thin:@oserver:1521:ORCL"
  username="APPCENTER"
  password="APPCENTER_password"/>
```

Where **APPCENTER** after **username=** is the name of the system user with "CONNECT" access to the **APPCNTR** database that you have previously created, and **APPCENTER_password** after **password=** is this user's password. If you have defined either a different user name, or a different password, or both, replace these values accordingly.

Deploying the Application Center WAR files and configuring the application server manually

The procedure to manually deploy the Application Center WAR files manually to an application server depends on the type of application server being configured.

These manual instructions assume that you are familiar with your application server.

Note: Using the MobileFirst Server installer to install Application Center is more reliable than installing manually, and should be used whenever possible.

If you prefer to use the manual process, follow these steps to configure your application server for Application Center. You must deploy the appcenterconsole.war and applicationcenter.war files to your Application Center. The files are located in *product_install_dir*/ApplicationCenter/console.

Configuring the Liberty profile for Application Center manually:

To configure WebSphere Application Server Liberty profile manually for Application Center, you must modify the server.xml file.

About this task

In addition to modifications for the databases that are described in “Manual installation of Application Center” on page 6-168, you must make the following modifications to the server.xml file.

Procedure

1. Ensure that the <featureManager> element contains at least the following <feature> elements:
 - For WebSphere Application Server Libertyprofile V8.5.0.x:

```
<feature>ssl-1.0</feature>
<feature>servlet-3.0</feature>
<feature>jdbc-4.0</feature>
<feature>appSecurity-1.0</feature>
<feature>jndi-1.0</feature>
```
 - For WebSphere Application Server Liberty profile V8.5.5.0 and later:

```

    <feature>jdbc-4.0</feature>
    <feature>appSecurity-2.0</feature>
    <feature>servlet-3.0</feature>

```

2. Add the following declarations for Application Center:

```

<!-- Declare the IBM Application Center Console application. -->
<application id="appcenterconsole"
    name="appcenterconsole"
    location="appcenterconsole.war"
    type="war">
  <application-bnd>
    <security-role name="appcenteradmin">
      <group name="appcentergroup"/>
    </security-role>
  </application-bnd>
  <classloader delegation="parentLast">
    <commonLibrary>
      <fileset dir="{wlp.install.dir}/lib" includes="com.ibm.ws.crypto.passwordutil_*.jar"/>
    </commonLibrary>
  </classloader>
</application>

<!-- Declare the IBM Application Center Services application. -->
<application id="applicationcenter"
    name="applicationcenter"
    location="applicationcenter.war"
    type="war">
  <application-bnd>
    <security-role name="appcenteradmin">
      <group name="appcentergroup"/>
    </security-role>
  </application-bnd>
  <classloader delegation="parentLast">
    <commonLibrary>
      <fileset dir="{wlp.install.dir}/lib"
        includes="com.ibm.ws.crypto.passwordutil_*.jar"/>
    </commonLibrary>
  </classloader>
</application>

<!-- Declare the user registry for the IBM Application Center. -->
<basicRegistry id="applicationcenter-registry"
    realm="ApplicationCenter">
  <!-- The users defined here are members of group "appcentergroup",
    thus have role "appcenteradmin", and can therefore perform
    administrative tasks through the Application Center Console. -->
  <user name="appcenteradmin" password="admin"/>
  <user name="demo" password="demo"/>
  <group name="appcentergroup">
    <member name="appcenteradmin"/>
    <member name="demo"/>
  </group>
</basicRegistry>

```

The groups and users that are defined in the `basicRegistry` are example logins that you can use to test Application Center. Similarly, the groups that are defined in the `<security-role name="appcenteradmin">` for the Application Center console and the Application Center service are examples. For more information about how to modify these groups, see “Configuring WebSphere Application Server Liberty profile” on page 6-191.

3. If the database is Oracle, add the **commonLibraryRef** attribute to the class loader of the Application Center service application.

```

...
<classloader delegation="parentLast" commonLibraryRef="OracleLib">
  <commonLibrary>
...

```

The name of the library reference (OracleLib in this example) must be the ID of the library that contains the JDBC JAR file. This ID is declared in the procedure that is documented in “Configuring Liberty profile for Oracle manually for Application Center” on page 6-180.

4. Copy the Application Center WAR files to your Liberty server.

- On UNIX and Linux systems:

```
mkdir -p $LIBERTY_HOME/wlp/usr/servers/<server_name>/apps
cp product_install_dir/ApplicationCenter/console/*.war
```

- On Windows systems:

```
mkdir LIBERTY_HOME\wlp\usr\servers\<server_name>\apps
copy /B product_install_dir\ApplicationCenter\console\appcenterconsole.war LIBERTY_HOME\
wlp\usr\servers\<server_name>\apps\appcenterconsole.war
copy /B product_install_dir\ApplicationCenter\console\applicationcenter.war LIBERTY_HOME\
wlp\usr\servers\<server_name>\apps\applicationcenter.war
```

5. Start the Liberty server.

What to do next

For more steps to configure Application Center, see “Configuring WebSphere Application Server Liberty profile” on page 6-191.

Configuring WebSphere Application Server for Application Center manually:

To configure WebSphere Application Server for Application Center manually, you must configure variables, custom properties, and class loader policies.

Before you begin

These instructions assume that a stand-alone profile exists and that the application server is using the default ports.

Procedure

1. Log on to the WebSphere Application Server administration console for your IBM MobileFirst Platform Server.
The address is of the form `http://server.com:9060/ibm/console`, where *server* is the name of the server.
2. Enable application security.
 - a. Click **Security > Global Security**.
 - b. Ensure that **Enable administrative security** is selected. Application security can be enabled only if administrative security is enabled.
 - c. Ensure that **Enable application security** is selected.
 - d. Click **OK**.
 - e. Save the changes.

For more information, see Enabling security.

3. Create the Application Center JDBC data source and provider.
See the instructions in the appropriate subsection in “Manual installation of Application Center” on page 6-168.
4. Install the Application Center console WAR file.
 - a. Depending on your version of WebSphere Application Server, click one of the following options:
 - **Applications > New > New Enterprise Application**
 - **Applications > New Application > New Enterprise Application**

- b. Navigate to the MobileFirst Server installation directory `product_install_dir/ApplicationCenter/console`.
 - c. Select **appcenterconsole.war**, and then click **Next**.
 - d. On the How do you want to install the application? page, click **Detailed**, and then click **Next**.
 - e. On the Application Security Warnings page, click **Continue**.
 - f. Click **Next** until you reach the "Map context roots for web modules" page.
 - g. In the **Context Root** field, type `/appcenterconsole`.
 - h. Click **Next**.
 - i. Click **Finish**.
5. Configure the class loader policies and then start the application:
 - a. Click the **Manage Applications** link, or click **Applications > WebSphere Enterprise Applications**.
 - b. From the list of applications, click **appcenterconsole_war**.
 - c. In the Detail Properties section, click the **Class loading and update detection** link.
 - d. In the Class loader order pane, click **Classes loaded with local class loader first (parent last)**.
 - e. Click **OK**.
 - f. In the Modules section, click **Manage Modules**.
 - g. From the list of modules, click **ApplicationCenterConsole**.
 - h. In the Class loader order pane, click **Classes loaded with local class loader first (parent last)**.
 - i. Click **OK** twice.
 - j. Click **Save**.
 - k. Click **Select** for **appcenterconsole_war** and click **Start**.
 6. Repeat step 4, selecting **applicationcenter.war** in substep c, and using a **Context Root** of `/applicationcenter` in substep g.
 7. Repeat step 5, selecting **applicationcenter.war** from the list of applications in substep b.
 8. Review the server class loader policy: Click **Servers > Server Types > Application Servers** and then select the server.
 - If the class loader policy is set to **Multiple**, do nothing.
 - If the class loader policy is set to **Single** and the class loading mode is set to **parent-last**, do nothing.
 - If the class loader policy is set to **Single** and the class loading mode is set to **parent-first**, change the class loader policy to **Multiple**, and set the class loader order of all applications other than MobileFirst applications to **parent-first**.

Results

You can now access the Application Center at `http://<server>:<port>/appcenterconsole`, where *server* is the host name of your server and *port* is the port number (by default 9080).

What to do next

For more steps to configure the Application Center, see "Configuring WebSphere Application Server full profile" on page 6-189.

Configuring Apache Tomcat for Application Center manually:

To configure Apache Tomcat for Application Center manually, you must copy JAR and WAR files to Tomcat, add database drivers, edit the `server.xml` file, and then start Tomcat.

Procedure

1. Add the database drivers to the Tomcat `lib` directory. See the instructions for the appropriate DBMS in “Manual installation of Application Center” on page 6-168.
2. Edit `tomcat_install_dir/conf/server.xml`.

- a. Uncomment the following element, which is initially commented out:

```
<Valve className="org.apache.catalina.authenticator.SingleSignOn" />
```

- b. Declare the Application Center console and services applications and a user registry:

```
<!-- Declare the IBM Application Center Console application. -->
<Context path="/appcenterconsole" docBase="appcenterconsole">
```

```
    <!-- Define the AppCenter services endpoint in order for the AppCenter
         console to be able to invoke the REST service.
         You need to enable this property if the server is behind a reverse
         proxy or if the context root of the Application Center Services
         application is different from '/applicationcenter'. -->
    <!-- <Environment name="ibm.appcenter.services.endpoint"
         value="http://proxy-host:proxy-port/applicationcenter"
         type="java.lang.String" override="false"/>
    -->
```

```
</Context>
```

```
<!-- Declare the IBM Application Center Services application. -->
<Context path="/applicationcenter" docBase="applicationcenter">
```

```
    <!-- The protocol of the application resources URI.
         This property is optional. It is only needed if the protocol
         of the external and internal URI are different. -->
    <!-- <Environment name="ibm.appcenter.proxy.protocol"
         value="http" type="java.lang.String" override="false"/>
    -->
```

```
    <!-- The host name of the application resources URI. -->
    <!-- <Environment name="ibm.appcenter.proxy.host"
         value="proxy-host"
         type="java.lang.String" override="false"/>
    -->
```

```
    <!-- The port of the application resources URI.
         This property is optional. -->
    <!-- <Environment name="ibm.appcenter.proxy.port"
         value="proxy-port"
         type="java.lang.Integer" override="false"/> -->
```

```
    <!-- Declare the IBM Application Center Services database. -->
    <!-- <Resource name="jdbc/AppCenterDS" type="javax.sql.DataSource" ... -->
```

```
</Context>
```

```
<!-- Declare the user registry for the IBM Application Center.
     The MemoryRealm recognizes the users defined in conf/tomcat-users.xml.
     For other choices, see Apache Tomcat's "Realm Configuration HOW-TO"
     http://tomcat.apache.org/tomcat-7.0-doc/realms-howto.html . -->
<Realm className="org.apache.catalina.realm.MemoryRealm"/>
```

where you fill in the <Resource> element as described in one of the sections:

- “Configuring Apache Tomcat for DB2 manually for Application Center” on page 6-171
 - “Configuring Apache Tomcat for Derby manually for Application Center” on page 6-175
 - “Configuring Apache Tomcat for MySQL manually for Application Center” on page 6-178
 - “Configuring Apache Tomcat for Oracle manually for Application Center” on page 6-182
3. Copy the Application Center WAR files to Tomcat.
 - On UNIX and Linux systems: `cp product_install_dir/ApplicationCenter/console/*.war TOMCAT_HOME/webapps`
 - On Windows systems:

```
copy /B product_install_dir\ApplicationCenter\console\appcenterconsole.war
tomcat_install_dir\webapps\appcenterconsole.war
copy /B product_install_dir\ApplicationCenter\console\applicationcenter.war
tomcat_install_dir\webapps\applicationcenter.war
```
 4. Start Tomcat.

What to do next

For more steps to configure the Application Center, see “Configuring Apache Tomcat” on page 6-192.

Configuring the Application Center after installation

You configure user authentication and choose an authentication method; configuration procedure depends on the web application server that you use.

The Application Center requires user authentication.

You must perform some configuration after the installer deploys the Application Center web applications in the web application server.

The Application Center has two Java Platform, Enterprise Edition (Java EE) security roles defined:

- The **appcenteruser** role that represents an ordinary user of the Application Center who can install mobile applications from the catalog to a mobile device belonging to that user.
- The **appcenteradmin** role that represents a user who can perform administrative tasks through the Application Center console.

You must map the roles to the corresponding sets of users.

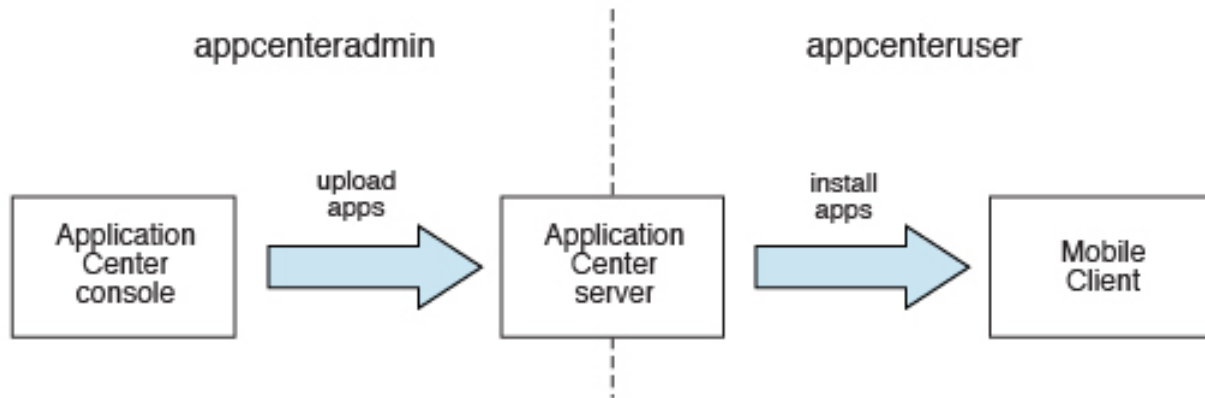

Figure 6-12. Java EE security roles of the Application Center and the components that they influence

If you choose to use an authentication method through a user repository such as LDAP, you can configure the Application Center so that you can use users and groups with the user repository to define the Access Control List (ACL) of the Application Center. This procedure is conditioned by the type and version of the web application server that you use. See “Managing users with LDAP” on page 6-194 for information about LDAP used with the Application Center.

After you configure authentication of the users of the Application Center, which includes configuring LDAP if you plan to use it, you can, if necessary, define the endpoint of the application resources. You must then build the Application Center mobile client. The mobile client is used to install applications on mobile devices. See “Preparations for using the mobile client” on page 11-69 for how to build the Application Center mobile client.

Related concepts:

“Managing users with LDAP” on page 6-194

Use the Lightweight Directory Access Protocol (LDAP) registry to manage users.

Related reference:

Preparations for using the mobile client

To use the mobile client to install apps on mobile devices, you must first import the **IBMAppCenter** project into the Eclipse environment, build the project, and deploy the mobile client in the Application Center.

Configuring WebSphere Application Server full profile

Configure security by mapping the Application Center Java EE roles to a set of users for both web applications.

Before you begin

Review the definition of roles at “Configuring the Application Center after installation” on page 6-188.

Procedure

You define the basics of user configuration in the WebSphere Application Server console. Access to the console is usually by this address:

`https://localhost:9043/ibm/console/`

1. Select **Security > Global Security**.
2. Select **Security Configuration Wizard** to configure users.

You can manage individual user accounts by selecting **Users and Groups > Manage Users**.

3. Map the roles **appcenteruser** and **appcenteradmin** to a set of users.
 - a. Select **Servers > Server Types > WebSphere application servers**.
 - b. Select the server.
 - c. In the **Configuration** tab, select **Applications > Enterprise applications**.

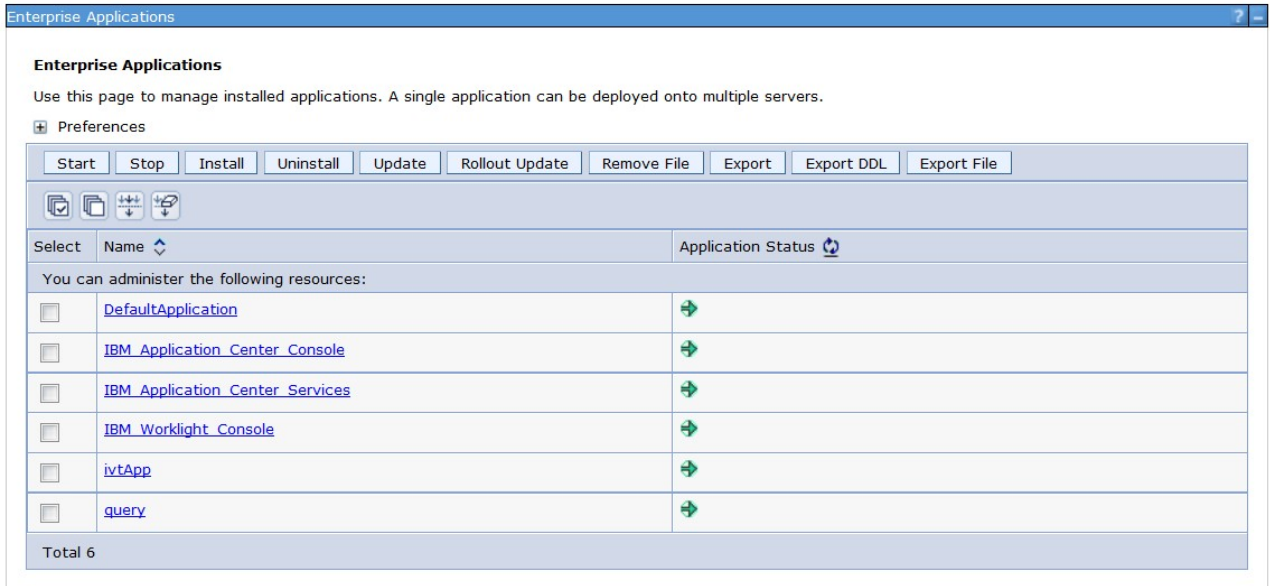

Figure 6-13. Mapping the Application Center roles

- d. Select **IBM_Application_Center_Services**.
- e. In the **Configuration** tab, select **Details > Security role to user/group mapping**.

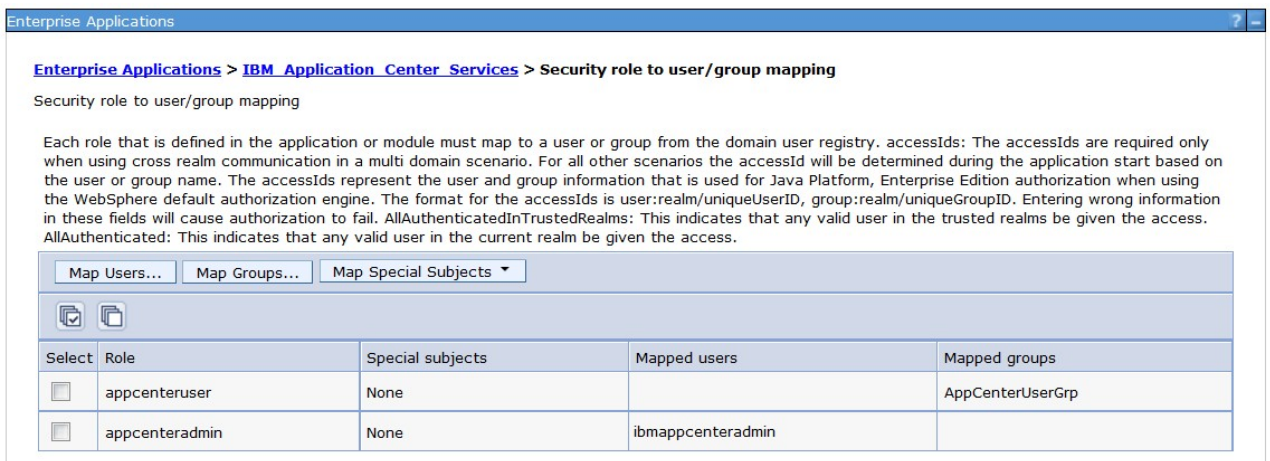

Figure 6-14. Mapping the **appcenteruser** and **appcenteradmin** roles: user groups

- f. Perform the necessary customization.
- g. Click **OK**.
- h. Repeat steps c to g to map the roles for the console web application; in step d, select **IBM_Application_Center_Console**.

- i. Click **Save** to save the changes.

Configuring WebSphere Application Server Liberty profile

Configure the Java EE security roles of the Application Center and the data source in the `server.xml` file.

Before you begin

Review the definition of roles at “Configuring the Application Center after installation” on page 6-188.

In WebSphere Application Server Liberty profile, you configure the roles of `appcenteruser` and `appcenteradmin` in the `server.xml` configuration file of the server.

About this task

To configure the security roles, you must edit the `server.xml` file. In the `<application-bnd>` element of each `<application>` element, create two `<security-role>` elements. One `<security-role>` element is for the **appcenteruser** role and the other is for the **appcenteradmin** role. Map the roles to the appropriate user group name **appcenterusergroup** or **appcenteradmingroup**. These groups are defined through the `<basicRegistry>` element. You can customize this element or replace it entirely with an `<ldapRegistry>` element or a `<safRegistry>` element.

Then, to maintain good response times with a large number of installed applications, for example with 80 applications, you should configure a connection pool for the Application Center database.

Procedure

1. Edit the `server.xml` file.

For example:

```
<security-role name="appcenteradmin">
  <group name="appcenteradmingroup"/>
</security-role>
<security-role name="appcenteruser">
  <group name="appcenterusergroup"/>
</security-role>
```

You must include this example in the `<application-bnd>` element of each `<application>` element: the `appcenterconsole` and `applicationcenter` applications.

Replace the `<security-role>` elements that have been created during installation for test purposes.

```
<basicRegistry id="appcenter">
  <user name="admin" password="admin"/>
  <user name="guest" password="guest"/>
  <user name="demo" password="demo"/>
  <group name="appcenterusergroup">
    <member name="guest"/>
    <member name="demo"/>
  </group>
  <group name="appcenteradmingroup">
    <member name="admin" id="admin"/>
  </group>
</basicRegistry>
```

This example shows a definition of users and groups in the `basicRegistry` of WebSphere Application Server Liberty. For more information about configuring

a user registry for WebSphere Application Server Liberty profile, see [Configuring a user registry for the Liberty profile](#).

2. Edit the `server.xml` file to define the **AppCenterPool** size.

```
<connectionManager id="AppCenterPool" minPoolSize="10" maxPoolSize="40"/>
```

3. In the `<dataSource>` element, define a reference to the connection manager:

```
<dataSource id="APPCNTR" jndiName="jdbc/AppCenterDS" connectionManagerRef="AppCenterPool"
...
/>
```

Configuring Apache Tomcat

You must configure the Java EE security roles for the Application Center on the Apache Tomcat web application server.

Before you begin

Review the definition of roles at “Configuring the Application Center after installation” on page 6-188.

Procedure

1. In the Apache Tomcat web application server, you configure the roles of **appcenteruser** and **appcenteradmin** in the `conf/tomcat-users.xml` file. The installation creates the following users:

```
<user username="appcenteradmin" password="admin" roles="appcenteradmin"/>
<user username="demo" password="demo" roles="appcenteradmin"/>
<user username="guest" password="guest" roles="appcenteradmin"/>
```

2. You can define the set of users as described in the Apache Tomcat documentation, [Realm Configuration HOW-TO](#).

Configuring properties of DB2 JDBC driver in WebSphere Application Server

Add some JDBC custom properties to avoid DB2 exceptions from a WebSphere Application Server that uses the IBM DB2 database.

About this task

When you use WebSphere Application Server with an IBM DB2 database, this exception could occur:

```
Invalid operation: result set is closed. ERRORCODE=-4470, SQLSTATE=null
```

To avoid such exceptions, you must add custom properties in WebSphere Application Server at the Application Center data source level.

Procedure

1. Log in to the WebSphere Application Server administration console.
2. Select **Resources > JDBC > Data sources > Application Center DataSource name > Custom properties** and click **New**.
3. In the **Name** field, enter **allowNextOnExhaustedResultSet**.
4. In the **Value** field, type **1**.
5. Change the type to `java.lang.Integer`.
6. Click **OK**.
7. Click **New**.
8. In the **Name** field, enter **resultSetHoldability**.

9. In the Value field, type 1.
10. Change the type to `java.lang.Integer`.
11. Click **OK** and save your changes.

Configuring WebSphere Application Server to support applications in public app stores

Configure WebSphere Application Server full profile and Liberty profile before access to public app stores through application links, because of the use of SSL connections.

The constraint imposed by the use of SSL connections requires the root certificates of public app stores to exist in the WebSphere truststore before you can use application links to access these public stores. The configuration requirement applies to both WebSphere Application Server full profile and Liberty profile.

The root certificate of Apple iTunes must be imported into the WebSphere truststore before you can use application links to iTunes.

To use application links to Apple iTunes, see “Configuring WebSphere Application Server to support applications in Apple iTunes.”

Configuring WebSphere Application Server to support applications in Apple iTunes

Configure WebSphere Application Server to enable links in the Application Center console to access applications in Apple iTunes.

About this task

Follow this procedure to import the root certificate of Apple iTunes into the WebSphere truststore. You must import this certificate before the Application Center can support links to applications stored in iTunes.

Procedure

1. Log in to the WebSphere Application Server console and navigate to **Security > SSL certificate and key management > Key stores and certificates > NodeDefaultTrustStore > Signer certificates**.
2. Click **Retrieve from port**.
3. In the **Host** field, enter `itunes.apple.com`.
4. In the **Port** field, enter 443.
5. In the **Alias** field, enter `itunes.apple.com`.
6. Click **Retrieve signer information**.
7. Click **OK** and save the configuration.

Configuring Liberty profile when IBM JDK is used

Configure Liberty profile to use default JSSE socket factories instead of SSL socket factories of WebSphere Application Server when IBM JDK is used.

Purpose

The purpose is to configure the IBM JDK SSL factories to be compatible with Liberty profile. This configuration is required only when IBM JDK is used. The configuration does not apply for use of Oracle JDK. By default, IBM JDK uses the

SSL socket factories of WebSphere Application Server. These factories are not supported by Liberty profile.

Exception when WebSphere Application Server SSL socket factories are used

If you use the IBM JDK of WebSphere Application Server, this exception could occur because this JDK uses SSL socket factories that are not supported by the Liberty profile. In this case, follow the requirements documented in Troubleshooting tips.

```
java.net.SocketException: java.lang.ClassNotFoundException:
Cannot find the specified class com.ibm.websphere.ssl.protocol.SSLSocketFactory
    at javax.net.ssl.DefaultSSLSocketFactory.a(SSLSocketFactory.java:11)
    at javax.net.ssl.DefaultSSLSocketFactory.createSocket(SSLSocketFactory.java:6)
    at com.ibm.net.ssl.www2.protocol.https.c.afterConnect(c.java:161)
    at com.ibm.net.ssl.www2.protocol.https.d.connect(d.java:36)
    at sun.net.www.protocol.http.HttpURLConnection.getInputStream(HttpURLConnection.java:1184)
    at java.net.HttpURLConnection.getResponseCode(HttpURLConnection.java:390)
    at com.ibm.net.ssl.www2.protocol.https.b.getResponseCode(b.java:75)
    at com.ibm.ws.jmx.connector.client.rest.internal.RESTBeanServerConnection.loadJMXServerInfo
(RESTBeanServerConnection.java:142)
    at com.ibm.ws.jmx.connector.client.rest.internal.RESTBeanServerConnection.<init>
(RESTBeanServerConnection.java:114)
    at com.ibm.ws.jmx.connector.client.rest.internal.Connector.connect(Connector.java:315)
    at com.ibm.ws.jmx.connector.client.rest.internal.Connector.connect(Connector.java:103)
```

Managing users with LDAP

Use the Lightweight Directory Access Protocol (LDAP) registry to manage users.

LDAP is a way to centralize the user management for multiple web applications in an LDAP Server that maintains a user registry. It can be used instead of specifying one by one the users for the security roles **appcenteradmin** and **appcenteruser**.

If you plan to use an LDAP registry with the Application Center, you must configure your WebSphere Application Server or your Apache Tomcat server to use an LDAP registry to authenticate users.

In addition to authentication of users, configuring the Application Center for LDAP also enables you to use LDAP to define the users and groups who can install mobile applications through the Application Center. The means of defining these users and groups is the Access Control List (ACL).

Since IBM Worklight V6.0, use the JNDI environment entries for defining LDAP configuration properties.

Expert users could configure the application servers to use LDAP authentication by using the methods that were documented in releases before IBM Worklight V6.0.

LDAP with WebSphere Application Server V7

Use LDAP to authenticate users and define the users and groups who can install mobile applications with the Application Center; you can use the JNDI environment or the VMM API to define the LDAP mapping

You use LDAP to define the roles **appcenteradmin** and **appcenteruser**. Then, you have two ways of defining LDAP mapping for WebSphere Application Server V7:

- By using the JNDI environment with a stand-alone LDAP configuration
- By using federated repositories with the Virtual Member Manager (VMM) API

Configuring LDAP authentication (WebSphere Application Server V7):

Define the users who can access the Application Center console and the users who can log in to the client by configuring LDAP as a stand-alone LDAP server or as a federated repository.

About this task

This procedure shows you how to use LDAP to define the roles **appcenteradmin** and **appcenteruser** in WebSphere Application Server V7.

Procedure

1. Log in to the WebSphere Application Server console.
2. In **Security > Global Security**, verify that administrative security and application security are enabled.
3. Select **Federated repositories** or **Standalone LDAP registry**.
4. Click **Configure**. For federated repositories, follow step 5. For stand-alone LDAP registry, follow step 6
5. **Option for federated repositories:** add the new repository and configure the required additional properties.
 - a. To add a new repository, click **Add Base entry to Realm**.
 - b. Specify the value of “Distinguished name of a base entry that uniquely identifies entries in the realm” and click **Add Repository**.
 - c. Select **LDAP Repository**.
 - d. Give this repository a name and enter the values required to connect to your LDAP server.
 - e. Under **Additional Properties**, click **LDAP entity types**.
 - f. Configure the **Group**, **OrgContainer**, and **PersonAccount** properties. These configuration details depend on your LDAP server.
6. **Option for stand-alone LDAP registry:** Configure access control (ACL) management. You can use JNDI properties for this configuration, but you cannot use VMM.
 - a. Enter the values of **General Properties**. These values depend on your LDAP server.
 - b. Under **Additional Properties**, click **Advanced Lightweight Directory Access Protocol (LDAP)** and configure the user and group filters and maps. These configuration details depend on your LDAP server.
7. Save the configuration, log out, and restart the server.
8. In the WebSphere Application Server console, map the security roles to users and groups.
 - a. In the **Configuration** tab, select **Applications > WebSphere Enterprise applications**.
 - b. Select “IBM_Application_Center_Services”.
 - c. In the **Configuration** tab, select **Details > Security role to user/group mapping**.
 - d. For **appcenteradmin** and **appcenteruser** roles, select **Map groups**. This selection enables you to select users and groups inside the WebSphere user repository, including LDAP users and groups. The selected users can access the Application Center as **appcenteradmin** or **appcenteruser**. You can also map the roles to **Special Subjects** “All authenticated in

application realm” to give everyone in the WebSphere user repository, including everyone registered in the LDAP registry, access to the Application Center.

9. Repeat the procedure described in step 8 on page 6-195 for **IBM_Application_Center_Console**. (Make sure that you select “IBM_Application_Center_Console” in step 8.b instead of “IBM_Application_Center_Services”).
10. Click **Save** to save your changes.

Configuring LDAP ACL management with JNDI (WebSphere Application Server V7):

Use LDAP to define the users and groups who can install mobile applications with the Application Center by using the JNDI environment.

About this task

Since IBM Worklight V6.0, two configuration approaches are available: the JNDI API or the Virtual Member Manager (VMM) API. This procedure shows you how to use the JNDI API to configure LDAP based on the federated repository configuration or with the stand-alone LDAP registry. Only the simple type of LDAP authentication is supported.

Procedure

1. Log in to the WebSphere Application Server console.
2. Select **Applications > Application Types > WebSphere enterprise applications**.
3. Click **IBM_Application_Center_Services**.
4. In the **Web Module Properties** section, select “Environment entries for Web modules”.
 - a. For the **ibm.appcenter.ldap.vmm.active** entry, assign the value “false”.
 - b. For the **ibm.appcenter.ldap.active** entry, assign the value “true”.
5. Continue to configure the remaining entries:
 - **ibm.appcenter.ldap.connectionURL**: LDAP connection URL.
 - **ibm.appcenter.ldap.user.base**: search base for users.
 - **ibm.appcenter.ldap.user.loginName**: LDAP login attribute.
 - **ibm.appcenter.ldap.user.displayName**: LDAP attribute for the user name to be displayed, for example, a person's full name.
 - **ibm.appcenter.ldap.group.base**: search base for groups.
 - **ibm.appcenter.ldap.group.name**: LDAP attribute for the group name.
 - **ibm.appcenter.ldap.group.uniquemember**: LDAP attribute that identifies the members of a group.
 - **ibm.appcenter.ldap.user.groupmembership**: LDAP attribute that identifies the groups that a user belongs to.
 - **ibm.appcenter.ldap.group.nesting**: management of nested groups. If nested groups are not managed, set the value to false.
 - **ibm.appcenter.ldap.cache.expiration.seconds**: delay in seconds before the LDAP cache expires. If no value is entered, the default value is 86400, which is equal to 24 hours.

Changes to users and groups on the LDAP server become visible to the Application Center after a delay, which is specified by **ibm.appcenter.ldap.cache.expiration.seconds**. The Application Center

maintains a cache of LDAP data and the changes only become visible after the cache expires. By default, the delay is 24 hours. If you do not want to wait for this delay to expire after changes to users or groups, you can call this command to clear the cache of LDAP data:

```
acdeploytool.sh -clearLdapCache -s serverurl -c context -u user -p password
```

See Using the stand-alone tool to clear the LDAP cache for details.

- a. Enter the value of each property.
 - b. Click **OK** and save the configuration.
6. **Option:** *If the LDAP external SASL authentication mechanism is required to bind to the LDAP server, configure the **ibm.appcenter.ldap.security.sasl** property, which defines the value of the security authentication mechanism. The value depends on the LDAP server; usually, it is set to "EXTERNAL".*
7. **Option:** *If security binding is required, follow this step.* Configure the following entries:
- **ibm.appcenter.ldap.security.binddn:** the distinguished name of the user permitted to search the LDAP directory.
 - **ibm.appcenter.ldap.security.bindpwd:** the password of the user permitted to search the LDAP directory. The password can be encoded with the "WebSphere PropFilePasswordEncoder" utility. Run the utility before you configure the **ibm.appcenter.ldap.security.bindpwd** custom property.
- a. Enter the value of each optional property and click **OK**. Set the value of the **ibm.appcenter.ldap.security.bindpwd** property to the encoded password generated by the "WebSphere PropFilePasswordEncoder" utility.
 - b. Save the configuration.
8. **Option:** *If LDAP referrals must be handled, follow this step.* Configure **ibm.appcenter.ldap.referral**: support of referrals by the JNDI API. • If no value is given, the JNDI API will not handle LDAP referrals. Possible values are:
- **ignore:** ignores referrals found in the LDAP server.
 - **follow:** automatically follows any referrals found in the LDAP server.
 - **throw:** causes an exception to occur for each referral found in the LDAP server.
- a. Enter the value of the property and click **OK**.
 - b. Save the configuration.
9. **Option:** *If users and groups are defined in the same subtree (the properties **ibm.appcenter.ldap.user.base** and **ibm.appcenter.ldap.group.base** have the same value), follow this step.* Configure the following entries:
- **ibm.appcenter.ldap.user.filter:** LDAP user search filter for the attribute of user login name. Use %v as the placeholder for the login name attribute.
 - **ibm.appcenter.ldap.group.filter:** LDAP group search filter. Use %v as the placeholder for the group attribute.
 - **ibm.appcenter.ldap.user.displayName.filter:** LDAP user search filter for the attribute of user display name. Use %v as the placeholder for the user display name attribute.
- a. Enter the value of each optional property and click **OK**.
 - b. Save the configuration.

Results

The following figure shows the values to assign to each property.

See “List of JNDI properties for the Application Center” on page 6-223 for a complete list of properties that you can set.

ApplicationCenterServices	ApplicationCenterServices-6.0.5.x-SNAPSHOT.war,WEB-INF/web.xml	ibm.appcenter.ldap.active	String	ACL management with LDAP (set to true to enable, set to false to disable)	<input type="text" value="true"/>
ApplicationCenterServices	ApplicationCenterServices-6.0.5.x-SNAPSHOT.war,WEB-INF/web.xml	ibm.appcenter.ldap.vmm.active	String	Use of the VMM API (Set to true to enable, set to false to disable)	<input type="text" value="false"/>
ApplicationCenterServices	ApplicationCenterServices-6.0.5.x-SNAPSHOT.war,WEB-INF/web.xml	ibm.appcenter.ldap.federated.active	String	Use of a federated registry in Liberty Profile (Set to true to enable, set to false to disable)	<input type="text" value="false"/>
ApplicationCenterServices	ApplicationCenterServices-6.0.5.x-SNAPSHOT.war,WEB-INF/web.xml	ibm.appcenter.ldap.referral	String	Management type of the LDAP referrals	<input type="text" value="follow"/>
ApplicationCenterServices	ApplicationCenterServices-6.0.5.x-SNAPSHOT.war,WEB-INF/web.xml	ibm.appcenter.ldap.connectionURL	String	LDAP connection URL	<input type="text" value="bluepages.ibm.com:389"/>
ApplicationCenterServices	ApplicationCenterServices-6.0.5.x-SNAPSHOT.war,WEB-INF/web.xml	ibm.appcenter.ldap.cache.expiration.seconds	String	Expiration of cached LDAP entries, in seconds. The default value is 86400 (i.e., 24h).	<input type="text"/>
ApplicationCenterServices	ApplicationCenterServices-6.0.5.x-SNAPSHOT.war,WEB-INF/web.xml	ibm.appcenter.ldap.user.base	String	Search base of users	<input type="text" value="ou=bluepages,o=ibm.com"/>
ApplicationCenterServices	ApplicationCenterServices-6.0.5.x-SNAPSHOT.war,WEB-INF/web.xml	ibm.appcenter.ldap.user.loginName	String	LDAP login attribute	<input type="text" value="mail"/>
ApplicationCenterServices	ApplicationCenterServices-6.0.5.x-SNAPSHOT.war,WEB-INF/web.xml	ibm.appcenter.ldap.user.displayName	String	LDAP attribute for the user name to be displayed	<input type="text" value="cn"/>
ApplicationCenterServices	ApplicationCenterServices-6.0.5.x-SNAPSHOT.war,WEB-INF/web.xml	ibm.appcenter.ldap.user.groupmembership	String	LDAP attribute that identifies the groups to which a user belongs	<input type="text" value="ibm-allGroups"/>
ApplicationCenterServices	ApplicationCenterServices-6.0.5.x-SNAPSHOT.war,WEB-INF/web.xml	ibm.appcenter.ldap.user.filter	String	LDAP user search filter for the login name (placeholder = %v)	<input type="text"/>
ApplicationCenterServices	ApplicationCenterServices-6.0.5.x-SNAPSHOT.war,WEB-INF/web.xml	ibm.appcenter.ldap.user.displayName.filter	String	LDAP user search filter for the display name (placeholder = %v)	<input type="text"/>
ApplicationCenterServices	ApplicationCenterServices-6.0.5.x-SNAPSHOT.war,WEB-INF/web.xml	ibm.appcenter.ldap.group.base	String	Search base of groups	<input type="text" value="ou=memberlist,o=ibm.com"/>

Figure 6-15. Environment entries and their values (LDAP and WebSphere Application Server V7)

Configuring LDAP ACL management with VMM (WebSphere Application Server V7):

Use LDAP to define the users and groups who can install mobile applications with the Application Center with the Virtual Member Manager (VMM) API.

About this task

Since IBM Worklight V6.0, two configuration approaches are available: the JNDI API or the VMM API. This procedure shows you how to use the VMM API to configure LDAP based on the federated repository configuration.

You must configure LDAP based on the federated repository configuration. The stand-alone LDAP registry is not supported.

Several different repositories, LDAP and non-LDAP, can be configured in the federated repository.

Procedure

1. Configure the attribute mapping. For users, the Application Center refers to these VMM attributes:

- **uid**: represents the user login name.
- **sn**: represents the full name of the user.

For groups, the Application Center refers only to the VMM attribute **cn**.

If VMM attributes are not identical to LDAP attributes, you must map the VMM attributes to the corresponding LDAP attributes.

In WebSphere Application Server V7, you cannot configure this mapping with the WebSphere Application Server console.

- Find in the file `{WAS_HOME}/profiles/{profileName}/config/cells/{cellName}/wim/config/wimconfig.xml` the section that contains the LDAP repository configuration with `id="your LDAP id"`:

```
<config:repositories xsi:type="config:LdapRepositoryType"
adapterClassName="com.ibm.ws.wim.adapter.ldap.LdapAdapter"
id="your LDAP id"....
```

Where your LDAP id is the user ID configured for you in the LDAP repository.

- In this section, after the element **<config:attributeConfiguration>**, add these entries:

```
<config:attributes name="your LDAP attribute for the user full name" propertyName="sn">
  <config:entityTypes>PersonAccount</config:entityTypes>
</config:attributes>
<config:attributes name="your LDAP attribute for the user login name " propertyName="uid">
  <config:entityTypes>PersonAccount</config:entityTypes>
</config:attributes>
```

- Save the file and restart the server.

- Configure the Application Center for ACL management with LDAP. In WebSphere Application Server V7, only a WebSphere administrator user can run VMM access. (VMM roles are only supported by WebSphere Application Server V8.)

You must define these properties:

- `ibm.appcenter.ldap.active = true`.
- `ibm.appcenter.ldap.vmm.active = true`.
- `ibm.appcenter.ldap.vmm.adminuser = WebSphere administrator user`.
- `ibm.appcenter.ldap.vmm.adminpwd = WebSphere administrator password`. The password can be encoded or not.
- `ibm.appcenter.ldap.cache.expiration.seconds = :` the delay in seconds before the LDAP cache expires. If no value is entered, the default value is 86400, which is equal to 24 hours.

Note: See “List of JNDI properties for the Application Center” on page 6-223 for a complete list of properties that you can set

Changes to users and groups on the LDAP server become visible to the Application Center after a delay, which is specified by **ibm.appcenter.ldap.cache.expiration.seconds**. The Application Center maintains a cache of LDAP data and the changes only become visible after the cache expires. By default, the delay is 24 hours. If you do not want to wait for this delay to expire after changes to users or groups, you can call this command to clear the cache of LDAP data:

```
acdeploytool.sh -clearLdapCache -s serverurl -c context -u user -p password
```

See Using the stand-alone tool to clear the LDAP cache for details.

See “List of JNDI properties for the Application Center” on page 6-223 for a complete list of properties that you can set.

- Log in to the WebSphere Application Server console.

- b. Select **Applications > Application Types > WebSphere enterprise applications**.
 - c. In the “Web Module Properties” section, select **IBM_Application_Center_Services** and then select **Environment entries for Web modules**.
 - d. Set the values for the properties.
 - e. Click **OK** and save the configuration. The application is automatically restarted.
3. **Optional:** Encode the password with the **PropFilePasswordEncoder** utility.
- a. Create a file `pwd.txt` that contains the entry `adminpwd=your clear password`, where your clear password is the unencoded administrator password.
 - b. Run this command:

```
{WAS_HOME}/profiles/profile name/bin/PropFilePasswordEncoder "file path/ pwd.txt" adminpwd
```
 - c. Open the `pwd.txt` file and copy the encoded password into the value of the **`ibm.appcenter.ldap.vmm.adminpwd`** property.

LDAP with WebSphere Application Server V8.x

LDAP authentication is achieved based on the federated repository configuration. ACL management configuration of the Application Center uses the Virtual Member Manager API.

You must configure LDAP based on the federated repository configuration. The stand-alone LDAP registry is not supported.

Several different repositories, LDAP and non-LDAP, can be configured in the federated repository.

For information about configuring federated repositories, see the WebSphere Application Server V8.0 user documentation or the WebSphere Application Server V8.5 user documentation, depending on your version.

Configuration of the Application Center for ACL management with LDAP

Some configuration details of ACL management are specific to the Application Center, because it uses the Virtual Member Manager (VMM) API.

The Application Center refers to these VMM attributes for users:

- uid** represents the user login name.
- sn** represents the full name of the user.

For groups, the Application Center refers only to the VMM attribute **cn**.

If VMM attributes are not identical in LDAP, you must map the VMM attributes to the corresponding LDAP attributes.

Configuring LDAP authentication (WebSphere Application Server V8.x):

Use LDAP to define users who can access the Application Center console and users who can log in to the client.

About this task

You can configure LDAP based on the federated repository configuration only. This procedure shows you how to use LDAP to define the roles **appcenteradmin** and **appcenteruser** in WebSphere Application Server V8.x.

Procedure

1. Log in to the WebSphere Application Server console.
2. Select **Security > Global security** and verify that administrative security and application security are enabled.
3. In the “User account repository” section, select **Federated repositories**.
4. Click **Configure**.
5. Add a new repository and configure the required repository.
 - a. Click **Add Base entry to Realm**.
 - b. Specify the value of “Distinguished name of a base entry that uniquely identifies entries in the realm” and click **Add Repository**.
 - c. Select **LDAP Repository**.
 - d. Give this repository a name and enter the values required to connect to your LDAP server.
 - e. Under **Additional Properties**, click **LDAP entity types**.
 - f. Configure the **Group**, **OrgContainer**, and **PersonAccount** properties. These configuration details depend on your LDAP server.
6. Save the configuration, log out, and restart the server.
7. In the WebSphere Application Server console, map the security roles to users and groups.
 - a. In the **Configuration** tab, select **Applications > WebSphere Enterprise applications**.
 - b. Select “IBM_Application_Center_Services”.
 - c. In the **Configuration** tab, select **Details > Security role to user/group mapping**.
 - d. For **appcenteradmin** and **appcenteruser** roles, select **Map groups**. This selection enables you to select users and groups inside the WebSphere user repository, including LDAP users and groups. The selected users can access the Application Center as **appcenteradmin** or **appcenteruser**. You can also map the roles to **Special Subjects** “All authenticated in application realm” to give everyone in the WebSphere user repository, including everyone registered in the LDAP registry, access to the Application Center.
8. Repeat the procedure described in step 7 for **IBM_Application_Center_Console**. (Make sure that you select “IBM_Application_Center_Console” in step 7.b instead of “IBM_Application_Center_Services”.)
9. Click **Save** to save your changes.

What to do next

You must enable ACL management with LDAP. See “Configuring LDAP ACL management (WebSphere Application Server V8.x).”

Configuring LDAP ACL management (WebSphere Application Server V8.x):

Use LDAP to define the users and groups who can install mobile applications with the Application Center with the Virtual Member Manager (VMM) API.

About this task

To configure ACL with LDAP, you should define three properties: **uid**, **sn**, and **cn**. These properties enable the login name and the full name of users and the name of user groups to be identified in the Application Center.

Then you should enable ACL management with VMM. You can configure LDAP based on the federated repository configuration only.

Procedure

1. Log in to the WebSphere Application Server console.
2. Select **Security > Global security**.
3. In the “User account repository” section, select **Configure**.
4. Select your LDAP repository entry.
5. Under **Additional Properties**, select **LDAP attributes** (WebSphere Application Server V8.0) or **Federated repositories property names to LDAP attributes mapping** (WebSphere Application Server V8.5).
6. Select **Add > Supported**.
7. Enter these property values:
 - a. For **Name** enter your LDAP login attribute.
 - b. For **Property name** enter **uid**.
 - c. For **Entity types** enter the LDAP entity type.
 - d. Click **OK**.

The screenshot shows the 'General Properties' dialog box for configuring LDAP attributes. The breadcrumb path is 'Global security > Federated repositories > AppCenter > LDAP attributes > mail'. The dialog contains the following fields: 'Name' (mail), 'Property name' (uid), 'Syntax', 'Entity types' (PersonAccount), 'Default value', and 'Default attribute'. At the bottom are 'Apply', 'OK', 'Reset', and 'Cancel' buttons.

Figure 6-16. Associating LDAP login with uid property (WebSphere Application Server V8.0)

8. Select **Add > Supported**.
 - a. For **Name** enter your LDAP attribute for full user name.
 - b. For **Property name** enter **sn**.
 - c. For **Entity types** enter the LDAP entity type.
 - d. Click **OK**.

The screenshot shows the 'General Properties' dialog box for configuring LDAP attributes. The breadcrumb path is 'Global security > Federated repositories > AppCenter > LDAP attributes > cn'. The dialog contains the following fields: 'Name' (cn), 'Property name' (sn), 'Syntax', 'Entity types' (PersonAccount), 'Default value', and 'Default attribute'. At the bottom are 'Apply', 'OK', 'Reset', and 'Cancel' buttons.

Figure 6-17. Associating LDAP full user name with sn property (WebSphere Application Server V8.0)

9. Select **Add > Supported** to configure a group name:

- a. For **Name** enter the LDAP attribute for your group name.
 - b. For **Property name** enter **cn**.
 - c. For **Entity types** enter the LDAP entity type.
 - d. Click **OK**.
10. Enable ACL management with LDAP:
- a. Select **Servers > Server Types > WebSphere application servers**.
 - b. Select the appropriate application server.
In a clustered environment you must configure all the servers in the cluster in the same way.
 - c. In the **Configuration** tab, under “Server Infrastructure”, click the **Java and Process Management** tab and select **Process definition**.
 - d. In the **Configuration** tab, under “Additional Properties”, select **Java Virtual Machine**.
 - e. In the **Configuration** tab, under “Additional Properties”, select **Custom properties**.
 - f. Enter the required property-value pairs in the form. To enter each pair, click **New**, enter the property and its value, and click **OK**.

Property-value pairs:

- `ibm.appcenter.ldap.vmm.active = true`
- `ibm.appcenter.ldap.active = true`
- `ibm.appcenter.ldap.cache.expiration.seconds = delay_in_seconds`

Enter the delay in seconds before the LDAP cache expires. If you do not enter a value, the default value is 86400, which is equal to 24 hours.

Changes to users and groups on the LDAP server become visible to the Application Center after a delay, which is specified by **ibm.appcenter.ldap.cache.expiration.seconds**. The Application Center maintains a cache of LDAP data and the changes only become visible after the cache expires. By default, the delay is 24 hours. If you do not want to wait for this delay to expire after changes to users or groups, you can call this command to clear the cache of LDAP data:

```
acdeploytool.sh -clearLdapCache -s serverurl -c context -u user -p password
```

See Using the stand-alone tool to clear the LDAP cache for details.

Results

The following figure shows an example of custom properties with the correct settings.

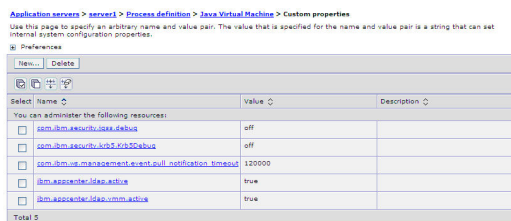

Figure 6-18. ACL management for Application Center with LDAP on WebSphere Application Server V8

What to do next

Save the configuration and restart the server.

To use the VMM API, you must assign the “IdMgrReader” role to the users who run the VMM code, or to the group owners of these users. You must assign this role to all users and groups who have the roles of “appcenteruser” or “appcenteradmin”.

In the `<was_home>\bin` directory, where `<was_home>` is the home directory of your WebSphere Application Server, run the **wsadmin** command.

After connecting with the WebSphere Application Server administrative user, run the following command:

```
$AdminTask mapIdMgrGroupToRole {-roleName IdMgrReader -groupId your_LDAP_group_id}
```

Run the same command for all the groups mapped to the roles of “appcenteruser” and “appcenteradmin”.

For individual users who are not members of groups, run the following command:

```
$AdminTask mapIdMgrUserToRole {-roleName IdMgrReader -userId your_LDAP_user_id}
```

You can assign the special subject “All Authenticated in Application's Realm” as roles for **appcenteruser** and **appcenteradmin**. If you choose to assign this special subject, **IdMgrReader** must be configured in the following way:

```
$AdminTask mapIdMgrGroupToRole {-roleName IdMgrReader -groupId ALLAUTHENTICATED}
```

Enter **exit** to end **wsadmin**.

LDAP with Liberty profile

Use LDAP to authenticate users and to define the users and groups who can install mobile applications with the Application Center by using the JNDI environment.

Using LDAP with Liberty profile requires you to configure LDAP authentication and LDAP ACL management.

Configuring LDAP authentication (Liberty profile):

You configure LDAP authentication by defining one or more LDAP registries in the `server.xml` file and you map LDAP users and groups to Application Center roles.

About this task

You can configure LDAP authentication of users and groups in the `server.xml` file by defining an LDAP registry or, since WebSphere Application Server Liberty profile V8.5.5, a federated registry that uses several LDAP registries. Then you map users and groups to Application Center roles. The mapping configuration is the same for LDAP authentication and basic authentication.

Procedure

1. To open the `server.xml` descriptor file, enter `{server.config.dir}/server.xml`
2. Insert one or several LDAP registry definitions after the `<httpEndpoint>` element.

Example for the LDAP registry:

```
<ldapRegistry baseDN="o=ibm.com" host="employees.com" id="Employees"
  ldapType="IBM Tivoli Directory Server" port="389" realm="AppCenterLdap"
  recursiveSearch="true">
  <idsFilters
    groupFilter="(&(cn=%v)(|(objectclass=groupOfNames)(objectclass=groupOfUniqueNames)))"
    id="Employees"
```

```

        userFilter="(& (emailAddress=%v) (objectClass=ibmPerson))"
        groupMemberIdMap="ibm-allGroups:member;ibm-allGroups:uniqueMember"
        userIdMap="*:emailAddress"/>
</ldapRegistry>

```

For information about the parameters used in this example, see the WebSphere Application Server V8.5 user documentation.

3. Insert a security role definition after each Application Center application definition (**applicationcenter** and **appcenterconsole**).

Example for security role definition: this example includes two sets of sample code that show how to code when the group names are unique within LDAP and how to code when the group names are not unique within LDAP.

Group names unique within LDAP

This sample code shows how to use the group names **ldapGroupForAppcenteruser** and **ldapGroupForAppcenteradmin** when they exist and are unique within LDAP.

```

<application-bnd>
  <security-role name="appcenteruser" id="appcenteruser">
    <group name="ldapGroupForAppcenteruser" />
  </security-role>
  <security-role name="appcenteradmin" id="appcenteradmin">
    <group name="ldapGroupForAppcenteradmin" />
  </security-role>
</application-bnd>

```

Group names not unique within LDAP

This sample code shows how to code the mapping when the group names are not unique within LDAP. The groups must be specified with the **access-id** attribute.

```

<application-bnd>
  <security-role name="appcenteruser" id="appcenteruser">
    <group name="ldapGroup"
      id="ldapGroup"
      access-id="group:AppCenterLdap/CN=ldapGroup,OU=myorg,
        DC=mydomain,DC=AD,DC=myco,DC=com"/>
  </security-role>
  ...
</application-bnd>

```

The **access-id** attribute must refer to the realm name used to specify the LDAP realm. In this sample code, the realm name is **AppCenterLdap**. The remainder of the **access-id** attribute specifies one of the LDAP groups named **ldapGroup** in a way that makes it unique.

If required, use similar code to map the **appcenteradmin** role.

Configuring LDAP ACL management (Liberty profile):

Use LDAP to define the users and groups who can install mobile applications through the Application Center. The means of defining these users and groups is the Access Control List (ACL).

Purpose

To enable ACL management with LDAP. You enable ACL management after you configure LDAP and map users and groups to Application Center roles. Only the simple type of LDAP authentication is supported.

Properties

To be able to define JNDI entries, the following feature must be defined in the `server.xml` file:

```
<feature>jndi-1.0</feature>
```

Add an entry for each property in the `<server>` section of the `server.xml` file. This entry should have the following syntax:

```
<jndiEntry jndiName="JNDI_property_name" value="property_value"/>
```

Where:

`JNDI_property_name` is the name of the property you are adding.

`property_value` is the value of the property you are adding.

Table 6-52. JNDI properties for configuring ACL management with LDAP in the `server.xml` file

Property	Description
<code>ibm.appcenter.ldap.active</code>	Set to true to enable LDAP; set to false to disable LDAP.
<code>ibm.appcenter.ldap.federated.active</code>	Since WebSphere Application Server Liberty profile V8.5.5: set to true to enable use of the federated registry; set to false to disable use of the federated registry, which is the default setting.
<code>ibm.appcenter.ldap.connectionURL</code>	LDAP connection URL.
<code>ibm.appcenter.ldap.user.base</code>	Search base of users.
<code>ibm.appcenter.ldap.user.loginName</code>	LDAP login attribute.
<code>ibm.appcenter.ldap.user.displayName</code>	LDAP attribute for the user name to be displayed, for example, a person's full name.
<code>ibm.appcenter.ldap.group.base</code>	Search base of groups.
<code>ibm.appcenter.ldap.group.name</code>	LDAP attribute for the group name.
<code>ibm.appcenter.ldap.group.uniquemember</code>	LDAP attribute that identifies the members of a group.
<code>ibm.appcenter.ldap.user.groupmembership</code>	LDAP attribute that identifies the groups to which a user belongs.
<code>ibm.appcenter.ldap.group.nesting</code>	Management of nested groups: if nested groups are not managed, set the value to false.
<code>ibm.appcenter.ldap.user.filter</code>	LDAP user search filter for the attribute of user login name. Use <code>%v</code> as the placeholder for the login name attribute. This property is only required when LDAP users and groups are defined in the same subtree; that is, when the properties <code>ibm.appcenter.ldap.user.base</code> and <code>ibm.appcenter.ldap.group.base</code> have the same value.
<code>ibm.appcenter.ldap.displayName.filter</code>	LDAP user search filter for the attribute of user display name. Use <code>%v</code> as the placeholder for the display name attribute. This property is only required when LDAP users and groups are defined in the same subtree; that is, when the properties <code>ibm.appcenter.ldap.user.base</code> and <code>ibm.appcenter.ldap.group.base</code> have the same value.

Table 6-52. JNDI properties for configuring ACL management with LDAP in the `server.xml` file (continued)

Property	Description
<code>ibm.appcenter.ldap.group.filter</code>	<p>LDAP group search filter. Use <code>%v</code> as the placeholder for the group attribute.</p> <p>This property is only required when LDAP users and groups are defined in the same subtree; that is, when the properties <code>ibm.appcenter.ldap.user.base</code> and <code>ibm.appcenter.ldap.group.base</code> have the same value.</p>
<code>ibm.appcenter.ldap.security.sasl</code>	<p>The value of the security authentication mechanism when the LDAP external SASL authentication mechanism is required to bind to the LDAP server. The value depends on the LDAP server; usually, it is set to "EXTERNAL".</p>
<code>ibm.appcenter.ldap.security.binddn</code>	<p>Property that identifies the distinguished name of the user permitted to search the LDAP directory. Use this property only if security binding is required.</p>
<code>ibm.appcenter.ldap.security.bindpwd</code>	<p>Property that identifies the password of the user permitted to search the LDAP directory. Use this property only if security binding is required.</p> <p>The password can be encoded with the "Liberty profile securityUtility" tool. Run the tool and then set the value of this property to the encoded password generated by the tool. The supported encoding types are xor and aes.</p> <p>Edit the Liberty profile <code>server.xml</code> file to check whether the <code>classloader</code> is enabled to load the JAR file that decodes the password.</p>
<code>ibm.appcenter.ldap.cache.expiration.seconds</code>	<p>Delay in seconds before the LDAP cache expires. If no value is entered, the default value is 86400, which is equal to 24 hours.</p> <p>Changes to users and groups on the LDAP server become visible to the Application Center after a delay, which is specified by <code>ibm.appcenter.ldap.cache.expiration.seconds</code>. The Application Center maintains a cache of LDAP data and the changes only become visible after the cache expires. By default, the delay is 24 hours. If you do not want to wait for this delay to expire after changes to users or groups, you can call this command to clear the cache of LDAP data:</p> <pre>acdeploytool.sh -clearLdapCache -s serverurl -c context -u user -p password</pre> <p>See Using the stand-alone tool to clear the LDAP cache for details.</p>
<code>ibm.appcenter.ldap.referral</code>	<p>Property that indicates whether referrals are supported by the JNDI API. If no value is given, the JNDI API will not handle LDAP referrals. Possible values are:</p> <ul style="list-style-type: none"> <code>ignore</code>: ignores referrals found in the LDAP server. <code>follow</code>: automatically follows any referrals found in the LDAP server. <code>throw</code>: causes an exception to occur for each referral found in the LDAP server.

See “List of JNDI properties for the Application Center” on page 6-223 for a complete list of LDAP properties that you can set.

Example of setting properties for ACL management with LDAP

This example shows the settings of the properties in the `server.xml` file required for ACL management with LDAP.

```
<jndiEntry jndiName="ibm.appcenter.ldap.active" value="true"/>
<jndiEntry jndiName="ibm.appcenter.ldap.connectionURL" value="ldap://employees.com:636"/>
<jndiEntry jndiName="ibm.appcenter.ldap.user.loginName" value="uid"/>
<jndiEntry jndiName="ibm.appcenter.ldap.user.base" value="dc=ibm,dc=com"/>
<jndiEntry jndiName="ibm.appcenter.ldap.group.base" value="dc=ibm,dc=com"/>
<jndiEntry jndiName="ibm.appcenter.ldap.user.displayName" value="sn"/>
<jndiEntry jndiName="ibm.appcenter.ldap.group.name" value="cn"/>
<jndiEntry jndiName="ibm.appcenter.ldap.group.uniquemember" value="uniqueMember"/>
<jndiEntry jndiName="ibm.appcenter.ldap.user.groupmembership" value="ibm-allGroups"/>
<jndiEntry jndiName="ibm.appcenter.ldap.cache.expiration.seconds" value="43200"/>
<jndiEntry jndiName="ibm.appcenter.ldap.security.sasl" value="'EXTERNAL'"/>
<jndiEntry jndiName="ibm.appcenter.ldap.referral" value="'follow'"/>
<jndiEntry jndiName="ibm.appcenter.ldap.user.filter" value="'(&uid=%v)(objectclass=inetOrgPerson)'" />
<jndiEntry jndiName="ibm.appcenter.ldap.user.displayName.filter" value="'(&cn=%v)(objectclass=inetOrgPerson)'" />
<jndiEntry jndiName="ibm.appcenter.ldap.group.filter" value="'(&cn=%v)(|(objectclass=groupOfNames)(objectclass=groupOfUniqueNames))'" />
```

LDAP with Apache Tomcat

Configure the Apache Tomcat server for LDAP authentication and configure security (Java™ Platform, Enterprise Edition) in the `web.xml` file of the Application Center.

To configure ACL management of the Application Center; configure LDAP for user authentication, map the Java Platform, Enterprise Edition (Java EE) roles of the Application Center to the LDAP roles, and configure the Application Center properties for LDAP authentication. Only the simple type of LDAP authentication is supported.

Configuring LDAP authentication (Apache Tomcat):

Define the users who can access the Application Center console and the users who can log in with the mobile client by mapping Java Platform, Enterprise Edition roles to LDAP roles.

Purpose

To configure ACL management of the Application Center; configure LDAP for user authentication, map the Java Platform, Enterprise Edition (Java EE) roles of the Application Center to the LDAP roles, and configure the Application Center properties for LDAP authentication. Only the simple type of LDAP authentication is supported.

You configure the Apache Tomcat server for LDAP authentication and configure security (Java™ Platform, Enterprise Edition) in the `web.xml` file of the Application Center Services web application (`applicationcenter.war`) and of the Application Center Console web application (`appcenterconsole.war`).

LDAP user authentication

You must configure a `JNDIRealm` in the `server.xml` file in the `<Host>` element. See the Realm Component on the Apache Tomcat website for more information about configuring a realm.

Example of configuration on Apache Tomcat to authenticate against an LDAP server

This example shows how to configure user authentication on an Apache Tomcat server by comparing with the authorization of these users on a server enabled for LDAP authentication.

```
<Host appBase="webapps" autoDeploy="true" name="localhost" unpackWARs="true">
  ...
  <Realm className="org.apache.catalina.realm.JNDIRealm"
    connectionURL="ldap://bluepages.ibm.com:389"
    userSubtree="true"
    userBase="ou=bluepages,o=ibm.com"
    userSearch="(emailAddress={0})"
    roleBase="ou=ibmgroups,o=ibm.com"
    roleName="cn"
    roleSubtree="true"
    roleSearch="(uniqueMember={0})"
    allRolesMode="authOnly"
    commonRole="appcenter"/>
  ...
</Host>
```

The value of **connectionURL** is the LDAP URL of your LDAP server.

The **userSubtree**, **userBase**, and **userSearch** attributes define how to use the name given to the Application Center in login form (in the browser message box) to match an LDAP user entry.

In the example, the definition of **userSearch** specifies that the user name is used to match the email address of an LDAP user entry.

The basis or scope of the search is defined by the value of the **userBase** attribute. In LDAP, an information tree is defined; the user base indicates a node in that tree.

The value of **userSubtree** should be set to `true`; if it is `false`, the search is performed only on the direct child nodes of the user base. It is important that the search penetrates the subtree and does not stop at the first level.

For authentication, you define only the **userSubtree**, **userBase**, and **userSearch** attributes. The Application Center also uses Java EE security roles. Therefore, you must map LDAP attributes to some Java EE roles. These attributes are used for mapping LDAP attributes to security roles:

- **roleBase**
- **roleName**
- **roleSubtree**
- **roleSearch**

In this example, the value of the **roleSearch** attribute matches all LDAP entries with a **uniqueMember** attribute whose value is the Distinguished Name (DN) of the authenticated user.

The **roleBase** attribute specifies a node in the LDAP tree below which the roles are defined.

The **roleSubtree** attribute indicates whether the LDAP search should search the entire subtree, whose root is defined by the value of **roleBase**, or only the direct child nodes.

The **roleName** attribute defines the name of the LDAP attribute.

The **allRolesMode** attribute specifies that you can use the asterisk (*) character as the value of **role-name** in the web.xml file. This attribute is optional.

The **commonRole** attribute adds a role shared by all authenticated users. This attribute is optional.

Mapping the Java EE roles of the Application Center to LDAP roles

After you define the LDAP request for the Java EE roles, you must change the web.xml file of the Application Center Services web application (applicationcenter.war) and of the Application Center Console web application (appcenterconsole.war) to map the Java EE roles of "appcenteradmin" and "appcenteruser" to the LDAP roles.

These examples, where LDAP users have LDAP roles called "MyLdapAdmin" and "MyLdapUser", show where and how to change the web.xml file.

The security-role-ref element in the JAX_RS servlet

```
<servlet>
  <servlet-name>MobileServicesServlet</servlet-name>
  <servlet-class>org.apache.wink.server.internal.servlet.RestServlet</servlet-class>
  <init-param>
    <param-name>javax.ws.rs.Application</param-name>
    <param-value>com.ibm.puremeap.services.MobileServicesServlet</param-value>
  </init-param>
  <load-on-startup>1</load-on-startup>
  <security-role-ref>
    <role-name>appcenteradmin</role-name>
    <role-link>MyLdapAdmin</role-link>
  </security-role-ref>
  <security-role-ref>
    <role-name>appcenteruser</role-name>
    <role-link>MyLdapUser</role-link>
  </security-role-ref>
</servlet>
```

The security-role element

```
<security-role>
  <role-name>MyLdapAdmin</role-name>
</security-role>
```

The auth-constraint element

After you edit the security-role-ref and the security-role elements, you can use the roles defined in the auth-constraint elements to protect the web resources. See the appcenteradminConstraint element and the appcenteruserConstraint element in this example for definition of the web resource collection to be protected by the role defined in the auth-constraint element.

```

<security-constraint>
  <display-name>appcenteruserConstraint</display-name>
  <web-resource-collection>
    <web-resource-name>appcenteruser</web-resource-name>
    <url-pattern>/installers.html</url-pattern>
    <url-pattern>/service/device/*</url-pattern>
    <url-pattern>/service/directory/*</url-pattern>
    <url-pattern>/service/plist/*</url-pattern>
    <url-pattern>/service/auth/*</url-pattern>
    <url-pattern>/service/application/*</url-pattern>
    <url-pattern>/service/desktop/*</url-pattern>
    <url-pattern>/service/principal/*</url-pattern>
    <url-pattern>/service/acl/*</url-pattern>
    <url-pattern>/service/userAndConfigInfo</url-pattern>
    <http-method>DELETE</http-method>
    <http-method>GET</http-method>
    <http-method>POST</http-method>
    <http-method>PUT</http-method>
    <http-method>HEAD</http-method>
  </web-resource-collection>
  <auth-constraint>
    <role-name>MyLdapUser</role-name>
  </auth-constraint>
  <user-data-constraint>
    <transport-guarantee>NONE</transport-guarantee>
  </user-data-constraint>
</security-constraint>

```

Configuring LDAP ACL management (Apache Tomcat):

Use LDAP to define the users and groups who can install mobile applications with the Application Center by defining the Application Center LDAP properties through JNDI.

Purpose

To configure LDAP ACL management of the Application Center; add an entry for each property in the <context> section of the IBM Application Center Services application in the server.xml file. This entry should have the following syntax:

```

<Environment name="JNDI_property_name" value="property_value" type="java.lang.String"
override="false"/>

```

Where:

JNDI_property_name is the name of the property you are adding.

property_value is the value of the property you are adding.

Table 6-53. Properties for configuring ACL management for LDAP in the server.xml file on Apache Tomcat

Property	Description
ibm.appcenter.ldap.active	Set to true to enable LDAP; set to false to disable LDAP.
ibm.appcenter.ldap.connectionURL	LDAP connection URL.
ibm.appcenter.ldap.user.base	Search base of users.
ibm.appcenter.ldap.user.loginName	LDAP login attribute.
ibm.appcenter.ldap.user.displayName	LDAP attribute for the user name to be displayed, for example, a person's full name.
ibm.appcenter.ldap.group.base	Search base of groups.

Table 6-53. Properties for configuring ACL management for LDAP in the `server.xml` file on Apache Tomcat (continued)

Property	Description
<code>ibm.appcenter.ldap.group.name</code>	LDAP attribute for the group name.
<code>ibm.appcenter.ldap.group.uniquemember</code>	LDAP attribute that identifies the members of a group.
<code>ibm.appcenter.ldap.user.groupmembership</code>	LDAP attribute that identifies the groups to which a user belongs.
<code>ibm.appcenter.ldap.group.nesting</code>	Management of nested groups: if nested groups are not managed, set the value to <code>false</code> .
<code>ibm.appcenter.ldap.user.filter</code>	<p>LDAP user search filter for the attribute of user login name. Use <code>%v</code> as the placeholder for the login name attribute.</p> <p>This property is only required when LDAP users and groups are defined in the same subtree; that is, when the properties <code>ibm.appcenter.ldap.user.base</code> and <code>ibm.appcenter.ldap.group.base</code> have the same value.</p>
<code>ibm.appcenter.ldap.displayName.filter</code>	<p>LDAP user search filter for the attribute of user display name. Use <code>%v</code> as the placeholder for the display name attribute.</p> <p>This property is only required when LDAP users and groups are defined in the same subtree; that is, when the properties <code>ibm.appcenter.ldap.user.base</code> and <code>ibm.appcenter.ldap.group.base</code> have the same value.</p>
<code>ibm.appcenter.ldap.group.filter</code>	<p>LDAP group search filter. Use <code>%v</code> as the placeholder for the group attribute.</p> <p>This property is only required when LDAP users and groups are defined in the same subtree; that is, when the properties <code>ibm.appcenter.ldap.user.base</code> and <code>ibm.appcenter.ldap.group.base</code> have the same value.</p>
<code>ibm.appcenter.ldap.security.sasl</code>	The value of the security authentication mechanism when the LDAP external SASL authentication mechanism is required to bind to the LDAP server. The value depends on the LDAP server; usually, it is set to "EXTERNAL".
<code>ibm.appcenter.ldap.security.binddn</code>	Property that identifies the distinguished name of the user permitted to search the LDAP directory. Use this property only if security binding is required.
<code>ibm.appcenter.ldap.security.bindpwd</code>	Property that identifies the password of the user permitted to search the LDAP directory. Use this property only if security binding is required.

Table 6-53. Properties for configuring ACL management for LDAP in the `server.xml` file on Apache Tomcat (continued)

Property	Description
<code>ibm.appcenter.ldap.cache.expiration.seconds</code>	<p>Delay in seconds before the LDAP cache expires. If no value is entered, the default value is 86400, which is equal to 24 hours.</p> <p>Changes to users and groups on the LDAP server become visible to the Application Center after a delay, which is specified by <code>ibm.appcenter.ldap.cache.expiration.seconds</code>. The Application Center maintains a cache of LDAP data and the changes only become visible after the cache expires. By default, the delay is 24 hours. If you do not want to wait for this delay to expire after changes to users or groups, you can call this command to clear the cache of LDAP data:</p> <pre>acdeploytool.sh -clearLdapCache -s serverurl -c context -u user -p password</pre> <p>See Using the stand-alone tool to clear the LDAP cache for details.</p>
<code>ibm.appcenter.ldap.referral</code>	<p>Property that indicates whether referrals are supported by the JNDI API. If no value is given, the JNDI API will not handle LDAP referrals. Possible values are:</p> <ul style="list-style-type: none"> • <code>ignore</code>: ignores referrals found in the LDAP server. • <code>follow</code>: automatically follows any referrals found in the LDAP server. • <code>throw</code>: causes an exception to occur for each referral found in the LDAP server.

See “List of JNDI properties for the Application Center” on page 6-223 for a complete list of LDAP properties that you can set.

The example shows properties defined in the `server.xml` file.

```
<Environment name="ibm.appcenter.ldap.active" value="true"
type="java.lang.String" override="false"/>
<Environment name="ibm.appcenter.ldap.connectionURL" value="ldaps://employees.com:636" type="java.lang.String"
override="false"/>
<Environment name="ibm.appcenter.ldap.user.base" value="dc=ibm,dc=com" type="java.lang.String" override="false"/>
<Environment name="ibm.appcenter.ldap.user.loginName" value="uid" type="java.lang.String" override="false"/>
<Environment name="ibm.appcenter.ldap.user.displayName" value="cn" type="java.lang.String" override="false"/>
<Environment name="ibm.appcenter.ldap.user.groupmembership" value="ibm-allGroups" type="java.lang.String" override="false"/>
<Environment name="ibm.appcenter.ldap.group.base" value="dc=ibm,dc=com" type="java.lang.String" override="false"/>
<Environment name="ibm.appcenter.ldap.group.name" value="cn" type="java.lang.String" override="false"/>
<Environment name="ibm.appcenter.ldap.group.uniquemember" value="uniquemember" type="java.lang.String" override="false"/>
<Environment name="ibm.appcenter.ldap.cache.expiration.seconds" value="43200" type="java.lang.String" override="false"/>
<Environment name="ibm.appcenter.ldap.security.sasl" value="EXTERNAL" type="java.lang.String" override="false"/>
<Environment name="ibm.appcenter.ldap.security.referral" value="follow" type="java.lang.String" override="false"/>
<Environment name="ibm.appcenter.ldap.user.filter" value="(&!(uid=%v)(objectclass=inetOrgPerson))"
type="java.lang.String" override="false"/>
<Environment name="ibm.appcenter.ldap.user.displayName.filter" value="(&(cn=%v)(objectclass=inetOrgPerson))"
type="java.lang.String" override="false"/>
<Environment name="ibm.appcenter.ldap.group.filter" value="(&(cn=%v){!(objectclass=groupOfNames)(objectclass=groupOfUniqueNames)})"
type="java.lang.String" override="false"/>
```

Defining the endpoint of the application resources

When you add a mobile application from the Application Center console, the server-side component creates Uniform Resource Identifiers (URI) for the application resources (package and icons). The mobile client uses these URI to manage the applications on your device.

Purpose

To manage the applications on your device, the Application Center console must be able to locate the Application Center REST services and to generate the required number of URI that enable the mobile client to find the Application Center REST services.

By default, the URI protocol, host name, and port are the same as those defined in the web application server used to access the Application Center console; the context root of the Application Center REST services is `applicationcenter`. When the context root of the Application Center REST services is changed or when the internal URI of the web application server is different from the external URI that can be used by the mobile client, the externally accessible endpoint (protocol, host name, and port) of the application resources must be defined by configuring the web application server. (Reasons for separating internal and external URI could be, for example, a firewall or a secured reverse proxy that uses HTTP redirection.)

The following figure shows a configuration with a secured reverse proxy that hides the internal address (192.168...). The mobile client must use the external address (`appcntr.net`).



Figure 6-19. Configuration with secured reverse proxy

Table 6-54. The endpoint properties

Property name	Purpose	Example
<code>ibm.appcenter.services.endpoint</code>	<p>This property enables the Application Center console to locate the Application Center REST services. The value of this property must be specified as the external address and context root of the <code>applicationcenter.war</code> web application. You can use the asterisk (*) character as wildcard to specify that the Application Center REST services use the same value as the Application Center console. For example: <code>*://*/*/appcenter</code> means use the same protocol, host, and port as the Application Center console, but use <code>appcenter</code> as context root.</p> <p>This property must be specified for the Application Center console application.</p>	<code>https://appcntr.net:443/applicationcenter</code>
<code>ibm.appcenter.proxy.protocol</code>	This property specifies the protocol required for external applications to connect to the Application Center.	<code>https</code>
<code>ibm.appcenter.proxy.host</code>	This property specifies the host name required for external applications to connect to the Application Center.	<code>appcntr.net</code>
<code>ibm.appcenter.proxy.port</code>	This property specifies the port required for external applications to connect to the Application Center.	<code>443</code>

See “List of JNDI properties for the Application Center” on page 6-223 for a complete list of endpoint properties that you can set.

Configuring the endpoint of the application resources (full profile)

For the WebSphere Application Server full profile, configure the endpoint of the application resources in the environment entries of the Application Center services and the Application Center console applications.

About this task

Follow this procedure when you must change the URI protocol, host name, and port used by the mobile client to manage the applications on your device. Since IBM Worklight V6.0, you use the JNDI environment entries.

Procedure

1. Log in to the WebSphere Application Server console.
2. Select **Applications > Application Types > WebSphere enterprise applications**.
3. Click **IBM Application Center Services**.
4. In the “Web Module Properties” section, select **Environment entries for Web modules**.

5. Assign the appropriate values for the following environment entries:
 - a. For **ibm.appcenter.proxy.host**, assign the host name.
 - b. For **ibm.appcenter.proxy.port**, assign the port number.
 - c. For **ibm.appcenter.proxy.protocol**, assign the external protocol.
 - d. Click **OK** and save the configuration.
6. Select **Applications > Application Types > WebSphere enterprise applications**.
7. Click **IBM Application Center Console**.
8. In the “Web Module Properties” section, select **Environment entries for Web modules**.
9. For **ibm.appcenter.services.endpoint**, assign the full URI of the Application Center REST services (the URI of the `applicationcenter.war` file).
 - In a scenario with a firewall or a secured reverse proxy, this URI must be the external URI and not the internal URI inside the local LAN.
 - You can use the asterisk (*) character as wildcard to specify that the Application Center REST services use the same value as the Application Center console. For example: `*://*:*/*appcenter` means use the same protocol, host, and port as the Application Center console, but use `appcenter` as context root.
10. Click **OK** and save the configuration. For a complete list of JNDI properties that you can set, see “List of JNDI properties for the Application Center” on page 6-223.

Configuring the endpoint of the application resources (Liberty profile)

For the Liberty profile, configure the endpoint of the application resources through the JNDI environment.

Purpose

Since IBM Worklight V6.0, follow this procedure when you must change the URI protocol, host name, and port used by the Application Center client to manage the applications on your device.

Properties

Edit the `server.xml` file. To be able to define JNDI entries, the **<feature>** element must be defined correctly in the `server.xml` file:

```
<feature>jndi-1.0</feature>
```

Add an entry for each property in the `<server>` section of the `server.xml` file. This entry should have the following syntax:

```
<jndiEntry jndiName="JNDI_property_name" value="property_value"/>
```

Where:

`JNDI_property_name` is the name of the property you are adding.

`property_value` is the value of the property you are adding.

Table 6-55. Properties in the `server.xml` file for configuring the endpoint of the application resources

Property	Description
<code>ibm.appcenter.services.endpoint</code>	The URI of the Application Center REST services (<code>applicationcenter.war</code>). In a scenario with a firewall or a secured reverse proxy, this URI must be the external URI and not the internal URI inside the local LAN.
<code>ibm.appcenter.proxy.protocol</code>	The protocol of the application resources URI. This property is optional. It is only needed if the protocol of the external and of the internal URI are different.
<code>ibm.appcenter.proxy.host</code>	The host name of the application resources URI.
<code>ibm.appcenter.proxy.port</code>	The port of the application resources URI. This property is optional. It is only needed if the protocol of the external and of the internal URI are different.

For a complete list of LAPD properties that you can set, see “List of JNDI properties for the Application Center” on page 6-223.

Example of setting properties for configuring the endpoint

This example shows the settings of the properties in the `server.xml` file required for configuring the endpoint of the application resources.

```
<jndiEntry jndiName="ibm.appcenter.services.endpoint" value=" https://appcntr.net:443/applicationcenter" />  
<jndiEntry jndiName="ibm.appcenter.proxy.protocol" value="https" />  
<jndiEntry jndiName="ibm.appcenter.proxy.host" value="appcntr.net" />  
<jndiEntry jndiName="ibm.appcenter.proxy.port" value=" 443"/>
```

You can use the asterisk (*) character as wildcard to specify that the Application Center REST services use the same value as the Application Center console. For example: `*://*:*/*/appcenter` means use the same protocol, host, and port as the Application Center console, but use `appcenter` as context root.

Configuring the endpoint of the application resources (Apache Tomcat)

For the Apache Tomcat server, configure the endpoint of the application resources in the `server.xml` file.

Purpose

Since IBM Worklight V6.0, follow this procedure when you must change the URI protocol, host name, and port used by the Application Center client to manage the applications on your device.

Properties

Edit the `server.xml` file in the `conf` directory of your Apache Tomcat installation.

Add an entry for each property in the `<context>` section of the corresponding application. This entry should have the following syntax:

```
<Environment name="JNDI_property_name" value="property_value" type="property_type" override="false"/>
```

Where:

JNDI_property_name is the name of the property you are adding.

property_value is the value of the property you are adding.

property_type is the type of the property you are adding.

Table 6-56. Properties in the server.xml file for configuring the endpoint of the application resources

Property	Type	Description
ibm.appcenter.services.endpoint	java.lang.String	The URI of the Application Center REST services (applicationcenter.war). In a scenario with a firewall or a secured reverse proxy, this URI must be the external URI and not the internal URI inside the local LAN.
ibm.appcenter.proxy.protocol	java.lang.String	The protocol of the application resources URI. This property is optional. It is only needed if the protocol of the external and of the internal URI are different.
ibm.appcenter.proxy.host	java.lang.String	The host name of the application resources URI.
ibm.appcenter.proxy.port	java.lang.Integer	The port of the application resources URI. This property is optional. It is only needed if the protocol of the external and of the internal URI are different.

For a complete list of JNDI properties that you can set, see “List of JNDI properties for the Application Center” on page 6-223.

Example of setting server.xml properties for configuring the endpoint

This example shows the settings of the properties in the server.xml file required for configuring the endpoint of the application resources.

In the <context> section of the Application Center console application:

```
<Environment name="ibm.appcenter.services.endpoint" value="https://appcntr.net:443/applicationcenter" type="java.lang.String" override="false"/>
```

You can use the asterisk (*) character as wildcard to specify that the Application Center REST services use the same value as the Application Center console. For example: *//*:*/appcenter means use the same protocol, host, and port as the Application Center console, but use appcenter as context root.

In the <context> section of the Application Center services application:

```
<Environment name="ibm.appcenter.services.endpoint" value="https://appcntr.net:443/applicationcenter" type="java.lang.String" override="false"/>
<Environment name="ibm.appcenter.proxy.protocol" value="https" type="java.lang.String" override="false"/>
<Environment name="ibm.appcenter.proxy.host" value="appcntr.net" type="java.lang.String" override="false"/>
<Environment name="ibm.appcenter.proxy.port" value="443" type="java.lang.Integer" override="false"/>
```

Configuring Secure Sockets Layer (SSL)

Learn about configuring SSL for the Application Center on supported application servers and the limitations of certificate verification on mobile operating systems.

For iOS applications, you must configure the Application Center server with SSL.

SSL transmits data over the network in a secured channel. You must purchase an official SSL certificate from an SSL certificate authority. Self-signed certificates do not work with the Application Center.

When the client accesses the server through SSL, the client verifies the server through the SSL certificate. If the server address matches the address filed in the SSL certificate, the client accepts the connection. For the verification to be successful, the client must know the root certificate of the certificate authority. Many root certificates are preinstalled on iOS devices. The exact list of preinstalled root certificates varies between versions of mobile operating systems.

You should consult the SSL certificate authority for information about the mobile operating system versions that support its certificates.

If the SSL certificate verification fails, a normal web browser requests confirmation to contact an untrusted site. The same behavior occurs when you use a self-signed certificate that was not purchased from a certificate authority. When mobile applications are installed, this control is not performed by a normal web browser, but by operating system calls.

Some versions of the iOS operating systems do not support this confirmation dialog in system calls. This limitation is a reason to avoid self-signed certificates or SSL certificates that are not suited to mobile operating systems. On the iOS operating system, you can install a self-signed CA certificate on the device to enable the device to handle system calls with respect to this self-signed certificate. This practice is not appropriate for Application Center in a production environment, but it may be suitable during the testing period. For details, see “Configuring SSL by using untrusted certificates” on page 6-136 and “Managing and installing self-signed CA certificates in an Application Center test environment” on page 6-221.

Configuring SSL for WebSphere Application Server full profile

Request a Secure Sockets Layer (SSL) certificate and process the received documents to import them into the keystore.

About this task

This procedure indicates how to request an SSL certificate and import it and the chain certificate into your keystore.

Procedure

1. Create a request to a certificate authority; in the WebSphere administrative console, select **Security > SSL certificate and key management > Key stores and certificates > keystore > Personal certificate requests > New**.

Where *keystore* identifies your keystore.

The request is sent to the certificate authority.

2. When you receive the SSL certificate, import it and the corresponding chain certificate into your keystore by following the instructions provided by the certificate authority. In the WebSphere administrative console, you can find the

corresponding option in **Security > SSL certificate and key management > Manage endpoint security configurations > node SSL settings > Key stores and certificates > keystore > Personal certificates > certificate > Receive a certificate from a certificate authority.**

Where:

- *node SSL settings* shows the SSL settings of the nodes in your configuration.
 - *keystore* identifies your keystore.
 - *certificate* identifies the certificate that you received.
3. Create an SSL configuration. See the instructions in the user documentation that corresponds to the version of the WebSphere Application Server full profile that supports your applications.

You can find configuration details in the WebSphere administrative console at **Security > SSL certificate and key management > Manage endpoint security configurations > SSL Configurations.**

Configuring SSL for Liberty profile

Create a keystore, import the Secure Socket Layer (SSL) certificate, and edit the `server.xml` file to configure SSL on Liberty profile.

About this task

Follow the steps in this procedure to configure SSL on Liberty profile.

Procedure

1. Create a keystore for your web server; use the `securityUtility` with the `createSSLCertificate` option. See Enabling SSL communication for the Liberty profile for more information.
2. Import the SSL certificate and the corresponding chain certificate into your keystore by following the instructions provided by the certificate authority.
3. Enable the `ssl-1.0` Liberty feature in the `server.xml` file.

```
<featureManager>
  <feature>ssl-1.0</feature>
</featureManager>
```
4. Add the keystore service object entry to the `server.xml` file. The `keyStore` element is called `defaultKeyStore` and contains the keystore password. For example:

```
<keyStore id="defaultKeyStore" location="/path/to/myKeyStore.p12"
  password="myPassword" type="PKCS12"/>
```
5. Make sure that the value of the `httpEndpoint` element in the `server.xml` file defines the `httpsPort` attribute. For example:

```
<httpEndpoint id="defaultHttpEndpoint" host="*" httpPort="9080" httpsPort="9443" >
```
6. Restart the web server. Now you can access the web server by `https://myserver:9443/...`

Configuring SSL for Apache Tomcat

Create a keystore, import the Secure Socket Layer (SSL) certificate, and edit the `conf/server.xml` file to define a connector for SSL on Apache Tomcat.

About this task

Follow the steps in this procedure to configure SSL on Apache Tomcat. See SSL Configuration HOW-TO for more details and examples of configuring SSL for Apache Tomcat.

Procedure

1. Create a keystore for your web server. You can use the Java **keytool** command to create a keystore.

```
keytool -genkey -alias tomcat -keyalg RSA -keystore /path/to/keystore.jks
```

2. Import the SSL certificate and the corresponding chain certificate into your keystore by following the instructions provided by the certificate authority.
3. Edit the `conf/server.xml` file to define a connector to use SSL. This connector must point to your keystore.

```
<Connector port="8443" protocol="HTTP/1.1" SSLEnabled="true"  
    maxThreads="150" scheme="https" secure="true"  
    clientAuth="false" sslProtocol="TLS"  
    keystoreFile="/path/to/keystore.jks"  
    keystorePass="mypassword" />
```

4. Restart the web server. Now you can access the web server by `https://myserver:8443/...`

Managing and installing self-signed CA certificates in an Application Center test environment

Use self-signed certificate authority (CA) certificates in test environments to install applications with Application Center on a mobile device from a secured server.

Uploading or deleting a certificate: Before you begin

When you install the Application Center mobile client from OTA (the bootstrap page), the device user must upload and install the self-signed CA file before the Application Center mobile client is installed.

About this task

When you use Application Center for a test installation, the administrator might not have a real Secure Sockets Layer (SSL) certificate available. You might want to use a self-signed CA certificate. Such certificates work if they get installed on the device as root certificate. For the basic concepts of CA certificates and further details about such certificates, see “Configuring SSL by using untrusted certificates” on page 6-136.

As an administrator, you can easily distribute self-signed CA certificates to devices.

Support for X.509 certificates comes from the iOS platform, not from IBM MobileFirst Platform Foundation for iOS. For more information about specific requirements for X.509 certificates, see iOS documentation.

Procedure

Managing self-signed certificates: in your role of administrator of Application Center, you can access the list of registered self-signed CA certificates to upload or delete certificates.

1. To display Application Center settings, click the gear icon .
2. To display the list of registered certificates, select **Self Signed Certificates**.
3. Upload or delete a certificate.
 - To upload a self-signed CA certificate, in the Application Center console, click **Upload a certificate** and select a certificate file.

Note: The certificate file must be in PEM file format. Typical file name suffixes for this type of file are .pem, .key, .cer, .cert. The certificate must be a self-signed one, that is, the values of the **Issuer** and **Subject** fields must be the same. And the certificate must be a CA certificate, that is, it must have the X509 extension named BasicConstraint set to CA:TRUE.

- To delete a certificate, click the trash can icon on the right of the certificate file name in the list.

Installing a self-signed CA certificate on a device:

About this task

Registered self-signed CA certificates are available through the bootstrap page at <http://hostname:portnumber/appcenterconsole/installers.html>

Where:

- *hostname* is the name of the server that hosts the Application Center console.
- *portnumber* is the corresponding port number.

Procedure

1. Click the **SSL Certificates** tab.
2. To display the details of a certificate, select the appropriate registered certificate.
3. To download and install the certificate on the device, click **Install**.

Managing the DB2 transaction log size

When you upload an application that is at least 40 MB with IBM MobileFirst Platform Application Center console, you might receive a transaction log full error.

About this task

The following system output is an example of the transaction log full error code.

```
DB2 SQL Error: SQLCODE=-964, SQLSTATE=57011
```

The content of each application is stored in the Application Center database.

The active log files are defined in number by the **LOGPRIMARY** and **LOGSECOND** database configuration parameters, and in size by the **LOGFILSIZ** database configuration parameter. A single transaction cannot use more log space than **LOGFILSZ * (LOGPRIMARY + LOGSECOND) * 4096 KB**.

The **DB2 GET DATABASE CONFIGURATION** command includes information about the log file size, and the number of primary and secondary log files.

Depending on the largest size of the MobileFirst application that is deployed, you might need to increase the DB2 log space.

Procedure

Using the **DB2 update db cfg** command, increase the **LOGSECOND** parameter. Space is not allocated when the database is activated. Instead, the space is allocated only as needed.

List of JNDI properties for the Application Center

Here is a list of the JNDI properties that can be configured for the Application Center.

Table 6-57. List of the JNDI properties for the Application Center

Property	Description
appcenter.database.type	The database type, which is only required when the database is not specified in appcenter.jndi.name .
appcenter.jndi.name	The JNDI name of the database. This parameter is the normal mechanism to specify the database. The default value is <code>java:comp/env/jdbc/AppCenterDS</code> .
appcenter.openjpa.ConnectionDriverName	The fully qualified class name of the database connection driver class. This property is only needed when the database is not specified in appcenter.jndi.name .
appcenter.openjpa.ConnectionPassword	The password for the database connection. This property is only needed when the database is not specified in appcenter.jndi.name .
appcenter.openjpa.ConnectionURL	The URL specific to the database connection driver class. This property is only needed when the database is not specified in appcenter.jndi.name .
appcenter.openjpa.ConnectionUserName	The user name or the database connection. This property is only needed when the database is not specified in appcenter.jndi.name .
ibm.appcenter.apns.p12.certificate.isDevelopmentCertificate	Specifies whether the certificate that enables Application Center to send push notifications about updates of iOS applications is a development certificate. Set to <code>true</code> to enable or <code>false</code> to disable. See “Configuring the Application Center server for connection to Apple Push Notification Services” on page 11-74.
ibm.appcenter.apns.p12.certificate.location	The path to the file of the development certificate that enables Application Center to send push notifications about updates of iOS applications. For example, <code>/Users/someUser/someDirectory/apache-tomcat/conf/AppCenter_apns_dev_cert.p12</code> . See “Configuring the Application Center server for connection to Apple Push Notification Services” on page 11-74.
ibm.appcenter.apns.p12.certificate.password	The password of the certificate that enables Application Center to send push notifications about updates of iOS applications is a development certificate. See “Configuring the Application Center server for connection to Apple Push Notification Services” on page 11-74.
ibm.appcenter.forceUpgradeDBTo60	The database design was changed starting from IBM Worklight version 6.0. The database is automatically updated when the Application Center web application starts. If you want to repeat this update, you can set this parameter to <code>true</code> and start the web application again. Later you can set this parameter to <code>false</code> .
ibm.appcenter.ios.plist.onetimeurl	Specifies whether URLs stored in iOS plist manifests use the one-time URL mechanism without credentials. If you set this property to <code>true</code> , the security level is medium since the one-time URLs are generated with a cryptographic mechanism so that nobody can guess the URL. However, they do not require the user to log in when you use these URLs. Setting this property to <code>false</code> is maximally secure, since the user is then required to log in for each URL. However, requesting the user to log in multiple times when you install an iOS application can degrade the user experience. See “Installing the client on an iOS mobile device” on page 11-105.

Table 6-57. List of the JNDI properties for the Application Center (continued)

Property	Description
ibm.appcenter.ldap.active	Specifies whether Application Center is configured for LDAP. Set to true to enable LDAP; set to false to disable LDAP. See “Managing users with LDAP” on page 6-194.
ibm.appcenter.ldap.cache.expiration.seconds	<p>The Application Center maintains a cache of LDAP data and the changes become visible only after the cache expires. Specify the amount of time in seconds an entry in the LDAP cache is valid. Set this property to a value larger than 3600 (1 hour) to reduce the amount of LDAP requests. If no value is entered, the default value is 86400, which is equal to 24 hours.</p> <p>If you need to manually clear the cache of LDAP data, enter this command:</p> <pre>acdeploytool.sh -clearLdapCache -s serverurl -c context -u user -p password</pre> <p>See Using the stand-alone tool to clear the LDAP cache for details.</p>
ibm.appcenter.ldap.connectionURL	The URL to access the LDAP server when no VMM is used. See “Configuring LDAP ACL management (Liberty profile)” on page 6-205 and “Configuring LDAP ACL management (Apache Tomcat)” on page 6-211.
ibm.appcenter.ldap.federated.active	Specifies whether Application Center is configured for LDAP with federated repositories. Since WebSphere Application Server Liberty Profile V8.5.5, set this property to true to enable use of the federated registry. Set this property to false to disable use of the federated registry, which is the default setting. See “Managing users with LDAP” on page 6-194.
ibm.appcenter.ldap.group.base	The search base to find groups when you use LDAP without VMM. See “Configuring LDAP ACL management (Liberty profile)” on page 6-205 and “Configuring LDAP ACL management (Apache Tomcat)” on page 6-211.
ibm.appcenter.ldap.group.filter	<p>LDAP group search filter. Use %v as the placeholder for the group attribute.</p> <p>This property is only required when LDAP users and groups are defined in the same subtree; that is, when the properties ibm.appcenter.ldap.user.base and ibm.appcenter.ldap.group.base have the same value.</p>
ibm.appcenter.ldap.group.name	The group name attribute when you use LDAP without VMM. See “Configuring LDAP ACL management (Liberty profile)” on page 6-205 and “Configuring LDAP ACL management (Apache Tomcat)” on page 6-211.
ibm.appcenter.ldap.group.nesting	Specifies whether the LDAP contains nested groups (that is, groups in groups) when you use LDAP without VMM. Setting this property to false speeds up the LDAP access since the groups are then not searched recursively. See “Configuring LDAP ACL management (Liberty profile)” on page 6-205 and “Configuring LDAP ACL management (Apache Tomcat)” on page 6-211.
ibm.appcenter.ldap.group.uniquemember	Specifies the members of a group when you use LDAP without VMM. This property is the inverse of ibm.appcenter.ldap.user.groupmembership . See “Configuring LDAP ACL management (Liberty profile)” on page 6-205 and “Configuring LDAP ACL management (Apache Tomcat)” on page 6-211.

Table 6-57. List of the JNDI properties for the Application Center (continued)

Property	Description
ibm.appcenter.ldap.referral	<p>Specifies whether referrals are supported by the JNDI API. If no value is given, the JNDI API does not handle LDAP referrals. Here are the possible values:</p> <ul style="list-style-type: none"> • ignore: ignores referrals that are found in the LDAP server. • follow: automatically follows any referrals that are found in the LDAP server. • throw: causes an exception to occur for each referral found in the LDAP server.
ibm.appcenter.ldap.security.binddn	<p>The distinguished name of the user that is allowed to search the LDAP directory. Use this property only if security binding is required.</p> <p>The password can be encoded with the “Liberty Profile securityUtility” tool. Run the tool and then set the value of this property to the encoded password generated by the tool. The supported encoding types are xor and aes.</p> <p>Edit the Liberty Profile server.xml file to check whether the <i>classloader</i> is enabled to load the JAR file that decodes the password. See “Configuring LDAP ACL management (Apache Tomcat)” on page 6-211.</p>
ibm.appcenter.ldap.security.bindpwd	<p>The password of the user that is permitted to search the LDAP directory. Use this property only if security binding is required. See “Configuring LDAP ACL management (Apache Tomcat)” on page 6-211.</p>
ibm.appcenter.ldap.security.sasl	<p>Specifies the security authentication mechanism when the LDAP external SASL authentication mechanism is required to bind to the LDAP server. The value depends on the LDAP server and it is typically set to EXTERNAL. If set, security authentication is used when you connect to LDAP without VMM. See “Configuring LDAP ACL management (Liberty profile)” on page 6-205 and “Configuring LDAP ACL management (Apache Tomcat)” on page 6-211.</p>
ibm.appcenter.ldap.user.base	<p>The search base to find users when you use LDAP without VMM. See “Configuring LDAP ACL management (Liberty profile)” on page 6-205 and “Configuring LDAP ACL management (Apache Tomcat)” on page 6-211.</p>
ibm.appcenter.ldap.user.displayName	<p>The display name attribute, such as the user’s real name, when you use LDAP without VMM. See “Configuring LDAP ACL management (Liberty profile)” on page 6-205 and “Configuring LDAP ACL management (Apache Tomcat)” on page 6-211.</p>
ibm.appcenter.ldap.displayName.filter	<p>LDAP user search filter for the attribute of ibm.appcenter.ldap.user.displayName. Use %v as the placeholder for the display name attribute.</p> <p>This property is only required when LDAP users and groups are defined in the same subtree; that is, when the properties ibm.appcenter.ldap.user.base and ibm.appcenter.ldap.group.base have the same value.</p>

Table 6-57. List of the JNDI properties for the Application Center (continued)

Property	Description
ibm.appcenter.ldap.user.filter	LDAP user search filter for the attribute of ibm.appcenter.ldap.user.loginName . Use %v as the placeholder for the login name attribute. This property is only required when LDAP users and groups are defined in the same subtree; that is, when the properties ibm.appcenter.ldap.user.base and ibm.appcenter.ldap.group.base have the same value.
ibm.appcenter.ldap.user.groupmembership	Specifies the groups of a member when you use LDAP without VMM. This property is the inverse of ibm.appcenter.ldap.group.uniquemember . This property is optional, but if it is specified, the LDAP access is faster. See “Configuring LDAP ACL management (Liberty profile)” on page 6-205 and “Configuring LDAP ACL management (Apache Tomcat)” on page 6-211.
ibm.appcenter.ldap.user.loginName	The login name attribute when you use LDAP without VMM. See “Configuring LDAP ACL management (Liberty profile)” on page 6-205 and “Configuring LDAP ACL management (Apache Tomcat)” on page 6-211.
ibm.appcenter.ldap.vmm.active	Specifies whether LDAP is done through VMM. Set to true to enable or false to disable. See “Configuring LDAP ACL management (WebSphere Application Server V8.x)” on page 6-201 and “Configuring LDAP ACL management with VMM (WebSphere Application Server V7)” on page 6-198.
ibm.appcenter.ldap.vmm.adminpwd	The password when LDAP is done through VMM. See “Configuring LDAP ACL management (WebSphere Application Server V8.x)” on page 6-201 and “Configuring LDAP ACL management with VMM (WebSphere Application Server V7)” on page 6-198.
ibm.appcenter.ldap.vmm.adminuser	The user when LDAP is done through VMM. See “Configuring LDAP ACL management (WebSphere Application Server V8.x)” on page 6-201 and “Configuring LDAP ACL management with VMM (WebSphere Application Server V7)” on page 6-198.
ibm.appcenter.logging.formatjson	This property has only an effect when ibm.appcenter.logging.tosystemerror is set to true. If enabled, it formats JSON responses in logging messages that are directed to System.Error. Setting this property is helpful when you debug the server.
ibm.appcenter.logging.tosystemerror	Specifies whether all logging messages are also directed to System.Error. Setting this property is helpful when you debug the server.
ibm.appcenter.openjpa.Log	This property is passed to OpenJPA and enables JPA logging. For details, see the Apache OpenJPA User's Guide.
ibm.appcenter.proxy.host	If the Application Center server is behind a firewall or reverse proxy, this property specifies the address of the host. Setting this property allows a user outside the firewall to reach the Application Center server. Typically, this property is the address of the proxy. See “Defining the endpoint of the application resources” on page 6-214.

Table 6-57. List of the JNDI properties for the Application Center (continued)

Property	Description
ibm.appcenter.proxy.port	If the Application Center server is behind a firewall or reverse proxy, this property specifies the address of the host. Setting this property allows a user outside the firewall to reach the Application Center server. Typically, this property is the port of the proxy, for example 443. It is only needed if the protocol of the external and of the internal URI are different. See “Defining the endpoint of the application resources” on page 6-214.
ibm.appcenter.proxy.protocol	If the Application Center server is behind a firewall or reverse proxy, this property specifies the protocol (http or https). Setting this property allows a user outside the firewall to reach the Application Center server. Typically, this property is set to the protocol of the proxy. For example, appcntr.net . This property is only needed if the protocol of the external and of the internal URI are different. See “Defining the endpoint of the application resources” on page 6-214.
ibm.appcenter.proxy.scheme	This property is just an alternative name for ibm.appcenter.proxy.protocol .
ibm.appcenter.push.schedule.period.amount	Specifies the time schedule when you send push notifications of application updates. When applications are frequently changed on the server, set this property to send batches of notifications. For example, send all notifications that happened within the past hour, instead of sending each individual notification.
ibm.appcenter.push.schedule.period.unit	Specifies the unit for the time schedule when you send push notifications of application updates.
ibm.appcenter.services.endpoint	Enables the Application Center console to locate the Application Center REST services. Specify the external address and context root of the applicationcenter.war web application. In a scenario with a firewall or a secured reverse proxy, this URI must be the external URI and not the internal URI inside the local LAN. For example, https://appcntr.net:443/applicationcenter . See “Defining the endpoint of the application resources” on page 6-214.
ibm.appcenter.services.iconCacheMaxAge	Specifies the amount of time in seconds cached icons remain valid for the Application Center Console and the Client. Application icons rarely change, therefore they are cached. Specify values larger than 600 (10 min) to reduce the amount of data transfer for the icons.
ibm.worklight.jndi.configuration	Optional. If the JNDI configuration is injected into the WAR files or provided as a shared library, the value of this property is the name of the JNDI configuration. This value can also be specified as a system property. See “Predefining MobileFirst Server configuration for several deployment environments.”
ibm.worklight.jndi.file	Optional. If the JNDI configuration is stored as an external file, the value of this property is the path of a file that describes the JNDI configuration. This value can also be specified as a system property. See “Predefining MobileFirst Server configuration for several deployment environments.”

Predefining MobileFirst Server configuration for several deployment environments

You can configure JNDI properties in a property file for easy transfer between one web application server and another; for example, to transfer from test to production environments.

As part of the installation of administration components of IBM MobileFirst Platform Foundation for iOS, various JNDI properties must be set. These components include MobileFirst Operations Console, MobileFirst Administration Service, and Application Center. Normally, JNDI properties are specified in the configuration of the web application server and are outside the web archive (WAR) file that represents the server component.

Instead, you can specify the JNDI properties in a property file. Having JNDI properties in a property file makes it easier to transfer the entire configuration from one web application server to another. For example, you can configure a test web server and, once the configuration is stable, you can transfer the configuration to the production web server by copying the property file to the production server.

This property file can be made available to the server components in various ways:

- The property file can be placed on the file system.
This solution is particularly useful for a stand-alone test server when you are experimenting with JNDI properties to determine the final configuration. You can easily change the file on the file system with a text editor. Then you have only to restart the web server to enable the changed configuration.
- The property file can be injected into web archive (WAR) files.
This solution is useful when you want to transfer the configuration together with the web archive file to another web server. You only have to handle the web archive file, and no other files. The configuration is, in this case, fused into the web archive file.
- The property file can be installed as a shared library for all server components.
This solution is useful when you intend to exchange the web archive files often, but want to keep the same configuration all the time.

Creating the property file

Define JNDI properties in a property file by using a text editor. Determine where to set JNDI properties according to a selective priority.

The property file follows the standard Java property file syntax and can be edited with any text editor. It has the file extension `.properties`. You can include all properties of all web archive (WAR) files in the same property file.

Here is an example of the content of a property file.

```
publicWorkLightHostname=myworklighthost.net
publicWorkLightPort=9080
publicWorkLightProtocol=https
push.gcm.proxy.enabled=false
push.gcm.proxy.host=myproxyhost.net
push.gcm.proxy.port=-1
push.gcm.proxy.protocol=https
ibm.worklight.admin.environmentid=id123
```

JNDI properties

You can refer to the details of JNDI properties in the relevant parts of the user documentation:

Application Center

“List of JNDI properties for the Application Center” on page 6-223

MobileFirst Application Services

“List of JNDI properties for MobileFirst Server administration” on page 6-86

MobileFirst runtime

“Configuration of MobileFirst applications on the server” on page 10-48

You do not have to specify all the possible JNDI properties in the property file. You can specify some in the property file and others as JNDI properties that are explicitly set in the web application server. The following list indicates the priority by which properties are enacted.

1. If a JNDI property is explicitly set in the web application server, this property value is taken. Refer to the documentation of your web application server for how to set JNDI properties.
2. If that is not the case, but the JNDI property is set in the property file injected into the web archive file or in the property file provided as a shared library, the property value is taken from this property file.
3. If that is not the case, but the JNDI property is set in the property file provided on the file system, the property value is taken from this property file.
4. If that is not the case, the default value of the JNDI property is taken.

Using a property file in the file system

You can place the property file directly into the file system of the web application server.

The property file can be stored directly in the file system. This approach is particularly useful for a stand-alone test server when you are experimenting with JNDI properties to determine the final configuration. You can easily change the file on the file system with a text editor. Then you have only to restart the web server to enable the changed configuration.

You must define the property **ibm.worklight.jndi.file** to point to the location of the property file. This property can be defined as a Java Virtual Machine system property or explicitly as a JNDI property. This property cannot be defined in the property file.

WebSphere Application Server full profile

Determine a suitable directory for the JNDI property file in the WebSphere Application Server installation directory.

- For a stand-alone server, you can use a directory such as:
`$WAS_INSTALL_DIR/profiles/profile-name/config/mywlconfig.properties`
- For deployment to a WebSphere Application Server ND cell, use for example:
`$WAS_INSTALL_DIR/profiles/profile-name/config/cells/cell-name/mywlconfig.properties`
- For deployment to a WebSphere Application Server ND cluster, use for example:
`$WAS_INSTALL_DIR/profiles/profile-name/config/cells/cell-name/clusters/cluster-name/mywlconfig.properties`
- For deployment to a WebSphere Application Server ND node, use for example:
`$WAS_INSTALL_DIR/profiles/profile-name/config/cells/cell-name/nodes/node-name/mywlconfig.properties`
- For deployment to a WebSphere Application Server ND server, use for example:

```
$WAS_INSTALL_DIR/profiles/profile-name/config/cells/cell-name/nodes/node-name/servers/server-name/mywlconfig.properties
```

Next, add the setting of the **ibm.worklight.jndi.file** property to the Java Virtual Machine custom properties in the WebSphere Application Server administration console. For details of how to add this setting, see “Setting the file pointer property (WebSphere Application Server full profile)” on page 6-231.

WebSphere Application Server Liberty profile

You must place the property file inside the server directory of the Liberty server; for example, place it in `$LIBERTY_HOME/usr/servers/worklightServer/mywlconfig.properties`.

Edit the `$LIBERTY_HOME/usr/servers/worklightServer/bootstrap.properties` file and add the property **ibm.worklight.jndi.file** to point to the property file; for example, `ibm.worklight.jndi.file=mywlconfig.properties`.

Alternatively, instead of editing `bootstrap.properties`, create or edit the file `$LIBERTY_HOME/usr/servers/worklightServer/jvm.options` and add, for example:
`-Dibm.worklight.jndi.file=mywlconfig.properties`

You can use the normal web archive (WAR) files of the web applications. They can be installed as described elsewhere in “Installing and configuring” on page 6-1.

Restart the web application server. Whenever the property file changes, the web application server must be restarted.

Apache Tomcat

You must place the property file inside the `conf` directory of the Apache Tomcat server; for example, place it in `$TOMCAT_HOME/conf/mywlconfig.properties`.

Edit the `$TOMCAT_HOME/conf/catalina.properties` file and add the property **ibm.worklight.jndi.file** to point to the property file; for example, **ibm.worklight.jndi.file=../conf/mywlconfig.properties**.

Alternatively, on UNIX systems, instead of editing `catalina.properties`, create or edit the `$TOMCAT_HOME/bin/setenv.sh` file and add, for example:

```
CATALINA_OPTS="$CATALINA_OPTS  
-Dibm.worklight.jndi.file=../conf/mywlconfig.properties"
```

or on microsoft Windows systems, create or edit the `$TOMCAT_HOME/bin/setenv.bat` file and add , for example:

```
set CATALINA_OPTS=%CATALINA_OPTS%  
-Dibm.worklight.jndi.file=../conf/mywlconfig.properties
```

You can use the normal web archive (WAR) files of the web applications. They can be installed as described elsewhere in “Installing and configuring” on page 6-1.

Restart the web application server. Whenever the property file changes, the web application server must be restarted.

Setting the file pointer property (WebSphere Application Server full profile)

Define the **ibm.worklight.jndi.file** property through the administration console of the WebSphere Application Server full profile.

Before you begin

Determine the location in the file system of the JNDI property file. See “WebSphere Application Server full profile” on page 6-229.

About this task

When you opt to configure JNDI properties by using a property file located directly in the file system, you must set a property to point to the property file. This property is outside the property file and is set through the administration console.

You must log in to the WebSphere Application Server administration console and add the setting of the **ibm.worklight.jndi.file** property to the Java Virtual Machine custom properties.

Procedure

1. Select **Servers > Server types > WebSphere Application Servers**.
2. Select the name of your server.
3. Expand “Java and process management” and select “Process Definition”.
4. Select “Java Virtual Machine”.
5. Select “Custom Properties” and click **New**.
6. Specify the name as **ibm.worklight.jndi.file**.
7. Specify the value as the path to the property file. The directory `$WAS_INSTALL_DIR/profiles/profile-name` can be specified as `${USER_INSTALL_ROOT}`; for example, that can be one of the following values:
 - `${USER_INSTALL_ROOT}/config/mywlconfig.properties`
 - `${USER_INSTALL_ROOT}/config/cells/cell-name/mywlconfig.properties`
 - `${USER_INSTALL_ROOT}/config/cells/cell-name/clusters/cluster-name/mywlconfig.properties`
 - `${USER_INSTALL_ROOT}/config/cells/cell-name/nodes/node-name/mywlconfig.properties`
 - `${USER_INSTALL_ROOT}/config/cells/cell-name/nodes/node-name/servers/server-name/mywlconfig.properties`
8. Click **Apply**.
9. Click **Save**.

What to do next

You can use the normal web archive (WAR) files of the web applications. They can be installed as described elsewhere in “Installing and configuring” on page 6-1.

To enable the property file, restart all MobileFirst Server components. These components are displayed in the WebSphere Application Server administration console under WebSphere enterprise applications.

Using property files injected into a web archive file

You can inject several configuration files into the WAR file of a MobileFirst Server component.

The property file can be injected into the web archive (WAR) files for MobileFirst Operations Console, MobileFirst Administration Service, MobileFirst runtime, or Application Center. This approach is useful when you want to transfer the configuration together with the web archive file to another web application server. In this case, you only have to handle the web archive file, and no other files. The configuration is, in this case, fused into the web archive file.

You can inject several different configurations into the same web archive file and then select in the web application server which configuration should be used. For example, you could have a test configuration and a production configuration injected at the same time. To do so, create multiple property files with different settings, one named `testconf.properties` and the other named `prodconf.properties`.

Some JNDI properties must have the same value in all MobileFirst Server components. Therefore, you should inject the same property files into all web archive files. The following JNDI properties must be the same for MobileFirst Operations Console, MobileFirst Administration Services, and MobileFirst runtime:

- `ibm.worklight.admin.environmentid`
- `ibm.worklight.topology.clustermode`
- `ibm.worklight.topology.platform`
- `ibm.worklight.admin.jmx.connector`
- `ibm.worklight.admin.jmx.dmgr.host`
- `ibm.worklight.admin.jmx.dmgr.port`
- `ibm.worklight.admin.jmx.host`
- `ibm.worklight.admin.jmx.port`
- `ibm.worklight.admin.jmx.user`
- `ibm.worklight.admin.jmx.pword`
- `ibm.worklight.admin.rmi.registryPort`
- `ibm.worklight.admin.rmi.serverPort`

Injecting property files into a WAR file by using the Command Line tool

The `wljndiinject` command line tool is used to inject a set of property files into a web archive file. To add the property files `testconf.properties` and `prodconf.properties` to a war file, use the following command:

```
wljndiinject --sourceWarFile source.war testconf.properties prodconf.properties
```

The resulting web archive file can be found in the folder `jndi-injected`. It contains the property files inside the web archive file.

Options of the tool:

--help Shows the help.

--sourceWarFile *file*

The web archive file that is used to add the property files.

--destFile *file*

The destination file name. If not specified, the destination file is placed in the jndi-injected directory.

--sharedJar

Used to create a shared library; For details, see "Creating a shared library of JNDI properties" on page 6-236.

Injecting property files into a WAR file by using an Ant task

You can use the `com.worklight.ant.jndi.JNDIInjectionTask` Ant task to inject a set of property files into a web archive file.

Here is a sample ant script that shows the use of the ant task:

```
<?xml version="1.0" encoding="UTF-8"?>
<project name="WLJndiInjectTask" basedir="." default="jndiinject.Sample">
  <property name="install.dir" value="/path.to.worklight.installation" />
  <path id="classpath.run">
    <fileset dir="{install.dir}/WorklightServer/">
      <include name="worklight-ant-deployer.jar" />
    </fileset>
  </path>
  <target name="jndiinject.init">
    <taskdef name="jndiinject"
      classname="com.worklight.ant.jndi.JNDIInjectionTask">
      <classpath refid="classpath.run" />
    </taskdef>
  </target>
  <target name="jndiinject.Sample"
    description="Injects properties into the Worklight war file"
    depends="jndiinject.init">
    <!-- This is just an example:
      Mandatory parameters are sourceWarFile and the fileset.
      All other parameters are optional and could be omitted.
      The source war files are expected in the wars directory.
      The property files are expected in the properties directory.
    -->
    <jndiinject
      sourceWarFile="wars/worklightproject.war"
      destWarFile="worklightproject-injected.war" >
      <fileset dir="." casesensitive="yes">
        <include name="properties/*.properties"/>
      </fileset>
    </jndiinject>
    <jndiinject
      sourceWarFile="wars/worklightadmin.war"
      destWarFile="worklightadmin-injected.war" >
      <fileset dir="." casesensitive="yes">
        <include name="properties/*.properties"/>
      </fileset>
    </jndiinject>
    <jndiinject
      sourceWarFile="wars/worklightconsole.war"
      destWarFile="worklightconsole-injected.war" >
      <fileset dir="." casesensitive="yes">
        <include name="properties/*.properties"/>
      </fileset>
    </jndiinject>
  </target>
</project>
```

Installing the property-injected WAR files in the web application server

After injection of the property files into the web archive files, the web archive files contain the property files and can be installed like any normal web archive file in the web application server.

For the MobileFirst Administration Services, MobileFirst Operations Console, and the MobileFirst runtime, you can use the ant task to install the web archive files, or you can update the web archive files manually.

For details of how to install web archive files for MobileFirst components, see:

- “Using Ant tasks to install MobileFirst Server administration” on page 6-53
- “Deploying a project WAR file and configuring the application server with Ant tasks” on page 10-14
- “Deploying the Application Center WAR files and configuring the application server manually” on page 6-183

When the web archive file is deployed, you must define the **ibm.worklight.jndi.configuration** property to point to the name of the required configuration.

Selecting the configuration in a property-injected WAR file

The default configuration is called `default.properties`. If the configuration of JNDI properties has a different name, you must define the **ibm.worklight.jndi.configuration** property. The value of this property must be the configuration name without the extension `.properties`. This property can be specified as a Java Virtual Machine system property or explicitly as a JNDI property. This property cannot be defined in the configuration property file.

Selecting the configuration: WebSphere Application Server full profile

You must log in to the WebSphere Application Server administration console and add the setting of the **ibm.worklight.jndi.configuration** property to the Java Virtual Machine custom properties.

To add this property setting:

1. Select **Servers > Server types > WebSphere Application Servers**.
2. Select the name of your server.
3. Expand “Java and process management” and select “Process Definition”
4. Select “Java Virtual Machine”.
5. Select “Custom Properties” and click **New**.
6. Specify the name as **ibm.worklight.jndi.configuration**.
7. Specify the value as the name of the configuration.
8. Click **Apply**.
9. Click **Save**.

When the property is set, to enable the configuration, restart the appropriate MobileFirst Server components. These components are displayed in the WebSphere Application Server administration console under WebSphere enterprise applications.

Selecting the configuration: WebSphere Application Server Liberty profile

You must edit the `$LIBERTY_HOME/usr/servers/worklightServer/bootstrap.properties` file and set the `ibm.worklight.jndi.configuration` property to point to the name of the configuration.

For example:

```
ibm.worklight.jndi.configuration=testconf
```

Alternatively, instead of editing the `bootstrap.properties` file, create or edit the `$LIBERTY_HOME/usr/servers/worklightServer/jvm.options` file. For example, add:

```
-Dibm.worklight.jndi.configuration=testconf
```

To enable the configuration, restart the web application server.

Selecting the configuration: Apache Tomcat

You must edit the `$TOMCAT_HOME/conf/catalina.properties` file and set the `ibm.worklight.jndi.configuration` property to point to the name of the configuration.

For example:

```
ibm.worklight.jndi.configuration=testconf
```

Alternatively, instead of editing the `catalina.properties` file, depending on the operating system, create or edit one of the following files:

- On UNIX systems: `$TOMCAT_HOME/bin/setenv.sh`

For example, add:

```
CATALINA_OPTS="$CATALINA_OPTS -Dibm.worklight.jndi.configuration=testconf"
```

- On Microsoft Windows systems: `$TOMCAT_HOME/bin/setenv.bat`

For example, add:

```
set CATALINA_OPTS=%CATALINA_OPTS% -Dibm.worklight.jndi.configuration=testconf
```

To enable the configuration, restart the web application server.

Using a shared library of JNDI properties

You can create a shared library to hold different configurations for any MobileFirst Server component.

If you do not want to inject properties into web archive files, the property file can be installed as a shared library for all MobileFirst Server components. This approach is useful when you intend to exchange the web archive files often, but want to keep the same configuration all the time. The original web archive files remain unchanged, but you need to install an additional shared library.

You can add several different configurations to the same shared library and then select in the web application server which configuration to use. For example, you could have a test configuration and a production configuration injected at the same time. To do so, create property files with different settings, one named `testconf.properties` and the other `prodconf.properties`.

Creating a shared library of JNDI properties

The `wljndiinject` command line tool is used to create a shared library for a set of property files. To create a shared library named `jndiprops.jar` with the property files `testconf.properties` and `prodconf.properties`, use the following command:

```
wljndiinject --sharedJar --destFile jndiprops.jar testconf.properties prodconf.properties
```

Options of the tool:

--help Shows the help.

--sourceWarFile *file*

This option is not required for creating a shared library. This option is used when a property file is injected into a web archive file to identify the web archive file.

--destFile *file*

The destination file name of the shared library.

--sharedJar

Used to create a shared library instead of injecting a property file into a web archive file.

Installing a shared library of JNDI configurations

Assume that all web applications are already installed. The shared library is added to the web applications.

WebSphere Application Server full profile

Determine a suitable directory for the shared library `jndiprops.jar` in the WebSphere Application Server installation directory and place the `jndiprops.jar` file there.

- For a stand-alone server, you can use a directory such as:
`$WAS_INSTALL_DIR/optionalLibraries/IBM/Worklight`
- For deployment to a WebSphere Application Server ND cell, use for example:
`$WAS_INSTALL_DIR/profiles/profile-name/config/cells/cell-name/Worklight`
- For deployment to a WebSphere Application Server ND cluster, use:
`$WAS_INSTALL_DIR/profiles/profile-name/config/cells/cell-name/clusters/cluster-name/Worklight`
- For deployment to a WebSphere Application Server ND node, use:
`$WAS_INSTALL_DIR/profiles/profile-name/config/cells/cell-name/nodes/node-name/Worklight`
- For deployment to a WebSphere Application Server ND server, use:
`$WAS_INSTALL_DIR/profiles/profile-name/config/cells/cell-name/nodes/node-name/servers/server-name/Worklight`

For details about adding the shared library, see “Adding the shared library (WebSphere Application Server full profile)” on page 6-238.

WebSphere Application Server Liberty profile

Place the `jndiprops.jar` file in a suitable directory; for example, `$LIBERTY_HOME/usr/shared/resources/lib/jndiprops.jar`.

Edit the `$LIBERTY_HOME/usr/servers/worklightServer/server.xml` file. For each `<application>` element, add or update the `<classloader>` element.

```

<application ...>
  ...
  <classloader delegation="parentLast"></p>
  ...
  <privateLibrary>
    <fileset dir="{shared.resource.dir}/lib"
      includes="jndiprops.jar"/>
  </privateLibrary>
</classloader>
</application>

```

Restart the web application server after these changes.

Apache Tomcat

Place the shared library, `jndiprops.jar` file, in a suitable directory; for example, `$TOMCAT_HOME/Worklight/jndiprops.jar`.

Edit the `$TOMCAT_HOME/conf/server.xml` file. For each `<Context>` element, add or update the `<Loader>` element.

```

<Context docBase="worklightconsole" path="/worklightconsole">
  <Loader className="org.apache.catalina.loader.VirtualWebappLoader"
    virtualClasspath="{catalina.base}/Worklight/jndiprops.jar"
    searchVirtualFirst="true"/>
  ...
</Context>

```

For the MobileFirst project, which uses additional shared libraries, the example code is:

```

<Context docBase="worklightconsole" path="/worklight">
  <Loader className="org.apache.catalina.loader.VirtualWebappLoader"
    virtualClasspath="{catalina.base}/Worklight/worklight/worklight-jee-library.jar;
    {catalina.base}/Worklight/jndiprops.jar"
    searchVirtualFirst="true"/>
  ...
</Context>

```

Restart the web application server after these changes.

Selecting the configuration in a shared library of JNDI configurations

The default configuration is called `default.properties`. If the configuration of JNDI properties has a different name, you must define the **`ibm.worklight.jndi.configuration`** property. The value of this property must be the configuration name without the extension `.properties`. This property can be specified as a Java Virtual Machine system property or explicitly as a JNDI property. This property cannot be defined in the configuration property file.

WebSphere Application Server full profile

You must log in to the WebSphere Application Server administration console and add the setting of the **`ibm.worklight.jndi.configuration`** property to the Java Virtual Machine custom properties.

To add this property setting:

1. Select **Servers > Server types > WebSphere Application Servers**.
2. Select the name of your server.
3. Expand "Java and process management" and select "Process Definition".
4. Select "Java Virtual Machine".
5. Select "Custom Properties" and click **New**.

6. Specify the name as **ibm.worklight.jndi.configuration**.
7. Specify the value as the name of the configuration.
8. Click **Apply**.
9. Click **Save**.

When the property is set, to enable the configuration, restart the appropriate MobileFirst Server components. These components are displayed in the WebSphere Application Server administration console under WebSphere enterprise applications.

WebSphere Application Server Liberty profile

You must edit the `$LIBERTY_HOME/usr/servers/worklightServer/bootstrap.properties` file and set the **ibm.worklight.jndi.configuration** property to point to the name of the configuration.

For example:

```
ibm.worklight.jndi.configuration=testconf
```

Alternatively, instead of editing the `bootstrap.properties` file, create or edit the `$LIBERTY_HOME/usr/servers/worklightServer/jvm.options` file. For example, add:

```
-Dibm.worklight.jndi.configuration=testconf
```

To enable the configuration, restart the web application server.

Apache Tomcat

You must edit the `$TOMCAT_HOME/conf/catalina.properties` file and set the **ibm.worklight.jndi.configuration** property to point to the name of the configuration. For example:

```
ibm.worklight.jndi.configuration=testconf
```

Alternatively, instead of editing the `catalina.properties` file, depending on the operating system, create or edit one of the following files:

- On UNIX systems: `$TOMCAT_HOME/bin/setenv.sh`

For example, add:

```
CATALINA_OPTS="$CATALINA_OPTS -Dibm.worklight.jndi.configuration=testconf"
```

- On Microsoft Windows systems: `$TOMCAT_HOME/bin/setenv.bat`

For example, add:

```
set CATALINA_OPTS=%CATALINA_OPTS% -Dibm.worklight.jndi.configuration=testconf
```

To enable the configuration, restart the web application server.

Adding the shared library (WebSphere Application Server full profile)

Define the shared library and specify which web applications use it.

Before you begin

Install the shared library `jndiprops.jar` in a suitable directory in the WebSphere Application Server installation directory.

About this task

You can install the property file as a shared library for all MobileFirst Server components. To do so, you must log in to the WebSphere Application Server administration console to add the shared library.

Procedure

1. Select **Environment > Shared Libraries**.
2. Select your scope in the fields **Node=** and **Server=**.
3. Click **New**.
4. Enter a name, for example, "MobileFirst JNDI Properties".
5. Enter a description, for example, "IBM MobileFirst JNDI property package".
6. Enter the classpath of the jndiprops.jar file. The *\$WAS_INSTALL_DIR/profiles/profile-name* directory can be specified as *\${USER_INSTALL_ROOT}*.
7. Select the option "Use an isolated class loader for this shared library".
8. Click **Apply**.
9. Click **Save**.
10. Specify which web applications should use the shared library.
 - a. In the administration console, select **Applications > Application Types > WebSphere enterprise applications**. You should stop all applications that you are going to change, because the operations run faster when the applications are stopped.
 - b. Select an application, for example, IBM MobileFirst Administration Service.
 - c. Select **Shared library references**.
 - d. In "Application", select IBM MobileFirst Administration Service.
 - e. Click **Reference shared libraries**.
 - f. Move the MobileFirst JNDI Properties library from Available to Selected.
 - g. Click **OK**.
 - h. Click **Save**.

Repeat this procedure for the other required web applications from among MobileFirst Operations Console, MobileFirst project, Application Center Service, Application Center Console.

What to do next

Go to **Applications > Application Types > WebSphere enterprise applications** and restart all the web applications.

Typical topologies of a MobileFirst instance in an extranet infrastructure

A MobileFirst instance uses a particular topology that is typical for organizations with an established extranet infrastructure.

The following figure depicts this topology.

Figure 6-20. Typical topology of a MobileFirst instance

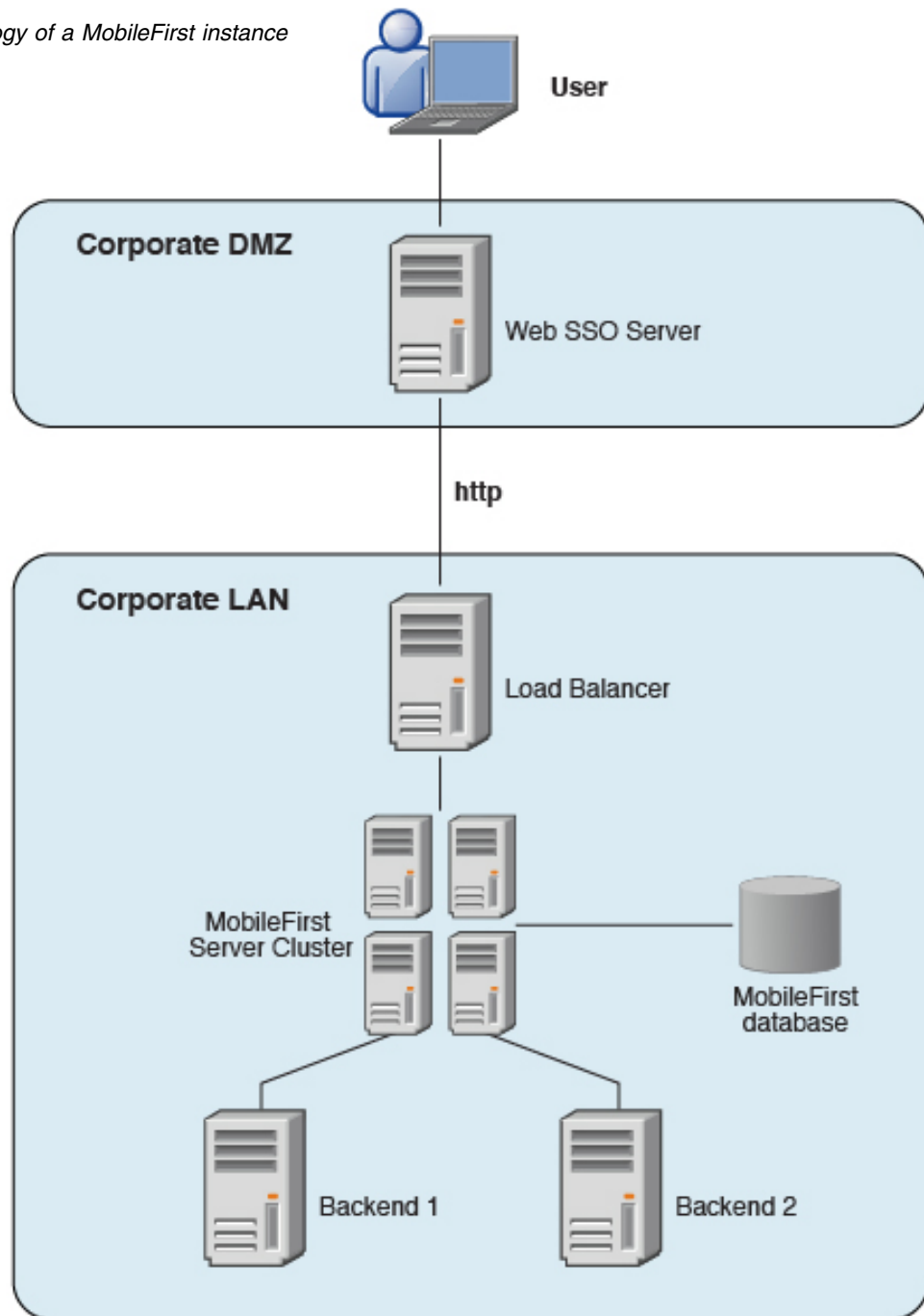

Such a topology is based on the following principles:

- MobileFirst Server is installed in the organization local area network (LAN), connecting to various enterprise back-end systems.
- MobileFirst Server can be clustered for high availability and scalability.
- MobileFirst Server uses a database for storing push notification information, statistics for reporting and analytics, and the metadata that the server needs at run time. All instances of MobileFirst Server share a single instance of the database.

- MobileFirst Server is installed behind a web Single Sign-On (SSO) authentication infrastructure, which acts as a reverse proxy and provides the Security Socket Layer (SSL).

MobileFirst Server can be installed in different network configurations, which might include several Data Management Zone (DMZ) layers, reverse proxies, Network Address Translation (NAT) devices, firewalls, high availability components such as load balancers, IP sprayers, clustering, and alike. Some of these components are explained. However, this document assumes a simpler configuration in which MobileFirst Server is installed in the DMZ.

Setting up IBM MobileFirst Platform Foundation for iOS in WebSphere Application Server cluster environment

You can set up a MobileFirst cluster environment with IBM WebSphere Application Server Network Deployment V8.5 and IBM HTTP Server.

About this task

This procedure explains how to set up IBM MobileFirst Platform Foundation for iOS in the topology shown in Figure 1:

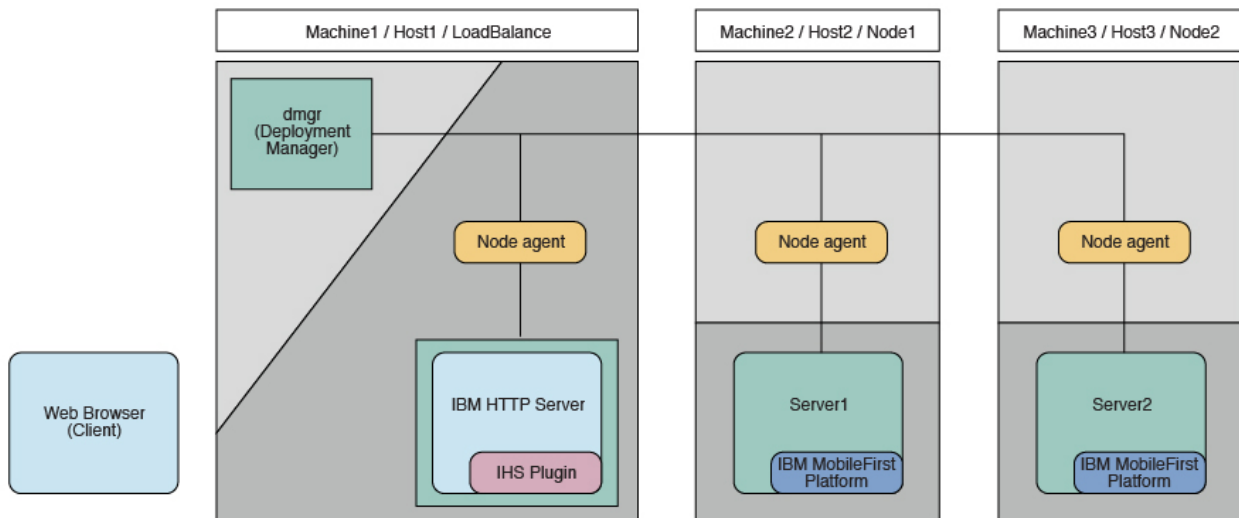

Figure 6-21. MobileFirst cluster topology with IBM WebSphere Application Server Network Deployment

If you install IBM HTTP Server, the administration components require certain JNDI properties to be configured. For more information, see “Using a reverse proxy with server farm and WebSphere Application Server Network Deployment topologies” on page 6-18 and “Defining the endpoint of the MobileFirst Administration services” on page 6-78.

The instructions are based on the hardware and software that are listed in the following Table 6-58 on page 6-242 and Table 6-59 on page 6-242 tables.

Table 6-58. Hardware

Host name	Operating system	Description
Host1	RHEL 6.2	WebSphere Application Server Deployment Manager and IBM HTTP Server.
Host2	RHEL 6.2	WebSphere Application Server cluster node / server 1
Host3	RHEL 6.2	WebSphere Application Server cluster node / server 2
Host4	RHEL 6.2	DB2 server

Table 6-59. Software

Name	Description
IBM Installation Manager 1.8	Install IBM WebSphere Application Server Network Deployment, IBM HTTP Server, IBM Web Server Plug-ins for WebSphere Application Server, and IBM MobileFirst Platform Foundation for iOS.
IBM WebSphere Application Server 8.5	WebSphere Application Server. You need to get the installation repository before you start.
IBM HTTP Server 8.5	IBM HTTP Server. You need to get the installation repository before you start. It is also included in the WebSphere Application Server installation repository.
Web Server Plug-ins 8.5	IBM HTTP Server Plugin. You need to get the installation repository before you start. It is also included in the WebSphere Application Server installation repository.
IBM MobileFirst Platform Foundation for iOS V7.0.0	IBM MobileFirst Platform Foundation for iOS runtime. You need to get access to the installation repository before you start.
IBM DB2 V9.7 or later	DB2 Database. Your DB2 server must be available before you start the IBM MobileFirst Platform Foundation for iOS installation.
Ant 1.8.3	Configure IBM MobileFirst Platform Foundation for iOS with Liberty Profile Server.

Procedure

1. Install WebSphere Application Server Network Deployment, IBM HTTP Server, and Web Server Plugins.
 - a. On the Host1 machine, log on with the “root” user ID and run IBM Installation Manager to install WebSphere Application Server Network Deployment, IBM HTTP server and Web Server Plugins. This documentation assumes that the applications are installed in the following places:

WebSphere Application Server Network Deployment home
/opt/WAS85

IBM HTTP Server home
/opt/IBM/HTTPServer

Web Server Plugins home
/opt/IBM/HTTPServer/Plugins

- b. Repeat step 1a on Host2 and Host3, but install only WebSphere Application Server Network Deployment.
2. Create a deployment manager and nodes.
 - a. To avoid network errors, add the host name and IP mapping to the /etc/hosts file.

On Windows:

Add the IP-to-host mapping to C:\Windows\System32\drivers\etc\hosts.

On Linux:

Add the IP-to-host mapping to /etc/hosts.

For example:

```
9.186.9.75 Host1
9.186.9.73 Host2
9.186.9.76 Host3
```

- b. Create a deployment manager and IBM HTTP Server node on Host1. You can change the profile name and profile path to suit your environment.
 - 1) Create the deployment manager profile. The following command creates a profile named "dmgr:"

On Windows:

```
./manageprofiles.bat -create -profileName dmgr
-profilePath ../profiles/dmgr -templatePath
../profileTemplates/management -severType
DEPLOYMENT_MANAGER
```

On Linux:

```
./manageprofiles.sh -create -profileName dmgr
-profilePath ../profiles/dmgr506 -templatePath
../profileTemplates/management -severType
DEPLOYMENT_MANAGER
```

- 2) Create an IBM HTTP Server node profile. The following command creates a profile named "ihs":

On Windows:

```
./manageprofiles.bat -create -profileName ihs
-profilePath ../profiles/ihs -templatePath
../profileTemplates/managed
```

On Linux:

```
./manageprofiles.sh -create -profileName ihs -profilePath
../profiles/ihs506 -templatePath ../profileTemplates/
managed
```

- 3) Start the deployment manager:

On Windows:

```
./startManager.bat
```

On Linux:

```
./startManager.sh
```

- 4) Add an IBM HTTP Server node to the deployment manager. The following command adds the node defined by the "ihs" profile to the deployment manager running on Host1, and assigns port 8879:

On Windows:

```
./addNode.bat Host1 8879 -profileName ihs
```

On Linux:

```
./addNode.sh Host1 8879 -profileName ihs
```

- 5) From the WebSphere Application Server administrative console, click **System administration > Nodes** and check that the node is added to the deployment manager.

Select	Name	Host Name	Version	Discovery Protocol	Status
	topoIhsCellManager01	topoIhs	ND 8.5.5.0	TCP	↔
<input type="checkbox"/>	topoIhsNode01	topoIhs	ND 8.5.5.0	TCP	↔

Note: Node names might be different from the profile names you specify because WebSphere Application Server automatically generates a display name for a new node.

- c. Create MobileFirst node1 on Host2.

- 1) Create a profile for the node. The following command creates a profile named node1:

On Windows:

```
./manageprofiles.bat -create -profileName node1  
-profilePath ../profiles/node1 -templatePath  
../profileTemplates/managed
```

On Linux:

```
./manageprofiles.sh -create -profileName node1  
-profilePath ../profiles/node1 -templatePath  
../profileTemplates/managed
```

- 2) Add the node to the deployment manager. The following command adds the node defined by the node1 profile to the deployment manager running on Host1, and assigns port 8879:

On Windows:

```
./addNode.bat Host1 8879 -profileName node1
```

On Linux:

```
./addNode.sh Host1 8879 -profileName node1
```

- d. Repeat step 2c to create MobileFirst node2 on Host3.
- e. From the WebSphere Application Server administrative console, click **System administration > Nodes** and check that the nodes you added to the deployment manager are listed.

Select	Name	Host Name	Version	Discovery Protocol	Status
	topoihCellManager01	topoih	ND 8.5.5.0	TCP	↔
<input type="checkbox"/>	topoihNode01	topoih	ND 8.5.5.0	TCP	↔
<input type="checkbox"/>	topowas1Node01	topowas1	ND 8.5.5.0	TCP	↔
<input type="checkbox"/>	topowas2Node01	topowas2	ND 8.5.5.0	TCP	↔

Note: Node names might be different from the profile names you specify because WebSphere Application Server automatically generates a display name for a new node.

3. Create a cluster and add MobileFirst nodes as members.
 - a. From the WebSphere Application Server administrative console, click **Servers > Clusters > WebSphere application server clusters**, and then click **New** to create a new cluster.

The screenshot shows the 'WebSphere application server clusters' page in the administrative console. On the left, a navigation tree has 'WebSphere application server clusters' selected and highlighted with a red box. On the right, the main content area shows a 'New...' button also highlighted with a red box, along with other buttons like 'Delete', 'Start', 'Stop', 'Ripplestart', and 'ImmediateStop'.

- b. For each MobileFirst node, add a member to the cluster: in the fields provided, enter the required information, and then click **Add Member**.

The screenshot shows the 'Create a new cluster' wizard, Step 3: Create additional cluster members. The form includes the following fields and options:

- Member name:** A text input field.
- Select node:** A dropdown menu with 'topowas2Node01 (ND 8.5.5.0)' selected.
- Weight:** A text input field with the value '2' and a range '(0..100)'.
- Generate unique HTTP ports:** A checked checkbox.
- Add Member:** A button to add the member to the cluster.

Below the form, there is a table showing the current cluster members:

Select	Member name	Nodes	Version	Weight
<input type="checkbox"/>	server1	topowas1Node01	ND 8.5.5.0	2
<input type="checkbox"/>	server2	topowas2Node01	ND 8.5.5.0	2
Total 2				

At the bottom of the wizard, there are 'Previous', 'Next', and 'Cancel' buttons.

- c. From the WebSphere Application Server administrative console, click **Servers > Server Types > WebSphere application servers** to check that the cluster member servers are listed.
- d. If the status column indicates that nodes are not synchronized, click **System Administration > Nodes**, and then click **Synchronize** to synchronize your nodes to the deployment manager.

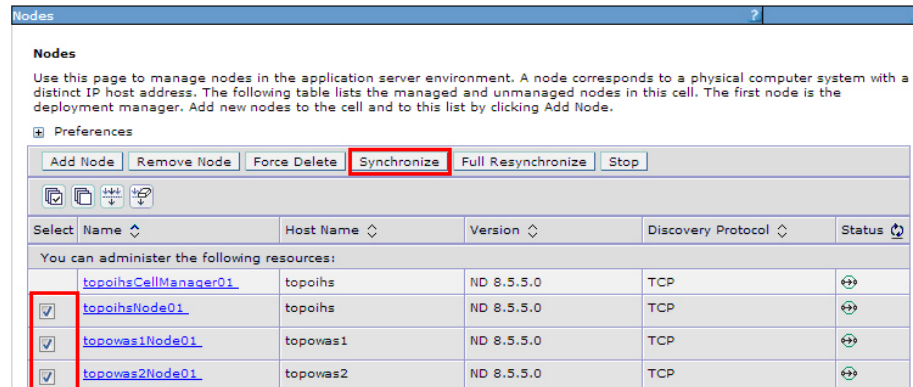

4. Install MobileFirst Server on Host1. Ensure that the WebSphere Application Server Network Deployment cluster is created without errors before you begin the installation. For installation instructions, see “Installing MobileFirst Server” on page 6-2.
5. Configure the databases. For instructions, see “Creating and configuring the databases with Ant tasks” on page 10-13.
6. In IBM MobileFirst Platform Command Line Interface for iOS, create a project and build a MobileFirst project WAR file. See “Artifacts produced during development cycle” on page 8-1.
7. Configure IBM MobileFirst Platform Foundation for iOS with the WebSphere Application Server Network Deployment cluster. For instructions, see “Deploying a project WAR file and configuring the application server with Ant tasks” on page 10-14. Modify the Ant template to match your WebSphere Application Server cluster and database server.
8. Verify the installation.
 - a. Restart the WebSphere Application Server cluster.
 - b. From the WebSphere Application Server administrative console, click **Resources > JDBC > Data sources**, and check that the data sources jdbc/WorklightAdminDS, jdbc/WorklightDS and jdbc/WorklightReportsDS exist. If Application Center is installed, check that the data source jdbc/AppCenterDS exists.

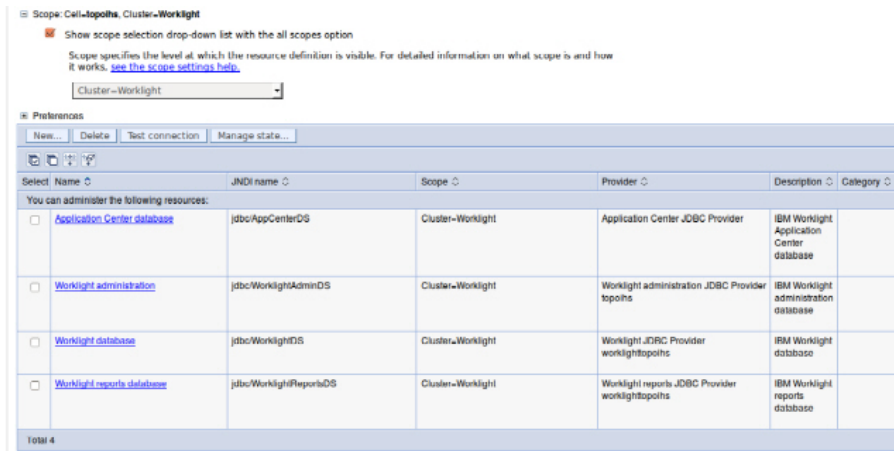

- c. Select the data sources and click **Test connection** to verify the DB2 database connection. Confirmations similar to the ones in the following messages indicate a successful connection.

The test connection operation for data source Application Center database on server nodeagent at node topowas1Node01 was successful.

The test connection operation for data source Application Center database on server nodeagent at node topowas2Node01 was successful.

- d. Go to **Applications > Application Types > WebSphere enterprise applications** and check that the MobileFirst Operations Console application is running.
- e. Now that you have deployed IBM MobileFirst Platform Foundation for iOS on the two node servers, you can access the MobileFirst Operations Console on each host by browsing to the associated URLs:
- <http://Host2:9080/worklightconsole>
 - <http://Host3:9080/worklightconsole>

Check that both MobileFirst Operations Console are running.

9. Configure the IBM HTTP Server.

- a. From the WebSphere Application Server administrative console, go to **Servers > Server Types > Web servers**, and then click **New** to create a new IBM HTTP server.

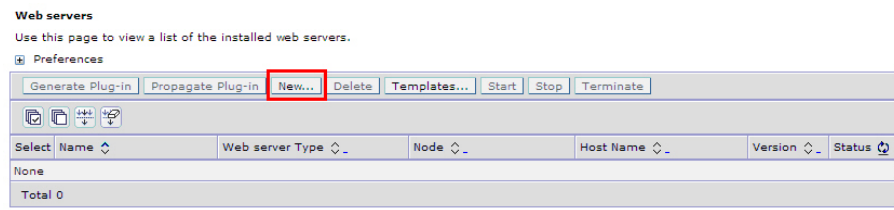

- b. Select the "ihs" node you previously created on Host1, then from the **Type** list, select **IBM HTTP Server**, and then click **Next**.

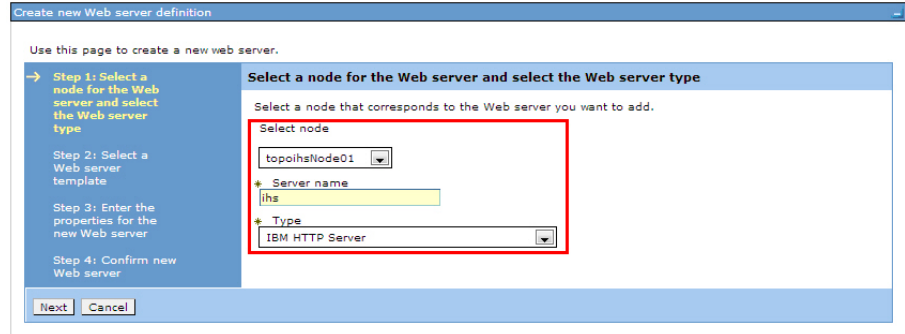

- c. Enter the IBM HTTP Server home and Web Server Plugins home you previously selected on Host1, and then click **Next** and save your configuration.

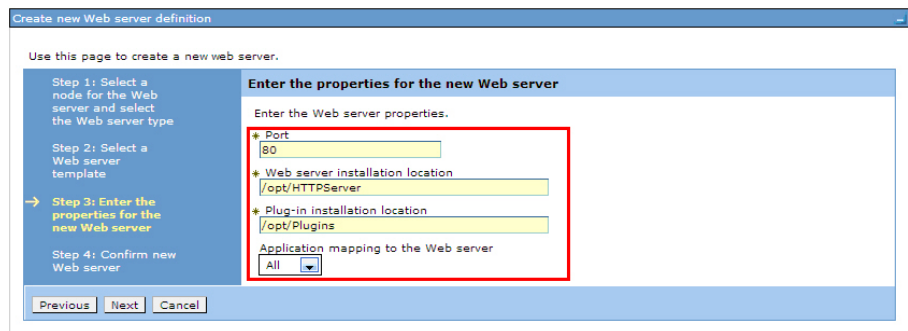

- d. In the administrative console, on the Web servers page, click **Generate Plug-in** to generate the plug-in configuration file.

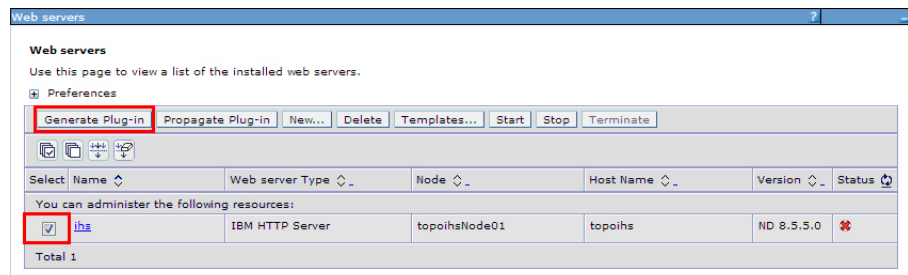

A confirmation message is displayed.

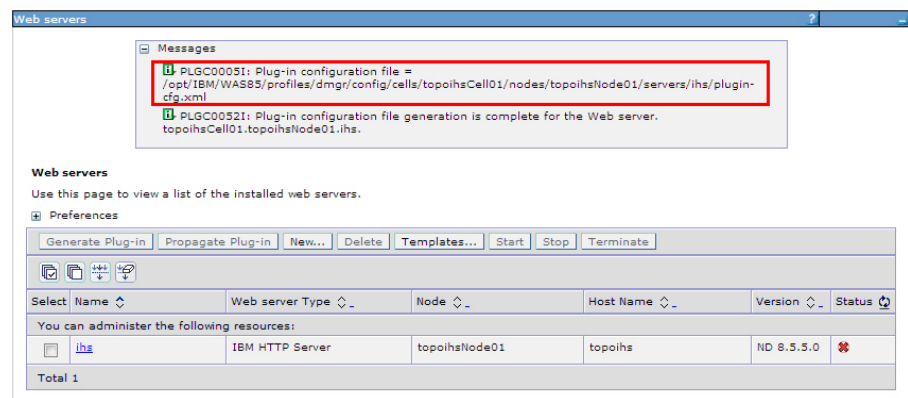

- e. Make a note of the `plugin-cfg.xml` location displayed in the confirmation message.

- f. In the administrative console, on the Web servers page, click **ihs**, and then in the **Configuration file name** field, click **Edit**.

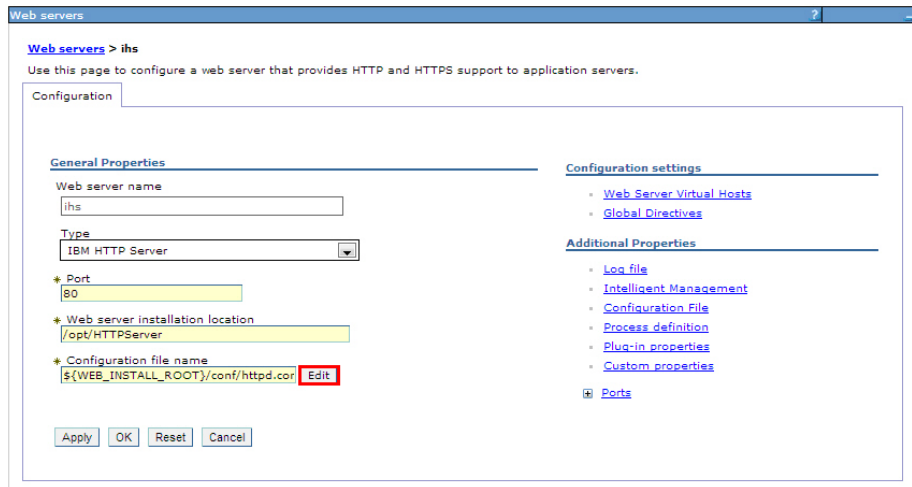

- g. In the editor, add a `was_ap22_module` and a `WebSpherePluginConfig` configuration to your `http.conf` file by adding the following text:

On Windows:

```
LoadModule was_ap22_module {IHS_Plugin_HOME}/bin/{64bits}/mod_was_ap22_http.dll
WebSpherePluginConfig {path to}/plugin-cfg.xml
```

On Linux:

```
LoadModule was_ap22_module {IHS_Plugin_HOME}/bin/{64bits}/mod_was_ap22_http.so
WebSpherePluginConfig {path to}/plugin-cfg.xml
```

- h. In the administrative console, on the Web servers page for the "ihs" server, click **Plug-in properties**.

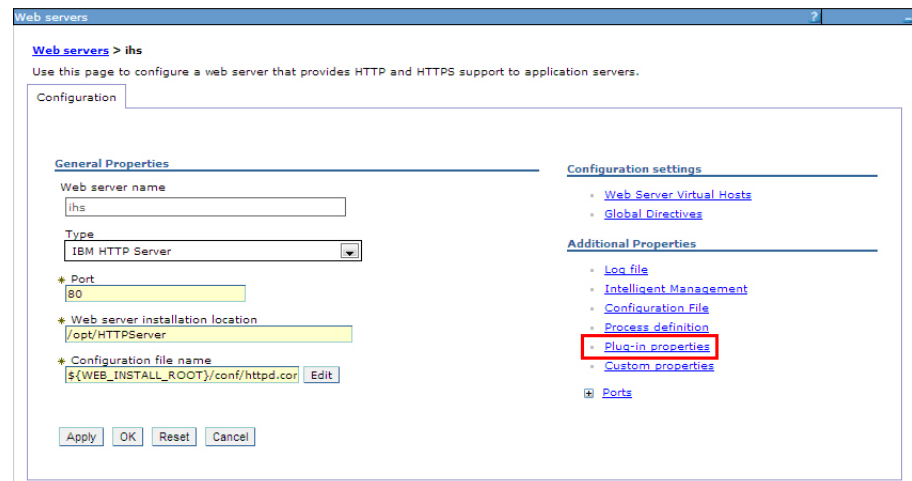

- i. In the **Plug-in Configuration file name** field, click **View**.

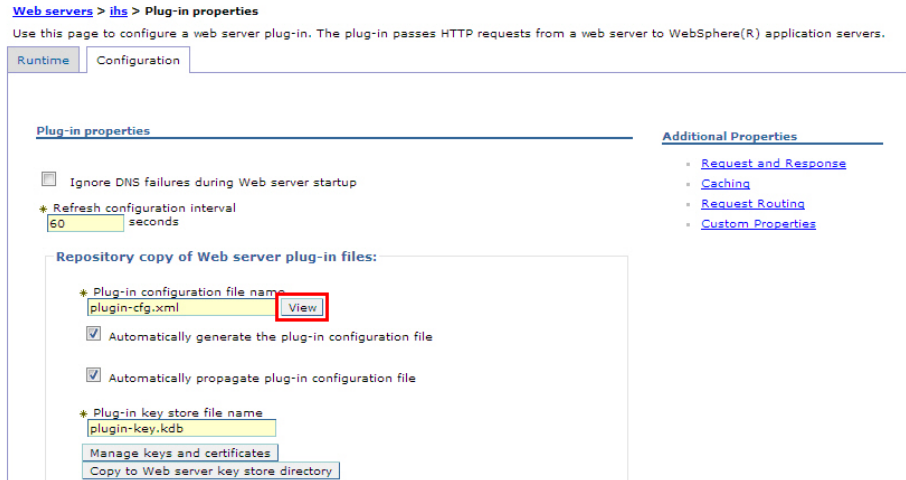

- j. Search for the cluster node and MobileFirst URI in the plugin-cfg.xml file.
For example:

```
<ServerCluster CloneSeparatorChange="false"
  GetDWLMTable="false"
  IgnoreAffinityRequests="true"
  LoadBalance="Round Robin"
  Name="Worklight"
  PostBufferSize="0"
  PostSizeLimit="-1"
  RemoveSpecialHeaders="true"
  RetryInterval="60"
  ServerIOTimeoutRetry="-1">
  <Server CloneID="17oi9lu2o"
    ConnectTimeout="5"
    ExtendedHandshake="false"
    LoadBalanceWeight="2"
    MaxConnections="-1"
    Name="topowas1Node01_server1"
    ServerIOTimeout="900"
    WaitForContinue="false">
    <Transport Hostname="topowas1" Port="9080" Protocol="http"/>
    <Transport Hostname="topowas1" Port="9443" Protocol="https">
      <Property Name="keyring" Value="/opt/Plugins/config/ihs/plugin-key.kdb"/>
      <Property Name="stashfile" Value="/opt/Plugins/config/ihs/plugin-key.sth"/>
    </Transport>
  </Server>
  <Server CloneID="17oi9m7kg"
    ConnectTimeout="5"
    ExtendedHandshake="false"
    LoadBalanceWeight="2"
    MaxConnections="-1"
    Name="topowas2Node01_server2"
    ServerIOTimeout="900"
    WaitForContinue="false">
    <Transport Hostname="topowas2" Port="9080" Protocol="http"/>
    <Transport Hostname="topowas2" Port="9443" Protocol="https">
      <Property Name="keyring" Value="/opt/Plugins/config/ihs/plugin-key.kdb"/>
      <Property Name="stashfile" Value="/opt/Plugins/config/ihs/plugin-key.sth"/>
    </Transport>
  </Server>

  <PrimaryServers>
    <Server Name="topowas1Node01_server1"/>
    <Server Name="topowas2Node01_server2"/>
  </PrimaryServers>
</ServerCluster>
```



```

<UriGroup Name="default_host_Worklight_URIs">
  <Uri AffinityCookie="JSESSIONID"
    AffinityURLIdentifier="jsessionid"
    Name="/appcenterconsole/*"/>
  <Uri AffinityCookie="JSESSIONID" AffinityURLIdentifier="jsessionid" Name="/worklight/*"/>
  <Uri AffinityCookie="JSESSIONID" AffinityURLIdentifier="jsessionid" Name="/applicationcenter/*"/>
</UriGroup>

```

If your configuration file does not include cluster servers and URIs, delete the "ihs" server and create it again.

- k. Optional: On the Plug-in properties page for the "ihs" server, click **Request Routing** if you want to set a load-balancing policy.

Additional Properties

- [Request and Response](#)
- [Caching](#)
- **[Request Routing](#)**
- [Custom Properties](#)

Request routing

Load balancing option
 Round Robin

* Retry interval
 1 seconds

Maximum size of request content

No Limit
 Set Limit

* Maximum buffer size used when reading the HTTP request content
 0 KBytes

Remove special headers
 Clone separator change

Apply OK Reset Cancel

- l. Optional: On the Plug-in properties page for the "ihs" server, click **Caching** if you want to configure caching.

Caching

Enable Edge Side Include (ESI) processing to cache the responses
 Enable invalidation monitor to receive notifications

Maximum cache size
 1024 KB

Apply OK Reset Cancel

10. Start the IBM HTTP server and verify that the server is running.
 - a. In the WebSphere Application Server administrative console, go to **Servers > Server Types > Web servers**.
 - b. Select the IBM HTTP server you created (in this example, named "ihs"), and then click **Start**.

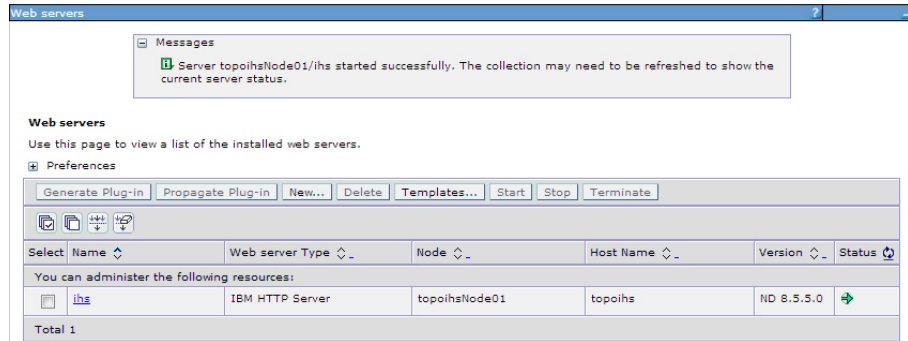

- c. If the server fails to start, check the log file. To find the location of the log file:
- 1) In the administrative console, on the Web servers page for the "ihs" server, click **Log file**.
 - 2) On the log file page, click the **Configuration** tab.
 - 3) The location of the log file is displayed in the **Error log file name** field.

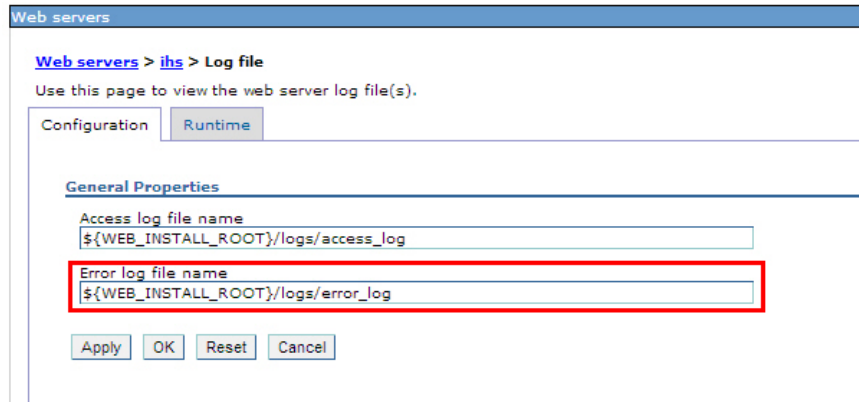

- d. To verify that the IBM HTTP server is running, enter the URL for the MobileFirst Operations Console in a web browser. For example:
 http://Host1:80/worklightconsole.

Results

IBM MobileFirst Platform Foundation for iOS is now installed on an IBM WebSphere Application Server Network Deployment cluster, and is ready for use.

Setting up an IBM HTTP Server in an IBM WebSphere Application Server Liberty profile farm

You can set up a MobileFirst cluster environment with Liberty profile.

Before you begin

Install a server farm for Liberty. See "Installing a server farm" on page 6-97. If a server farm is not configured, the MobileFirst Server installation does not work properly, and changes made by using the MobileFirst Operations Console or Administration Service are not replicated to all the servers of the farm, resulting in inconsistent behavior for client devices that connect to the MobileFirst Server.

About this task

You can set up IBM MobileFirst Platform Foundation for iOS in the topology similar to the one shown in Figure 6-22.

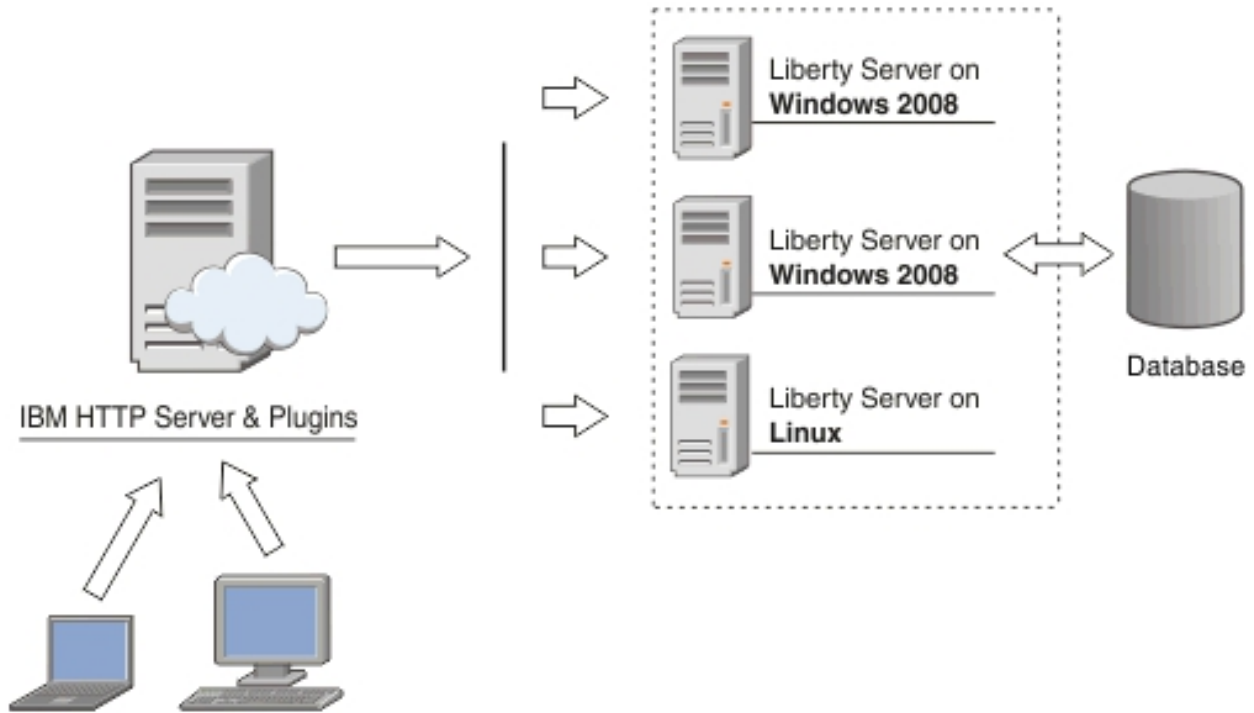

Figure 6-22. MobileFirst cluster topology with Liberty profile

If you install IBM HTTP Server, the administration components require certain JNDI properties to be configured. For more information, see “Using a reverse proxy with server farm and WebSphere Application Server Network Deployment topologies” on page 6-18 and “Defining the endpoint of the MobileFirst Administration services” on page 6-78.

This procedure uses the hardware listed in Table 6-60 and the software listed in Table 6-61 on page 6-254.

Table 6-60. Hardware

Hostname	Operating system	Description
Host1	RHEL 6.2	IBM HTTP server with Web Server plug-in, acting as load balancer.
Host2	RHEL 6.2	Liberty farm server 1
Host3	RHEL 6.2	Liberty farm server 2
Host4	RHEL 6.2	DB2 server

Table 6-61. Software

Name	Description
IBM Installation Manager	Install IBM HTTP Server , IBM Liberty profile, and IBM MobileFirst Platform Foundation for iOS.
IBM HTTP Server	You need to get access to the installation repository before you start the procedure. IBM HTTP Server is also included in the WebSphere Application Server installation repository.
Web Server Plug-ins	You need to get access to the installation repository before you start the procedure. IBM HTTP Server Plugin is also included in the WebSphere Application Server installation repository.
IBM Liberty profile	You need to get access to the installation repository before you start the procedure. IBM Liberty profile is also included in the WebSphere Application Server installation repository.
IBM MobileFirst Platform Foundation for iOS	You need to get access to the installation repository before you start the procedure.
IBM DB2	Your DB2 server must be available before you start the IBM MobileFirst Platform Foundation for iOS installation.

Procedure

1. Install IBM HTTP Server and Web Server Plugins.
 - a. On the Host1 machine. log on with the “root” user ID and run IBM Installation Manager to install the IBM HTTP server and Web Server Plugins. This documentation assumes that the applications are installed in the following places:

IBM HTTP Server home
/opt/HTTPServer

Web Server Plugins home
/opt/Plugins
2. Start the Liberty profile servers to test whether you can access the MobileFirst Operations Console on Host2 and Host3 by browsing to the associated URLs:
 - http://Host2:9080/worklight/console
 - http://Host3:9080/worklight/console

Check that both MobileFirst Operations Console are running.
3. Run the following command on Host1 to start the IBM HTTP server.

```
/opt/HTTPServer/bin/httpd -d /opt/HTTPServer -k start -f /opt/HTTPServer/conf/httpd.conf
```

If you encounter problems during IBM HTTP server startup, see “Troubleshooting IBM HTTP Server startup” on page 6-259.
4. Ensure that the IBM HTTP Server can be accessed at the following URL in a web browser:

```
http://<hostname>:<port>
```

5. For each Liberty server, generate a web server plug-in configuration file named `plugin-cfg.xml`. The web server plug-in is used to forward HTTP requests from the web server to the application server.

a. Start the server that hosts your applications and ensure that the `localConnector-1.0` feature and other required features are included in the server configuration. Use the `pluginConfiguration` element in the server configuration file to specify the `webserverPort` and `webserverSecurePort` attributes for requests that are forwarded from the web server. By default, the value of `webserverPort` is 80 and the value of `webserverSecurePort` is 443. Assign the value `*` to the host attribute to ensure that applications on the Liberty server can be accessed from a remote browser. Here is an example of a `server.xml` server configuration file:

```
<server description="new server">
  <featureManager>
    <feature>localConnector-1.0</feature>
    <feature>jsp-2.2</feature>
  </featureManager>
  <httpEndpoint id="defaultHttpEndpoint" host="*" httpPort="9080">
    <tcpOptions soReuseAddr="true" />
  </httpEndpoint>
  <pluginConfiguration webserverPort="80" webserverSecurePort="443"/>
</server>
```

b. Use one of the following methods to generate the `plugin-cfg.xml` file for the Liberty server running your application.

- jConsole:

- 1) Using the same JDK as the server, run the jConsole Java utility from a command prompt. For example, run the following command:

```
C:\java\bin\jconsole
```

- 2) In the jConsole window, click **Local Process**, click the server process in the list of local processes, and then click **Connect**.

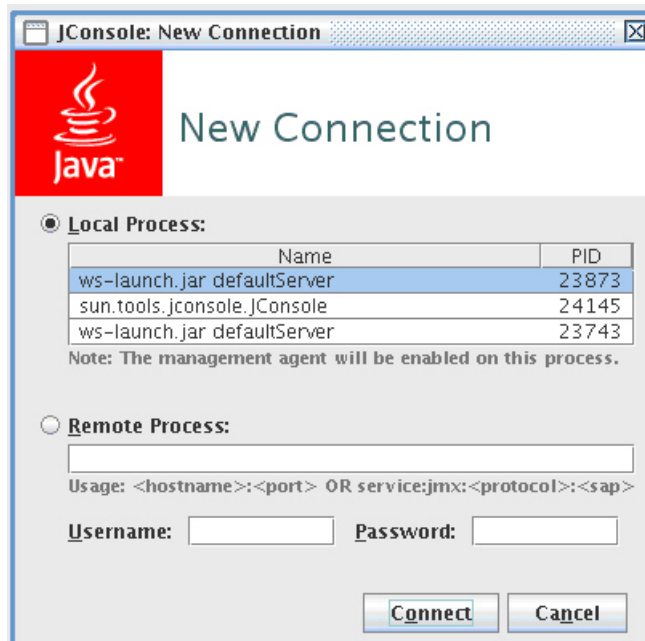

- 3) In the Java Monitoring & Management Console, click the **MBeans** tab.

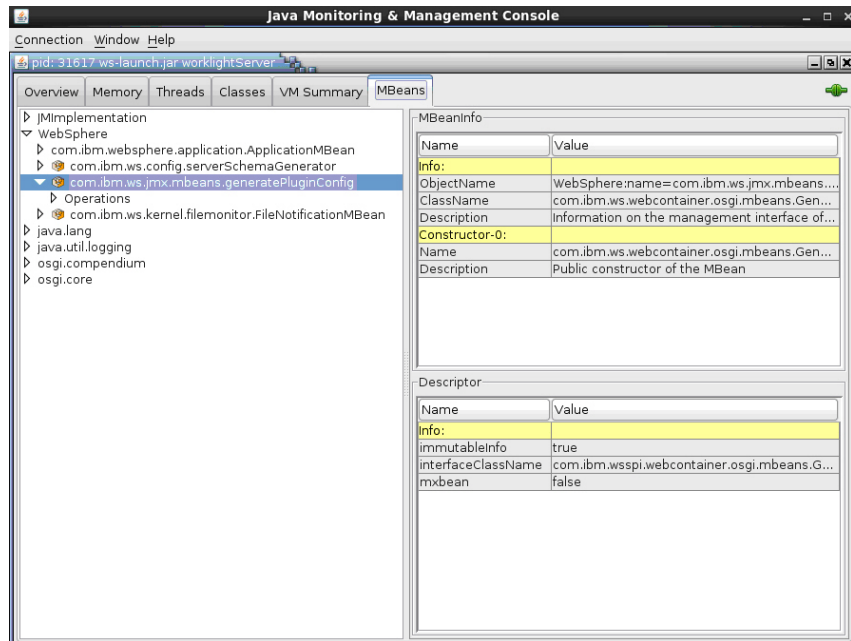

- 4) Select and invoke the defaultPluginConfig generation MBean operation to generate the plugin-cfg.xml file.

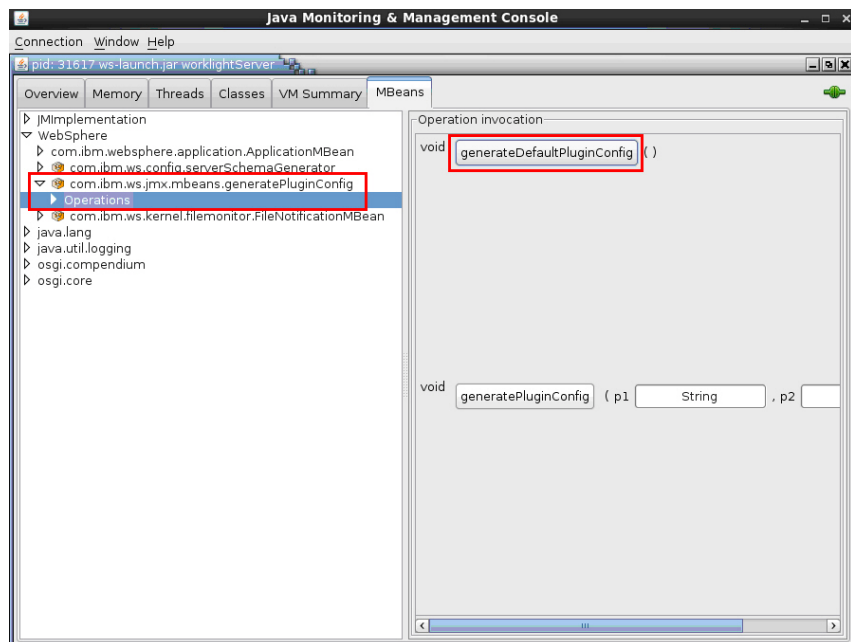

You can find the generated file in the `\wlp\usr\servers\` directory. Here is an example:

```
<?xml version="1.0" encoding="UTF-8"?>
<Config ASDisableNagle="false"
  AcceptAllContent="false"
  AppServerPortPreference="HostHeader"
  ChunkedResponse="false"
  FIPSEnable="false"
  IISDisableNagle="false"
  IISPluginPriority="High"
  IgnoreDNSFailures="false"
  RefreshInterval="60"
  ResponseChunkSize="64"
```

```

SSLConsolidate="false"
SSLPKCSDriver="REPLACE"
SSLPKCSPassword="REPLACE"
TrustedProxyEnable="false"
VHostMatchingCompat="false">
<Log LogLevel="Error" Name="String\logs\String\http_plugin.log"/>
<Property Name="ESIEnable" Value="true"/>
<Property Name="ESIMaxCacheSize" Value="1024"/>
<Property Name="ESIInvalidationMonitor" Value="false"/>
<Property Name="ESIEnableToPassCookies" Value="false"/>
<Property Name="PluginInstallRoot" Value="String"/>
<VirtualHostGroup Name="default_host">
  <VirtualHost Name="*:443"/>
  <VirtualHost Name="*:80"/>
  <VirtualHost Name="*:9080"/>
</VirtualHostGroup>
<ServerCluster CloneSeparatorChange="false"
  GetDWLMTable="false"
  IgnoreAffinityRequests="true"
  LoadBalance="Round Robin"
  Name="String_default_node_Cluster"
  PostBufferSize="64"
  PostSizeLimit="-1"
  RemoveSpecialHeaders="true"
  RetryInterval="60">
  <Server CloneID="s56"
    ConnectTimeout="0"
    ExtendedHandshake="false"
    MaxConnections="-1"
    Name="default_node_String0"
    ServerIOTimeout="900"
    WaitForContinue="false">
    <Transport Hostname="wasvm56" Port="9080" Protocol="http"/>
  </Server>
  <PrimaryServers>
    <Server Name="default_node_String0"/>
  </PrimaryServers>
</ServerCluster>
<UriGroup Name="default_host_String_default_node_Cluster_URIs">
  <Uri AffinityCookie="JSESSIONID" AffinityURLIdentifier="jsessionid" Name="/tri-web/*"/>
</UriGroup>
<Route ServerCluster="String_default_node_Cluster"
  UriGroup="default_host_String_default_node_Cluster_URIs"
  VirtualHostGroup="default_host"/>
</Config>

```

- Eclipse:
 - 1) Make sure your Liberty server is started.
 - 2) In Eclipse, in the servers panel, right-click the Liberty server, and then click **Utilities > Generate Plugin Config**.
- c. Copy the plugin-cfg.xml file to the machine that hosts the IBM HTTP Server web server, and then restart the web server to activate the settings in the file. Typically, you must enable the plug-in within the httpd.conf file of the web server by using the LoadModule phrase, and you must specify the location of the plugin-cfg.xml file using the WebSpherePluginConfig phrase.

On Windows:

```

LoadModule was_ap22_module "path\to\mod_was_ap22_http.dll"
WebSpherePluginConfig "path\to\plugin-cfg.xml"

```

On other distributed systems:

```

LoadModule was_ap22_module "path\to\mod_was_ap22_http.so"
WebSpherePluginConfig "path\to\plugin-cfg.xml"

```

6. Use one of the following methods to merge the `plugin-cfg.xml` files for all the Liberty servers in the cluster.
 - Manually merge the files using a text editor.
 - Use the job manager to submit a **Generate merged plugin configuration for Liberty servers** job.

For more information about the job manager, see [Generating a merged plug-in configuration for Liberty profile servers using the job manager](#).

7. Verify that workloads are distributed to multiple Liberty servers via the IBM HTTP Server and Web Server Plugins.
 - a. Ensure that session affinity is enabled.

To do so, check that a **CloneID** attribute is included for each server in the `plugin-cfg.xml` file of the IBM HTTP Server and Web Server Plugins. Although you can generate **CloneID** values automatically, in production environments, you must specify particular strings in the Liberty Profile `server.xml` file. See [Configuring session persistence for the Liberty profile](#).

If you do not specify particular strings, the value of the **CloneID** might change under some circumstances and session affinity would stop working. Automatically generated **CloneID** should not be used in a production environment. In WebSphere Application Server Liberty profile, the **CloneID** is generated when you start a server for the first time; it is regenerated if you start the server with the `--clean` option.

In production use, manually assigning a clone ID ensures that the **CloneID** is stable and that request affinity is correctly maintained. The **CloneID** must be unique for each server and can be 8 to 9 alphanumeric characters in length.

The following example shows **CloneID** attributes specified for three servers:

```
<ServerCluster CloneSeparatorChange="false"
  GetDWLMTable="false"
  IgnoreAffinityRequests="true"
  LoadBalance="Round Robin"
  Name="String_default_node_Cluster1"
  PostBufferSize="64"
  PostSizeLimit="-1"
  RemoveSpecialHeaders="true"
  RetryInterval="60">
  <Server CloneID="s59"
    ConnectTimeout="0"
    ExtendedHandshake="false"
    MaxConnections="-1"
    Name="default_node_String1"
    ServerIOTimeout="900"
    WaitForContinue="false">
    <Transport Hostname="wasvm59.example.com" Port="9080" Protocol="http"/>
  </Server>
  <Server CloneID="s56"
    ConnectTimeout="0"
    ExtendedHandshake="false"
    MaxConnections="-1"
    Name="default_node_String2"
    ServerIOTimeout="900"
    WaitForContinue="false">
    <Transport Hostname="wasvm56.example.com" Port="9080" Protocol="http"/>
  </Server>
  <Server CloneID="vm28"
    ConnectTimeout="0"
    ExtendedHandshake="false"
    MaxConnections="-1"
    Name="default_node_String3"
    ServerIOTimeout="900"
```



```

        WaitForContinue="false">
        <Transport Hostname="wasvm28.example.com" Port="9080" Protocol="http"/>
    </Server>
</PrimaryServers>
    <Server Name="default_node_String1"/>
    <Server Name="default_node_String2"/>
    <Server Name="default_node_String3"/>
</PrimaryServers>
</ServerCluster>

```

- b. Ensure that each Liberty server is started.
- c. Verify that round-robin load-balancing is successfully routing application requests to each of the backend Liberty servers.

Troubleshooting IBM HTTP Server startup

Problems to start the IBM HTTP Server during deployment of an IBM MobileFirst Platform Server on a WebSphere Application Server Liberty profile farm might be caused by an exception in the runtime library.

About this task

When you set up IBM MobileFirst Platform Foundation for iOS on a WebSphere Application Server Liberty profile farm, you are instructed to start the IBM HTTP Server by running the following command:

```
/opt/HTTPServer/bin/httpd -d /opt/HTTPServer -k start -f /opt/HTTPServer/conf/httpd.conf
```

If the attempt fails with the following message, the problem might be caused by an attempt to start IBM HTTP Server outside a WebSphere Application Server environment in which certain libraries cannot be found.

```
/opt/HTTPServer/bin/httpd: error while loading shared libraries: libexpat.so.0:
cannot open shared object file: No such file or directory
```

If a similar message is displayed, you can make the required libraries available as follows.

Procedure

1. Check the IBM HTTP Server libraries:

```
ldd /opt/HTTPServer/bin/httpd
```

The output shows that libexpat.so.0 cannot be found:

```

linux-vdso.so.1 => (0x00007fff8c9d3000)
libm.so.6 => /lib64/libm.so.6 (0x00000039fb000000)
libaprutil-1.so.0 => /usr/lib64/libaprutil-1.so.0 (0x00007fc371a7d000)
librt.so.1 => /lib64/librt.so.1 (0x00000039fac00000)
libcrypt.so.1 => /lib64/libcrypt.so.1 (0x0000003a07c00000)
libpthread.so.0 => /lib64/libpthread.so.0 (0x00000039fa800000)
libdl.so.2 => /lib64/libdl.so.2 (0x00000039fa000000)
libexpat.so.0 => not found
libapr-1.so.0 => /usr/lib64/libapr-1.so.0 (0x00007fc37184f000)
libc.so.6 => /lib64/libc.so.6 (0x00000039fa400000)
libuuid.so.1 => /lib64/libuuid.so.1 (0x0000003a04c00000)
libexpat.so.1 => /lib64/libexpat.so.1 (0x00000039ff400000)
libdb-4.7.so => /lib64/libdb-4.7.so (0x00000039fd800000)
/lib64/ld-linux-x86-64.so.2 (0x00000039f9c00000)
libfreebl3.so => /lib64/libfreebl3.so (0x0000003a08000000)

```

2. Find the library on the file system.

```
ls -l `locate libexpat.so.0`
```

```
[root@topowas1 opt]# ls -l `locate libexpat.so.0`
lrwxrwxrwx. 1 root root    17 Apr 20 04:20 /opt/HTTPServer/lib/libexpat.so.0 -> lib
expat.so.0.1.0
-rwxr-xr-x. 1 root root 158148 Feb 20 13:54 /opt/HTTPServer/lib/libexpat.so.0.1.0
```

3. Check /etc/ld.so.conf.

```
cat /etc/ld.so.conf
```

The output shows that it includes all conf files under /etc/ld.so.conf.d/.

```
include ld.so.conf.d/*.conf
```
4. Add the IBM HTTP Server library to the configuration.
 - a.

```
cd /etc/ld.so.conf.d/
```
 - b. Add the http library to the system configuration. The location of the IBM HTTP Server lib is shown in Step 1.

```
echo /opt/HTTPServer/lib > httpd-lib.conf
```
 - c. Remove the ldd cache.

```
rm /etc/ld.so.cache
```
 - d. Reload the ldd configuration.

```
/sbin/ldconfig
```
5. Check the IBM HTTP Server libraries again:

```
ldd /opt/HTTPServer/bin/httpd
```

The output shows that libexpat.so.0 is available:

```
linux-vdso.so.1 => (0x00007ffffd594a000)
libm.so.6 => /lib64/libm.so.6 (0x00000039fb000000)
libaprutil-1.so.0 => /opt/HTTPServer/lib/libaprutil-1.so.0 (0x00007f20474bf000)
librt.so.1 => /lib64/librt.so.1 (0x00000039fac00000)
libcrypt.so.1 => /lib64/libcrypt.so.1 (0x0000003a07c00000)
libpthread.so.0 => /lib64/libpthread.so.0 (0x00000039fa800000)
libdl.so.2 => /lib64/libdl.so.2 (0x00000039fa000000)
libexpat.so.0 => /opt/HTTPServer/lib/libexpat.so.0 (0x00007f204739c000)
libapr-1.so.0 => /opt/HTTPServer/lib/libapr-1.so.0 (0x00007f2047271000)
libc.so.6 => /lib64/libc.so.6 (0x00000039fa400000)
/lib64/ld-linux-x86-64.so.2 (0x00000039f9c00000)
libfreebl3.so => /lib64/libfreebl3.so (0x0000003a08000000)
```

6. Start the IBM HTTP Server.

Integrating IBM WebSphere DataPower with a cluster of instances of MobileFirst Server

You can use IBM WebSphere DataPower as a gateway for all incoming connections for IBM MobileFirst Platform Foundation for iOS and Application Center, and IBM HTTP Server (IHS) for load-balancing MobileFirst Server that are deployed on an IBM WebSphere Application Server 8.5 cluster or a Liberty profile server farm.

Before you begin

Ensure that the following environments are available:

- MobileFirst Server is deployed on an IBM WebSphere Application Server ND cluster or on a Liberty profile server farm and is configured to use DB2 or any compatible database. For more information, see “Typical topologies of a MobileFirst instance in an extranet infrastructure” on page 6-239.
- IBM MobileFirst Platform Foundation for iOS Application Center is set up on an IBM WebSphere Application Server ND cluster. For more information, see “Installing and configuring the Application Center” on page 6-162.

- IBM WebSphere DataPower XI52.
- IBM HTTP Server.
- Any LDAP server with SSL enabled.

About this task

This procedure explains how to set up IBM MobileFirst Platform Foundation for iOS in the topology similar to the one shown in Figure 6-23.

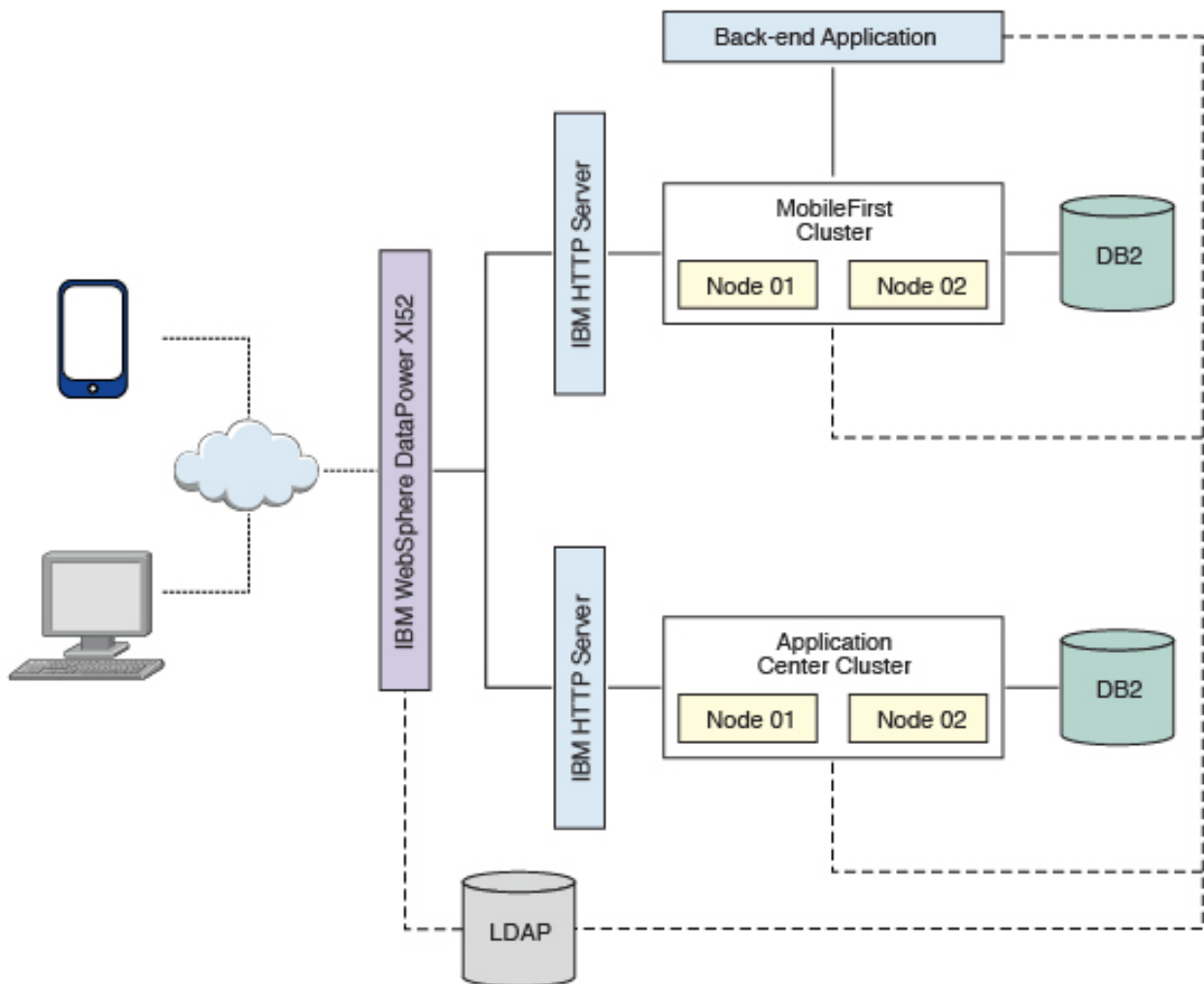

Figure 6-23. IBM MobileFirst Platform Foundation for iOS integration with an IBM WebSphere Application Server 8.5 Cluster or a Liberty profile Server Farm

DataPower XI52 acts as the gateway for all IBM MobileFirst Platform Foundation for iOS and Application Center requests. DataPower validates all incoming user credentials against an LDAP registry. If the validation is successful, DataPower generates an LTPA token, which is present as part of a session cookie. This cookie is only valid for one session and is used for all further requests during that session. The cookies themselves contain information about the user that has been authenticated, the realm for which the user was authenticated (such as an LDAP server) and a timestamp. A request with a valid LTPA cookie can access a server that is a member of the same authentication domain as the first server. The request is automatically authenticated, thereby enabling single-sign-on (SSO).

All requests that reach the MobileFirst cluster or the backend application validate only the LTPA token. If the LTPA token is valid, the request is authenticated according to the rules that are set. The LTPA token guarantees that as long as the token is valid, all requests have SSO capability into all backend servers, including IBM MobileFirst Platform Foundation for iOS and Application Center.

The following sequence of events takes place when a mobile application makes a request (see Figure 6-24):

1. The mobile application makes a request to the DataPower gateway.
2. DataPower checks for an LTPA token in the incoming request.
3. If a valid LTPA token is present, the request is sent to the IBM MobileFirst Platform Foundation for iOS cluster.
 - If an LTPA token is not present or if the token is not valid, DataPower throws an authentication challenge. The mobile application handles the challenge and then prompts for user credentials.
4. The MobileFirst cluster validates the LTPA token and sends the request to the backend application server along with the LTPA token.
5. The backend application server validates the LTPA token and sends the response back to IBM MobileFirst Platform Foundation for iOS.
6. IBM MobileFirst Platform Foundation for iOS forwards the request to DataPower, and DataPower forwards it to the requesting mobile application.

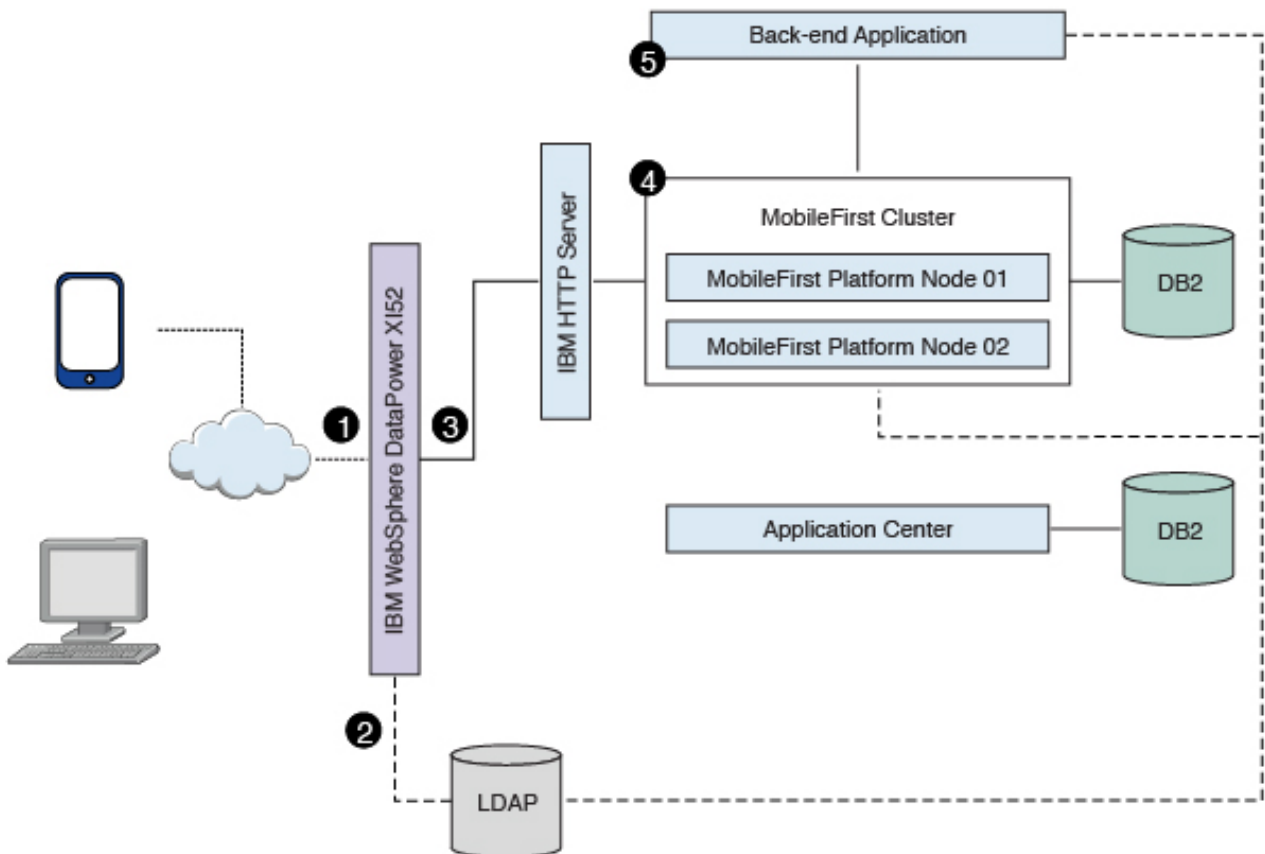

Figure 6-24. Mobile application request-response flow

The Application Center request-response flow takes a similar route to the mobile application flow, except that requests are routed to the Application Center server instead of to the MobileFirst cluster (see Figure 6-25).

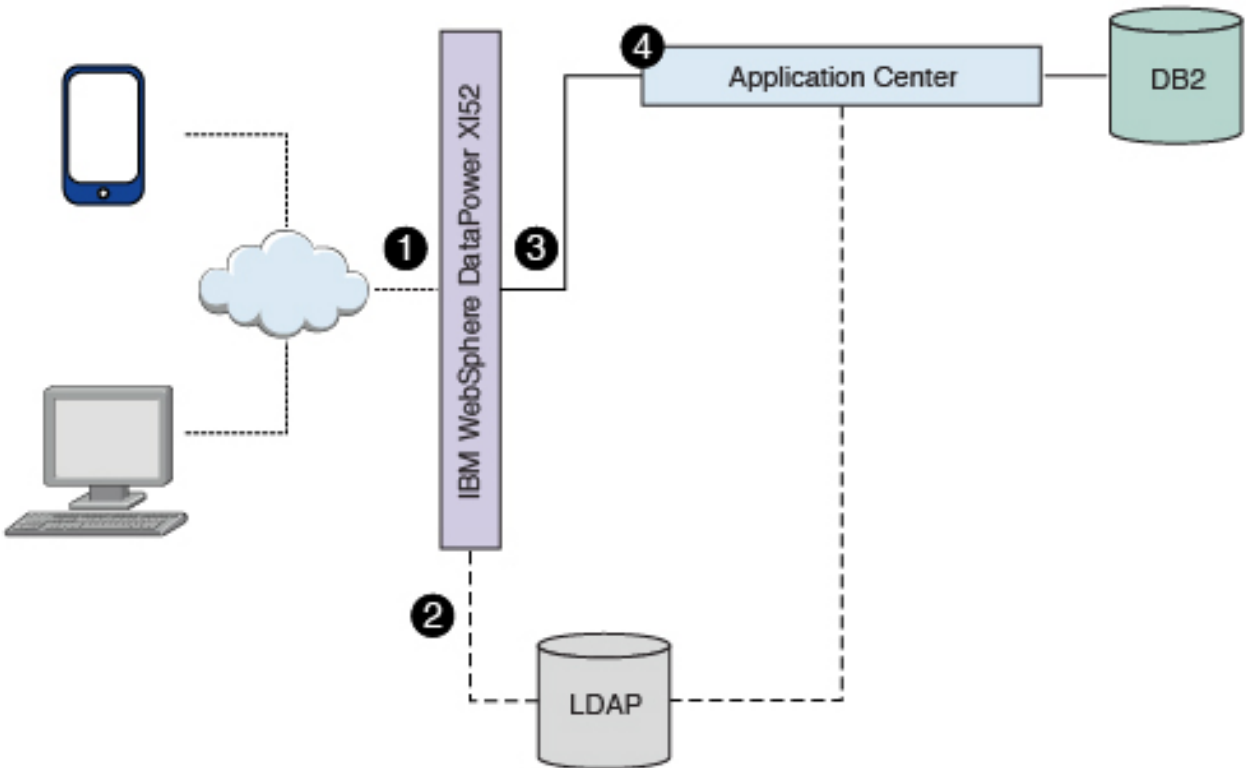

Figure 6-25. Application Center request-response flow

Procedure

1. Configure server security.
 - On a WebSphere Application Server cluster:
 - a. Login to the WebSphere Application Server integrated solutions console.
 - b. Enable and configure application security.
 - 1) Navigate to **Security > Global security**, and then click **Security Configuration Wizard**.
 - 2) In the "Specify extent of protection" pane, select **Enable application security**.
 - 3) In the "Select user repository" pane, click **Federated repositories** to integrate with the LDAP server. Several different repositories, both LDAP and non-LDAP, can be configured in the federated repository. Enter the LDAP server details. Refer to the WebSphere Application Server documentation for detailed instructions.
 - 4) Complete the configuration steps and save your changes.
 - 5) On the "Global security" page, confirm that the following settings apply:
 - The **Enable administrative security** is selected.
 - The user account repository is set to LDAP.

- c. Enable WebSphere Application Server LTPA SSO between the MobileFirst Server cluster and backend servers. To support SSO across multiple WebSphere Application Server domains or cells, you must share the LTPA keys and the password among the domains. You need to export the LTPA keys from one of the domains and import them into all other domains in which you want to enable SSO. For detailed instructions, see *Configuring LTPA and working with keys*.
- d. Stop and restart the WebSphere Application Server cluster for the application security changes to take effect.
- On a Liberty profile server farm:
 - a. Integrate the LDAP server with Liberty profile, For detailed instructions, see *Configuring LDAP user registries with the Liberty profile*. You must configure LDAP user registries on each member of the liberty server farm. The following file is a sample LDAP configuration for Liberty server:

```
<!-- LDAP configuration Start -->
<ldapRegistry id="IBMDirectoryServerLDAP" realm="WASLTPARealm"
  host="9.186.9.169" port="389" ignoreCase="true"
  baseDN="dc=worklight,dc=com"
  bindDN="cn=admin,dc=worklight,dc=com"
  bindPassword="passw0rd"
  ldapType="IBM Tivoli Directory Server">
<idsFilters userFilter="(&(uid=%v)(objectclass=posixAccount))"
  groupFilter="(&(cn=%v)(objectclass=posixGroup))"
  userIdMap="*:uid"
  groupIdMap="*:cn"
  groupMemberIdMap="ibm-allGroups:member;ibm-allGroups:uniqueMember;
  groupOfNames:member;groupOfUniqueNames:uniqueMember" />
</ldapRegistry>
```

- b. Configure SSO for the Liberty server farm. To enable SSO on Liberty, you must configure an LTPA key file for each Liberty server in the Liberty farm. See *Configuring LTPA on the Liberty profile*. The following file is a sample LTPA configuration for Liberty server:

```
<ltpa keysFileName="{server.config.dir}/resources/security/ltpa.keystore" keysPassword="passw0rd" expiration="120" />
```

2. Configure MobileFirst Server.

You can secure IBM MobileFirst Platform Foundation for iOS in a typical WebSphere Application Server runtime environment in two ways:

Option 1

Securing WebSphere Application Server using application security and securing the IBM MobileFirst Platform Foundation for iOS WAR file.

Option 2

Securing WebSphere Application Server using application security but not securing the IBM MobileFirst Platform Foundation for iOS WAR file.

Option 1 provides greater authentication security. The application server, such as the IBM WebSphere Application Server Liberty profile (Liberty) protects all resources and forces users to log in before any other authentication mechanism. The behavior occurs regardless of the expected authentication order for a security test. See “Supported configurations for LTPA” on page 10-90 for more information.

Once the user has been successfully authenticated, an LTPA token is returned. This LTPA token needs to be present as part of all future requests from the mobile application, including adapter invocations. On the MobileFirst Server side, the call to the backend application should be modified to carry this LTPA token.

For the purpose of explaining how this is done, assume that authentication configuration has a security test that uses a realm called WASLTPARealm, which is of type WebSphere LTPA. Assume also that there is an HTTP adapter defined on the server. Assume that the adapter is called SecureAdapter, and that it contains a procedure called getAccountInfo.

The following code snippet shows how to pass the LTPA token when invoking an adapter procedure from the mobile application.

```
function getAccountInfo(){
  var ltpaToken
  if(WL.Client.isUserAuthenticated('WASLTPARealm')){
    var attrs = WL.Client.getUserInfo('WASLTPARealm', 'attributes');
    if(attrs){
      ltpaToken = attrs.LtpaToken;
      console.log('Set ltpaToken again: '+ltpaToken);
    }
  }

  var token = {'LtpaToken2' : ltpaToken};
  var invocationData = {
    adapter: "SecureAdapter",
    procedure: "getAccountInfo",
    parameters: [token]
  };

  WL.Client.invokeProcedure(invocationData, {
    onSuccess: <on success callback>,
    onFailure: <on failure callback>
  });
}
```

On the server side, the adapter procedure needs to get the token, which is passed as a parameter. This parameter holds the LTPA token information that is used by the adapter to contact the backend service.

```
function getAccountInfo(token) {
  WL.Logger.info(token);

  var input = {
    method : 'get',
    returnedContentType : 'xml',
    cookies: token,
    path : '<path to the backend service>'
  };

  return WL.Server.invokeHttp(input);
}
```

Since V6.2.0, MobileFirst Server is composed of one or more runtime environments, an administration console and administration services, an enterprise application store, and an operational analytics feature. MobileFirst Server components run as web applications on an application server. For more information about MobileFirst Server components, see “Introduction to the MobileFirst Server components” on page 6-5.

The roles associated with the MobileFirst Operations Console and Administration Services components are different from the role defined in the WASLTPAModule login module (see “WASLTPAModule login module” on page 8-285). The MobileFirst Operations Console and Administration services roles should be mapped to the IT administrator users who are responsible for running administration tasks on the mobile application such as application deployment, management, version enforcement, and management of push notifications.

The roles defined in the WASLTPAModule login module are part of the MobileFirst runtime environments. These roles should be mapped to the users

or user groups that have been cleared to access the MobileFirst applications. MobileFirst Operations Console and Administration Services must be set up and configured before you proceed to deploy the MobileFirst runtime services. See the following instructions depending on your application server, to map the administration user roles for MobileFirst Operations Console and Administration Services:

- “Configuring WebSphere Application Server full profile for MobileFirst Server administration” on page 6-84
- “Configuring WebSphere Application Server Liberty profile for MobileFirst Server administration” on page 6-85

Once the runtime deployment is completed, you need to map the users against the roles defined in the WASLTPAModule login module or web.xml. In the WebSphere Application Server console, open the application configuration tab of the deployed MobileFirst Server and click **Security role to user/group mapping** to map the LDAP user to the MobileFirst roles.

Detail Properties

- [Target specific application status](#)
- [Startup behavior](#)
- [Application binaries](#)
- [Class loading and update detection](#)
- [Request dispatcher properties](#)
- [Security role to user/group mapping](#)
- [JASPI provider](#)
- [Custom properties](#)
- [View Deployment Descriptor](#)
- [Last participant support extension](#)

Figure 6-26. Mapping the LDAP user to WebSphere Application Server

Select your role name and click **Map users** to map the LDAP user to this application.

For IBM Worklight V6.0 and earlier, you must edit the web.xml file and add the user roles. For V6.1.0 and later, the roles can be added as part of the WASLTPAModule login module. See “WASLTPAModule login module” on page 8-285.

3. Configure Application Center.
 - a. Complete the following configuration tasks depending on the server being used:
 - “Configuring WebSphere Application Server full profile” on page 6-189
 - “Configuring WebSphere Application Server Liberty profile” on page 6-191
 - b. Manage users with LDAP.

Application Center uses two security roles: appcenteradmin and appcenteruser. The LDAP users need to be mapped against the security roles.

Depending on the server that you are using, refer to the "Configuring LDAP authentication" section under one of the following documentation links:

- "LDAP with WebSphere Application Server V7" on page 6-194
- "LDAP with WebSphere Application Server V8.x" on page 6-200
- "LDAP with Liberty profile" on page 6-204

c. Define the endpoint of the application resources.

In this configuration, Application Center is behind DataPower, which is acting as a secure reverse proxy. To manage the applications on your device, the Application Center console must be able to locate the Application Center REST services and generate the required number of URI that enable the mobile client to find the Application Center REST services.

By default, the URI protocol, host name, and port are the same as those defined in the web application server used to access the Application Center console; the context root of the Application Center REST services is `applicationcenter`. When the context root of the Application Center REST services is changed or when the internal URI of the web application server is different from the external URI that can be used by the mobile client, the externally accessible endpoint (protocol, host name, and port) of the application resources must be defined by configuring the web application server. (Reasons for separating internal and external URI could be, for example, a firewall or a secured reverse proxy that uses HTTP redirection.)

The following Application Center JNDI properties must reference the DataPower gateway's details:

- **`ibm.appcenter.services.endpoint`**
- **`ibm.appcenter.proxy.protocol`**
- **`ibm.appcenter.proxy.host`**
- **`ibm.appcenter.proxy.port`**

Depending on the server type, set the Application Center JNDI properties by completing one of the following procedures:

- "Configuring the endpoint of the application resources (full profile)" on page 6-215
- "Configuring the endpoint of the application resources (Liberty profile)" on page 6-216

4. Configure DataPower. DataPower XI52 acts as the gateway for all IBM MobileFirst Platform Foundation for iOS and Application Center requests. DataPower validates all incoming user credentials against an LDAP registry. The following sections show how to configure DataPower.

a. Create a new multi-protocol gateway. Complete the following steps:

- 1) From the DataPower XI52 control panel, click the **Multi-Protocol Gateway** icon to open the Multi-Protocol Gateway main page.



Control Panel

Services



Figure 6-27. Accessing the Multi-Protocol Gateway main page

- 2) Click **Add** to add a new gateway.
- 3) Provide a name for the gateway and set **Type** to dynamic-backend.
- 4) Make sure that **Request Type** and **Response Type** are set to Non-XML.
- 5) On the Advanced tab page, select **Follow Redirects** and **Process Backend Errors**.
- 6) On the Stylesheet Params tab page, add the parameters listed in Table 6-62:

Table 6-62. Stylesheet parameters

Parameter name	Value
{http://www.datapower.com/param/config}applicationcenterBackend	http://<appcenterHostName>:<port>
{http://www.datapower.com/param/config}worklightBackend	http://<worklightIHSHostName>:<port>

- 7) On the General tab page, add an HTTPS (SSL) Front Side Handler with reverse SSL Proxy profile. Ensure that the following methods and versions are selected:
 - HTTP 1.0
 - HTTP 1.1
 - POST method
 - GET method
 - PUT method
 - HEAD method
 - OPTIONS
 - DELETE method
 - URL with Query Strings
 - URL with Fragment Identifiers
- 8) Click the plus sign (+) to add a new multi-protocol gateway policy.
- 9) Provide a name for the policy, click **Apply Policy**, and then click **Close Window**. The policy is added to the gateway.
- 10) Apply your configuration.

b. Edit the multi-protocol gateway policy. Add the following rules to provide form-based authentication, generate an LTPA token and verify the LTPA token. All the rules are described in the following tables. You must list them in the same order.

- 1) worklight-ssl-policy_skipFavicon: see Table 6-63
- 2) worklight-ssl-policy_verifyLTPA: see Table 6-64
- 3) worklight-ssl-policy_allowSSLLoginPage: see Table 6-65
- 4) worklight-ssl-policy_worklightSSLLogin: see Table 6-66 on page 6-270

Table 6-63. Properties of worklight-ssl-policy_skipFavicon

Property	Value
Direction	Client to Server.
Match	<ul style="list-style-type: none"> • Type = URL • Pattern = /favicon.ico
Advanced	"Set Variable" -> var://service/mpgw/skip-backside = 1
Result	Not applicable.

Table 6-64. Properties of worklight-ssl-policy_verifyLTPA

Property	Value
Direction	Client to Server.
Match	<ul style="list-style-type: none"> • Type = HTTP • HTTP tag = Cookie • Pattern = *LtpaToken*
AAA	<ul style="list-style-type: none"> • Input: INPUT • Output: NULL <p>Add a new AAA Policy named VerifyLTPA with the following configuration:</p> <ul style="list-style-type: none"> • Extract Identity: LTPA token • Method: Accept LTPA Token. • Acceptable LTPA versions: WebSphere version 1 and WebSphere version 2 • LTPA key file: upload the LTPA keyfile. • LTPA key file password: specify the password for the LTPA keyfile. • Extract Resource: URL Sent by Client • Authorization: Allow any authenticated client.
Transform	<p>Upload route.xsl. See "Sample dynamic routing stylesheet" on page 6-271.</p> <ul style="list-style-type: none"> • Input: INPUT • Output: auth
Result	Not applicable.

Table 6-65. Properties of worklight-ssl-policy_allowSSLLoginPage

Property	Value
Direction	Client to Server.

Table 6-65. Properties of *worklight-ssl-policy_allowSSLLoginPage* (continued)

Property	Value
Match	<ul style="list-style-type: none"> Type = URL Pattern = /(Login Error)Page\.htm(1)?(\?originalUrl=.*)?
AAA	<ul style="list-style-type: none"> Input: INPUT Output: NULL <p>Add a new AAA Policy named AllowSSLLoginPage with the following configuration:</p> <ul style="list-style-type: none"> Method: HTML Form-based Authentication HTML Form Policy: Create one with the default values, but edit these values: <ul style="list-style-type: none"> Use SSL For Login: enabled SSL Port: port on which the multi-protocol gateway is listening. Authentication: Pass identity token to authorization phase Resource extraction: URL sent by client Authorization: Always allow
Result	Not applicable.

Table 6-66. Properties of *worklight-ssl-policy_worklightSSLLogin*

Property	Value
Direction	Client to Server.
Match	<ul style="list-style-type: none"> Boolean Or Combinations: On Type = URL Pattern: /worklightconsole/* Type = URL Pattern: /wladmin/* Type = URL Pattern: /worklight/* Type = URL Pattern: /j_security_check Type = URL Pattern: /applicationcenter/* Type = URL Pattern: /appcenterconsole/*
Advanced	"Convert Query Params to XML Action"

Table 6-66. Properties of `worklight-ssl-policy_worklightSSLLogin` (continued)

Property	Value
AAA	<p>Create a new AAA Policy named <code>worklightSSLFormLogin</code> with the following configuration:</p> <ul style="list-style-type: none"> • Extract Identity: <ul style="list-style-type: none"> – Method: HTML Form-based Authentication – HTML Form Policy: Select the same policy created in the previous step. • Authentication: <ul style="list-style-type: none"> – Method: Bind to LDAP server – Enter the HostName, Port(636) – Create an SSL Forward proxy profile with the LDAP server's SSL certificate. – LDAP Bind DN, in this case would be: <code>cn=admin,dc=worklight,dc=com</code> – Enter the LDAP Bind Password. – LDAP Prefix : <code>uid=</code> – LDAP Suffix : <code>ou=people,dc=worklight,dc=com</code> • Resource extraction: URL sent by client • Authorization: Allow any authenticated client. • Post Processing: Generate LTPA Token -> on. <ul style="list-style-type: none"> – LTPA Token Version: WebSphere version 2 – LTPA Key File: Select the <code>ltpa</code> key file – LTPA key file password: Specify the password for the <code>ltpa</code> keyfile.
Transform	<p>Upload <code>route.xml</code> file. See “Sample dynamic routing stylesheet.”</p> <ul style="list-style-type: none"> • Input: INPUT • Output: auto
Result	Not applicable.

Results

The different pieces of the topology are now configured and provide a seamless SSO experience for mobile applications as well as for Application Center.

Sample dynamic routing stylesheet

You can use this sample stylesheet to handle the dynamic routing of requests between IBM MobileFirst Platform Foundation for iOS and IBM MobileFirst Platform Application Center. You refer to the stylesheet when you create rules to define a form-based authentication policy that generates and verifies LTPA tokens.

You provide a custom dynamic routing stylesheet when you define rule `worklight-ssl-policy_verifyLTPA` (see “Integrating IBM WebSphere DataPower with a cluster of instances of MobileFirst Server” on page 6-260, Table 6-64 on page 6-269), and when you define rule `worklight-ssl-policy_worklightSSLLogin` (see

“Integrating IBM WebSphere DataPower with a cluster of instances of MobileFirst Server” on page 6-260, Table 6-66 on page 6-270).

```
<xsl:stylesheet version="1.0"
  xmlns:xsl="http://www.w3.org/1999/XSL/Transform"
  xmlns:dp="http://www.datapower.com/extensions"
  xmlns:dpconfig="http://www.datapower.com/param/config"
  xmlns:re="http://exslt.org/regular-expressions"
  extension-element-prefixes="dp re dpconfig"
  exclude-result-prefixes="dp">

  <xsl:param name="dpconfig:worklightBackend"/>
  <xsl:param name="dpconfig:applicationcenterBackend"/>
  <xsl:template match="/">

    <xsl:variable name="worklight" select="'worklight'"/>
    <xsl:variable name="worklightconsole" select="'worklightconsole'"/>
    <xsl:variable name="wladmin" select="'wladmin'"/>
    <xsl:variable name="applicationcenter" select="'applicationcenter'"/>
    <xsl:variable name="appcenterconsole" select="'appcenterconsole'"/>

    <xsl:variable name="worklightBackend" select="$dpconfig:worklightBackend"/>
    <xsl:variable name="applicationcenterBackend" select="$dpconfig:applicationcenterBackend"/>

    <xsl:variable name="incomingURI" select="dp:variable('var://service/URI')"/>
    <xsl:variable name="httpContentType" select="dp:http-request-header('Content-Type')"/>
    <xsl:variable name="accessControlRequestHeaders" select="dp:http-request-header('Access-Control-Request-Headers')"/>
    <xsl:variable name="accessControlRequestMethod" select="dp:http-request-header('Access-Control-Request-Method')"/>

    <xsl:choose>
      <!-- set the backend server if the url is /worklight -->
      <xsl:when test="contains(dp:variable('var://service/URI'),
$worklight) or contains(dp:variable('var://service/URI'),
$worklightconsole) or contains(dp:variable('var://service/URI'), $wladmin)">
        <dp:set-http-request-header name="Content-Type" value="$httpContentType"/>
        <dp:set-variable name="var://service/routing-url" value="$worklightBackend"/>
        <dp:set-variable name="var://service/URI" value="$incomingURI"/>
      </xsl:when>

      <xsl:when test="contains(dp:variable('var://service/URI'), $applicationcenter)
or contains(dp:variable('var://service/URI'), $appcenterconsole)">
        <dp:set-http-request-header name="Content-Type" value="$httpContentType"/>
        <dp:set-http-request-header name="Access-Control-Request-Headers" value="$accessControlRequestHeaders"/>
        <dp:set-http-request-header name="Access-Control-Request-Method" value="$accessControlRequestMethod"/>
        <dp:set-variable name="var://service/routing-url" value="$applicationcenterBackend"/>
        <dp:set-variable name="var://service/URI" value="$incomingURI"/>
      </xsl:when>

      <xsl:when test="contains(dp:variable('var://service/URI'), 'j_security_check')">
        <dp:set-http-request-header name="Content-Type" value="$httpContentType"/>
        <dp:set-variable name="var://service/routing-url" value="$applicationcenterBackend"/>
        <dp:set-variable name="var://service/URI" value="/appcenterconsole/login/j_security_check"/>
      </xsl:when>

      <xsl:otherwise>
        <xsl:message dp:type="all" dp:priority="error"> No matching url found. </xsl:message>
      </xsl:otherwise>
    </xsl:choose>

    <xsl:value-of select="."/>
  </xsl:template>
</xsl:stylesheet>
```

Endpoints of the IBM MobileFirst Platform Server production server

You can create whitelists and blacklists for the endpoints of the MobileFirst Server.

Note: Information regarding URLs that are exposed by IBM MobileFirst Platform Foundation for iOS is provided as a guideline for organizations to make informed decisions and ensure they are tested in an enterprise infrastructure, based on what has been enabled for white and black lists.

Table 6-67. MobileFirst Server production endpoints

	API URL, under <application root context>/	Description	Suggested for whitelist?	For more information
MFP Applications				
	apps/services/api/*	Used by client applications for operations such as init, Direct Update requests, invocation of adapter procedures, and more.	Yes	“HTTP Interface of the production server” on page 6-275
	apps/services/random/*	Used for generating a random number. Used by JSON store implementation and encrypted cache on the client side.	Yes, if you plan to use offline storage such as JSON store.	“JSONStore overview” on page 8-161
	apps/services/reach	Used for the reach API, this servlet returns status 200 with OK, letting you verify that the MobileFirst Server is up and running.	Yes	
	apps/services/www/*	Used by mobile web or desktop application to access its resources.	Yes	Web application resource requests
	apps/services/download/*	Deprecated	No	
	apps/services/preview/*	Used to preview the application.	No. Used for development and administration purposes.	Preview application resource requests
Node Sync				
	node/integration/*	Used to receive notifications from IBM MobileFirst Platform Foundation for iOS adapters that are based on Node.js. Not in use and can be blocked.	No	
Vitality				
	ws/rest/vitality	Used to check server availability. Returns a list of applications and adapters. For use of admin personnel.	No	“Vitality queries for checking server health” on page 12-2
Invoke back end procedure				

Table 6-67. MobileFirst Server production endpoints (continued)

	API URL, under <application root context>/	Description	Suggested for whitelist?	For more information
	invoke	Used to invoke an adapter procedure.	Yes, if application uses adapter authentication features, or if you want to access the adapter directly and not from the application. Note that if this API passes the firewall, everyone will be able to invoke any adapter procedure and it will be protected only by the adapter security test and not by the application security test.	“Accessing adapters from the /invoke endpoint” on page 8-160
	subscribeSMS	Push subscription service API. Used by applications.	Yes, if application uses push subscription API.	“Web-based SMS subscription” on page 8-212
	receiveSMS	SMS subscription service API. Used by applications.	Yes, if application uses SMS subscription API.	“Using two-way SMS communication” on page 8-219
External Server Security				
Deprecated: Starting with V7.0.0, these endpoints are deprecated. Use the OAuth Server endpoints instead. For more information, see “OAuth-based security model” on page 8-221.				
Client side logging				
	apps/services/loguploader/*	Used by client applications to upload their accumulated debug and analytics logs.	Yes	“Client-side log capture” on page 8-300
	apps/services/configprofile/*	Used by client applications to GET their log configuration, which the admin set via the Log Configuration tab in the IBM MobileFirst Platform Operations Console.	Yes	“Client-side log capture” on page 8-300
Dev				
	dev/*	Development service API such as /invoke, /appdata, /preview, and others. Used in development environments only.	No, only for the development environment and not for QA, pre-production, or production.	
USSD				
	ussd/*	Used for communication with the USSD (Unstructured Supplementary Service Data) gateway.	Yes	“USSD Support” on page 8-151
OAuth Server				

Table 6-67. MobileFirst Server production endpoints (continued)

API URL, under <application root context>/	Description	Suggested for whitelist?	For more information
authorization/v1/clients/instance	Used by clients applications to register with the OAuth Server	No	“OAuth-based security model” on page 8-221
authorization/v1/authorization	Used by client applications to perform authorization	Yes, if you are using OAuth	“OAuth-based security model” on page 8-221
authorization/v1/token	Used by client applications to obtain access tokens	Yes, if you are using OAuth	“OAuth-based security model” on page 8-221
authorization/v1/publickey	Used by external resource filters to obtain the public key of the MobileFirst Server	Yes, if you are using OAuth	“OAuth-based security model” on page 8-221
authorization/v1/token/validation	Used for performing online token validation	Yes, if you are using OAuth	“OAuth-based security model” on page 8-221
authorization/v1/clients/preview	Used for registering applications in preview mode	No, only for development	“OAuth-based security model” on page 8-221

HTTP Interface of the production server

You can use the HTTP interface of the production server to make application API requests or web application resource requests. Use the following request structures, headers, and elements.

Application API requests

Use the following request structure to perform an application API request:

{Protocol}://{Worklight Server}/apps/services/api/{Application ID}/{Application Environment}/{Action}

Table 6-68. Application API request headers

Header Name	Data Type	Description	Valid values
x-wl-app-version	String	Version of the application	
WL-Instance-ID	String	Protection mechanism for XSS attacks.	

Table 6-69. Application API request elements

Header Name	Data Type	Description	Valid values
Protocol	String		HTTP
Worklight Server	String	Host name or IP address (and possibly port) identifying the MobileFirst Server	

Table 6-69. Application API request elements (continued)

Header Name	Data Type	Description	Valid values
Application ID	String	Unique Identifier of the application within the MobileFirst Server. Every application deployed on the MobileFirst Server must have a unique identifier	Up to 256 alphanumeric and underscore characters
Application Environment	String	Name of the environment that the application is running on	air, desktopbrowser, iOSnative, ipad, iphone, JavaMEnative, mobilewebapp
Action	String	Requested action	Details in following table

Table 6-70. Actions

Action	HTTP Request	Parameters
init	POST	x , isAjaxRequest – see the following table showing common parameters.
heartbeat	POST	x , isAjaxRequest – see the following table showing common parameters.
logactivity	POST	x , isAjaxRequest – see the following table showing common parameters. activity – string.
query	POST	x , isAjaxRequest – see the following table showing common parameters. filterList – JSON block parameterList – JSON block sorterList – JSON block Note: When the action is query , the request URL has the following structure: .../query/{Adapter Name}/{Procedure Name} where Adapter Name and Procedure Name are strings.
logout	POST	x , isAjaxRequest - see the following table showing common parameters.

Table 6-70. Actions (continued)

Action	HTTP Request	Parameters
login	POST	x, isAjaxRequest – see the following table showing common parameters. realm – string.
updates	POST	x, isAjaxRequest – see the following table showing common parameters. skin – current skin name (string) checksum – the checksum of the current skin (string) skinLoaderChecksum – the checksum of the skin selection code (string)
getup	POST	x, isAjaxRequest - see the following table showing common parameters.
deleteup	POST	x, isAjaxRequest – see the following table showing common parameters. userprefkey – the user preference to delete.
getuserinfo	POST	x, isAjaxRequest – see the following table showing common parameters.
getgadgetprefs	POST	x, isAjaxRequest - see the following table showing common parameters.

Table 6-70. Actions (continued)

Action	HTTP Request	Parameters
notifications	POST	<p>x, isAjaxRequest – see the following table showing common parameters.</p> <p>subscribe – JSON string containing subscribe options</p> <p>unsubscribe – when specified, designates an unsubscribe action</p> <p>updateToken – the update notification token (string)</p> <p>adapter – the name of the notification adapter (string)</p> <p>eventSource – the name of the notification event source (string)</p> <p>alias – notification subscription alias (string)</p> <p>tag – the name of the tag (string)</p>
fbcallback	GET or POST	<p>x, isAjaxRequest – see the following table showing common parameters.</p> <p>popup – string</p>
composite	POST	<p>x, isAjaxRequest - see the following table showing common parameters.</p> <p>requests – a JSON string containing information about other actions to invoke.</p> <p>This action is used to combine several actions in a single HTTP request.</p>
appversionaccess	GET	<p>x, isAjaxRequest – see the following table showing common parameters.</p>
setup	POST	<p>x, isAjaxRequest - see the following table showing common parameters.</p> <p>userprefs contains JSON pairs of preference key and value</p>

Table 6-70. Actions (continued)

Action	HTTP Request	Parameters
authentication	POST	x, isAjaxRequest - see the following table showing common parameters. action values are popup, test, or test_img
authenticate	POST	x, isAjaxRequest - see the following table showing common parameters. This is an empty handler used to allow the client to respond to authentication challenges with a challengeResponse that cannot fit in a single header or when all headers combined are bigger than the limit for header size.

Table 6-71. Common parameters

Parameter	Values	Comments
isAjaxRequest	true	Included with every GET and POST request only from Adobe™ AIR application.
-	None	Included with every POST request only from Webkit-based browsers and application frameworks: Safari, Chrome, and Adobe AIR.

Web application resource requests

Use the following request structure to submit a web application resource request:

```
{Protocol}://{Worklight Server}/apps/services/www/{Application ID}/
{Application Environment}/{Application Resource Path}
```

Request elements

See *Application API Request Elements* for details about the following request elements: **Protocol**, **Worklight Server**, **Application ID**, and **Application Environment**.

Table 6-72. Request elements

Element	Data Type	Description	Valid Values
Application Resource Path	String	HTML, image, JavaScript, CSS, and any other application resource	Example values: img/bg.png, myWidget.html, js/myWidget.js

Preview application resource requests

Use the following request structure to preview application resource requests:

```
{Protocol}://{Worklight Server}/apps/services/preview/{Application ID}/  
{Application Environment}/{Application Version}/{Application Resource Path}
```

Request elements

See *Application API Request Elements* for details about the following request elements: **Protocol**, **Worklight Server**, **ApplicationID**, and **Application Environment**.

Table 6-73. Request elements

Element	Data Type	Description	Valid Values
Application Resource Path	String	HTML, image, JavaScript, CSS, and any other application resource	Example values: img/bg.png, myWidget.html, js/myWidget.js

Troubleshooting IBM MobileFirst Platform Server

You can troubleshoot to locate the server and databases on Windows 8, Windows 7, and Windows XP, or to find the cause of installation or database creation failure.

Troubleshooting to find the cause of installation failure

You can troubleshoot to find the cause of installation failure.

About this task

If installation failed but the cause is not obvious, you can troubleshoot by completing the following procedure:

Procedure

See the failed-install.log file in the installation directory or, if this file does not exist, the install.log file in the installation directory. On Windows systems, if the default installation location was chosen, the directory is C:\Program Files\IBM\Worklight\. This file contains details about the installation process.

What to do next

If you still cannot determine the cause of the installation failure, you can use the manual installation instructions to investigate the problem more thoroughly. See “Deploying a project WAR file and configuring the application server manually” on page 10-39.

Troubleshooting failure to create the DB2 database

An incompatible database connection mode might result in failure to create the DB2 database.

About this task

If the following message is displayed when you attempt to create a DB2 database, proceed as follows:

```
"Creating database <WL_DB> (this may take 5 minutes) ... failed: Cannot connect to database <WL_DB> after it was created: com.ibm.db2.jcc.am.SqlException: DB2 SQL Error: SQLCODE=-1035, SQLSTATE=57019, SQLERRMC=null, DRIVER=<driver_version>"
```

Procedure

1. Wait a few minutes for the current DB2 database connections to close, and then click **Back**, and then **Next** to check whether the issue is solved.
2. If the problem persists, contact your database administrator to solve the database connection issue that is documented on the SQL1035N web page.

Troubleshooting a MobileFirst Server upgrade with Derby as the database

If IBM MobileFirst Platform Application Center is installed and uses Apache Derby as a database, stop the application server that runs the application before you run IBM Installation Manager to upgrade a IBM MobileFirst Platform Server installation.

About this task

During an upgrade of MobileFirst Server, if Application Center is installed, the installer migrates the database that is used by Application Center. When Apache Derby is the database, this operation can fail if the application server that runs Application Center is not stopped.

The symptom of this problem is that the upgrade fails and the log file contains the error message Another instance of Derby may have already booted the database.

Procedure

Before you run IBM Installation Manager to upgrade an installation of MobileFirst Server and Application Center, stop the application server that runs the Application Center application.

Troubleshooting failure to authenticate to Application Center and applications that use the basic registry element

Authentication fails when attempting to log in to the Application Center and other applications that run on WebSphere Application Server Liberty profile and use the `basicRegistry` element.

About this task

When IBM MobileFirst Platform Foundation for iOS is installed with Application Center on WebSphere Application Server Liberty profile, it adds a `basicRegistry` element in the `server.xml` file of the Liberty server instance, with demo users, even if a `basicRegistry` element already exists. Authentication into the Application

Center and other applications that use users from the basic registry no longer works. For example, after an attempt to log in to the Application Center, the following error message is displayed:

```
Error 404: java.io.FileNotFoundException: SRVE0190E: File not found: /j_security_check
```

The liberty server log file contains the following error message:

```
[ERROR] CWWKS3006E: A configuration exception has occurred. There are multiple available UserRegistry implementation services; the system cannot determine which to use.
```

When IBM MobileFirst Platform Foundation for iOS is uninstalled, the basic registry that was created during the installation by the IBM MobileFirst Platform Server installer is removed from the `server.xml` file, even if other users have been added to that basic registry. If other applications than Application Center use the basic registry, authentication on these applications is no longer possible. This issue might include installations of the IBM MobileFirst Platform Operations Console and Administration Services.

Procedure

1. Move the content of the basic registry that was created by IBM Installation Manager in the initial basic registry element. For an installation that is not for test purposes only, do not copy the users `demo` and `appcenteradmin`, and remove them from the `appcentergroup`. Remove the following code from the `server.xml` file:

```
<!-- Declare the user registry for the Application Center. -->
<basicRegistry id="applicationcenter-registry" realm="ApplicationCenter">
  <!-- The users defined here are members of group "appcentergroup",
  thus have role "appcenteradmin", and can therefore perform administrative tasks
  through the Application Center console. -->
  <user name="appcenteradmin" password="admin"/>
  <user name="demo" password="demo"/>
  <group name="appcentergroup">
    <member name="appcenteradmin"/>
    <member name="demo"/>
  </group>
</basicRegistry>
```

2. When you uninstall IBM MobileFirst Platform Foundation for iOS, the uninstaller of MobileFirst Server creates a backup of the `server.xml` file under the name `server.xml.saved2`. Open the `server.xml.saved2` file, and copy the `basicRegistry` element back in the `server.xml` file. Remove the users and groups that were only needed by the Application Center.

Troubleshooting server farm configuration issues

When you start the Administration Services and the MobileFirst runtime environments, several exception types can be emitted in the application server logs if the configuration of the server farm is incorrect.

Server ID is not set

MBeanRegistrationException "server id JNDI property is not set".

This is because in the application server configuration, the JNDI property `ibm.worklight.admin.serverid` is not set.

You must configure the property `ibm.worklight.admin.serverid` in the application server. Restart the application server. For more information, see “Configuring a MobileFirst project in production by using JNDI environment entries” on page 10-60.

Administration Services MBean is already registered

The Administration Services MBean *<MBean name>* is already registered on another node of the farm, which means that the JNDI property **ibm.worklight.admin.serverid** has the same value on other nodes.

This situation occurs because the Administration Services MBean is already registered under the same name on another server of the farm. The value of the JNDI property **ibm.worklight.admin.serverid** is the same as one defined in another server of the farm.

You must configure the property **ibm.worklight.admin.serverid** in the application server. This property must be unique among the servers of the farm. Restart the application server.

Upgrading to IBM MobileFirst Platform Foundation for iOS V7.0.0

This section contains the procedures for upgrading from IBM Worklight V5.0.6 or later to V7.0.0 and migrating the applications you created in earlier versions of the product to work with IBM MobileFirst Platform Foundation for iOS V7.0.0.

About this task

Upgrading from one version of the product to another involves upgrading the software, upgrading your database, if needed, and sometimes upgrading your apps. Most of this upgrade is automatically done for you when you use the installer. However, the upgrade might also involve some manual operations, such as setting various properties, using special command facilities, and running supplied Ant tasks. The complete upgrade procedures are detailed in the following topics.

Those topics cover how to upgrade to V7.0.0 of MobileFirst Server, and how to migrate your applications for V7.0.0.

Version compatibility

Compatibility among different versions of the IBM MobileFirst Platform Foundation for iOS client and server depends on several factors.

The following table describes different situations and the compatibility rules that apply to each.

To understand the compatibility rules, it can be useful to understand the IBM product release conventions. Each full number of a release is composed of the following parts, where each part is replaced by a digit from 0 to 9:

version.release.modification.fixpack

Note: Version numbers cited in the table examples are for illustrative purposes only, and might not correspond to actual releases.

Table 7-1. Version compatibility rules.

Description	Compatibility rule	Examples
Server and client have same version and release. (Modification and fix pack release numbers can be different.)	Server and client with the same version and release are fully compatible.	7.0.0.0 server is compatible with 7.0.0.0 client.
Newer server than client.	Compatible.	7.0.0.0 server is compatible with 6.3.0.0 client
Older server than client.	Not compatible.	6.3.0.0 server is not compatible with 7.0.0.0 client

Table 7-1. Version compatibility rules (continued).

Description	Compatibility rule	Examples
<p>Server artifacts created with older version of MobileFirst Studio or the MobileFirst Platform Command Line Interface for iOS than the version of the server.</p>	<p>For complete details of which server, .war file, and artifacts work together, see Table 2. However, the following guidelines apply:</p> <p>For versions prior to 6.1.0, only the same versions of server, .war file, and application (.wlapp file) and adapters can work together.</p> <p>If the initial server version is Worklight Server 6.1 or 6.2, the .war file that was created with the same version of Worklight Studio or Command Line Interface for IBM Worklight Developers can be migrated to a newer server version, but the newer server can accommodate only artifacts (.wlapp and adapter files) that were built from the initial version.</p> <p>If the initial server version is Worklight Server 6.2.0.1 or later, including MobileFirst Server 6.3 or later, the .war file that was created with the same initial version of Studio or the Command Line Interface can be migrated to the newer server version. The migrated .war file can accommodate artifacts that were created with any of the following versions of Studio or the Command Line Interface:</p> <ul style="list-style-type: none"> • Initial version • Newer server version that .war file is migrated to • Any version prior to the initial version <p>The artifacts will behave as though they are running on the older version of the server.</p> <p>For information about migrating the .war file, see “Migrating a project WAR file for use with a new MobileFirst Server” on page 10-39.</p>	<p>Example 1:</p> <p>Artifacts built with MobileFirst Studio 6.3.0.0 can run on server 7.0.0.0. However, the artifacts will behave as though they are running on server version 6.3.0.0.</p> <p>Example 2:</p> <p>Initially, a version 6.2.0.1 .war file can run the artifacts from 6.2.01 and below on a 6.2.0.1 server. If this .war file is migrated to 7.0, then the migrated .war file can run 7.0 artifacts. However, the war file cannot run MobileFirst Server 6.3 artifacts.</p>
<p>Server artifacts created with newer version of MobileFirst Studio or the MobileFirst Platform Command Line Interface for iOS than the version of the server.</p>	<p>Not compatible.</p>	<p>Artifacts built with MobileFirst Studio 7.0.0.0 cannot run on server 6.3.0.0.</p>
<p>Direct Update feature</p>	<p>If the version of MobileFirst Studio or the MobileFirst Platform Command Line Interface for iOS that was used to build an update package differs from the version of MobileFirst Studio or the MobileFirst Platform Command Line Interface for iOS that was used to build the original application package then the update will not be applied.</p>	<p>Original application was built with MobileFirst Studio 6.3.0.0; update was built with MobileFirst Studio 7.0.0.0. Update will not occur.</p>

The following table shows which .war file and artifact versions can work with each server version. Application behavior remains as with the original version of the application. Version numbers prior to 6.3 apply to Worklight products. Version numbers of 6.3 and above apply to MobileFirst products.

Table 7-2. Server, project and artifact compatibility.

Server version	Can work with the following project versions (.war file created with this version of Studio or Command Line Interface)	Can work with the following artifact versions (application and adapter files created with this version of Studio or command line)
7.0.0	7.0.0	5.0.6, 6.0.0, 6.1.0, 6.2.0, 6.3.0, 7.0.0
7.0.0	6.3.0 migrated to 7.0.0	5.0.6, 6.0.0, 6.1.0, 6.2.0, 6.3.0
7.0.0	6.2.0 migrated to 7.0.0	6.2.0
7.0.0	6.1.0 migrated to 7.0.0	6.1.0
7.0.0	6.0.0 migrated to 7.0.0	6.0.0
7.0.0	5.0.6 migrated to 7.0.0	5.0.6
6.3.0	6.3.0	5.0.6, 6.0.0, 6.1.0, 6.2.0, 6.3.0
6.3.0	6.2.0 migrated to 6.3.0	6.2.0
6.3.0	6.1.0 migrated to 6.3.0	6.1.0
6.3.0	6.0.0 migrated to 6.3.0	6.0.0
6.3.0	5.0.6 migrated to 6.3.0	5.0.6
6.2.0.1	6.2.0.1	5.0.6, 6.0.0, 6.1.0, 6.2.0, 6.2.0.1
6.2.0.1	6.2.0 migrated to 6.2.0.1	6.2.0
6.2.0.1	6.1.0 migrated to 6.2.0.1	6.1.0
6.2.0	6.2.0	6.2.0
6.2.0	6.1.0 migrated to 6.2.0	6.1.0
6.2.0	6.0.0 migrated to 6.2.0	6.0.0
6.2.0	5.0.6 migrated to 6.2.0	5.0.6
6.1.0	6.1.0	6.1.0
6.1.0	6.0.0 migrated to 6.1.0	6.1.0
6.1.0	5.0.6 migrated to 6.1.0	6.0.0
6.0.0	6.0.0	6.0.0
5.0.6	5.0.6	5.0.6

Migrating projects to V7.0.0 using MobileFirst Platform Command Line Interface for iOS

If you are using IBM MobileFirst Platform Command Line Interface for iOS to develop an IBM MobileFirst Platform Foundation for iOS project that is from any release before V7.0.0, your project is automatically migrated to V7.0.0.

When you run the `mfp add` command or the `mfp build` command, or when the MobileFirst Server starts, your MobileFirst project is migrated to V7.0.0.

Migrating IBM SmartCloud Analytics Embedded to IBM MobileFirst Platform Operational Analytics

If you used IBM SmartCloud Analytics Embedded in previous versions of IBM MobileFirst Platform Foundation for iOS, you must now migrate to IBM MobileFirst Platform Operational Analytics.

About this task

In IBM MobileFirst Platform Foundation for iOS V7.0.0, IBM MobileFirst Platform Operational Analytics replaces IBM SmartCloud Analytics Embedded. Complete the following steps to migrate to IBM MobileFirst Platform Operational Analytics. For more information about IBM MobileFirst Platform Operational Analytics, see “Operational analytics” on page 12-8.

Procedure

1. Install the analytics WAR file on your application server, but do not start the server. For detailed information about installing the analytics WAR file, see “Installing the IBM MobileFirst Platform Operational Analytics” on page 6-145.
2. Locate the data folder on your IBM SmartCloud Analytics Embedded server. If the installation path for IBM SmartCloud Analytics Embedded was not modified, this folder is located in `/opt/IBM/analytics/data`.
3. Copy the data folder to the same machine as the machine where the analytics WAR file is hosted.

Note: The data folder then becomes the location where all analytics data is stored, so make sure to place this folder in an appropriate location.

4. Modify the `datapath` JNDI variable on your application server to point to the data folder that was copied from the IBM SmartCloud Analytics Embedded server folder in step 3. For example:

```
<jndiEntry jndiName="analytics/datapath" value="/home/system/data"/>
```

Important: Make sure the JNDI property points to a copied version of the data folder. This is to ensure that your data is still backed up in case of data corruption due to a migration failure.

5. Identify the cluster name that was specified when IBM SmartCloud Analytics Embedded was installed. This name will be the name of the folder at the root of the data folder.
 6. Modify the `clustername` JNDI variable on your application server to match the cluster name that was installed by IBM SmartCloud Analytics Embedded. For example:
- ```
<jndiEntry jndiName="analytics/clustername" value="WLCLUSTER"/>
```
7. Start the Analytics WAR server and review the console. The migration process begins automatically. The data is available to view after the migration process is completed.

---

## Upgrading to MobileFirst Server V7.0.0 in a production environment

Upgrading MobileFirst Server in a production environment is a more exacting process than in your development environment because you must back up your data and prepare for the upgrade carefully to minimize production downtime. This section provides a series of steps to upgrade your production server or servers efficiently and in the shortest time possible.

When you upgrade from Worklight Server V5.0.6.x or later to V7.0.0 in a production environment, the process can be more complicated than upgrading to a new version in your development environment. The upgrade procedure can also take longer if you have existing MobileFirst applications that run in a production MobileFirst Server environment. For step-by-step instructions on how to upgrade your production MobileFirst Server to V7.0.0, see the following topics.

**Note:** The documentation in the topics that follow assumes the following facts:

- Your database type is IBM DB2, MySQL, or Oracle (not Apache Derby).
- Your application server type is WebSphere Application Server full profile, WebSphere Application Server Liberty profile, or Apache Tomcat.

**Important:** The topics are in a specific order, and must be completed in the order shown.

The upgrade procedure can take some time, several hours in fact, and so these activities must be scheduled to create the least disruption and downtime to production servers and the applications that run on them.

The topics provide essential information about backing up any existing databases or application server data, migrating your existing MobileFirst projects and applications to the new version, and performing other preparation tasks that must be completed before you install the new version of MobileFirst Server. These preparatory steps are followed by postinstallation, verification, and configuration tasks that must be completed before you restart the new MobileFirst Server and finish migrating your MobileFirst applications.

Read through the entire set of topics before you begin the actual upgrade process to become familiar with the tasks ahead of you, what must be done, and in what order.

Start with “Overview of the upgrade to MobileFirst Server V7.0.0 process,” and then read through the steps under each of the major topics that follow.

## Overview of the upgrade to MobileFirst Server V7.0.0 process

An overview of the MobileFirst Server V7.0.0 upgrade process, including what is updated and what is not.

A typical instance of MobileFirst Server includes the following elements:

- A Database Management System (DBMS) that runs databases for the Application Center and for MobileFirst Server. This DBMS hosts and run the following databases:
  - The Application Center database (if Application Center is installed on that server).
  - The administration database.
  - One or more runtime databases. Each runtime environment requires one runtime database and an optional reports database.
- One or more application servers. These application servers host and run the following web applications:
  - The Application Center application (if Application Center is installed on that server).
  - The MobileFirst Operations Console application. One MobileFirst Operations Console can be used to administer several MobileFirst runtime environments. It is defined by a WAR file, which is `worklightconsole.war`.
  - The Administration Services application. This application provides the necessary services for the MobileFirst Operations Console and hosts all the services (REST services) and administration tasks. The Administration Services application is defined by a WAR file, which is `worklightadmin.war`, and is connected to the administration database.

- One or more MobileFirst runtime environments. Each MobileFirst runtime environment:
  - Is defined by a WAR file that is created with the MobileFirst Platform Command Line Interface for iOS development tool.
  - Is connected to two databases, one for runtime and one for reports.
  - Can run on one or more physical servers, for both workload and service availability considerations.
- An installation of the MobileFirst Server programs, usually on the same computer as the application server or deployment manager.

Other items can belong to an IBM MobileFirst Platform Foundation for iOS configuration, for example, an IBM HTTP Server, IBM DataPower, or an LDAP system.

The topics in this section focus on the task of upgrading and configuring the following entities:

- The MobileFirst Server programs.
- The databases, including the creation of the administration database.
- The MobileFirst project runtime applications and Application Center applications that are deployed in the application server.

**Note:** The upgrade of the MobileFirst project runtime applications includes the installation and setup of the MobileFirst Operations Console and administration services applications.

The actual steps that you must complete for the upgrade can change, depending on the particular *upgrade path* you are pursuing. Your upgrade path is determined by whether you are upgrading:

- From a previous version of Worklight Server or MobileFirst Server to MobileFirst Server V7.0.0 (for example, from V6.0.0.x to V7.0.0 or from V6.1.0.x to V7.0.0).
- From MobileFirst Server V7.0.0 to a fix pack release or an interim fix (for example, from V7.0.0 to V7.0.0.x).

The spreadsheet at the following link lists the individual steps for each of these upgrade paths, and helps you to determine:

- Whether the step is required or not required, depending on your MobileFirst upgrade path.
- Whether your Application Center and MobileFirst Server (old version), uninstalled, stopped, or upgraded (and running) during this step as the result of actions in the current step or previous steps.

The spreadsheet can be downloaded here: [MobileFirst Server Upgrade Steps spreadsheet](#)

To provide further assistance, at the beginning of each topic a shorter version of this spreadsheet is provided for that step.



Is this step required for your upgrade path?						System status after this step, if both Application Center and MobileFirst Server are on the same application server	
Worklight Server V5.0.6.x to MobileFirst Server V7.0.0	Worklight Server V6.0.x to MobileFirst Server V7.0.0	Worklight Server V6.1.x to MobileFirst Server V7.0.0.x	Worklight Server V6.2.x to MobileFirst Server V7.0.0	MobileFirst Server V6.3.0 to MobileFirst Server V7.0.0	V7.0.0 to V7.0.0.x (fix pack or interim fix)	Application Center Status	MobileFirst Server Status
Yes/No	Yes/No	Yes/No	Yes/No	Yes/No	Yes/No	Running/ Stopped/ Uninstalled/ Upgraded	Running/ Stopped/ Uninstalled/ Upgraded

## Preparation for upgrades to MobileFirst Server

Before you begin the actual upgrade to MobileFirst Server V7.0.0, you must complete several preparation tasks.

Upgrading to a new version of MobileFirst Server in a development environment is quick and easy because in most cases no critical data must be preserved in IBM MobileFirst Platform Foundation for iOS databases. In a production environment, however, more time and effort are required for the upgrade, to minimize production downtime and inconvenience to users of existing applications.

Complete the following preparation tasks before you begin upgrading to a new MobileFirst Server version. You can start any time before the upgrade, but you must complete these tasks before you move to the next major step, “Starting the MobileFirst Server V7.0.0 upgrade process” on page 7-20.

### Gathering information for MobileFirst Server V7.0.0 upgrades

To avoid having to stop the upgrade process to look up required information, gather it in advance and have it handy.

#### About this task

One of the purposes of these instructions is to minimize the time for upgrades to MobileFirst Server. You do not want to start the procedure and then discover that you are missing some piece of information that is required by the installer.

To avoid this situation, prepare a list of information that you are likely to be asked for and keep it handy during the upgrade process.

In addition, it is often necessary to pre-plan certain aspects of the upgrade and clear them with your application server administrator and your database administrator. For example, you must know the correct user name. You must also either have sufficient permissions to create or update databases, or have your database administrator do it for you.

Is this step required for your upgrade path?						System status after this step, if both Application Center and MobileFirst Server are on the same application server	
Worklight Server V5.0.6.x to MobileFirst Server V7.0.0	Worklight Server V6.0.x to MobileFirst Server V7.0.0	Worklight Server V6.1.x to MobileFirst Server V7.0.0	Worklight Server V6.2.x to MobileFirst Server V7.0.0	MobileFirst Server V6.3.x to MobileFirst Server V7.0.0	V7.0.0 to V7.0.0.x (fix pack or interim fix)	Application Center Status	MobileFirst Server Status
Yes	Yes	Yes	Yes	Yes	Yes	Running	Running

## Procedure

Go through the following checklist.

- Verify that your operating system, application server, and Database Management System (DBMS) meet the system requirements for MobileFirst Server V7.0.0 at Detailed System Requirements for IBM MobileFirst Platform Foundation for iOS and IBM Mobile Foundation.
- Make a list of the host names and IP addresses of all servers that must be upgraded.
- Make a similar list of all database names and locations.
- Ensure that the correct JDBC drivers for the target databases are available on your computer. IBM Installation Manager needs access to these drivers to upgrade the Application Center database. Ant scripts also need access to these drivers to create the administration database and upgrade the MobileFirst runtime databases.
- Gather the credentials to the MobileFirst Server administration, the MobileFirst runtime environments, the MobileFirst reports, and Application Center databases. If you do not know the correct schemas, user names, and passwords, ask your database administrator for assistance.

**Note:** The administration database does not exist for IBM Worklight V6.1.0 or earlier.

- Stop and restart the application server and verify its configuration. If you do not know the correct schemas, user names, and passwords, ask your database administrator for assistance.
- If the URL to the Application Center or the MobileFirst Server applications or their console changes, identify all the systems that you must update. If you upgrade from V6.1.0 to V7.0.0, the URLs to the Application Center and the MobileFirst runtime environment do not change, but a new URL is introduced for the MobileFirst Operations Console.

## Planning installation of the MobileFirst Administration Services and MobileFirst Operations Console

You must plan the steps that you perform later to upgrade the Administration Services and the MobileFirst Operations Console. These components were introduced in V6.2.0, and if you upgrade from an earlier version, you must install them first.

## Before you begin

Worklight Server V6.2.0 introduced a new architecture for the unified console based on several core elements that are described in “Introduction to the MobileFirst Server components” on page 6-5.

If you upgrade from IBM Worklight V6.1.0 or earlier, you must install the following new components as part of the upgrade process: the Administration Services, and the MobileFirst Operations Console.

The present topic lists the items that you must plan before you perform that upgrade process. The actual installation procedure for the Administration Services, and optionally the MobileFirst Operations Console, is at “Installation or upgrade of MobileFirst Server Administration Services” on page 7-33.

## About this task

The following table lists the upgrade paths for which this step is mandatory.

Table 7-3. Upgrade paths

Is this step required for your upgrade path?						System status after this step, if both Application Center and MobileFirst Server are on the same application server	
Worklight Server V5.0.6.x to MobileFirst Server V7.0.0	Worklight Server V6.0.x to MobileFirst Server V7.0.0	Worklight Server V6.1.x to MobileFirst Server V7.0.0.x	Worklight Server V6.2.x to MobileFirst Server V7.0.0	MobileFirst Server V6.3.x to MobileFirst Server V7.0.0	V7.0.0 to V7.0.0.x (fix pack or interim fix)	Application Center Status	MobileFirst Server Status
Yes	Yes	Yes	No	No	No	Running	Running

If you upgrade from V6.1.0 or earlier, install the Administration Services as part of the upgrade process.

To minimize downtime or issues while you follow the upgrade procedure, start with reviewing the installation procedure and configuration options:

1. Review the topic “Planning deployment of administration components and runtimes” on page 6-7.
2. Define your upgrade strategy if multiple MobileFirst runtimes are installed (project WAR files).
3. Prepare the configuration of the application.
4. Set up the MobileFirst administration database.
5. Review the configuration of the application server.

The following procedure emphasizes important items that you must prepare before running an upgrade. You must also review the installation instructions at “Installing the MobileFirst Server administration” on page 6-43.

The following steps are for planning only, and you do not have to start the installation of the MobileFirst Server administration at this stage. The actual installation is described later in the upgrade procedure, at “Installation or upgrade of MobileFirst Server Administration Services” on page 7-33.

## Procedure

1. Review the topic “Planning deployment of administration components and runtimes” on page 6-7 to define the application server where you can install the MobileFirst Server administration components.
2. Define your upgrade strategy if multiple MobileFirst runtimes are installed (project WAR files).

**Note:** You must perform this step only if you have more than one MobileFirst runtimes (project WAR files) to upgrade. If you have only one MobileFirst runtime to upgrade, you can skip this test.

You can either manage all the runtimes with the same MobileFirst Administration Services and Console runtime environment or install this environment for each runtime.

- Manage all the runtimes with the same MobileFirst Administration Services and Console runtime environment: This is the default setting. Carefully review the context root of each runtime. The context root is used to identify a runtime in the administration database. After the MobileFirst administration data is migrated to the administration database, you can no longer change the context root of a MobileFirst Server runtime. For more information, see “Upgrade the runtime and reports databases” on page 7-36.
  - Install a MobileFirst Administration Services and Console environment for each runtime: In this case, define the environment IDs as follows:
    - If you install by running an Ant file, add an environmentID attribute to the Ant tasks for installation administration: `<installworklightadmin>`, `<updateworklightadmin>`, `<uninstallworklightadmin>`, `<configureapplicationserver>`, `<updateapplicationserver>`, `<unconfigureapplicationserver>`. For more information, see “Ant tasks for installation of MobileFirst runtime environments” on page 14-16 and “Ant tasks for installation of MobileFirst Operations Console and Administration Services” on page 14-10.
    - If you install manually, update the **ibm.worklight.admin.environmentid** JNDI property as documented in “List of JNDI properties for MobileFirst Server administration” on page 6-86 and “Configuring a MobileFirst project in production by using JNDI environment entries” on page 10-60.
3. Prepare the configuration of the application.

Since IBM Worklight Foundation V6.2.0, the protection of the Administration Services and the MobileFirst Operations Console is configured by security roles that are managed in the application server. For more information, see “Configuring user authentication for MobileFirst Server administration” on page 6-82. To prepare the installation and configuration of the Administration Services and the MobileFirst Operations Console, you must identify the users who need access to the console, and verify that these users are declared in the application server. This way, you can configure their access to the Administration Services and MobileFirst Operations Console when the applications are installed.
  4. Set up the MobileFirst administration database.

A MobileFirst administration database is necessary for the Administration Services. This database can be created at installation time, if you have an administrator access to the database server. Otherwise, you must contact your database administrator so that the database is created in advance, and you must provide your database administrator with the information listed at “Optional creation of the administration database” on page 6-43.
  5. Review the configuration of the application server.

For IBM MobileFirst Platform Foundation for iOS V7.0.0, you must configure your application server to enable Java Management Extensions (JMX) communication between the Administration Services and the MobileFirst Server runtime. Review the topic “Configuration of the application server” on page 6-46 to see if there is a need to configure your application server to support JMX for a production environment. For example, in the case of WebSphere Application Server Liberty profile, the Ant tasks that you use to install the Administration Services can configure a default secure JMX connection, which includes the generation of a self-signed SSL certificate with a validity period of 365 days. But this configuration is not intended for production use.

## Identify the MobileFirst WAR file and prepare the Ant deployment script

In this task, you identify the MobileFirst project WAR file that contains numerous resources and configuration settings for MobileFirst Server and prepare the Ant script that is used to deploy it.

### About this task

The MobileFirst WAR file is a web application archive that contains a MobileFirst Operations Console, default values for server-specific configuration settings, and other resources that can be required to run MobileFirst applications and adapters.

Is this step required for your upgrade path?						System status after this step, if both Application Center and MobileFirst Server are on the same application server	
Worklight Server V5.0.6.x to MobileFirst Server V7.0.0	Worklight Server V6.0.x to MobileFirst Server V7.0.0	Worklight Server V6.1.x to MobileFirst Server V7.0.0.x	Worklight Server V6.2.x to MobileFirst Server V7.0.0	MobileFirst Server V6.3.x to MobileFirst Server V7.0.0	V7.0.0 to V7.0.0.x (fix pack or interim fix)	Application Center Status	MobileFirst Server Status
Yes	Yes	Yes	Yes	Yes	Yes	Running	Running

### Procedure

In the upgrade process, the MobileFirst runtime environment must be redeployed to the application server. It is important to deploy the same WAR file. To ensure this, you must complete the following steps:

- Find the WAR file that was previously deployed to the application server.
  - If you are upgrading from Worklight Server V6.0.0.x or later, find the JNDI properties that were set for the deployed Worklight project to override the default `worklight.properties` file. If you used an Ant script with the `configureapplicationserver` task to deploy the WAR file, you can find in that script the JNDI properties that were set at installation time. For more information, see “Configuration of MobileFirst applications on the server” on page 10-48.  
For upgrading from Worklight Server V6.0.0.x or later, the procedure to deploy the WAR file is described at “Deploying the project WAR file” on page 10-5.
  - When you upgrade from Worklight Server V5.0.6.x, a MobileFirst WAR file is installed by the installer. If you have not modified this WAR file on your

production server, you must create a modified file by following the instructions at “Building a project WAR file with Ant” on page 10-4.

When you modify the WAR file, use Worklight Studio V5.0.6.x or the Ant tasks (`worklight-ant.jar`) from an installation of Worklight Studio V5.0.6.x that was used to build the apps previously deployed to the server. The version of Worklight Studio that was used to build the project WAR file must exactly match the version of Worklight Studio that was used to build the apps previously deployed to the server.

The WAR file is automatically upgraded to MobileFirst Server V7.0.0 format during the deployment procedure that is described in later steps.

2. Prepare the Ant deployment script that is used to upgrade this WAR file to MobileFirst Server V7.0.0 and to deploy this WAR file to the application server, with the upgraded MobileFirst runtime library.
  - When you upgrade from Worklight Server V6.0.0.x or later, you can reuse the script that you used for initial deployment. Make a copy of this file and modify it as follows:

- a. In the Ant file, make sure that the reference to the JAR file is `worklight-ant-deployer.jar`, and not `worklight-ant.jar`. Since IBM Worklight V6.1.0, this library is named `worklight-ant-deployer.jar`. For example, in the V6.0.0 script looks contains these lines:

```
<taskdef resource="com/worklight/ant/defaults.properties">
 <classpath>
 <fileset dir="${worklight.server.install.dir}/WorklightServer">
 <include name="worklight-ant.jar"/>
 </fileset>
 </classpath>
</taskdef>
```

Replace the reference to the JAR file as highlighted:

```
<taskdef resource="com/worklight/ant/defaults.properties">
 <classpath>
 <fileset dir="${worklight.server.install.dir}/WorklightServer">
 <include name="worklight-ant-deployer.jar"/>
 </fileset>
 </classpath>
</taskdef>
```

- b. In the Ant file, you must add the following targets, which are specific to IBM MobileFirst Platform Foundation for iOS V7.0.0:

- **admininstall**
- **minimal-admupdate**
- **admuninstall**
- **admdatabases**
- **minimal-update**

- c. Add `<adminDatabase>` to the `<configuredatabase kind="Worklight">` Ant task. This element upgrades the administration data to the new administration database.

Those targets are required to install the MobileFirst Operations Console and Administration Services. You can find examples of such targets in “Sample configuration files” on page 14-35. If you use the XML extracts of the sample configuration files, replace the variables (`{$. . . }`) by the corresponding variables of your Ant file. For more information about the references of the Ant tasks, see:

- “Ant **configuredatabase** task reference” on page 14-1

- “Ant tasks for installation of MobileFirst Operations Console and Administration Services” on page 14-10
- “Ant tasks for installation of MobileFirst runtime environments” on page 14-16
- If you upgrade from Worklight Server V5.0.6.x:
  - Install MobileFirst Server V7.0.0 on your computer, but without installing Application Center.
  - Navigate to directory `<WorklightInstallDir>/WorklightServer/configuration-samples`.
  - Select the file that corresponds to your combination of application server and database. The files are named with the convention `redeploy506-<appserver>-<db>.xml`.
  - Make a copy of this file.
  - Edit the copied file and change the values of the properties to match your installation configuration.
- 3. Verify that the **environmentID** attribute for the MobileFirst runtime environments matches the **environmentID** attribute that is used to install the MobileFirst Server administration Ant file.

If you install the MobileFirst Server administration components with a different Ant file than the one that you used to install the MobileFirst runtime environment, for example if you install the MobileFirst Server administration with the Server Configuration Tool, you might have a different **environmentID** for the administration and the runtime. In this case, the MobileFirst Server administration components would not find the MobileFirst runtime environments.

The **environmentID** is an attribute of the following Ant tasks:

- `installworklightadmin`, `updateworklightadmin`, and `uninstallworklightadmin` Ant tasks, which are documented at “Ant tasks for installation of MobileFirst Operations Console and Administration Services” on page 14-10.
- `configureapplicationserver`, `updateapplicationserver`, `unconfigureapplicationserver` Ant tasks, which are documented at “Ant tasks for installation of MobileFirst runtime environments” on page 14-16.

### **Review and note the Application Server configuration for MobileFirst Server and Application Center**

In this task, if it is required for your upgrade path, you prepare for the undeployment and redeployment of applications to the application server to correct information that can potentially be modified or deleted by IBM Installation Manager.

#### **About this task**

In some upgrade scenarios, the applications that are deployed to the application server must be undeployed, and then redeployed. As a consequence, the configurations that were previously made to these applications are erased and must be reconfigured after the application is deployed again to the application server.

The applications to review are as follows:

- For Application Center:
  - The Application Center Console and Application Center Services

- For Worklight Server or MobileFirst Server:
  - The Administration Console and Administration Services
  - Each project runtime

The JDBC data sources to review are as follows:

- For Application Center: the Application Center database
- For Worklight Server or MobileFirst Server:
  - The runtime database
  - The reports database
  - The administration database

If these items were previously configured, note the configuration details so you can reconfigure them after the applications are reinstalled and redeployed. The configurations affected can include security settings, lists of users authorized to use the application, startup behaviors, connection pool settings, JNDI properties, and other items.

The upgrade paths in which this step is mandatory are listed in the following table.

Is this step required for your upgrade path?						System status after this step, if both Application Center and MobileFirst Server are on the same application server	
Worklight Server V5.0.6.x to MobileFirst Server V7.0.0	Worklight Server V6.0.x to MobileFirst Server V7.0.0	Worklight Server V6.1.x to MobileFirst Server V7.0.0.x	Worklight Server V6.2.x to MobileFirst Server V7.0.0	MobileFirst Server V6.3.x to MobileFirst Server V7.0.0	V7.0.0 to V7.0.0.x (fix pack or interim fix)	Application Center Status	MobileFirst Server Status
Yes	Yes	Yes	No	No	See fix pack or interim fix installation instructions	Running	Running

## Procedure

To review the configuration of the data sources and applications:

- For WebSphere Application Server full profile, use the console.
- For WebSphere Application Server Liberty profile:
  - Open the `server.xml` file. The settings that can be modified or removed by IBM Installation Manager are between the marker comments, as shown in the following sample:
 

```
<!-- Begin of configuration added by IBM Worklight installer. -->
...
<!-- End of configuration added by IBM Worklight installer. -->
```
- For Apache Tomcat:
  - Open the `server.xml` and the `tomcat-users.xml` files. The settings that can be modified or removed by IBM Installation Manager are between the marker comments, as shown in the following sample:



```

<!-- Begin of Context and Realm configuration added by IBM Worklight installer. -->
...
<!-- End of Context and Realm configuration added by IBM Worklight installer. -->

```

## Verify environments of deployed apps

Before you upgrade to MobileFirst Server V7.0.0, verify that all of the environments that are targeted in your MobileFirst applications are still supported.

### About this task

After the migration is completed, your MobileFirst applications contain only the environments that are supported by the current version of MobileFirst Server.

In IBM Worklight Foundation V6.2.0, no mobile operating system is dropped or deprecated. Since IBM Worklight V6.1.0, some of the MobileFirst environments such as iGoogle, Facebook, Apple OS X Dashboard, Vista that were supported in IBM Worklight V5.0.6 are no longer supported. If a target mobile device has an application that is installed on it which requires an environment that is no longer supported by a version of MobileFirst Server prior to V7.0.0, the application on this device stops working after an upgrade of MobileFirst Server to V7.0.0.

Therefore, if you upgrade Worklight Server from V6.0.0.x or earlier to MobileFirst Server V7.0.0, you must pay particular attention to the following procedure.

Is this step required for your upgrade path?						System status after this step, if both Application Center and MobileFirst Server are on the same application server	
Worklight Server V5.0.6.x to MobileFirst Server V7.0.0	Worklight Server V6.0.x to MobileFirst Server V7.0.0	Worklight Server V6.1.x to MobileFirst Server V7.0.0.x	Worklight Server V6.2.x to MobileFirst Server V7.0.0	MobileFirst Server V6.3.x to MobileFirst Server V7.0.0	V7.0.0 to V7.0.0.x (fix pack or interim fix)	Application Center Status	MobileFirst Server Status
Yes	Yes	No	No	No	No	Running	Running

### Procedure

If your current version of MobileFirst Server includes existing applications that target environments that are no longer supported by MobileFirst Server V7.0.0:

- For old, no-longer-supported environments, your application developers must update the MobileFirst application to run with an environment supported by MobileFirst Server V7.0.0 before you can run it.
- For new environments for which support is added after the release of MobileFirst Server V7.0.0, check for the availability of a fix pack release that provides support for this environment.

The following table can help to determine the IBM Worklight versions in which support for older environments was discontinued, and to suggest possible replacement environments for those environments.

Environment	Support removed in	Suggested replacement path
Facebook	IBM Worklight V6.0.0	Desktop web app

Environment	Support removed in	Suggested replacement path
iGoogle	IBM Worklight V6.0.0	Review environments supported by IBM Worklight V6.1.0
Apple OS X Dashboard	IBM Worklight V6.0.0	Review environments supported by IBM Worklight V6.1.0
Windows 7 and Vista	IBM Worklight V6.0.0	Review environments supported by IBM Worklight V6.1.0
Windows Phone 7.5	IBM Worklight V6.1.0	Review environments supported by IBM Worklight V6.1.0

**Related concepts:**

“Version compatibility” on page 7-1

Compatibility among different versions of the IBM MobileFirst Platform Foundation for iOS client and server depends on several factors.

**In-place upgrade or rolling upgrade to MobileFirst Server V7.0.0**

You can upgrade to a new version of the product in one of two ways: as an *in-place upgrade* or as a *rolling upgrade*. An in-place upgrade replaces the previous version while a rolling upgrade does not.

You can replace the previous version by the new one or you can install the new version alongside the previous one.

**In-place upgrade**

An upgrade by which the old version of Worklight Server or MobileFirst Server is no longer installed after the new version of MobileFirst Server is installed.

In-place upgrades require some downtime of the service.

**Rolling upgrade**

An upgrade that installs the new version of MobileFirst Server such that it runs side-by-side with the old version of Worklight Server or MobileFirst Server in the same application server or in a different application server.

The procedure for a rolling upgrade to apply a fix pack to IBM MobileFirst Platform Foundation for iOS V7.0.0 is documented in “Rolling upgrade procedure to apply a fix pack to IBM MobileFirst Platform Foundation for iOS V7.0.0” on page 7-53.

The following table shows possible upgrade paths.

Table 7-4. Upgrade paths

Is this step required for your upgrade path?						System status after this step, if both Application Center and MobileFirst Server are on the same application server	
Worklight Server V5.0.6.x to MobileFirst Server V7.0.0	Worklight Server V6.0.x to MobileFirst Server V7.0.0	Worklight Server V6.1.x to MobileFirst Server V7.0.0.x	Worklight Server V6.2.x to MobileFirst Server V7.0.0	MobileFirst Server V6.3.x to MobileFirst Server V7.0.0	V7.0.0 to V7.0.0.x (fix pack or interim fix)	Application Center Status	MobileFirst Server Status
Yes	Yes	Yes	Yes	Yes	Yes	Running	Running

## Packaging change of WebSphere Application Server Liberty profile in IBM Worklight V6.x

Important information about how WebSphere Application Server Liberty profile is delivered since IBM Worklight V6.0.0, and what is the impact on the upgrade of your production MobileFirst Server.

### About this task

**Important:** The information on this page applies to you if you previously installed Worklight Server V5.x with the embedded WebSphere Application Server Liberty profile option.

Since IBM Worklight V6.1.0, WebSphere Application Server Liberty Core is not embedded in the IBM Installation Manager wizard of MobileFirst Server. Instead, it is provided as a separate IBM Installation Manager wizard.

Is this step required for your upgrade path?						System status after this step, if both Application Center and MobileFirst Server are on the same application server	
Worklight Server V5.0.6.x to MobileFirst Server V7.0.0	Worklight Server V6.0.x to MobileFirst Server V7.0.0	Worklight Server V6.1.x to MobileFirst Server V7.0.0.x	Worklight Server V6.2.x to MobileFirst Server V7.0.0	MobileFirst Server V6.3.x to MobileFirst Server V7.0.0	V7.0.0 to V7.0.0.x (fix pack or interim fix)	Application Center Status	MobileFirst Server Status
Yes	No	No	No	No	No	Running	Running

### Procedure

As a result of this packaging, the MobileFirst Server upgrade process does not upgrade your installed version of WebSphere Application Server Liberty profile, and will not apply fix packs to it in the future. At the end of the upgrade process, your Liberty server remains installed in `<WorklightServerInstallationDirectory>/server/wlp`, but is considered as an external file from the perspective of upgrades, uninstall, and updates from the IBM Installation Manager wizard of MobileFirst Server.

To prevent this existing server from being uninstalled during the upgrade process, the IBM Installation Manager wizard temporarily renames its directory during the upgrade process. It is critical to apply the steps that are defined in section Special steps for WebSphere Application Server Liberty profile before you start the upgrade process. The result of not completing these steps can be a non-functional server.

### Alternate Method: Move your MobileFirst apps and data to a new Liberty server

This alternate upgrade method migrates your MobileFirst Operations Console and Application Center to a new WebSphere Application Server Liberty profile server installed by IBM Installation Manager. This server can be updated by IBM Installation Manager when new updates for Liberty are made available.

1. Stop the Liberty server that was installed with the previous version of IBM MobileFirst Platform Foundation for iOS.

2. Install WebSphere Application Server Liberty Core with IBM Installation Manager. The installer for WebSphere Application Server Liberty Core is part of the IBM MobileFirst Platform Foundation for iOS package.
3. Create a server in this new WebSphere Application Server Liberty profile installation. If you are not familiar with the creation of a server for Liberty, see the “Tutorial for a basic installation of MobileFirst Server” on page 6-23.
4. Configure the Liberty server for your production environment.
5. Modify the Ant files created in section “Identify the MobileFirst WAR file and prepare the Ant deployment script” on page 7-11 to point to the newly installed WebSphere Application Server Liberty Core.
6. When you reach the step “Running IBM Installation Manager and completing the Application Center upgrade” on page 7-25, follow the instructions for “Upgrading from Worklight Server V5.0.6.x (changing the Liberty server)” on page 7-29.

### Become familiar with IBM Installation Manager before you start

Before you start the actual installation, verify that you have all the products that you want to install and that you are familiar with IBM Installation Manager procedures.

#### About this task

You use IBM Installation Manager to complete the actual upgrade. Before you start, verify that you have all of the necessary installation components, and that you understand the installation procedure.

Is this step required for your upgrade path?						System status after this step, if both Application Center and MobileFirst Server are on the same application server	
Worklight Server V5.0.6.x to MobileFirst Server V7.0.0	Worklight Server V6.0.x to MobileFirst Server V7.0.0	Worklight Server V6.1.x to MobileFirst Server V7.0.0.x	Worklight Server V6.2.x to MobileFirst Server V7.0.0	MobileFirst Server V6.3.x to MobileFirst Server V7.0.0	V7.0.0 to V7.0.0.x (fix pack or interim fix)	Application Center Status	MobileFirst Server Status
Yes	Yes	Yes	Yes	Yes	Yes	Running	Running

### Procedure

Before you use IBM Installation Manager to upgrade your production server, familiarize (or refamiliarize) yourself with how it works:

1. Make sure that you have the appropriate version of IBM Installation Manager installed on the installation workstation.

**Note:** IBM Installation Manager is sometimes referred to as *IBM Rational Enterprise Deployment* on the eXtreme Leverage, Passport Advantage sites, and on the distribution disks. The file names for the images take the form *IBM Rational Enterprise Deployment <version number><hardware platform> <language>*; for example, *IBM Rational Enterprise Deployment V1.6.3.Windows Multilingual*.

Use IBM Installation Manager V1.7.2, especially on Windows. For more information about IBM Installation Manager procedures, see the IBM Installation Manager user documentation.

**Important:** If you are performing an in-place upgrade, and you have IBM Installation Manager installed on your computer in several different modes, for example, administrator mode and nonadministrator (single user) mode, you must use the same mode used to install the previous version of Worklight Server or MobileFirst Server.

2. Download the repositories that are required for the update from Passport Advantage, or have them available if they are on physical media.

For more information about the types of upgrade repositories available, see “Information about the repositories.”

3. Verify that the products that you want to update are contained in the IBM Installation Manager repositories.
4. If you do not plan to use IBM Installation Manager in graphical mode but in silent install mode, review the procedures for a silent install as documented in “Command-line installation with XML response files (silent installation)” on page 6-31 and “Working with sample response files for IBM Installation Manager” on page 6-32 and prepare your response file.

To prepare your response file from sample response files, create a response file based on the following versions of MobileFirst Server, and sample files:

Table 7-5. Sample upgrade response files in the *Silent\_Install\_Sample\_Files.zip*

Initial version of MobileFirst Server	Sample file
Worklight Server V5.x	upgrade-initially-worklightv5.xml
Worklight Server V6.x	upgrade-initially-worklightv6.xml
IBM MobileFirst Platform Server V6.x	upgrade-initially-mfpserverv6.xml
IBM MobileFirst Platform Server V7.x	upgrade-initially-mfpserver.xml

In the <offering> element in the <install> element, set the version attribute to match the release you want to upgrade to, or remove the version attribute if you want to upgrade to the newest version available in the repositories.

## Information about the repositories

There are three types of repositories: base repositories, delta repositories, and interim fix repositories:

- A *base repository* is an installation package that is available on Passport Advantage or on physical media. It is self-contained.
- A *delta repository* is an installation package that is available from FixCentral and is labeled as an *update pack*. It requires a base repository of the previous release version to be functional.
- An *interim fix repository* is an installation package that is available from FixCentral and is labeled as an interim fix, and that is only versioned by a build number. It requires the repositories of the previous release version to be functional: either a base repository, or both a base repository and a delta repository.

To install a major release (for example, MobileFirst Server V7.0.0), you need only:

- The base repository V7.0.0 installation package from Passport Advantage or physical media.

To install a fix pack release (for example, MobileFirst Server V7.0.0.1), you need:

- The corresponding base repository (such as MobileFirst Server V7.0.0) installation package from Passport Advantage or physical media. The corresponding base repository for V7.0.0.x fix packs is the V7.0.0 release.
- The appropriate V7.0.0.x installation package from FixCentral.

For a fix pack installation, you must add both repositories to the list known to IBM Installation Manager. Then, in the example given, IBM Installation Manager recognizes the V7.0.0 release as an **Install** choice and the V7.0.0.x release (or interim fix) as an **Update** choice.

To install an interim fix release, you can need up to three repositories:

- The repositories for the release to which the fix applies.
- The repository for the fix.

For installing an interim fix, you must add all these repositories to the list known to IBM Installation Manager. Then IBM Installation Manager recognizes the interim fix as an Update choice.

### **Review of the basic IBM Installation Manager steps**

**Attention:** The following steps are not the actual installation. They are preparatory tasks to help you ensure that you have everything that is required for the upgrade. Be sure to click **Cancel** in the last step.

1. Start IBM Installation Manager.
2. Click **File > Preferences > Repositories** to add references to the repositories that you downloaded and extracted on a local disk, or that you can access through the internet.  
See Repository preferences for details.
3. Click **Install**.
4. Verify that the products list contains everything that you need.
5. Click **Cancel**. Do not proceed with the installation.

## **Starting the MobileFirst Server V7.0.0 upgrade process**

In this phase of the upgrade process, you shut down and back up the application server and MobileFirst databases and perform other pre-installation tasks.

When you finish the tasks that are listed in “Preparation for upgrades to MobileFirst Server” on page 7-7, you can begin the actual upgrade process.

**Note:** After you complete this phase of the upgrade process, your MobileFirst Server, Application Center, databases, and application server(s) are (or can be) offline. They are no longer available to support existing apps or provide service to existing users of those apps. The upgrade process itself can take several hours. Therefore, you must plan the timing of this process for non-critical hours to have minimal impact on users.

The following topics present the steps, in the order in which they must be completed.

### **Verify the ownership of your MobileFirst Server files**

Before you begin the actual installation, check the ownership of all MobileFirst Server files.

## About this task

The upcoming step “Running IBM Installation Manager and completing the Application Center upgrade” on page 7-25 attempts to remove and replace many files in the MobileFirst Server installation directory. This step can fail if the single-user mode of IBM Installation Manager is used and some of the files or directories are not owned by that user. Therefore, it is useful to guard against this case.

Is this step required for your upgrade path?						System status after this step, if both Application Center and MobileFirst Server are on the same application server	
Worklight Server V5.0.6.x to MobileFirst Server V7.0.0	Worklight Server V6.0.x to MobileFirst Server V7.0.0	Worklight Server V6.1.x to MobileFirst Server V7.0.0.x	Worklight Server V6.2.x to MobileFirst Server V7.0.0	MobileFirst Server V6.3.x to MobileFirst Server V7.0.0	V7.0.0 to V7.0.0.x (fix pack or interim fix)	Application Center Status	MobileFirst Server Status
Yes	Yes	Yes	Yes	Yes	Yes	Running	Running

## Procedure

If you previously installed MobileFirst Server with the nonadministrator (single-user) mode of IBM Installation Manager, check whether all files and directories in the `product_install_dir` installation directory are owned by the current user.

For more information about Installation Manager administrator and nonadministrator modes, see Administrator, nonadministrator, and group mode. Group mode is not supported for MobileFirst Server installation.

On UNIX, you can use the following command to list the files and directories that do not fulfill this condition.

```
cd product_install_dir
find . '!'-user "$USER" -print
```

This command is expected to return nothing.

## What to do next

See also: “File system prerequisites” on page 6-5

## Back up your application server

Back up the directory that contains the application server and its configuration.

## About this task

Back up your application server so that you can recover in case of an unsuccessful server upgrade. This strategy covers the rare cases in which the new application server version fails to work correctly if errors occur in the forthcoming configuration changes.

Is this step required for your upgrade path?						System status after this step, if both Application Center and MobileFirst Server are on the same application server	
Worklight Server V5.0.6.x to MobileFirst Server V7.0.0	Worklight Server V6.0.x to MobileFirst Server V7.0.0	Worklight Server V6.1.x to MobileFirst Server V7.0.0.x	Worklight Server V6.2.x to MobileFirst Server V7.0.0	MobileFirst Server V6.3.x to MobileFirst Server V7.0.0	V7.0.0 to V7.0.0.x (fix pack or interim fix)	Application Center Status	MobileFirst Server Status
Yes	Yes	Yes	Yes	Yes	Yes	Running	Running

## Procedure

Back up all the application servers (or network deployment nodes) where the Application Center and MobileFirst Server administration applications are installed.

For WebSphere Application Server Liberty profile:

- Back up the `usr` directory. By default this directory is located in `<LibertyInstallDir>/usr`, but its location can be redefined by the `WLP_USER_DIR` variable in `<LibertyInstallDir>/env/server.env`.

For WebSphere Application Server full profile:

- If your original installation was to one or more servers under the control of a deployment manager, and not a single stand-alone server:
  - Either use the WebSphere `backupConfig` command to back up the deployment manager node.
  - Or back up the `config` directory inside the deployment manager profile directory.
- If your original installation was to a stand-alone server:
  - Either use the WebSphere `backupConfig` command to back up the entire node.
  - Or back up the application server profile directory.

See the documentation for Apache Tomcat to determine the directories to back up for this application server.

## Shutting down the application server

If you use WebSphere Application Server Liberty profile or Apache Tomcat, you must shut down the application server during this step.

## About this task

You must shut down the application server before running IBM Installation Manager in the following three cases:

- If your application server is Apache Tomcat.
- If your application server is WebSphere Application Server Liberty Core.
- If your application server is the embedded version of WebSphere Application Server Liberty profile that is installed by the Worklight Server V5.0.6 or earlier installer.



- In this case, you must also shut down all processes that have either their current working directory inside or opened files inside the MobileFirst installation directory hierarchy.
- On Windows, you must also shut down all such processes inside the Liberty MobileFirst Server directory hierarchy, which is in C:\ProgramData\IBM\Worklight\WAS85liberty-server.

Otherwise, if the application server is running when IBM Installation Manager starts the upgrade, some upgrade operations might fail, leaving the MobileFirst Server installation in an inconsistent state.

Is this step required for your upgrade path?						System status after this step, if both Application Center and MobileFirst Server are on the same application server	
Worklight Server V5.0.6.x to MobileFirst Server V7.0.0	Worklight Server V6.0.x to MobileFirst Server V7.0.0	Worklight Server V6.1.x to MobileFirst Server V7.0.0.x	Worklight Server V6.2.x to MobileFirst Server V7.0.0	MobileFirst Server V6.3.x to MobileFirst Server V7.0.0	V7.0.0 to V7.0.0.x (fix pack or interim fix)	Application Center Status	MobileFirst Server Status
Yes	Yes	Yes	Yes	Yes	Yes	Stopped (Liberty and Tomcat) Running (others)	Stopped (Liberty and Tomcat) Running (others)

## Procedure

For Apache Tomcat and WebSphere Application Server Liberty Core, use the administration commands to shut down the application server as you would normally.

For the embedded version of WebSphere Application Server Liberty Server, you can use the following procedure:

1. Ensure that the *JAVA\_HOME* environment variable points to the installation directory of a Java 6 or 7 implementation (JRE or JDK), or that the *PATH* environment variable contains a java program from a Java 6 or 7 implementation.
2. Shut down the server.
  - a. On UNIX, enter the following commands, changing the installation location if necessary:
 

```
cd /opt/IBM/Worklight
cd server/wlp/bin
./server stop worklightServer
```
  - b. On Windows, enter the following commands, changing the installation location if necessary:
 

```
cd C:\Program Files (x86)\IBM\Worklight
cd server\wlp\bin
server.bat stop worklightServer
```
3. Verify that no other runaway Liberty server processes are running in the same directory. On Linux and AIX, you can list such processes with the following command:
 

```
ps auxww | grep java | grep /wlp/
```

## Stop all instances of the Application Center applications

Stop the applications currently running on Application Center.

### About this task

If you have installed Application Center on multiple servers, networked or not, then all instances of the IBM Application Center Console and IBM Application Center Services must be stopped before you run IBM Installation Manager to upgrade the MobileFirst Server installation.

Is this step required for your upgrade path?						System status after this step, if both Application Center and MobileFirst Server are on the same application server	
Worklight Server V5.0.6.x to MobileFirst Server V7.0.0	Worklight Server V6.0.x to MobileFirst Server V7.0.0	Worklight Server V6.1.x to MobileFirst Server V7.0.0.x	Worklight Server V6.2.x to MobileFirst Server V7.0.0	MobileFirst Server V6.3.x to MobileFirst Server V7.0.0	V7.0.0 to V7.0.0.x (fix pack or interim fix)	Application Center Status	MobileFirst Server Status
Yes (if installed on multiple servers)	Yes (if installed on multiple servers)	Yes (if installed on multiple servers)	Yes (if installed on multiple servers)	Yes (if installed on multiple servers)	See fix pack or interim fix installation instructions	Stopped (all instances)	Stopped (Liberty and Tomcat) Running (others)

### Procedure

The reason this step is required is that IBM Installation Manager migrates the schema of the database so that it can be used with MobileFirst Server V7.0.0. No instance of Application Center can be running while this operation is performed.

After the database is migrated, only migrated Application Center applications must be run, because only migrated applications are able to read and write to the new databases. Otherwise, the Application Center database might be corrupted.

If you installed Application Center only once, this operation is done automatically by IBM Installation Manager.

### Back up the Application Center database

Before you run IBM Installation Manager to install MobileFirst Server V7.0.0, back up your Application Center database.

### About this task

In the upgrade process, the Application Center database is updated and migrated to a schema compatible with MobileFirst Server V7.0.0. This operation cannot be undone. If, for any reason, you decide to roll back the upgrade of MobileFirst Server, you need this backup.

Is this step required for your upgrade path?						System status after this step, if both Application Center and MobileFirst Server are on the same application server	
Worklight Server V5.0.6.x to MobileFirst Server V7.0.0	Worklight Server V6.0.x to MobileFirst Server V7.0.0	Worklight Server V6.1.x to MobileFirst Server V7.0.0.x	Worklight Server V6.2.x to MobileFirst Server V7.0.0	MobileFirst Server V6.3.x to MobileFirst Server V7.0.0	V7.0.0 to V7.0.0.x (fix pack or interim fix)	Application Center Status	MobileFirst Server Status
Yes	Yes	Yes	Yes	Yes	See interim fix installation instructions	Stopped (all instances)	Stopped (Liberty and Tomcat) Running (others)

## Procedure

Use the standard procedures for your DBMS (IBM DB2, Oracle, or MySQL) to back up the Application Center database. The default name for the Application Center database, unless you modified it at install time, is as follows:

- For IBM DB2, MySQL, and Oracle, if you installed IBM Worklight V5.0.6: APPCNTR
- For IBM DB2 and MySQL if you installed IBM Worklight V6.0.0 or later: APPCNTR
- For Oracle, if you installed IBM Worklight V6.0.0 or later: ORCL

The runtime and reports databases are backed up as well, but in a later step of this procedure. For more information, see step “Back up the runtime and reports databases” on page 7-35 of this upgrade procedure.

## Running IBM Installation Manager and completing the Application Center upgrade

Use IBM Installation Manager to install the new MobileFirst Server version.

Before you continue, make sure that you completed all of the steps in the “Preparation for upgrades to MobileFirst Server” on page 7-7 and “Starting the MobileFirst Server V7.0.0 upgrade process” on page 7-20 sections that preceded this step.

It is also possible to run IBM Installation Manager in silent install mode, using response files that are either generated by using it in wizard mode on a machine where a GUI is available, or by working with sample response files supplied with IBM MobileFirst Platform Foundation for iOS. For more information, see “Command-line installation with XML response files (silent installation)” on page 6-31 and “Working with sample response files for IBM Installation Manager” on page 6-32.

### Upgrading from MobileFirst Server V6.3.0, or V7.0.0

In this step, you run IBM Installation Manager to perform the upgrade from MobileFirst Server V7.0.0.

## About this task

IBM Installation Manager completes the following tasks:

- It installs on your disk the files and tools that are required to deploy IBM MobileFirst Platform Foundation for iOS on your application server.
- If Application Center was installed in the previous version of MobileFirst Server, the installer also:
  - Undeploys the previous version of the Application Center from the application server.
  - Upgrades the databases of Application Center to the format used by the current version of IBM MobileFirst Platform Foundation for iOS V7.0.0. To see a copy of the upgrade scripts, you can install MobileFirst Server in a new package group and review a copy of the upgrade scripts in `<MobileFirstInstallDir>/ApplicationCenter/databases`.
  - Deploys the new version of Application Center to the application server and connects it to the upgraded database.
  - Configures the application server for running the Application Center.

Is this step required for your upgrade path?						System status after this step, if both Application Center and MobileFirst Server are on the same application server	
Worklight Server V5.0.6.x to MobileFirst Server V7.0.0	Worklight Server V6.0.0.x to MobileFirst Server V7.0.0	Worklight Server V6.1.0.x to MobileFirst Server V7.0.0.x	Worklight Server V6.2.0.x to MobileFirst Server V7.0.0	MobileFirst Server V6.3.0.x to MobileFirst Server V7.0.0	V7.0.0 to V7.0.0.x (fix pack or interim fix)	Application Center Status	MobileFirst Server Status
No	No	No	No	Yes	Yes	Stopped (all instances)	Stopped (Liberty and Tomcat) Running (others)

## Procedure

Having prepared for this step by becoming familiar with IBM Installation Manager and ensuring that you have all the proper repositories for the upgrade, start the actual installation using the following steps:

1. Start IBM Installation Manager.
2. Click **Update**.
3. Step through the installation wizard, following the onscreen prompts to complete the upgrade.

### Upgrading from Worklight Server V6.0.0, V6.1.0, or V6.2.0

In this step, you run IBM Installation Manager to perform the actual upgrade from IBM Worklight V6.x to MobileFirst Server V7.0.0.

## About this task

IBM Installation Manager completes the following tasks:

- It installs on your disk the files and tools that are required to deploy IBM MobileFirst Platform Foundation for iOS on your application server.
- If Application Center was installed in the previous version of IBM Worklight, the installer also:
  - Undeploys the previous version of the Application Center from the application server.
  - Upgrades the databases of Application Center to the format used by IBM MobileFirst Platform Foundation for iOS V7.0.0. To see a copy of the upgrade scripts, you can install MobileFirst Server in a new package group and review a copy of the upgrade scripts in `<MobileFirstInstallDir>/ApplicationCenter/databases`.
  - Deploys the new version of Application Center to the application server and connects it to the upgraded database.
  - Configures the application server for running the Application Center.

Is this step required for your upgrade path?						System status after this step, if both Application Center and MobileFirst Server are on the same application server	
Worklight Server V5.0.6.x to MobileFirst Server V7.0.0	Worklight Server V6.0.x to MobileFirst Server V7.0.0	Worklight Server V6.1.x to MobileFirst Server V7.0.0.x	Worklight Server V6.2.x to MobileFirst Server V7.0.0	MobileFirst Server V6.3.x to MobileFirst Server V7.0.0	V7.0.0 to V7.0.0.x (fix pack or interim fix)	Application Center Status	MobileFirst Server Status
No	Yes	Yes	Yes	No	No	Stopped (all instances)	Stopped (Liberty and Tomcat) Running (others)

## Procedure

Having prepared for this step by becoming familiar with IBM Installation Manager and ensuring that you have all the proper repositories for the upgrade, start the actual installation using the following steps:

1. Start IBM Installation Manager.
2. Click **Install**.

**Note:** In IBM MobileFirst Platform Foundation for iOS, you must upgrade by clicking **Install**, because the package name for Worklight Server changed between Worklight Server and MobileFirst Server.

3. Select the package group that contains your Worklight Server installation.
4. Step through the installation wizard, following the onscreen prompts to complete the upgrade.

### Upgrading from Worklight Server V5.0.6.x

Use this procedure to upgrade from Worklight Server V5.0.6.x to MobileFirst Server V7.0.0 in a stand-alone WebSphere Application Server or Apache Tomcat environment.

## About this task

If you originally installed IBM Worklight on:

- A stand-alone WebSphere Application Server Liberty profile server,
- A stand-alone WebSphere Application Server full profile server, or
- A stand-alone Apache Tomcat server,

use the following procedure, with the IBM Installation Manager **Install** function.

Is this step required for your upgrade path?						System status after this step, if both Application Center and MobileFirst Server are on the same application server	
Worklight Server V5.0.6.x to MobileFirst Server V7.0.0	Worklight Server V6.0.x to MobileFirst Server V7.0.0	Worklight Server V6.1.x to MobileFirst Server V7.0.0	Worklight Server V6.2.x to MobileFirst Server V7.0.0	MobileFirst Server V6.3.x to MobileFirst Server V7.0.0	V7.0.0 to V7.0.0.x (fix pack or interim fix)	Application Center Status	MobileFirst Server Status
Yes (unless Liberty server was installed by Worklight Server V5.0.6)	No	No	No	No	No	Stopped (all instances)	Uninstalled

## Procedure

1. Start IBM Installation Manager.
2. Click **Install**. The package name for MobileFirst Server has changed between Worklight Server V5.x and MobileFirst Server V7.0.0, so the upgrade must be done with the 'Install' process.
3. If you are doing an in-place upgrade (see “In-place upgrade or rolling upgrade to MobileFirst Server V7.0.0” on page 7-16), select the package group that contains your Worklight Server installation. If you are doing a rolling upgrade, select **Create a new package group**.
4. Step through the installation wizard. If you are doing an in-place upgrade, most choices are disabled (displayed in gray). But you can change the passwords for the database or for WebSphere Application Server access if they are different from the original installation.
5. IBM Installation Manager completes the following tasks:
  - It installs on your disk the files and tools that are required to deploy IBM MobileFirst Platform Foundation for iOS in your application server.
  - It undeploys the previous version of IBM Worklight from the Application Server.
  - It removes the application server configurations that were set by the previous installer of Worklight Server.
  - If Application Center was installed in the previous version of Worklight Server, the installer also:
    - Undeploys the previous version of the Application Center from the application server.

- Upgrades the databases of Application Center to the format used by the current version of MobileFirst Server. To see a copy of the upgrade scripts, you can install MobileFirst Server in a new package group and review a copy of the upgrade scripts in `<MobileFirstInstallDir>/ApplicationCenter/databases`.
- Deploys the new version of Application Center to the application server and connects it to the upgraded database.
- Configure the application server for running the Application Center.

### Upgrading from Worklight Server V5.0.6.x (changing the Liberty server)

This step contains special instructions if you are migrating to a new instance of WebSphere Application Server Liberty profile.

#### About this task

This task is part of the “Alternate Method: Move your MobileFirst apps and data to a new Liberty server” on page 7-17 section of the “Packaging change of WebSphere Application Server Liberty profile in IBM Worklight V6.x” on page 7-17 step.

Is this step required for your upgrade path?						System status after this step, if both Application Center and MobileFirst Server are on the same application server	
Worklight Server V5.0.6.x to MobileFirst Server V7.0.0	Worklight Server V6.0.x to MobileFirst Server V7.0.0	Worklight Server V6.1.x to MobileFirst Server V7.0.0.x	Worklight Server V6.2.x to MobileFirst Server V7.0.0	MobileFirst Server V6.3.x to MobileFirst Server V7.0.0	V7.0.0 to V7.0.0.x (fix pack or interim fix)	Application Center Status	MobileFirst Server Status
Yes (if Liberty server was installed by Worklight Server V5.0.6)	No	No	No	No	No	Stopped (all instances)	Uninstalled

#### Procedure

Having prepared for this step by becoming familiar with IBM Installation Manager and ensuring that you have all the proper repositories for the upgrade, start the actual installation using the following steps:

1. Start IBM Installation Manager.
2. Click **Install**.
3. Select a new package group.
4. Step through the installation wizard. Enter the database settings used to install Application Center for V5.0.6.
5. For the Application Server choice, select the newly installed WebSphere Application Server Liberty Core.

## Restore the Application Center configurations and restart the application server

In this step, you restore the required configurations of Application Center that you made note of in a previous step.

### About this task

Restore the configurations that you previously identified in step “Review and note the Application Server configuration for MobileFirst Server and Application Center” on page 7-13.

Is this step required for your upgrade path?						System status after this step, if both Application Center and MobileFirst Server are on the same application server	
Worklight Server V5.0.6.x to MobileFirst Server V7.0.0	Worklight Server V6.0.x to MobileFirst Server V7.0.0	Worklight Server V6.1.x to MobileFirst Server V7.0.0.x	Worklight Server V6.2.x to MobileFirst Server V7.0.0	MobileFirst Server V6.3.x to MobileFirst Server V7.0.0	V7.0.0 to V7.0.0.x (fix pack or interim fix)	Application Center Status	MobileFirst Server Status
Yes	Yes	No	No	No	See fix pack or interim fix installation instructions	Upgraded	Running (if upgrading from V6.0.x or later), Stopped (if upgrading from V5.0.6.x)

### Procedure

- The applications to restore are as follows:
  - For the applications:
    - The Application Center Console
    - The Application Center Services
- The JDBC data sources to restore are as follows:
  - The Application Center database
- When you have restored these configurations, restart the application server that was upgraded.

### Results

At the end of this step, Application Center is upgraded. All applications previously loaded in Application Center should be available.

However, if this Application Center is running on the same application server as a MobileFirst Operations Console, that application server is shut down again in a later step, and is only restarted in subsequent steps.



## Upgrading the MobileFirst runtime environment for MobileFirst Server V7.0.0

In these postinstallation steps, you set or restore configurations for MobileFirst Server, its databases, and MobileFirst Operations Console, and restart the application server.

Since IBM Worklight V6.0.0, it is possible to deploy several MobileFirst runtime environments to an application server. You must perform these steps for each MobileFirst runtime environment that you deployed and that you want to upgrade to V7.0.0. If you migrated a MobileFirst runtime environment and deployed it on multiple application servers, all instances must be upgraded.

Complete each of the following steps, as required for your particular upgrade path.

### Stop all MobileFirst Server instances

Before you complete subsequent upgrade steps, you must shut down all runtime environments. You must also disable the auto start mode of the Worklight Console if you upgrade from IBM Worklight V6.0.0.x on WebSphere Application Server full profile.

### About this task

If you installed Worklight Server or MobileFirst Server on multiple servers, whether networked or not, you must stop all runtime environments before you move on to the next steps.

**Note:** You must do so even if you installed only one runtime environment.

This step is mandatory because in step “Upgrade the runtime and reports databases” on page 7-36, you upgrade the schema of the databases so that it can be used with MobileFirst Server V7.0.0. No database schema can be upgraded while a runtime environment is running.

After the database is upgraded, only upgraded runtime environments can run, because only upgraded applications can read and write to the new databases. Otherwise, the database might be corrupted.

Is this step required for your upgrade path?						System status after this step, if both Application Center and MobileFirst Server are on the same application server	
Worklight Server V5.0.6.x to MobileFirst Server V7.0.0	Worklight Server V6.0.x to MobileFirst Server V7.0.0	Worklight Server V6.1.x to MobileFirst Server V7.0.0.x	Worklight Server V6.2.x to MobileFirst Server V7.0.0	MobileFirst Server V6.3.x to MobileFirst Server V7.0.0	V7.0.0 to V7.0.0.x (fix pack or interim fix)	Application Center Status	MobileFirst Server Status
Yes	Yes	Yes	Yes	Yes	See the installation instructions for the fix pack or interim fix	Upgraded	Stopped (all instances)

**Important:** In addition to stopping all runtime environments, if you upgrade from IBM Worklight V6.0.0.x on WebSphere Application Server full profile, you must also disable the auto start mode of the Worklight Console application during the upgrade before you shut down the Worklight Server. If the auto start mode is not disabled, the Worklight Console modifies the database when the server is started in step “Upgrading the MobileFirst runtime environment for MobileFirst Server V7.0.0” on page 7-31 and prevents the new MobileFirst runtime environment from starting.

To disable the auto start mode:

1. Log in to the WebSphere Console.
2. Go to the menu **Applications > Application Types > WebSphere enterprise applications**, and list the applications.
3. In the table, click Worklight Console application, whose default name is **IBM\_Worklight\_Console**.
4. In **Detail Properties** click **Target Specific Application Status**.
5. Select all the target servers, or the cluster where the application is installed.
6. Click **Disable Auto Start**.
7. Click **Save** to save the configuration.
8. Verify that the **Auto Start** property in the table is set to **No**.

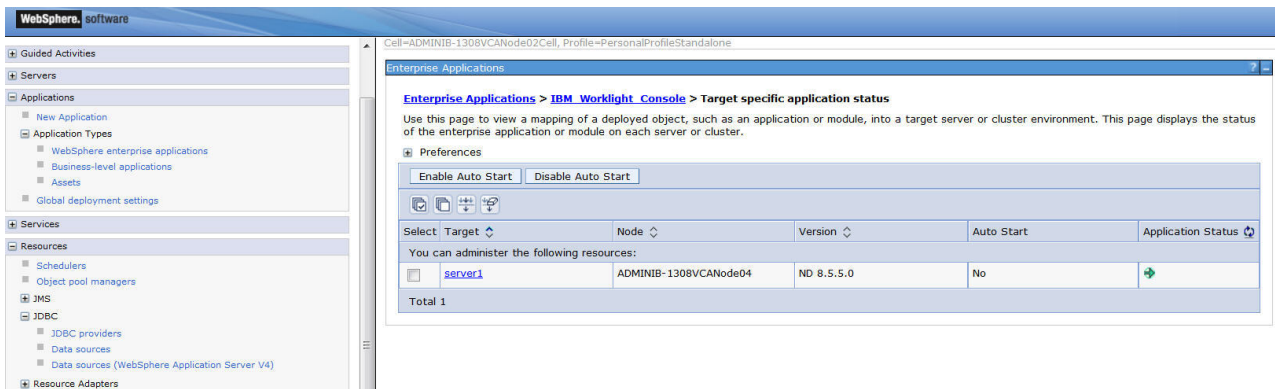

Figure 7-1.

## Shutting down the application server to be upgraded

For certain configurations, in this step you shut down the application server before completing subsequent steps.

### About this task

For certain types of application servers (see the following table and “Procedure” on page 7-33 section), you must shut down the application server before proceeding to subsequent steps.

Is this step required for your upgrade path?						System status after this step, if both Application Center and MobileFirst Server are on the same application server	
Worklight Server V5.0.6.x to MobileFirst Server V7.0.0	Worklight Server V6.0.x to MobileFirst Server V7.0.0	Worklight Server V6.1.x to MobileFirst Server V7.0.0.x	Worklight Server V6.2.x to MobileFirst Server V7.0.0	MobileFirst Server V6.3.x to MobileFirst Server V7.0.0	V7.0.0 to V7.0.0.x (fix pack or interim fix)	Application Center Status	MobileFirst Server Status
Yes	Yes	Yes	Yes	Yes	Yes	Stopped (embedded Liberty, Liberty on Windows, Tomcat on Windows), Upgraded (other cases)	Stopped (all instances)

### Procedure

In the following cases, you must shut down the application server before you undeploy applications from the MobileFirst Operations Console application:

- If the application server is WebSphere Application Server Liberty profile and the OS is Windows.
- If the application server is Apache Tomcat, and the OS is Windows or the database type is Apache Derby.

If these application servers are not shut down, the undeploy operations might fail.

### Installation or upgrade of MobileFirst Server Administration Services

As part of the MobileFirst Server upgrade, you must install the Administration Services, and optionally the MobileFirst Operations Console.

The following table lists the upgrade paths in which this step is mandatory.

Is this step required for your upgrade path?						System status after this step, if both Application Center and MobileFirst Server are on the same application server	
Worklight Server V5.0.6.x to MobileFirst Server V7.0.0	Worklight Server V6.0.x to MobileFirst Server V7.0.0	Worklight Server V6.1.x to MobileFirst Server V7.0.0.x	Worklight Server V6.2.x to MobileFirst Server V7.0.0	MobileFirst Server V6.3.x to MobileFirst Server V7.0.0	V7.0.0 to V7.0.0.x (fix pack or interim fix)	Application Center Status	MobileFirst Server Status
Yes	Yes	Yes	Yes	Yes	Yes	Stopped (embedded Liberty, Liberty on Windows, Tomcat on Windows), upgraded (other cases)	Stopped (all instances)

The procedure is different depending on whether you upgrade from a previous version to V7.0.0, or to a fix pack or interim fix.

**For an upgrade from Worklight Server V6.1.0 or earlier to MobileFirst Server V7.0.0** Follow the steps in “Installing the MobileFirst Server administration” on page 6-43.

**For an upgrade from Worklight Server V6.2.0 or MobileFirst Server V6.3.0 to MobileFirst Server V7.0.0**

1. Back up the administration database
2. Find the Ant file that you created in “Identify the MobileFirst WAR file and prepare the Ant deployment script” on page 7-11.
3. Make sure that the taskdef for the `worklight-ant-deployer.jar` file uses the correct directory. The correct directory is the directory that contains the upgraded installation of MobileFirst Server V7.0.0.
4. Set the **ANT\_HOME** environment variable to `product_install_dir/tools/apache-ant-1.8.4/`.
5. Upgrade the administration database:  
`product_install_dir/tools/apache-ant-1.8.4/bin/ant -f your_file adm_databases`
6. Run the **minimal-admupdate** target of the Ant file:  
`product_install_dir/tools/apache-ant-1.8.4/bin/ant -f your_file minimal-admupdate`

**For an upgrade from MobileFirst Server V7.0.0 to a fix pack or to an interim fix**

1. Find the Ant file that you created in “Identify the MobileFirst WAR file and prepare the Ant deployment script” on page 7-11.
2. Make sure that the taskdef for the `worklight-ant-deployer.jar` file uses the correct directory. The correct directory is the directory that contains the upgraded installation of MobileFirst Server V7.0.0.
3. Set the **ANT\_HOME** environment variable to `product_install_dir/tools/apache-ant-1.8.4/`.
4. Run the **minimal-admupdate** target of the Ant file:  
`product_install_dir/tools/apache-ant-1.8.4/bin/ant -f your_file minimal-admupdate`

## Back up the runtime and reports databases

Back up the contents of your MobileFirst project databases.

### About this task

**Important:** Before performing this step, verify that you have completed step “Stop all MobileFirst Server instances” on page 7-31, and that no instance of MobileFirst Server is still running, and thus still using these databases.

During the upgrade process in the steps “Upgrade the runtime and reports databases” on page 7-36 and “Upgrade the MobileFirst Server runtime environment” on page 7-38, the data that is specific to administration and runtime environments are split into distinct databases:

- The MobileFirst data that is related to administration is moved to the administration database.
- The runtime and reports databases that you previously updated are migrated to a schema compatible with MobileFirst Server V7.0.0.

The previous operations cannot be undone.

If, for some reason, you decide to roll back the upgrade of MobileFirst Server, you need this backup.

Is this step required for your upgrade path?						System status after this step, if both Application Center and MobileFirst Server are on the same application server	
Worklight Server V5.0.6.x to MobileFirst Server V7.0.0	Worklight Server V6.0.x to MobileFirst Server V7.0.0	Worklight Server V6.1.x to MobileFirst Server V7.0.0.x	Worklight Server V6.2.x to MobileFirst Server V7.0.0	MobileFirst Server V6.3.x to MobileFirst Server V7.0.0	V7.0.0 to V7.0.0.x (fix pack or interim fix)	Application Center Status	MobileFirst Server Status
Yes	Yes	Yes	Yes	Yes	See fix pack or interim fix installation instructions	Stopped (embedded Liberty, Liberty on Windows, Tomcat on Windows), Upgraded (other cases)	Stopped (all instances)

### Procedure

The default names for the databases, unless you modified them at installation time, are as follows:

- For IBM DB2, Derby, MySQL, and Oracle, if you installed IBM Worklight V5.0.6.x: WRKLGHT and WLREPORT
- For IBM DB2, Derby, and MySQL, if you installed IBM Worklight V6.x: WRKLGHT and WLREPORT
- For Oracle, if you installed IBM Worklight V6.x, for Oracle: ORCL

## Upgrade the runtime and reports databases

You must move the data that is related to administration to the administration database. You must also upgrade the runtime and the reports databases to a schema that is compatible with MobileFirst Server V7.0.0.

### Before you begin

1. Make sure that you complete step “Stop all MobileFirst Server instances” on page 7-31, and that no instance of Worklight Server or MobileFirst Server is still running, and therefore is still using these databases.
2. Make sure that you complete step “Installation or upgrade of MobileFirst Server Administration Services” on page 7-33 and that the administration database exists.

**Note:** This procedure explains how to upgrade the database with Ant tasks. For a manual upgrade of the databases, see “Manually upgrading the MobileFirst Server V7.0.0 databases” on page 7-43 instead.

### About this task

In this step, you run Ant scripts to perform operations on your MobileFirst Server databases.

Is this step required for your upgrade path?						System status after this step, if both Application Center and MobileFirst Server are on the same application server	
Worklight Server V5.0.6.x to MobileFirst Server V7.0.0	Worklight Server V6.0.x to MobileFirst Server V7.0.0	Worklight Server V6.1.x to MobileFirst Server V7.0.0.x	Worklight Server V6.2.x to MobileFirst Server V7.0.0	MobileFirst Server V6.3.x to MobileFirst Server V7.0.0	V7.0.0 to V7.0.0.x (fix pack or interim fix)	Application Center Status	MobileFirst Server Status
Yes	Yes	Yes	Yes	Yes	See fix pack or interim fix installation instructions	Stopped (embedded Liberty, Liberty on Windows, Tomcat on Windows), Upgraded (Other cases)	Stopped (all instances)

### Procedure

1. If you upgrade from IBM Worklight V6.0.0.x, and the application server is WebSphere Application Server full profile, make sure that you disabled the auto start mode for all instances of the Worklight Console application, as specified in “Stop all MobileFirst Server instances” on page 7-31.
2. Locate the Ant file that you created in section “Identify the MobileFirst WAR file and prepare the Ant deployment script” on page 7-11.
3. Verify that taskdef for the `worklight-ant-deployer.jar` uses the directory that contains the upgraded installation of MobileFirst Server V7.0.0.

In this example, check the value of the **worklight.server.install.dir** property because this property defines the directory of the `worklight-ant-deployer.jar` in the taskdef tag:

```
<property name="worklight.server.install.dir" value="c:/Program File/IBM/Worklight"/>

[...]

<taskdef resource="com/worklight/ant/defaults.properties">
 <classpath>
 <fileset dir="${worklight.server.install.dir}/WorklightServer">
 <include name="worklight-ant-deployer.jar"/>
 </fileset>
 </classpath>
</taskdef>
```

**Important:** This verification step defines the version of IBM MobileFirst Platform Foundation for iOS that you use to upgrade the databases, to deploy the WAR file, and to install the MobileFirst runtime library for the MobileFirst Operations Console.

4. Set the **ANT\_HOME** environment variable to `product_install_dir/tools/apache-ant-1.8.4/`.

This version of Apache Ant is the one for which the MobileFirst deployment scripts are tested. If you do not set this environment variable before you run the script if and have another installation of Ant on your computer, that installation might be used.

5. In the Ant file, make sure that the Ant task `<configuredatabase kind="Worklight">` contains an `<admindatabase>` subelement.

**Note:** In the following example code, DB2 is the DBMS. The **`${contextRoot}`** property contains the value of the context root of the MobileFirst project.

```
<configuredatabase kind="Worklight">
 <db2 database="WRKLGHT" server="proddb.example.com"
 user="w16admin" password="w16pass" schema="WLRT">
 <dba user="db2inst1" password="db2IsFun"/>
 </db2>
 <driverclasspath>
 <fileset dir="/opt/database-drivers/db2-9.7">
 <include name="db2jcc4.jar"/>
 <include name="db2jcc_license_*.jar"/>
 </fileset>
 </driverclasspath>
 <admindatabase runtimeContextRoot=${contextRoot}>
 <db2 database="WLADMIN" server="proddb.example.com"
 user="w16admin" password="w16pass" schema="ADMIN">
 </db2>
 <driverclasspath>
 <fileset dir="/opt/database-drivers/db2-9.7">
 <include name="db2jcc4.jar"/>
 <include name="db2jcc_license_*.jar"/>
 </fileset>
 </driverclasspath>
 </admindatabase>
</configuredatabase>
```

6. Start the **databases** target of the Ant file with this command:

```
product_install_dir/tools/apache-ant-1.8.4/bin/ant -f your_file databases
```

**Note:** If you created an Ant file with your own target names, the Ant task to start is **configuredatabase**.

- If you use push notifications and you want to upgrade from V6.1.0 or earlier, configure your runtime database manually for push notifications by following the instructions in “Runtime database configuration for Push notifications” on page 7-49.

This procedure loads the administration database and upgrades the database schemas for the runtime and reports databases to V7.0.0.

### Upgrade the MobileFirst Server runtime environment

In this step, you run the Ant script to upgrade MobileFirst runtime environment to V7.0.0. You must repeat this procedure as many times for each runtime environment to upgrade.

#### About this task

In this step, you run the same Ant script as in the previous step, but with a different parameter to indicate the Ant target and the nature of the upgrade.

Is this step required for your upgrade path?						System status after this step, if both Application Center and MobileFirst Server are on the same application server	
Worklight Server V5.0.6.x to MobileFirst Server V7.0.0	Worklight Server V6.0.x to MobileFirst Server V7.0.0	Worklight Server V6.1.x to MobileFirst Server V7.0.0.x	Worklight Server V6.2.x to MobileFirst Server V7.0.0	MobileFirst Server V6.3.x to MobileFirst Server V7.0.0	V7.0.0 to V7.0.0.x (fix pack or interim fix)	Application Center Status	MobileFirst Server Status
Yes	Yes	Yes	Yes	Yes	Yes	Stopped (Embedded Liberty, Liberty on Windows, Tomcat on Windows), Upgraded (other cases)	Stopped (Embedded Liberty, Liberty on Windows, Tomcat on Windows), Partially upgraded (other cases)

#### Procedure

- Locate the Ant file that you created in section “Identify the MobileFirst WAR file and prepare the Ant deployment script” on page 7-11.
- Verify that the taskdef for the worklight-ant-deployer.jar uses the correct directory containing the upgraded installation of MobileFirst Server V7.0.0.

In the example shown below, you need to check the value of the property worklight.server.install.dir because this property is used to define the directory of the worklight-ant-deployer.jar in the taskdef tag:

```
<property name="Worklight.server.install.dir" value="c:/Program File/IBM/Worklight"/>
```

[...]

```
<taskdef resource="com/worklight/ant/defaults.properties">
 <classpath>
 <fileset dir="${product_install_dir}/WorklightServer">
```



```

 <include name="worklight-ant-deployer.jar"/>
 </fileset>
</classpath>
</taskdef>

```

This verification step is extremely important. It defines the version of IBM MobileFirst Platform Foundation for iOS that you use to migrate the databases, to deploy the WAR file, and to install the MobileFirst runtime library for the MobileFirst Operations Console.

3. Verify that the **environmentID** attribute for the MobileFirst runtime environment matches the **environmentID** attribute that you used to install the MobileFirst Server administration file. For more information, see “Identify the MobileFirst WAR file and prepare the Ant deployment script” on page 7-11.
4. Set the environment variable `ANT_HOME` to `product_install_dir/tools/apache-ant-1.8.4/`.

This is the version of Apache Ant for which the MobileFirst deployment scripts have been tested. If you do not set this environment variable before running the script, and have another installation of Ant on your computer, that installation may be used.

5. Select the Ant target.
  - To upgrade from V5.0.6.x, use **install**.
  - To upgrade from V6.0.0.x, or V6.1.0.x, use **uninstall**, then **install**.
  - To upgrade from V6.2.0.x, or V6.3.0.x, use **minimal-update**.
  - To upgrade from V7.0.0 to a fix pack or interim fix, use one of the following choices:
    - Use **uninstall**, then **install** or **minimal-update**.
    - Or use **minimal-update**.

Your choice depends on the nature of the changes in the fix. For more information, see the installation instructions for the fix pack or interim fix.

6. Run Ant with the selected target:

```
product_install_dir/tools/apache-ant-1.8.4/bin/ant -f your file target defined in step 4
```

This script has the following effects:

- It migrates the WAR file to match the runtime environment of the MobileFirst Server installation.
- It installs the MobileFirst runtime environment to the application server, with the root context as defined in the Ant file.

**Note:** The context root of the runtime environment cannot be changed because the mobile applications that you previously deployed keep pointing to this context root.

- It connects the runtime environment to the Administration Services through a Java Management Extensions (JMX) mechanism.
- If you choose to install the MobileFirst Operations Console, it connects the MobileFirst Operations Console to the Administration Services to manage the MobileFirst runtime environment.

## Upgrading server farms for MobileFirst Server 7.0

### About this task

In this step, you upgrade your server farms to be compatible with MobileFirst Server 7.0. Read from the following tables whether this step is required for your

upgrade path and what the system status is afterward if both Application Center and MobileFirst Server are on the same application.

*Table 7-6. Is this step required for your upgrade path?.*

Worklight® Server V6.0.x to MobileFirst Server V7.0.0	No
Worklight Server V5.0.6.x to MobileFirst Server V7.0.0	No
Worklight Server V6.1.x to MobileFirst Server V7.0.0	No
Worklight Server V6.2.x to MobileFirst Server V7.0.0	Yes
MobileFirst Server V6.3.x to MobileFirst Server V7.0.0	Yes
V7.0.0 to V7.0.0.x (fix pack or interim fix)	No

*Table 7-7. System status after this step.*

Module	Status
Application Center	Stopped (Embedded Liberty, Liberty on Windows, Tomcat on Windows), Upgraded (other cases)
MobileFirst Server	Stopped (Embedded Liberty, Liberty on Windows, Tomcat on Windows), Partially upgraded (other cases)

For more information, see “List of JNDI properties for MobileFirst Server administration” on page 6-86.

### WebSphere Application Server Liberty

Optionally, you can remove some unused JNDI properties and configure the heartbeat rate and timeout values.

- The following JNDI properties in the server.xml file are not used any more. You can remove them.

```
<jndiEntryjndiName="ibm.worklight.farm.type"
value="File"/>
<jndiEntryjndiName="ibm.worklight.farm.definition.location" value="<plugin xml file location>"/>
```

- You can configure the heartbeat rate and timeout values by defining the following JNDI properties in the server.xml file.

```
<jndiEntryjndiName="worklight.admin.farm.heartbeat"
value="<heartbeat rate in minutes>"/>
<jndiEntryjndiName="ibm.worklight.admin.farm.missed.heartbeats.timeout"
value="<number of missed heartbeats before considering the server as being down>"/>
```

### Tomcat

Optionally, you can remove some unused JNDI properties and configure the heartbeat rate and timeout values.

- The following JNDI properties in the server.xml file are not used any more. You can remove them.

```
<Environment name="ibm.worklight.farm.type" value="File" type="java.lang.String"
override="false"/>
<Environment name="ibm.worklight.farm.definition.location"
value="<plugin xml file location>" type="java.lang.String" override="false"/>
```

- You can configure the heartbeat rate and timeout values by defining the following JNDI properties in the server.xml file.

```
<Environment name="worklight.admin.farm.heartbeat" value="<heartbeat rate in minutes>"
type="java.lang.String" override="false"/>
<Environmentname="ibm.worklight.admin.farm.missed.heartbeats.timeout"
value="<number of missed heartbeats before considering the server as being down>"type="java.lang.String"override="false">
```

## WebSphere Application Server

### Required modifications

You must set new JNDI properties in MobileFirst Administration Services applications and every MobileFirst runtime application.

1. Open the WebSphere Application Server administration console.
2. On the navigation pane, select **Applications > Application Types > Websphere enterprise applications**.
3. Select the application that you want to configure.
4. In **Web Module Properties**, click **Environment entries for Web Modules** to display the JNDI properties.
5. Set the **ibm.worklight.admin.jmx.user** property to a user name that has access to the SOAP connector.
6. Set the **ibm.worklight.admin.jmx.pwd** property to the password of the user that you declared in the **ibm.worklight.admin.jmx.user** property.
7. Verify that the **ibm.worklight.admin.jmx.connector** property is set to **SOAP**.

### Optional modifications

You can configure the heartbeat rate and timeout values by defining the **worklight.admin.farm.heartbeat** and **ibm.worklight.admin.farm.missed.heartbeats.timeout** JNDI properties in the MobileFirst Administration Services application.

## Restore the MobileFirst Server Configuration

In this step you restore the required configurations of MobileFirst Server that you made note of in a previous step.

### About this task

Restore the configurations that you previously identified in step “Review and note the Application Server configuration for MobileFirst Server and Application Center” on page 7-13.

Is this step required for your upgrade path?						System status after this step, if both Application Center and MobileFirst Server are on the same application server	
Worklight Server V5.0.6.x to MobileFirst Server V7.0.0	Worklight Server V6.0.x to MobileFirst Server V7.0.0	Worklight Server V6.1.x to MobileFirst Server V7.0.0.x	Worklight Server V6.2.x to MobileFirst Server V7.0.0	MobileFirst Server V6.3.x to MobileFirst Server V7.0.0	V7.0.0 to V7.0.0.x (fix pack or interim fix)	Application Center Status	MobileFirst Server Status
Yes	Yes	Yes	No	No	See fix pack or interim fix installation instructions	Stopped (embedded Liberty, Liberty on Windows, Tomcat on Windows), Upgraded (other cases)	Stopped (embedded Liberty, Liberty on Windows, Tomcat on Windows), Upgraded (other cases)

### Procedure

- The applications to restore are as follows:
  - For the applications:
    - The MobileFirst runtime environments.
  - For the JDBC data source:
    - The runtime and reports database.

### Restart the application server

In this final step, you restart the application server.

### About this task

Now that the upgrade of MobileFirst Server is completed, restart your application server.

Is this step required for your upgrade path?						System status after this step, if both Application Center and MobileFirst Server are on the same application server	
Worklight Server V5.0.6.x to MobileFirst Server V7.0.0	Worklight Server V6.0.x to MobileFirst Server V7.0.0	Worklight Server V6.1.x to MobileFirst Server V7.0.0.x	Worklight Server V6.2.x to MobileFirst Server V7.0.0	MobileFirst Server V6.3.x to MobileFirst Server V7.0.0	V7.0.0 to V7.0.0.x (fix pack or interim fix)	Application Center Status	MobileFirst Server Status
Yes	Yes	Yes	Yes	Yes	Yes	Upgraded	Upgraded

### Procedure

- Use your standard procedures to start the application server, or restart the application server if it was running in this step, so that all changes are taken into account.

At the end of this step, the MobileFirst Server is upgraded. All applications that you previously deployed are available, along with their environments (those that are supported by MobileFirst Server V7.0.0).

The URL of the MobileFirst Operations Console changed. If you did not specify a context root in the Ant file, its context root is `/worklightconsole`.

## Additional MobileFirst Server V7.0.0 upgrade information

This section contains additional information that may be of use if you have additional test or pre-production databases that must be updated, if you need to update HTTP redirections on networked servers, if you are manually upgrading the application server, or in the event of a failed upgrade.

### Recovering from an unsuccessful upgrade to MobileFirst Server V7.0.0

Instructions for how to recover from a failed installation or to revert to the previous version of Worklight Server or MobileFirst Server.

#### About this task

If the MobileFirst Server upgrade fails for any reason, use the following procedure to restore the previous Worklight Server or MobileFirst Server version.

#### Procedure

The **Roll Back** button of IBM Installation Manager is not supported for MobileFirst Server. Therefore, to return to the previous version:

1. Uninstall MobileFirst Server, with IBM Installation Manager.
2. Install the old version of Worklight Server or MobileFirst Server with IBM Installation Manager, specifying the same installation parameters that you used previously.
3. Restore the databases. For more information, see “Back up the runtime and reports databases” on page 7-35.
4. Restore the application server. For more information, see “Back up your application server” on page 7-21.
5. If the server fails to start and load the applications, delete `workarea` of the server before starting it again. For example, for a WebSphere Application Server Liberty profile backup, the `workarea` is the directory `<LibertyInstallDir>/usr/servers/<serverName>/workarea`.

### Manually installing the MobileFirst Server administration during the upgrade

You can manually install the MobileFirst Server administration as part of the MobileFirst Server upgrade.

Since IBM Worklight Foundation V6.2.0, you must install the administration components. To manually set up the MobileFirst Server administration, follow the steps detailed in “Manually installing MobileFirst Server administration” on page 6-56.

### Manually upgrading the MobileFirst Server V7.0.0 databases

Follow these instructions to manually update the MobileFirst project databases. First set up the MobileFirst Server administration environment.

**Note:** The reports database, referenced below as WLREPORT, is deprecated in IBM MobileFirst Platform Foundation for iOS V7.0.0. You should use “Operational analytics” on page 12-8 instead. Note that setting up the reports database is optional in this release and prior releases. Also note that the use of the reports database is redundant with MobileFirst Operational Analytics console in this release and previous releases, because of the deprecation of the reports database.

If you prefer to update databases manually instead of using the Ant tasks, you must update their sets of tables and columns manually. For example, if you have test or preproduction databases as part of your production environment, each served by a different runtime database or schema, you can use this procedure to update their schemas.

Updating the reports (by default WLREPORT), and the Application Center (by default APPCNTR) databases is done by running a sequence of database scripts.

Updating the runtime database (by default WRKLGHT) and administration database (by default WLADMIN) is done by running a sequence of database scripts, if you upgrade from IBM Worklight Foundation V6.2.0 or later.

In IBM Worklight Foundation V6.2.0, the process of updating the runtime database (by default WRKLGHT) is required to move the runtime administrative data to the administration database. When you upgrade from IBM Worklight V6.1.0 or older, before you call the script `WorklightServer/databases/upgrade-worklight-61-62-<dbms>.sql`, run the data migration tool to update the administration database to V7.0.0. Then run the sql scripts from V6.2.0 to the current release to update the WRKLGHT database schema. If you forgot to run the data migration tool before you run the sql script, `WorklightServer/databases/upgrade-worklight-61-62-<dbms>.sql` is likely to fail, and indicates that the data migration was not run. In that case, the WRKLGHT schema is not updated, or is incorrect.

The data migration tool and the database upgrade scripts are both contained in the MobileFirst Server directory that you just installed.

## Procedure

For the WRKLGHT database, if you upgrade from IBM Worklight V6.1.0 or earlier:

1. Apply the proper sql scripts to upgrade the database to IBM Worklight V6.1.0.
2. Comment the line that refers to the index I\_USERPRF\_USERID if it was already created.
3. Run the data migration tool to update the administration database to V7.0.0.
4. Apply the proper sql scripts to upgrade the database from the previous version to IBM MobileFirst Platform Foundation for iOS V7.0.0.

For the WRKLGHT and WLADMIN databases, if you upgrade from V6.2.0 or later, you must apply the proper sql scripts to upgrade the databases to IBM MobileFirst Platform Foundation for iOS V7.0.0.

For the WLREPORT and APPCNTR databases: apply the proper sql scripts to upgrade the databases to IBM MobileFirst Platform Foundation for iOS V7.0.0.

See the following paragraphs to get information about the index I\_USERPRF\_USERID, the data migration tool, and the sql scripts.

## Running the data migration tool

**Note:** You must run the data migration tool only if you upgrade from V6.1.0 or earlier.

Before you run the tool in command line, make sure that the library `worklight-ant-deployer.jar` is in your current directory, or that your `CLASSPATH` variable references the directory it is in. Example on a Unix/Linux machine:

```
Go to the directory library that worklight-ant-deployer.jar is in
$ cd $product_install_dir/WorklightServer
Print the usage
$ java -cp worklight-ant-deployer.jar com.ibm.worklight.config.dbmigration.MigrationTool usage
Usage:
 java -cp worklight-ant-deployer.jar com.ibm.worklight.config.dbmigration.MigrationTool [options]
```

### Options:

```
-p <project> The name of the project to create.
-sourceurl The path to the source database.
-sourceschema The name of the schema of the source database.
-sourcedriver The fully qualified driver class name of the source
 database. This driver must be in the class path.
-sourceuser The user name of the source database.
-sourcepassword The password of the source database.
-sourceproperty <key> <value> Adds additional OpenJPA properties to the connection
 of the source database.
-targeturl The path to the target database.
-targetschema The name of the schema of the target database.
-targetdriver The fully qualified driver class name of the target
 database. This driver must be in the class path.
-targetuser The user name of the target database.
-targetpassword The password of the target database.
-targetproperty <key> <value> Adds additional OpenJPA properties to the connection
 of the target database.
```

```
Example with DB2 as DBMS
$ java -cp worklight-ant-deployer.jar com.ibm.worklight.config.dbmigration.MigrationTool
-p worklight
-sourceurl jdbc:db2://proddb.example.com:50000/WRKLGHT
-sourceschema WLRT
-sourcedriver com.ibm.db2.jcc.DB2Driver
-sourceuser wuser1
-sourcepassword wuser1_pswd
-targeturl jdbc:db2://proddb.example.com:50000/WLADMIN
-targetschema ADMIN
-targetdriver com.ibm.db2.jcc.DB2Driver
-targetuser wuser2
-targetpassword wuser2_pswd
```

To run the data migration tool, you must add the database drivers to the class path. For example, to migrate a DB2 database, you must add the `db2jcc4.jar` file and the license JAR file (for example `db2jcc_license_cu.jar`), to the class path:

```
$ java -cp worklight-ant-deployer.jar:/path/to/db2jcc4.jar:/path/to/db2jcc_license_cu.jar
com.ibm.worklight.config.dbmigration.MigrationTool usage
```

### Note:

- The name of the project to create (worklight in the example) must be the context root where the MobileFirst runtime component (project WAR file) is deployed. For example, if the runtime component is deployed in the application server with a context root `/worklight`, then the project name must be `worklight`. The applications will be assigned to this project name. When a runtime component starts, it contacts the administration service to get the applications and the adapters it needs to serve. The runtime component uses its project name, computed by removing the initial `/` from its context root, to indicate which

applications it needs. If the project name is not the same as the context root without the initial slash, then the migrated applications and the adapters are not visible by the runtime component.

- For MySQL databases, the schema options '-sourceschema' and '-targetschema' must be left unspecified. The name of the schema to use will be the name of the database specified in the connection URL.

## SQL scripts

**Important:** Before you apply the sql scripts that upgrade the WRKLGHT database from the previous version to IBM MobileFirst Platform Foundation for iOS V7.0.0, you must check whether the index I\_USERPRF\_USERID, in column USER\_ID of the table GADGET\_USER\_PREF, exists. If it does, in the WorklightServer/databases/upgrade-worklight-61-62-<dbms>.sql script, comment the following line that refers to its creation before running it:

```
INDEX I_USERPRF_USERID ON GADGET_USER_PREF (USER_ID);
```

For more information about this index, see the technote IBM Worklight queries on the GADGET\_USER\_PREF table might take time.

## Scripts for DB2

For an upgrade from IBM Worklight V5.0.6.x to V6.0.0:

- WorklightServer/databases/upgrade-worklight-506-60-db2.sql (for WRKLGHT)
- WorklightServer/databases/upgrade-worklightreports-506-60-db2.sql (for REPORTS)
- ApplicationCenter/databases/upgrade-appcenter-506-60-db2.sql (for APPCNTR)

For an upgrade from IBM Worklight V6.0.0.x to V6.1.0:

- WorklightServer/databases/upgrade-worklight-60-61-db2.sql (for WRKLGHT)
- WorklightServer/databases/upgrade-worklightreports-60-61-db2.sql (for REPORTS)
- ApplicationCenter/databases/upgrade-appcenter-60-61-db2.sql (for APPCNTR)

For an upgrade from IBM Worklight V6.1.0.x to IBM Worklight Foundation V6.2.0:

- WorklightServer/databases/upgrade-worklightadmin-61-62-db2.sql (for WLADMIN)
- WorklightServer/databases/upgrade-worklight-61-62-db2.sql (for WRKLGHT)
- WorklightServer/databases/upgrade-worklightreports-61-62-db2.sql (for REPORTS)
- ApplicationCenter/databases/upgrade-appcenter-61-62-db2.sql (for APPCNTR)

For an upgrade from IBM Worklight Foundation V6.2.0.x to IBM MobileFirst Platform Foundation for iOS V6.3.0:

- WorklightServer/databases/upgrade-worklightadmin-62-63-db2.sql (for WLADMIN)
- WorklightServer/databases/upgrade-worklight-62-63-db2.sql (for WRKLGHT)



- WorklightServer/databases/upgrade-worklightreports-62-63-db2.sql (for REPORTS)
- ApplicationCenter/databases/upgrade-appcenter-62-63-db2.sql (for APPCNTR)

For an upgrade from IBM MobileFirst Platform Foundation for iOS V6.3.0.x to IBM MobileFirst Platform Foundation for iOS V 7.0.0:

- WorklightServer/databases/upgrade-worklightadmin-63-70-db2.sql (for WLADMIN)
- WorklightServer/databases/upgrade-worklight-63-70-db2.sql (for WRKLGHT)
- WorklightServer/databases/upgrade-worklightreports-63-70-db2.sql (for REPORTS)
- ApplicationCenter/databases/upgrade-appcenter-63-70-db2.sql (for APPCNTR)

These scripts are applied similarly to steps 4 and 6 in “Setting up your DB2 databases manually” on page 10-18

**Note:** If you are using Application Center, the size limit for applications stored on Application Center with IBM DB2 is 1 GB. If you have applications larger than 1 GB in the Application Center, remove them before starting the upgrade process.

## Scripts for MySQL

For an upgrade from IBM Worklight V5.0.6 to V6.0.0:

- WorklightServer/databases/upgrade-worklight-506-60-mysql.sql (for WRKLGHT)
- WorklightServer/databases/upgrade-worklightreports-506-60-mysql.sql (for REPORTS)
- ApplicationCenter/databases/upgrade-appcenter-506-60-mysql.sql (for APPCNTR)

For an upgrade from IBM Worklight V6.0.0.x to V6.1.0:

- WorklightServer/databases/upgrade-worklight-60-61-mysql.sql (for WRKLGHT)
- WorklightServer/databases/upgrade-worklightreports-60-61-mysql.sql (for REPORTS)
- ApplicationCenter/databases/upgrade-appcenter-60-61-mysql.sql (for APPCNTR)

For an upgrade from IBM Worklight V6.1.0.x to IBM Worklight Foundation V6.2.0:

- WorklightServer/databases/upgrade-worklightadmin-61-62-mysql.sql (for WLADMIN)
- WorklightServer/databases/upgrade-worklight-61-62-mysql.sql (for WRKLGHT)
- WorklightServer/databases/upgrade-worklightreports-61-62-mysql.sql (for REPORTS)
- ApplicationCenter/databases/upgrade-appcenter-61-62-mysql.sql (for APPCNTR)

For an upgrade from IBM Worklight Foundation V6.2.0.x to IBM MobileFirst Platform Foundation for iOS V6.3.0:

- WorklightServer/databases/upgrade-worklightadmin-62-63-mysql.sql (for WLADMIN)
- WorklightServer/databases/upgrade-worklight-62-63-mysql.sql (for WRKLGHT)
- WorklightServer/databases/upgrade-worklightreports-62-63-mysql.sql (for REPORTS)
- ApplicationCenter/databases/upgrade-appcenter-62-63-mysql.sql (for APPCNTR)

For an upgrade from IBM MobileFirst Platform Foundation for iOS V6.3.0.x to IBM MobileFirst Platform Foundation for iOS V7.0.0:

- WorklightServer/databases/upgrade-worklightadmin-63-70-mysql.sql (for WLADMIN)
- WorklightServer/databases/upgrade-worklight-63-70-mysql.sql (for WRKLGHT)
- WorklightServer/databases/upgrade-worklightreports-63-70-mysql.sql (for REPORTS)
- ApplicationCenter/databases/upgrade-appcenter-63-70-mysql.sql (for APPCNTR)

These scripts are applied similarly to step 1.b in “Setting up your MySQL databases manually” on page 10-29.

### Scripts for Oracle

For an upgrade from IBM Worklight V5.0.6 to V6.0.0:

- WorklightServer/databases/upgrade-worklight-506-60-oracle.sql (for WRKLGHT)
- WorklightServer/databases/upgrade-worklightreports-506-60-oracle.sql (for REPORTS)
- ApplicationCenter/databases/upgrade-appcenter-506-60-oracle.sql (for APPCNTR)

For an upgrade from IBM Worklight V6.0.0.x to V6.1.0:

- WorklightServer/databases/upgrade-worklight-60-61-oracle.sql (for WRKLGHT)
- WorklightServer/databases/upgrade-worklightreports-60-61-oracle.sql (for REPORTS)
- ApplicationCenter/databases/upgrade-appcenter-60-61-oracle.sql (for APPCNTR)

For an upgrade from IBM Worklight V6.1.0.x to IBM Worklight Foundation V6.2.0:

- WorklightServer/databases/upgrade-worklightadmin-61-62-oracle.sql (for WLADMIN)
- WorklightServer/databases/upgrade-worklight-61-62-oracle.sql (for WRKLGHT)
- WorklightServer/databases/upgrade-worklightreports-61-62-oracle.sql (for REPORTS)
- ApplicationCenter/databases/upgrade-appcenter-61-62-oracle.sql (for APPCNTR)

For an upgrade from IBM Worklight Foundation V6.2.0.x to IBM MobileFirst Platform Foundation for iOS V6.3.0:

- WorklightServer/databases/upgrade-worklightadmin-62-63-oracle.sql (for WLADMIN)
- WorklightServer/databases/upgrade-worklight-62-63-oracle.sql (for WRKLGHT)
- WorklightServer/databases/upgrade-worklightreports-62-63-oracle.sql (for REPORTS)
- ApplicationCenter/databases/upgrade-appcenter-62-63-oracle.sql (for APPCNTR)

For an upgrade from IBM MobileFirst Platform Foundation for iOS V6.3.0.x to IBM MobileFirst Platform Foundation for iOS V7.0.0:

- WorklightServer/databases/upgrade-worklightadmin-63-70-oracle.sql (for WLADMIN)
- WorklightServer/databases/upgrade-worklight-63-70-oracle.sql (for WRKLGHT)
- WorklightServer/databases/upgrade-worklightreports-63-70-oracle.sql (for REPORTS)
- ApplicationCenter/databases/upgrade-appcenter-63-70-oracle.sql (for APPCNTR)

These scripts are applied similarly to step 3 in “Setting up your Oracle databases manually” on page 10-34.

## Runtime database configuration for Push notifications

**Note:** The following section applies if you use push notifications and you upgrade from V6.1.0 or earlier.

To ensure that push notifications work as expected, you must complete some additional manual configuration. After your migration to V7.0.0 is complete (this includes a complete migration of both the runtime database and the runtime environment) and the application server is restarted, complete the steps based on your database type. No changes are required if you use MySQL or Derby.

This task requires administrator access privileges.

### DB2

1. Change *SCHEMANAME* instances to actual names.
2. Replace X and Y values based on the given description.

```
SELECT MAX(ID) FROM SCHEMANAME.PUSH_DEVICES;
SELECT MAX(ID) FROM SCHEMANAME.PUSH_SUBSCRIPTIONS;
```

```
--Value of X = Result of the selected query of PUSH_DEVICES + 1. For example, if SELEC
--SCHEMANAME.PUSH_DEVICES returns 100, then X = 101;
--Value of Y = Result of the selected query of PUSH_SUBSCRIPTIONS + 1. For example, if
--SCHEMANAME.PUSH_SUBSCRIPTIONS returns 100, then Y = 101;
```

```
ALTER SEQUENCE SCHEMANAME.PUSHDEVICE_SEQ RESTART WITH X ;
ALTER SEQUENCE SCHEMANAME.PUSHSUBSCRIPTION_SEQ RESTART WITH Y ;
```

```
VALUES NEXT VALUE FOR SCHEMANAME.PUSHDEVICE_SEQ;
VALUES NEXT VALUE FOR SCHEMANAME.PUSHSUBSCRIPTION_SEQ;
```

### Oracle

1. Change *SCHEMANAME* instances to actual names.
2. Replace X and Y values (based on the given description) while running the query.

```
SELECT MAX(ID) FROM SCHEMANAME.PUSH_DEVICES;
SELECT MAX(ID) FROM SCHEMANAME.PUSH_SUBSCRIPTIONS;
```

```
SELECT LAST_NUMBER FROM ALL_SEQUENCES WHERE SEQUENCE_NAME='PUSHDEVICE_SEQ';
SELECT LAST_NUMBER FROM ALL_SEQUENCES WHERE SEQUENCE_NAME='PUSHSUBSCRIPTION_SEQ';
```

--Take note of the resulting value of each query above to use in the following X and Y ca

--Value of X = (MAX(ID) OF PUSH\_DEVICES - LAST\_NUMBER OF PUSHDEVICE\_SEQ) + 20. For exampl  
 --SCHEMANAME.PUSH\_DEVICES returned 100 and SELECT LAST\_NUMBER FROM ALL\_SEQUENCES  
 --(where SEQUENCE\_NAME='PUSHDEVICE\_SEQ' is 50), then X=100-50+20 = 70

--Value of Y = (MAX(ID) OF PUSH\_SUBSCRIPTIONS - LAST\_NUMBER OF PUSHSUBSCRIPTION\_SEQ) + 20  
 --MAX(ID) FROM SCHEMANAME.PUSH\_SUBSCRIPTIONS returned 100, then Y = 101 and SELECT --LAST  
 --FROM ALL\_SEQUENCES (where SEQUENCE\_NAME='PUSHSUBSCRIPTION\_SEQ' is 50), then Y=100-50+20

```
ALTER SEQUENCE SCHEMANAME.PUSHDEVICE_SEQ INCREMENT BY X ;
SELECT SCHEMANAME.PUSHDEVICE_SEQ.NEXTVAL FROM dual;
ALTER SEQUENCE SCHEMANAME.PUSHDEVICE_SEQ INCREMENT BY 1;
```

```
ALTER SEQUENCE SCHEMANAME.PUSHSUBSCRIPTION_SEQ INCREMENT BY Y ;
SELECT SCHEMANAME.PUSHSUBSCRIPTION_SEQ.NEXTVAL FROM dual;
ALTER SEQUENCE SCHEMANAME.PUSHSUBSCRIPTION_SEQ INCREMENT BY 1;
```

## Manually upgrading the application server

Follow these instructions to manually upgrade the application server.

The recommended way to upgrade MobileFirst Server is to use IBM Installation Manager, either in its graphical mode or in silent mode with a response file, and the Ant tasks, as described previously.

However, if this is not applicable to your installation and you must update your application server manually, use a different series of steps.

Instead of completing the tasks “Running IBM Installation Manager and completing the Application Center upgrade” on page 7-25 and “Upgrade the MobileFirst Server runtime environment” on page 7-38, use the following procedure:

- Upgrade the databases manually as specified in section “Manually upgrading the MobileFirst Server V7.0.0 databases” on page 7-43.
- Review the manual installation procedures at:
  - “Manual installation of Application Center” on page 6-168
  - “Deploying a project WAR file and configuring the application server manually” on page 10-39
- Update the items manually. This includes, at a minimum:
  - The WAR file for the Application Center console, Application Center services, and the MobileFirst Operations Console.
  - The MobileFirst library `worklight-jee-library.jar`.
  - The MobileFirst runtime environment, which must be migrated to the current version of the server using the migrate Ant task described at “Migrating a project WAR file for use with a new MobileFirst Server” on page 10-39.

## Verifying and updating the HTTP redirections for MobileFirst Server V7.0.0

If you are upgrading to MobileFirst Server on a clustered application server environment, you should also update IBM HTTP Server after you install IBM MobileFirst Platform Foundation for iOS V7.0.0.

If your MobileFirst Server upgrade is to be installed on a WebSphere Application Server Network Deployment clustered environment or a WebSphere Application Server Liberty profile farm, you might have to update IHS after you install MobileFirst Server V7.0.0. For general information about installing these types of application server, see:

- “Setting up IBM MobileFirst Platform Foundation for iOS in WebSphere Application Server cluster environment” on page 6-241
- “Setting up an IBM HTTP Server in an IBM WebSphere Application Server Liberty profile farm” on page 6-252

If your application server receives HTTP requests forwarded by an HTTP server, the HTTP server configuration may require updating.

For IBM HTTP Server, in the IHS plugin file the context root of the applications must be updated especially for the session affinity configuration section. The following example is a configuration for Application Center that is deployed with its default settings, and a project that is deployed with a root context of /worklight.

```
<UriGroup Name="default_host_defaultServer_default_node_Cluster_URIs">
 <Uri AffinityCookie="JSESSIONID" AffinityURLIdentifier="jsessionid"
 Name="/worklight/*"/>
 <Uri AffinityCookie="JSESSIONID" AffinityURLIdentifier="jsessionid"
 Name="/applicationcenter/*"/>
 <Uri AffinityCookie="JSESSIONID" AffinityURLIdentifier="jsessionid"
 Name="/appcenterconsole/*"/>
</UriGroup>
```

## Updating DB2 schema names in the case of a manual installation

In this step, you must update the DB2 schema if you are using DB2 for the runtime database or the reports database.

### About this task

For the runtime database and the reports database, IBM MobileFirst Platform Foundation for iOS V7.0.0 expects the schema name without surrounding double quotation marks.

### Procedure

Perform one of the following steps, based on your installation.

1. WebSphere Application Server Liberty profile:
  - a. Edit the server.xml file in the usr/servers/serverName directory.
  - b. Look for the <properties.db2.jcc .../> element in the <dataSource jndiName="contextroot/jdbc/WorklightDS" ...> and <dataSource jndiName="contextroot/jdbc/WorklightReportsDS" ...> elements.
  - c. Optional: If there are double quotation marks around the value of the currentSchema attribute, you must remove them. For example, change currentSchema='wrkschem' or currentSchema="&quot;wrkschem&quot;" to currentSchema='wrkschem'.

2. WebSphere Application Server full profile:
  - a. Sign in to WebSphere Application Server administrative console.
  - b. Click **Resources > JDBC > Data sources**
  - c. For each database with the JNDI name jdbc/WorklightDS or jdbc/WorklightReportsDS, possibly with a suffix:
    - 1) Select the data source
    - 2) Click **Additional properties > Custom properties**.
    - 3) Select the currentSchema property.
    - 4) If the value is not empty, remove the double quotation marks around the value. For example, change the value "wrkschem" to wrkschem.
    - 5) Click **OK**.
    - 6) Click **Save** to save the changes.
3. Tomcat:
  - a. Edit the server.xml file in the conf directory.
  - b. In the <Resource name="jdbc/WorklightDS" .../> and <Resource name="jdbc/WorklightReportsDS" .../> elements, remove the double quotation marks around the value of the currentSchema connection property in the url attribute, if this property is present. For example, change url='jdbc:db2://dbserver.example.com:50000/WRKLGHT:currentSchema="wrkschem";' to url='jdbc:db2://dbserver.example.com:50000/WRKLGHT:currentSchema=wrkschem;'.

## Updating deployment scripts

If you use Ant tasks **app-deployer** or **adapter-deployer** to deploy apps or adapters, you must update the Ant scripts to use the Ant task **wladm**.

If you have Ant scripts that deploy apps or adapters by using the Ant tasks **app-deployer** or **adapter-deployer**, you must update them to use the Ant task **wladm**. The Ant tasks **app-deployer** or **adapter-deployer** no longer apply in IBM MobileFirst Platform Foundation for iOS V7.0.0.

**Note:** In the following code samples, *mf\_install\_dir* is the directory where you installed MobileFirst Server.

1. In the initialization commands of the Ant script, replace the path as follows:

```
<taskdef resource="com/worklight/ant/defaults.properties">
 <classpath>
 <pathelement location="mf_install_dir/WorklightServer/worklight-ant-deployer.jar"/>
 </classpath>
</taskdef>
```

With

```
<taskdef resource="com/worklight/ant/deployers/antlib.xml">
 <classpath>
 <pathelement location="mf_install_dir/WorklightServer/worklight-ant-deployer.jar"/>
 </classpath>
</taskdef>
```

2. Replace <app-deployer> calls.

```
<app-deployer deployable="myApp.wlapp"
 worklightserverhost="http://server-address:port/project-name"
 userName="username" password="password"/>
```

With

```
<wladm url="https://server-address:secure-port/worklightadmin" user="username" password="password">
 <deploy-app runtime="project-name" file="myApp.wlapp"/>
</wladm>
```

Set the placeholders as follows:

- For *worklightadmin*, substitute the actual context root of the MobileFirst administration services web application
- For *username* and *password*, pick a user that is in the role **worklightadmin** or **worklightdeployer**.

3. Replace <adapter-deployer> calls.

```
<adapter-deployer deployable="myAdapter.adapter"
 worklightserverhost="http://server-address:port/project-name"
 userName="username" password="password"/>
```

With

```
<wladm url="https://server-address:secure-port/worklightadmin" user="username" password="password">
 <deploy-adapter runtime="project-name" file="myAdapter.adapter"/>
</wladm>
```

Set the placeholders as follows:

- For *worklightadmin*, substitute the actual context root of the MobileFirst administration services web application.
- For *username* and *password*, you need to pick a user that is in the role **worklightadmin** or **worklightdeployer**.

For more information about the **wladm** Ant task, see “Administering MobileFirst applications through Ant” on page 11-11.

---

## Rolling upgrade procedure to apply a fix pack to IBM MobileFirst Platform Foundation for iOS V7.0.0

You can perform a rolling upgrade to apply a fix pack or an interim fix to an installation of MobileFirst Server V7.0.0 without downtime of the MobileFirst runtime environment. Performing this rolling upgrade ensures that there is no interruption of service for the mobile applications that query the MobileFirst Server .

To perform this rolling upgrade, you must install the upgraded version of IBM MobileFirst Platform Foundation for iOS in a different environment, for example a new cluster in WebSphere Application Server Network Deployment. This environment must be connected to the same databases as the initial IBM MobileFirst Platform Foundation for iOS installation. You must then switch HTTP traffic progressively from the old environment to the new environment.

The procedure for an in-place upgrade, with interruption of service, is documented at “Upgrading to IBM MobileFirst Platform Foundation for iOS V7.0.0” on page 7-1.

**Important:** This procedure applies to a MobileFirst Server installation, including the Administration Services, the MobileFirst Operations Console, and the MobileFirst runtime environment, but does not apply to the Application Center.

The following topics explain what you must plan for your production environment, and the steps of the rolling upgrade procedure for IBM MobileFirst Platform Foundation for iOS, installed in one cluster in IBM WebSphere

Application Server, with the HTTP traffic routed by an IBM HTTP Server, and web server plug-ins for IBM WebSphere Application Server.

## Planning the rolling upgrade procedure

You must plan the steps of the rolling upgrade procedure to install a fix pack to IBM MobileFirst Platform Foundation for iOS without downtime.

You must review, adapt, and test this upgrade procedure for your production environment. Other components that interact with IBM MobileFirst Platform Foundation for iOS in your production environment might require extra steps or changes to that procedure.

The goal of this procedure is to switch HTTP-based traffic from a previous installation of MobileFirst Server to an upgraded installation of MobileFirst Server. This is done without losing any data in the former databases, and without visible impact for users of applications that have an active session while this procedure is applied.

If other protocols than HTTP are used by some components of your application to interact with the MobileFirst Server, then you must include in your upgrade plan a way to route that traffic during a rolling upgrade procedure.

For example, if you use a pull mechanism for push notifications, you must review the risk of double notification or lost notification in a rolling upgrade procedure. For more information, see “Possible MobileFirst push notification architectures” on page 8-204.

You must review, with the development team, the code of all your adapters to identify extra steps that might be required for a rolling upgrade procedure. This is the case especially if these adapters require external resources, or use other communication protocols than HTTP, such as JMS or WebSphere MQ.

During the rolling upgrade, you must also stop management operations, such as uploading a new application or a new adapter to the console. If a new version of a MobileFirst application or adapter is uploaded to the MobileFirst Server during the upgrade procedure, some servers on the clusters might not be notified of this change and might continue to operate with the old artifact. If a new MobileFirst application is uploaded to the MobileFirst Server and the runtimes do not all have the same version, it might trigger arbitrary direct update sessions for the users of MobileFirst apps, depending on the server to which they were routed. Identify all MobileFirst administration users that have a privilege to upgrade an application. Their role is defined as `worklightadmin` or `worklightdeployer`. You can then notify them of the beginning and the end of the rolling upgrade. During that period, they must not upload any adapter or application.

This procedure requires to temporarily duplicate the environment. You might find it convenient to apply this procedure at a period of low traffic, so that you can use existing hardware resources for the servers of the new environment. You must double the number of instances of WebSphere Application Server during the rolling upgrade, and the hardware must have enough memory to run these servers without paging. The CPU requirements must not increase significantly during that procedure because the use on the servers that are being brought online would ramp up as new sessions get routed to the new version of the application. The CPU use on the servers that run the old version of the application must ramp down as existing sessions end.



## Overview of the rolling upgrade procedure

Learn about the steps of a rolling upgrade procedure.

You must perform the following actions to complete a rolling upgrade procedure. These steps are detailed in the following topics.

- Stop management operations while you apply the rolling upgrade procedure. No management operation, such as uploading a new application version or a new adapter, must be performed during a rolling upgrade.
- Duplicate the application server environment and install the fix pack IBM MobileFirst Platform Foundation for iOS V7.0.0.x in that duplicated environment, for example in a new cluster. You must use the existing administration database, MobileFirst runtime database, and MobileFirst reports database.
- Start a server in the duplicated environment.
- Direct some of the new HTTP sessions to the new servers and drain the servers of the previous installation so that they do not receive new HTTP sessions.

**Note:** IBM MobileFirst Platform Foundation for iOS uses session affinity and locally stores data about the state of sessions in a server. When routing traffic to the new cluster, existing sessions must continue to be routed to the old server with which they started.

- When the old servers are all drained and there is no longer any active session, and the new MobileFirst Server is confirmed to work correctly, shut down the old servers. If required, uninstall the old IBM MobileFirst Platform Foundation for iOS version from those servers.
- When the old environment is shut down, you can authorize management operations again.

## Performing a rolling upgrade to install a fix pack

Learn how to perform a rolling upgrade to install a fix pack to IBM MobileFirst Platform Foundation for iOS, assuming the following topology: IBM MobileFirst Platform Foundation for iOS is installed in one cluster in IBM WebSphere Application Server, and the HTTP traffic is routed by an IBM HTTP Server and web server plug-ins for IBM WebSphere Application Server.

### About this task

The following topics present the steps of the rolling upgrade procedure, in the order in which they must be completed.

**Note:** The cluster in which your current installation of the product is installed is called `cluster_WL61` in the following topics.

### Stopping management operations

Managements operations must not be performed during a rolling upgrade.

### Procedure

You must ensure that all management operations, such as uploading a new application or a new adapter, are stopped while you perform the rolling upgrade procedure.

Notify users with the privilege `worklightadmin` or `worklightdeployer` that they cannot deploy any artifact until the upgrade procedure is complete.

## Installing the IBM MobileFirst Platform Foundation for iOS fix pack in a new cluster

You must create a new cluster, in which you install the IBM MobileFirst Platform Foundation for iOS fix pack. Here, the procedure targets an installation in a WebSphere Application Server Network Deployment environment, in a single cell, with IBM HTTP Server and web server plug-ins for IBM WebSphere Application Server.

### Procedure

1. Create a cluster in IBM WebSphere Application Server. In the rest of this document, this cluster is called **cluster\_WL61FP1**.
2. Create servers in this cluster.
3. For each server, set a weight of 0.
4. Install the IBM MobileFirst Platform Foundation for iOS fix pack in this cluster. You can install this fix pack with the IBM MobileFirst Platform Foundation for iOS Ant tasks, or manually.
  - To install this fix pack with the IBM MobileFirst Platform Foundation for iOS Ant tasks, follow the steps 5 - 9 on page 7-57.
  - To install this fix pack manually, follow the steps 10 on page 7-57 - 14 on page 7-58.

Installing the fix pack with the IBM MobileFirst Platform Foundation for iOS Ant tasks:

5. With IBM Installation Manager, install the IBM MobileFirst Platform Foundation for iOS fix pack on the computer where the WebSphere Application Server Deployment Manager is installed.

**Note:** Do not install the Application Center.

6. Verify that WebSphere Application Server is not set to automatically generate and propagate the web plug-in. To be sure that the installation of the product fix-pack does not generate and propagate a new web plug-in that you did not review, perform the following steps.
  - a. Open the WebSphere Application Server administration console.
  - b. Go to **Servers > Server Types > Web Servers**.
  - c. In the table, click the web server.
  - d. Under **Additional Properties**, click **Plug-in properties**.
  - e. Make sure that the check box for **Automatically generate the plug-in configuration file** is not selected.
  - f. Make sure that the check box for **Automatically propagate plug-in configuration file** is not selected.
7. Copy the Ant file that you used to install IBM MobileFirst Platform Foundation for iOS in the cluster **cluster\_WL61**.
  - a. Modify the cluster name, for example `${was.nd.cluster.name}` in the code example in step 8.
  - b. Modify the environment ID.

You use this environment ID to distinguish the Administration Services and MobileFirst runtime environment from the two clusters. The new ID also generates different application names to avoid name conflicts in the WebSphere Application Server cell.
  - c. You must make these modifications for the following Ant tasks. Use the same environment ID in all the tasks.

- configureapplicationserver
- updateapplicationserver
- unconfigureapplicationserver
- installworklightadmin
- updateworklightadmin
- uninstallworklightadmin

**Important:** The environment ID determines which instance of Administration Services manages the deployed runtime environments. All runtime environments must have the same environment ID as the MobileFirst Server administration components.

8. Run the `admininstall` target of the Ant file.
9. Run the `install` target of the Ant file that installs the MobileFirst runtime environment. If you have more than one MobileFirst runtime environment, repeat this operation for all of them:

**Note:** Do not change the database settings, the context roots, or the other parameters of the installation.

```
<!-- Start of the install target Generated by IBM MobileFirst Platform Foundation -->
<target name="install">
 <configureapplicationserver environmentId="{worklight.environment.id}"
 contextroot="{worklight.contextroot}"
 id="{worklight.deployment.id}">
 <project warfile="{worklight.project.war.file}"/>
 <applicationserver>
 <websphereapplicationserver installldir="{appserver.was.installldir}"
 profile="{appserver.was.profile}"
 user="{appserver.was.admin.name}"
 password="{appserver.was.admin.password}">
 <cluster name="{appserver.was.nd.cluster}"/>
 </websphereapplicationserver>
 </applicationserver>
 </configureapplicationserver>
</target>
```

Installing the fix pack manually:

10. Install the data sources that point to the administration and MobileFirst runtime databases in the cluster.
  - For instructions about the administration database, see the following documentation:
    - “Configuring WebSphere Application Server for DB2 manually for MobileFirst Server administration” on page 6-58
    - “Configuring WebSphere Application Server for Oracle manually for the MobileFirst Server administration” on page 6-69
  - For instructions about the runtime database, see the following documentation:
    - “Configuring WebSphere Application Server for DB2 manually” on page 10-20
    - “Configuring WebSphere Application Server for Oracle manually” on page 10-36
11. Select a name for an environment ID that is used for all the web applications that you installed in step 12 on page 7-58.

For example, FP1.

**Note:** You must not have any other installation of IBM MobileFirst Platform Foundation for iOS in the WebSphere Application Server cell that is using the same environment ID.

12. Install the Administration Services as documented in “Configuring WebSphere Application Server for MobileFirst Server administration manually” on page 6-74, with the following change:  
In **Environment entries for Web modules** for the Administration Services, set the value of **ibm.worklight.admin.environmentid** to the environment ID that you selected in step 11 on page 7-57.
13. Install the MobileFirst runtime environment as documented in “Configuring WebSphere Application Server for MobileFirst Server administration manually” on page 6-74, with the following change:  
In **Environment entries for Web modules** for the MobileFirst runtime environment, set the value of **ibm.worklight.admin.environmentid** to the environment ID that you selected in step 11 on page 7-57.
14. Use a different name for the WebSphere applications than the one that you used in the first cluster.

## Completing the configuration of the new installation of IBM MobileFirst Platform Foundation for iOS

You must complete the configuration of the new installation of IBM MobileFirst Platform Foundation for iOS with security settings, update of the JNDI properties, and other configuration settings.

### About this task

This configuration includes the following parameters for the Administration Services application, and for the MobileFirst Operations Console application. For more information, see “Configuring MobileFirst Server” on page 6-105.

### Procedure

1. Configure the security settings that define the users for each of the following roles: `worklightadmin`, `worklightdeployer`, `worklightmonitor`, `worklightoperator`.
2. Update the JNDI properties that you modified during the installation in the **WL61FP1** cluster:
  - For the Administration Services and the MobileFirst Operations Console.
  - For each MobileFirst runtime environment.

## Verifying the new installation of IBM MobileFirst Platform Foundation for iOS

You must make sure that IBM MobileFirst Platform Foundation for iOS is installed properly.

### Procedure

1. Start all the servers in the **Worklight61FP1** cluster. This action starts all the MobileFirst runtime environments. They synchronize with the Administration Services, and download the application and adapter artifacts they need to be ready to serve requests.
2. Log to the MobileFirst Operations Console. At this stage, IBM HTTP Server must not route traffic to that installation, so you must connect directly to the host name and port of a server. If the MobileFirst Operations Console is

installed with the default context root, which is `worklightconsole`, the URL looks like the following example: `http://<hostname>:<httpPortOfServer>:/worklightconsole/`

3. Verify that the MobileFirst runtime environments are present and that they do not report any error.
4. Optional: You might also perform an additional smoke test of the adapters that are specific to your IBM MobileFirst Platform Foundation for iOS installation.

## Switching progressively the HTTP traffic to the new cluster, with session affinity

You must modify the HTTP plug-in file to route the HTTP traffic to the new installation of IBM MobileFirst Platform Foundation for iOS

### Before you begin

The following procedure requires modifications of the HTTP plug-in file, `plugin-cfg.xml`. Before you perform this procedure in production, you must test it in a test environment.

**Important:** If errors occur during these steps, it would result in incorrect traffic routing and might impact all applications in the cell of the WebSphere Application Server.

### About this task

The procedure to route the traffic is based on the following properties of the web plug-in:

- The plug-in routes traffic to a server cluster that is based on the definition of the cluster members in its `<ServerCluster>` listing. The HTTP plug-in has no other information about the target servers other than what is defined in the plug-in configuration file. Even if a collection of servers is defined in a WebSphere cell as being in two separate clusters, they can be defined in one cluster from the point of view of the plug-in. With this property, you can use the plug-in to route traffic between the clusters `cluster_WL61` and `cluster_WL61FP1`.
- The `LoadBalanceWeight` attribute of the `Server` element is used to statically assign a weighting factor that is associated with the round-robin distribution of new requests among the servers that are in a cluster. When this attribute is set to zero, this is a signal to the plug-in to stop sending new requests to that application server. Requests that are associated with existing sessions on that server continue to flow to it, but as those sessions get terminated, the server stops having any active sessions.
- The `plugin-cfg.xml` file is re-read periodically by the plug-in to the HTTP server, with a default refresh interval of 1 minute.

For more information about updating the `plugin-cfg.xml` file, see “Setting up IBM MobileFirst Platform Foundation for iOS in WebSphere Application Server cluster environment” on page 6-241.

### Procedure

1. Progressively, set the weight of a server in the `cluster_WL61` to 0.
2. Move a server of the cluster `cluster_WL61FP1` to the definition of `cluster_WL61`, with a weight of 2.
3. Wait for the server in cluster `cluster_WL61` to drain so that most of the session terminates and that it stops using CPU resources.

4. Repeat the procedure for the next server.

## Example

Before you start the procedure:

```
<ServerCluster LoadBalance="Round Robin" Name="cluster_WL61">
 <Server CloneID="a8er1kj2" LoadBalanceWeight="2" Name="ServerWL61_1">
 <Transport Hostname="test1.ibm.com" Port="9081" Protocol="http"/>
 </Server>
 <Server CloneID="a8er2kd3" LoadBalanceWeight="2" Name="ServerWL61_2">
 <Transport Hostname="test2.ibm.com" Port="9082" Protocol="http"/>
 </Server>
 <Server CloneID="a8es3as1" LoadBalanceWeight="2" Name="ServerWL61_3">
 <Transport Hostname="test3.ibm.com" Port="9083" Protocol="http"/>
 </Server>
 <PrimaryServers>
 <Server Name="ServerWL61_1"/>
 <Server Name="ServerWL61_2"/>
 <Server Name="ServerWL61_3"/>
 </PrimaryServers>
</ServerCluster>
[...]
<ServerCluster LoadBalance="Round Robin" Name="cluster_WL61FP1">
 <Server CloneID="a8sd1kj2" LoadBalanceWeight="0" Name="ServerWL61FP1_1">
 <Transport Hostname="test1.ibm.com" Port="9084" Protocol="http"/>
 </Server>
 <Server CloneID="a8as2kd3" LoadBalanceWeight="0" Name="ServerWL61FP1_2">
 <Transport Hostname="test2.ibm.com" Port="9085" Protocol="http"/>
 </Server>
 <Server CloneID="a8qa3as1" LoadBalanceWeight="0" Name="ServerWL61FP1_3">
 <Transport Hostname="test3.ibm.com" Port="9086" Protocol="http"/>
 </Server>
 <PrimaryServers>
 <Server Name="ServerWL61FP1_1"/>
 <Server Name="ServerWL61FP1_2"/>
 <Server Name="ServerWL61FP1_3"/>
 </PrimaryServers>
</ServerCluster>
[...]
<!-- Example of the UriGroups and Routes. They are not changed while you switch the traffic -->
<UriGroup Name="prod_vhost_cluster_WL61_URIs">
 <Uri AffinityCookie="JSESSIONID"
 AffinityURLIdentifier="jsessionid" Name="/worklightconsole/*"/>
 <Uri AffinityCookie="JSESSIONID"
 AffinityURLIdentifier="jsessionid" Name="/worklightadmin/*"/>
 <Uri AffinityCookie="JSESSIONID"
 AffinityURLIdentifier="jsessionid" Name="/worklight/*"/>
</UriGroup>
<Route ServerCluster="ClusterX"
 UriGroup="prod_vhost_cluster_WL61_URIs" VirtualHostGroup="default_host"/>
<UriGroup Name="test_vhost_cluster_WL61FP1_URIs">
 <Uri AffinityCookie="JSESSIONID"
 AffinityURLIdentifier="jsessionid" Name="/worklightconsole/*"/>
 <Uri AffinityCookie="JSESSIONID"
 AffinityURLIdentifier="jsessionid" Name="/worklightadmin/*"/>
 <Uri AffinityCookie="JSESSIONID"
 AffinityURLIdentifier="jsessionid" Name="/worklight/*"/>
</UriGroup>
<Route ServerCluster="ClusterY" UriGroup="test_vhost_cluster_WL61FP1_URIs"
 VirtualHostGroup="test_host"/>
```

Moving a server:

```
<ServerCluster LoadBalance="Round Robin" Name="cluster_WL61">
 <!-- Server ServerWL61_1 has a weight of 0 -->
 <Server CloneID="a8er1kj2" LoadBalanceWeight="0" Name="ServerWL61_1">
```

```

 <Transport Hostname="test1.ibm.com" Port="9081" Protocol="http"/>
 </Server>
 <Server CloneID="a8er2kd3" LoadBalanceWeight="2" Name="ServerWL61_2">
 <Transport Hostname="test2.ibm.com" Port="9082" Protocol="http"/>
 </Server>
 <Server CloneID="a8es3as1" LoadBalanceWeight="2" Name="ServerWL61_3">
 <Transport Hostname="test3.ibm.com" Port="9083" Protocol="http"/>
 <!-- Server ServerWL61F1_1 added to the cluster_WL61 in the plugin-cfg file -->
 <Server CloneID="a8sd1kj2" LoadBalanceWeight="2" Name="ServerWL61FP1_1">
 <Transport Hostname="test1.ibm.com" Port="9084" Protocol="http"/>
 </Server>
 <PrimaryServers>
 <Server Name="ServerWL61_1"/>
 <Server Name="ServerWL61_2"/>
 <Server Name="ServerWL61_3"/>
 <Server Name="ServerWL61FP1_1"/>
 </PrimaryServers>
</ServerCluster>
[...]
<ServerCluster LoadBalance="Round Robin" Name="cluster_WL61FP1">
 <Server CloneID="a8as2kd3" LoadBalanceWeight="0" Name="ServerWL61FP1_2">
 <Transport Hostname="test2.ibm.com" Port="9085" Protocol="http"/>
 </Server>
 <Server CloneID="a8qa3as1" LoadBalanceWeight="0" Name="ServerWL61FP1_3">
 <Transport Hostname="test3.ibm.com" Port="9086" Protocol="http"/>
 </Server>
 <PrimaryServers>
 <Server Name="ServerWL61FP1_2"/>
 <Server Name="ServerWL61FP1_3"/>
 </PrimaryServers>
</ServerCluster>

```

End of the transition:

```

<ServerCluster LoadBalance="Round Robin" Name="cluster_WL61">
 <!-- Server ServerWL61_X have a weight of 0 -->
 <Server CloneID="a8er1kj2" LoadBalanceWeight="0" Name="ServerWL61_1">
 <Transport Hostname="test1.ibm.com" Port="9081" Protocol="http"/>
 </Server>
 <Server CloneID="a8er2kd3" LoadBalanceWeight="0" Name="ServerWL61_2">
 <Transport Hostname="test2.ibm.com" Port="9082" Protocol="http"/>
 </Server>
 <Server CloneID="a8es3as1" LoadBalanceWeight="0" Name="ServerWL61_3">
 <Transport Hostname="test3.ibm.com" Port="9083" Protocol="http"/>
 <!-- Server ServerWL61F1_X added to the cluster_WL61 in the plugin-cfg file -->
 <Server CloneID="a8sd1kj2" LoadBalanceWeight="2" Name="ServerWL61FP1_1">
 <Transport Hostname="test1.ibm.com" Port="9084" Protocol="http"/>
 </Server>
 <Server CloneID="a8as2kd3" LoadBalanceWeight="2" Name="ServerWL61FP1_2">
 <Transport Hostname="test2.ibm.com" Port="9085" Protocol="http"/>
 </Server>
 <Server CloneID="a8qa3as1" LoadBalanceWeight="2" Name="ServerWL61FP1_3">
 <Transport Hostname="test3.ibm.com" Port="9086" Protocol="http"/>
 </Server>
 <PrimaryServers>
 <Server Name="ServerWL61_1"/>
 <Server Name="ServerWL61_2"/>
 <Server Name="ServerWL61_3"/>
 <Server Name="ServerWL61FP1_1"/>
 <Server Name="ServerWL61FP1_2"/>
 <Server Name="ServerWL61FP1_3"/>
 </PrimaryServers>
</ServerCluster>
[...]

```

```
<ServerCluster LoadBalance="Round Robin" Name="cluster_WL61FP1">
 <PrimaryServers>
 </PrimaryServers>
</ServerCluster>
```

## Performing a rollback procedure

You might want to perform a rollback procedure to restore your initial configuration if a problem occurs.

### Procedure

If a problem is detected while you are switching the traffic, you must restore the `plugin-cfg.xml` to its initial state so that the HTTP traffic is routed again to the initial installation of IBM MobileFirst Platform Foundation for iOS.

## Uninstalling IBM MobileFirst Platform Foundation for iOS from the old cluster

You must uninstall IBM MobileFirst Platform Foundation for iOS from the cluster that it was previously installed in, and update the appropriate settings accordingly.

### Procedure

1. When the migration is complete and the sessions are stopped, shutdown the `cluster_WL61` cluster.
2. You can allow management operations to start again and notify users with privilege `worklightadmin` or `worklightdeployer` that they are allowed to deploy MobileFirst artifacts because the upgrade procedure is complete.
3. Uninstall IBM MobileFirst Platform Foundation for iOS from the cluster `cluster_WL61`.
4. Update the `plugin-cfg.xml` so that it no longer references the old cluster `cluster_WL61`.
5. Verify that the HTTP traffic is routed correctly to the new cluster. For example, you can activate the log file of the web plug-in, and review the log.

---

## Applying a fix pack to the MobileFirst Data Proxy

Follow these steps to upgrade the MobileFirst Data Proxy and the Trust Association Interceptor (TAI).

### Before you begin

You must run IBM Installation Manager to upgrade the installation directory of IBM MobileFirst Platform Foundation for iOS. For more information, see “Running IBM Installation Manager and completing the Application Center upgrade” on page 7-25.

The following procedure installs the upgraded versions of the MobileFirst Data Proxy WAR file and the TAI (Trust Association Interceptor) on your disk.

**Note:** If you installed Application Center, you might want to upgrade or apply a fix pack only to the MobileFirst Data Proxy, and not to the Application Center. To do this, you can run IBM Installation Manager to install IBM MobileFirst Platform Foundation for iOS in a different location, without installing Application Center:

- For a graphic installation, in the window **Configuration Choice**, select **No** to the question **Install the IBM MobileFirst Platform Application Center**.



- For a command-line installation, use the silent installation file that is named `install-no-appcenter.xml`, which is described in “Working with sample response files for IBM Installation Manager” on page 6-32.

## About this task

If you installed the MobileFirst Data Proxy with Ant tasks, follow the steps 1 to 6.

If you installed the MobileFirst Data Proxy manually, follow the steps 7 to 11.

## Procedure

For an installation with Ant tasks:

1. Locate the Ant file that you used to perform the installation.
2. Verify that the **taskdef** for the `worklight-ant-deployer.jar` uses the correct directory, which contains the upgraded installation of MobileFirst Server V7.0.0.

Review the following example. You must check the value of the property `worklight.server.install.dir`, because this property is used to define the directory of the `worklight-ant-deployer.jar` file in the **taskdef** tag:

```
<taskdef resource="com/worklight/ant/defaults.properties">
 <classpath>
 <fileset dir="{worklight.server.install.dir}/WorklightServer">
 <include name="worklight-ant-deployer.jar"/>
 </fileset>
 </classpath>
</taskdef>
```

**Important:** This verification step must not be overlooked because it defines the version of IBM MobileFirst Platform Foundation for iOS that you use to deploy the WAR file and update the TAI.

3. Stop your application server.
4. Run the following command:
 

```
product_install_dir/shortcuts/ant -f <your file> update
```

 This command has the following effects:
  - It updates the WAR file of the MobileFirst Data Proxy web app.
  - On WebSphere Application Server Liberty profile, and WebSphere Application Server stand-alone server, it updates the TAI.
5. On WebSphere Application Server Network Deployment, replace the TAI JAR file by the new JAR file, which is in `product_install_dir/WorklightServer/external-server-libraries`, on all nodes of your WebSphere Application Server cell.

For more information, see the instructions to install the MobileFirst Data Proxy manually.

6. Restart the application server.

For a manual installation:

7. Replace the MobileFirst Data Proxy WAR file in your application server. You find the WAR file in `product_install_dir/Datastore/imf-data-proxy.war`.
8. Stop the application server.
9. Replace the TAI JAR file in your application server. You find the JAR file in `product_install_dir/WorklightServer/external-server-libraries/com.ibm.worklight.oauth.tai_*.jar`.

10. On WebSphere Application Server Liberty profile, replace the TAI feature manifest in your application server.  
You find the manifest in *product\_install\_dir/WorklightServer/external-server-libraries/OAuthTai-1.0.mf*.
11. Restart the application server.

---

## Developing MobileFirst applications

You use IBM MobileFirst Platform Command Line Interface for iOS, the MobileFirst client, and the server-side API to develop iOS applications.

This information is designed to help users develop applications for various channels by using IBM MobileFirst Platform Foundation for iOS. It is intended for developers who are familiar with iOS application development.

This section covers client-side development and server-side development topics, such as the integration with back-end services, and push notifications.

### Development framework features

IBM MobileFirst Platform Foundation for iOS provides a framework that enables the development, optimization, integration, and management of secure apps. This framework provides the following features:

- Guidelines and design patterns that promote compatibility across multiple consumer environments.
- Automatic packaging and provisioning of application resources to multiple consumer environments.
- A flexible UI optimization and globalization scheme.
- Tools that provide uniform access to back-end enterprise data, processes, and transactions.
- Uniform persistence.
- A uniform personalization model.
- A flexible authentication model and automatic application protection from web attacks.

---

## Artifacts produced during development cycle

When you use IBM MobileFirst Platform Foundation for iOS to develop a mobile application, you produce client and server artifacts.

### Client artifacts

A mobile binary file ready for deployment on a mobile device. For example, an iPhone .ipa file. This is usually uploaded to an “App Store” such as the Apple Store.

### Application metadata and resources (.wlap)

A .wlap file. Metadata and web resources of a MobileFirst application deployed on the MobileFirst Server. Used by the MobileFirst Server to identify and service mobile applications.

### Adapter files (.adapter)

An adapter file (.adapter) contains server-side code written by the MobileFirst developer (for example, retrieve data from a remote database). Adapter code is accessed by MobileFirst applications via a simple invocation API.

.wlap and .adapter files are referred to in this topic as *content*. These are typically identical between the organization’s development, testing, and production environments.

### **A project web archive (WAR) file to be deployed on your application server**

This file contains the default server-specific configurations such as security profiles, server properties, and more. `.wlap` and `.adapter` files use these properties at various stages. Typically, the project WAR file is adapted to the test and production environment, when you deploy the file to your application server. For more information, see “Deploying the project WAR file” on page 10-5.

## **MobileFirst projects**

With MobileFirst Platform Command Line Interface for iOS (CLI), you can develop mobile applications within projects, build your applications, and create skins for specific devices.

### **MobileFirst projects**

To develop your mobile applications with IBM MobileFirst Platform Foundation for iOS, you must first create a project using CLI.

In your project, when you create an application, you have a main application folder, in which you can find several subfolders and files:

- One folder for the iOS environment in the application, and where you store the Objective-C code that is specific to this environment.
- A `legal` folder, for you to store all the license-related documents.
- An `application-descriptor.xml` file that contains the application metadata.
- A `build-settings.xml` file, for you to prepare minification and concatenation configurations for each environment.

## **Integrating with source control systems**

Some source code files should be held in a version control system: others should not.

There are two types of files and folders in a standard MobileFirst project hierarchy:

- Your own source code files and some source code files that are provided in the MobileFirst device runtime libraries.

You should commit these files to a version control system.

- Files that are generated from your web source code and some JavaScript files that are provided with IBM MobileFirst Platform Foundation for iOS (such as `wlclient.js`).

These files and folders are added to the file system every build.

You should not commit them to a version control system.

In the next figure, these files and folders are marked with a star (\*) after their names.

```

Project Name
+---Java Resources
+---JavaScript Resources
+---adapters
+---apps
+---Application Name
| application-descriptor.xml
| build-settings.xml
|
+---android
+---css
+---images
+---js
+---native
| Application Name.iml
| AndroidManifest.xml
| project.properties
|
+---assets
| | wiclient.properties
| |
| +---featurelibs
| +---www (*)
| +---libs
| +---res
| +---src
+---nativeResources
|
+---blackberry
+---css
+---images
+---js
+---native
| config.xml
| icon.png
| splash.png
| wldata
|
+---src
| WLExtension.jar
|
+---www (*)
|
+---blackBerry10
+---css
+---images
+---js
+---nativeResources
|
+---www (*)
|
+---common
| index.html
|
+---css
+---images
+---js
|
+---ipad
+---css
+---images
+---js
+---native
| buildtime.sh
| config.xml
| Entitlements-Debug.plist
| Entitlements-Release.plist
| main.m
| Project Name Application NameIpad_Prefix.pch
| Project Name Application NameIpad-Info.plist
| README.txt
| worklight.plist
|
+---Classes
| Application Name.h
| Application Name.m
|
+---CordovaLib (*)
+---FipsNtcp
+---Frameworks
+---Project Name Application NameIpad.xcodeproj
+---Resources
+---Settings.bundle
+---TeaLeaf
+---WorklightSDK (*)
+---www (*)
+---nativeResources
|
+---iphone
+---css
+---images
+---js
+---native
| buildtime.sh
| config.xml
| Entitlements-Debug.plist
| Entitlements-Release.plist
| main.m
| Project Name Application NameIphone_Prefix.pch
| Project Name Application NameIphone-Info.plist
| README.txt
| worklight.plist
|
+---Classes
| Application Name.h
| Application Name.m
|
+---CordovaLib (*)
+---FipsNtcp
+---Frameworks
+---Project Name Application NameIphone.xcodeproj
+---Resources
+---Settings.bundle
+---TeaLeaf
+---WorklightSDK (*)
+---www (*)
+---nativeResources
|
+---legal
|
+---windowsphone8
+---css
+---images
+---js
+---native
| Application Name.csproj
| App.xaml
| App.xaml.cs
| ApplicationIcon.png
| Background.png
| config.xml
| MainPage.xaml
| MainPage.xaml.cs
| Newtonsoft.Json.dll
| SplashScreenImage.jpg
| Wiclient.properties
| WMPNativeLib.dll
| WPCordovaClassLib.dll
|
+---applicationBar
+---buildtarget
+---Properties
+---Resources
+---www (*)
+---nativeResources
|
+---bin (*)
+---externalServerLibraries
+---server
| +---conf
| +---java
| +---lib
+---services

```

```

Project Name
|
+---Java Resources
+---JavaScript Resources
+---adapters
+---apps
+---Application Name
| application-descriptor.xml
| build-settings.xml
|
+---ipad
| +---css
| +---images
| +---js
| +---native
| | buildtime.sh
| | config.xml
| | Entitlements-Debug.plist
| | Entitlements-Release.plist

```

**Note:** In iOS environments, the Frameworks folder contains a default `.framework` file, `sqlcipher.framework`, that is automatically generated by the MobileFirst builder if it is not already in the Frameworks folder. The Frameworks folder should be committed to your source control system, but the `sqlcipher.framework` file can be ignored.

To ensure that your source code is always synchronized with your source control system, add the (\*) files and folders to the ignore list in your source control system. For Subversion, for example, perform the following steps:

- **Step 1:** Using the Tortoise extension for Subversion, right-click each file or folder that is to be ignored and add it to the ignore list.
- **Step 2:** Go up one level in the file system and commit the change to the SVN repository. The changes take effect from now on for every developer who updates the code.

---

## Developing applications for iOS

Whatever the environment, the process for developing iOS applications shares some common elements: an iOS API application, an application descriptor, and a client property file.

### Developing native applications for iOS

After you have created the native API application in IBM MobileFirst Platform Command Line Interface for iOS and added the second project from Xcode IDE, you edit the application descriptor and client property files, and then copy the files to the appropriate project. If you want to work with Apple Swift language, you create a Swift project.

**Note:** The **Keychain Sharing** capability is mandatory while running iOS apps in the iOS Simulator when using Xcode 8. You need to enable this capability manually before building the Xcode project.

#### Application descriptor of iOS applications

In the application descriptor, you define various aspects of your native iOS application.

The application descriptor file is a metadata file in which you define various aspects of the application. It is in the application root directory and its name is `application-descriptor.xml`.

The following example shows the format of the application descriptor file of native API applications for iOS:

```
<?xml version="1.0" encoding="UTF-8"?>
<nativeIOSApp
 id="ios"
 platformVersion="7.0.0"
 version="1.0"
 securityTest="security test name"
 bundleId="com.ios"
 applicationId="ios"
 xmlns="http://www.worklight.com/native-ios-descriptor">
 <displayName>application display name</displayName>
 <description>application description</description>
 <accessTokenExpiration>3600</accessTokenExpiration>
```

```

 <userIdentityRealms>Realm1, Realm2</userIdentityRealms>
 <pushSender password="{push.apns.senderpassword}"/>
</nativeIOSApp>

```

The content of the application descriptor file is as follows.

```

<?xml version="1.0" encoding="UTF-8"?>
<nativeIOSApp
 id="ios"
 platformVersion="6.0.0"
 version="1.0"
 securityTest="security test name"
 bundleId="com.ios"
 applicationId="ios"
 xmlns="http://www.worklight.com/native-ios-descriptor">

```

The `<nativeIOSApp>` element is the root element of the descriptor. It takes three mandatory attributes and two optional attributes:

**id** This attribute specifies the ID of the application. The ID must be identical to the application folder name. It must be an alphanumeric string that starts with a letter. It can contain underscore ("\_") characters. It must not be a reserved word in JavaScript.

**platformVersion**

Contains the version of IBM MobileFirst Platform Foundation for iOS on which the app was developed.

**version**

This attribute specifies the version of the application. This version is a string of the form x.y, where x and y are numbers. It is visible to users who download the app from the app store or market.

**securityTest**

This optional attribute specifies a security configuration that is defined in the `authenticationConfig.xml` file. When a client attempts to access a protected resource, IBM MobileFirst Platform Foundation for iOS checks whether the client is already authenticated according to the security test. If the client is not yet authenticated, IBM MobileFirst Platform Foundation for iOS starts the process to obtain the client credentials and to verify them.

**bundleId**

This optional attribute specifies the bundle ID of the application.

**applicationId**

This attribute specifies the name of the application, as specified in the `worklight.plist` file. The values in the `application-descriptor.xml` and `worklight.plist` must match, and the value of **applicationId** must be the same as the value of **id**. This attribute is required if you use the IBM MobileFirst Platform Foundation for iOS classic security model. For more information, see "MobileFirst application authenticity overview" on page 8-247.

**<displayName>**

This element contains the application name. This name is visible in the MobileFirst Operations Console and is copied to the descriptor files of various web and desktop environments.

```

 <displayName>application display name</displayName>

```

**<description>**

This element contains the application description. This description is visible in the MobileFirst Operations Console and is copied to the descriptor files of various web and desktop environments.

<description>application description</description>

#### <userIdentityRealms>

This element is a comma-separated ordered list of user identity realms for OAuth authentication. The realms should be ordered by preference. The first successfully authenticated realm in this list is selected as the user identity realm. If the list is empty, or no realm in the list was authenticated, the ID token contains no identity information. This element is optional and the default value is an empty list:

<userIdentityRealms>WASLTPRealm, CustomAuthenticatorRealm</userIdentityRealms>

**Note:** This attribute is used to set user identity in the OAuth-based flows. For the classic (pre-V7.0.0) authentication flows, see the documentation for the customSecurityTest security test.

#### <accessTokenExpiration>

This element is optional and defines the expiration period (in seconds) of OAuth access tokens. The default is 3600 seconds (one hour). Client applications can use the token to access protected resources as long as the token has not expired. When the token expires, the client application has to obtain a new access token to access a protected resource. Obtaining a new access token may happen automatically without user intervention if all the realms by which the resource is protected have not expired. However, if one of the realms that is included in the security test of the resource has expired, and the realm requires user input (such as a form-based authenticator), the user has to re-authenticate.

<accessTokenExpiration>3600</accessTokenExpiration>

#### <pushSender>

This element defines the password to the SSL certificate that encrypts the communication link with the Apple Push Notification Service (APNS).

<pushSender password="{push.apns.senderpassword}"/>

#### </nativeIOSApp>

This tag closes the content of the application descriptor file.

</nativeIOSApp>

## Client property file for iOS

This file defines the client-side properties so that your native app uses the MobileFirst native API for iOS.

The `worklight.plist` client property file contains the necessary information for initializing `WLClient` instances. Before you use this file in your native application for iOS, you must define the properties as specified in the following table.

Table 8-1. Properties of the `worklight.plist` file

Property	Description	Example values
<b>protocol</b>	The communication protocol with MobileFirst Server.	http or https
<b>host</b>	The host name of MobileFirst Server.	localhost
<b>port</b>	The port of MobileFirst Server. If this value is left blank, the default port is used. If the <b>protocol</b> property value is https, you must leave this value blank.	10080



Table 8-1. Properties of the *worklight.plist* file (continued)

Property	Description	Example values
<b>wlServerContext</b>	The server URL context.	/ <b>Note:</b> If you use IBM MobileFirst Platform Foundation Developer Edition, you must set the value of this property to the name of your MobileFirst project.
<b>application id</b>	The application ID, as defined in the <i>application-descriptor.xml</i> file.	myApp
<b>application version</b>	The application version, as defined in the <i>application-descriptor.xml</i> file.	1.0
<b>environment</b>	This property defines the MobileFirst environment. The value of this property must be <code>iOSnative</code> . <b>Important:</b> You must not modify the value of this property value.	<code>iOSnative</code>
<b>languagePreferences</b>	This property defines a comma-separated list of preferred languages to be used by IBM MobileFirst Platform Foundation for iOS to display system messages. This property is optional.	en, fr, de, es
<b>platformVersion</b>	This property defines the version number of the IBM MobileFirst Platform Foundation for iOS.	6.3.0.00.20140813-0730
<b>wlUId</b>	This property is for internal usage. You must not modify the value.	wY/mbnwKTDDYQUvuQCdSgg==

## Copying files of iOS applications

To use the MobileFirst native API for iOS in your native application, you must copy the library and the client property file of your native API application into the project of your native app for iOS.

### Before you begin

#### About this task

Make sure the MobileFirst project files are accessible from your native iOS project in the Xcode development environment. Then, by using Xcode, you specify what frameworks, libraries, and build settings to include.

## Procedure

Setting up the Xcode project to include the MobileFirst API.

1. In your Xcode project add the MobileFirst files to your project:
  - a. Select the project root icon in the project explorer.
  - b. From the **File** menu choose the **AddFiles** option and add the WorklightAPI folder and the worklight.plist file from your MobileFirst project.
  - c. Select **Copy items if needed** and **Create groups for any added folders** options.
  - d. Click **Add**.

**Note:** These steps add the MobileFirst frameworks to the **Link Binary with Libraries** list in the **Build Phases** tab.

2. In the **Build Phases** tab, make sure these frameworks and libraries have been linked to your project in the **Link Binary with Libraries** list.
  - SystemConfiguration.framework
  - MobileCoreServices.framework
  - CoreData.framework
  - CoreLocation.framework
  - Security.framework
  - sqlcipher.framework

**Note:** Some items may already be linked.

- libstdc++.6.dylib
- libz.dylib

**Important:** If you are using Xcode 7, link libstdc++.6.tbd, and libz.tbd instead of the corresponding .dylib files. Using Xcode 7 requires the latest interim fix.

3. Optional: If the MobileFirst frameworks do not appear in the **Build Phases** tab:
  - a. Open the **Build Settings** page.
  - b. Find the **Search Paths** section.
  - c. Add the following entry to the **Framework Search Paths**:  
\$(PROJECT\_DIR)/WorklightAPI/Frameworks. If you did not copy the folder into the Xcode project, enter the full path of the WorklightAPI folder.
4. In the **Other Linker Flags** field, enter the following value: -ObjC
5. In the **Deployment** section, select a value for the **iOS Deployment Target** field that is greater than or equal to 6.0.
6. Optional: Set the build options.

**Important:** If you are using Xcode 7, in the **Build Settings** tab:

- a. Open the **Build Options** section.
- b. Set **Enable Bitcode** to No.

For more information, see “Disabling bitcode in Xcode builds” on page 8-14.

## Creating a Swift project

Because Apple Swift is compatible with Objective-C, you can use the MobileFirst API from within an iOS Swift project.

## Procedure

1. Create a Swift project and install the native API into an iOS native application.
2. After you follow the steps for an iOS application, select **Build Settings > Swift Compiler - Code Generation**.
3. In Objective-C Bridging Header, add this file: `$SRCROOT/WorklightAPI/include/WLSwiftBridgingHeader.h`.

If you already have your own Bridging Header for other purposes, include the MobileFirst Bridging Header inside your own Bridging Header instead.

## Results

All the MobileFirst classes are now available from any of your Swift files. The XCode IDE provides code autocompletion, converted to the Swift style.

## What to do next

A tutorial is available on the Getting Started page.

## Using Logger in Swift Projects

In order to use OCLogger in Swift projects, you can configure your Swift application by following the steps described in this section.

## Procedure

1. Create a native MobileFirst application for iOS that uses Swift. For more information, see “Developing native applications for iOS” on page 8-4.
2. In the Xcode IDE, create a Swift file and name it `OCLoggerSwiftExtension.swift`.

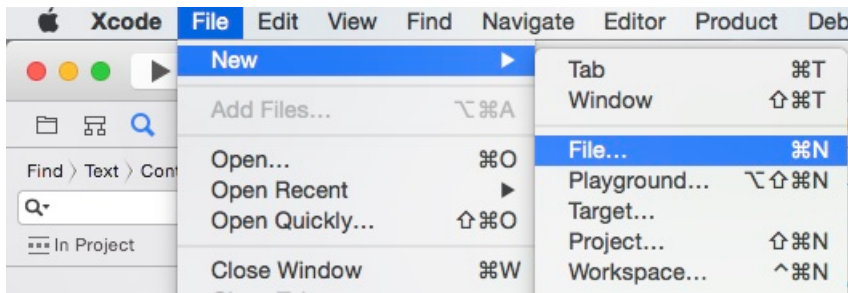

Figure 8-2. New Xcode File

This screen capture shows File > New > File menu that you use to create a file.

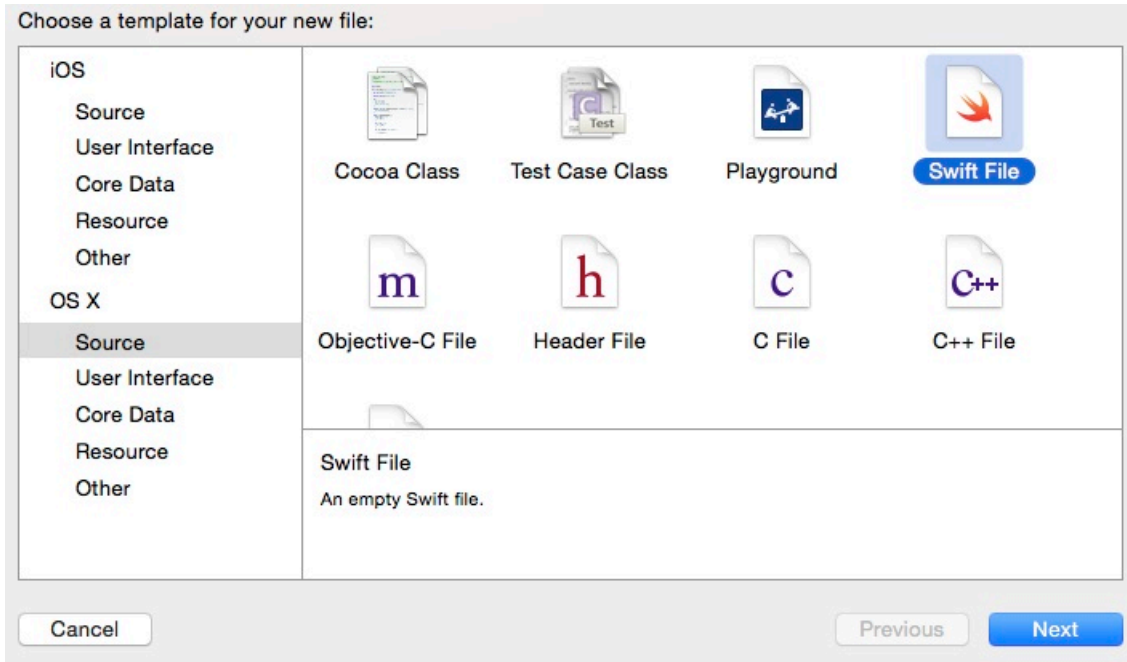

Figure 8-3. Swift File Type

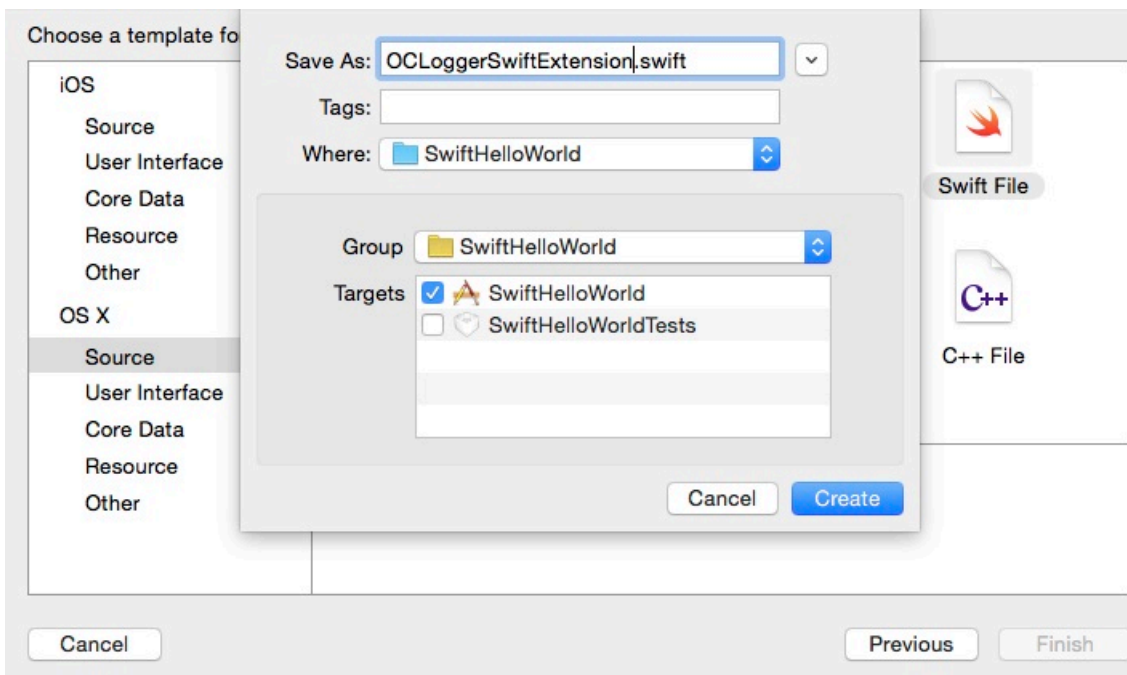

Figure 8-4. Name a Swift File

3. Add the following code to the file:

```
import Foundation

extension OCLogger {
 //Log methods with no metadata

 func logTraceWithMessages(message:String, _ args: CVarArgType...) {
 logWithLevel(OCLogger_TRACE, message: message, args:getValist(args), userInfo:Dictionary<String, String>())
 }
}
```

```

}

func logDebugWithMessages(message:String, _ args: CVarArgType...) {
 logWithLevel(OCLogger_DEBUG, message: message, args:getVaList(args), userInfo:Dictionary<String, String>())
}

func logInfoWithMessages(message:String, _ args: CVarArgType...) {
 logWithLevel(OCLogger_INFO, message: message, args:getVaList(args), userInfo:Dictionary<String, String>())
}

func logWarnWithMessages(message:String, _ args: CVarArgType...) {
 logWithLevel(OCLogger_WARN, message: message, args:getVaList(args), userInfo:Dictionary<String, String>())
}

func logErrorWithMessages(message:String, _ args: CVarArgType...) {
 logWithLevel(OCLogger_ERROR, message: message, args:getVaList(args), userInfo:Dictionary<String, String>())
}

func logFatalWithMessages(message:String, _ args: CVarArgType...) {
 logWithLevel(OCLogger_FATAL, message: message, args:getVaList(args), userInfo:Dictionary<String, String>())
}

func logAnalyticsWithMessages(message:String, _ args: CVarArgType...) {
 logWithLevel(OCLogger_ANALYTICS, message: message, args:getVaList(args), userInfo:Dictionary<String, String>())
}

//Log methods with metadata

func logTraceWithUserInfo(userInfo:Dictionary<String, String>, message:String, _ args: CVarArgType...) {
 logWithLevel(OCLogger_TRACE, message: message, args:getVaList(args), userInfo:userInfo)
}

func logDebugWithUserInfo(userInfo:Dictionary<String, String>, message:String, _ args: CVarArgType...) {
 logWithLevel(OCLogger_DEBUG, message: message, args:getVaList(args), userInfo:userInfo)
}

func logInfoWithUserInfo(userInfo:Dictionary<String, String>, message:String, _ args: CVarArgType...) {
 logWithLevel(OCLogger_INFO, message: message, args:getVaList(args), userInfo:userInfo)
}

func logWarnWithUserInfo(userInfo:Dictionary<String, String>, message:String, _ args: CVarArgType...) {
 logWithLevel(OCLogger_WARN, message: message, args:getVaList(args), userInfo:userInfo)
}

func logErrorWithUserInfo(userInfo:Dictionary<String, String>, message:String, _ args: CVarArgType...) {
 logWithLevel(OCLogger_ERROR, message: message, args:getVaList(args), userInfo:userInfo)
}

func logFatalWithUserInfo(userInfo:Dictionary<String, String>, message:String, _ args: CVarArgType...) {
 logWithLevel(OCLogger_FATAL, message: message, args:getVaList(args), userInfo:userInfo)
}

func logAnalyticsWithUserInfo(userInfo:Dictionary<String, String>, message:String, _ args: CVarArgType...) {
 logWithLevel(OCLogger_ANALYTICS, message: message, args:getVaList(args), userInfo:userInfo)
}
}

//Alternatives for macros

private func _metadataDictionary(file:String, fn:String, line:Int) -> Dictionary<String, String> {
return [
 "$method" : fn,
 "$file" : file.lastPathComponent,
 "$line" : String(line),
 "$src": "swift"
];
}

```

```

public func OCLoggerTrace(message:String, package:String =
"IMF", file: String = __FILE__, fn: String = __FUNCTION__, line: Int = __LINE__, #args: CVarArgType...) {
 OCLogger.getInstanceWithPackage(package).logWithLevel(OCLogger_TRACE, message: message, args:getVaList(args),
userInfo: _metadataDictionary(file, fn, line));
}

public func OCLoggerDebug(message:String, package:String =
"IMF", file: String = __FILE__, fn: String = __FUNCTION__, line: Int = __LINE__, #args: CVarArgType...) {
 OCLogger.getInstanceWithPackage(package).logWithLevel(OCLogger_DEBUG, message: message, args:getVaList(args),
userInfo: _metadataDictionary(file, fn, line));
}

public func OCLoggerInfo(message:String, package:String =
"IMF", file: String = __FILE__, fn: String = __FUNCTION__, line: Int = __LINE__, #args: CVarArgType...) {
 OCLogger.getInstanceWithPackage(package).logWithLevel(OCLogger_INFO, message: message, args:getVaList(args),
userInfo: _metadataDictionary(file, fn, line));
}

public func OCLoggerWarn(message:String, package:String =
"IMF", file: String = __FILE__, fn: String = __FUNCTION__, line: Int = __LINE__, #args: CVarArgType...) {
 OCLogger.getInstanceWithPackage(package).logWithLevel(OCLogger_WARN, message: message, args:getVaList(args),
userInfo: _metadataDictionary(file, fn, line));
}

public func OCLoggerError(message:String, package:String =
"IMF", file: String = __FILE__, fn: String = __FUNCTION__, line: Int = __LINE__, #args: CVarArgType...) {
 OCLogger.getInstanceWithPackage(package).logWithLevel(OCLogger_ERROR, message: message, args:getVaList(args),
userInfo: _metadataDictionary(file, fn, line));
}

public func OCLoggerFatal(message:String, package:String =
"IMF", file: String = __FILE__, fn: String = __FUNCTION__, line: Int = __LINE__, #args: CVarArgType...) {
 OCLogger.getInstanceWithPackage(package).logWithLevel(OCLogger_FATAL, message: message, args:getVaList(args),
userInfo: _metadataDictionary(file, fn, line));
}

public func OCLoggerAnalytics(message:String, package:String =
"IMF", file: String = __FILE__, fn: String = __FUNCTION__, line: Int = __LINE__, #args: CVarArgType...) {
 OCLogger.getInstanceWithPackage(package).logWithLevel(OCLogger_ANALYTICS, message: message, args:getVaList(args),
userInfo: _metadataDictionary(file, fn, line));
}

```

4. Test that the Swift extension is working by using the Logger in Swift with the following code:

```

OCLogger.setLevel(OCLogger_TRACE)
OCLogger.setCapture(true);

let logger : OCLogger = OCLogger.getInstanceWithPackage("MyTestLoggerPackage")

logger.logTraceWithMessages("Hello %@", "Trace");
logger.logTraceWithMessages("Hello Trace");

OCLoggerDebug("Hello Debug!");
OCLoggerDebug("Hello %@", package: "SomePackageName", args: "Debug!");

```

## Results

Verify the output is similar to the following output:

```

SwiftHelloWorld[7591:4265124] [TRACE] [MyTestLoggerPackage] Hello Trace
SwiftHelloWorld[7591:4265124] [TRACE] [MyTestLoggerPackage] Hello Trace
SwiftHelloWorld[7591:4265124] [DEBUG] [IMF] viewDidLoad() in ViewController.swift:26 :: Hello Debug!
SwiftHelloWorld[7591:4265124] [DEBUG] [SomePackageName] viewDidLoad() in ViewController.swift:27 :: Hello Debug!

```

**Note:** The project name used in this example is SwiftHelloWorld. Your project name will show in the output in place of SwiftHelloWorld. The code was added to the viewDidLoad() function in the ViewController.swift file. Your output depends on where you added the code in your project. The timestamps were removed from this example for clarity.

## Enforcing TLS-secure connections in iOS apps

For development purposes, hybrid iOS projects that are created in IBM MobileFirst Platform Studio or by using CLI bypass the iOS 9 requirement to enforce Transport Layer Security (TLS) protocol version 1.2 in all apps.

### About this task

Apple's App Transport Security (ATS) is a new feature of iOS 9 that enforces best practices for connections between the app and the server. By default, this feature enforces some connection requirements that improve security. These include client-side HTTPS requests and server-side certificates and connection ciphers that conform to Transport Layer Security (TLS) version 1.2 using forward secrecy.

For **development purposes**, you can override the default behavior by specifying an exception in the Info.plist file in your app, as described in App Transport Security Technote. However, in a full **production environment**, all iOS apps must enforce TLS-secure connections for them to work properly.

The latest interim fix of IBM MobileFirst Platform Foundation for iOS V7.0.0/IBM MobileFirst Platform Foundation for iOS V6.0.0 and later (required for iOS 9 and Xcode 7) automatically turn off transport security for hybrid apps to allow all non-secure connections to the MobileFirst Development Server.

To enable non-TLS connections, the following exception must appear in the `<projectname>info.plist` file in the `<project>\Resources` folder:

```
<key>NSExceptionDomains</key>
<dict>
 <key>yourserver.com</key>
 <dict>
 <!--Include to allow subdomains-->
 <key>NSIncludesSubdomains</key>
 <true/>

 <!--Include to allow insecure HTTP requests-->
 <key>NSTemporaryExceptionAllowsInsecureHTTPLoads</key>
 <true/>
 </dict>
</dict>
```

**Note:** If you are creating a **hybrid** iOS application, your IBM MobileFirst Platform Server host name is added automatically to the NSException dictionary. If you are creating a **native** iOS application, however, you must manually add the IBM MobileFirst Platform Server host name to the NSException dictionary.

### Procedure

1. To prepare for production, remove or comment out the code that appears earlier in this page.
2. Set up the client to send HTTPS requests by using the following entry to the dictionary:

```
<key>protocol</key>
<string>https</string>
```

```
<key>port</key>
<string>10443</string>
```

The SSL port number is defined on the server in `server.xml` in the `httpEndpoint` definition.

3. Configure a server that is enabled for the TLS 1.2 protocol. For more information, see *Configuring MobileFirst Server to enable TLS V1.2*.
4. Make settings for ciphers and certificates, as they apply to your setup. For more information, see *App Transport Security Technote, Secure communications using Secure Sockets Layer (SSL) for WebSphere Application Server Network Deployment, and Enabling SSL communication for the Liberty profile*.

### Disabling bitcode in Xcode builds

You must disable the new bitcode option in Xcode builds for IBM MobileFirst Platform Foundation for iOS projects.

#### About this task

Starting with Xcode 7, bitcode is a default, but optional option for iOS apps. The bitcode option is not currently supported in IBM MobileFirst Platform Foundation for iOS. To use the MobileFirst SDK in your Xcode projects, you must disable bitcode. The latest MobileFirst interim fix is required to work with Xcode 7 and iOS9.

**Note:** Applications that are based on Apple watchOS 2 require the bitcode to be enabled and are currently not supported in IBM MobileFirst Platform Foundation for iOS.

#### Procedure

On the **Xcode Build Settings** tab, in the **Build Options** group, set **Enable Bitcode** to **No**.

---

## Updating mobile apps with IBM MobileFirst Platform Foundation for iOS and the Application Center

You can choose among different ways to update a mobile application depending on the context.

When you build applications for internal use in your organization and that are not to be delivered through public app stores such as the Apple App Store, you could use the Application Center to deliver these applications over the air. There are several scenarios that you might want to consider.

### Delivering a new version of native code

The main reason that you would want to deliver a new version of an application is probably because your application uses native code and you want to provide new features or deliver fixes that require changes in the native code. You might also need to provide a new native version of the application, even if your MobileFirst application is completely written by using web technologies, to accommodate new mobile operating systems supported only in later versions of IBM MobileFirst Platform Foundation for iOS. You cannot use the direct update mechanism in either of these cases. You must build and deploy a new version of the application.



You can provide the update through the Application Center.

Start by uploading the new application binary (IPA) to the Application Center console. The application is listed as a new available version of the application. For the Application Center to consider the application as a new version of an existing application, you must keep the application identification unchanged; for example, it must have the same bundle ID for iOS. You change the internal version of the application; for example, **CFBundleVersion** on iOS. For more information about application properties in the Application Center console, see “Application properties” on page 11-83.

If you configured the Application Center to send push notifications for updates, users would receive a notification as soon as the new version is deployed. The content of this message enables the user to open the Application Center mobile client on the update page of the mobile application, so that he or she can trigger an over-the-air installation.

When you disable the previous version, you must provide the URL of the latest application version, so that users have an easy way to fetch the new version.

In the Application Center, if you want to direct users of the mobile application to the update page of the mobile client, you can use a custom URL of the format:

```
ibmappctr://show-app? Package-name
```

Where *Package-name* is the package name of the application that you have updated to a new version.

The exact URL is listed in the “Application properties” page of the Application Center console. For more information, see “Application properties” on page 11-83.

When a user launches a disabled application version, the user is directed to get the update on the main page of the application in the Application Center mobile client. An Update button gives access to over-the-air update of the application.

## Updating the Application Center application

Since IBM Worklight Foundation V6.2.0, when a new version of the Application Center becomes available, users do not have to uninstall the mobile application before downloading and installing the new version on their mobile devices. For example, when a new version of the Application Center is made available to support new mobile operating systems. Users can be automatically notified when a new version of the mobile client is available in the Application Center repository. In your role as Administrator of the Application Center, you have only to upload the new binary version of the mobile client application to the catalog.

---

## MobileFirst Platform Command Line Interface for iOS

To help developers get a better tools experience, IBM MobileFirst Platform provides a command-line interface (CLI) tool to easily create and manage apps. The CLI enables developers to use their preferred text editors or alternative IDEs to create mobile applications.

The commands support tasks such as creating, adding, and configuring with the MobileFirst API library, adding the client-side MobileFirst properties file and performing the build and deploy of the MobileFirst application. From the command-line, you can create and deploy adapters, and test them locally. You can

administer your MobileFirst project from CLI or REST services, or the Console, where you can easily control the local server and observe the logs.

You can also use the CLI to integrate third-party tools such as ANT or Grunt to create your own tool chain for automated testing, build, and deployment flows.

To install command-line tools, see “Installing command-line tools for developers” on page 6-2.

## CLI commands usage

The CLI commands are intended for IT developers to create MobileFirst projects separately from the Eclipse MobileFirst Studio.

Use the command-line interface (CLI) keywords and options from a command line window. To run the commands, you can use either **mfp** or **mobilefirst**.

You can run the commands in either of the following ways:

- The direct method: You enter the command and set its options on one line and press Enter. For example: **\$ mfp add adapter MyAdapter --type http**.
- The interactive method: You enter the command with no arguments and press Enter. For example: **\$ mfp add adapter**. Then, you are prompted to set the available parameters one by one.

Examples:

```
$ mfp create MyProject --app myApp
$ cd MyProject
$ mfp add api MyiOS
$ mfp add adapter MySQLAdapter --type sql
$ cd MySQLAdapter
$ mfp build
$ mfp deploy
```

## Command-line flags and options

**-v, --version** Prints this utility's version  
**-d, --debug** Produces debug log output  
**-dd, --ddebug** Produces verbose log output

For a complete list of the CLI commands with descriptions of their function, see “Commands.”

## Commands

You can use IBM MobileFirst Platform Command Line Interface for iOS to create apps from the command line.

### A

#### ADAPTER

Syntax: **mfp adapter [add|call]**

You can use the **adapter** command to manage your adapters on the MobileFirst Server.

#### ADAPTER ADD

Syntax: `mfp adapter add [<name> --type|-t <type> [--jsonstore|-j] [--ussd|-u] [--package|-p <package>]` The `adapter add` command creates a new adapter, which is generated in the `adapters` folder of the current project.

If you run `adapter add` without any arguments, you are prompted for the following parameters:

**<name>**

The name that you want for the generated adapter.

**<type>**

The type of adapter. Valid values are: **castiron**, **http**, **java**, **jco**, **jms**, **sap**, and **sql**.

**[--jsonstore|-j]**

Your choice of JSONStore procedures. JSONStore procedures are not valid for JCo and Java adapters.

**[--ussd|-u]**

The option for the Unstructured Supplementary Service Data (USSD) communication technology.

**[--package|-p <package>]**

The name of the package that contains the Java adapter classes. Package option is valid only for Java adapters.

## ADAPTER CALL

Syntax: `mfp adapter call [<adapter>/<procedure> ["<arguments>"]]`

or

`mfp adapter call [<adapter>/<procedure> [--type|-t get|post] [--file|-f <args.json>]`

or

Syntax: `mfp adapter call [<adapter>/<procedure>`

`[--type|-t get|post]`

`[--form|-fp <form_parameters>]`

`[--header|-h <header_parameters>]`

`[--query|-q <query_parameters>]`

`]`

The `adapter call` command calls an adapter's procedure on the MobileFirst Server. You can use "**FORM**, **HEADER**, and **QUERY** parameters" to call an adapter's procedure by using the direct mode. Add the flag for the parameter type and pass the object of parameters, if needed. For example: `--form "username:user" --header "password:pass" --query "date:01/01/2015"`.

To use "**PATH** parameters" in direct mode, add them to the adapter/procedure path. Replace the `{pathParameter}` with the value that you want to send as the parameter. For example:

- Before: `myAdapter/users/{username}`. In this example, you must replace the `{username}` parameter.
- After: `myAdapter/users/StanLee`

**[--file|-f]**

The JSON file that contains the required arguments.

**[--type|-t]**

Indicates the request type: **GET** or **POST** are the valid options. If you are using Java adapters, the type also includes **PUT** and **DELETE**.

**Note:** If the **type** parameter is not defined, the adapter call command uses **GET** by default. Type cannot be passed in a JSON file.

**[--form|-fp]**

The form parameters to pass with the procedure. For Java Adapters and Direct Mode use only.

**[--header|-h]**

The header parameters to pass with the procedure. For Java Adapters and Direct Mode use only.

**[--query|-q]**

The query parameters to pass with the procedure. For Java Adapters and Direct Mode use only.

You can run the **adapter call** command by using one of the following methods.

- Interactive: **\$ mfp adapter call**, then follow the prompts by using the arrow keys.
- Direct with no parameters: **\$ mfp adapter call adapterName/procedure**.
- Direct with multiple parameters: **\$ mfp adapter call adapterName/procedure "stringParameter", 2, true**.
- Direct with an array: **\$ mfp adapter call adapterName/procedure ["stringParameter", 2, true**
- Direct with a JSON file parameter: **\$ mfp adapter call adapterName/procedure --file ./myArgs.json**

JSON file

```
[
 "world"
]
```

JSON file for Java adapter

```
{
 "FORM":{"username":"user","password":"pass"},
 "QUERY":{"index":6},
 "HEADER":{"Date":"01/01/2015"}
}
```

- Direct with POST method: **\$ mfp adapter call adapterName/procedure/{path\_parameter} -fp "username:user1" --type post**
- Direct with Java adapter: **\$ mfp adapter call "adapterName/procedure/{pathParameter with space}" --form "username:user" --header "Date:01/01/2015" --query "index=6" --type post**

**ADD**

Syntax: **mfp add [adapter|api]** The **add** command generates new MobileFirst artifacts. The current working directory must be a child of an existing MobileFirst project. Generated artifacts go into the appropriate folder within the project, regardless of the current working directory. For example, adapters are generated to the adapters folder and native APIs are generated to the apps folder.

## ADD ADAPTER

Syntax: **mfp add adapter** [**<name>** **--type|-t** **<adapertype>** **--jsonstore|-j** **--ussd|-u** **--package|-p**]] This command is deprecated in V7.0.0. You can use the **adapter add** command instead. The **add adapter** command creates a new adapter, which is generated into the **adapters** folder of the current project.

If you run **add adapter** without any arguments, you are prompted for the following parameters:

**<name>**

The name that you want for the generated adapter.

**<adapertype>**

The type of adapter. For example: HTTP, Cast Iron<sup>®</sup>, SAP, JCo, or Java.

**--jsonstore|-j**

Your choice of JSONStore procedures. JSONStore procedures are not valid for JCo and Java adapters.

**--ussd|-u**

The option for the Unstructured Supplementary Service Data (USSD) communication technology.

**--package|-p**

The name of the package that contains the Java adapter classes. Package option is valid only for Java adapters.

## ADD API

Syntax: **mfp add api** [**<name>**] The **add api** command generates a new native API into the **apps** folder of the current project. Run the command in the current working directory, which is a child of a MobileFirst project.

If you run **\$ mfp add api** without any arguments, you are prompted for the following parameter:

**<name>**

The name that you want for the generated native API.

## B

### BD

Syntax: **mfp bd** The **bd** command builds and deploys to the local test server the set of MobileFirst resources that are most local to the current working directory. To run the **bd** command, navigate to the preferred folder and enter **\$ mfp bd**.

### BUILD

Syntax: **mfp build** The **build** command builds the set of MobileFirst resources that are most local to the current working directory.

To generate a build in the preferred folder, navigate to the folder and enter **\$ mfp build**.

- If you run the command from the root folder of a MobileFirst project, the command builds all the apps and adapters in the project.
- If you run the command from the **apps** folder, the command builds all the apps in the project.
- If you run the command from the folder of a specific adapter, the command builds that one adapter.

## C

### CONFIG

Syntax: **mfp config [<setting>][<value>]**This command is a global command. Use the **config** command to set your configuration preferences, in particular which browser is used by CLI. To configure your preferences, you can use one of the following syntaxes:

- Interactive: Run **\$ mfp config** and follow the prompts by using the arrow keys.
- Direct with the **setting** parameter: **\$ mfp config [<setting>]**.
- Direct with the **setting** and **value** parameters: **\$ mfp config [<setting>] [<value>]**.

### CONSOLE

Syntax: **mfp console**This command is a global command. The **console** command opens the MobileFirst Operations Console in your default browser for the current project.

This command takes no parameters. To open the MobileFirst Operations Console, run: **\$ mfp console**.

### CREATE

Syntax: **mfp create [<name> --app|-a <app>]**This command is a global command. The **create** command creates a new MobileFirst project in the current working directory. This new project contains an iOS app in the apps folder. If you enter the command without any arguments, you are prompted for the name of the project and the name of the application. To generate a new MobileFirst project that is called MyProject, enter **\$ mfp create MyProject --app MyApp**.

### CREATE SERVER

Syntax: **mfp create-server**This command is a global command that does not need to be run manually because the built-in development server is automatically created and started as needed. The **create server** command creates a new WebSphere Application Server Liberty application server in your default folder. The server is preconfigured to work as a MobileFirst local test server. To run the command, enter **mfp create-server**. This command takes no arguments.

## D

### DEPLOY

Syntax: **mfp deploy**The **deploy** command deploys to the local test server the set of MobileFirst resources that are found in the current working directory. To run the **deploy** command in the preferred folder, navigate to the folder and enter **\$ mfp deploy**.

- If you run the command from the root folder of a MobileFirst project, the command deploys all apps and adapters in the project.
- If you run the command from the apps folder, the command deploys all the apps in the project.
- If you run the command from the folder of a specific adapter, the command deploys that one adapter.
- If you run the command from the folder of a specific application, the command deploys that one application.

## H

### HELP

Syntax: **mfp help** [**<command>**]This command is a global command. The **help** command displays either information about the general use of the CLI, or detailed help for each command.

- Information about the use of the CLI: **\$ mfp help**.
- Information about a specific command: **\$ mfp help invoke**.

## I

### INFO

Syntax: **mfp info**The **info** command generates information about your environment. This information contains the operating system, the memory consumption on your machine, the node version, and the CLI version. If your current directory is a MobileFirst project, it also displays information about your project.

### INVOKE

Syntax: **mfp invoke** [**<adapter>:<procedure>**[\"**<json array>**\"]**--file|-f <path to json array file>**]]This command is deprecated. You can use the **adapter call** command instead. The **invoke** command starts a procedure for a specified adapter on MobileFirst Server. Pass the arguments as a comma-separated list. If you enter the command with no arguments, you are prompted for an adapter and procedure, based on what is available in the current working directory of your project. You can run the command with one of the following syntaxes:

- Interactive: **\$ mfp invoke**, then follow the prompts by using the arrow keys.
- Direct with no parameters: **\$ mfp invoke adapterName:function**.
- Direct with a JSON array parameter: **\$ mfp invoke adapterName:function [\"string\", 2, true]**.
- Direct with a JSON file parameter: **\$ mfp invoke adapterName:function --file ./myArts.json**.

## L

### LOGS

Syntax: **mfp logs**The **logs** command shows the path to the local test server logs. You can run the **logs** command from any directory. On completion, the path to the test server logs is displayed and control is returned to the command line. The **logs** command takes no arguments. To run it, enter **\$ mfp logs**.

## R

### RESTART

Syntax: **mfp restart**The **restart** command restarts the local test server. Run the **restart** command in the current working directory, which is a child of a MobileFirst project. On completion, a message indicates a successful start, and control is returned to the command line. This command takes no arguments. To run the **restart** command in the preferred folder, navigate to the folder and enter **\$ mfp restart**.

### RUN

Syntax: **mfp run**The **run** command starts the local test server. Run **mfp run** in the current working directory, which is a child of a MobileFirst project. This command does not return control to the command line. It displays new status messages from the server until the server is stopped. The **run** command takes no arguments. To run it, enter **\$ mfp run**.

## S

### START

Syntax: **mfp start**The **start** command starts the local test server. Run **mfp start** command in the current working directory, which is a child of a MobileFirst project. On completion, a message indicates that a successful start and control is returned to the command line. This command takes no arguments. To start the local test server, enter **\$ mfp start**.

### STATUS

Syntax: **mfp status**The **status** command shows the status of the local test server, either running or stopped. Run the command in the current working directory, which is a child of a MobileFirst project. This command takes no arguments. To run the command, enter **\$ mfp status**.

### STOP

Syntax: **mfp stop**The **stop** command stops the local test server. Run **mfp stop** command in the current working directory, which is a child of a MobileFirst project. This command takes no arguments. To run the command, enter **\$ mfp stop**.

## Commands

You can use IBM MobileFirst Platform Command Line Interface for iOS to create apps from the command line.

## A:

### ADAPTER

Syntax: **mfp adapter [add|call]**

You can use the **adapter** command to manage your adapters on the MobileFirst Server.

### ADAPTER ADD

Syntax: **mfp adapter add [<name> --type|-t <type> [--jsonstore|-j] [--ussd|-u] [--package|-p <package>]**The **adapter add** command creates a new adapter, which is generated in the **adapters** folder of the current project.

If you run **adapter add** without any arguments, you are prompted for the following parameters:

#### <name>

The name that you want for the generated adapter.

#### <type>

The type of adapter. Valid values are: **castiron**, **http**, **java**, **jco**, **jms**, **sap**, and **sql**.

#### [--jsonstore|-j]

Your choice of JSONStore procedures. JSONStore procedures are not valid for JCo and Java adapters.



**[--ussd|-u]**

The option for the Unstructured Supplementary Service Data (USSD) communication technology.

**[--package|-p <package>]**

The name of the package that contains the Java adapter classes. Package option is valid only for Java adapters.

## ADAPTER CALL

Syntax: **mfp adapter call** [<adapter>/<procedure> ["<arguments>"]]

or

**mfp adapter call** [<adapter>/<procedure> [--type|-t get|post] [--file|-f <args.json>]]

or

Syntax: **mfp adapter call** [<adapter>/<procedure>

**[--type|-t get|post]**

**[--form|-fp <form\_parameters>]**

**[--header|-h <header\_parameters>]**

**[--query|-q <query\_parameters>]**

**]**

The **adapter call** command calls an adapter's procedure on the MobileFirst Server. You can use "**FORM**, **HEADER**, and **QUERY** parameters" to call an adapter's procedure by using the direct mode. Add the flag for the parameter type and pass the object of parameters, if needed. For example: `--form "username:user" --header "password:pass" --query "date:01/01/2015"`.

To use "**PATH** parameters" in direct mode, add them to the adapter/procedure path. Replace the **{pathParameter}** with the value that you want to send as the parameter. For example:

- Before: `myAdapter/users/{username}`. In this example, you must replace the **{username}** parameter.
- After: `myAdapter/users/StanLee`

**[--file|-f]**

The JSON file that contains the required arguments.

**[--type|-t]**

Indicates the request type: **GET** or **POST** are the valid options. If you are using Java adapters, the type also includes **PUT** and **DELETE**.

**Note:** If the **type** parameter is not defined, the `adapter call` command uses **GET** by default. Type cannot be passed in a JSON file.

**[--form|-fp]**

The form parameters to pass with the procedure. For Java Adapters and Direct Mode use only.

**[--header|-h]**

The header parameters to pass with the procedure. For Java Adapters and Direct Mode use only.

### **[--query|-q]**

The query parameters to pass with the procedure. For Java Adapters and Direct Mode use only.

You can run the **adapter call** command by using one of the following methods.

- Interactive: **\$ mfp adapter call**, then follow the prompts by using the arrow keys.
- Direct with no parameters: **\$ mfp adapter call adapterName/procedure**.
- Direct with multiple parameters: **\$ mfp adapter call adapterName/procedure "stringParameter", 2, true**.
- Direct with an array: **\$ mfp adapter call adapterName/procedure ["stringParameter", 2, true**
- Direct with a JSON file parameter: **\$ mfp adapter call adapterName/procedure --file ./myArgs.json**

JSON file

```
[
 "world"
]
```

JSON file for Java adapter

```
{
 "FORM":{"username":"user","password":"pass"},
 "QUERY":{"index":6},
 "HEADER":{"Date":"01/01/2015"}
}
```

- Direct with POST method: **\$ mfp adapter call adapterName/procedure/{path\_parameter} -fp "username:user1" --type post**
- Direct with Java adapter: **\$ mfp adapter call "adapterName/procedure/{pathParameter with space}" --form "username:user" --header "Date:01/01/2015" --query "index=6" --type post**

## **ADD**

Syntax: **mfp add [adapter|api]** The **add** command generates new MobileFirst artifacts. The current working directory must be a child of an existing MobileFirst project. Generated artifacts go into the appropriate folder within the project, regardless of the current working directory. For example, adapters are generated to the adapters folder and native APIs are generated to the apps folder.

## **ADD ADAPTER**

Syntax: **mfp add adapter [<name> --type|-t <adapertype> [--jsonstore|-j] [--ussd|-u] [--package|-p]]** This command is deprecated in V7.0.0. You can use the **adapter add** command instead. The **add adapter** command creates a new adapter, which is generated into the **adapters** folder of the current project.

If you run **add adapter** without any arguments, you are prompted for the following parameters:

**<name>**

The name that you want for the generated adapter.

**<adapertype>**

The type of adapter. For example: HTTP, Cast Iron, SAP, JCo, or Java.

**[--jsonstore|-j]**

Your choice of JSONStore procedures. JSONStore procedures are not valid for JCo and Java adapters.

**[--ussd|-u]**

The option for the Unstructured Supplementary Service Data (USSD) communication technology.

**[--package|-p]**

The name of the package that contains the Java adapter classes. Package option is valid only for Java adapters.

**ADD API**

Syntax: **mfp add api [<name>]**The **add api** command generates a new native API into the apps folder of the current project. Run the command in the current working directory, which is a child of a MobileFirst project.

If you run **\$ mfp add api** without any arguments, you are prompted for the following parameter:

**<name>**

The name that you want for the generated native API.

**B:****BD**

Syntax: **mfp bd**The **bd** command builds and deploys to the local test server the set of MobileFirst resources that are most local to the current working directory. To run the **bd** command, navigate to the preferred folder and enter **\$ mfp bd**.

**BUILD**

Syntax: **mfp build**The **build** command builds the set of MobileFirst resources that are most local to the current working directory.

To generate a build in the preferred folder, navigate to the folder and enter **\$ mfp build**.

- If you run the command from the root folder of a MobileFirst project, the command builds all the apps and adapters in the project.
- If you run the command from the apps folder, the command builds all the apps in the project.
- If you run the command from the folder of a specific adapter, the command builds that one adapter.

**C:****CONFIG**

Syntax: **mfp config [<setting>][<value>]**This command is a global command. Use the **config** command to set your configuration preferences, in particular which browser is used by CLI. To configure your preferences, you can use one of the following syntaxes:

- Interactive: Run **\$ mfp config** and follow the prompts by using the arrow keys.
- Direct with the **setting** parameter: **\$ mfp config [<setting>]**.
- Direct with the **setting** and **value** parameters: **\$ mfp config [<setting>] [<value>]**.

**CONSOLE**

Syntax: **mfp console**This command is a global command. The **console** command opens the MobileFirst Operations Console in your default browser for the current project.

This command takes no parameters. To open the MobileFirst Operations Console, run: **\$ mfp console**.

## CREATE

Syntax: **mfp create** [**<name>** **--app** | **-a** **<app>**]This command is a global command. The **create** command creates a new MobileFirst project in the current working directory. This new project contains an iOS app in the apps folder. If you enter the command without any arguments, you are prompted for the name of the project and the name of the application. To generate a new MobileFirst project that is called MyProject, enter **\$ mfp create MyProject --app MyApp**.

## CREATE SERVER

Syntax: **mfp create-server**This command is a global command that does not need to be run manually because the built-in development server is automatically created and started as needed. The **create server** command creates a new WebSphere Application Server Liberty application server in your default folder. The server is preconfigured to work as a MobileFirst local test server. To run the command, enter **mfp create-server**. This command takes no arguments.

## D:

## DEPLOY

Syntax: **mfp deploy**The **deploy** command deploys to the local test server the set of MobileFirst resources that are found in the current working directory. To run the **deploy** command in the preferred folder, navigate to the folder and enter **\$ mfp deploy**.

- If you run the command from the root folder of a MobileFirst project, the command deploys all apps and adapters in the project.
- If you run the command from the apps folder, the command deploys all the apps in the project.
- If you run the command from the folder of a specific adapter, the command deploys that one adapter.
- If you run the command from the folder of a specific application, the command deploys that one application.

## H:

## HELP

Syntax: **mfp help** [**<command>**]This command is a global command. The **help** command displays either information about the general use of the CLI, or detailed help for each command.

- Information about the use of the CLI: **\$ mfp help**.
- Information about a specific command: **\$ mfp help invoke**.

## I:

## INFO

Syntax: **mfp info**The **info** command generates information about your environment. This information contains the operating system, the memory

consumption on your machine, the node version, and the CLI version. If your current directory is a MobileFirst project, it also displays information about your project.

## INVOKE

Syntax: **mfp invoke** [**<adapter>**:**<procedure>**[\"**<json array>**\"]**--file|-f <path to json array file>**]]This command is deprecated. You can use the **adapter call** command instead. The **invoke** command starts a procedure for a specified adapter on MobileFirst Server. Pass the arguments as a comma-separated list. If you enter the command with no arguments, you are prompted for an adapter and procedure, based on what is available in the current working directory of your project. You can run the command with one of the following syntaxes:

- Interactive: **\$ mfp invoke**, then follow the prompts by using the arrow keys.
- Direct with no parameters: **\$ mfp invoke adapterName:function**.
- Direct with a JSON array parameter: **\$ mfp invoke adapterName:function [\"string\", 2, true]**.
- Direct with a JSON file parameter: **\$ mfp invoke adapterName:function --file ./myArts.json**.

## L:

## LOGS

Syntax: **mfp logs**The **logs** command shows the path to the local test server logs. You can run the **logs** command from any directory. On completion, the path to the test server logs is displayed and control is returned to the command line. The **logs** command takes no arguments. To run it, enter **\$ mfp logs**.

## R:

## RESTART

Syntax: **mfp restart**The **restart** command restarts the local test server. Run the **restart** command in the current working directory, which is a child of a MobileFirst project. On completion, a message indicates a successful start, and control is returned to the command line. This command takes no arguments. To run the **restart** command in the preferred folder, navigate to the folder and enter **\$ mfp restart**.

## RUN

Syntax: **mfp run**The **run** command starts the local test server. Run **mfp run** in the current working directory, which is a child of a MobileFirst project. This command does not return control to the command line. It displays new status messages from the server until the server is stopped. The **run** command takes no arguments. To run it, enter **\$ mfp run**.

## S:

## START

Syntax: **mfp start**The **start** command starts the local test server. Run **mfp start** command in the current working directory, which is a child of a MobileFirst project. On completion, a message indicates that a successful start and control is returned to the command line. This command takes no arguments. To start the local test server, enter **\$ mfp start**.

## STATUS

Syntax: **mfp status**The **status** command shows the status of the local test server, either running or stopped. Run the command in the current working directory, which is a child of a MobileFirst project. This command takes no arguments. To run the command, enter **\$ mfp status**.

## STOP

Syntax: **mfp stop**The **stop** command stops the local test server. Run **mfp stop** command in the current working directory, which is a child of a MobileFirst project. This command takes no arguments. To run the command, enter **\$ mfp stop**.

## Commands

You can use IBM MobileFirst Platform Command Line Interface for iOS to create apps from the command line.

### A:

## ADAPTER

Syntax: **mfp adapter [add|call]**

You can use the **adapter** command to manage your adapters on the MobileFirst Server.

## ADAPTER ADD

Syntax: **mfp adapter add [<name> --type|-t <type> [--jsonstore|-j] [--ussd|-u] [--package|-p <package>]**The **adapter add** command creates a new adapter, which is generated in the **adapters** folder of the current project.

If you run **adapter add** without any arguments, you are prompted for the following parameters:

### <name>

The name that you want for the generated adapter.

### <type>

The type of adapter. Valid values are: **castiron**, **http**, **java**, **jco**, **jms**, **sap**, and **sql**.

### [--jsonstore|-j]

Your choice of JSONStore procedures. JSONStore procedures are not valid for JCo and Java adapters.

### [--ussd|-u]

The option for the Unstructured Supplementary Service Data (USSD) communication technology.

### [--package|-p <package>]

The name of the package that contains the Java adapter classes. Package option is valid only for Java adapters.

## ADAPTER CALL

Syntax: **mfp adapter call [<adapter>/<procedure> ["<arguments>"]]**

or

**mfp adapter call [<adapter>/<procedure> [--type|-t get|post] [--file|-f <args.json>]**

or

Syntax: **mfp adapter call** [<adapter>/<procedure>

**[--type|-t get|post]**

**[--form|-fp <form\_parameters>]**

**[--header|-h <header\_parameters>]**

**[--query|-q <query\_parameters>]**

]

The **adapter call** command calls an adapter's procedure on the MobileFirst Server. You can use "**FORM**, **HEADER**, and **QUERY** parameters" to call an adapter's procedure by using the direct mode. Add the flag for the parameter type and pass the object of parameters, if needed. For example: `--form "username:user" --header "password:pass" --query "date:01/01/2015"`.

To use "**PATH** parameters" in direct mode, add them to the adapter/procedure path. Replace the {**pathParameter**} with the value that you want to send as the parameter. For example:

- Before: `myAdapter/users/{username}`. In this example, you must replace the {**username**} parameter.
- After: `myAdapter/users/StanLee`

**[--file|-f]**

The JSON file that contains the required arguments.

**[--type|-t]**

Indicates the request type: **GET** or **POST** are the valid options. If you are using Java adapters, the type also includes **PUT** and **DELETE**.

**Note:** If the **type** parameter is not defined, the `adapter call` command uses **GET** by default. Type cannot be passed in a JSON file.

**[--form|-fp]**

The form parameters to pass with the procedure. For Java Adapters and Direct Mode use only.

**[--header|-h]**

The header parameters to pass with the procedure. For Java Adapters and Direct Mode use only.

**[--query|-q]**

The query parameters to pass with the procedure. For Java Adapters and Direct Mode use only.

You can run the **adapter call** command by using one of the following methods.

- Interactive: `$ mfp adapter call`, then follow the prompts by using the arrow keys.
- Direct with no parameters: `$ mfp adapter call adapterName/procedure`.
- Direct with multiple parameters: `$ mfp adapter call adapterName/procedure "stringParameter", 2, true`.
- Direct with an array: `$ mfp adapter call adapterName/procedure ["stringParameter", 2, true`
- Direct with a JSON file parameter: `$ mfp adapter call adapterName/procedure --file ./myArgs.json`  
JSON file

```
[
 "world"
]
```

JSON file for Java adapter

```
{
 "FORM":{"username":"user","password":"pass"},
 "QUERY":{"index":6},
 "HEADER":{"Date":"01/01/2015"}
}
```

- Direct with POST method: **\$ mfp adapter call adapterName/procedure/{path\_parameter} -fp "username:user1" --type post**
- Direct with Java adapter: **\$ mfp adapter call "adapterName/procedure/{pathParameter with space}" --form "username:user" --header "Date:01/01/2015" --query "index=6" --type post**

## ADD

Syntax: **mfp add [adapter|api]** The **add** command generates new MobileFirst artifacts. The current working directory must be a child of an existing MobileFirst project. Generated artifacts go into the appropriate folder within the project, regardless of the current working directory. For example, adapters are generated to the adapters folder and native APIs are generated to the apps folder.

## ADD ADAPTER

Syntax: **mfp add adapter [<name> --type|-t <adaptype> [--jsonstore|-j] [--ussd|-u] [--package|-p]]** This command is deprecated in V7.0.0. You can use the **adapter add** command instead. The **add adapter** command creates a new adapter, which is generated into the **adapters** folder of the current project.

If you run **add adapter** without any arguments, you are prompted for the following parameters:

### <name>

The name that you want for the generated adapter.

### <adaptype>

The type of adapter. For example: HTTP, Cast Iron, SAP, JCo, or Java.

### [--jsonstore|-j]

Your choice of JSONStore procedures. JSONStore procedures are not valid for JCo and Java adapters.

### [--ussd|-u]

The option for the Unstructured Supplementary Service Data (USSD) communication technology.

### [--package|-p]

The name of the package that contains the Java adapter classes. Package option is valid only for Java adapters.

## ADD API

Syntax: **mfp add api [<name>]** The **add api** command generates a new native API into the apps folder of the current project. Run the command in the current working directory, which is a child of a MobileFirst project.

If you run **\$ mfp add api** without any arguments, you are prompted for the following parameter:



**<name>**

The name that you want for the generated native API.

**B:**

**BD**

Syntax: **mfp bd**The **bd** command builds and deploys to the local test server the set of MobileFirst resources that are most local to the current working directory. To run the **bd** command, navigate to the preferred folder and enter **\$ mfp bd**.

**BUILD**

Syntax: **mfp build**The **build** command builds the set of MobileFirst resources that are most local to the current working directory.

To generate a build in the preferred folder, navigate to the folder and enter **\$ mfp build**.

- If you run the command from the root folder of a MobileFirst project, the command builds all the apps and adapters in the project.
- If you run the command from the apps folder, the command builds all the apps in the project.
- If you run the command from the folder of a specific adapter, the command builds that one adapter.

**C:**

**CONFIG**

Syntax: **mfp config [<setting>][<value>]**This command is a global command. Use the **config** command to set your configuration preferences, in particular which browser is used by CLI. To configure your preferences, you can use one of the following syntaxes:

- Interactive: Run **\$ mfp config** and follow the prompts by using the arrow keys.
- Direct with the **setting** parameter: **\$ mfp config [<setting>]**.
- Direct with the **setting** and **value** parameters: **\$ mfp config [<setting>] [<value>]**.

**CONSOLE**

Syntax: **mfp console**This command is a global command. The **console** command opens the MobileFirst Operations Console in your default browser for the current project.

This command takes no parameters. To open the MobileFirst Operations Console, run: **\$ mfp console**.

**CREATE**

Syntax: **mfp create [<name> --app|-a <app>]**This command is a global command. The **create** command creates a new MobileFirst project in the current working directory. This new project contains an iOS app in the apps folder. If you enter the command without any arguments, you are prompted for the name of the project and the name of the application. To generate a new MobileFirst project that is called MyProject, enter **\$ mfp create MyProject --app MyApp**.

**CREATE SERVER**

Syntax: **mfp create-server**This command is a global command that does not need to be run manually because the built-in development server is automatically created and started as needed. The **create server** command creates a new WebSphere Application Server Liberty application server in your default folder. The server is preconfigured to work as a MobileFirst local test server. To run the command, enter **mfp create-server**. This command takes no arguments.

## D:

### DEPLOY

Syntax: **mfp deploy**The **deploy** command deploys to the local test server the set of MobileFirst resources that are found in the current working directory. To run the **deploy** command in the preferred folder, navigate to the folder and enter **\$ mfp deploy**.

- If you run the command from the root folder of a MobileFirst project, the command deploys all apps and adapters in the project.
- If you run the command from the apps folder, the command deploys all the apps in the project.
- If you run the command from the folder of a specific adapter, the command deploys that one adapter.
- If you run the command from the folder of a specific application, the command deploys that one application.

## H:

### HELP

Syntax: **mfp help [<command>]**This command is a global command. The **help** command displays either information about the general use of the CLI, or detailed help for each command.

- Information about the use of the CLI: **\$ mfp help**.
- Information about a specific command: **\$ mfp help invoke**.

## I:

### INFO

Syntax: **mfp info**The **info** command generates information about your environment. This information contains the operating system, the memory consumption on your machine, the node version, and the CLI version. If your current directory is a MobileFirst project, it also displays information about your project.

### INVOKE

Syntax: **mfp invoke [<adapter>:<procedure>[\"<json array>\"|**--file**|-f <path to json array file>]]**This command is deprecated. You can use the **adapter call** command instead. The **invoke** command starts a procedure for a specified adapter on MobileFirst Server. Pass the arguments as a comma-separated list. If you enter the command with no arguments, you are prompted for an adapter and procedure, based on what is available in the current working directory of your project. You can run the command with one of the following syntaxes:

- Interactive: **\$ mfp invoke**, then follow the prompts by using the arrow keys.
- Direct with no parameters: **\$ mfp invoke adapterName:function**.

- Direct with a JSON array parameter: **\$ mfp invoke adapterName:function ["string", 2, true]**.
- Direct with a JSON file parameter: **\$ mfp invoke adapterName:function --file ./myArts.json**.

**L:**

## LOGS

Syntax: **mfp logs**The **logs** command shows the path to the local test server logs. You can run the **logs** command from any directory. On completion, the path to the test server logs is displayed and control is returned to the command line. The **logs** command takes no arguments. To run it, enter **\$ mfp logs**.

**R:**

## RESTART

Syntax: **mfp restart**The **restart** command restarts the local test server. Run the **restart** command in the current working directory, which is a child of a MobileFirst project. On completion, a message indicates a successful start, and control is returned to the command line. This command takes no arguments. To run the **restart** command in the preferred folder, navigate to the folder and enter **\$ mfp restart**.

## RUN

Syntax: **mfp run**The **run** command starts the local test server. Run **mfp run** in the current working directory, which is a child of a MobileFirst project. This command does not return control to the command line. It displays new status messages from the server until the server is stopped. The **run** command takes no arguments. To run it, enter **\$ mfp run**.

**S:**

## START

Syntax: **mfp start**The **start** command starts the local test server. Run **mfp start** command in the current working directory, which is a child of a MobileFirst project. On completion, a message indicates that a successful start and control is returned to the command line. This command takes no arguments. To start the local test server, enter **\$ mfp start**.

## STATUS

Syntax: **mfp status**The **status** command shows the status of the local test server, either running or stopped. Run the command in the current working directory, which is a child of a MobileFirst project. This command takes no arguments. To run the command, enter **\$ mfp status**.

## STOP

Syntax: **mfp stop**The **stop** command stops the local test server. Run **mfp stop** command in the current working directory, which is a child of a MobileFirst project. This command takes no arguments. To run the command, enter **\$ mfp stop**.

## Commands

You can use IBM MobileFirst Platform Command Line Interface for iOS to create apps from the command line.

A:

## ADAPTER

Syntax: **mfp adapter** [add|call]

You can use the **adapter** command to manage your adapters on the MobileFirst Server.

## ADAPTER ADD

Syntax: **mfp adapter add** [<name> --type|-t <type> [--jsonstore|-j] [--ussd|-u] [--package|-p <package>] The **adapter add** command creates a new adapter, which is generated in the **adapters** folder of the current project.

If you run **adapter add** without any arguments, you are prompted for the following parameters:

**<name>**

The name that you want for the generated adapter.

**<type>**

The type of adapter. Valid values are: **castiron**, **http**, **java**, **jco**, **jms**, **sap**, and **sql**.

**[--jsonstore|-j]**

Your choice of JSONStore procedures. JSONStore procedures are not valid for JCo and Java adapters.

**[--ussd|-u]**

The option for the Unstructured Supplementary Service Data (USSD) communication technology.

**[--package|-p <package>]**

The name of the package that contains the Java adapter classes. Package option is valid only for Java adapters.

## ADAPTER CALL

Syntax: **mfp adapter call** [<adapter>/<procedure> ["<arguments>"]]

or

**mfp adapter call** [<adapter>/<procedure> [--type|-t get|post] [--file|-f <args.json>]]

or

Syntax: **mfp adapter call** [<adapter>/<procedure>

[--type|-t get|post]

[--form|-fp <form\_parameters>]

[--header|-h <header\_parameters>]

[--query|-q <query\_parameters>]

]

The **adapter call** command calls an adapter's procedure on the MobileFirst Server. You can use "**FORM**, **HEADER**, and **QUERY** parameters" to call an adapter's procedure by using the direct mode. Add the flag for the parameter type and pass the object of parameters, if needed. For example: **--form "username:user" --header "password:pass" --query "date:01/01/2015"**.

To use "PATH parameters" in direct mode, add them to the adapter/procedure path. Replace the {**pathParameter**} with the value that you want to send as the parameter. For example:

- Before: **myAdapter/users/{username}**. In this example, you must replace the {**username**} parameter.
- After: **myAdapter/users/StanLee**

**[--file|-f]**

The JSON file that contains the required arguments.

**[--type|-t]**

Indicates the request type: **GET** or **POST** are the valid options. If you are using Java adapters, the type also includes **PUT** and **DELETE**.

**Note:** If the **type** parameter is not defined, the adapter call command uses **GET** by default. Type cannot be passed in a JSON file.

**[--form|-fp]**

The form parameters to pass with the procedure. For Java Adapters and Direct Mode use only.

**[--header|-h]**

The header parameters to pass with the procedure. For Java Adapters and Direct Mode use only.

**[--query|-q]**

The query parameters to pass with the procedure. For Java Adapters and Direct Mode use only.

You can run the **adapter call** command by using one of the following methods.

- Interactive: **\$ mfp adapter call**, then follow the prompts by using the arrow keys.
- Direct with no parameters: **\$ mfp adapter call adapterName/procedure**.
- Direct with multiple parameters: **\$ mfp adapter call adapterName/procedure "stringParameter", 2, true**.
- Direct with an array: **\$ mfp adapter call adapterName/procedure ["stringParameter", 2, true**
- Direct with a JSON file parameter: **\$ mfp adapter call adapterName/procedure --file ./myArgs.json**

JSON file

```
[
 "world"
]
```

JSON file for Java adapter

```
{
 "FORM":{"username":"user","password":"pass"},
 "QUERY":{"index":6},
 "HEADER":{"Date":"01/01/2015"}
}
```

- Direct with POST method: **\$ mfp adapter call adapterName/procedure/{path\_parameter} -fp "username:user1" --type post**
- Direct with Java adapter: **\$ mfp adapter call "adapterName/procedure/{pathParameter with space}" --form "username:user" --header "Date:01/01/2015" --query "index=6" --type post**

ADD

Syntax: **mfp add [adapter|api]**The **add** command generates new MobileFirst artifacts. The current working directory must be a child of an existing MobileFirst project. Generated artifacts go into the appropriate folder within the project, regardless of the current working directory. For example, adapters are generated to the adapters folder and native APIs are generated to the apps folder.

## ADD ADAPTER

Syntax: **mfp add adapter [<name> --type|-t <adapertype> [--jsonstore|-j] [--ussd|-u] [--package|-p]]**This command is deprecated in V7.0.0. You can use the **adapter add** command instead. The **add adapter** command creates a new adapter, which is generated into the **adapters** folder of the current project.

If you run **add adapter** without any arguments, you are prompted for the following parameters:

**<name>**

The name that you want for the generated adapter.

**<adapertype>**

The type of adapter. For example: HTTP, Cast Iron, SAP, JCo, or Java.

**[--jsonstore|-j]**

Your choice of JSONStore procedures. JSONStore procedures are not valid for JCo and Java adapters.

**[--ussd|-u]**

The option for the Unstructured Supplementary Service Data (USSD) communication technology.

**[--package|-p]**

The name of the package that contains the Java adapter classes. Package option is valid only for Java adapters.

## ADD API

Syntax: **mfp add api [<name>]**The **add api** command generates a new native API into the apps folder of the current project. Run the command in the current working directory, which is a child of a MobileFirst project.

If you run **\$ mfp add api** without any arguments, you are prompted for the following parameter:

**<name>**

The name that you want for the generated native API.

## B:

## BD

Syntax: **mfp bd**The **bd** command builds and deploys to the local test server the set of MobileFirst resources that are most local to the current working directory. To run the **bd** command, navigate to the preferred folder and enter **\$ mfp bd**.

## BUILD

Syntax: **mfp build**The **build** command builds the set of MobileFirst resources that are most local to the current working directory.

To generate a build in the preferred folder, navigate to the folder and enter **\$ mfp build**.

- If you run the command from the root folder of a MobileFirst project, the command builds all the apps and adapters in the project.
- If you run the command from the apps folder, the command builds all the apps in the project.
- If you run the command from the folder of a specific adapter, the command builds that one adapter.

## C:

### CONFIG

Syntax: **mfp config** [**<setting>**] [**<value>**] This command is a global command. Use the **config** command to set your configuration preferences, in particular which browser is used by CLI. To configure your preferences, you can use one of the following syntaxes:

- Interactive: Run **\$ mfp config** and follow the prompts by using the arrow keys.
- Direct with the **setting** parameter: **\$ mfp config** [**<setting>**].
- Direct with the **setting** and **value** parameters: **\$ mfp config** [**<setting>**] [**<value>**].

### CONSOLE

Syntax: **mfp console** This command is a global command. The **console** command opens the MobileFirst Operations Console in your default browser for the current project.

This command takes no parameters. To open the MobileFirst Operations Console, run: **\$ mfp console**.

### CREATE

Syntax: **mfp create** [**<name>** **--app** | **-a** **<app>**] This command is a global command. The **create** command creates a new MobileFirst project in the current working directory. This new project contains an iOS app in the apps folder. If you enter the command without any arguments, you are prompted for the name of the project and the name of the application. To generate a new MobileFirst project that is called MyProject, enter **\$ mfp create MyProject --app MyApp**.

### CREATE SERVER

Syntax: **mfp create-server** This command is a global command that does not need to be run manually because the built-in development server is automatically created and started as needed. The **create server** command creates a new WebSphere Application Server Liberty application server in your default folder. The server is preconfigured to work as a MobileFirst local test server. To run the command, enter **mfp create-server**. This command takes no arguments.

## D:

### DEPLOY

Syntax: **mfp deploy** The **deploy** command deploys to the local test server the set of MobileFirst resources that are found in the current working directory. To run the **deploy** command in the preferred folder, navigate to the folder and enter **\$ mfp deploy**.

- If you run the command from the root folder of a MobileFirst project, the command deploys all apps and adapters in the project.

- If you run the command from the apps folder, the command deploys all the apps in the project.
- If you run the command from the folder of a specific adapter, the command deploys that one adapter.
- If you run the command from the folder of a specific application, the command deploys that one application.

## H:

### HELP

Syntax: **mfp help** [**<command>**] This command is a global command. The **help** command displays either information about the general use of the CLI, or detailed help for each command.

- Information about the use of the CLI: **\$ mfp help**.
- Information about a specific command: **\$ mfp help invoke**.

## I:

### INFO

Syntax: **mfp info** The **info** command generates information about your environment. This information contains the operating system, the memory consumption on your machine, the node version, and the CLI version. If your current directory is a MobileFirst project, it also displays information about your project.

## INVOKE

Syntax: **mfp invoke** [**<adapter>**:**<procedure>** [**\<json array>**\ | **--file** | **-f <path to json array file>**]] This command is deprecated. You can use the **adapter call** command instead. The **invoke** command starts a procedure for a specified adapter on MobileFirst Server. Pass the arguments as a comma-separated list. If you enter the command with no arguments, you are prompted for an adapter and procedure, based on what is available in the current working directory of your project. You can run the command with one of the following syntaxes:

- Interactive: **\$ mfp invoke**, then follow the prompts by using the arrow keys.
- Direct with no parameters: **\$ mfp invoke adapterName:function**.
- Direct with a JSON array parameter: **\$ mfp invoke adapterName:function ["string", 2, true]**.
- Direct with a JSON file parameter: **\$ mfp invoke adapterName:function --file ./myArts.json**.

## L:

### LOGS

Syntax: **mfp logs** The **logs** command shows the path to the local test server logs. You can run the **logs** command from any directory. On completion, the path to the test server logs is displayed and control is returned to the command line. The **logs** command takes no arguments. To run it, enter **\$ mfp logs**.

## R:

### RESTART



Syntax: **mfp restart**The **restart** command restarts the local test server. Run the **restart** command in the current working directory, which is a child of a MobileFirst project. On completion, a message indicates a successful start, and control is returned to the command line. This command takes no arguments. To run the **restart** command in the preferred folder, navigate to the folder and enter **\$ mfp restart**.

## RUN

Syntax: **mfp run**The **run** command starts the local test server. Run **mfp run** in the current working directory, which is a child of a MobileFirst project. This command does not return control to the command line. It displays new status messages from the server until the server is stopped. The **run** command takes no arguments. To run it, enter **\$ mfp run**.

## S:

## START

Syntax: **mfp start**The **start** command starts the local test server. Run **mfp start** command in the current working directory, which is a child of a MobileFirst project. On completion, a message indicates that a successful start and control is returned to the command line. This command takes no arguments. To start the local test server, enter **\$ mfp start**.

## STATUS

Syntax: **mfp status**The **status** command shows the status of the local test server, either running or stopped. Run the command in the current working directory, which is a child of a MobileFirst project. This command takes no arguments. To run the command, enter **\$ mfp status**.

## STOP

Syntax: **mfp stop**The **stop** command stops the local test server. Run **mfp stop** command in the current working directory, which is a child of a MobileFirst project. This command takes no arguments. To run the command, enter **\$ mfp stop**.

## Commands

You can use IBM MobileFirst Platform Command Line Interface for iOS to create apps from the command line.

## A:

### ADAPTER

Syntax: **mfp adapter [add|call]**

You can use the **adapter** command to manage your adapters on the MobileFirst Server.

### ADAPTER ADD

Syntax: **mfp adapter add [<name> --type|-t <type> [--jsonstore|-j] [--ussd|-u] [--package|-p <package>]**The **adapter add** command creates a new adapter, which is generated in the **adapters** folder of the current project.

If you run **adapter add** without any arguments, you are prompted for the following parameters:

**<name>**

The name that you want for the generated adapter.

**<type>**

The type of adapter. Valid values are: **castiron**, **http**, **java**, **jco**, **jms**, **sap**, and **sql**.

**[--jsonstore|-j]**

Your choice of JSONStore procedures. JSONStore procedures are not valid for JCo and Java adapters.

**[--ussd|-u]**

The option for the Unstructured Supplementary Service Data (USSD) communication technology.

**[--package|-p <package>]**

The name of the package that contains the Java adapter classes. Package option is valid only for Java adapters.

## ADAPTER CALL

Syntax: **mfp adapter call [<adapter>/<procedure> ["<arguments>"]]**

or

**mfp adapter call [<adapter>/<procedure> [--type|-t get|post] [--file|-f <args.json>]]**

or

Syntax: **mfp adapter call [<adapter>/<procedure>**

**[--type|-t get|post]**

**[--form|-fp <form\_parameters>]**

**[--header|-h <header\_parameters>]**

**[--query|-q <query\_parameters>]**

**]**

The **adapter call** command calls an adapter's procedure on the MobileFirst Server. You can use "**FORM**, **HEADER**, and **QUERY** parameters" to call an adapter's procedure by using the direct mode. Add the flag for the parameter type and pass the object of parameters, if needed. For example: **--form "username:user" --header "password:pass" --query "date:01/01/2015"**.

To use "**PATH** parameters" in direct mode, add them to the adapter/procedure path. Replace the **{pathParameter}** with the value that you want to send as the parameter. For example:

- Before: **myAdapter/users/{username}**. In this example, you must replace the **{username}** parameter.
- After: **myAdapter/users/StanLee**

**[--file|-f]**

The JSON file that contains the required arguments.

**[--type|-t]**

Indicates the request type: **GET** or **POST** are the valid options. If you are using Java adapters, the type also includes **PUT** and **DELETE**.

**Note:** If the **type** parameter is not defined, the **adapter call** command uses **GET** by default. Type cannot be passed in a JSON file.

**[--form|-fp]**

The form parameters to pass with the procedure. For Java Adapters and Direct Mode use only.

**[--header|-h]**

The header parameters to pass with the procedure. For Java Adapters and Direct Mode use only.

**[--query|-q]**

The query parameters to pass with the procedure. For Java Adapters and Direct Mode use only.

You can run the **adapter call** command by using one of the following methods.

- Interactive: **\$ mfp adapter call**, then follow the prompts by using the arrow keys.
- Direct with no parameters: **\$ mfp adapter call adapterName/procedure.**
- Direct with multiple parameters: **\$ mfp adapter call adapterName/procedure "stringParameter", 2, true.**
- Direct with an array: **\$ mfp adapter call adapterName/procedure ["stringParameter", 2, true**
- Direct with a JSON file parameter: **\$ mfp adapter call adapterName/procedure --file ./myArgs.json**

JSON file

```
[
 "world"
]
```

JSON file for Java adapter

```
{
 "FORM":{"username":"user","password":"pass"},
 "QUERY":{"index":6},
 "HEADER":{"Date":"01/01/2015"}
}
```

- Direct with POST method: **\$ mfp adapter call adapterName/procedure/{path\_parameter} -fp "username:user1" --type post**
- Direct with Java adapter: **\$ mfp adapter call "adapterName/procedure/{pathParameter with space}" --form "username:user" --header "Date:01/01/2015" --query "index=6" --type post**

**ADD**

Syntax: **mfp add [adapter|api]** The **add** command generates new MobileFirst artifacts. The current working directory must be a child of an existing MobileFirst project. Generated artifacts go into the appropriate folder within the project, regardless of the current working directory. For example, adapters are generated to the adapters folder and native APIs are generated to the apps folder.

**ADD ADAPTER**

Syntax: **mfp add adapter [<name> --type|-t <adapertype> [--jsonstore|-j] [--ussd|-u] [--package|-p]]** This command is deprecated in V7.0.0. You can use the **adapter add** command instead. The **add adapter** command creates a new adapter, which is generated into the **adapters** folder of the current project.

If you run **add adapter** without any arguments, you are prompted for the following parameters:

**<name>**

The name that you want for the generated adapter.

**<adaptype>**

The type of adapter. For example: HTTP, Cast Iron, SAP, JCo, or Java.

**[--jsonstore|-j]**

Your choice of JSONStore procedures. JSONStore procedures are not valid for JCo and Java adapters.

**[--ussd|-u]**

The option for the Unstructured Supplementary Service Data (USSD) communication technology.

**[--package|-p]**

The name of the package that contains the Java adapter classes. Package option is valid only for Java adapters.

## ADD API

Syntax: **mfp add api [<name>]**The **add api** command generates a new native API into the apps folder of the current project. Run the command in the current working directory, which is a child of a MobileFirst project.

If you run **\$ mfp add api** without any arguments, you are prompted for the following parameter:

**<name>**

The name that you want for the generated native API.

## B:

### BD

Syntax: **mfp bd**The **bd** command builds and deploys to the local test server the set of MobileFirst resources that are most local to the current working directory. To run the **bd** command, navigate to the preferred folder and enter **\$ mfp bd**.

## BUILD

Syntax: **mfp build**The **build** command builds the set of MobileFirst resources that are most local to the current working directory.

To generate a build in the preferred folder, navigate to the folder and enter **\$ mfp build**.

- If you run the command from the root folder of a MobileFirst project, the command builds all the apps and adapters in the project.
- If you run the command from the apps folder, the command builds all the apps in the project.
- If you run the command from the folder of a specific adapter, the command builds that one adapter.

## C:

### CONFIG

Syntax: **mfp config [<setting>][<value>]**This command is a global command. Use the **config** command to set your configuration preferences, in particular which browser is used by CLI. To configure your preferences, you can use one of the following syntaxes:

- Interactive: Run **\$ mfp config** and follow the prompts by using the arrow keys.

- Direct with the **setting** parameter: **\$ mfp config [<setting>]**.
- Direct with the **setting** and **value** parameters: **\$ mfp config [<setting>] [<value>]**.

## CONSOLE

Syntax: **mfp console**This command is a global command. The **console** command opens the MobileFirst Operations Console in your default browser for the current project.

This command takes no parameters. To open the MobileFirst Operations Console, run: **\$ mfp console**.

## CREATE

Syntax: **mfp create [<name> --app|-a <app>]**This command is a global command. The **create** command creates a new MobileFirst project in the current working directory. This new project contains an iOS app in the apps folder. If you enter the command without any arguments, you are prompted for the name of the project and the name of the application. To generate a new MobileFirst project that is called MyProject, enter **\$ mfp create MyProject --app MyApp**.

## CREATE SERVER

Syntax: **mfp create-server**This command is a global command that does not need to be run manually because the built-in development server is automatically created and started as needed. The **create server** command creates a new WebSphere Application Server Liberty application server in your default folder. The server is preconfigured to work as a MobileFirst local test server. To run the command, enter **mfp create-server**. This command takes no arguments.

## D:

### DEPLOY

Syntax: **mfp deploy**The **deploy** command deploys to the local test server the set of MobileFirst resources that are found in the current working directory. To run the **deploy** command in the preferred folder, navigate to the folder and enter **\$ mfp deploy**.

- If you run the command from the root folder of a MobileFirst project, the command deploys all apps and adapters in the project.
- If you run the command from the apps folder, the command deploys all the apps in the project.
- If you run the command from the folder of a specific adapter, the command deploys that one adapter.
- If you run the command from the folder of a specific application, the command deploys that one application.

## H:

### HELP

Syntax: **mfp help [<command>]**This command is a global command. The **help** command displays either information about the general use of the CLI, or detailed help for each command.

- Information about the use of the CLI: **\$ mfp help**.
- Information about a specific command: **\$ mfp help invoke**.

I:

## INFO

Syntax: **mfp info**The **info** command generates information about your environment. This information contains the operating system, the memory consumption on your machine, the node version, and the CLI version. If your current directory is a MobileFirst project, it also displays information about your project.

## INVOKE

Syntax: **mfp invoke** [**<adapter>**:**<procedure>**[\"**<json array>**\"]**--file|-f <path to json array file>**]]This command is deprecated. You can use the **adapter call** command instead. The **invoke** command starts a procedure for a specified adapter on MobileFirst Server. Pass the arguments as a comma-separated list. If you enter the command with no arguments, you are prompted for an adapter and procedure, based on what is available in the current working directory of your project. You can run the command with one of the following syntaxes:

- Interactive: **\$ mfp invoke**, then follow the prompts by using the arrow keys.
- Direct with no parameters: **\$ mfp invoke adapterName:function**.
- Direct with a JSON array parameter: **\$ mfp invoke adapterName:function [\"string\", 2, true]**.
- Direct with a JSON file parameter: **\$ mfp invoke adapterName:function --file ./myArts.json**.

L:

## LOGS

Syntax: **mfp logs**The **logs** command shows the path to the local test server logs. You can run the **logs** command from any directory. On completion, the path to the test server logs is displayed and control is returned to the command line. The **logs** command takes no arguments. To run it, enter **\$ mfp logs**.

R:

## RESTART

Syntax: **mfp restart**The **restart** command restarts the local test server. Run the **restart** command in the current working directory, which is a child of a MobileFirst project. On completion, a message indicates a successful start, and control is returned to the command line. This command takes no arguments. To run the **restart** command in the preferred folder, navigate to the folder and enter **\$ mfp restart**.

## RUN

Syntax: **mfp run**The **run** command starts the local test server. Run **mfp run** in the current working directory, which is a child of a MobileFirst project. This command does not return control to the command line. It displays new status messages from the server until the server is stopped. The **run** command takes no arguments. To run it, enter **\$ mfp run**.

S:

## START

Syntax: **mfp start**The **start** command starts the local test server. Run **mfp start** command in the current working directory, which is a child of a MobileFirst project. On completion, a message indicates that a successful start and control is returned to the command line. This command takes no arguments. To start the local test server, enter **\$ mfp start**.

## STATUS

Syntax: **mfp status**The **status** command shows the status of the local test server, either running or stopped. Run the command in the current working directory, which is a child of a MobileFirst project. This command takes no arguments. To run the command, enter **\$ mfp status**.

## STOP

Syntax: **mfp stop**The **stop** command stops the local test server. Run **mfp stop** command in the current working directory, which is a child of a MobileFirst project. This command takes no arguments. To run the command, enter **\$ mfp stop**.

## Commands

You can use IBM MobileFirst Platform Command Line Interface for iOS to create apps from the command line.

A:

## ADAPTER

Syntax: **mfp adapter [add|call]**

You can use the **adapter** command to manage your adapters on the MobileFirst Server.

## ADAPTER ADD

Syntax: **mfp adapter add [<name> --type|-t <type> [--jsonstore|-j] [--ussd|-u] [--package|-p <package>]**The **adapter add** command creates a new adapter, which is generated in the **adapters** folder of the current project.

If you run **adapter add** without any arguments, you are prompted for the following parameters:

**<name>**

The name that you want for the generated adapter.

**<type>**

The type of adapter. Valid values are: **castiron**, **http**, **java**, **jco**, **jms**, **sap**, and **sql**.

**[--jsonstore|-j]**

Your choice of JSONStore procedures. JSONStore procedures are not valid for JCo and Java adapters.

**[--ussd|-u]**

The option for the Unstructured Supplementary Service Data (USSD) communication technology.

**[--package|-p <package>]**

The name of the package that contains the Java adapter classes. Package option is valid only for Java adapters.

## ADAPTER CALL

Syntax: **mfp adapter call [<adapter>/<procedure> ["<arguments>"]]**

or

```
mfp adapter call [<adapter>/<procedure> [--type|-t get|post]
[--file|-f <args.json>]]
```

or

```
Syntax: mfp adapter call [<adapter>/<procedure>
 [--type|-t get|post]
 [--form|-fp <form_parameters>]
 [--header|-h <header_parameters>]
 [--query|-q <query_parameters>]
```

]

The **adapter call** command calls an adapter's procedure on the MobileFirst Server. You can use "**FORM**, **HEADER**, and **QUERY** parameters" to call an adapter's procedure by using the direct mode. Add the flag for the parameter type and pass the object of parameters, if needed. For example: `--form "username:user" --header "password:pass" --query "date:01/01/2015"`.

To use "**PATH** parameters" in direct mode, add them to the adapter/procedure path. Replace the `{pathParameter}` with the value that you want to send as the parameter. For example:

- Before: `myAdapter/users/{username}`. In this example, you must replace the `{username}` parameter.
- After: `myAdapter/users/StanLee`

**[--file|-f]**

The JSON file that contains the required arguments.

**[--type|-t]**

Indicates the request type: **GET** or **POST** are the valid options. If you are using Java adapters, the type also includes **PUT** and **DELETE**.

**Note:** If the **type** parameter is not defined, the `adapter call` command uses **GET** by default. Type cannot be passed in a JSON file.

**[--form|-fp]**

The form parameters to pass with the procedure. For Java Adapters and Direct Mode use only.

**[--header|-h]**

The header parameters to pass with the procedure. For Java Adapters and Direct Mode use only.

**[--query|-q]**

The query parameters to pass with the procedure. For Java Adapters and Direct Mode use only.

You can run the **adapter call** command by using one of the following methods.

- Interactive: `$ mfp adapter call`, then follow the prompts by using the arrow keys.
- Direct with no parameters: `$ mfp adapter call adapterName/procedure`.
- Direct with multiple parameters: `$ mfp adapter call adapterName/procedure "stringParameter", 2, true`.



- Direct with an array: `$ mfp adapter call adapterName/procedure ["stringParameter", 2, true`
- Direct with a JSON file parameter: `$ mfp adapter call adapterName/procedure --file ./myArgs.json`  
 JSON file  

```
[
 "world"
]
```

 JSON file for Java adapter  

```
{
 "FORM":{"username":"user","password":"pass"},
 "QUERY":{"index":6},
 "HEADER":{"Date":"01/01/2015"}
}
```
- Direct with POST method: `$ mfp adapter call adapterName/procedure/{path_parameter} -fp "username:user1" --type post`
- Direct with Java adapter: `$ mfp adapter call "adapterName/procedure/{pathParameter with space}" --form "username:user" --header "Date:01/01/2015" --query "index=6" --type post`

## ADD

Syntax: `mfp add [adapter|api]` The **add** command generates new MobileFirst artifacts. The current working directory must be a child of an existing MobileFirst project. Generated artifacts go into the appropriate folder within the project, regardless of the current working directory. For example, adapters are generated to the `adapters` folder and native APIs are generated to the `apps` folder.

## ADD ADAPTER

Syntax: `mfp add adapter [<name> --type|-t <adaptype> [--jsonstore|-j] [--ussd|-u] [--package|-p]]` This command is deprecated in V7.0.0. You can use the **adapter add** command instead. The **add adapter** command creates a new adapter, which is generated into the `adapters` folder of the current project.

If you run **add adapter** without any arguments, you are prompted for the following parameters:

### <name>

The name that you want for the generated adapter.

### <adaptype>

The type of adapter. For example: HTTP, Cast Iron, SAP, JCo, or Java.

### [--jsonstore|-j]

Your choice of JSONStore procedures. JSONStore procedures are not valid for JCo and Java adapters.

### [--ussd|-u]

The option for the Unstructured Supplementary Service Data (USSD) communication technology.

### [--package|-p]

The name of the package that contains the Java adapter classes. Package option is valid only for Java adapters.

## ADD API

Syntax: **mfp add api [<name>]**The **add api** command generates a new native API into the apps folder of the current project. Run the command in the current working directory, which is a child of a MobileFirst project.

If you run **\$ mfp add api** without any arguments, you are prompted for the following parameter:

**<name>**

The name that you want for the generated native API.

**B:**

**BD**

Syntax: **mfp bd**The **bd** command builds and deploys to the local test server the set of MobileFirst resources that are most local to the current working directory. To run the **bd** command, navigate to the preferred folder and enter **\$ mfp bd**.

**BUILD**

Syntax: **mfp build**The **build** command builds the set of MobileFirst resources that are most local to the current working directory.

To generate a build in the preferred folder, navigate to the folder and enter **\$ mfp build**.

- If you run the command from the root folder of a MobileFirst project, the command builds all the apps and adapters in the project.
- If you run the command from the apps folder, the command builds all the apps in the project.
- If you run the command from the folder of a specific adapter, the command builds that one adapter.

**C:**

**CONFIG**

Syntax: **mfp config [<setting>][<value>]**This command is a global command. Use the **config** command to set your configuration preferences, in particular which browser is used by CLI. To configure your preferences, you can use one of the following syntaxes:

- Interactive: Run **\$ mfp config** and follow the prompts by using the arrow keys.
- Direct with the **setting** parameter: **\$ mfp config [<setting>]**.
- Direct with the **setting** and **value** parameters: **\$ mfp config [<setting>] [<value>]**.

**CONSOLE**

Syntax: **mfp console**This command is a global command. The **console** command opens the MobileFirst Operations Console in your default browser for the current project.

This command takes no parameters. To open the MobileFirst Operations Console, run: **\$ mfp console**.

**CREATE**

Syntax: **mfp create [<name> --app|-a <app>]**This command is a global command. The **create** command creates a new MobileFirst project in the current working directory. This new project contains an iOS app in the apps folder. If you enter the command without any arguments, you are

prompted for the name of the project and the name of the application. To generate a new MobileFirst project that is called MyProject, enter **\$ mfp create MyProject --app MyApp**.

## CREATE SERVER

Syntax: **mfp create-server**This command is a global command that does not need to be run manually because the built-in development server is automatically created and started as needed. The **create server** command creates a new WebSphere Application Server Liberty application server in your default folder. The server is preconfigured to work as a MobileFirst local test server. To run the command, enter **mfp create-server**. This command takes no arguments.

## D:

### DEPLOY

Syntax: **mfp deploy**The **deploy** command deploys to the local test server the set of MobileFirst resources that are found in the current working directory. To run the **deploy** command in the preferred folder, navigate to the folder and enter **\$ mfp deploy**.

- If you run the command from the root folder of a MobileFirst project, the command deploys all apps and adapters in the project.
- If you run the command from the apps folder, the command deploys all the apps in the project.
- If you run the command from the folder of a specific adapter, the command deploys that one adapter.
- If you run the command from the folder of a specific application, the command deploys that one application.

## H:

### HELP

Syntax: **mfp help [<command>]**This command is a global command. The **help** command displays either information about the general use of the CLI, or detailed help for each command.

- Information about the use of the CLI: **\$ mfp help**.
- Information about a specific command: **\$ mfp help invoke**.

## I:

### INFO

Syntax: **mfp info**The **info** command generates information about your environment. This information contains the operating system, the memory consumption on your machine, the node version, and the CLI version. If your current directory is a MobileFirst project, it also displays information about your project.

## INVOKE

Syntax: **mfp invoke [<adapter>:<procedure>[\"<json array>\"|**--file**|-f <path to json array file>]]**This command is deprecated. You can use the **adapter call** command instead. The **invoke** command starts a procedure for a specified adapter on MobileFirst Server. Pass the arguments as a comma-separated list. If you enter the command with no arguments, you

are prompted for an adapter and procedure, based on what is available in the current working directory of your project. You can run the command with one of the following syntaxes:

- Interactive: **\$ mfp invoke**, then follow the prompts by using the arrow keys.
- Direct with no parameters: **\$ mfp invoke adapterName:function**.
- Direct with a JSON array parameter: **\$ mfp invoke adapterName:function ["string", 2, true]**.
- Direct with a JSON file parameter: **\$ mfp invoke adapterName:function --file ./myArts.json**.

**L:**

## **LOGS**

Syntax: **mfp logs**The **logs** command shows the path to the local test server logs. You can run the **logs** command from any directory. On completion, the path to the test server logs is displayed and control is returned to the command line. The **logs** command takes no arguments. To run it, enter **\$ mfp logs**.

**R:**

## **RESTART**

Syntax: **mfp restart**The **restart** command restarts the local test server. Run the **restart** command in the current working directory, which is a child of a MobileFirst project. On completion, a message indicates a successful start, and control is returned to the command line. This command takes no arguments. To run the **restart** command in the preferred folder, navigate to the folder and enter **\$ mfp restart**.

## **RUN**

Syntax: **mfp run**The **run** command starts the local test server. Run **mfp run** in the current working directory, which is a child of a MobileFirst project. This command does not return control to the command line. It displays new status messages from the server until the server is stopped. The **run** command takes no arguments. To run it, enter **\$ mfp run**.

**S:**

## **START**

Syntax: **mfp start**The **start** command starts the local test server. Run **mfp start** command in the current working directory, which is a child of a MobileFirst project. On completion, a message indicates that a successful start and control is returned to the command line. This command takes no arguments. To start the local test server, enter **\$ mfp start**.

## **STATUS**

Syntax: **mfp status**The **status** command shows the status of the local test server, either running or stopped. Run the command in the current working directory, which is a child of a MobileFirst project. This command takes no arguments. To run the command, enter **\$ mfp status**.

## **STOP**

Syntax: **mfp stop**The **stop** command stops the local test server. Run **mfp stop** command in the current working directory, which is a child of a MobileFirst project. This command takes no arguments. To run the command, enter **\$ mfp stop**.

## Commands

You can use IBM MobileFirst Platform Command Line Interface for iOS to create apps from the command line.

A:

### ADAPTER

Syntax: **mfp adapter [add|call]**

You can use the **adapter** command to manage your adapters on the MobileFirst Server.

### ADAPTER ADD

Syntax: **mfp adapter add [<name> --type|-t <type> [--jsonstore|-j] [--ussd|-u] [--package|-p <package>]**The **adapter add** command creates a new adapter, which is generated in the **adapters** folder of the current project.

If you run **adapter add** without any arguments, you are prompted for the following parameters:

**<name>**

The name that you want for the generated adapter.

**<type>**

The type of adapter. Valid values are: **castiron**, **http**, **java**, **jco**, **jms**, **sap**, and **sql**.

**[--jsonstore|-j]**

Your choice of JSONStore procedures. JSONStore procedures are not valid for JCo and Java adapters.

**[--ussd|-u]**

The option for the Unstructured Supplementary Service Data (USSD) communication technology.

**[--package|-p <package>]**

The name of the package that contains the Java adapter classes. Package option is valid only for Java adapters.

### ADAPTER CALL

Syntax: **mfp adapter call [<adapter>/<procedure> ["<arguments>"]]**

or

**mfp adapter call [<adapter>/<procedure> [--type|-t get|post] [--file|-f <args.json>]**

or

Syntax: **mfp adapter call [<adapter>/<procedure>**

**[--type|-t get|post]**

**[--form|-fp <form\_parameters>]**

**[--header|-h <header\_parameters>]**

**[--query|-q <query\_parameters>]**

]

The **adapter call** command calls an adapter's procedure on the MobileFirst Server. You can use "**FORM**, **HEADER**, and **QUERY** parameters" to call an adapter's procedure by using the direct mode. Add the flag for the parameter type and pass the object of parameters, if needed. For example:  
`--form "username:user" --header "password:pass" --query "date:01/01/2015".`

To use "**PATH** parameters" in direct mode, add them to the adapter/procedure path. Replace the `{pathParameter}` with the value that you want to send as the parameter. For example:

- Before: `myAdapter/users/{username}`. In this example, you must replace the `{username}` parameter.
- After: `myAdapter/users/StanLee`

**[--file|-f]**

The JSON file that contains the required arguments.

**[--type|-t]**

Indicates the request type: **GET** or **POST** are the valid options. If you are using Java adapters, the type also includes **PUT** and **DELETE**.

**Note:** If the **type** parameter is not defined, the `adapter call` command uses **GET** by default. Type cannot be passed in a JSON file.

**[--form|-fp]**

The form parameters to pass with the procedure. For Java Adapters and Direct Mode use only.

**[--header|-h]**

The header parameters to pass with the procedure. For Java Adapters and Direct Mode use only.

**[--query|-q]**

The query parameters to pass with the procedure. For Java Adapters and Direct Mode use only.

You can run the **adapter call** command by using one of the following methods.

- Interactive: `$ mfp adapter call`, then follow the prompts by using the arrow keys.
- Direct with no parameters: `$ mfp adapter call adapterName/procedure.`
- Direct with multiple parameters: `$ mfp adapter call adapterName/procedure "stringParameter", 2, true.`
- Direct with an array: `$ mfp adapter call adapterName/procedure ["stringParameter", 2, true`
- Direct with a JSON file parameter: `$ mfp adapter call adapterName/procedure --file ./myArgs.json`

JSON file

```
[
 "world"
]
```

JSON file for Java adapter

```
{
 "FORM":{"username":"user","password":"pass"},
 "QUERY":{"index":6},
 "HEADER":{"Date":"01/01/2015"}
}
```

- Direct with POST method: `$ mfp adapter call adapterName/procedure/{path_parameter} -fp "username:user1" --type post`
- Direct with Java adapter: `$ mfp adapter call "adapterName/procedure/{pathParameter with space}" --form "username:user" --header "Date:01/01/2015" --query "index=6" --type post`

## ADD

Syntax: `mfp add [adapter|api]` The `add` command generates new MobileFirst artifacts. The current working directory must be a child of an existing MobileFirst project. Generated artifacts go into the appropriate folder within the project, regardless of the current working directory. For example, adapters are generated to the `adapters` folder and native APIs are generated to the `apps` folder.

## ADD ADAPTER

Syntax: `mfp add adapter [<name> --type|-t <adapertertype> [--jsonstore|-j] [--ussd|-u] [--package|-p]]` This command is deprecated in V7.0.0. You can use the `adapter add` command instead. The `add adapter` command creates a new adapter, which is generated into the `adapters` folder of the current project.

If you run `add adapter` without any arguments, you are prompted for the following parameters:

### <name>

The name that you want for the generated adapter.

### <adapertertype>

The type of adapter. For example: HTTP, Cast Iron, SAP, JCo, or Java.

### [--jsonstore|-j]

Your choice of JSONStore procedures. JSONStore procedures are not valid for JCo and Java adapters.

### [--ussd|-u]

The option for the Unstructured Supplementary Service Data (USSD) communication technology.

### [--package|-p]

The name of the package that contains the Java adapter classes. Package option is valid only for Java adapters.

## ADD API

Syntax: `mfp add api [<name>]` The `add api` command generates a new native API into the `apps` folder of the current project. Run the command in the current working directory, which is a child of a MobileFirst project.

If you run `$ mfp add api` without any arguments, you are prompted for the following parameter:

### <name>

The name that you want for the generated native API.

B:

BD

Syntax: **mfp bd**The **bd** command builds and deploys to the local test server the set of MobileFirst resources that are most local to the current working directory. To run the **bd** command, navigate to the preferred folder and enter **\$ mfp bd**.

## BUILD

Syntax: **mfp build**The **build** command builds the set of MobileFirst resources that are most local to the current working directory.

To generate a build in the preferred folder, navigate to the folder and enter **\$ mfp build**.

- If you run the command from the root folder of a MobileFirst project, the command builds all the apps and adapters in the project.
- If you run the command from the apps folder, the command builds all the apps in the project.
- If you run the command from the folder of a specific adapter, the command builds that one adapter.

## C:

### CONFIG

Syntax: **mfp config [<setting>][<value>]**This command is a global command. Use the **config** command to set your configuration preferences, in particular which browser is used by CLI. To configure your preferences, you can use one of the following syntaxes:

- Interactive: Run **\$ mfp config** and follow the prompts by using the arrow keys.
- Direct with the **setting** parameter: **\$ mfp config [<setting>]**.
- Direct with the **setting** and **value** parameters: **\$ mfp config [<setting>] [<value>]**.

### CONSOLE

Syntax: **mfp console**This command is a global command. The **console** command opens the MobileFirst Operations Console in your default browser for the current project.

This command takes no parameters. To open the MobileFirst Operations Console, run: **\$ mfp console**.

### CREATE

Syntax: **mfp create [<name> --app|-a <app>]**This command is a global command. The **create** command creates a new MobileFirst project in the current working directory. This new project contains an iOS app in the apps folder. If you enter the command without any arguments, you are prompted for the name of the project and the name of the application. To generate a new MobileFirst project that is called MyProject, enter **\$ mfp create MyProject --app MyApp**.

### CREATE SERVER

Syntax: **mfp create-server**This command is a global command that does not need to be run manually because the built-in development server is automatically created and started as needed. The **create server** command creates a new WebSphere Application Server Liberty application server in your default folder. The server is preconfigured to work as a MobileFirst local test server. To run the command, enter **mfp create-server**. This command takes no arguments.



## D:

### DEPLOY

Syntax: **mfp deploy**The **deploy** command deploys to the local test server the set of MobileFirst resources that are found in the current working directory. To run the **deploy** command in the preferred folder, navigate to the folder and enter **\$ mfp deploy**.

- If you run the command from the root folder of a MobileFirst project, the command deploys all apps and adapters in the project.
- If you run the command from the apps folder, the command deploys all the apps in the project.
- If you run the command from the folder of a specific adapter, the command deploys that one adapter.
- If you run the command from the folder of a specific application, the command deploys that one application.

## H:

### HELP

Syntax: **mfp help** [**<command>**]This command is a global command. The **help** command displays either information about the general use of the CLI, or detailed help for each command.

- Information about the use of the CLI: **\$ mfp help**.
- Information about a specific command: **\$ mfp help invoke**.

## I:

### INFO

Syntax: **mfp info**The **info** command generates information about your environment. This information contains the operating system, the memory consumption on your machine, the node version, and the CLI version. If your current directory is a MobileFirst project, it also displays information about your project.

### INVOKE

Syntax: **mfp invoke** [**<adapter>:<procedure>**[\"**<json array>**\"]**|--file|-f <path to json array file>**]]This command is deprecated. You can use the **adapter call** command instead. The **invoke** command starts a procedure for a specified adapter on MobileFirst Server. Pass the arguments as a comma-separated list. If you enter the command with no arguments, you are prompted for an adapter and procedure, based on what is available in the current working directory of your project. You can run the command with one of the following syntaxes:

- Interactive: **\$ mfp invoke**, then follow the prompts by using the arrow keys.
- Direct with no parameters: **\$ mfp invoke adapterName:function**.
- Direct with a JSON array parameter: **\$ mfp invoke adapterName:function [\"string\", 2, true]**.
- Direct with a JSON file parameter: **\$ mfp invoke adapterName:function --file ./myArts.json**.

## L:

### LOGS

Syntax: **mfp logs**The **logs** command shows the path to the local test server logs. You can run the **logs** command from any directory. On completion, the path to the test server logs is displayed and control is returned to the command line. The **logs** command takes no arguments. To run it, enter **\$ mfp logs**.

**R:**

## **RESTART**

Syntax: **mfp restart**The **restart** command restarts the local test server. Run the **restart** command in the current working directory, which is a child of a MobileFirst project. On completion, a message indicates a successful start, and control is returned to the command line. This command takes no arguments. To run the **restart** command in the preferred folder, navigate to the folder and enter **\$ mfp restart**.

## **RUN**

Syntax: **mfp run**The **run** command starts the local test server. Run **mfp run** in the current working directory, which is a child of a MobileFirst project. This command does not return control to the command line. It displays new status messages from the server until the server is stopped. The **run** command takes no arguments. To run it, enter **\$ mfp run**.

**S:**

## **START**

Syntax: **mfp start**The **start** command starts the local test server. Run **mfp start** command in the current working directory, which is a child of a MobileFirst project. On completion, a message indicates that a successful start and control is returned to the command line. This command takes no arguments. To start the local test server, enter **\$ mfp start**.

## **STATUS**

Syntax: **mfp status**The **status** command shows the status of the local test server, either running or stopped. Run the command in the current working directory, which is a child of a MobileFirst project. This command takes no arguments. To run the command, enter **\$ mfp status**.

## **STOP**

Syntax: **mfp stop**The **stop** command stops the local test server. Run **mfp stop** command in the current working directory, which is a child of a MobileFirst project. This command takes no arguments. To run the command, enter **\$ mfp stop**.

## **Commands**

You can use IBM MobileFirst Platform Command Line Interface for iOS to create apps from the command line.

**A:**

## **ADAPTER**

Syntax: **mfp adapter [add|call]**

You can use the **adapter** command to manage your adapters on the MobileFirst Server.

## **ADAPTER ADD**

Syntax: `mfp adapter add [<name> --type|-t <type> [--jsonstore|-j] [--ussd|-u] [--package|-p <package>]` The `adapter add` command creates a new adapter, which is generated in the `adapters` folder of the current project.

If you run `adapter add` without any arguments, you are prompted for the following parameters:

**<name>**

The name that you want for the generated adapter.

**<type>**

The type of adapter. Valid values are: **castiron**, **http**, **java**, **jco**, **jms**, **sap**, and **sql**.

**[--jsonstore|-j]**

Your choice of JSONStore procedures. JSONStore procedures are not valid for JCo and Java adapters.

**[--ussd|-u]**

The option for the Unstructured Supplementary Service Data (USSD) communication technology.

**[--package|-p <package>]**

The name of the package that contains the Java adapter classes. Package option is valid only for Java adapters.

## ADAPTER CALL

Syntax: `mfp adapter call [<adapter>/<procedure> ["<arguments>"]]`

or

`mfp adapter call [<adapter>/<procedure> [--type|-t get|post] [--file|-f <args.json>]`

or

Syntax: `mfp adapter call [<adapter>/<procedure>`

`[--type|-t get|post]`

`[--form|-fp <form_parameters>]`

`[--header|-h <header_parameters>]`

`[--query|-q <query_parameters>]`

`]`

The `adapter call` command calls an adapter's procedure on the MobileFirst Server. You can use "**FORM**, **HEADER**, and **QUERY** parameters" to call an adapter's procedure by using the direct mode. Add the flag for the parameter type and pass the object of parameters, if needed. For example: `--form "username:user" --header "password:pass" --query "date:01/01/2015"`.

To use "**PATH** parameters" in direct mode, add them to the adapter/procedure path. Replace the `{pathParameter}` with the value that you want to send as the parameter. For example:

- Before: `myAdapter/users/{username}`. In this example, you must replace the `{username}` parameter.
- After: `myAdapter/users/StanLee`

**[--file|-f]**

The JSON file that contains the required arguments.

**[--type|-t]**

Indicates the request type: **GET** or **POST** are the valid options. If you are using Java adapters, the type also includes **PUT** and **DELETE**.

**Note:** If the **type** parameter is not defined, the adapter call command uses **GET** by default. Type cannot be passed in a JSON file.

**[--form|-fp]**

The form parameters to pass with the procedure. For Java Adapters and Direct Mode use only.

**[--header|-h]**

The header parameters to pass with the procedure. For Java Adapters and Direct Mode use only.

**[--query|-q]**

The query parameters to pass with the procedure. For Java Adapters and Direct Mode use only.

You can run the **adapter call** command by using one of the following methods.

- Interactive: **\$ mfp adapter call**, then follow the prompts by using the arrow keys.
- Direct with no parameters: **\$ mfp adapter call adapterName/procedure.**
- Direct with multiple parameters: **\$ mfp adapter call adapterName/procedure "stringParameter", 2, true.**
- Direct with an array: **\$ mfp adapter call adapterName/procedure ["stringParameter", 2, true**
- Direct with a JSON file parameter: **\$ mfp adapter call adapterName/procedure --file ./myArgs.json**

JSON file

```
[
 "world"
]
```

JSON file for Java adapter

```
{
 "FORM":{"username":"user","password":"pass"},
 "QUERY":{"index":6},
 "HEADER":{"Date":"01/01/2015"}
}
```

- Direct with POST method: **\$ mfp adapter call adapterName/procedure/{path\_parameter} -fp "username:user1" --type post**
- Direct with Java adapter: **\$ mfp adapter call "adapterName/procedure/{pathParameter with space}" --form "username:user" --header "Date:01/01/2015" --query "index=6" --type post**

**ADD**

Syntax: **mfp add [adapter|api]** The **add** command generates new MobileFirst artifacts. The current working directory must be a child of an existing MobileFirst project. Generated artifacts go into the appropriate folder within the project, regardless of the current working directory. For example, adapters are generated to the adapters folder and native APIs are generated to the apps folder.

## ADD ADAPTER

Syntax: **mfp add adapter** [**<name>** **--type|-t <adapertype>** **--jsonstore|-j** **--ussd|-u** **--package|-p**] This command is deprecated in V7.0.0. You can use the **adapter add** command instead. The **add adapter** command creates a new adapter, which is generated into the **adapters** folder of the current project.

If you run **add adapter** without any arguments, you are prompted for the following parameters:

**<name>**

The name that you want for the generated adapter.

**<adapertype>**

The type of adapter. For example: HTTP, Cast Iron, SAP, JCo, or Java.

**--jsonstore|-j**

Your choice of JSONStore procedures. JSONStore procedures are not valid for JCo and Java adapters.

**--ussd|-u**

The option for the Unstructured Supplementary Service Data (USSD) communication technology.

**--package|-p**

The name of the package that contains the Java adapter classes. Package option is valid only for Java adapters.

## ADD API

Syntax: **mfp add api** [**<name>**] The **add api** command generates a new native API into the **apps** folder of the current project. Run the command in the current working directory, which is a child of a MobileFirst project.

If you run **\$ mfp add api** without any arguments, you are prompted for the following parameter:

**<name>**

The name that you want for the generated native API.

## B:

## BD

Syntax: **mfp bd** The **bd** command builds and deploys to the local test server the set of MobileFirst resources that are most local to the current working directory. To run the **bd** command, navigate to the preferred folder and enter **\$ mfp bd**.

## BUILD

Syntax: **mfp build** The **build** command builds the set of MobileFirst resources that are most local to the current working directory.

To generate a build in the preferred folder, navigate to the folder and enter **\$ mfp build**.

- If you run the command from the root folder of a MobileFirst project, the command builds all the apps and adapters in the project.
- If you run the command from the **apps** folder, the command builds all the apps in the project.
- If you run the command from the folder of a specific adapter, the command builds that one adapter.

## C:

### CONFIG

Syntax: **mfp config** [**<setting>**][**<value>**] This command is a global command. Use the **config** command to set your configuration preferences, in particular which browser is used by CLI. To configure your preferences, you can use one of the following syntaxes:

- Interactive: Run **\$ mfp config** and follow the prompts by using the arrow keys.
- Direct with the **setting** parameter: **\$ mfp config** [**<setting>**].
- Direct with the **setting** and **value** parameters: **\$ mfp config** [**<setting>**] [**<value>**].

### CONSOLE

Syntax: **mfp console** This command is a global command. The **console** command opens the MobileFirst Operations Console in your default browser for the current project.

This command takes no parameters. To open the MobileFirst Operations Console, run: **\$ mfp console**.

### CREATE

Syntax: **mfp create** [**<name>** **--app**|-**a** **<app>**] This command is a global command. The **create** command creates a new MobileFirst project in the current working directory. This new project contains an iOS app in the apps folder. If you enter the command without any arguments, you are prompted for the name of the project and the name of the application. To generate a new MobileFirst project that is called MyProject, enter **\$ mfp create MyProject --app MyApp**.

### CREATE SERVER

Syntax: **mfp create-server** This command is a global command that does not need to be run manually because the built-in development server is automatically created and started as needed. The **create server** command creates a new WebSphere Application Server Liberty application server in your default folder. The server is preconfigured to work as a MobileFirst local test server. To run the command, enter **mfp create-server**. This command takes no arguments.

## D:

### DEPLOY

Syntax: **mfp deploy** The **deploy** command deploys to the local test server the set of MobileFirst resources that are found in the current working directory. To run the **deploy** command in the preferred folder, navigate to the folder and enter **\$ mfp deploy**.

- If you run the command from the root folder of a MobileFirst project, the command deploys all apps and adapters in the project.
- If you run the command from the apps folder, the command deploys all the apps in the project.
- If you run the command from the folder of a specific adapter, the command deploys that one adapter.
- If you run the command from the folder of a specific application, the command deploys that one application.

## H:

### HELP

Syntax: **mfp help** [**<command>**]This command is a global command. The **help** command displays either information about the general use of the CLI, or detailed help for each command.

- Information about the use of the CLI: **\$ mfp help**.
- Information about a specific command: **\$ mfp help invoke**.

## I:

### INFO

Syntax: **mfp info**The **info** command generates information about your environment. This information contains the operating system, the memory consumption on your machine, the node version, and the CLI version. If your current directory is a MobileFirst project, it also displays information about your project.

### INVOKE

Syntax: **mfp invoke** [**<adapter>:<procedure>**[\"**<json array>**\"**|--file|-f <path to json array file>**]]This command is deprecated. You can use the **adapter call** command instead. The **invoke** command starts a procedure for a specified adapter on MobileFirst Server. Pass the arguments as a comma-separated list. If you enter the command with no arguments, you are prompted for an adapter and procedure, based on what is available in the current working directory of your project. You can run the command with one of the following syntaxes:

- Interactive: **\$ mfp invoke**, then follow the prompts by using the arrow keys.
- Direct with no parameters: **\$ mfp invoke adapterName:function**.
- Direct with a JSON array parameter: **\$ mfp invoke adapterName:function [\"string\", 2, true]**.
- Direct with a JSON file parameter: **\$ mfp invoke adapterName:function --file ./myArts.json**.

## L:

### LOGS

Syntax: **mfp logs**The **logs** command shows the path to the local test server logs. You can run the **logs** command from any directory. On completion, the path to the test server logs is displayed and control is returned to the command line. The **logs** command takes no arguments. To run it, enter **\$ mfp logs**.

## R:

### RESTART

Syntax: **mfp restart**The **restart** command restarts the local test server. Run the **restart** command in the current working directory, which is a child of a MobileFirst project. On completion, a message indicates a successful start, and control is returned to the command line. This command takes no arguments. To run the **restart** command in the preferred folder, navigate to the folder and enter **\$ mfp restart**.

## RUN

Syntax: **mfp run**The **run** command starts the local test server. Run **mfp run** in the current working directory, which is a child of a MobileFirst project. This command does not return control to the command line. It displays new status messages from the server until the server is stopped. The **run** command takes no arguments. To run it, enter **\$ mfp run**.

S:

## START

Syntax: **mfp start**The **start** command starts the local test server. Run **mfp start** command in the current working directory, which is a child of a MobileFirst project. On completion, a message indicates that a successful start and control is returned to the command line. This command takes no arguments. To start the local test server, enter **\$ mfp start**.

## STATUS

Syntax: **mfp status**The **status** command shows the status of the local test server, either running or stopped. Run the command in the current working directory, which is a child of a MobileFirst project. This command takes no arguments. To run the command, enter **\$ mfp status**.

## STOP

Syntax: **mfp stop**The **stop** command stops the local test server. Run **mfp stop** command in the current working directory, which is a child of a MobileFirst project. This command takes no arguments. To run the command, enter **\$ mfp stop**.

## Commands

You can use IBM MobileFirst Platform Command Line Interface for iOS to create apps from the command line.

A:

## ADAPTER

Syntax: **mfp adapter [add|call]**

You can use the **adapter** command to manage your adapters on the MobileFirst Server.

## ADAPTER ADD

Syntax: **mfp adapter add [<name> --type|-t <type> [--jsonstore|-j] [--ussd|-u] [--package|-p <package>]**The **adapter add** command creates a new adapter, which is generated in the **adapters** folder of the current project.

If you run **adapter add** without any arguments, you are prompted for the following parameters:

**<name>**

The name that you want for the generated adapter.

**<type>**

The type of adapter. Valid values are: **castiron**, **http**, **java**, **jco**, **jms**, **sap**, and **sql**.

**[--jsonstore|-j]**

Your choice of JSONStore procedures. JSONStore procedures are not valid for JCo and Java adapters.



**[--ussd|-u]**

The option for the Unstructured Supplementary Service Data (USSD) communication technology.

**[--package|-p <package>]**

The name of the package that contains the Java adapter classes. Package option is valid only for Java adapters.

## ADAPTER CALL

Syntax: **mfp adapter call** [<adapter>/<procedure> ["<arguments>"]]

or

**mfp adapter call** [<adapter>/<procedure> [--type|-t get|post] [--file|-f <args.json>]]

or

Syntax: **mfp adapter call** [<adapter>/<procedure>

**[--type|-t get|post]**

**[--form|-fp <form\_parameters>]**

**[--header|-h <header\_parameters>]**

**[--query|-q <query\_parameters>]**

**]**

The **adapter call** command calls an adapter's procedure on the MobileFirst Server. You can use "**FORM**, **HEADER**, and **QUERY** parameters" to call an adapter's procedure by using the direct mode. Add the flag for the parameter type and pass the object of parameters, if needed. For example: `--form "username:user" --header "password:pass" --query "date:01/01/2015"`.

To use "**PATH** parameters" in direct mode, add them to the adapter/procedure path. Replace the **{pathParameter}** with the value that you want to send as the parameter. For example:

- Before: `myAdapter/users/{username}`. In this example, you must replace the `{username}` parameter.
- After: `myAdapter/users/StanLee`

**[--file|-f]**

The JSON file that contains the required arguments.

**[--type|-t]**

Indicates the request type: **GET** or **POST** are the valid options. If you are using Java adapters, the type also includes **PUT** and **DELETE**.

**Note:** If the **type** parameter is not defined, the `adapter call` command uses **GET** by default. Type cannot be passed in a JSON file.

**[--form|-fp]**

The form parameters to pass with the procedure. For Java Adapters and Direct Mode use only.

**[--header|-h]**

The header parameters to pass with the procedure. For Java Adapters and Direct Mode use only.

### **[--query|-q]**

The query parameters to pass with the procedure. For Java Adapters and Direct Mode use only.

You can run the **adapter call** command by using one of the following methods.

- Interactive: **\$ mfp adapter call**, then follow the prompts by using the arrow keys.
- Direct with no parameters: **\$ mfp adapter call adapterName/procedure**.
- Direct with multiple parameters: **\$ mfp adapter call adapterName/procedure "stringParameter", 2, true**.
- Direct with an array: **\$ mfp adapter call adapterName/procedure ["stringParameter", 2, true**
- Direct with a JSON file parameter: **\$ mfp adapter call adapterName/procedure --file ./myArgs.json**

JSON file

```
[
 "world"
]
```

JSON file for Java adapter

```
{
 "FORM":{"username":"user","password":"pass"},
 "QUERY":{"index":6},
 "HEADER":{"Date":"01/01/2015"}
}
```

- Direct with POST method: **\$ mfp adapter call adapterName/procedure/{path\_parameter} -fp "username:user1" --type post**
- Direct with Java adapter: **\$ mfp adapter call "adapterName/procedure/{pathParameter with space}" --form "username:user" --header "Date:01/01/2015" --query "index=6" --type post**

## **ADD**

Syntax: **mfp add [adapter|api]** The **add** command generates new MobileFirst artifacts. The current working directory must be a child of an existing MobileFirst project. Generated artifacts go into the appropriate folder within the project, regardless of the current working directory. For example, adapters are generated to the adapters folder and native APIs are generated to the apps folder.

## **ADD ADAPTER**

Syntax: **mfp add adapter [<name> --type|-t <adapertype> [--jsonstore|-j] [--ussd|-u] [--package|-p]]** This command is deprecated in V7.0.0. You can use the **adapter add** command instead. The **add adapter** command creates a new adapter, which is generated into the **adapters** folder of the current project.

If you run **add adapter** without any arguments, you are prompted for the following parameters:

**<name>**

The name that you want for the generated adapter.

**<adapertype>**

The type of adapter. For example: HTTP, Cast Iron, SAP, JCo, or Java.

**[--jsonstore|-j]**

Your choice of JSONStore procedures. JSONStore procedures are not valid for JCo and Java adapters.

**[--ussd|-u]**

The option for the Unstructured Supplementary Service Data (USSD) communication technology.

**[--package|-p]**

The name of the package that contains the Java adapter classes. Package option is valid only for Java adapters.

**ADD API**

Syntax: **mfp add api [<name>]**The **add api** command generates a new native API into the apps folder of the current project. Run the command in the current working directory, which is a child of a MobileFirst project.

If you run **\$ mfp add api** without any arguments, you are prompted for the following parameter:

**<name>**

The name that you want for the generated native API.

**B:****BD**

Syntax: **mfp bd**The **bd** command builds and deploys to the local test server the set of MobileFirst resources that are most local to the current working directory. To run the **bd** command, navigate to the preferred folder and enter **\$ mfp bd**.

**BUILD**

Syntax: **mfp build**The **build** command builds the set of MobileFirst resources that are most local to the current working directory.

To generate a build in the preferred folder, navigate to the folder and enter **\$ mfp build**.

- If you run the command from the root folder of a MobileFirst project, the command builds all the apps and adapters in the project.
- If you run the command from the apps folder, the command builds all the apps in the project.
- If you run the command from the folder of a specific adapter, the command builds that one adapter.

**C:****CONFIG**

Syntax: **mfp config [<setting>][<value>]**This command is a global command. Use the **config** command to set your configuration preferences, in particular which browser is used by CLI. To configure your preferences, you can use one of the following syntaxes:

- Interactive: Run **\$ mfp config** and follow the prompts by using the arrow keys.
- Direct with the **setting** parameter: **\$ mfp config [<setting>]**.
- Direct with the **setting** and **value** parameters: **\$ mfp config [<setting>] [<value>]**.

**CONSOLE**

Syntax: **mfp console**This command is a global command. The **console** command opens the MobileFirst Operations Console in your default browser for the current project.

This command takes no parameters. To open the MobileFirst Operations Console, run: **\$ mfp console**.

## CREATE

Syntax: **mfp create** [**<name>** **--app** | **-a** **<app>**]This command is a global command. The **create** command creates a new MobileFirst project in the current working directory. This new project contains an iOS app in the apps folder. If you enter the command without any arguments, you are prompted for the name of the project and the name of the application. To generate a new MobileFirst project that is called MyProject, enter **\$ mfp create MyProject --app MyApp**.

## CREATE SERVER

Syntax: **mfp create-server**This command is a global command that does not need to be run manually because the built-in development server is automatically created and started as needed. The **create server** command creates a new WebSphere Application Server Liberty application server in your default folder. The server is preconfigured to work as a MobileFirst local test server. To run the command, enter **mfp create-server**. This command takes no arguments.

## D:

## DEPLOY

Syntax: **mfp deploy**The **deploy** command deploys to the local test server the set of MobileFirst resources that are found in the current working directory. To run the **deploy** command in the preferred folder, navigate to the folder and enter **\$ mfp deploy**.

- If you run the command from the root folder of a MobileFirst project, the command deploys all apps and adapters in the project.
- If you run the command from the apps folder, the command deploys all the apps in the project.
- If you run the command from the folder of a specific adapter, the command deploys that one adapter.
- If you run the command from the folder of a specific application, the command deploys that one application.

## H:

## HELP

Syntax: **mfp help** [**<command>**]This command is a global command. The **help** command displays either information about the general use of the CLI, or detailed help for each command.

- Information about the use of the CLI: **\$ mfp help**.
- Information about a specific command: **\$ mfp help invoke**.

## I:

## INFO

Syntax: **mfp info**The **info** command generates information about your environment. This information contains the operating system, the memory

consumption on your machine, the node version, and the CLI version. If your current directory is a MobileFirst project, it also displays information about your project.

## INVOKE

Syntax: **mfp invoke** [**<adapter>:<procedure>**[\"**<json array>**\"]**--file|-f <path to json array file>**]] This command is deprecated. You can use the **adapter call** command instead. The **invoke** command starts a procedure for a specified adapter on MobileFirst Server. Pass the arguments as a comma-separated list. If you enter the command with no arguments, you are prompted for an adapter and procedure, based on what is available in the current working directory of your project. You can run the command with one of the following syntaxes:

- Interactive: **\$ mfp invoke**, then follow the prompts by using the arrow keys.
- Direct with no parameters: **\$ mfp invoke adapterName:function**.
- Direct with a JSON array parameter: **\$ mfp invoke adapterName:function [\"string\", 2, true]**.
- Direct with a JSON file parameter: **\$ mfp invoke adapterName:function --file ./myArts.json**.

## L:

## LOGS

Syntax: **mfp logs** The **logs** command shows the path to the local test server logs. You can run the **logs** command from any directory. On completion, the path to the test server logs is displayed and control is returned to the command line. The **logs** command takes no arguments. To run it, enter **\$ mfp logs**.

## R:

## RESTART

Syntax: **mfp restart** The **restart** command restarts the local test server. Run the **restart** command in the current working directory, which is a child of a MobileFirst project. On completion, a message indicates a successful start, and control is returned to the command line. This command takes no arguments. To run the **restart** command in the preferred folder, navigate to the folder and enter **\$ mfp restart**.

## RUN

Syntax: **mfp run** The **run** command starts the local test server. Run **mfp run** in the current working directory, which is a child of a MobileFirst project. This command does not return control to the command line. It displays new status messages from the server until the server is stopped. The **run** command takes no arguments. To run it, enter **\$ mfp run**.

## S:

## START

Syntax: **mfp start** The **start** command starts the local test server. Run **mfp start** command in the current working directory, which is a child of a MobileFirst project. On completion, a message indicates that a successful start and control is returned to the command line. This command takes no arguments. To start the local test server, enter **\$ mfp start**.

## STATUS

Syntax: **mfp status**The **status** command shows the status of the local test server, either running or stopped. Run the command in the current working directory, which is a child of a MobileFirst project. This command takes no arguments. To run the command, enter **\$ mfp status**.

## STOP

Syntax: **mfp stop**The **stop** command stops the local test server. Run **mfp stop** command in the current working directory, which is a child of a MobileFirst project. This command takes no arguments. To run the command, enter **\$ mfp stop**.

## Commands

You can use IBM MobileFirst Platform Command Line Interface for iOS to create apps from the command line.

### A:

## ADAPTER

Syntax: **mfp adapter [add|call]**

You can use the **adapter** command to manage your adapters on the MobileFirst Server.

## ADAPTER ADD

Syntax: **mfp adapter add [<name> --type|-t <type> [--jsonstore|-j] [--ussd|-u] [--package|-p <package>]**The **adapter add** command creates a new adapter, which is generated in the **adapters** folder of the current project.

If you run **adapter add** without any arguments, you are prompted for the following parameters:

### <name>

The name that you want for the generated adapter.

### <type>

The type of adapter. Valid values are: **castiron**, **http**, **java**, **jco**, **jms**, **sap**, and **sql**.

### [--jsonstore|-j]

Your choice of JSONStore procedures. JSONStore procedures are not valid for JCo and Java adapters.

### [--ussd|-u]

The option for the Unstructured Supplementary Service Data (USSD) communication technology.

### [--package|-p <package>]

The name of the package that contains the Java adapter classes. Package option is valid only for Java adapters.

## ADAPTER CALL

Syntax: **mfp adapter call [<adapter>/<procedure> ["<arguments>"]]**

or

**mfp adapter call [<adapter>/<procedure> [--type|-t get|post] [--file|-f <args.json>]**

or

Syntax: **mfp adapter call** [<adapter>/<procedure>

**[--type|-t get|post]**

**[--form|-fp <form\_parameters>]**

**[--header|-h <header\_parameters>]**

**[--query|-q <query\_parameters>]**

]

The **adapter call** command calls an adapter's procedure on the MobileFirst Server. You can use "**FORM**, **HEADER**, and **QUERY** parameters" to call an adapter's procedure by using the direct mode. Add the flag for the parameter type and pass the object of parameters, if needed. For example: `--form "username:user" --header "password:pass" --query "date:01/01/2015"`.

To use "**PATH** parameters" in direct mode, add them to the adapter/procedure path. Replace the {**pathParameter**} with the value that you want to send as the parameter. For example:

- Before: `myAdapter/users/{username}`. In this example, you must replace the {**username**} parameter.
- After: `myAdapter/users/StanLee`

**[--file|-f]**

The JSON file that contains the required arguments.

**[--type|-t]**

Indicates the request type: **GET** or **POST** are the valid options. If you are using Java adapters, the type also includes **PUT** and **DELETE**.

**Note:** If the **type** parameter is not defined, the adapter call command uses **GET** by default. Type cannot be passed in a JSON file.

**[--form|-fp]**

The form parameters to pass with the procedure. For Java Adapters and Direct Mode use only.

**[--header|-h]**

The header parameters to pass with the procedure. For Java Adapters and Direct Mode use only.

**[--query|-q]**

The query parameters to pass with the procedure. For Java Adapters and Direct Mode use only.

You can run the **adapter call** command by using one of the following methods.

- Interactive: `$ mfp adapter call`, then follow the prompts by using the arrow keys.
- Direct with no parameters: `$ mfp adapter call adapterName/procedure`.
- Direct with multiple parameters: `$ mfp adapter call adapterName/procedure "stringParameter", 2, true`.
- Direct with an array: `$ mfp adapter call adapterName/procedure ["stringParameter", 2, true`
- Direct with a JSON file parameter: `$ mfp adapter call adapterName/procedure --file ./myArgs.json`  
JSON file

```
[
 "world"
]
```

JSON file for Java adapter

```
{
 "FORM":{"username":"user","password":"pass"},
 "QUERY":{"index":6},
 "HEADER":{"Date":"01/01/2015"}
}
```

- Direct with POST method: **\$ mfp adapter call adapterName/procedure/{path\_parameter} -fp "username:user1" --type post**
- Direct with Java adapter: **\$ mfp adapter call "adapterName/procedure/{pathParameter with space}" --form "username:user" --header "Date:01/01/2015" --query "index=6" --type post**

## ADD

Syntax: **mfp add [adapter|api]** The **add** command generates new MobileFirst artifacts. The current working directory must be a child of an existing MobileFirst project. Generated artifacts go into the appropriate folder within the project, regardless of the current working directory. For example, adapters are generated to the adapters folder and native APIs are generated to the apps folder.

## ADD ADAPTER

Syntax: **mfp add adapter [<name> --type|-t <adaptype> [--jsonstore|-j] [--ussd|-u] [--package|-p]]** This command is deprecated in V7.0.0. You can use the **adapter add** command instead. The **add adapter** command creates a new adapter, which is generated into the **adapters** folder of the current project.

If you run **add adapter** without any arguments, you are prompted for the following parameters:

### <name>

The name that you want for the generated adapter.

### <adaptype>

The type of adapter. For example: HTTP, Cast Iron, SAP, JCo, or Java.

### [--jsonstore|-j]

Your choice of JSONStore procedures. JSONStore procedures are not valid for JCo and Java adapters.

### [--ussd|-u]

The option for the Unstructured Supplementary Service Data (USSD) communication technology.

### [--package|-p]

The name of the package that contains the Java adapter classes. Package option is valid only for Java adapters.

## ADD API

Syntax: **mfp add api [<name>]** The **add api** command generates a new native API into the apps folder of the current project. Run the command in the current working directory, which is a child of a MobileFirst project.

If you run **\$ mfp add api** without any arguments, you are prompted for the following parameter:



**<name>**

The name that you want for the generated native API.

**B:**

**BD**

Syntax: **mfp bd**The **bd** command builds and deploys to the local test server the set of MobileFirst resources that are most local to the current working directory. To run the **bd** command, navigate to the preferred folder and enter **\$ mfp bd**.

**BUILD**

Syntax: **mfp build**The **build** command builds the set of MobileFirst resources that are most local to the current working directory.

To generate a build in the preferred folder, navigate to the folder and enter **\$ mfp build**.

- If you run the command from the root folder of a MobileFirst project, the command builds all the apps and adapters in the project.
- If you run the command from the apps folder, the command builds all the apps in the project.
- If you run the command from the folder of a specific adapter, the command builds that one adapter.

**C:**

**CONFIG**

Syntax: **mfp config [<setting>][<value>]**This command is a global command. Use the **config** command to set your configuration preferences, in particular which browser is used by CLI. To configure your preferences, you can use one of the following syntaxes:

- Interactive: Run **\$ mfp config** and follow the prompts by using the arrow keys.
- Direct with the **setting** parameter: **\$ mfp config [<setting>]**.
- Direct with the **setting** and **value** parameters: **\$ mfp config [<setting>] [<value>]**.

**CONSOLE**

Syntax: **mfp console**This command is a global command. The **console** command opens the MobileFirst Operations Console in your default browser for the current project.

This command takes no parameters. To open the MobileFirst Operations Console, run: **\$ mfp console**.

**CREATE**

Syntax: **mfp create [<name> --app|-a <app>]**This command is a global command. The **create** command creates a new MobileFirst project in the current working directory. This new project contains an iOS app in the apps folder. If you enter the command without any arguments, you are prompted for the name of the project and the name of the application. To generate a new MobileFirst project that is called MyProject, enter **\$ mfp create MyProject --app MyApp**.

**CREATE SERVER**

Syntax: **mfp create-server**This command is a global command that does not need to be run manually because the built-in development server is automatically created and started as needed. The **create server** command creates a new WebSphere Application Server Liberty application server in your default folder. The server is preconfigured to work as a MobileFirst local test server. To run the command, enter **mfp create-server**. This command takes no arguments.

## D:

### DEPLOY

Syntax: **mfp deploy**The **deploy** command deploys to the local test server the set of MobileFirst resources that are found in the current working directory. To run the **deploy** command in the preferred folder, navigate to the folder and enter **\$ mfp deploy**.

- If you run the command from the root folder of a MobileFirst project, the command deploys all apps and adapters in the project.
- If you run the command from the apps folder, the command deploys all the apps in the project.
- If you run the command from the folder of a specific adapter, the command deploys that one adapter.
- If you run the command from the folder of a specific application, the command deploys that one application.

## H:

### HELP

Syntax: **mfp help [<command>]**This command is a global command. The **help** command displays either information about the general use of the CLI, or detailed help for each command.

- Information about the use of the CLI: **\$ mfp help**.
- Information about a specific command: **\$ mfp help invoke**.

## I:

### INFO

Syntax: **mfp info**The **info** command generates information about your environment. This information contains the operating system, the memory consumption on your machine, the node version, and the CLI version. If your current directory is a MobileFirst project, it also displays information about your project.

### INVOKE

Syntax: **mfp invoke [<adapter>:<procedure>[\"<json array>\"|**--file**|-f <path to json array file>]]**This command is deprecated. You can use the **adapter call** command instead. The **invoke** command starts a procedure for a specified adapter on MobileFirst Server. Pass the arguments as a comma-separated list. If you enter the command with no arguments, you are prompted for an adapter and procedure, based on what is available in the current working directory of your project. You can run the command with one of the following syntaxes:

- Interactive: **\$ mfp invoke**, then follow the prompts by using the arrow keys.
- Direct with no parameters: **\$ mfp invoke adapterName:function**.

- Direct with a JSON array parameter: **\$ mfp invoke adapterName:function ["string", 2, true]**.
- Direct with a JSON file parameter: **\$ mfp invoke adapterName:function --file ./myArts.json**.

**L:**

## LOGS

Syntax: **mfp logs**The **logs** command shows the path to the local test server logs. You can run the **logs** command from any directory. On completion, the path to the test server logs is displayed and control is returned to the command line. The **logs** command takes no arguments. To run it, enter **\$ mfp logs**.

**R:**

## RESTART

Syntax: **mfp restart**The **restart** command restarts the local test server. Run the **restart** command in the current working directory, which is a child of a MobileFirst project. On completion, a message indicates a successful start, and control is returned to the command line. This command takes no arguments. To run the **restart** command in the preferred folder, navigate to the folder and enter **\$ mfp restart**.

## RUN

Syntax: **mfp run**The **run** command starts the local test server. Run **mfp run** in the current working directory, which is a child of a MobileFirst project. This command does not return control to the command line. It displays new status messages from the server until the server is stopped. The **run** command takes no arguments. To run it, enter **\$ mfp run**.

**S:**

## START

Syntax: **mfp start**The **start** command starts the local test server. Run **mfp start** command in the current working directory, which is a child of a MobileFirst project. On completion, a message indicates that a successful start and control is returned to the command line. This command takes no arguments. To start the local test server, enter **\$ mfp start**.

## STATUS

Syntax: **mfp status**The **status** command shows the status of the local test server, either running or stopped. Run the command in the current working directory, which is a child of a MobileFirst project. This command takes no arguments. To run the command, enter **\$ mfp status**.

## STOP

Syntax: **mfp stop**The **stop** command stops the local test server. Run **mfp stop** command in the current working directory, which is a child of a MobileFirst project. This command takes no arguments. To run the command, enter **\$ mfp stop**.

## Commands

You can use IBM MobileFirst Platform Command Line Interface for iOS to create apps from the command line.

A:

## ADAPTER

Syntax: **mfp adapter [add|call]**

You can use the **adapter** command to manage your adapters on the MobileFirst Server.

## ADAPTER ADD

Syntax: **mfp adapter add [<name> --type|-t <type> [--jsonstore|-j] [--ussd|-u] [--package|-p <package>]** The **adapter add** command creates a new adapter, which is generated in the **adapters** folder of the current project.

If you run **adapter add** without any arguments, you are prompted for the following parameters:

**<name>**

The name that you want for the generated adapter.

**<type>**

The type of adapter. Valid values are: **castiron**, **http**, **java**, **jco**, **jms**, **sap**, and **sql**.

**[--jsonstore|-j]**

Your choice of JSONStore procedures. JSONStore procedures are not valid for JCo and Java adapters.

**[--ussd|-u]**

The option for the Unstructured Supplementary Service Data (USSD) communication technology.

**[--package|-p <package>]**

The name of the package that contains the Java adapter classes. Package option is valid only for Java adapters.

## ADAPTER CALL

Syntax: **mfp adapter call [<adapter>/<procedure> ["<arguments>"]]**

or

**mfp adapter call [<adapter>/<procedure> [--type|-t get|post] [--file|-f <args.json>]**

or

Syntax: **mfp adapter call [<adapter>/<procedure>**

**[--type|-t get|post]**

**[--form|-fp <form\_parameters>]**

**[--header|-h <header\_parameters>]**

**[--query|-q <query\_parameters>]**

**]**

The **adapter call** command calls an adapter's procedure on the MobileFirst Server. You can use "**FORM**", "**HEADER**", and "**QUERY**" parameters" to call an adapter's procedure by using the direct mode. Add the flag for the parameter type and pass the object of parameters, if needed. For example:  
**--form "username:user" --header "password:pass" --query "date:01/01/2015".**

To use "PATH parameters" in direct mode, add them to the adapter/procedure path. Replace the {**pathParameter**} with the value that you want to send as the parameter. For example:

- Before: **myAdapter/users/{username}**. In this example, you must replace the {**username**} parameter.
- After: **myAdapter/users/StanLee**

**[--file|-f]**

The JSON file that contains the required arguments.

**[--type|-t]**

Indicates the request type: **GET** or **POST** are the valid options. If you are using Java adapters, the type also includes **PUT** and **DELETE**.

**Note:** If the **type** parameter is not defined, the adapter call command uses **GET** by default. Type cannot be passed in a JSON file.

**[--form|-fp]**

The form parameters to pass with the procedure. For Java Adapters and Direct Mode use only.

**[--header|-h]**

The header parameters to pass with the procedure. For Java Adapters and Direct Mode use only.

**[--query|-q]**

The query parameters to pass with the procedure. For Java Adapters and Direct Mode use only.

You can run the **adapter call** command by using one of the following methods.

- Interactive: **\$ mfp adapter call**, then follow the prompts by using the arrow keys.
- Direct with no parameters: **\$ mfp adapter call adapterName/procedure**.
- Direct with multiple parameters: **\$ mfp adapter call adapterName/procedure "stringParameter", 2, true**.
- Direct with an array: **\$ mfp adapter call adapterName/procedure ["stringParameter", 2, true**
- Direct with a JSON file parameter: **\$ mfp adapter call adapterName/procedure --file ./myArgs.json**

JSON file

```
[
 "world"
]
```

JSON file for Java adapter

```
{
 "FORM":{"username":"user","password":"pass"},
 "QUERY":{"index":6},
 "HEADER":{"Date":"01/01/2015"}
}
```

- Direct with POST method: **\$ mfp adapter call adapterName/procedure/{path\_parameter} -fp "username:user1" --type post**
- Direct with Java adapter: **\$ mfp adapter call "adapterName/procedure/{pathParameter with space}" --form "username:user" --header "Date:01/01/2015" --query "index=6" --type post**

ADD

Syntax: **mfp add [adapter|api]**The **add** command generates new MobileFirst artifacts. The current working directory must be a child of an existing MobileFirst project. Generated artifacts go into the appropriate folder within the project, regardless of the current working directory. For example, adapters are generated to the adapters folder and native APIs are generated to the apps folder.

## ADD ADAPTER

Syntax: **mfp add adapter [<name> --type|-t <adapertype> [--jsonstore|-j] [--ussd|-u] [--package|-p]]**This command is deprecated in V7.0.0. You can use the **adapter add** command instead. The **add adapter** command creates a new adapter, which is generated into the **adapters** folder of the current project.

If you run **add adapter** without any arguments, you are prompted for the following parameters:

**<name>**

The name that you want for the generated adapter.

**<adapertype>**

The type of adapter. For example: HTTP, Cast Iron, SAP, JCo, or Java.

**[--jsonstore|-j]**

Your choice of JSONStore procedures. JSONStore procedures are not valid for JCo and Java adapters.

**[--ussd|-u]**

The option for the Unstructured Supplementary Service Data (USSD) communication technology.

**[--package|-p]**

The name of the package that contains the Java adapter classes. Package option is valid only for Java adapters.

## ADD API

Syntax: **mfp add api [<name>]**The **add api** command generates a new native API into the apps folder of the current project. Run the command in the current working directory, which is a child of a MobileFirst project.

If you run **\$ mfp add api** without any arguments, you are prompted for the following parameter:

**<name>**

The name that you want for the generated native API.

## B:

## BD

Syntax: **mfp bd**The **bd** command builds and deploys to the local test server the set of MobileFirst resources that are most local to the current working directory. To run the **bd** command, navigate to the preferred folder and enter **\$ mfp bd**.

## BUILD

Syntax: **mfp build**The **build** command builds the set of MobileFirst resources that are most local to the current working directory.

To generate a build in the preferred folder, navigate to the folder and enter **\$ mfp build**.

- If you run the command from the root folder of a MobileFirst project, the command builds all the apps and adapters in the project.
- If you run the command from the apps folder, the command builds all the apps in the project.
- If you run the command from the folder of a specific adapter, the command builds that one adapter.

## C:

### CONFIG

Syntax: **mfp config** [**<setting>**] [**<value>**] This command is a global command. Use the **config** command to set your configuration preferences, in particular which browser is used by CLI. To configure your preferences, you can use one of the following syntaxes:

- Interactive: Run **\$ mfp config** and follow the prompts by using the arrow keys.
- Direct with the **setting** parameter: **\$ mfp config** [**<setting>**].
- Direct with the **setting** and **value** parameters: **\$ mfp config** [**<setting>**] [**<value>**].

### CONSOLE

Syntax: **mfp console** This command is a global command. The **console** command opens the MobileFirst Operations Console in your default browser for the current project.

This command takes no parameters. To open the MobileFirst Operations Console, run: **\$ mfp console**.

### CREATE

Syntax: **mfp create** [**<name>** **--app** | **-a** **<app>**] This command is a global command. The **create** command creates a new MobileFirst project in the current working directory. This new project contains an iOS app in the apps folder. If you enter the command without any arguments, you are prompted for the name of the project and the name of the application. To generate a new MobileFirst project that is called MyProject, enter **\$ mfp create MyProject --app MyApp**.

### CREATE SERVER

Syntax: **mfp create-server** This command is a global command that does not need to be run manually because the built-in development server is automatically created and started as needed. The **create server** command creates a new WebSphere Application Server Liberty application server in your default folder. The server is preconfigured to work as a MobileFirst local test server. To run the command, enter **mfp create-server**. This command takes no arguments.

## D:

### DEPLOY

Syntax: **mfp deploy** The **deploy** command deploys to the local test server the set of MobileFirst resources that are found in the current working directory. To run the **deploy** command in the preferred folder, navigate to the folder and enter **\$ mfp deploy**.

- If you run the command from the root folder of a MobileFirst project, the command deploys all apps and adapters in the project.

- If you run the command from the apps folder, the command deploys all the apps in the project.
- If you run the command from the folder of a specific adapter, the command deploys that one adapter.
- If you run the command from the folder of a specific application, the command deploys that one application.

## H:

### HELP

Syntax: **mfp help** [**<command>**] This command is a global command. The **help** command displays either information about the general use of the CLI, or detailed help for each command.

- Information about the use of the CLI: **\$ mfp help**.
- Information about a specific command: **\$ mfp help invoke**.

## I:

### INFO

Syntax: **mfp info** The **info** command generates information about your environment. This information contains the operating system, the memory consumption on your machine, the node version, and the CLI version. If your current directory is a MobileFirst project, it also displays information about your project.

## INVOKE

Syntax: **mfp invoke** [**<adapter>**:**<procedure>** [**\<json array>**\ | **--file** | **-f <path to json array file>**]] This command is deprecated. You can use the **adapter call** command instead. The **invoke** command starts a procedure for a specified adapter on MobileFirst Server. Pass the arguments as a comma-separated list. If you enter the command with no arguments, you are prompted for an adapter and procedure, based on what is available in the current working directory of your project. You can run the command with one of the following syntaxes:

- Interactive: **\$ mfp invoke**, then follow the prompts by using the arrow keys.
- Direct with no parameters: **\$ mfp invoke adapterName:function**.
- Direct with a JSON array parameter: **\$ mfp invoke adapterName:function [\<string>, 2, true]**.
- Direct with a JSON file parameter: **\$ mfp invoke adapterName:function --file ./myArts.json**.

## L:

### LOGS

Syntax: **mfp logs** The **logs** command shows the path to the local test server logs. You can run the **logs** command from any directory. On completion, the path to the test server logs is displayed and control is returned to the command line. The **logs** command takes no arguments. To run it, enter **\$ mfp logs**.

## R:

### RESTART



Syntax: **mfp restart**The **restart** command restarts the local test server. Run the **restart** command in the current working directory, which is a child of a MobileFirst project. On completion, a message indicates a successful start, and control is returned to the command line. This command takes no arguments. To run the **restart** command in the preferred folder, navigate to the folder and enter **\$ mfp restart**.

## RUN

Syntax: **mfp run**The **run** command starts the local test server. Run **mfp run** in the current working directory, which is a child of a MobileFirst project. This command does not return control to the command line. It displays new status messages from the server until the server is stopped. The **run** command takes no arguments. To run it, enter **\$ mfp run**.

## S:

## START

Syntax: **mfp start**The **start** command starts the local test server. Run **mfp start** command in the current working directory, which is a child of a MobileFirst project. On completion, a message indicates that a successful start and control is returned to the command line. This command takes no arguments. To start the local test server, enter **\$ mfp start**.

## STATUS

Syntax: **mfp status**The **status** command shows the status of the local test server, either running or stopped. Run the command in the current working directory, which is a child of a MobileFirst project. This command takes no arguments. To run the command, enter **\$ mfp status**.

## STOP

Syntax: **mfp stop**The **stop** command stops the local test server. Run **mfp stop** command in the current working directory, which is a child of a MobileFirst project. This command takes no arguments. To run the command, enter **\$ mfp stop**.

## Commands

You can use IBM MobileFirst Platform Command Line Interface for iOS to create apps from the command line.

## A:

### ADAPTER

Syntax: **mfp adapter [add|call]**

You can use the **adapter** command to manage your adapters on the MobileFirst Server.

### ADAPTER ADD

Syntax: **mfp adapter add [<name> --type|-t <type> [--jsonstore|-j] [--ussd|-u] [--package|-p <package>]**The **adapter add** command creates a new adapter, which is generated in the **adapters** folder of the current project.

If you run **adapter add** without any arguments, you are prompted for the following parameters:

**<name>**

The name that you want for the generated adapter.

**<type>**

The type of adapter. Valid values are: **castiron**, **http**, **java**, **jco**, **jms**, **sap**, and **sql**.

**[--jsonstore|-j]**

Your choice of JSONStore procedures. JSONStore procedures are not valid for JCo and Java adapters.

**[--ussd|-u]**

The option for the Unstructured Supplementary Service Data (USSD) communication technology.

**[--package|-p <package>]**

The name of the package that contains the Java adapter classes. Package option is valid only for Java adapters.

## ADAPTER CALL

Syntax: **mfp adapter call [<adapter>/<procedure> ["<arguments>"]]**

or

**mfp adapter call [<adapter>/<procedure> [--type|-t get|post]  
[--file|-f <args.json>]]**

or

Syntax: **mfp adapter call [<adapter>/<procedure>**

**[--type|-t get|post]**

**[--form|-fp <form\_parameters>]**

**[--header|-h <header\_parameters>]**

**[--query|-q <query\_parameters>]**

**]**

The **adapter call** command calls an adapter's procedure on the MobileFirst Server. You can use "**FORM**, **HEADER**, and **QUERY** parameters" to call an adapter's procedure by using the direct mode. Add the flag for the parameter type and pass the object of parameters, if needed. For example:  
**--form "username:user" --header "password:pass" --query "date:01/01/2015".**

To use "**PATH** parameters" in direct mode, add them to the adapter/procedure path. Replace the **{pathParameter}** with the value that you want to send as the parameter. For example:

- Before: **myAdapter/users/{username}**. In this example, you must replace the **{username}** parameter.
- After: **myAdapter/users/StanLee**

**[--file|-f]**

The JSON file that contains the required arguments.

**[--type|-t]**

Indicates the request type: **GET** or **POST** are the valid options. If you are using Java adapters, the type also includes **PUT** and **DELETE**.

**Note:** If the **type** parameter is not defined, the **adapter call** command uses **GET** by default. Type cannot be passed in a JSON file.

**[--form|-fp]**

The form parameters to pass with the procedure. For Java Adapters and Direct Mode use only.

**[--header|-h]**

The header parameters to pass with the procedure. For Java Adapters and Direct Mode use only.

**[--query|-q]**

The query parameters to pass with the procedure. For Java Adapters and Direct Mode use only.

You can run the **adapter call** command by using one of the following methods.

- Interactive: **\$ mfp adapter call**, then follow the prompts by using the arrow keys.
- Direct with no parameters: **\$ mfp adapter call adapterName/procedure.**
- Direct with multiple parameters: **\$ mfp adapter call adapterName/procedure "stringParameter", 2, true.**
- Direct with an array: **\$ mfp adapter call adapterName/procedure ["stringParameter", 2, true**
- Direct with a JSON file parameter: **\$ mfp adapter call adapterName/procedure --file ./myArgs.json**

JSON file

```
[
 "world"
]
```

JSON file for Java adapter

```
{
 "FORM":{"username":"user","password":"pass"},
 "QUERY":{"index":6},
 "HEADER":{"Date":"01/01/2015"}
}
```

- Direct with POST method: **\$ mfp adapter call adapterName/procedure/{path\_parameter} -fp "username:user1" --type post**
- Direct with Java adapter: **\$ mfp adapter call "adapterName/procedure/{pathParameter with space}" --form "username:user" --header "Date:01/01/2015" --query "index=6" --type post**

**ADD**

Syntax: **mfp add [adapter|api]** The **add** command generates new MobileFirst artifacts. The current working directory must be a child of an existing MobileFirst project. Generated artifacts go into the appropriate folder within the project, regardless of the current working directory. For example, adapters are generated to the adapters folder and native APIs are generated to the apps folder.

**ADD ADAPTER**

Syntax: **mfp add adapter [<name> --type|-t <adapertype> [--jsonstore|-j] [--ussd|-u] [--package|-p]]** This command is deprecated in V7.0.0. You can use the **adapter add** command instead. The **add adapter** command creates a new adapter, which is generated into the **adapters** folder of the current project.

If you run **add adapter** without any arguments, you are prompted for the following parameters:

**<name>**

The name that you want for the generated adapter.

**<adaptype>**

The type of adapter. For example: HTTP, Cast Iron, SAP, JCo, or Java.

**[--jsonstore|-j]**

Your choice of JSONStore procedures. JSONStore procedures are not valid for JCo and Java adapters.

**[--ussd|-u]**

The option for the Unstructured Supplementary Service Data (USSD) communication technology.

**[--package|-p]**

The name of the package that contains the Java adapter classes. Package option is valid only for Java adapters.

## ADD API

Syntax: **mfp add api [<name>]**The **add api** command generates a new native API into the apps folder of the current project. Run the command in the current working directory, which is a child of a MobileFirst project.

If you run **\$ mfp add api** without any arguments, you are prompted for the following parameter:

**<name>**

The name that you want for the generated native API.

## B:

### BD

Syntax: **mfp bd**The **bd** command builds and deploys to the local test server the set of MobileFirst resources that are most local to the current working directory. To run the **bd** command, navigate to the preferred folder and enter **\$ mfp bd**.

## BUILD

Syntax: **mfp build**The **build** command builds the set of MobileFirst resources that are most local to the current working directory.

To generate a build in the preferred folder, navigate to the folder and enter **\$ mfp build**.

- If you run the command from the root folder of a MobileFirst project, the command builds all the apps and adapters in the project.
- If you run the command from the apps folder, the command builds all the apps in the project.
- If you run the command from the folder of a specific adapter, the command builds that one adapter.

## C:

### CONFIG

Syntax: **mfp config [<setting>][<value>]**This command is a global command. Use the **config** command to set your configuration preferences, in particular which browser is used by CLI. To configure your preferences, you can use one of the following syntaxes:

- Interactive: Run **\$ mfp config** and follow the prompts by using the arrow keys.

- Direct with the **setting** parameter: **\$ mfp config [<setting>]**.
- Direct with the **setting** and **value** parameters: **\$ mfp config [<setting>] [<value>]**.

## CONSOLE

Syntax: **mfp console**This command is a global command. The **console** command opens the MobileFirst Operations Console in your default browser for the current project.

This command takes no parameters. To open the MobileFirst Operations Console, run: **\$ mfp console**.

## CREATE

Syntax: **mfp create [<name> --app|-a <app>]**This command is a global command. The **create** command creates a new MobileFirst project in the current working directory. This new project contains an iOS app in the apps folder. If you enter the command without any arguments, you are prompted for the name of the project and the name of the application. To generate a new MobileFirst project that is called MyProject, enter **\$ mfp create MyProject --app MyApp**.

## CREATE SERVER

Syntax: **mfp create-server**This command is a global command that does not need to be run manually because the built-in development server is automatically created and started as needed. The **create server** command creates a new WebSphere Application Server Liberty application server in your default folder. The server is preconfigured to work as a MobileFirst local test server. To run the command, enter **mfp create-server**. This command takes no arguments.

## D:

## DEPLOY

Syntax: **mfp deploy**The **deploy** command deploys to the local test server the set of MobileFirst resources that are found in the current working directory. To run the **deploy** command in the preferred folder, navigate to the folder and enter **\$ mfp deploy**.

- If you run the command from the root folder of a MobileFirst project, the command deploys all apps and adapters in the project.
- If you run the command from the apps folder, the command deploys all the apps in the project.
- If you run the command from the folder of a specific adapter, the command deploys that one adapter.
- If you run the command from the folder of a specific application, the command deploys that one application.

## H:

## HELP

Syntax: **mfp help [<command>]**This command is a global command. The **help** command displays either information about the general use of the CLI, or detailed help for each command.

- Information about the use of the CLI: **\$ mfp help**.
- Information about a specific command: **\$ mfp help invoke**.

I:

## INFO

Syntax: **mfp info**The **info** command generates information about your environment. This information contains the operating system, the memory consumption on your machine, the node version, and the CLI version. If your current directory is a MobileFirst project, it also displays information about your project.

## INVOKE

Syntax: **mfp invoke** [**<adapter>**:**<procedure>**[\"**<json array>**\"]**|--file|-f <path to json array file>**]]This command is deprecated. You can use the **adapter call** command instead. The **invoke** command starts a procedure for a specified adapter on MobileFirst Server. Pass the arguments as a comma-separated list. If you enter the command with no arguments, you are prompted for an adapter and procedure, based on what is available in the current working directory of your project. You can run the command with one of the following syntaxes:

- Interactive: **\$ mfp invoke**, then follow the prompts by using the arrow keys.
- Direct with no parameters: **\$ mfp invoke adapterName:function**.
- Direct with a JSON array parameter: **\$ mfp invoke adapterName:function [\"string\", 2, true]**.
- Direct with a JSON file parameter: **\$ mfp invoke adapterName:function --file ./myArts.json**.

L:

## LOGS

Syntax: **mfp logs**The **logs** command shows the path to the local test server logs. You can run the **logs** command from any directory. On completion, the path to the test server logs is displayed and control is returned to the command line. The **logs** command takes no arguments. To run it, enter **\$ mfp logs**.

R:

## RESTART

Syntax: **mfp restart**The **restart** command restarts the local test server. Run the **restart** command in the current working directory, which is a child of a MobileFirst project. On completion, a message indicates a successful start, and control is returned to the command line. This command takes no arguments. To run the **restart** command in the preferred folder, navigate to the folder and enter **\$ mfp restart**.

## RUN

Syntax: **mfp run**The **run** command starts the local test server. Run **mfp run** in the current working directory, which is a child of a MobileFirst project. This command does not return control to the command line. It displays new status messages from the server until the server is stopped. The **run** command takes no arguments. To run it, enter **\$ mfp run**.

S:

## START

Syntax: **mfp start**The **start** command starts the local test server. Run **mfp start** command in the current working directory, which is a child of a MobileFirst project. On completion, a message indicates that a successful start and control is returned to the command line. This command takes no arguments. To start the local test server, enter **\$ mfp start**.

#### STATUS

Syntax: **mfp status**The **status** command shows the status of the local test server, either running or stopped. Run the command in the current working directory, which is a child of a MobileFirst project. This command takes no arguments. To run the command, enter **\$ mfp status**.

#### STOP

Syntax: **mfp stop**The **stop** command stops the local test server. Run **mfp stop** command in the current working directory, which is a child of a MobileFirst project. This command takes no arguments. To run the command, enter **\$ mfp stop**.

---

## Developing the server side of a MobileFirst application

This collection of topics relates to various aspects of developing the server-side components of a MobileFirst application.

### MobileFirst Java adapters

With IBM MobileFirst Platform Foundation for iOS, you can create, test, and deploy adapters written in Java.

Java adapters were introduced to MobileFirst, starting with V7.0. Java adapters, written in Java, are based on the JAX-RS specification and expose a full REST API to the client. In other words, a Java adapter is a JAX-RS service that can be deployed to MobileFirst Server and that by default, has access to MobileFirst Server APIs.

The benefits of using a Java adapter are:

- Ability to fully control the URLs structure, the content types, the request and response headers, content and encoding.
- Rapid development and testing by using MobileFirst Studio and CLI.
- Rapid deployment to a running MobileFirst Server without compromising on performance and without any downtime.
- Ready-to-use security integration with MobileFirst security that uses simple annotations in the source code.

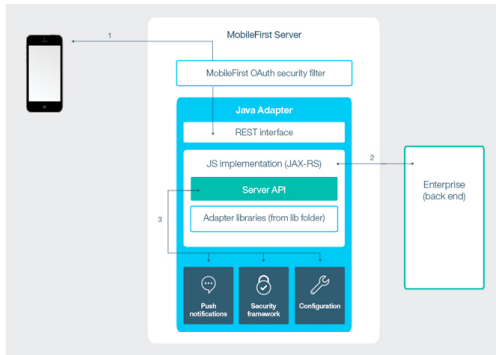

Figure 8-5. The Java adapter framework

Figure 1 illustrates how a mobile device (1) can access any Java adapter from its REST endpoint. The REST interface is protected by the MobileFirst OAuth security filter, meaning that the client needs to obtain an access token to access the adapter resources. Because any of the resources of the adapter can have its own URL, it is possible to use a third-party (that is, non-MobileFirst) URL-based security framework. The REST interface invokes the Java code (JAX-RS service) to handle incoming requests. The Java code can perform operations on the server by using the Java MobileFirst Server API (3). In addition, the Java code can connect to the enterprise system to fetch data, update data, or perform any other operation that the enterprise system exposes (2).

For more information about IBM MobileFirst Platform Foundation for iOS adapters, see .

### Adapter sandboxing

Note that every Java adapter has its own isolated sandbox, in which all its classes are running without knowing about or interrupting the sandboxes of other adapters. It is possible to include third-party libraries that are required by the adapter code in the adapter/lib folder. Libraries that are included there override any libraries that are provided by the application server or included in the server/lib folder.



## Setting up the connectivity to back-end configuration

Unlike JavaScript adapters, Java adapters do not provide back-end connectivity, by default. It is the responsibility of the adapter developer to write code that connects to the back-end system. Examples of open source libraries are Apache HttpClient for connecting over HTTP and java.sql APIs for connecting directly to databases.

For more information about connectivity and samples of implementations of back-end connectivity inside a Java adapter, see Java Adapter.

## Developing Java adapters

Learn about creating a new Java adapter and developing Java adapter code.

### Creating a Java adapter using MobileFirst Studio:

Follow these instructions to create a new Java adapter in MobileFirst Studio.

#### About this task

You can create a Java adapter in MobileFirst Studio.

#### Procedure

1. In MobileFirst Studio, right-click a MobileFirst project, then select **New > MobileFirst Adapter**.
2. In the dialog, select **Java Adapter**.
3. Enter the adapter name and package name.
4. Click **Finish**.

### Creating a Java adapter using MobileFirst CLI commands:

Follow these instructions to create a Java adapter using MobileFirst CLI commands.

#### About this task

You can create a Java adapter from the command line.

#### Procedure

1. Open a terminal.
2. Change directory to the MobileFirst project directory.
3. Type: `mfp add adapter <name> -type java -package <package name>`.

### Developing Java adapter code:

Learn about implementing the adapter's JAX-RS service, the Java server side API, and debugging Java adapter code.

*Implementing the adapter's JAX-RS service:*

To implement the JAX-RS service of the Adapter, you must first implement the JAX-RS application class, then implement the JAX-RS resources classes.

*Implementing the JAX-RS application class:*

## About this task

The JAX-RS application class tells the JAX-RS framework which resources are included in the application. Any resource can have a separate set of URLs. Traditionally the application class should extend `javax.ws.rs.core.Application` and implement the method `getClasses` or `getSingletons` that will be called by the JAX-RS framework to get information about this application. In the following example, a JAX-RS application defines three resources: `Resource1`, `UsersResource`, and `MyResourceSingleton`. The first two are provided by the `getClasses` method, while the last is provided by `getSingletons`:

```
import java.util.HashSet;
import java.util.Set;
import javax.ws.rs.core.Application;

public class MyApplication extends Application{

 @Override
 public Set<Class<?>> getClasses() {
 HashSet<Class<?>> classes = new HashSet<Class<?>>();
 classes.add(Resource1.class);
 classes.add(UsersResource.class);
 return classes;
 }

 @Override
 public Set<Object> getSingletons() {
 Set<Object> singletons = new HashSet<Object>();
 singletons.add(MyResourceSingleton.getInstance());
 return singletons;
 }
}
```

An alternative to using the `javax.ws.rs.core.Application` is to use `com.worklight.wink.extensions.MFPJAXRSApplication`. In the following example, there is no need to put all the resources classes (or singletons) in a list, since `MFPJAXRSApplication` scans the package returned by the `getPackageToScan` method for JAX-RS resources and creates the list automatically. Additionally, it has an `init` method that is called by IBM MobileFirst Platform Server as soon as the adapter is deployed (before serving has begun) and when the MobileFirst runtime starts up:

```
import com.worklight.wink.extensions.MFPJAXRSApplication;
public class MyApplication2 extends MFPJAXRSApplication{
 @Override
 protected void init() throws Exception {
 //Perform initialization
 }

 @Override
 protected String getPackageToScan() {
 return getClass().getPackage().getName();
 }
}
```

*Implementing a JAX-RS resource:*

## About this task

A JAX-RS resource is a POJO ("plain old Java object") which is mapped to a root URL and has Java methods for serving requests to this root URL and its sub-URLs. For example:

```

import java.util.ArrayList;
import javax.ws.rs.Consumes;
import javax.ws.rs.DELETE;
import javax.ws.rs.GET;
import javax.ws.rs.POST;
import javax.ws.rs.PUT;
import javax.ws.rs.Path;
import javax.ws.rs.PathParam;
import javax.ws.rs.Produces;
import javax.ws.rs.core.MediaType;
import javax.ws.rs.core.Response;
import javax.ws.rs.core.Response.Status;

@Path("/users")
//This is the root URL of the resource ("/users")
public class UsersResource {
 //Instead of this static field, it could be a users DAO that works with Database or cloud storage
 static ArrayList<User> users = new ArrayList<User>();

 @GET
 @Produces(MediaType.APPLICATION_JSON)
 //This will serve: GET /users
 public ArrayList<User> getUsers(){
 return users;
 }

 @Path("/{userId}")
 @Produces(MediaType.APPLICATION_JSON)
 //This will serve: GET /users/{userId}
 public User getUser(@PathParam("userId") String userId){
 return findUserById(userId);
 }

 @POST
 @Consumes(MediaType.APPLICATION_JSON)
 //This will serve: POST /users
 public void addUser(User u) {
 users.add(u);
 }

 @PUT
 @Consumes(MediaType.APPLICATION_JSON)
 //This will serve: PUT /users
 public Response updateUser(User u) {
 User user = findUserById(u.getId());
 if (user == null){
 return Response.status(Status.NOT_FOUND)
 .entity("User with ID: "+u.getId()+" not found")
 .build();
 }
 users.remove(user);
 users.add(u);
 return Response.ok().build();
 }

 @DELETE
 @Path("/{userId}")
 //This will serve: DELETE /users/{userId}
 public void deleteUser(@PathParam("userId") String userId){
 User user = findUserById(userId);
 users.remove(user);
 }

 private User findUserById(String userId) {

```

```

//TODO implement...
return null;
}
}

```

The resource just shown is mapped to the URL `/users` and serves the following requests:

*Table 8-2. Resource requests*

Request	Description
<b>GET</b> <code>/users</code>	Gets all users list
<b>POST</b> <code>/user</code>	Adds a new user
<b>GET</b> <code>/users/{id}</code>	Gets a specific user with id <b>id</b>
<b>PUT</b> <code>/users</code>	Updates an existing user
<b>DELETE</b> <code>/users/{id}</code>	Deletes a user with id <b>id</b>

The JAX-RS framework does the mapping from the simple Java object `User` to a JSON object and vice-versa, making it easier for the service developer to use without taking care of repeating conversion-related code. The implementation also helps in extracting parameter values from the URL and from the query string without having to parse it manually.

*Security configuration of a JAX-RS resource:*

#### **About this task**

After you have implemented a JAX-RS resource inside a Java adapter, the resource is already secured by the default security of the MobileFirst platform. That means that only a registered mobile app that is deployed on the same MobileFirst Server as the adapter can access this resource. It is possible to customize the security configuration of a resource by using the annotation `@OAuthSecurity`. This annotation can be used at the level of the resource itself or in one of its URLs.

#### **@OAuthSecurity annotation**

The `@OAuthSecurity` annotation is declared as follows:

```

@Retention(RetentionPolicy.RUNTIME)
@Target({ElementType.METHOD, ElementType.TYPE})
public @interface OAuthSecurity {
 String scope() default "";
 boolean enabled() default true;
}

```

- The **scope** field is the required scope of the protected resource.
- The **enabled** field makes it possible to enable or disable security for a resource.

#### **Using @OAuthSecurity at the resource class level**

To make the `UserResource` that was used in the previous examples unprotected, all you must do is add:

```
@OAuthSecurity(enabled=false)
```

above the class definition, as shown in the following example:

```

@Path("/users")
@OAuthSecurity(enabled=false)
//This is the root URL of the resource ("/users")
public class UsersResource {
 ...
}

```

## Using @OAuthSecurity at the method level

Suppose you want to leave the user's resource unprotected for readers only but protect the add/edit/delete user operations. You can use the **@OAuthSecurity** annotation at the method level, as shown in the following example:

```
@Path("/users")
@OAuthSecurity(enabled=false)
//This is the root URL of the resource ("/users")
public class UsersResource {

 @GET
 @Produces(MediaType.APPLICATION_JSON)
 //This will serve: GET /users
 public ArrayList<User> getUsers(){
 ...
 }

 @Path("/{userId}")
 @Produces(MediaType.APPLICATION_JSON)
 //This will serve: GET /users/{userId}
 public User getUser(@PathParam("userId") String userId){
 ...
 }

 @POST
 @Consumes(MediaType.APPLICATION_JSON)
 @OAuthSecurity(scope="adminRealm")
 //This will serve: POST /users
 public void addUser(User u) {
 ...
 }

 @PUT
 @Consumes(MediaType.APPLICATION_JSON)
 @OAuthSecurity(scope="adminRealm")
 //This will serve: PUT /users
 public Response updateUser(User u) {
 ...
 }

 @DELETE
 @Path("/{userId}")
 @OAuthSecurity(scope="adminRealm")
 //This will serve: DELETE /users/{userId}
 public void deleteUser(@PathParam("userId") String userId){
 ...
 }

 ...
}
```

*Java server side API:*

Java adapters can use the IBM MobileFirst Platform Server Java API to perform server-related operations such as: calling other adapters, submitting push notifications, logging on to the server log, getting values of configuration properties, reporting activities to analytics, and getting the identity of the request issuer.

To get the server API interface use the following code:

```
WLServerAPI serverApi = WLServerAPIProvider.getWLServerAPI();
```

The `WLServerAPI` interface is the parent of all the API categories: analytics, configuration, push, adapters, authentication. If you want to use the push API, you can write:

```
PushAPI pushApi = serverApi.getPushAPI();
```

For more information on the Java API, see the . Examples of the use of the API are provided in the following sections.

### Logger

Adding a logger to the JAX-RS resource of your adapter is essential for logging debug information, information, warnings, and errors to the MobileFirst Server log. In the Java adapters, you can use the standard `java.util.logging` logger. To add logger declare the following static field:

```
static Logger logger = Logger.getLogger(UsersResource.class.getName());
```

**Note:** The logger is part of the new adapter template, so in most cases, there is no need to add it.

### Push API

You can extend the `UsersResource` described in “Implementing the adapter's JAX-RS service” on page 8-87 to notify all the devices of a user when the user record is updated:

```
WLServerAPI serverAPI = WLServerAPIProvider.getWLServerAPI();

@PUT
@Consumes(MediaType.APPLICATION_JSON)
public Response updateUser(User u) {

 //TODO Really update the user...

 //Notify all devices that the user has been updated
 PushAPI push = serverAPI.getPushAPI();
 INotification notification = push.buildNotification();
 notification.getTarget().setUserIds(u.getId()); //Targeted only for the updated user

 JSONObject payload = new JSONObject();
 payload.put("user", u.getId());
 notification.getSettings().getAPNS().setPayload(payload);

 try {
 push.sendMessage(notification, "myApp");
 } catch (MFPSendMessageFailedException e) {
 e.printStackTrace(); //Ignore failure in this case, since the update succeeded.
 }
 return Response.ok().build();
}
```

### Security API

The security API provides the security context object that contains information about the identity of the request issuer. In the following example, a new validation is added to the user's resource: User records can be updated only by users themselves:

```
WLServerAPI serverAPI = WLServerAPIProvider.getWLServerAPI();

@PUT
@Consumes(MediaType.APPLICATION_JSON)
public Response updateUser(User u) {

 SecurityAPI security = serverAPI.getSecurityAPI();
 String requestIssuerUserId = security.getSecurityContext().getUserIdentity().getId();
 if (!u.getId().equals(requestIssuerUserId)){
 return Response.status(Status.FORBIDDEN)
 }
}
```

```

 .entity("The user: "+requestIssuerUserId+
 " is not allowed to modify the user record of another user").build();
 }

 //TODO Really update the user...

```

### Adapters API

The adapters API makes it easy to perform requests to other adapters in the same server.

The following example shows how to use the adapters API to call a JavaScript adapter:

```

@Path("/")
public class JavaAdapter1Resource {
 static Logger logger = Logger.getLogger(JavaAdapter1Resource.class.getName());

 @GET
 @Path("/calljs")
 @Produces("application/json")
 public JSONObject callJSAdapterExample() throws Exception{
 AdaptersAPI adaptersAPI = WLServerAPIProvider.getWLServerAPI().getAdaptersAPI();
 //Using helper method to create a request to the JS adapter
 HttpRequest req = adaptersAPI.createJavascriptAdapterRequest("JSAdapter", "getStories");
 //Execute the request and get the response
 HttpResponse resp = adaptersAPI.executeAdapterRequest(req);
 //Convert the response to JSON since we know that JS adapters always return JSON
 JSONObject json = adaptersAPI.getResponseAsJSON(resp);
 //Return the json response as the response of the current request that is being taking care of
 return json;
 }
}

```

### Configuration API

The configuration API enables the adapter to read server-side configuration properties defined in the `worklight.properties` file or as JNDI entries. For more information about MobileFirst configuration properties, see “Commands” on page 8-16.

For example, to get the value of the `serverSessionTimeout` property, write the following code:

```
String serverSessionTimeout = serverAPI.getConfigurationAPI().getMFPCConfigurationProperty("serverSessionTimeout");
```

*Debugging Java adapter code:*

Use IBM MobileFirst Platform Studio's debug mode to debug Java adapter code.

*Starting debug mode:*

#### Before you begin

After you enter debug mode, you can debug the Java code exactly as you debug a standard Java application. You might need to issue a request to the adapter to make its code run and hit the breakpoints.

**Note:** While in debug mode, you can debug the code of all deployed Java adapters and the code in the `server/java` folder as well.

#### Procedure

1. Right-click a Java adapter and select **Debug As > Debug MobileFirst Java Adapters**.
2. Optional: Open the **Debug** perspective in MobileFirst Studio to see threads, breakpoints, and values.

*Stopping debug mode:*

**Procedure**

1. Open the **Debug** perspective in MobileFirst Studio.
2. Right-click the **Debug** tab and select **remote debug [Remote Java Application]** > **Terminate**.

## MobileFirst JavaScript adapters

With IBM MobileFirst Platform Foundation for iOS, you can create, test, and deploy adapters written in JavaScript.

You can create and configure all JavaScript adapters manually. In addition, you can automatically generate SAP Netweaver Gateway or SOAP adapters with the services discovery wizard.

Starting with IBM MobileFirst Platform Foundation for iOS V6.3, changes were made to the XML definition and behavior of JavaScript adapter timeout and concurrency. For more information, see “Adapter timeout and concurrency” on page 8-122.

For more general information on IBM MobileFirst Platform Foundation for iOS adapters, see .

### Benefits of MobileFirst JavaScript adapters

JavaScript adapters provide various benefits, as follows:

- **Fast Development:** Adapters are developed in JavaScript and XSL. Developers employ flexible and powerful server-side JavaScript to produce succinct and readable code for integrating with back-end applications and processing data. Developers can also use XSL to transform hierarchical back-end data to JSON.
- **Read-only and Transactional Capabilities:** MobileFirst adapters support read-only and transactional access modes to back-end systems.
- **Security:** MobileFirst adapters use flexible authentication facilities to create connections with back-end systems. Adapters offer control over the identity of the user with whom the connection is made. The user can be a *system* user, or a user on whose behalf the transaction is made.
- **Transparency:** Data retrieved from back-end applications is exposed in a uniform manner, so that application developers can access data uniformly, regardless of its source, format, and protocol.
- **REST Interface:** A new REST interface lets you benefit from the OAuth 2.0 security framework, even when using your existing JavaScript adapters. For more information, see “Accessing adapters from the /adapters endpoint” on page 8-158.

### The adapter framework

The adapter framework mediates between the mobile apps and the back-end services. A typical flow is depicted in the following diagram. The app, the back-end application, and the JavaScript code and XSLT components in the MobileFirst Server are supplied by the adapter or app developer. The procedure and auto-conversions are part of IBM MobileFirst Platform Foundation for iOS.



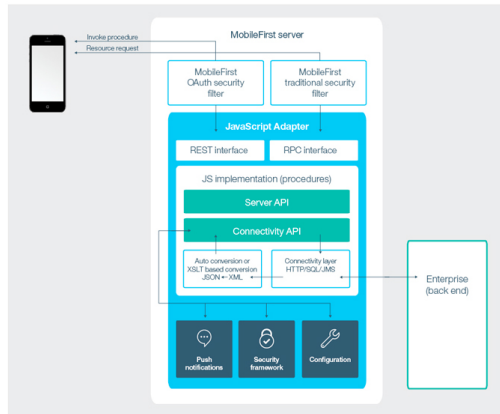

Figure 8-6. The JavaScript adapter framework

1. An adapter exposes a set of services, called procedures. Mobile apps invoke procedures by issuing Ajax requests.
2. The procedure retrieves information from the back-end application.
3. The back-end application then returns data in some format.
  - If this format is JSON, the MobileFirst Server keeps the data intact.
  - If this format is not JSON, the MobileFirst Server automatically converts it to JSON. Alternatively, you can provide an XSL transformation to convert the data to JSON. In this case, the returned content type from the back end must be XML. Then, you can use an XSLT to filter the data.
4. The JavaScript implementation of the procedure receives the JSON data, performs any additional processing, and returns it to the calling app.
  - Take note of the following points:
  - Writing an adapter that pulls large amounts of data and transfers it to the client application is discouraged because the data must be processed twice: once at the adapter and once again at the client application.
  - HTTP POST requests are used for client-server communications between the MobileFirst application and the MobileFirst Server. Parameters must be

supplied in a plain text or numeric format. To transfer images (or any other type of file data), they must be converted to base64 first.

## Anatomy of JavaScript adapters

MobileFirst adapters are developed by using XML, JavaScript, and XSL. Each adapter must have the following elements:

- Exactly one XML file, describing the connectivity to the back-end system to which the adapter connects, and listing the procedures that are exposed by the adapter to other adapters and to applications.
- Exactly one JavaScript file, containing the implementation of the procedures declared in the XML file.
- Zero or more XSL files, each containing a transformation from the raw XML data retrieved by the adapter to JSON returned by adapter procedures.

The files are packaged in a compressed file with a `.adapter` suffix (such as `myadapter.adapter`).

The root element of the XML configuration files is `<adapter>`. The main subelements of the `<adapter>` element are as follows:

- `<connectivity>`: Defines the connection properties and load constraints of the back-end system. When the back end requires user authentication, this element defines how the credentials are obtained from the user. For more information, see “Structure of the adapter XML file.”
- `<procedure>`: Declares a procedure that is exposed by the adapter. For more information, see “Implementing adapter procedures” on page 8-149.

The structure of the `<adapter>` element is as follows:

```
<?xml version="1.0" encoding="UTF-8"?>
<wl:adapter>
 <description>
 <connectivity>
 <connectionPolicy>
 <loadConstraints>
 </connectivity>

 <procedure /> <!-- One or more such elements -->
</wl:adapter>
```

## Structure of the adapter XML file

The adapter XML file is used to configure connectivity to the back-end system and to declare the procedures that are exposed by the adapters to applications and to other adapters.

## The adapter element

The adapter element is the root element of the adapter configuration file. It has the following structure, which consists of both attributes and subelements:

```
<wl:adapter name="Java_adap"
 xmlns:xsi="http://www.w3.org/2001/XMLSchema-instance"
 xmlns:wl="http://www.ibm.com/mfp/integration"
 xmlns:http="http://www.ibm.com/mfp/integration/http">

 <displayName>Java_adap</displayName>
 <description>Java_adap</description>
 <connectivity>
 <connectionPolicy xsi:type="wl:NullConnectionPolicyType"></connectionPolicy>
```

```

</connectivity>
 <JAXRSApplicationClass>java_package.Java_adapApplication</JAXRSApplicationClass>
</wl:adapter>

```

## The adapter element attributes

IBM MobileFirst Platform Foundation for iOS provides two schemas that are used by all adapters. Additionally, this product provides a specific schema for each type of adapter. Each schema must be associated with a different namespace. Namespaces are declared by using the `xmlns` attribute, and are linked to their schemas by using the `xsi:schemaLocation` attribute. The `<adapter>` element contains the following attributes.

### **name**

Mandatory.

The name of the adapter. This name must be unique within the MobileFirst Server. It can contain alphanumeric characters and underscores, and must start with a letter. After you define and deploy an adapter, you cannot modify its name.

### **xmlns:namespace**

Mandatory.

Defines schema *namespaces*.

This attribute must appear three times.

- `xmlns:xsi`: Defines the namespace associated with the `http://www.w3.org/2001/XMLSchema-instance` schema.
- `xmlns:wl`: Defines the namespace that is associated with the `http://www.ibm.com/mfp/integration` schema.
- `xmlns:namespace`: Defines the namespace that is associated with the schema related to the back-end application. For example, `xmlns:sap` or `xmlns:sql`.

### **xsi:schemaLocation**

Optional.

Identifies the schema locations.

```

xsi:schemaLocation="http://www.ibm.com/mfp/integration location-of-integration-schema-file
URI-of-specific-adapter-schema location-of-schema"

```

If this attribute is missing, auto-complete for XML elements and attributes that are defined in the schema is not available in MobileFirst Studio.

At run time, this attribute has no effect.

## The adapter element subelements

The adapter element has the following subelements.

### **displayName**

Optional.

This element is deprecated. The name of the adapter that is displayed in the MobileFirst Operations Console. If this element is not specified, the value of the name attribute is used instead.

**description**

Optional.

Additional information about the adapter. Displayed in the MobileFirst Operations Console.

**connectivity**

Mandatory.

Defines the mechanism by which the adapter connects to the back-end application. It contains the `connectionPolicy` subelement. The `connectionPolicy` subelement is mandatory, and it defines connection properties. The structure of this subelement depends on the integration technology of the back-end application.

**procedure**

Mandatory.

Defines a process for accessing a service that is exposed by a back-end application. Occurs once for each procedure that is exposed by the adapter.

The procedure element has the following structure.

```
<procedure
 name="unique-name"
 connectAs="value"
 audit="value"
 securityTest="value"
/>
```

The procedure element has the following attributes.

**name**

Mandatory.

The name of the procedure. This name must be unique within the adapter. It can contain alphanumeric characters and underscores, and must start with a letter.

**connectAs**

Optional.

Defines how to create a connection to the back end for invoking the retrieve procedure. The following values are valid.

- `server`: Default. The connection to the back-end is created according to the connection policy defined for the adapter.
- `endUser`: The connection to the back-end is created with the user's identity. Only valid if you identify a user realm in the security tests for this procedure.

**audit**

Optional.

Defines whether calls to the procedure are logged in the audit log. The log file is *Project Name*/server/log/audit/audit.log.

The following values are valid.

- `true`: Calls to the procedure are logged in the audit log.
- `false`: Default. Calls to the procedure are not logged in the audit log.

### **securityTest**

Optional.

The name of the security test that you want to use to protect the adapter procedure, as defined in the authenticationConfig.xml file.

### **Cast Iron adapter connectionPolicy element:**

You can access various enterprise data sources, such as databases, web services, and JMS, and provides validation, aggregation, and formatting capabilities by using Cast Iron.

#### **Structure**

The connectionPolicy element has the following structure.

```
<connectionPolicy xsi:type="http:HTTPConnectionPolicyType">
 <protocol>http</protocol>
 <domain>your.CastIron.com</domain>
 <port>80</port>
 <connectionTimeoutInMilliseconds>30000</connectionTimeoutInMilliseconds>
 <socketTimeoutInMilliseconds>30000</socketTimeoutInMilliseconds>
 <maxConcurrentConnectionsPerNode>50</maxConcurrentConnectionsPerNode>
</connectionPolicy>
```

#### **Attributes**

The connectionPolicy element has the following attributes.

##### **xsi:type**

Mandatory.

The value of this attribute must be set to http:HTTPConnectionPolicyType.

#### **Subelements**

The connectionPolicy element has the following subelements.

##### **protocol**

Optional.

The URL protocol to use. The following values are valid.

- http: default
- https

##### **domain**

Mandatory.

The host address.

##### **port**

Optional.

The port address.

##### **connectionTimeoutInMilliseconds**

Optional

The time until a connection to the back-end can be established. This timeout does not ensure that a timeout exception occurs after a time elapses after the invocation of the HTTP request.

If you pass a different value for this parameter in the `invokeHTTP()` JavaScript function, you can override the value that is defined here. For more information, see the `WL.Server` class.

#### **socketTimeoutInMilliseconds**

Optional.

The timeout between two consecutive packets, starting from the connection packet. This timeout does not ensure that a timeout exception occurs after a time elapses after the invocation of the HTTP request.

If you pass a different value for this parameter in the `invokeHttp()` JavaScript function, you can override the value that is defined here. For more information, see the `WL.Server` class.

#### **maxConcurrentConnectionsPerNode**

Optional.

Defines the maximum number of concurrent connections, which the MobileFirst Server can open to the back end.

IBM MobileFirst Platform Foundation for iOS does not limit the incoming service requests from applications. This subelement can be configured at the application server level. This product limits only the number of concurrent HTTP connections to the back-end service.

The default number of concurrent HTTP connections is 50. You can modify this number based on the expected concurrent requests to the adapter and the maximum requests allowed on the back-end service. You can also configure the back-end service to limit the number of concurrent incoming requests.

Consider a two-node system, where the expected load on the system is 100 concurrent requests and the back-end service can support up to 80 concurrent requests. You can set `maxConcurrentConnectionsPerNode` to 40. This setting ensures that no more than 80 concurrent requests are made to the back-end service.

If you increase the value, the back-end application needs more memory. To avoid memory issues, do not set this value too high. Instead, estimate the average and peak number of transactions per second, and evaluate their average duration. Then, calculate the number of required concurrent connections as indicated in this example, and add a 5-10% margin. Then, monitor your back end, and adjust this value as required, to ensure that your back-end application can process all incoming requests.

When you deploy adapters to a cluster, set the value of this attribute to the maximum required load divided by the number of cluster members.

For more information about how to size your back-end application, see the **Scalability and Hardware Sizing** document and the hardware calculator spreadsheet at Developer Center website for IBM MobileFirst Platform Foundation.

## HTTP adapter `connectionPolicy` element:

You can use the HTTP adapter to start RESTful services and SOAP-based services. You can also complete HTML scraping.

### Structure

The `connectionPolicy` element has the following structure.

```
<connectionPolicy xsi:type="http:HTTPConnectionPolicyType"; cookiePolicy="cookie-policy" maxRedirects="int">
 <protocol>protocol</protocol>
 <domain>host-name</domain>
 <port>host-port</port>
 <connectionTimeoutInMilliseconds>connection_timeout</connectionTimeoutInMilliseconds>
 <socketTimeoutInMilliseconds>socket_timeout</socketTimeoutInMilliseconds>
 <authentication> ... </authentication>
 <proxy> ... </proxy>
 <sslCertificateAlias>ssl-certificate-alias</sslCertificateAlias>
 <sslCertificatePassword>ssl-certificate-password</sslCertificatePassword>
 <maxConcurrentConnectionsPerNode>max_concurrent_connections</maxConcurrentConnectionsPerNode>
</connectionPolicy>
```

### Attributes

The `connectionPolicy` element has the following attributes.

#### `xsi:type`

Mandatory.

The value of this attribute must be set to `http:HTTPConnectionPolicyType`.

#### `cookiePolicy`

Optional.

This attribute sets how the HTTP adapter handles cookies that arrive from the back-end application. The following values are valid.

- `RFC_2109`: default value
- `RFC_2965`
- `NETSCAPE`
- `IGNORE_COOKIES`

#### `maxRedirects`

Optional.

The maximum number of redirects that the HTTP adapter can follow. This attribute is useful when the back-end application sends circular redirects as a result of some error, such as authentication failures. If this attribute is set to 0, the adapter does not attempt to follow redirects at all, and the HTTP 302 response is returned to the user. The default value is 10.

### Subelements

The `connectionPolicy` element has the following subelements.

#### `protocol`

Optional.

The URL protocol to use. The following values are valid.

- `http`: default

- https

**domain**

Mandatory.

The host address.

**port**

Optional.

The port address.

**sslCertificateAlias**

Optional for regular HTTP authentication and simple SSL authentication.

Mandatory for mutual SSL authentication.

The alias of the adapter private SSL key, which is used by the HTTP adapter key manager to access the correct SSL certificate in the keystore. For more information about the keystore setup process, see “SSL certificate keystore setup” on page 10-54.

**sslCertificatePassword**

Optional for regular HTTP authentication and simple SSL authentication.

Mandatory for mutual SSL authentication.

The password of the adapter private SSL key, which is used by the HTTP adapter key manager to access the correct SSL certificate in the keystore. For more information about the keystore setup process, see “SSL certificate keystore setup” on page 10-54.

**authentication**

Optional.

Authentication configuration of the HTTP adapter. The HTTP adapter can use one of four protocols, and can also contain a server identity. You can configure the HTTP adapter to use one of four authentication protocols by defining the <authentication> element. You can define the <authentication> element in one of the following ways.

- Basic Authentication

```
<authentication>
 <basic/>
</authentication>
```
- Digest Authentication

```
<authentication>
 <digest/>
</authentication>
```
- NTLM Authentication

```
<authentication>
 <ntlm workstation="value"/>
</authentication>
```

The workstation attribute is optional. This attribute denotes the name of the computer on which the MobileFirst Server runs.

- SPNEGO/Kerberos Authentication

```
<authentication>
 <spnego stripPortOffServiceName="true"/>
</authentication>
```



The attribute `stripPortOffServiceName` is optional. This attribute specifies whether the Kerberos client uses the service name without the port number.

When you use this option, you must also place the `krb5.conf` file under *Project Name/server/conf*. This file must contain Kerberos configuration such as the location of the Kerberos server, and domain names. Its structure is described in the Kerberos V5 System Administrator's Guide in the `mit.edu` website.

If the adapter exposes procedures with the attribute `connectAs="server"`, the connection policy can contain `<serverIdentity>` element. This feature applies to all authentication schemes. For example:

```
<authentication>
 <basic/>
 <serverIdentity>
 <username> ${DOMAIN\user} </username>
 <password> ${password} </password>
 </serverIdentity>
</authentication>
```

### **proxy**

Optional.

Access the back-end application. Add a `<proxy>` element inside the `<connectionPolicy>` element. If the proxy requires authentication, add a nested `<authentication>` element inside `<proxy>`. This element has the same structure as the one used to describe the authentication protocol of the adapter, described in The HTTP adapter's `<authentication>` element.

The following example shows a proxy that requires basic authentication and uses a server identity.

```
<connectionPolicy xsi:type="http:HTTPConnectionPolicyType">
 <protocol>http</protocol>
 <domain>www.bbc.co.uk</domain>
 <proxy>
 <protocol>http</protocol>
 <domain>wl-proxy</domain>
 <port>8167</port>
 <authentication>
 <basic/>
 <serverIdentity>
 <username>${proxy.user}</username>
 <password>${proxy.password}</password>
 </serverIdentity>
 </authentication>
 </proxy>
</connectionPolicy>
```

### **maxConcurrentConnectionsPerNode**

Optional.

Defines the maximum number of concurrent connections, which the MobileFirst Server can open to the back end.

IBM MobileFirst Platform Foundation for iOS does not limit the incoming service requests from applications. This subelement can be configured at the application server level. This product limits only the number of concurrent HTTP connections to the back-end service.

The default number of concurrent HTTP connections is 50. You can modify this number based on the expected concurrent requests to the adapter and

the maximum requests allowed on the back-end service. You can also configure the back-end service to limit the number of concurrent incoming requests.

Consider a two-node system, where the expected load on the system is 100 concurrent requests and the back-end service can support up to 80 concurrent requests. You can set `maxConcurrentConnectionsPerNode` to 40. This setting ensures that no more than 80 concurrent requests are made to the back-end service.

If you increase the value, the back-end application needs more memory. To avoid memory issues, do not set this value too high. Instead, estimate the average and peak number of transactions per second, and evaluate their average duration. Then, calculate the number of required concurrent connections as indicated in this example, and add a 5-10% margin. Then, monitor your back end, and adjust this value as required, to ensure that your back-end application can process all incoming requests.

When you deploy adapters to a cluster, set the value of this attribute to the maximum required load divided by the number of cluster members.

For more information about how to size your back-end application, see the Scalability and Hardware Sizing document and the hardware calculator spreadsheet at Developer Center website for IBM MobileFirst Platform Foundation.

#### **connectionTimeoutInMilliseconds**

Optional.

The timeout in milliseconds until a connection to the back-end can be established. Setting this timeout does not ensure that a timeout exception occurs after a specific time elapses after the invocation of the HTTP request.

If you pass a different value for this parameter in the `invokeHTTP()` JavaScript function, you can override the value that is defined here. For more information, see the `WL.Server` class.

#### **socketTimeoutInMilliseconds**

Optional.

The timeout in milliseconds between two consecutive packets, starting from the connection packet. Setting this timeout does not ensure that a timeout exception occurs after a specific time elapses after the invocation of the HTTP request.

If you pass a different value for the **socketTimeoutInMilliseconds** parameter in the `invokeHttp()` JavaScript function, you can override the value that is defined here. For more information, see the `WL.Server` class.

#### **JMS adapter connectionPolicy element:**

You can use Java™ Messaging Service (JMS) is the standard messaging Java API to send messages between two or more clients. The MobileFirst JMS adapter provides reading and writing capabilities to messaging providers that implement the JMS API.

#### **Structure**

The `connectionPolicy` element has the following structure.

```

<connectionPolicy xsi:type="jms:JMSConnectionPolicyType">
 <!-- uncomment this if you want to use an external JNDI repository -->
 <!-- <namingConnection url="MY_JNDI_URL"
 initialContextFactory="providers_initial_context_factory_class_name"
 user="JNDIUserName"
 password="JNDIPassword"/>
 -->

 <jmsConnection
 connectionFactory="java:comp/env/MYConnectionFactory"
 user="MessagingSystemUserName"
 password="MessagingSystemPassword"
 />
</connectionPolicy>

```

### Attributes

The `connectionPolicy` element has the following attributes.

#### **xsi:type**

Mandatory.

The value of this attribute must be set to `jms:JMSConnectionPolicyType`.

### Subelements

The `connectionPolicy` element has the following subelements.

#### **namingConnection**

Optional.

Describes how to connect to an external JNDI repository. Only used if the JNDI objects are not stored in the Java Platform, Enterprise Edition server that the adapter is deployed in. This element has the following attributes.

#### **url**

Mandatory.

The URL of the external JNDI repository. For example: `iiop://localhost`. The URL syntax is dependent upon the JNDI provider.

#### **initialContextFactory**

Mandatory.

The `initialContextFactory` class name of the JNDI provider. For example: `com.ibm.Websphere.naming.WsnInitialContextFactory`. The driver, and any associated files, must be placed in the `/server/lib` directory. If you develop in the Eclipse environment, the driver and associated files must be placed in the `/lib` directory.

**Note:** If you develop for WebSphere Application Server with WebSphere MQ, do not add the WebSphere MQ Java™ archive (JAR) files to the `/lib` directory. If the WebSphere MQ JAR files are added, class loading problems occur because the files already exist in the WebSphere Application Server environment.

#### **user**

Optional.

User name of a user with authority to connect to the JNDI repository. If user is not specified, the default user name is guest.

**password**

Optional.

User name of a user with authority to connect to the JNDI repository. If user is not specified, the default password is guest.

**.jmsConnection**

Mandatory.

Describes the connection factory and optional security details that are used to connect to the messaging system.

**connectionFactory**

Mandatory.

The name of the connection factory that is used when you connect to the messaging system.

If you are deploying in WebSphere Application Server, the connection factory must be a global JNDI object. The object must be addressed without the java:comp/env context. For example: `jms/MyConnFactory` and not `java:comp/env/jms/MyConnFactory`. However, if you are deploying in Tomcat, the connection factory must be addressed including the java:/comp/env context. For example: `java:comp/env/jms/MyConnFactory`.

**user**

Optional.

User name of a user with authority to connect to the messaging system.

**password**

Optional.

Password for the user who is specified in the user attribute.

**SAP Gateway adapter connectionPolicy element:**

You can use SAP adapters to communicate with SAP Netweaver Gateway back-end services.

**Structure**

The connectionPolicy element has the following structure.

```
<connectionPolicy xsi:type="nwgateway:NWGatewayHTTPConnectionPolicyType">
 <protocol>HTTP</protocol>
 <domain>host</domain>
 <port>8320</port>
 <connectionTimeoutInMilliseconds>30000</connectionTimeoutInMilliseconds>
 <socketTimeoutInMilliseconds>30000</socketTimeoutInMilliseconds>
 <serviceRootUrl>/sap/opu/odata/IWBEP/RMTSAMPLEFLIGHT_2/</serviceRootUrl>
 <authentication>
 <basic/>
 <serverIdentity>
 <client>001</client>
 <username>mygatewayuser</username>
 <password>mygatewaypassword</password>
 </serverIdentity>
 </authentication>
</connectionPolicy>
```

```

 </serverIdentity>
 </authentication>
 <!-- Following properties used by adapter's key manager for choosing specific certificate from key store
 <sslCertificateAlias></sslCertificateAlias>
 <sslCertificatePassword></sslCertificatePassword-->
 <maxConcurrentConnectionsPerNode>50</maxConcurrentConnectionsPerNode>
</connectionPolicy>

```

### Attributes

The `connectionPolicy` element has the following attributes.

#### **xsi:type**

Mandatory.

The value of this attribute must be set to `nwgateway:NWGatewayHTTPConnectionPolicyType`.

### Subelements

The `connectionPolicy` element has the following subelements.

#### **protocol**

Mandatory.

The URL protocol to use. The following values are valid.

- http: default
- https

#### **domain**

Mandatory.

The host address.

#### **port**

Mandatory.

The port address.

#### **connectionTimeoutInMilliseconds**

Optional.

The time until a connection to the back-end can be established. Setting this timeout does not ensure that a timeout exception occurs after a time elapses after the invocation of the HTTP request.

If you pass a different value for this parameter in the `invokeHTTP()` JavaScript function, you can override this value. For more information, see the `WL.Server` class.

#### **socketTimeoutInMilliseconds**

Optional.

The time between two consecutive packets, starting from the connection packet. Setting this timeout does not ensure that a timeout exception occurs after a time elapses after the invocation of the HTTP request.

If you pass a different value for this parameter in the `invokeHttp()` JavaScript function, you can override the value that is defined here. For more information, see the `WL.Server` class.

## **serviceRootUrl**

Mandatory.

The root URL for the SAP Netweaver gateway service that you are trying to access.

## **authentication**

Mandatory.

Authentication configuration of the SAP Netweaver Gateway adapter. Your adapter can use one of four protocols, and a server identity, which you can configure if you define this element. You can define the authentication in one of the following ways.

- Basic Authentication

```
<authentication>
 <basic/>
</authentication>
```
- Digest Authentication

```
<authentication>
 <digest/>
</authentication>
```
- NTLM Authentication

```
<authentication>
 <ntlm workstation="value"/>
</authentication>
```

The workstation attribute is optional. This attribute denotes the name of the computer on which the MobileFirst Server runs.

- SPNEGO/Kerberos Authentication

```
<authentication>
 <spnego stripPortOffServiceName="true"/>
</authentication>
```

The attribute stripPortOffServiceName is optional. This attribute specifies whether the Kerberos client uses the service name without the port number.

When you use this option, you must also place the krb5.conf file under *Project Name/server/conf*. This file must contain Kerberos configuration such as the location of the Kerberos server, and domain names. Its structure is described in the Kerberos V5 System Administrator's Guide in the mit.edu website.

If the adapter exposes procedures with the attribute connectAs="server", the connection policy can contain the serverIdentity element. This feature applies to all authentication schemes. For example:

```
<authentication>
 <basic/>
 <serverIdentity>
 <client>001</client>
 <username> ${DOMAIN\user} </username>
 <password> ${password} </password>
 </serverIdentity>
</authentication>
```

The serverIdentity element has the following 3 subelements.

### **client**

Mandatory.

The SAP-Client to be used to contact the Netweaver Gateway.

**username**

Mandatory.

The user name for contacting the Netweaver Gateway.

**password**

Mandatory.

The password for contacting the Netweaver Gateway.

**sslCertificateAlias**

Optional for regular HTTP authentication and simple SSL authentication.

Mandatory for mutual SSL authentication.

The alias of the adapter private SSL key, which is used by the HTTP adapter key manager to access the correct SSL certificate in the keystore. For more information about the keystore setup process, see "SSL certificate keystore setup" on page 10-54.

**sslCertificatePassword**

Optional for regular HTTP authentication and simple SSL authentication.

Mandatory for mutual SSL authentication.

The password of the adapter private SSL key, which is used by the HTTP adapter key manager to access the correct SSL certificate in the keystore. For more information about the keystore setup process, see "SSL certificate keystore setup" on page 10-54.

**SAP JCo adapter connectionPolicy element:**

You can use the SAP Java Connector (SAP JCo) adapters to develop SAP-compatible components and applications in Java.

**Structure**

The connectionPolicy element has the following structure.

```
<connectionPolicy xsi:type="sapjco:JCOConnectionPolicy"
 jcoClientClient="001"
 jcoClientUser="userName"
 jcoClientPasswd="password"
 jcoClientLang="EN"
 jcoClientAsHost="mysapserver.ibm.com"
 jcoClientSysnr="01"
 maxConnections="10"
/>
```

**Attributes**

The connectionPolicy element has the following attributes.

**xsi:type**

Mandatory.

The value of this attribute must be set to sapjco:JCOConnectionPolicy.

**jcoClientClient**

Mandatory.

The SAP client.

**jcoClientUser**

Mandatory.

The logon user.

**jcoClientPasswd**

Mandatory.

The logon password.

**jcoClientLang**

Mandatory.

The logon language.

**jcoClientAsHost**

Mandatory.

The application server.

**jcoClientSysnr**

Mandatory.

The SAP system number.

**maxConnections**

Mandatory.

The maximum number of connections that are allowed for the pool.

**SQL adapter connectionPolicy element:**

You can use the MobileFirst SQL adapter to run SQL queries with parameters and stored procedures that retrieve or update data in the database.

**Structure**

The connectionPolicy element has two options for connection:

- The dataSourceDefinition subelement: for development mode.
- The dataSourceJNDIName subelement: for production mode.

Connecting by using the dataSourceDefinition subelement:

```
<connectionPolicy xsi:type="sql:SQLConnectionPolicy">
 <dataSourceDefinition>
 <driverClass>com.mysql.jdbc.Driver</driverClass>
 <url>jdbc:mysql://localhost:3306/mydb</url>
 <user>myUsername</user>
 <password>myPassword</password>
 </dataSourceDefinition>
</connectionPolicy>
```

Connecting by using the dataSourceJNDIName subelement:

```
<connectionPolicy xsi:type="sql:SQLConnectionPolicy">
 <dataSourceJNDIName>jdbc/myAdapterDS</dataSourceJNDIName>
</connectionPolicy>
```



## Attributes

The `connectionPolicy` element has the following attributes.

### **xsi:type**

Mandatory.

The value of this attribute must be set to `sql:SQLConnectionPolicy`.

## Subelements

The `connectionPolicy` element contains either of the following subelements.

### **dataSourceDefinition**

Mandatory

Contains the parameters that are needed to connect to a data source. The `url`, `user`, `password`, and `driverClass` parameters can be externalized as custom properties. Then, they can then be overridden by environment entries.

The following example illustrates this process.

`adapter.xml`:

```
<connectionPolicy xsi:type="sql:SQLConnectionPolicy">
 <dataSourceDefinition>
 <driverClass>com.mysql.jdbc.Driver</driverClass>
 <url>${my-mysql-url}</url>
 <user>${my-mysql-user}</user>
 <password>${my-mysql-password}</password>
 </dataSourceDefinition>
</connectionPolicy>
```

`worklight.properties`:

```
my-mysql-url=jdbc:mysql://localhost:3306/mysqldbname
my-mysql-user=user_name
my-mysql-password=password
```

### **dataSourceJNDIName**

Mandatory.

Connect to the data source by using the JNDI name of a data source that is provided by the application server. Application servers provide a way to configure data sources. For more information, see “Creating and configuring the databases manually” on page 10-17.

You can also externalize the data source JNDI name and make it configurable from the server configuration. For example:

`adapter.xml`

```
<connectionPolicy xsi:type="sql:SQLConnectionPolicy">
 <dataSourceJNDIName>${my-adapter-ds}</dataSourceJNDIName>
</connectionPolicy>
```

`worklight.properties`

```
my - adapter - ds = jdbc / myAdapterDS
```

For more information, see “Configuring a MobileFirst project in production by using JNDI environment entries” on page 10-60.

## Developing JavaScript adapters

Learn to configure a new IBM MobileFirst Platform Foundation for iOS JavaScript adapter, and set up connectivity to back-end configuration.

### Creating a JavaScript MobileFirst adapter:

Follow these instructions to create a MobileFirst project and configure a new MobileFirst adapter.

#### About this task

On initial creation of a new adapter, MobileFirst automatically generates the default skeleton for the adapter with all the required properties, based on the type (HTTP, SQL, or JMS). You need only to modify the default skeleton to configure an adapter.

#### Procedure

1. Optional: Perform this step only if you do not already have an existing MobileFirst project. If you set up MobileFirst shortcuts, right-click anywhere within the Eclipse Project Explorer view and click **New > MobileFirst Project**. Otherwise, click **New > Other**, then select **MobileFirst > MobileFirst Project** from the list of wizards and click **Next**.

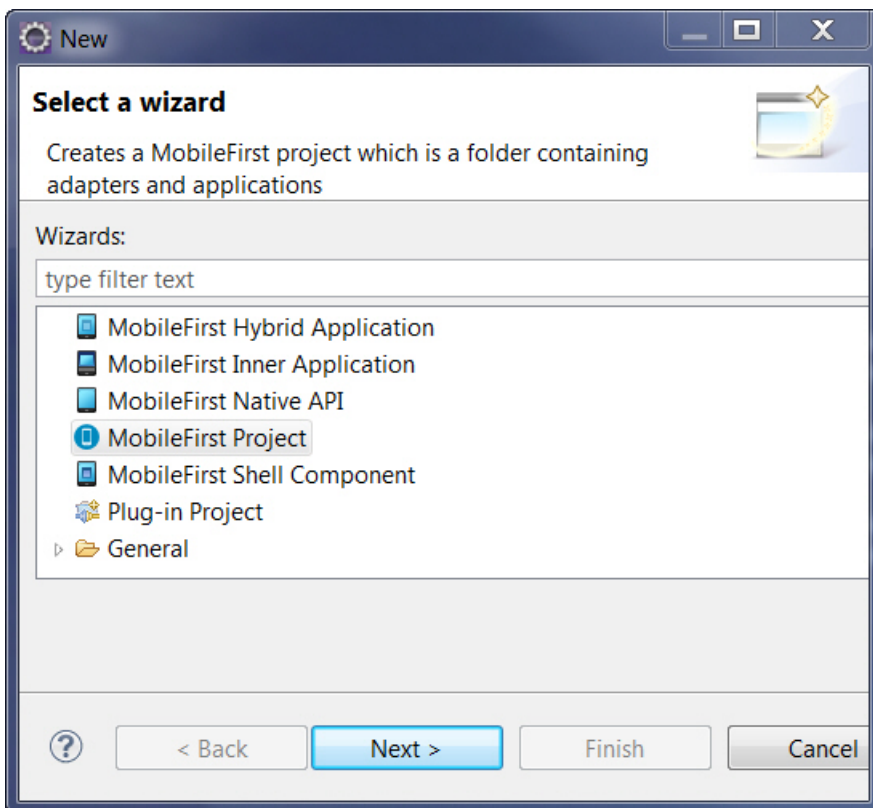

Figure 8-7. Creating a MobileFirst project from the wizard.

2. In the **New MobileFirst Project** wizard, specify a name for the project and click **Finish**.
3. If you set up MobileFirst shortcuts, right-click the MobileFirst Project to which you want to add the adapter, and select **New > Adapter**. Otherwise, select **New**

> **Other**, then select **MobileFirst > MobileFirst Adapter** from the list of wizards and click **Next**.  
The **New Adapter** wizard opens.

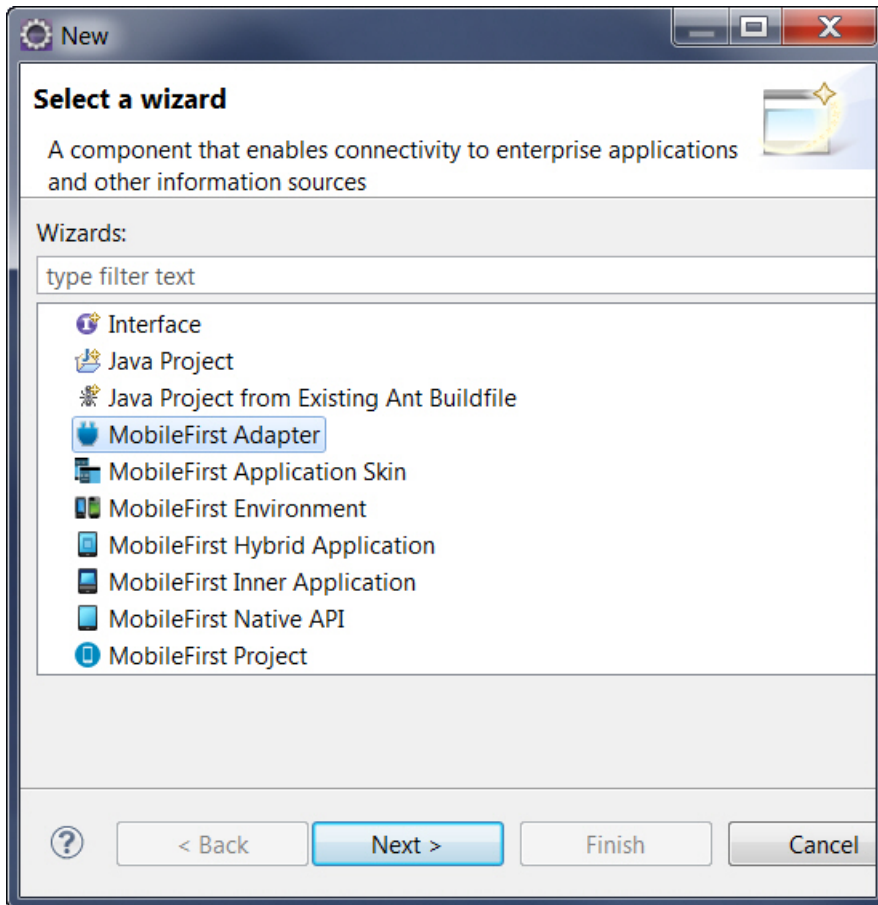

Figure 8-8. Configuring a new MobileFirst adapter.

4. Select the required adapter type from the **Adapter type** list and enter a name for the adapter in the **Adapter name** field.

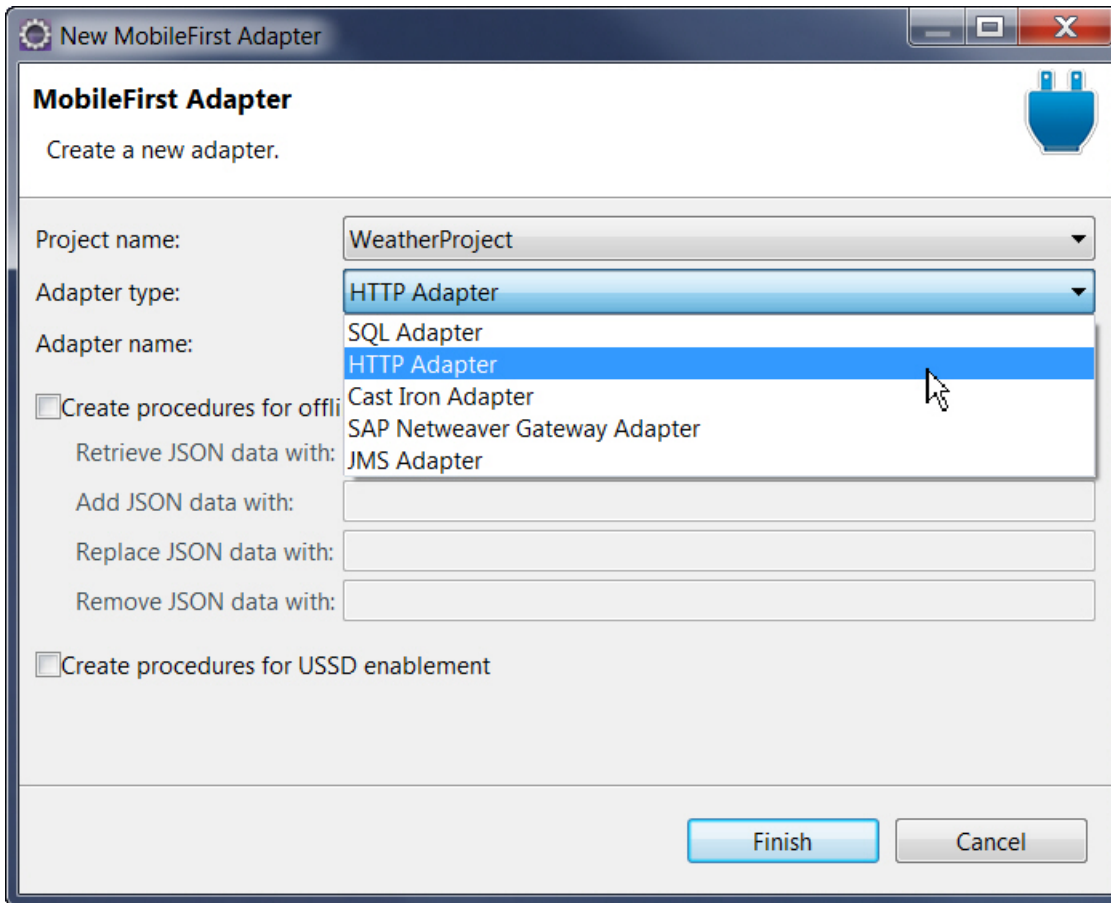

Figure 8-9. Selecting an adapter type.

5. Optional:
  - Select **Create procedures for offline JSONStore** to include four place holder procedures in the adapter template: a procedure that gets data, a procedure that adds data, a procedure that replaces data, and a procedure that removes data. These procedures are designed to help you develop a JSONStore-enabled application that communicates with a back end.
  - Select **Create procedures for USSD enablement** to generate sample procedures for USSD in the adapter js file.
6. Click **Finish**.

*Generating adapters with the services discovery wizard:*

With the services discovery wizard, you specify the back-end services that you want to invoke from your MobileFirst project, and generate the adapters that connect to those services.

The services discovery wizard supports the following types of back-end services:

- IBM Business Process Manager (IBM BPM) process applications. Discover IBM BPM process applications and generate the generic and application-specific adapters.
- RESTful resources. Describe a RESTful resource by accessing your back-end service.

- Services that are exposed by an SAP Netweaver Gateway. These services are resource-based, which means that they expose a collection of resources that you can manipulate. Like web services, they can also have custom procedural operations, and generate inputs and outputs.
- Web Services, as described by Web Services Description Language (WSDL) files. These services are procedural in nature, with inputs and outputs that are explicit. For example, when a web service calls a remote procedure, it gets a result.

The adapters that communicate with the chosen back-end service are automatically generated, and placed in the **adapters** folder of your project.

**Note:** If you manually modify an adapter file, first create a copy of this file, and make sure to modify only the copied file. The services discovery wizard might regenerate the original file each time you add a service. The exact adapter that is regenerated depends on the type of service that is involved.

*Generating adapters with IBM BPM:*

You can use the Add Service Wizard to select an active snapshot and generate an adapter that provides access to the IBM Business Process Manager (IBM BPM) REST APIs.

### Procedure

1. Right-click the **services** folder of your project in the Project Explorer tab, and click **Discover Back-end Services**. The Add Service Wizard window opens.

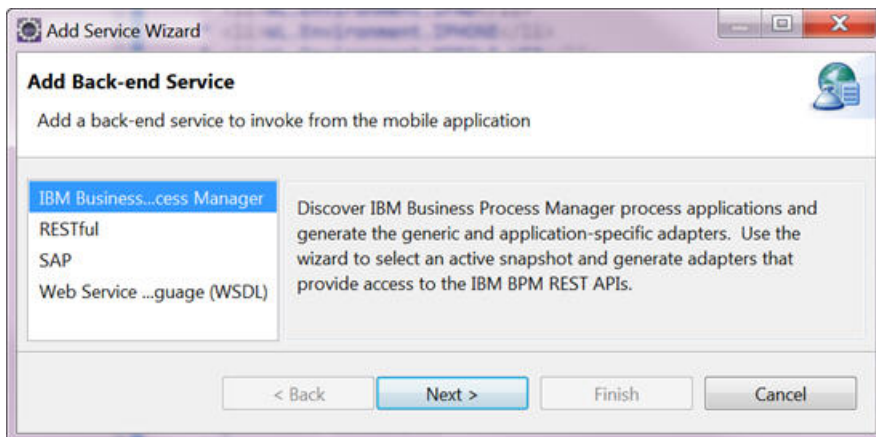

Figure 8-10. The Add Service Wizard

2. Select **IBM Business Process Manager** and click **Next**. The IBM BPM process applications page is displayed.
3. You can set up a connection to an IBM BPM server if you complete one of the following choices.
  - Click **Add** next to the **Connections** field.
  - Click **Manage IBM BPM Connections** to edit existing connections.
    - a. Click **Add**.
  - Select an existing IBM BPM connection from the drop-down list in the **Connections** field.

4. Enter your server URL, user, and password credentials and click **OK**. The IBM BPM process applications and their available active snapshots are visible in the **Select Snapshot** field.
5. Expand the process application that you want to create an adapter for, select a snapshot, and click **Next**.
6. Name your adapter and click **Finish**.

## Results

A generic adapter and an application-specific adapter are generated under the **adapters** folder of your project. You can use this adapter to access IBM BPM REST APIs on the IBM BPM server.

The project's `/server/conf/worklight.properties` file is also updated to include the necessary IBM BPM server properties.

*Generating adapters by describing RESTful resources:*

You can use the Add Service wizard to describe a RESTful resource to access your back-end service. Use the wizard to describe URL segments that are dynamic parameters to generate MobileFirst adapters.

## Procedure

1. Right-click the **services** folder of your project in the Project Explorer tab, and click **Discover Back-end Services**. The Add Service Wizard window opens.
2. Select **RESTful** and click **Next**.  
The **Resource Structure** page is visible.

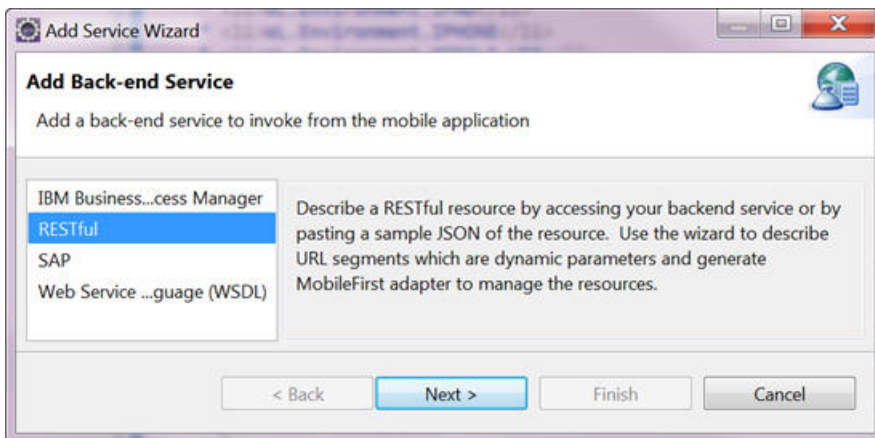
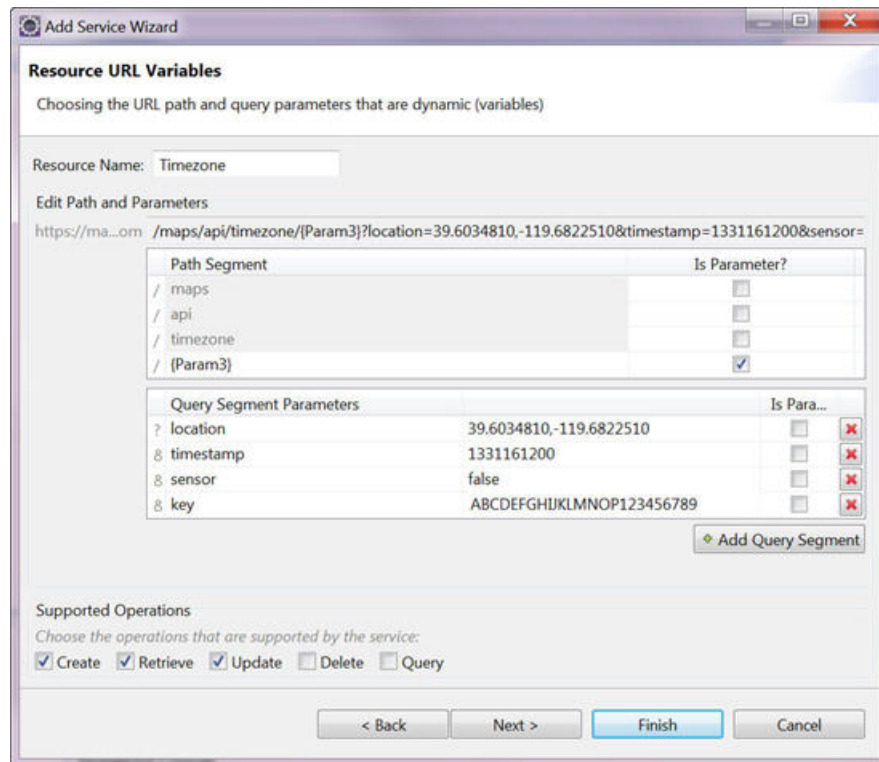

Figure 8-11. The Add Service Wizard

3. Complete the **Resource Structure** page.
  - a. Type the URL to the resource into the **Resource URL** field and complete one of the following choices.
    - Click **Fetch URL** to retrieve a JSON payload from the URL entered and display it in the **Sample Resource (as JSON)** field.  
You might need to set up authentication and custom headers before you click **Fetch URL**.
    - Manually enter a sample JSON payload in the **Sample Resource (as JSON)** field.

The **Sample Resource (as JSON)** field is completed with the JSON code that results from the provided URL. That JSON code is parsed into build structures that are visible in the **Resource Structure** field.

- b. From the **Resource Structure** field, select which parameter is the **Key**.
  - c. Select the level of authentication from the **Authentication** field.
    - **None:** Authentication is not needed.
    - **Basic Authentication:** Authentication is needed. The user ID and password are sent in clear text, according to HTTP Basic Authentication guidelines.
    - **Digest:** Authentication is needed. The user ID and password are sent by using HTTP Digest authentication (as a hash).
  - d. If you need specific HTTP headers to communicate with the back-end service, complete the **Request Custom HTTP Header** fields. The left column is the header name, and the right column is the value. The drop-down list on the left includes a set of HTTP header names. Or, you can type any header name.
  - e. Click **Next**.
4. From the Resource URL Variables page, select the settings for your adapter.



5. To customize resource operations, click **Next**. Otherwise, click **Finish**.
6. If you clicked **Next**, customize your resource operations.
  - a. Choose the **HTTP Method** for each operation.

Table 8-3. HTTP methods

Method	Safe	Idempotent	Cacheable	Description
GET	Yes	Yes	Yes	Retrieves information from the input server by using the input URI
PUT	No	Yes	No	Puts or updates a resource on the server
POST	No	No	No	Sends data to the server
DELETE	No	Yes	No	Deletes the requested resource

- b. Complete the **Edit path and parameters** field.
- c. If you need specific HTTP headers to communicate with the back-end service, complete the **Request Custom HTTP Header** fields. The left column is the header name, and the right column is the value. The drop-down list on the left includes a set of HTTP header names. Or, you can type any header name.
- d. Click **Finish**.

### Results

- An adapter is generated under the **adapters** folder of your project. You can use this adapter to invoke services with JavaScript calls.
- A **.xml** service description file is also generated under the **services** folder of your project. You can refer to the **.xml** files under the **services** folder of your project to have a summary view of the target adapters.

### Generating adapters with SAP Gateway:

You can use the Add Service Wizard to discover services that are exposed by an SAP Gateway and generate MobileFirst adapter for invoking the services.

### Procedure

1. Right-click the **services** folder of your project in the Project Explorer tab, and click **Discover Back-end Services**. The Add Service Wizard window opens.



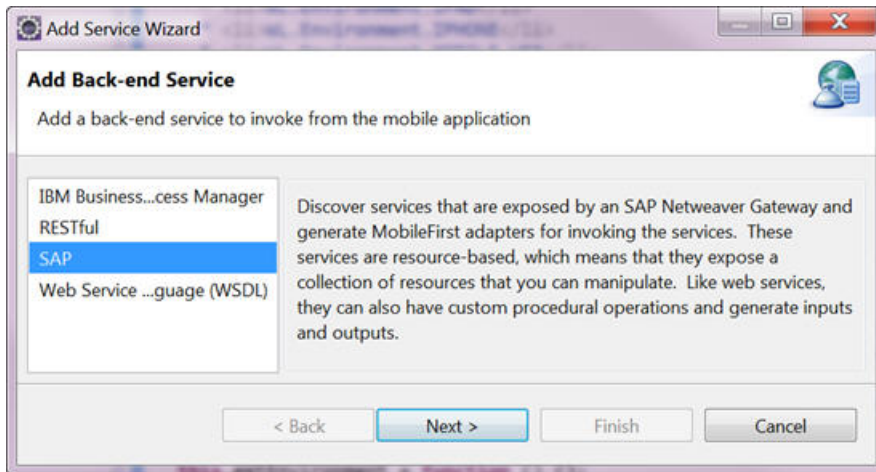

Figure 8-12. The Add Service Wizard

2. Select **SAP** and click **Next**.
3. Set up a connection to an SAP Netweaver Gateway server by either:
  - Clicking **Add** to create an SAP connection.
  - Clicking the **Manage SAP Connections** link to edit existing connections.
  - Selecting an existing SAP connection from the **Connection** list.
4. Proceed with the connection configuration by entering your server URL, client ID, user name, and password. In the **Select Service** pane, you can now see the list of SAP services that are available on the server you specified.
5. Click **Finish**.

### Results

- An adapter is generated under the **adapters** folder of your project. You can use this adapter to invoke services with JavaScript calls.
- An **.xml** service description file is also generated under the **services** folder of your project. You can refer to the **.xml** files under the **services** folder of your project to have a summary view of the target adapters.

### *Generating adapters with WSDL:*

You can use the Add Service Wizard to discover and generate MobileFirst adapters for invoking a SOAP-based Web Service. You can import a Web Service Definition Language (WSDL) of the service from your file system, workspace, or remotely by typing its URL in the wizard.

### Procedure

1. Right-click the **services** folder of your project in the Project Explorer tab, and click **Discover Back-end Services**. The Add Service Wizard window opens.

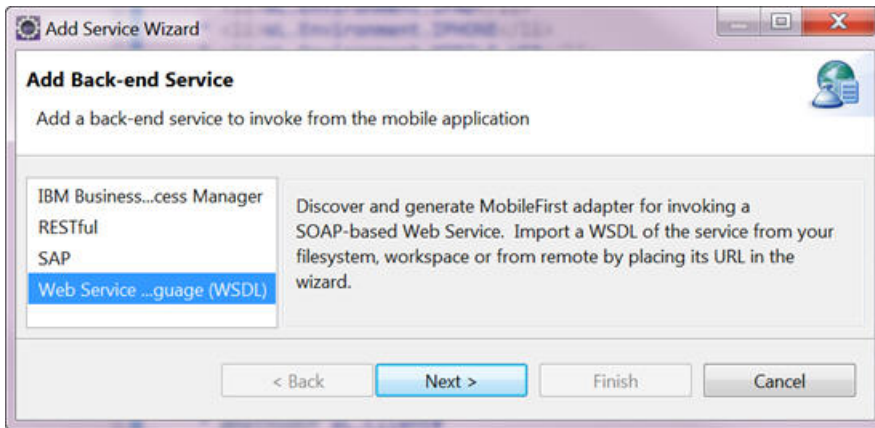
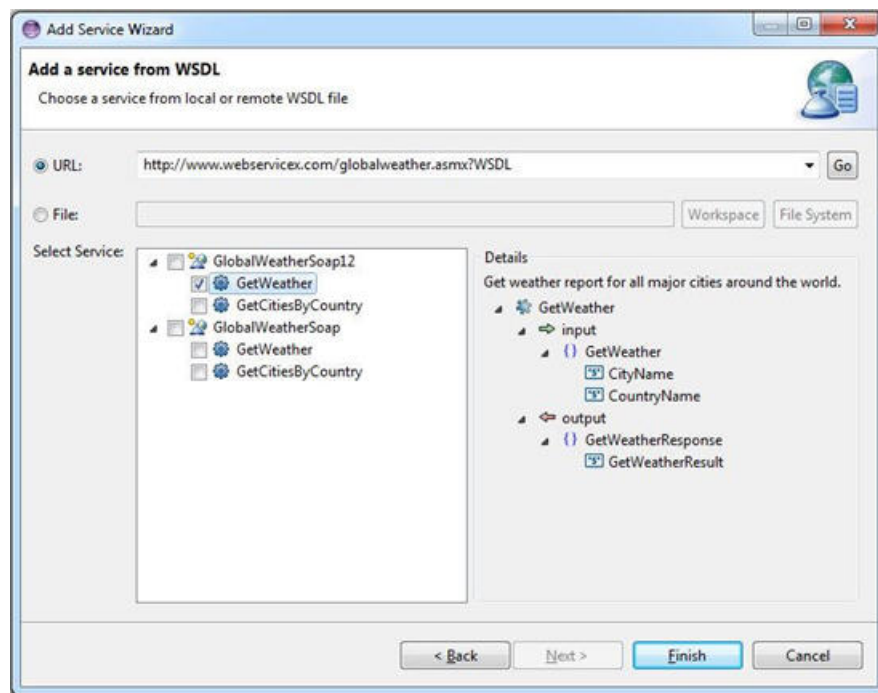

Figure 8-13. The Add Service Wizard

2. Select **Web Service Definition Language (WSDL)** and click **Next**.
3. Complete the Add a Service from WSDL page. Enter a URL or select one from the **URL** drop-down list, and click **Go**. Or browse to a file in your workspace or in your system.



- a. Enter a URL or select one from the **URL** drop-down list, and click **Go**.

**Note:** If you enter a secure URL (https), the system fetches the certificate from the specified server, and stores it into a private key storage area that is created in your workspace.

- b. Optional. If you are prompted to, enter your credentials. You can now see the list of available services. Different types of information are displayed in the **Details** pane, depending on the level you select:
  - The first level corresponds to the binding configuration details. When this level is selected, the **Details** pane shows the SOAP version.

- The second level corresponds to the data operation details. When this level is selected, the **Details** pane shows the input and the output of the remote invoked procedure.
- c. Select one or more services that you want to invoke from your application.
4. Click **Finish**.

## Results

- An adapter is generated under the **adapters** folder of your project. You can use this adapter to invoke services with JavaScript calls.
- An .xml service description file is also generated under the **services** folder of your project. You can refer to the .xml files under the **services** folder of your project to have a summary view of the target adapters.  
A sample payload of each service is available from the Properties dialog box of the service. You can reuse this sample payload in other adapters. To use the sample payload of a service:
  1. Right-click the service name in the services folder of your project in the Eclipse Project Explorer view, and click **Properties**.
  2. Copy the text from the **Sample Procedure Parameter** field.

*Invocation of generated SOAP adapters:*

The generated SOAP adapters have a procedure that calls the back-end service operation. You can invoke this procedure from your MobileFirst application in the same way as you invoke other MobileFirst adapter procedures, by providing the necessary parameters for the invocation.

The generated procedure accepts two parameters: the message to the service, and custom HTTP headers.

### The message to send to the service (required)

This mandatory parameter is the message to send to the service in JSON format.

The message parameter is a JSON representation of the XML message to include in the SOAP body that is sent to the service.

The following examples show JSON representations for sample XML messages.

1. Simple XML message: the adapter converts the provided JSON parameter into XML body by creating a matching element for each JSON attribute.

The following JSON parameter in the procedure:

```
{"GetTechnicianVisits": {"TechnicianId": "1"}}
```

is transformed by the adapter into the following XML fragment in the SOAP body:

```
<GetTechnicianVisits>
 <TechnicianId>1</TechnicianId>
</GetTechnicianVisits>
```

2. XML messages with namespaces

The generated adapter implementation (SoapAdapterX-impl.js) has a set of namespace prefixes imported from the provided WSDL service. To specify elements with specific namespaces, those prefixes must be used to name the relevant JSON attributes.

The following JSON parameter in the procedure:

```
{"tns1:GetTechnicianVisits": {"tns1:TechnicianId": "1"}}
```

is transformed by the adapter into the following XML fragment in the SOAP body:

```
<GetTechnicianVisits xmlns:tns1="http://namespace/sample">
 <TechnicianId>1</TechnicianId>
</GetTechnicianVisits>
```

**Note:** Since IBM MobileFirst Platform Foundation for iOS V6.2.0, if the names of the elements are unique, the generated SOAP adapters no longer require the use of namespace prefixes on all the fields in the payload.

### 3. XML messages with attributes

Adding the @ prefix to a JSON attribute name instructs the adapter to create an attribute instead of creating an element.

The following JSON parameter in the procedure:

```
{"GetTechnicianVisits": {"@technicianId": "1"}}
```

is transformed by the adapter into the following XML fragment in the SOAP body:

```
<GetTechnicianVisits technicianId="1"/>
```

### A JSON object that holds custom HTTP headers for the invocation (optional)

This optional parameter is a JSON object that lists custom HTTP headers (key values). These custom HTTP headers are added to the service call when the POST request is invoked with the generated SOAP message.

```
{ 'custom-header-1': 'value1', 'custom-header-2': 'value2' }
```

### Setting up connectivity to back-end configuration:

Learn about adapter timeout and concurrency, connectivity for non-Java adapters, and developing JavaScript adapter code.

*Adapter timeout and concurrency:*

Changes in the behavior of adapter timeout and concurrency starting in IBM MobileFirst Platform Foundation for iOS V6.3 have impact on the adapter XML schema.

### Timeout and concurrency in IBM MobileFirst Platform Foundation for iOS V6.3

Starting in IBM MobileFirst Platform Foundation for iOS V6.3, the behavior of timeout and concurrency was modified for HTTP-based, JMS, and SQL adapters.

#### HTTP-based adapters

In earlier versions of IBM MobileFirst Platform Foundation for iOS, timeout and concurrency were handled by thread pools. They are now enforced by the underlying HTTP framework.

- Timeout:

Previously, you were able to define a timeout for a single procedure. Starting from V6.3, you can use the standard socket timeout and connection timeout that are provided by HTTP frameworks. A socket timeout defines the time between two consecutive packets, starting from the connection packet. A connection timeout defines the time within which a connection to the back-end must be established.

You can set the socket and connection timeouts in two places:

- To set the default value for an adapter, set it in the adapter XML file. For more details on timeout in the XML file, see “Structure of the adapter XML file” on page 8-96.
- To set the timeouts for a specific back-end invocation, use the **options** struct in the `invokeHttp()` JavaScript function. For more information, see the `WL.Server` class.

- **Concurrency:**

You use the **<maxConcurrentConnectionsPerNode>** subelement of the **<connectionPolicy>** element in the adapter XML file to set concurrency limits. For more information, see “Structure of the adapter XML file” on page 8-96.

### JMS adapters

- **Timeout:** JMS adapter provides several timeout specifications based on the action that is attempted. There has been no change in functionality in that sense but the per-procedure timeout has been removed.
- **Concurrency:** Starting from IBM MobileFirst Platform Foundation for iOS V6.3, concurrency is no longer supported for JMS adapters.

### SQL adapters

Previously, concurrency and timeout were handled by thread pools. Starting from V6.3, the only method to define concurrency and timeout, is to use the SQL Connection Pool obtained using a JNDI reference.

### XML schema changes in IBM MobileFirst Platform Foundation for iOS V6.3

IBM MobileFirst Platform Foundation for iOS V6.3 uses a new adapter XML schema. Adapters using earlier schemas cannot be used in Studio V6.3 and CLI V6.3. The following changes are made to the adapter schema during upgrade:

- The **requestTimeoutInSeconds** attribute of the **<procedure>** element is no longer supported. During project upgrades to IBM MobileFirst Platform Foundation for iOS V6.3, the attribute is commented out in all **<procedure>** elements.
- The **<loadConstraints>** element and its attributes are no longer supported. During project upgrades to IBM MobileFirst Platform Foundation for iOS V6.3, this element is removed.
- In HTTP-based adapters, there are three new elements: **<connectionTimeoutInMilliseconds>**, **<socketTimeoutInMilliseconds>**, and **<maxConcurrentConnectionsPerNode>** under **<connectionPolicy>**. During project upgrades to IBM MobileFirst Platform Foundation for iOS V6.3, these new elements are added. For more information, see “Structure of the adapter XML file” on page 8-96.

### Compatibility with earlier versions

Adapters from previous version work and can be deployed on the MobileFirst Server V6.3. However, they behave differently, as described below.

### HTTP-based adapters

- **Timeout:**  
The value of the **requestTimeoutInSeconds** attribute of **<procedure>** elements is now used to set the value of the HTTP socket timeout and connection timeout per procedure. For more information about socket and connection timeout see "HTTP-based adapters" in Adapter timeout and concurrency changes.
- **Concurrency:**  
The concurrency limits are enforced by the underlying HTTP framework, instead of by a thread pool.

### JMS adapters

The **requestTimeoutInSeconds** attribute of **<procedure>** and **<loadConstraints>** elements is ignored.

### SQL adapters

The **requestTimeoutInSeconds** attribute of **<procedure>** and **<loadConstraints>** elements is ignored. Use JNDI configuration instead.

### Adapter invocation failures due to large data

Adapter calls are not intended for returning very large JSON data. The adapter response is stored in memory and string parsed. Data that exceeds the amount of available memory might cause adapter invocation to fail. To reduce the possibility that such a failure occurs, limit the amount of data to less than 10 MB.

#### *Connectivity for non-Java adapters:*

With IBM MobileFirst Platform Studio, you can configure back-end connectivity for non-Java adapters.

#### *HTTP adapters:*

The MobileFirst HTTP adapter can be used to invoke RESTful services and SOAP-based services. It can also be used to perform HTML scraping.

You can use the HTTP adapter to send GET, POST, PUT, and DELETE HTTP requests and retrieve data from the response body. Data in the response can arrive in XML, HTML, or JSON formats.

You can use SSL in an HTTP adapter with simple and mutual authentication to connect to back-end services. Configure the MobileFirst Server to use SSL in an HTTP adapter by implementing the following steps:

- Set the URL protocol of the HTTP adapter to `https`.
- Store SSL certificates in a keystore that is defined by using JNDI environment entries. The keystore setup process is described in "SSL certificate keystore setup" on page 10-54.
- If you use SSL with mutual authentication, the following extra steps must also be implemented:
  - Generate your own private key for the HTTP adapter or use one provided by a trusted authority.
  - If you generated your own private key, export the public certificate of the generated private key and import it into the back-end truststore.
  - Save the private key of the keystore that is defined by using JNDI environment entries.

- Define an alias and password for the private key in the <connectionPolicy> element of the HTTP adapter XML file, *adaptername.xml*. The <sslCertificateAlias> and <sslCertificatePassword> subelements are described in “HTTP adapter connectionPolicy element” on page 8-101.
- If you use WebSphere Application Server, you can take benefit of the WebSphere SSL configuration as described in “WebSphere Application Server SSL configuration and HTTP adapters” on page 10-54.

Note, however that SSL represents transport level security, which is independent of basic authentication. It is possible to do basic authentication either over HTTP or HTTPS.

*Encoding a SOAP XML envelope:*

Follow these instructions to encode a SOAP XML envelope within a request body

### About this task

**Important:** This workaround is only for WebSphere Application Server.

### Procedure

1. Encode XML within JavaScript by using E4X.

E4X is officially part of JavaScript 1.6. This technology can be used to encode any XML document, not necessarily SOAP envelopes. You can use the `WL.Server.signSoapMessage()` method only inside a procedure declared within an HTTP adapter. It signs a fragment of the specified envelope with ID `wsId` by using the key in the specified **keystoreAlias**, and inserting the digital signature into the input document.

To use `WL.Server.signSoapMessage()` API when running IBM MobileFirst Platform Foundation for iOS on IBM WebSphere Application Server, you might need to add a JVM argument that instructs the application server to use a specific **SOAPMessageFactory** implementation instead of a default one.

2. To do this, go to **Application servers > {server\_name} > Process definition > Java Virtual Machine** and provide the following argument under **Generic JVM arguments**.

Type in the code phrase exactly as it is presented here:

```
-Djavax.xml.soap.MessageFactory=com.sun.xml.internal.messaging
.saaj.soap.ver1_1.SOAPMessageFactory1_1Impl
```

3. Restart the JVM.

### Example

```
var request =
<S:Envelope xmlns:S="http://schemas.xmlsoap.org/soap/envelope/">
<S:Body>
<requestMessageObject xmlns="http://acme.com/ws/">
<messageHeader>
<version>1.0</version>
<originatingDevice>{originatingDevice}</originatingDevice>
<originatingIP>
{WL.Server.configuration["local.IPAddress"]}
</originatingIP>
<requestTimestamp>
{new Date().toLocaleString()}
</requestTimestamp>
</messageHeader>
<messageData>
<context>
```

```
<userkey>{userKey}</userkey>
<sessionid>{sessionid}</sessionid>
</context>
</messageData>
</requestMessageObject>
</S:Body>
</S:Envelope>;
```

*NTLM configuration for HTTP adapters:*

NTLM uses a challenge-response mechanism for authentication. Learn how to use a MobileFirst adapter when connecting to a back end or resource that is protected by NTLM protocol.

### Back-end connection types

MobileFirst Server can connect with a back-end system or resource that is protected by NTLM protocol, either as a server or as an end-user.

#### Connect as server

In this connection type, all sessions use the same connection context to the back end. This is the default MobileFirst Server behavior. See Figure 1.

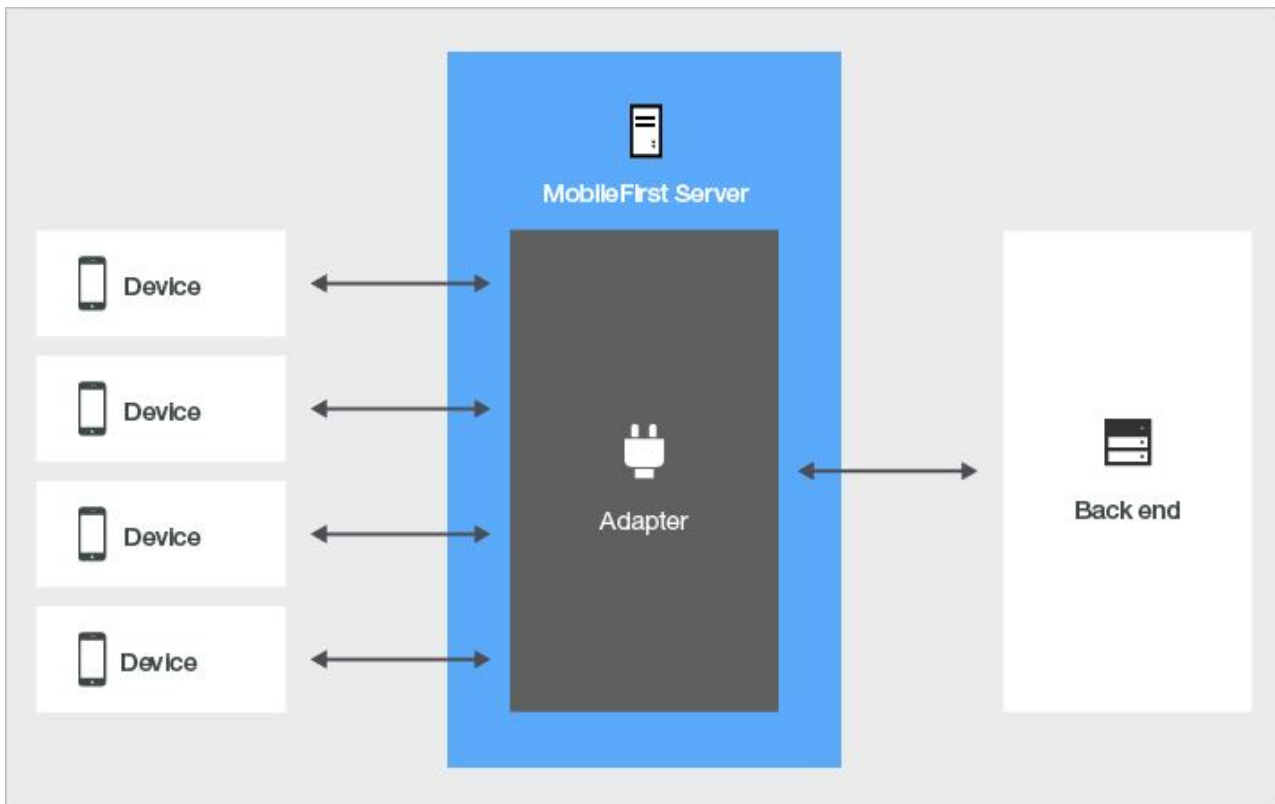

Figure 8-14. Connecting to the back end as server

#### Connect as end user

In this connection type, each session is authenticated separately and has a unique connection context against the back end. See Figure 2.



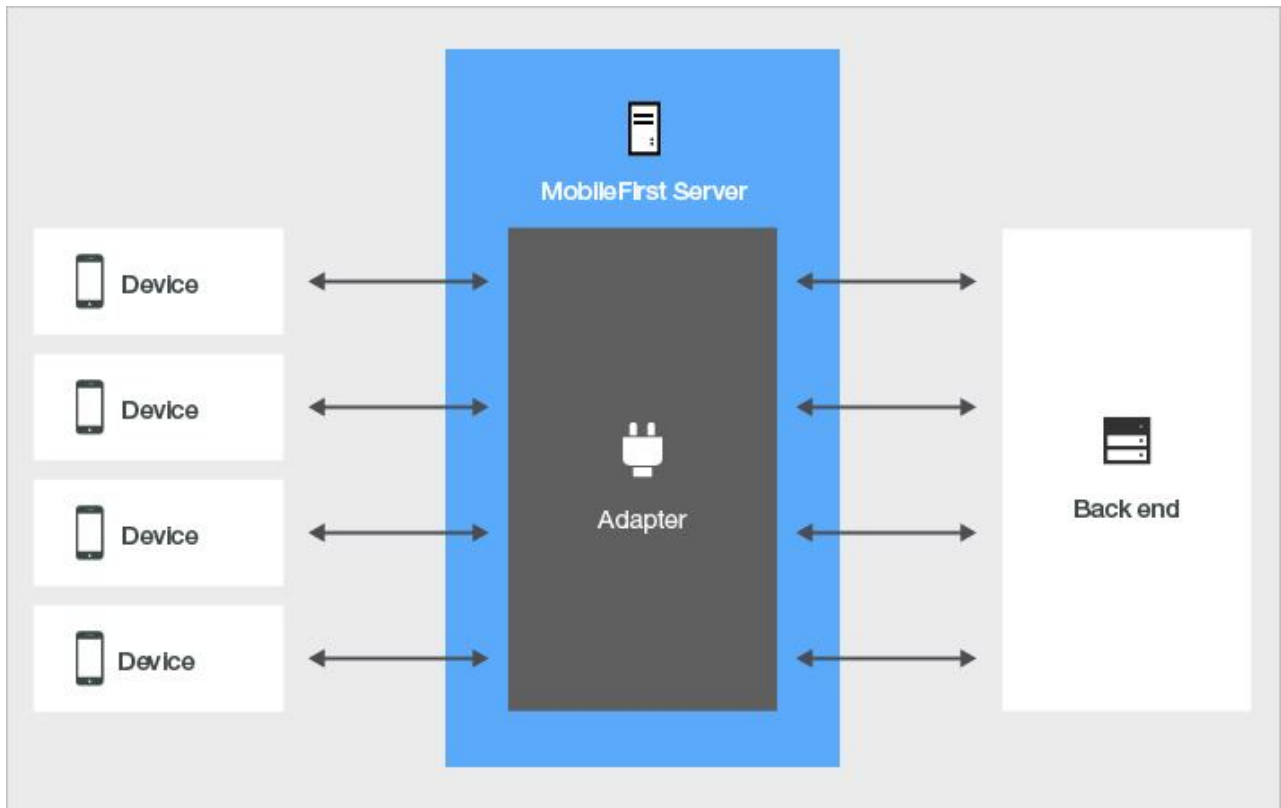

Figure 8-15. Connecting to the back end as end user

### Back-end connection settings

The connection types that are described in the previous section correspond to the server and endUser options of the connectAs attribute in the adapter XML file.

- To connect as server (the default), there is no need to make any configuration change to the adapter.xml file.
- To connect as an end-user, add a procedure element to the adapter XML file, as follows:

```
<procedure name= "MyProcedure" connectAs= "endUser" />
```

For more information about the connectAs attribute, see “Structure of the adapter XML file” on page 8-96.

#### *Implementing NTLM authentication for server requests:*

Implement NTLM authentication where a single, shared instance of HTTP client is used per adapter for all mobile application instances.

### About this task

By default, procedures that connect to a back-end server that uses NTLM protocol are handled on a server-to-server basis, as the connectAs attribute is defined as =“server”. You need only configure serverIdentity of the adapter XML file as a subelement of the authentication. You also add the ntlm workstation attribute, so that MobileFirst Server knows which authentication method to use when connecting to the back end.

## Procedure

1. Open the adapter.xml file of the project.
2. Add an authentication element as follows:

```
<connectivity>
 <connectionPolicy xsi:type="http:HTTPConnectionPolicyType">
 <protocol>http</protocol>
 <domain>your-domain-here</domain>
 <port>80</port>
 <connectionTimeoutInMilliseconds>30000</connectionTimeoutInMilliseconds>
 <socketTimeoutInMilliseconds>30000</socketTimeoutInMilliseconds>
 <authentication>
 <ntlm workstation="ServerName"/>
 <serverIdentity>
 <username>your-server-name-here/your-username-here</username>
 <password>your-password-here</password>
 </serverIdentity>
 </authentication>
 <maxConcurrentConnectionsPerNode>50</maxConcurrentConnectionsPerNode>
 </connectionPolicy>
</connectivity>
```

**Note:** When the NTLM protocol is used, the user name must always be specified in the format: server-name/user-name. Ensure that in the adapter.xml file, you pass the server and user names to the back-end server in that pattern. For more information, see “HTTP adapter connectionPolicy element” on page 8-101.

*Implementing NTLM authentication for end-user requests:*

Implement NTLM authentication where a separate instance of HTTP session is opened for each client session.

## About this task

To enable NTLM authentication with connectAs="endUser", you configure the server and add handling functions in the adapter.

*Configure MobileFirst Server authentication:*

## Procedure

1. In the authenticationConfig.xml file for your project, make the following edits:

- a. Create a security test to protect the procedure:

```
<customSecurityTest name="NTLMSecurityTest">
 <test isInternalUserID="true" realm="NTLMAuthRealm"/>
</customSecurityTest>
```

- b. Use BasicAuthenticator, AdapterBasedAuthenticator, or any other authenticator that handles userIdentity, as the class for the realm to be used by the security test:

```
<realm name="NTLMAuthRealm" loginModule="AuthLoginModule">
 <className>com.worklight.integration.auth.AdapterAuthenticator</className>
 <parameter name="login-function" value="MyAdapter.onAuthRequired"/>
 <parameter name="logout-function" value="MyAdapter.onLogout"/>
</realm>
```

- c. Add a login module to create and store user identities to be used by this realm:

```
<loginModule name="AuthLoginModule">
 <className>com.worklight.core.auth.ext.NonValidatingLoginModule</className>
</loginModule>
```

2. In the adapter.xml file, make the following edits:
  - a. Add the authentication element and its ntlm workstation subelement to the adapter XML file, so that MobileFirst Server knows which authentication method to use when connecting to the back end:

```
<connectivity>
 <connectionPolicy xsi:type="http:HTTPConnectionPolicyType">
 <protocol>http</protocol>
 <domain>Put.Your.Domain.Here</domain>
 <port>80</port>
 <connectionTimeoutInMilliseconds>30000</connectionTimeoutInMilliseconds>
 <socketTimeoutInMilliseconds>30000</socketTimeoutInMilliseconds>
 <authentication>
 <ntlm workstation="wl-ntlm"/>
 </authentication>
 <maxConcurrentConnectionsPerNode>50</maxConcurrentConnectionsPerNode>
 </connectionPolicy>
</connectivity>
```

- b. Assign this security test to the procedure that is used to connect to the back end protected by the NTLM protocol, and add connectAs="endUser" to the procedure declaration in the adapter XML file:

```
<procedure name= "getNTLMData" securityTest= "NTLMSecurityTest" connectAs= "endUser"/>
```

*Create adapter functions:*

#### **Procedure**

1. Define the submitAuthentication function. Create a userIdentity that contains a user identifier and credentials properties. Format the userId in the pattern servername/username:

```
function submitAuthentication(username, password){
 var userIdentity = {
 userId: "MyServerName\"/" + username,
 credentials: password
 };
 WL.Server.setActiveUser("NTLMAuthRealm", null);
 WL.Server.setActiveUser("NTLMAuthRealm", userIdentity);
 ...
}
```

For more information, see “Implementing adapter-based authenticators” on page 8-274.

2. Create an HTTP request to the NTLM-protected back end:

```
function getSecretData(){
 var input = {
 method : 'get',
 returnedContentType : 'html',
 path : "index.html"
 };
 return WL.Server.invokeHttp(input);
}
```

For more information, see the invokehttp() function in the WL.Server class.

*Back-end responses in adapters:*

Understanding the logic of invocation results both on the client side and inside adapters helps you handle different failure scenarios.

## HTTP adapter flow

For a general description of an adapter flow, see “MobileFirst JavaScript adapters” on page 8-94. The following sections explain how to handle back-end responses in the case of an HTTP adapter. A typical HTTP adapter flow might involve the following sequence of events:

1. The client (that is, the mobile app) uses the `invokeProcedure` method of the `WL.Client` class to invoke one of the adapter's procedures from the MobileFirst Server.
2. The adapter then uses the `invokeHttp` method of the `WL.Server` class to call the back-end service.
3. The adapter procedure processes the data from the back end and returns a JSON object to the client.
4. The client calls its `onSuccess` handler to process the data received by the adapter.

## Responses from the invoke procedure

The adapter flow starts with a `WL.Client` class `invokeProcedure` call, which supports `onSuccess` and `onFailure` handlers. Both handlers receive an object, which is a standard JSON object. The following table describes some of its properties:

*Table 8-4. Properties of the object received following the invoke procedure*

Property	Description
<code>isSuccessful</code>	Whether the procedure call is successful. <b>Note:</b> The text following the table explains the circumstances when a request is considered to be successful.
<code>status</code>	HTTP status code from the procedure call. This is not the HTTP code from the back-end service, only from the connection with the MobileFirst Server.
<code>errorCode</code>	A possible error code if the call is not successful.
<code>errorMsg</code>	A possible error message if the call is not successful.
<code>invocationContext</code>	An optional object that is sent in the procedure call and is returned as-is.
<code>invocationResult</code>	JSON object that is returned by your procedure call. This object may be augmented with additional data such as session information.

Which handler is called depends on the value of the `isSuccessful` property in the invocation result:

- If `isSuccessful` is set to `true`, `onSuccess` is called.
- If `isSuccessful` is set to `false`, `onFailure` is called.

As long as your adapter returns something, the procedure invocation is considered successful and so the `isSuccessful` property is set to `true`. The `isSuccessful` property is set to `false` under the following circumstances:

- When calling a procedure that does not exist.

- When calling an adapter that does not exist.
- When the MobileFirst Server is unresponsive (for example, due to a bad host name or because the MobileFirst Server is currently unavailable).
- When the invocation times out (you can set a timeout value as one of the `invokeProcedure` options).
- When the adapter throws an exception.
- When the code in the procedure specifically overwrites the `onSuccess` property.

The `isSuccessful` property is set to `false` if there is a connection issue between the client and the adapter; not if there is an error in the back-end service. This means, for example, that if your procedure calls a back-end service which returns an error (such as a "404" error) but your procedure still returns a valid JSON object, your procedure invocation is still considered to be successful from the perspective of the client. If you simply return the result of `invokeHttp` straight to the client, since you are returning something, `isSuccessful` is `true` by default and `onSuccess` is called. This may or may not be what you want to happen. You need to make sure that your procedure code is capable of handling cases when a back-end service returns an error.

### Invocations from the adapter to the back end

From your procedure, you call a remote back-end service by using the `invokeHttp` method of the `WL.Server` class. The returned object from this call is a JSON object that represents the result of the HTTP request. If the response is an XHTML or XML tree, it is converted to JSON. For example, if the response is an HTML page, you see a property called "html" (the root HTML tag) with the content tree inside.

The following table describes some of the other properties. Additional arbitrary properties might also be returned by the back-end service.

*Table 8-5. Properties of the object received following the invocation from the adapter to the back end*

Property	Description
<code>errors</code>	Array of errors during the request.
<code>isSuccessful</code>	Boolean value summarizing whether the request is successful. <b>Note:</b> The text following the table explains the circumstances when a request is considered to be successful.
<code>responseHeaders</code>	JSON object representing the different HTTP headers of the response.
<code>responseTime</code>	HTTP response time.
<code>statusCode</code>	HTTP status code of the remote invocation.
<code>statusReason</code>	Short text description that explains the status code.
<code>totalTime</code>	Response time plus any additional time for IBM MobileFirst Platform Foundation for iOS to complete processing or convert formats.

Similar to the client side, if `isSuccessful` is set to `true`, the data that you receive is not necessarily exactly what you expect. It merely indicates that something was returned. You can therefore assume that `isSuccessful` is `true` by default. This includes the following cases:

- The remote HTTP server returns an OK status code such as 200.
- The remote HTTP server returns **any valid status code** such as 2XX, 3XX, 4XX, 5XX, and other codes.

The `isSuccessful` property is set to `false` under the following circumstances:

- The HTTP host cannot be reached or is invalid.
- The HTTP request has timed out.

Because `isSuccessful` is set to `true` by default, you might not receive the data that you want or expect. For example, you might want a “404” error to be treated as a failure whereas IBM MobileFirst Platform Foundation for iOS considers it a success. You can use properties such as the `statusCode` property that is returned in the result of a `WL.Server.invokeHttp` call (or any other interesting data from the response) to decide if the procedure should be considered successful or not. You can then handle situations that should be considered unsuccessful in one of the following ways:

- Overwrite the `isSuccessful` property by setting its value to `false` in your JSON response.
- Consider the request as successful, set some custom flags in your JSON response, and handle the situation in your client's `onSuccess` handler. You might also want to place a `try/catch` block around your procedure code and handle any exceptions accordingly. If an exception is thrown, the client will receive an `isSuccessful` response that is set to `false`.

In a production environment, returning the result of the `invokeHttp` call back to the client might not be the ideal value to return at the end of the procedure for the following reasons:

- The meaning of a “successful” request might vary in different cases.
- The back-end response might include additional data that should not be forwarded to the client; such as certain response headers, architecture of the back end, or any data that is not relevant to the logic of the app. Instead, consider building a new JSON object with your own data, which might possibly include parts of the original response.

### Example

Here is an example of an adapter that receives a “404” error as a result of trying to get data from an invalid URL: `www.ibm.com/no-such-place`.

#### **adapt.xml**

This file can be generated using the **mfp add adapter** command. The back end host name is set to `www.ibm.com`.

```
<?xml version="1.0" encoding="UTF-8"?>
<wl:adapter name="adapt"
 xmlns:xsi="http://www.w3.org/2001/XMLSchema-instance"
 xmlns:wl="http://www.ibm.com/mfp/integration"
 xmlns:http="http://www.ibm.com/mfp/integration/http"

 <displayName>adapt</displayName>
 <description>adapt</description>
 <connectivity>
```

```

 <connectionPolicy xsi:type="http:HTTPConnectionPolicyType">
 <protocol>http</protocol>
 <domain>www.ibm.com</domain>
 <port>80</port>
 </connectionPolicy>
 </connectivity>
 <procedure name="test"/>
</wl:adapter>

```

### adapt-impl.js

This is the implementation of the procedure. It calls a remote URL and generates a response. If the HTTP status code is anything other than 200, the `isSuccessful` property is set to false.

```

function test(){

 var input = {
 method : 'get',
 path : 'no-such-place' //Replace this with a valid path to see success
 };
 var backendResponse = WL.Server.invokeHttp(input);
 var procedureResponse = {};

 if(backendResponse.isSuccessful && backendResponse.statusCode == 200){
 //For simplicity, considering only 200 as valid
 //Do something interesting with the data
 procedureResponse.interestingData = backendResponse.html.head.title;
 }
 else{
 procedureResponse.isSuccessful = false; //Overwrite to failure
 }

 return procedureResponse;
}

```

### main.js

The client app invokes the procedure. If the request is successful, the app logic continues. If the request is not successful, an error message is displayed.

```

WL.Client.invokeProcedure({
 adapter : 'adapt',
 procedure : 'test'
}, {
 onSuccess : function(result) {
 //Do something interesting with resulting JSON
 $('#someDiv').html(result.invocationResult.interestingData);
 },
 onFailure: function(result){
 WL.SimpleDialog.show("Error","The service is temporarily not available.
Please try again later.",[{text: "OK"}]);
 }
});

```

### SQL adapters:

You can use the IBM MobileFirst Platform Foundation for iOS SQL adapter to execute parameterized SQL queries and stored procedures that retrieve or update data in an SQL database.

You can use plain SQL queries or stored procedures. As a developer, you must download the JDBC connector driver for the specific database type separately and add it to the `server\lib\` folder of a MobileFirst project. You can download the JDBC connector driver from the appropriate vendor website.

For more information about SQL adapters, see the [JavaScript SQL Adapter tutorial](#).

*JMS adapters:*

Java messaging service (JMS) is the standard messaging Java API for sending messages between two or more clients. The MobileFirst JMS adapter provides reading and writing capabilities to messaging providers that implement the JMS API.

You can configure a JMS adapter to work with such messaging providers as a Liberty profile server or a WebSphere MQ message broker.

*Connecting a JMS adapter to the WebSphere Application Server messaging provider:*

You can develop and test MobileFirst adapters that use Java Message Service (JMS) on a WebSphere Application Server messaging provider. The WebSphere Application Server messaging provider can be the default messaging provider, a WebSphere MQ messaging provider, or a third-party provider.

### **Before you begin**

You must have configured the WebSphere Application Server messaging provider and JMS resources such as the queue connection factories and the queues or topics.

### **About this task**

The following procedure shows how to connect a JMS adapter to a WebSphere Application Server messaging provider.

### **Procedure**

1. Create a MobileFirst JMS adapter.
2. Because the adapter runs on a JMS-enabled server, the naming connection section of the adapter.xml file is not necessary. It can remain commented out.
3. Enter the JNDI name for the queue connection factory that was created in the server.xml file.

```
<connectivity>
 <connectionPolicy xsi:type="jms:JMSConnectionPolicy">

 <!-- <namingConnection url="MY_JNDI_URL"
 initialContextFactory="providers_initial_context_factory_class_name"
 user="JNDIUserName"
 password="JNDIPassword"/> -->

 <jmsConnection
 connectionFactory="jms/WASQCF"
 user="admin"
 password="admin"
 />
 </connectionPolicy>

 <loadConstraints maxConcurrentConnectionsPerNode="10"/>
</connectivity>
```

4. In the JMS adapter implementation file, enter the JNDI name for the queue as the destination for both the read and write methods:

```
function readMessage() {
 var result = WL.Server.readSingleJMSMessage({
 destination: "jms/WASQueue",
 timeout: 60
 });
};
```



```

 if (!result.message) {
 WL.Logger.debug(">> JMS adapter >> readNextMessage >> no message in queue");
 return {};
 } else {
 WL.Logger.debug(">> JMS adapter >> readNextMessage >> message received ::");
 return result.message;
 }
};
}

```

5. Change the MobileFirst target server in MobileFirst Platform Command Line Interface for iOS to point to your WebSphere Application Server environment.
6. Build and deploy the MobileFirst adapter to the WebSphere Application Server environment. You can test the JMS adapter in your browser by using the following URL syntax:

```

http://<was-hostname>:<port>/<context-root>/invoke?adapterName=
<adapterName>&procedure=<procedureName>¶meters=["<parameters>"]

```

An example of a URL pointing to an external WebSphere Application Server server:

```

http://localhost:9080/worklight/invoke?adapter=JMSAdapter&procedure=
writeMessage¶meters=["Hello World"]

```

*Connecting a JMS adapter to a Liberty profile server:*

You can develop and test MobileFirst adapters that use Java Message Service (JMS) on a WebSphere Application Server Liberty profile ND server.

### **Before you begin**

If you want to create adapters that use the JMS API, you must understand that the WebSphere Application Server Liberty profile included with IBM MobileFirst Platform Foundation for iOS does not contain the built-in Liberty JMS features. Therefore, an embedded MobileFirst Development Server or a local external instance of this bundled WebSphere Application Server Liberty profile server cannot act as a JMS provider.

### **About this task**

JMS is supported by the WebSphere Application Server Liberty profile V8.5 ND (Network Deployment) server. If you have a local copy of this application server that is installed on the same workstation as your MobileFirst tools, you can use it to develop and test your JMS applications.

Because WebSphere Application Server Liberty profile does not support remote JNDI lookups, it is not possible to make remote connections to the JMS server. The MobileFirst adapter must be running on the same local Liberty profile server that has JMS enabled.

The following procedure shows how to connect to an external Liberty profile server that supports JMS.

### **Procedure**

1. Enable JMS on your Liberty profile ND server by using the procedures in the WebSphere Application Server user documentation at Configuring point-to-point messaging for a single Liberty profile server. Make a note of the JNDI connection factory and queue name, as shown in the following code example:

```

<!-- Enable features -->
<featureManager>
 <feature>jsp-2.2</feature>
 <feature>wasJmsServer-1.0</feature>
 <feature>wasJmsClient-1.1</feature>
 <feature>jndi-1.0</feature>
</featureManager>

<messagingEngine id="defaultME">
 <queue
 id="libertyQ"
 forceReliability="ReliablePersistent"
 maxQueueDepth="5000">
 </queue>
</messagingEngine>

<jmsQueueConnectionFactory jndiName="jms/libertyQCF" connectionManagerRef="ConMgr2">
 <properties.wasJms
 nonPersistentMapping="ExpressNonPersistent"
 persistentMapping="ReliablePersistent"/>
</jmsQueueConnectionFactory>

<connectionManager id="ConMgr2" maxPoolSize="2"/>

<jmsQueue jndiName="jms/libertyQue">
 <properties.wasJms
 queueName="libertyQ"
 deliveryMode="Application"
 timeToLive="500000"
 priority="1"
 readAhead="AsConnection" />
</jmsQueue>

```

2. Create a MobileFirst JMS adapter.
3. Because the adapter runs on a JMS-enabled Liberty profile server, the naming connection section of the adapter.xml file is not necessary. It can remain commented out.
4. Enter the JNDI name for the connection factory that was created in the server.xml file.

```

<connectivity>
 <connectionPolicy xsi:type="jms:JMSConnectionPolicyType">

 <!-- <namingConnection url="MY_JNDI_URL"
 initialContextFactory="providers_initial_context_factory_class_name"
 user="JNDIUserName"
 password="JNDIPassword"/> -->

 <jmsConnection
 connectionFactory="jms/libertyQCF"
 user="admin"
 password="admin"
 />

 </connectionPolicy>
</connectivity>

```

5. In the JMS adapter implementation file, enter the JNDI name for the queue as the destination for both the read and write methods:

```

function readMessage() {
 var result = WL.Server.readSingleJMSMessage({
 destination:"jms/libertyQue",
 timeout: 60
 });
 if (!result.message) {
 WL.Logger.debug(">> JMS adapter >> readNextMessage >> no message in queue");
 return {};
 } else {

```

```

 WL.Logger.debug(">> JMS adapter >> readNextMessage >> message received ::");
 return result.message;
 };
}

```

6. Change the MobileFirst target server in MobileFirst Platform Command Line Interface for iOS to point to your Liberty ND server.
7. Build and deploy the MobileFirst adapter to the Liberty profile ND server. You can test the JMS adapter in your browser by using the following URL syntax:

```

http://<liberty-hostname>:<port>/<context-root>/invoke?adapterName=
<adapterName>&procedure=<procedureName>¶meters=["<parameters>"]

```

An example of a URL pointing to an external Liberty profile ND server:

```

http://localhost:9080/worklight/invoke?adapter=JMSAdapter&procedure=
writeMessage¶meters=["Hello World"]

```

#### *Connecting a JMS adapter to WebSphere MQ:*

You can connect a MobileFirst Java Message Service (JMS) adapter to WebSphere MQ.

#### **Before you begin**

If you are running the adapter on WebSphere Application Server, use the WebSphere Application Server messaging provider. For more information, see “Connecting a JMS adapter to the WebSphere Application Server messaging provider” on page 8-134.

Ensure that you have prior knowledge of WebSphere MQ and have a WebSphere MQ Message Broker setup with the appropriate JMS administered objects. For more information about setting up WebSphere MQ for JMS, see the IBM WebSphere MQ user documentation.

#### **About this task**

The MobileFirst JMS adapter does not support connecting to WebSphere MQ through bindings mode, only in client mode. A TCP connection is created for each JMS request, even if the JMS broker and MobileFirst adapter are running on the same computer.

To connect a MobileFirst JMS adapter to WebSphere MQ, you create a project, copy some JAR files to the project directory, and modify the adapter file.

#### **Procedure**

Include the required WebSphere MQ Java libraries

1. Create a MobileFirst project.
2. Locate the java/lib directory in your WebSphere MQ directory.  
Example: /opt/mqm/java/lib
3. Copy the following JAR files from the java/lib directory into the server/lib directory of your MobileFirst project:
  - CL3Export.jar
  - CL3Nonexport.jar
  - com.ibm.mq.axis2.jar
  - com.ibm.mq.commonservices.jar
  - com.ibm.mq.defaultconfig.jar

- com.ibm.mq.headers.jar
- com.ibm.mq.jar
- com.ibm.mq.jmqi.jar
- com.ibm.mq.jms.Nojndi.jar
- com.ibm.mq.pcf.jar
- com.ibm.mq.postcard.jar
- com.ibm.mq.soap.jar
- com.ibm.mq.tools.ras.jar
- com.ibm.mqjms.jar
- connector.jar
- dhbcore.jar
- fscontext.jar
- jta.jar
- providerutil.jar
- rmm.jar

Modify the adapter XML file

4. Create a MobileFirst JMS adapter.
5. Open the adapter.xml file.
6. In the namingConnection element of the xml file, set the URL to the location of your bindings file that was generated by WebSphere MQ.

Example:

```
url="file:/home/user/JMS"
```

7. In the namingConnection element of the XML file, set the **initialContextFactory** attribute to com.sun.jndi.fscontext.ReffSContextFactory.
8. In the jmsConnection element, set the **connectionFactory** attribute to the name of the connection factory that was set up in WebSphere MQ.
9. Optional: If security is enabled in WebSphere MQ, include the credentials as shown in the following code example.

```
<connectivity>
 <connectionPolicy xsi:type="jms:JMSConnectionPolicyType">
 <namingConnection
 url="file:/home/user/JMS"
 initialContextFactory="com.sun.jndi.fscontext.ReffSContextFactory"
 user="admin"
 password="password"/>
 <jmsConnection
 connectionFactory="myConnFactory"
 user="admin"
 password="password"/>
 </connectionPolicy>
</connectivity>
```

Modify the adapter implementation file

10. Open the adapter's implementation file.
11. In the autogenerated read and write methods, replace the **destination** property with the name that was configured in your JMS administered object in WebSphere MQ.

Example:

```

function readMessage() {
 var result = WL.Server.readSingleJMSMessage({
 destination: "JMS1",
 timeout: 60
 });
 WL.Logger.debug(result);
 if (result.errors) {
 WL.Logger.debug(">> JMS adapter >> readNextMessage >> errors occurred");
 return result;
 } else if (!result.message) {
 WL.Logger.debug(">> JMS adapter >> readNextMessage >> no messages in queue");
 return result;
 } else {
 WL.Logger.debug(">> JMS adapter >> readNextMessage >> message received ::");
 }
}

```

## Results

The MobileFirst JMS adapter is now properly configured to connect to WebSphere MQ. You can test the JMS adapter in your browser by using the following URL:

`http://<hostname>:<port>/<context-root>/invoke?adapterName=<adapterName>&procedure=<procedureName>&parameters=['<parameters>']`

## Example

`http://localhost:10080/worklight/invoke?adapter=JMSAdapter&procedure=writeMessage&parameters=['Hello World']`

*SAP Gateway adapters:*

Your IBM MobileFirst Platform Foundation for iOS applications can communicate with SAP Netweaver Gateway back-end services by using SAP adapters. Using HTTP rest calls and the OData protocol, applications can remotely create, retrieve, update, and delete entities through the adapter.

*Starting an SAP Gateway adapter:*

You can create, retrieve, update, delete, and analyze Entities that exist on an SAP system by using the MobileFirst SAP Gateway adapter.

*Creating an entity:*

You can create entity remotely through SAP Gateway.

## About this task

*Table 8-6. Attributes*

Attribute	Mandatory or Optional	Description
<b>content</b>	Mandatory	Defines the properties of the entity. Supports JSON and Atom/XML formatting.

## Procedure

- To create an entity in JSON format, write the input parameters as shown in the following example.

```

"City": "Midland",
"Country": "USA",
"LanguageCode": "3",

```

```

"LocalCurrencyCode": "324",
"MimeType": "",
"Name": "Destination Paradise",
"POBox": "322",
"PostalCode": "48642",
"Region": "B",
"Street": "100 Electric Ave",
"TelephoneNumber": "5558675309",
"TravelAgencyID": "0000099",
"URL": "www.foo.com"

```

- To create an entity in XML format, write the input parameters as shown in the following example.

```

"<?xml version='1.0' encoding='utf-8'?">
 <entry xml:base='http://sapw101.austin.ibm.com:8003/sap/opu/odata/iwbep/RMTSAMPLEFLIGHT_2/'
 xmlns='http://www.w3.org/2005/Atom' xmlns:m='http://schemas.microsoft.com/ado/2007/08/
 /dataservices/metadata'
 xmlns:d='http://schemas.microsoft.com/ado/2007/08/dataservices'>

 <id>http://sapw101.austin.ibm.com:8003/sap/opu/odata/iwbep/RMTSAMPLEFLIGHT_2/
 /TravelAgencies('0000099')</id>
 <title type='text'>TravelAgencies('0000099')</title>
 <updated>2014-07-18T14:10:27Z</updated>
 <category term='RMTSAMPLEFLIGHT_2.TravelAgency'
 scheme='http://schemas.microsoft.com/ado/2007/08/dataservices/scheme'
 /><link href='TravelAgencies('0000099')' rel='edit'
 title='TravelAgency' />
 <content type='application/xml'>
 <m:properties>
 <d:TravelAgencyID>0000099</d:TravelAgencyID>
 <d:Name>Destination Paradise</d:Name>
 <d:Street>100 Electric Ave</d:Street>
 <d:POBox>322</d:POBox>
 <d:PostalCode>48642</d:PostalCode>
 <d:City>Midland</d:City>
 <d:Country>USA</d:Country>
 <d:Region>B</d:Region>
 <d:TelephoneNumber>9896002072</d:TelephoneNumber>
 <d:URL>www.foo.com</d:URL>
 <d:LanguageCode>34</d:LanguageCode>
 <d:LocalCurrencyCode>324</d:LocalCurrencyCode>
 <d:MimeType>xml</d:MimeType>
 </m:properties>
 </content>
 </entry>"

```

## Results

If you use the previous examples, you receive the following response from MobileFirst Server.

```

{
 "d": {
 "City": "Midland",
 "Country": "USA",
 "LanguageCode": "3",
 "LocalCurrencyCode": "324",
 "MimeType": "",
 "Name": "Destination Paradise",
 "POBox": "322",
 "PostalCode": "48642",
 "Region": "B",
 "Street": "100 Electric Ave",
 "TelephoneNumber": "5558675309",
 "TravelAgencyID": "0000099",
 "URL": "www.foo.com",
 "__metadata": {

```

```

 "id": "http://serv101.tampa.ibm.com:1234/sap/opu/odata/iwbep/RMTSAMPLEFLIGHT_2/TravelAgencies('00000099')",
 "type": "RMTSAMPLEFLIGHT_2.TravelAgency",
 "uri": "http://serv101.tampa.ibm.com:1234/sap/opu/odata/iwbep/RMTSAMPLEFLIGHT_2/TravelAgencies('00000099')",
 }
},
"isSuccessful": true,
"responseHeaders": {
 "content-length": "554",
 "content-type": "application/json; charset=utf-8",
 "dataserviceversion": "2.0",
 "location": "http://serv101.tampa.ibm.com:1234/sap/opu/odata/iwbep/RMTSAMPLEFLIGHT_2/TravelAgencies('00000099')",
 "server": "SAP NetWeaver Application Server \ / ABAP 731"
},
"statusCode": 201,
"statusReason": "Created"
}

```

*Retrieving an entity:*

You can retrieve an entity through an SAP Gateway server.

### About this task

*Table 8-7. Attributes*

Attribute	Mandatory or Optional	Description
<b>expand</b>	Optional	Indicates that the response from the Gateway represents navigation properties inline, rather than referenced. Formatted as a JSON array.
<b>keys</b>	Mandatory	Identifies which entity is to be retrieved based on its key property or properties. Formatted as a JSON object.
<b>select</b>	Optional	Indicates that a response from the Gateway is formatted with a subset of specified properties. Formatted as a JSON array.

### Procedure

To retrieve an entity in JSON format, write the input parameters as shown in the following example.

```

{
 "keys": {
 "carrid": "LH"
 },
 "select": ["carrid", "carrierFlights"],
 "expand": ["carrierFlights"]
}

```

### Results

If you use the previous example, you receive the following response from MobileFirst Server.

```

{
 "_metadata": {
 "content_type": "image/gif",
 "edit_media": "https://sap4.sapdevelopercenter.com:444/sap/opu/odata/iwfn/RMTSAMPLEFLIGHT/CarrierCollection('LH')/$value",
 "media_src": "https://sap4.sapdevelopercenter.com:444/sap/opu/odata/iwfn/RMTSAMPLEFLIGHT/CarrierCollection('LH')/$value",
 "type": "RMTSAMPLEFLIGHT.Carrier",
 "uri": "https://sap4.sapdevelopercenter.com:444/sap/opu/odata/iwfn/RMTSAMPLEFLIGHT/CarrierCollection('LH')",
 },
 "carrid": "LH",
 "carrierFlights": {
 "results": [
 {
 "CURRENCY": "EUR",
 "FlightCarrier": {
 "_deferred": {
 "uri": "https://sap4.sapdevelopercenter.com:444/sap/opu/odata/iwfn/RMTSAMPLEFLIGHT/FlightCollection(carrid='LH',connid='0400',fldate=datetime'2013-12-21T00%3A00%3A00')/FlightCarrier"
 }
 },
 "PAYMENTSUM": "209124.00",
 "PLANETYPE": "A310-300",
 "PRICE": "666.00",
 "SEATSMAX": 280,
 "SEATSMAX_B": 22,
 "SEATSMAX_F": 10,
 "SEATSOCC": 267,
 "SEATSOCC_B": 22,
 "SEATSOCC_F": 9,
 "_metadata": {
 "type": "RMTSAMPLEFLIGHT.Flight",
 "uri": "https://sap4.sapdevelopercenter.com:444/sap/opu/odata/iwfn/RMTSAMPLEFLIGHT/FlightCollection(carrid='LH',connid='0400',fldate=datetime'2013-12-21T00%3A00%3A00')",
 },
 "carrid": "LH",
 "connid": "0400",
 "fldate": "\/Date(1387584000000)\/",
 "flightBookings": {
 "_deferred": {
 "uri": "https://sap4.sapdevelopercenter.com:444/sap/opu/odata/iwfn/RMTSAMPLEFLIGHT/FlightCollection(carrid='LH',connid='0400',fldate=datetime'2013-12-21T00%3A00%3A00')/flightBookings"
 }
 }
 }
]
 }
 ...
}

```

### Updating an entity:

You can update an entity from an SAP Gateway server.

### About this task

Table 8-8. Attributes

Attribute	Mandatory or Optional	Description
<b>content</b>	Mandatory	This attribute is the new set of properties for the specified entity. Any properties that are not defined in <b>content</b> are set to an empty string when the update is complete. Supports JSON and Atom/XML formatting.



## Procedure

To update an entity in XML format, write the input parameters as shown in the following example.

```
{
 "keys":{
 "TravelAgencyID"
 }
}
```

## Results

If you use the previous example, you receive the following response from MobileFirst Server.

```
"City": "Midland",
"Country": "USA",
"LanguageCode": "3",
"LocalCurrencyCode": "324",
"MimeType": "",
"Name": "Destination Paradise",
"POBox": "322",
"PostalCode": "48642",
"Region": "B",
"Street": "100 Electric Ave",
"TelephoneNumber": "5558675309",
"TravelAgencyID": "00000099",
"URL": "www.foo.com"
```

*Deleting an entity:*

You can delete an existing entity through an SAP Gateway server.

## About this task

Table 8-9. Attributes

Attribute	Mandatory or Optional	Description
keys	Mandatory	Identifies which entity must be deleted, based on its key properties. Formatted as a JSON object.

## Procedure

To delete an entity in JSON format, write the input parameters as shown in the following example.

```
{
 "keys":{
 "TravelAgencyID":"99"
 }
}
```

If you use the previous example, you receive the following response from MobileFirst Server.

```
{
 "isSuccessful": true,
 "responseHeaders": {
 "content-length": "0",
 "dataserviceversion": "2.0",
 "server": "SAP NetWeaver Application Server \/ ABAP 731"
 }
}
```

```

 },
 "statusCode": 204,
 "statusReason": "No Content"
 }
}

```

## Results

A successful deletion results in a 204 No Content response from the server.

*Querying an existing entity:*

You can search for existing Collections within an SAP Gateway server.

## About this task

Table 8-10. Attributes

Attribute	Mandatory or Optional	Description
<b>expand</b>	Optional	Indicates that the response from the Gateway represents navigation properties inline, rather than referenced. Formatted as a JSON array.
<b>filter</b>	Optional	Uses logic operators to indicate that only the matching criteria are returned in the response. Formatted as a String. For examples, see: Filter System Query Option.
<b>custom</b>	Optional	Overrides all other input parameters and directly appends this query to your resource path. You can use this parameter to generate more complex queries. For example: \$expand=Products(\$filter=Date eq null).
<b>select</b>	Optional	Indicates that a response from the Gateway is formatted with a subset of specified properties. Formatted as a JSON array.
<b>skip</b>	Optional	Identifies that the first input number of items of a Collection are skipped in the response.
<b>top</b>	Optional	Identifies how many items of a Collection are returned in a response. Formatted as a non-negative integer, which is enclosed in quotation marks.

## Procedure

- To use the **select** parameter for querying an existing entity in JSON format, write the input parameter as shown in the following example.

```

{
 "select": ["TravelAgencyID"]
}

```

- To use the **filter** parameter for querying an existing entity in JSON format, write the input parameter as shown in the following example.

```
{
 "filter": "TelephoneNumber eq '5558675309'"
}
```

- To use the **expand** parameter for querying an existing entity in JSON format, write the input parameter as shown in the following example.

```
{
 "expand": ["carrierFlights"]
}
```

- To use the **skip** parameter for querying an existing entity in JSON format, write the input parameter as shown in the following example.

```
{
 "skip": "2"
}
```

- To use the **top** parameter for querying an existing entity in JSON format, write the input parameter as shown in the following example.

```
{
 "top": "2"
}
```

*Retrieving a property of an entity:*

You can retrieve a specific property from an entity through an SAP Gateway server.

### About this task

Table 8-11. Attributes

Attribute	Mandatory or Optional	Description
<b>keys</b>	Mandatory	Identifies the entity to be retrieved based on its key properties. Formatted as a JSON Object.
<b>property</b>	Optional	Defines the Property to be retrieved. Formatted as a String.

### Procedure

- To retrieve a property from an entity in JSON format, write the input parameters as shown in the following example.

```
{
 "keys":{
 "carrid":'IBM Air',
 "connid":'0017',
 "fldate":"2013-12-18T00:00:00"
 },
 "property":"carrierFlights"
}
```

If you use the previous example, you receive the following response from MobileFirst Server.

```
{
 "isSuccessful": true,
 "results": [
 {
 "CURRENCY": "USD",
 "FlightCarrier": {
 "__deferred": {
```

```

 "uri": "https://serv101.tampa.ibm.com:1234/sap/opu/odata/iwfn/RMTSAMPLEFLIGHT\
/FlightCollection(carrid='IBM Air',connid='0017',fldate=datetime'2013-12-18T00%3A00%3A00')\FlightCarrier"
 },
 "PAYMENTSUM": "192281.41",
 "PLANETYPE": "747-400",
 "PRICE": "422.94",
 "SEATSMAX": 385,
 "SEATSMAX_B": 31,
 "SEATSMAX_F": 21,
 "SEATSOCC": 374,
 "SEATSOCC_B": 28,
 "SEATSOCC_F": 21,
 "_metadata": {
 "type": "RMTSAMPLEFLIGHT.Flight",
 "uri": "https://serv101.tampa.ibm.com:1234/sap/opu/odata/iwfn/RMTSAMPLEFLIGHT\
/FlightCollection(carrid='IBM Air',connid='0017',fldate=datetime'2013-12-18T00%3A00%3A00')"
 },
 "carrid": "IBM Air",
 "connid": "0017",
 "fldate": "\Date(1387324800000)\",
 "flightBookings": {
 "_deferred": {
 "uri": "https://serv101.tampa.ibm.com:1234/sap/opu/odata/iwfn/RMTSAMPLEFLIGHT\
/FlightCollection(carrid='IBM Air',connid='0017',fldate=datetime'2013-12-18T00%3A00%3A00')\flightBookings"
 }
 },
 "flightDetails": {
 "_metadata": {
 "type": "RMTSAMPLEFLIGHT.FlightDetails"
 },
 "airportFrom": "JFK",
 "airportTo": "SFO",
 ...

```

- To retrieve a property from an entity in JSON format, write the input parameters as shown in the following example.

```

{
 "keys":{
 "carrid":'AA',
 "connid":'0017',
 "fldate":'2013-12-18T00:00:00'
 },
 "property":"CARRNAME/$value"
}

```

If you use the previous example, you receive the following response from MobileFirst Server.

```

{
 "RETURN": "American Airlines",
 "isSuccessful": true,
 "responseHeaders": {
 "content-length": "17",
 "content-type": "text/plain; charset=utf-8",
 "dataserviceversion": "2.0",
 "server": "SAP NetWeaver Application Server \/ Tampa 1234",
 "x-csrf-token": "9PfsXHsbriIR4PNwflKBAG=="
 },
 "statusCode": 200,
 "statusReason": "OK"
}

```

### Configuring an SAP Gateway adapter with a system user:

You can connect to an SAP back end with a system user. However, you should use user-based authentication for most scenarios. Check your SAP license terms.

#### Before you begin

Make sure that SAP Gateway adapters exist in your MobileFirst project.

#### Procedure

1. Expand the **adapters** folder of your MobileFirst project, right-click *<SAP Adapter name>.xml*, and select **Open With > Adapter Editor**.
2. In the **Adapter Editor** view, expand **Connectivity** and select **Connection Policy**.
3. Click **Add**, select **authentication** from the Add Item window, and click **OK**.
4. Under Connection Policy, select **authentication** and click **Add**.
  - a. Select the appropriate authentication mechanism of your SAP server. This example uses **basic**. The results look something like the following image.

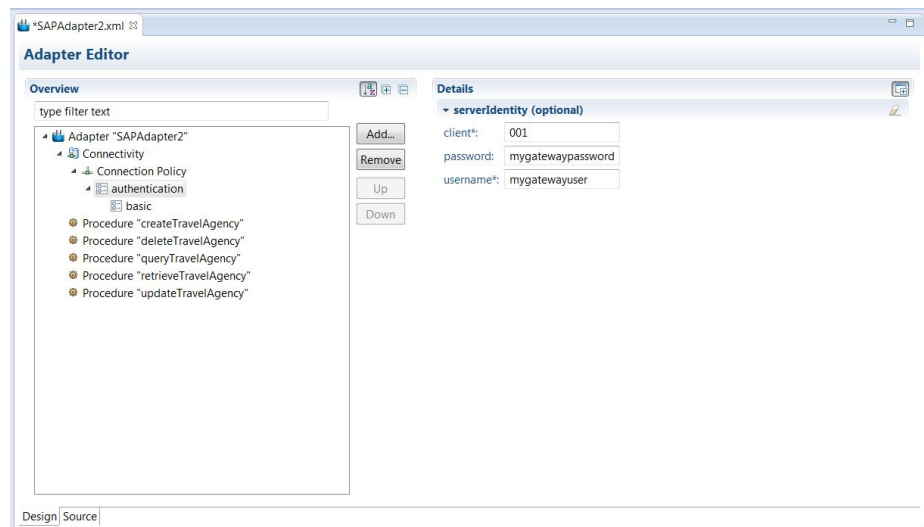

5. To see the changes in the source code, select the **Source** tab at the bottom of the **Adapter Editor** view.

#### Results

Your SAP Gateway adapter is configured to start procedures on a server-identity authentication basis.

#### SAP JCo adapters:

You can use the SAP Java Connector (SAP JCo) adapters to develop SAP-compatible components and applications in Java.

#### Invoking an SAP JCo adapter:

If you invoke the SAP Java Connector (SAP JCo) adapter, you can communicate with the SAP Server both inbound and outbound.

## About this task

Table 8-12. Parameters

Parameter	Mandatory or Optional	Description
FunctionName	Mandatory	The name of the function to be run on the SAP system
Imports	Mandatory	The input parameters

### Procedure

1. Call the `invokeSAPFunction` procedure and pass in the following parameters.  

```
{"FunctionName" : "BAPI_USER_GET_DETAIL", "Imports" : {"USERNAME" : "DEVELOPER"}}
```
2. Save your `adapter_name-impls.js` file.

### Results

The following message is displayed in the Console: Adapter build and deploy finished.

*The Cast Iron adapter:*

The MobileFirst Cast Iron adapter initiates orchestrations in Cast Iron to retrieve and return data to mobile clients.

Cast Iron accesses various enterprise data sources, such as databases, web services, and JMS, and provides validation, aggregation, and formatting capabilities.

The Cast Iron adapter supports two patterns of connectivity:

#### **Outbound pattern.**

The invocation of Cast Iron orchestrations from IBM MobileFirst Platform Foundation for iOS.

#### **Inbound pattern.**

Cast Iron sends notifications to devices through IBM MobileFirst Platform Foundation for iOS.

The Cast Iron adapter supports the invocation of a Cast Iron orchestration over HTTP only. Cast Iron Template Integration Projects (TIPs) are provided in Cast Iron as examples of this technique, and for you to use as a basis for your own orchestrations. For more information, see the Cast Iron documentation.

Cast Iron uses the standard MobileFirst notification adapter and event sources to publish notification messages to be delivered to devices by using one of the many notification providers.

For information about defining event sources, see the `createEventSource` method in the `WL.Server` class.

Cast Iron Template Integration Projects (TIPs) are provided in Cast Iron as examples of this technique, and for you to use as a basis for your own notification scenarios. For more information, see the Cast Iron documentation.

To protect the notification adapter, use basic authentication.

## Troubleshooting a Cast Iron adapter – connectivity issues

Symptom: The MobileFirst adapter cannot communicate with the Cast Iron server.

Causes:

- Cast Iron provides two network interfaces, one for administration and one for data. Ensure that you are using the correct host name or IP address of the Cast Iron data interface. You can find this information under the Network menu item in the Cast Iron administrative interface. This information is stored in the *adapter-name.xml* file for your adapter.
- The invocation fails with a message Failed to parse the payload from backend. This failure is typically caused by a mismatch between the data returned by the Cast Iron orchestration and the returnedContentType parameter in the *adapter-name.js* implementation. For example, the Cast Iron orchestration returns JSON but the adapter is configured to expect XML.

*Developing JavaScript adapter code:*

Learn about implementing a procedure in the adapter XML file, calling Java code from a JavaScript adapter, and invoking a back-end service.

*Implementing adapter procedures:*

Implement a procedure in the adapter XML file, using an appropriate signature and any return value.

### Before you begin

You have declared a procedure in the adapter XML file, using a <procedure> tag.

### Procedure

Implement the procedure in the adapter JavaScript file. The signature of the JavaScript function that implements the procedure has the following format:

```
function funcName (param1, param2, ...),
```

Where:

- *funcName* is the name of function which the procedure implements. This name must be the same as the value specified in the name attribute of the <procedure> element in the adapter XML file.
- *param1* and *param2* are the function parameters. The parameters can be scalars (strings, integers, and so on) or objects.

In your JavaScript code, you can use the MobileFirst server-side JavaScript API to access back-end applications, invoke other procedures, access user properties, and write log and debug lines.

You can return any value from your function, scalar or object.

### Example

This example demonstrates how to use JavaScript on the server side. Note the following when performing procedures on the server side:

- Procedures are implemented in the adapter JavaScript file.
- The service URL is used for procedure invocations.

- Some parts of the URL are constant; for example, `http://example.com/`. They are declared in the XML file. Other parts of the URL can be parameterized; that is, substituted at run time by parameter values that are provided to the MobileFirst procedure. The following URL parts can be parameterized:
  - Path elements
  - Query string parameters
  - Fragments

For advanced options for adapters, such as cookies, headers, and encoding, see “HTTP adapter connectionPolicy element” on page 8-101.

In the JavaScript file, use the same procedure name as in the XML file. The mandatory parameters to call the procedure are `method`, `path`, and `returnedContentType`. The procedure can be parameterized at run time, for example:

```
function getFeeds() {
 var input = {
 method : 'get',
 returnedContentType : 'xml',
 path : "rss.xml"
 };

 return WL.Server.invokeHttp(input);
}
```

To call an HTTP request, use the `WL.Server.invokeHttp` method. Provide an input parameter object, which must specify the following options:

- The HTTP method: GET, POST, PUT, or DELETE
- The returned content type: XML, JSON, HTML, or plain
- The service path
- The query parameters (optional)
- The request body (optional)
- The transformation type (optional)

For a complete list of options, see `WL.Server` class.

*The Rhino container:*

IBM MobileFirst Platform Foundation for iOS uses Rhino as the engine for running the JavaScript script used to implement adapter procedures.

Rhino is an open source JavaScript container developed by Mozilla. In addition to being part of Java 6, Rhino has two other advantages:

- It compiles the JavaScript code into byte code, which runs faster than interpreted code.
- It provides access to Java code directly from JavaScript. For example:

```
var date = new java.util.Date();
var millisec = date.getTime()
```

**Note:** Global variables are handled according to the following rules:

- In the same user session (for example, an application loaded in a browser), the values of global variables persist from one method call of an adapter to another method call of the same adapter (that is, they are not reset).



- If you create two different user sessions that connect to the same adapter (for example, by opening the same app in different browsers or devices), every user session holds its own global variable state.
- If a user session expires, the Rhino session expires, and variables are no longer defined.

*Calling Java code from a JavaScript adapter:*

Follow these instructions to instantiate Java objects and call their methods from JavaScript code in your adapter.

### Before you begin

**Attention:** The name of any Java package to which you refer from within an adapter must start with the domains `com`, `org`, or `net`.

### Procedure

1. Instantiate a Java object by using the `new` keyword and apply the method on the newly instantiated object.
2. Optional: Assign a JavaScript variable to be used as a reference to the newly instantiated object.
3. Include the Java classes that are called from the JavaScript adapter in your MobileFirst project under *Worklight Project Folder/server/java*. They are automatically built and deployed to the MobileFirst Server, and the result of the build is placed under *Worklight Project Folder/bin*

### Example

```
var x = new MyJavaClass();
var y = x.myMethod(1, "a");
```

## USSD Support

Unstructured Supplementary Service Data (USSD) is a communication technology that is used by GSM cellular telephones to send text messages between a mobile phone and an application program in the network.

USSD establishes a real-time session between the mobile phone and the application that handles the service.

IBM MobileFirst Platform Foundation for iOS uses the HTTP/HTTPS protocol to communicate with the USSD gateway, which is a third-party entity. The USSD gateway routes USSD messages to the MobileFirst Server. Adapter procedures need to be defined to process these requests and send back a response. You need to define USSD event handler to route the requests to the adapter procedure that handles those requests.

**Note:** For more information, see the `WL.Server.createUSSDEventHandler` and `WL.Server.createUSSDResponse` APIs in `WL.Server`.

Here is a sample flow for USSD:

1. A mobile user enters a USSD short code, such as `*123#`.
2. The request is forwarded to a USSD gateway.
3. The gateway maps the short code to a known URL provided by IBM MobileFirst Platform Foundation for iOS, creates the USSD session, and forwards the request to the URL.

- A MobileFirst adapter with the matching filter receives the request and responds to the gateway request with the configurable USSD menu/simple text.

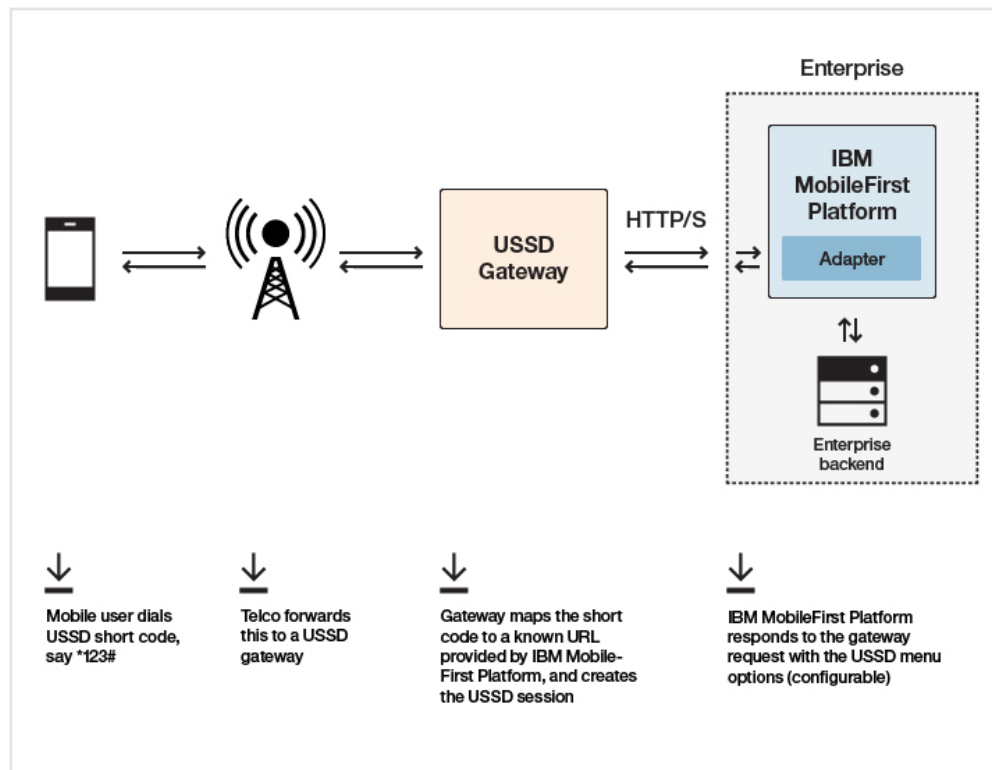

## Configuration required at USSD Gateway

`http://<hostname>:<port>/<contextroot>/ussd`

This URL can be followed by parameters specific to the gateway. Refer to your USSD Gateway documentation for more details.

## Server-side APIs required at MobileFirst adapter side

To create a filter to process the USSD request:

```
WL.Server.setEventHandlers([WL.Server.createUSSEventHandler({
 'shortcode' : '*123#'
}), handleUSSDRequest)]);
```

To send back a response:

```
WL.Server.createUSSDResponse("This is my response", "text/plain", true))
```

## Security

To prevent entities with malicious intent from sending requests to the MobileFirst Server via a USSD URL, the USSD feature is protected by default. The `authenticationConfig.xml` file is configured to reject all requests to the USSD servlet with a rejecting login module. To allow restricted access to USSD, MobileFirst administrators must modify the `authenticationConfig.xml` file with appropriate authenticator and login modules, or comment the URL pattern `/ussd*` to allow unrestricted access. For example, the following configuration in the `authenticationConfig.xml` file ensures that only requests with a specific user name in the header of the HTTP request are allowed:

```

<staticResources>
 <resource id="subscribeServlet" securityTest="SubscribeServlet">
 <urlPatterns>/subscribeSMS*;ussd*</urlPatterns>
 </resource>
 ...
</staticResources>

<securityTests>
 <customSecurityTest name="SubscribeServlet">
 <test realm="SubscribeServlet" isInternalUserID="true"/>
 </customSecurityTest>
 ...
</securityTests>

<realms>
 <realm name="SubscribeServlet" loginModule="headerLogin">
 <className>com.worklight.core.auth.ext.HeaderAuthenticator</className>
 </realm>
 ...
</realms>

<loginModules>
 <loginModule name="headerLogin">
 <className>com.worklight.core.auth.ext.HeaderLoginModule</className>
 <parameter name="user-name-header" value="username"/>
 </loginModule>
 ...
</loginModules>

```

## Invoking a back-end service for USSD

You can invoke a MobileFirst HTTP adapter to test the USSD functionality.

### Before you begin

This feature is only available within MobileFirst Studio for HTTP adapters. It is not available when you run an adapter on a stand-alone server that is based on WebSphere Application Server or Tomcat.

### About this task

In MobileFirst Studio, you can invoke an HTTP-based USSD adapter and see the results that are returned to the USSD gateway to verify that the adapter is performing correctly.

### Procedure

1. Right-click an adapter file, and select **Run As > Invoke MobileFirst Back-end Service**.

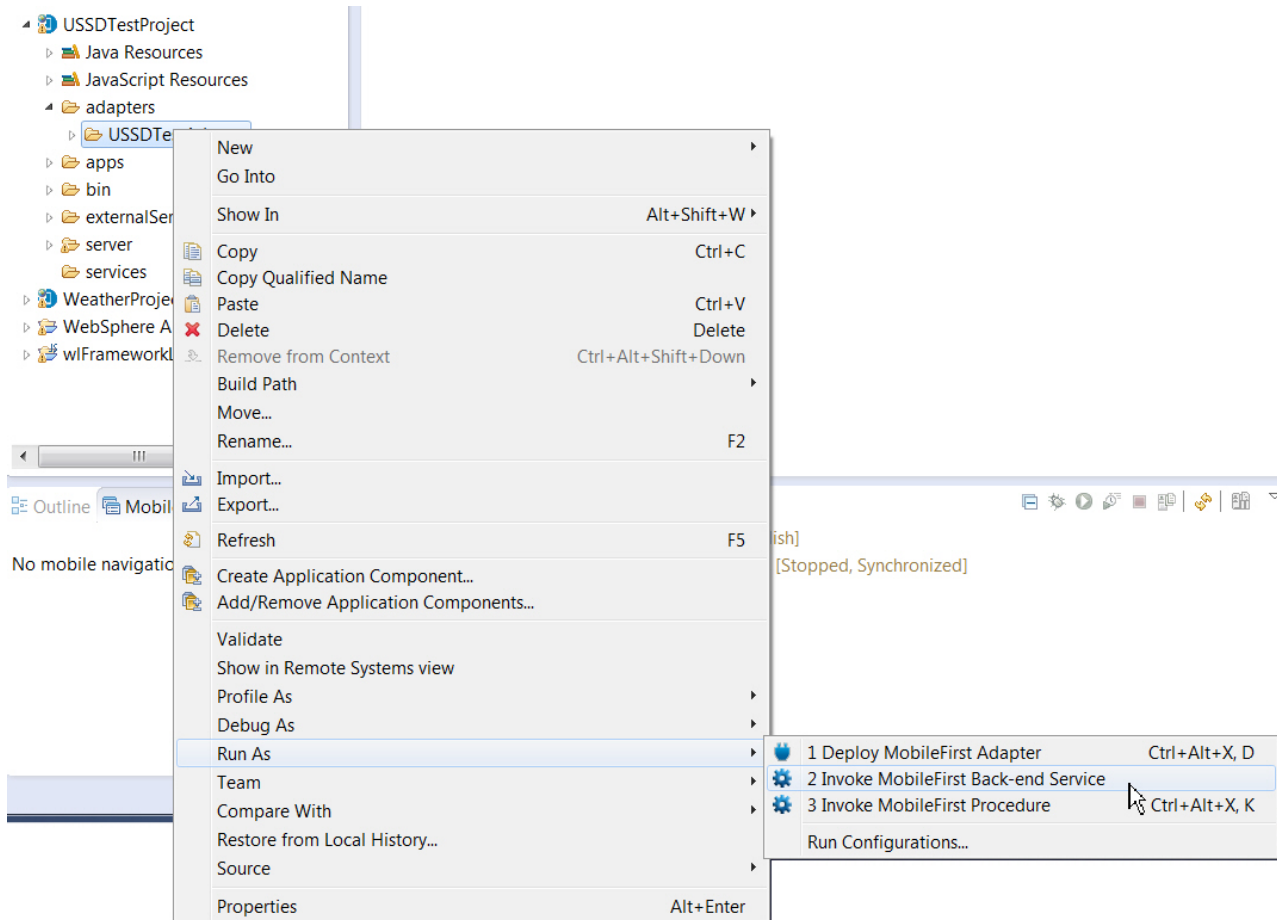

Figure 8-16. Invoking a MobileFirst back-end service

2. In the dialog box, from the **Connect as** drop-down list, select **gateway**. Then provide the options for invoking the USSD handler in the text box. The USSD gateway can send HTTP parameters, headers, cookies, or body.

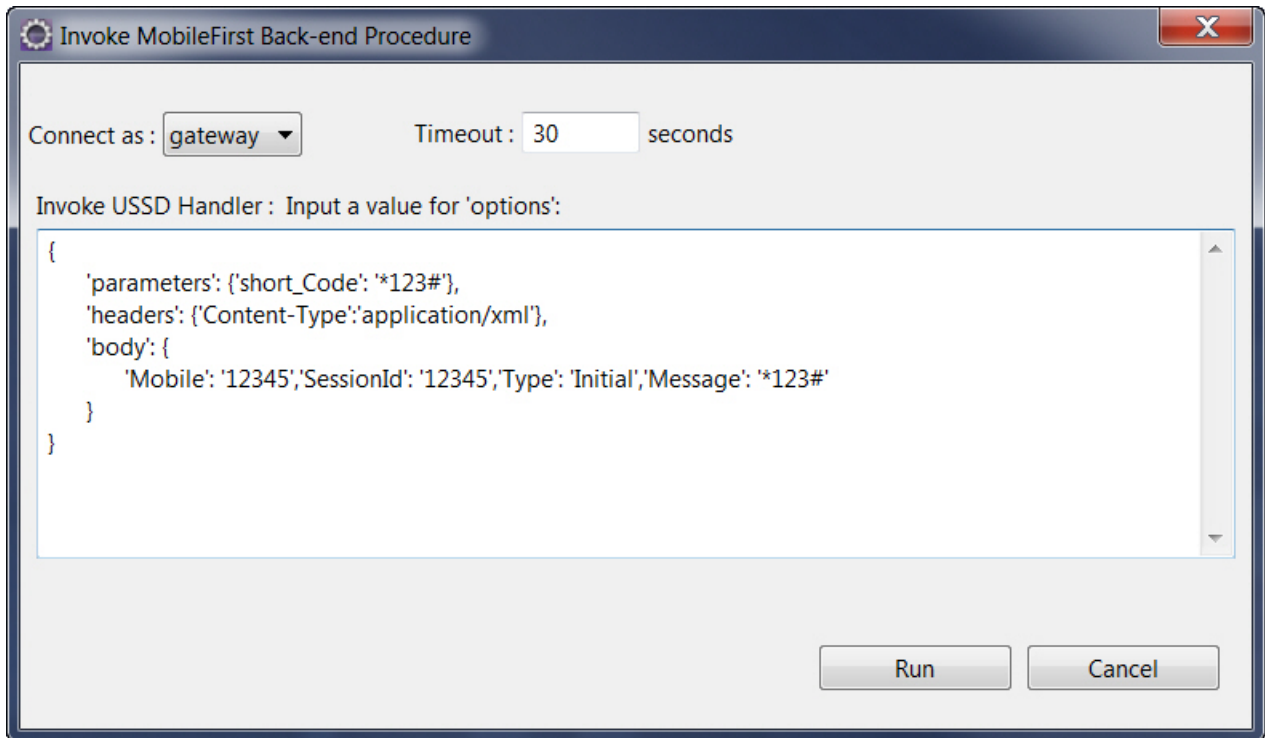
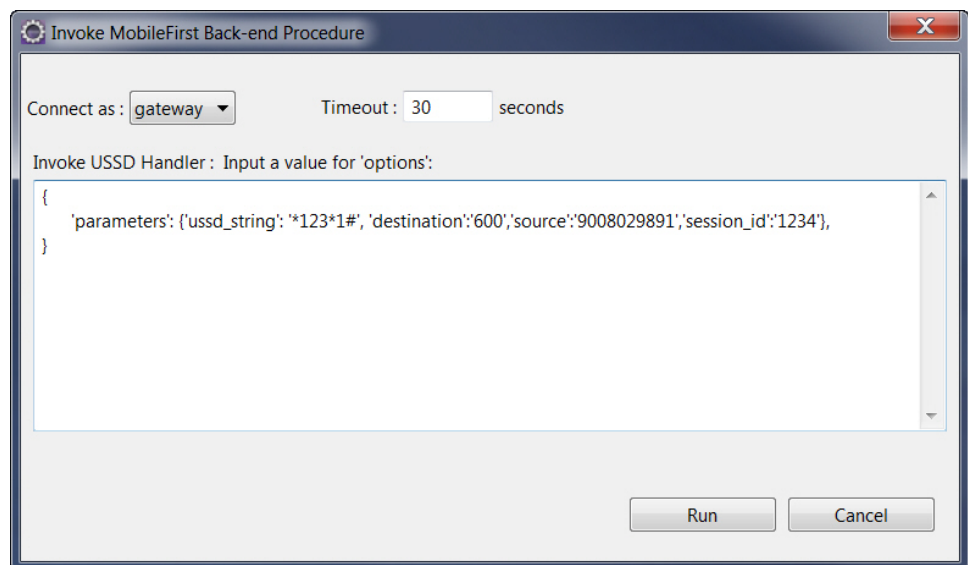

Figure 8-17. Invocation parameters.

A browser window opens, displaying the result of the adapter invocation

3. You can follow this procedure as many times as required to test the menu flow with the USSD gateway. Here are some examples that use the different types of parameters that are passed from the USSD gateway.

Example 1: Passing query string parameters.



Example 2: Passing JSON parameters in the body.

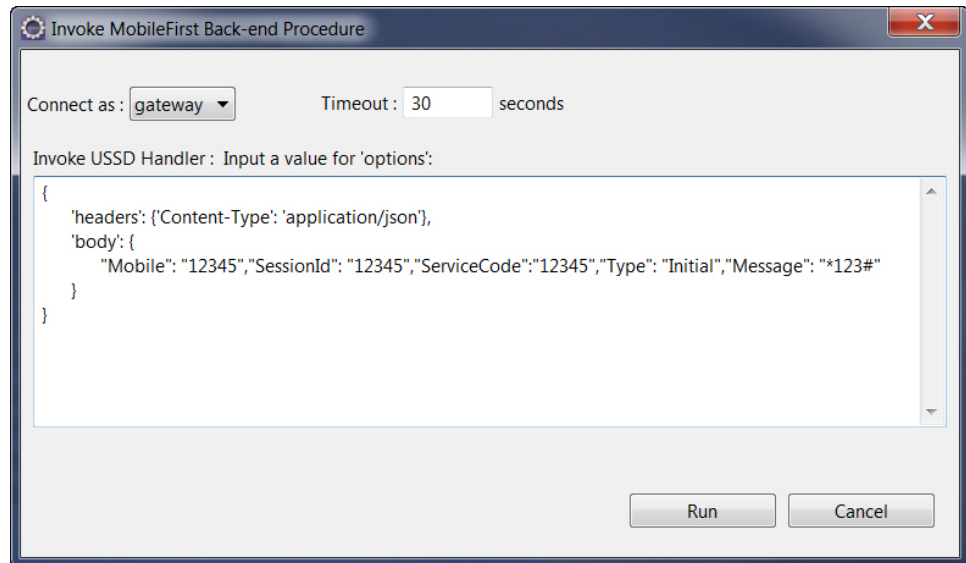

Example 3: Passing XML in the body.

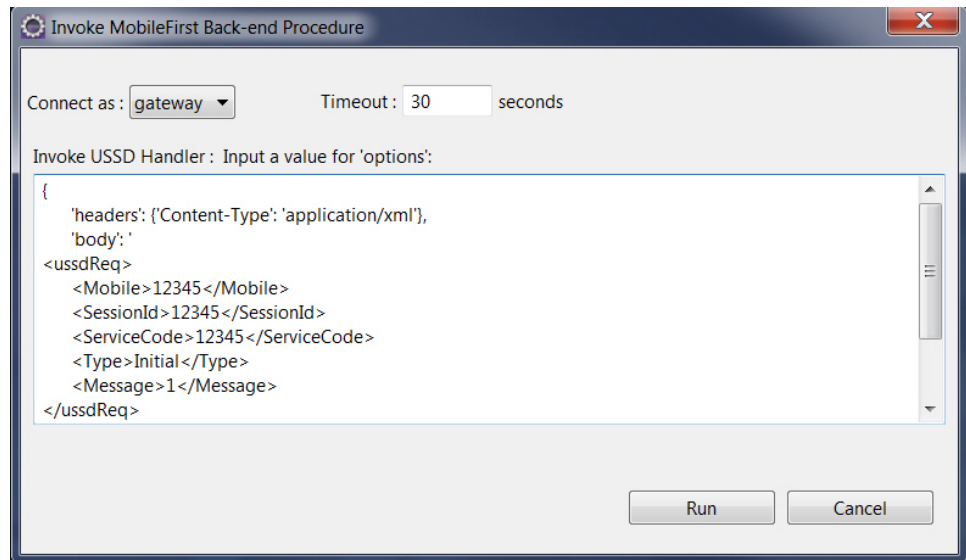

**Note:** If the body that you pass is not a JSON object, then enclose the object in quotes (" "). If it is a JSON object, then surround it with curly brackets ({}).

## Deploying adapters

In MobileFirst Studio, you can automatically deploy a new or modified adapter to the MobileFirst Server.

### Procedure

Right-click the adapter folder and select **Run As > Deploy MobileFirst Adapter**.

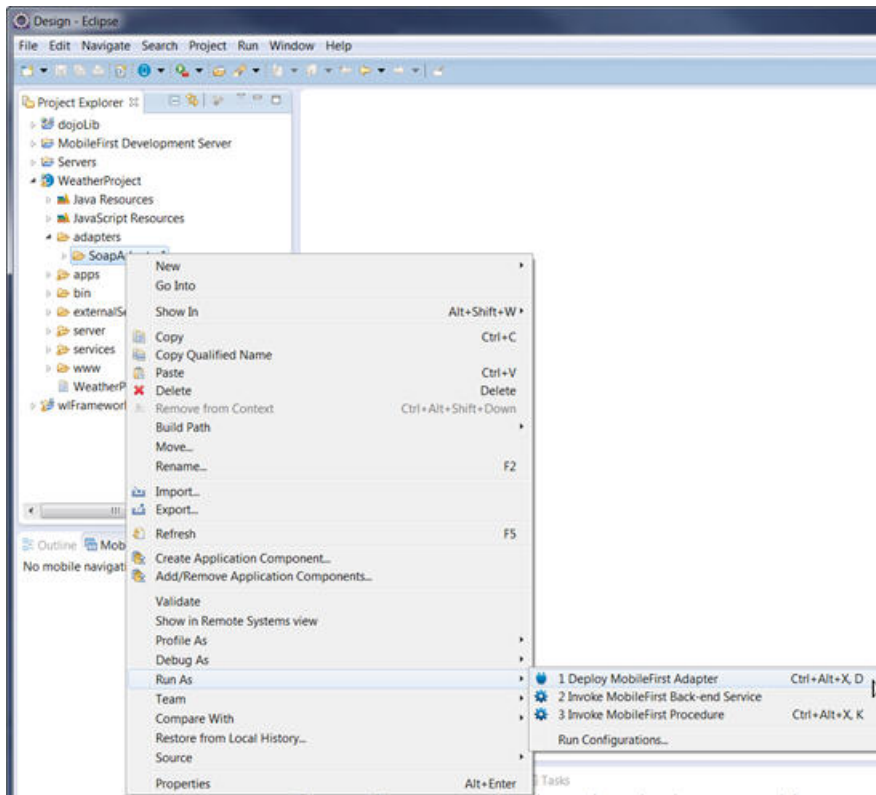

Figure 8-18. Deploying a MobileFirst adapter.

## Results

A message is displayed, indicating whether the deployment action succeeded or failed.

**Note:** When the development server is started, adapters are automatically deployed after they are created or modified and saved. You can view this feature by clicking **Window > Preferences**. Select **MobileFirst**. To change this feature, clear the **Automatically Deploy Adapters on Change** check box. The default value of this feature is **true**. The **preview** command automatically deploys all adapters that are not deployed for a project if this preference is set to **true**.

## Testing adapters

You can select a procedure, enter a set of parameters, and invoke the procedure on the MobileFirst Server.

### Testing adapters with MobileFirst Platform Command Line Interface for iOS (CLI)

To test an adapter by using CLI, you must call the adapter.

To call an adapter by using CLI, run the **mfp adapter call** command. For more information about this command, see **mfp adapter call**.

### Testing adapters with external tools such as Postman

MobileFirst Java adapters expose a full REST API. If you know the URL of a resource or procedure, you can use HTTP tools such as Postman to test requests and pass the following parameters.

- URL parameters

- Path parameters
- Body parameters
- Headers

If your resource is protected by a security scope, the request prompts you to provide a valid authorization header. The default value of this security scope is simple. Unless you disabled security, the endpoint is protected.

As a solution for testing, the development version of the MobileFirst Server includes a test token endpoint.

To receive a Test Token, create an HTTP POST request to `http(s)://{server_ip}:{server_port}/{project_name}/authorization/v1/testtoken` with your HTTP client (Postman).

You receive a JSON object with a temporary valid authorization token.

```
{
 "Authorization": "Bearer eyJhbGciOiJSUzI1NiIsImpwayI6eyJhbGciOiJSU0EiLCJleHAiOiJBUUFCIiwibW9kIjoj
QU0wRGQ3eEFkdjZILX1nTDdyOHFDtGRFLTNjMm2FPZU1xb2UtckpBMHVadXcyckhowFozV1ZDZUt1e1JWY0NPWNRTi1t
UUsbwWZ6NV8zby1ldjBVWXdYa1NPd0JCbdFFaHFJd1ZEed09pZwcySk1HbDBFWHNQWmZrT1pJLUhVNG9NaWktVHJ0THp..."
}
```

In your next requests to the adapter endpoints, add an HTTP header with the name `Authorization` and the value that you received that starts with `Bearer`.

Now that you have a valid token, you can access the resource by using the security framework.

For more information about the test token endpoint, see “The test token endpoint” on page 8-241.

## Client access to adapters

Clients can access adapters from three endpoints in the IBM MobileFirst Platform Server.

The following table summarizes the supported adapter types, HTTP methods, and security model for each MobileFirst Server endpoint.

Table 8-13. Client access to MobileFirst Server endpoints

Endpoint	Supported for Java adapters	Supported for JavaScript adapters	Permitted HTTP methods	Supported security model
/adapters	yes	yes	GET, POST, PUT, DELETE, HEAD, TRACE	OAuth 2.0-based
/apps/services/api/query	no	yes	POST	Pre-V7.0
/invoke	no	yes	GET, POST	Pre-V7.0

### Accessing adapters from the /adapters endpoint

Clients can access both Java and JavaScript adapters from the /adapters endpoint on the server. You can access this endpoint from both mobile and non-mobile clients.

The URL pattern for accessing the /adapters endpoint is as follows:

```
http(s)://<server>:<port>/<Context>/adapters/<adapter-name>/*
```



For example, assuming that `http://mfp-server-host/project` is the IBM MobileFirst Platform Foundation for iOS project URL, and the project contains one Java adapter named `adapter1` and the adapter has a resource with path `/res1`, then `/res1` is accessible from the following URL:

`http://mfp-server-host/project/adapters/adapter1/res1`

**Note:** Using the `/adapters` endpoint is the recommended way to access IBM MobileFirst Platform Foundation for iOS adapters. This endpoint supports both JavaScript and Java adapters and is protected by the OAuth security mechanism, which was introduced beginning with MobileFirst V7.0.

## Accessing adapters from a mobile client

IBM MobileFirst Platform Foundation for iOS provides a client API for accessing OAuth protected resources such as adapters. If you choose to use MobileFirst client for that purpose, it will automatically handle security for you. The following example demonstrates how to use the client API to access an adapter resource:

### Native iOS client

```
NSString static *const RESOURCE_URL = @"adapters/adapter1/res1";
WLResourceRequest *request = [WLResourceRequest requestWithURL:[NSURL URLWithString:RESOURCE_URL] method:WLRequestMethodGet];
[request sendWithCompletionHandler:^(WLResponse *response, NSError *error) {
 NSString *httpStatus = [NSString stringWithFormat:@"%d", [response status]];
 self.httpStatusTextField.text = httpStatus;
 if (error != nil) {
 [self updateView:[error description]];
 } else {
 [self updateView:[response.responseText]];
 }
}];
```

## Accessing adapters from non-mobile clients

When accessing adapters from non-mobile clients, note the following:

- You can access unprotected resources using a non-mobile client.
- In production, it is not possible to access protected resources without a mobile device.
- In a development environment, it is possible to access protected resources by using a test token. For more information, see [The test token endpoint](#).

## RESTful access to JavaScript adapters

In addition to invoking JavaScript adapters over HTTP by using IBM MobileFirst Platform Foundation for iOS from the `/adapter` endpoint, you can call existing JavaScript adapter procedures over HTTP via REST URLs.

The URL pattern is as follows:

`http(s)://<server>:<port>/<Context>/adapters/<adapter-name>/<procedure-name>`

For example:

`http://<hostname>:<port>/mfp/adapters/TodaysNews/getStories?params=['world']`

Both the GET and POST methods can be used to call the adapter procedure. The procedure arguments are passed as the value of a parameter called **params**. This parameter is a query parameter for GET requests and a form parameter for POST requests. The value must be a JSON array of parameters that are provided in order.

**Note:**

For successful invocations, the status code of the HTTP response is set to 200 (OK). The response body contains the JSON output that resulted from the invocation of the JavaScript adapter. If an error occurred during adapter invocation, the status code is set to 500 (Internal Server Error).

**Accessing adapters from the /apps/services/api/query endpoint**

In versions of IBM MobileFirst Platform Foundation for iOS previous to V7.0 this endpoint was the preferred access point for clients.

The client API that can be used to access adapters from this endpoint is `invokeProcedure` in the `WLClient` class. For more information, see `WLClient` iOS API.

**Accessing adapters from the /invoke endpoint**

JavaScript adapter procedures can be invoked by issuing an HTTP request to the MobileFirst `/invoke` endpoint.

The URL pattern for accessing the `/invoke` endpoint is as follows

`http(s)://<server>:<port>/<Context>/invoke`

**Note:** The usage of the `/invoke` endpoint is discouraged. Consider using the `/adapters` endpoint even when invoking a JavaScript adapter procedure. For more information, see “Accessing adapters from the `/adapters` endpoint” on page 8-158.

The following parameters are required:

*Table 8-14. Parameters for adapter invocation*

Property	Description
<b>adapter</b>	The name of the adapter
<b>procedure</b>	The name of the procedure
<b>parameters</b>	An array of parameter values

The request can be either GET or POST.

**Note:** The invocation service uses the same authentication framework as described in the “MobileFirst security framework” on page 8-221 section.

The default security test for adapter procedures contains Anti-XSRF protection, but this configuration can be overridden by either:

- Implementing your own authentication realm (see “Authenticators and login modules” on page 8-257 for more details).
- Disabling the authentication requirement for a specific procedure. You can do so by adding the **securityTest**="`wl_unprotected`" property to the `<procedure>` element in the adapter XML file.

**Note:** Disabling authentication requirement on a procedure means that this procedure becomes completely unprotected and anyone who knows the adapter and the procedure name can access it. Therefore, consider protecting sensitive adapter procedures.

---

## JSONStore

Learn about JSONStore.

### JSONStore overview

JSONStore features add the ability to store JSON documents in MobileFirst applications.

JSONStore is a lightweight, document-oriented storage system that is included as a feature of IBM MobileFirst Platform Foundation for iOS, and enables persistent storage of JSON documents. Documents in an application are available in JSONStore even when the device that is running the application is offline. This persistent, always-available storage can be useful for customers, employees, or partners, to give them access to documents when, for example, there is no network connection to the device.

For JSONStore API reference information for native iOS applications, see the [JSONStore Class Reference](#) in the API reference section.

Here is a high-level summary of what JSONStore provides:

- A developer-friendly API that gives developers the ability to populate the local store with documents, and to update, delete, and search across documents.
- Persistent, file-based storage matches the scope of the application.
- AES 256 encryption of stored data provides security and confidentiality. You can segment protection by user with password-protection, in the case of more than one user on a single device.
- Ability to keep track of local changes.

A single store can have many collections, and each collection can have many documents. It is also possible to have a MobileFirst application that contains multiple stores. For information, see “JSONStore multiple user support” on page 8-179.

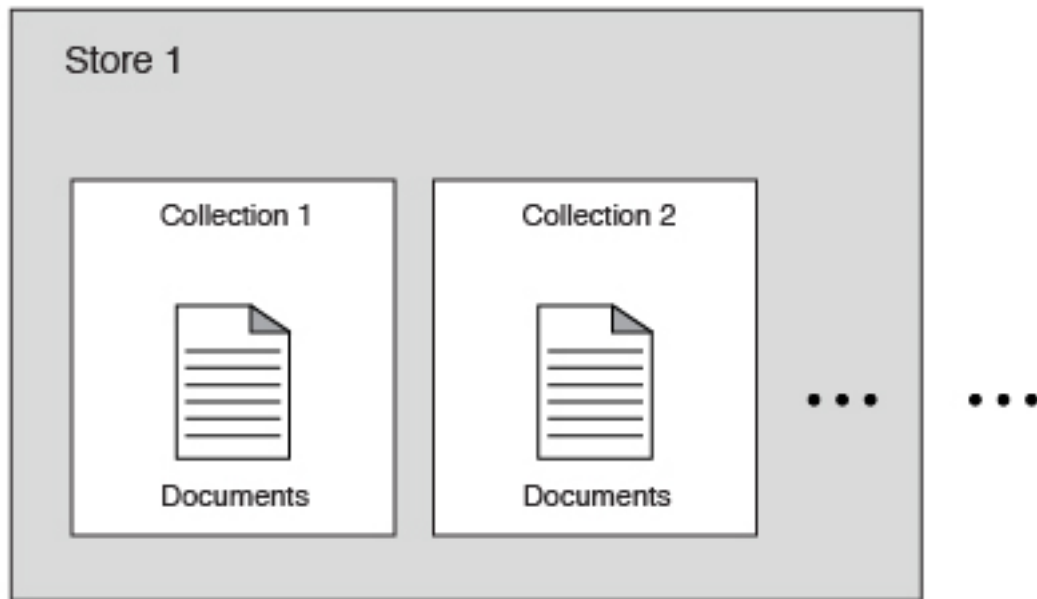

Figure 8-19. A basic graphic representation of JSONStore.

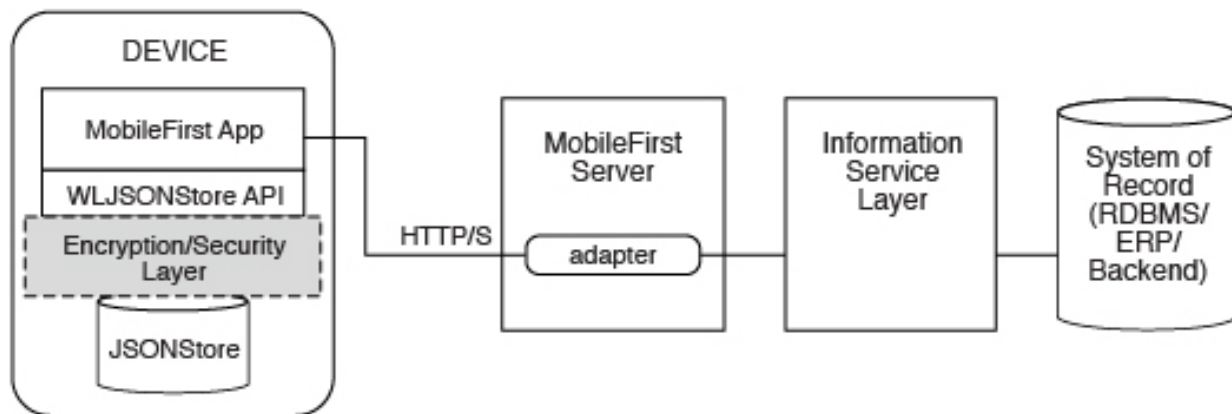

Figure 8-20. Components and their interaction with the server when you use JSONStore for data synchronization.

**Note:** Because it is familiar to developers, relational database terminology is used in this documentation at times to help explain JSONStore. There are many differences between a relational database and JSONStore however. For example, the strict schema that is used to store data in relational databases is different from JSONStore's approach. With JSONStore, you can store any JSON content, and index the content that you need to search.

## General JSONStore terminology

Learn about general JSONStore terminology.

### JSONStore document

A document is the basic building block of JSONStore.

A JSONStore document is a JSON object with an automatically generated identifier (`_id`) and JSON data. It is similar to a record or a row in database terminology. The value of `_id` is always a unique integer inside a specific collection. Some functions like the `add`, `replace`, and `remove` methods in the `JSONStoreInstance` class take an Array of Documents/Objects. These methods are useful to perform operations on various Documents/Objects at a time.

## Example

Single document

```
var doc = { _id: 1, json: {name: 'carlos', age: 99} };
```

## Example

Array of documents

```
var docs = [
 { _id: 1, json: {name: 'carlos', age: 99} },
 { _id: 2, json: {name: 'tim', age: 100} }
]
```

## JSONStore collection

A JSONStore collection is similar to a table, in database terminology

## Example

Customer collection

```
[
 { _id: 1, json: {name: 'carlos', age: 99} },
 { _id: 2, json: {name: 'tim', age: 100} }
]
```

This code is not the way that the documents are stored on disk, but it is a good way to visualize what a collection looks like at a high level.

## JSONStore store

A store is the persistent JSONStore file that contains one or more collections.

A store is similar to a relational database, in database terminology. A store is also referred to as a JSONStore.

## JSONStore search fields

A search field is a key/value pair.

Search fields are keys that are indexed for fast lookup times, similar to column fields or attributes, in database terminology.

Extra search fields are keys that are indexed but that are not part of the JSON data that is stored. These fields define the key whose values (in the JSON collection) are indexed and can be used to search more quickly.

Valid data types are: string, boolean, number, and integer. These types are only type hints, there is no type validation. Furthermore, these types determine how

indexable fields are stored. For example, {age: 'number'} will index 1 as 1.0 and {age: 'integer'} will index 1 as 1.

## Examples

Search fields and extra search fields.

```
var searchField = {name: 'string', age: 'integer'};
var additionalSearchField = {key: 'string'};
```

It is only possible to index keys inside an object, not the object itself. Arrays are handled in a pass-through fashion, meaning that you cannot index an array or a specific index of the array (`arr[n]`), but you can index objects inside an array.

Indexing values inside an array.

```
var searchFields = {
 'people.name' : 'string', // matches carlos and tim on myObject
 'people.age' : 'integer' // matches 99 and 100 on myObject
};

var myObject = {
 people : [
 {name: 'carlos', age: 99},
 {name: 'tim', age: 100}
]
};
```

## JSONStore queries

Queries are objects that use search fields or extra search fields to look for documents.

The example presumes that the name search field is of type string and the age search field is of type integer.

## Examples

Find documents with name that matches carlos:

```
var query1 = {name: 'carlos'};
```

Find documents with name that matches carlos and age matches 99:

```
var query2 = {name: 'carlos', age: 99};
```

## JSONStore query parts

Query parts are used to build more advanced searches. Some JSONStore operations, such as some versions of `find` or `count` take query parts. Everything within a query part is joined by AND statements, while query parts themselves are joined by OR statements. The search criteria returns a match only if everything within a query part is true. You can use more than one query part to search for matches that satisfy one or more of the query parts.

Find with query parts operate only on top-level search fields. For example: `name`, and not `name.first`. Use multiple collections where all search fields are top-level to get around this. The query parts operations that work with non top-level search fields are: `equal`, `notEqual`, `like`, `notLike`, `rightLike`, `notRightLike`, `leftLike`, and `notLeftLike`. The behavior is undetermined if you use non-top-level search fields.

## JSONStore API concepts

JSONStore provides API reference information for iOS applications.

### Store

#### Open and initialize a collection

Starts one or more collections. Starting or provisioning a JSONStore collection means that the persistent storage that is used to contain collections and documents is created, if it does not exist. If the store is encrypted and a correct password is passed, the required security procedures to make the data accessible are run. There is minimal effort in initializing all the collections when an application starts.

After you open a collection, an accessor to the collection is available, which gives access to collection APIs. It allows developers to call functions such as `find`, `add`, and `replace` on an initialized collection.

It is possible to initialize multiple times with different collections. New collections are initialized without affecting collections that are already initialized.

#### Destroy

Completely wipes data for all users, destroys the internal storage, and clears security artifacts. The `destroy` function removes the following data:

- All documents.
- All collections.
- All stores. For more information, see “JSONStore multiple user support” on page 8-179.
- All JSONStore metadata and security artifacts. For more information, see “JSONStore security” on page 8-178.

#### Close all

Locks access to all the collections in a store until the collections are reinitialized. Where `initialize` can be considered a login, `close` can be considered a logout.

#### Start, commit, and rollback transaction

A transaction is a set of operations that must all succeed for the operations to manipulate the store. If any operation fails, the transaction can be rolled back to revert the store to its previous state. After a transaction is started, it is important that you handle committing or rolling back your transactions to prevent excess processing. Three operations exist in the Store API for transactions:

- 

##### Start transaction

Begin a snapshot in which the store is reverted to if the transaction fails.

- 

##### Commit transaction

Inform the store that all operations in the transaction succeeded, and all changes can be finalized.

-

### **Rollback transaction**

Inform the store that an operation in the transaction failed, and all changes must be discarded.

## **Collection**

### **Store and add a document**

You can add a document or array of documents to a collection. You can also pass an array of objects (for example `[{name: 'carlos'}, {name: 'tim'}]`) instead of a single object. Every object in the array is stored as a new document inside the collection.

### **Remove a document**

Marks one or more documents as removed from a collection. Removed documents are not returned by the `find` or `count` operations.

### **Find All Documents, Find Documents by Id, and Find With Query**

You can find documents in a collection by their search fields and extra search fields. An internal search field, `_id`, holds a unique integer identifier that can be used to find the document (Find by Id). You can search for documents with the following APIs:

- 

#### **Find All Documents**

Returns every document in a collection.

- 

#### **Find All Dirty Documents**

Returns every document in a collection that is marked dirty.

- 

#### **Find by Id**

Find the document with the corresponding `_id` search key value.

- 

#### **Find With Query or Query Parts**

Find all documents that match a query or all query parts. For more information, see the Search Query format section at “Additional references” on page 8-167.

`Filter` returns what is being indexed, which might be different than what was saved to a collection. Some examples of unexpected results are:

1. If your search field has upper case letters, the result is returned in all lower-case letters.
2. If you pass something that is not a string, it is indexed as a string. For example, `1` is `'1'`, `1.0` is `'1.0'`, `true` is `'1'`, and `false` is `'0'`.
3. If your filter criteria includes non top-level search fields, you might get a single string with all the terms that are joined by a special identifier (`-@-`). For example, `'carlos-@-mike-@-dgonz'`.



## Replace a document and change documents

You can use the Replace API to replace the contents of a document in the collection with new data, which is based on the `_id`. If the data contains the `_id` field of a document in the database, the document is replaced with the data and all search fields are reindexed for that document.

The Change API is similar to the Replace API, but the Replace is based on a set of search field criteria instead of `_id`. The Replace API can be emulated by performing the Change API with the search field criteria of only `_id`. All search fields in the search field criteria must exist in the documents in the store, and in the data that is passed to the Change API.

## Count All Documents, Count All Dirty Documents, and Count With Query

The Count API returns an integer number by counting the total number of documents that match the query. There are three Count APIs:

- 

### Count All Documents

Give the total count of all documents in the collection.

- 

### Count All Dirty Documents

Give the total number of documents in the collection that are currently marked dirty.

- 

### Count With Query or Query Parts

Give the total number of documents that match a specific search query. For more information, see the Search Query format section at “Additional references.”

## Remove Collection and Clear Collection

Removing a collection deletes all data that is associated with a collection, and causes the collection accessor to be no longer usable.

Clearing a collection deletes all documents in the collection. This operation keeps the collection open after it completes.

## Mark Clean

The Mark Clean API is used to remove the dirty flag from a document in the collection, and deletes the document completely from the collection if it was marked dirty by a remove document operation. The Mark Clean API is useful when used with the Find All Dirty Documents API to sync the collection with a remote database.

## Additional references

### Search Query format

When an API requires a search query, a common format is followed for the collection. A query consists of an array of objects where each key/value pair is ANDed together. Each object in the array is ORed together. For example:

```
[{fn: "Mike", age: 30}, {fn: "Carlos", age: 36}]
```

is represented as (with fuzzy search):

```
(fn LIKE "%Mike%" AND age LIKE "%30%") OR (fn LIKE "%Carlos%" AND age LIKE "%36%")
```

## Search Query Parts format

The following examples use pseudocode to convey how query parts work. A query such as {name: 'carlos', age: 10} can be passed a modifier such as {exact: true}, which ensures only items that exactly match name and age are returned. Query parts give you the flexibility of adding modifiers to any part of the query. For example:

```
queryPart1 = QueryPart().like('name', 'carlos').lessThan('age', 10);
```

The previous example is transformed into something like:

```
('name' LIKE %carlos%) AND (age < 10)
```

You can also create another query part, for example:

```
queryPart2 = QueryPart().equal('name', 'mike')
```

When you add various query parts with the find API, for example:

```
find([queryPart1, queryPart2])
```

You get something like:

```
(('name' LIKE %carlos%) AND (age < 10)) OR (name EQUAL 'mike')
```

## Limit and Offset

Passing a limit to an API's options restricts the number of results by the number specified. It is also possible to pass an offset to skip results by the number specified. To pass an offset, a limit must also be passed. This API is useful for implementing pagination or for optimization. By limiting the data to a subset that is necessary, the memory and processing power is reduced.

## Fuzzy Search versus Exact Search

The default behavior is fuzzy searching, which means that queries return partial results. For example, the query {name: 'carl'} finds 'carlos' and 'carl' (for example, name LIKE '%carl%'). When {exact: true} is passed, matches are exact but not case-sensitive. For example, 'hello' matches 'Hello' (for example, name.toLowerCase() = 'hello'). Integer matching is not type-sensitive. For example, "1" matches both "1" and "1.0". Numbers are stored as their decimal representation. For example, "1" is stored as "1.0". Boolean values are indexed as 1 (true) and 0 (false).

## Troubleshooting JSONStore

Find information to help resolve issues that you might encounter when you use the JSONStore API.

### JSONStore troubleshooting overview

Find information to help resolve issues that you might encounter when you use the JSONStore API.

## Provide information when you ask for help

It is better to provide more information than to risk not providing enough information. The following list is a good starting point for the information that is required to help with JSONStore issues.

- Operating system and version. For example, Mac OSX 10.8.3.
- JDK version. For example, Java SE Runtime Environment (build 1.7).
- IBM MobileFirst Platform Foundation for iOS version. For example, IBM Worklight V5.0.6 Developer Edition.
- iOS version. For example, iOS Simulator 6.1 or iPhone 4S iOS 6.0.
- Logs, such as Xcode.

## Try to isolate the issue

Follow these steps to isolate the issue to more accurately report a problem.

1. Reset the simulator and call the destroy API to start with a clean system.
2. Ensure that you are running on a supported production environment.
  - iOS >= 6.0 simulator or device
3. Try to turn off encryption by not passing a password to the `init` or `open` APIs.
4. Look at the SQLite database file that is generated by JSONStore. Encryption must be turned off.
  - iOS simulator:

```
$ cd ~/Library/Application Support/iPhone Simulator/7.1/Applications/<id>/Documents/wljsonstore
$ sqlite3 jsonstore.sqlite
```

- Look at the searchFields with `.schema` and select data with `SELECT * FROM <collection-name>;`. To exit sqlite3, type `.exit`. If you pass a user name to the `init` method, the file is called `<username>.sqlite`. If you do not pass a user name, the file is called `jsonstore.sqlite` by default.
5. Use the debugger.

## Common issues

Understanding the following JSONStore characteristics can help resolve some of the common issues that you might encounter.

- The only way to store binary data in JSONStore is to first encode it in base64. Store file names or paths instead of the actual files in JSONStore.
- Accessing JSONStore data from native code is possible only in IBM MobileFirst Platform Foundation for iOS V6.2.0.
- There is no limit on how much data you can store inside JSONStore, beyond limits that are imposed by the mobile operating system.
- JSONStore provides persistent data storage. It is not only stored in memory.
- The `init` API fails when the collection name starts with a digit or symbol. IBM Worklight V5.0.6.1 and later returns an appropriate error:  
4 BAD\_PARAMETER\_EXPECTED\_ALPHANUMERIC\_STRING
- There is a difference between a number and an integer in search fields. Numeric values like 1 and 2 are stored as 1.0 and 2.0 when the type is number. They are stored as 1 and 2 when the type is integer.
- If an application is forced to stop or crashes, it always fails with error code -1 when the application is started again and the `init` or `open` API is called. If this problem happens, call the `closeAll` API first.
- When you use JSONStore on a 64-bit device, you might see the following error:

java.lang.UnsatisfiedLinkError: dlopen failed: "... is 32-bit instead of 64-bit

This error means that you have 64-bit native libraries in your Android project, and JSONStore does not currently work when you use these libraries. To confirm, go to `src/main/libs` or `src/main/jniLibs` under your Android project, and check whether you have the `x86_64` or `arm64-v8a` folders. If you do, delete these folders, and JSONStore can work again.

## Store internals

See an example of how JSONStore data is stored.

The key elements in this simplified example:

- `_id` is the unique identifier (for example, AUTO INCREMENT PRIMARY KEY).
- `json` contains an exact representation of the JSON object that is stored.
- `name` and `age` are search fields.
- `key` is an extra search field.

## Example

Table 8-15. Contents of a store in JSONStore

<code>_id</code>	<code>key</code>	<code>name</code>	<code>age</code>	<code>JSON</code>
1	c	carlos	99	{name: 'carlos', age: 99}
2	t	time	100	{name: 'tim', age: 100}

When you search by using one of the following queries or a combination of them: `{_id : 1}`, `{name: 'carlos'}`, `{age: 99}`, `{key: 'c'}`, the returned document is `{_id: 1, json: {name: 'carlos', age: 99} }`.

The other internal JSONStore fields are:

### **`_dirty`**

Determines whether the document was marked as dirty or not. This field is useful to track changes to the documents. For more information, see “JSONStore API concepts” on page 8-165 or “Work with external data” on page 8-181.

### **`_deleted`**

Marks a document as deleted or not. This field is useful to remove objects from the collection, to later use them to track changes with your backend and decide whether to remove them or not.

### **`_operation`**

A string that reflects the last operation to be performed on the document (for example, replace).

## JSONStore errors

Learn about JSONStore errors.

Possible JSONStore error codes that are returned are listed in “JSONStore error codes” on page 8-171.

## Objective-C

All of the APIs that might fail take an error parameter that takes an address to an NSError object. If you don't want to be notified of errors, you can pass in nil. When an operation fails, the address is populated with an NSError, which has an error and some potential userInfo. The userInfo might contain extra details (for example, the document that caused the failure).

### Example

```
// This NSError points to an error if one occurs.
NSError* error = nil;

// Perform the destroy.
[JSONStore destroyDataAndReturnError:&error];
```

### JSONStore error codes

Definitions of the error codes that are related to JSONStore.

#### **-100 UNKNOWN\_FAILURE**

Unrecognized error.

#### **-75 OS\_SECURITY\_FAILURE**

This error code is related to the requireOperatingSystemSecurity flag. It can occur if the destroy API fails to remove security metadata that is protected by operating system security (Touch ID with passcode fallback), or the init or open APIs are unable to locate the security metadata. It can also fail if the device does not support operating system security, but operating system security usage was requested.

#### **-50 PERSISTENT\_STORE\_NOT\_OPEN**

JSONStore is closed. Try calling the open method in the JSONStore class first to enable access to the store.

#### **-48 TRANSACTION\_FAILURE\_DURING\_ROLLBACK**

There was a problem with rolling back the transaction.

#### **-47 TRANSACTION\_FAILURE\_DURING\_REMOVE\_COLLECTION**

Cannot call removeCollection while a transaction is in progress.

#### **-46 TRANSACTION\_FAILURE\_DURING\_DESTROY**

Cannot call destroy while there are transactions in progress.

#### **-45 TRANSACTION\_FAILURE\_DURING\_CLOSE\_ALL**

Cannot call closeAll while there are transactions in place.

#### **-44 TRANSACTION\_FAILURE\_DURING\_INIT**

Cannot initialize a store while there are transactions in progress.

#### **-43 TRANSACTION\_FAILURE**

There was a problem with transactions.

#### **-42 NO\_TRANSACTION\_IN\_PROGRESS**

Cannot commit to rolled back a transaction when there is no transaction in progress.

#### **-41 TRANSACTION\_IN\_PROGRESS**

Cannot start a new transaction while another transaction is in progress.

#### **-40 FIPS\_ENABLEMENT\_FAILURE**

Something is wrong with FIPS. See the tutorial on the Getting Started page.

#### **-24 JSON\_STORE\_FILE\_INFO\_ERROR**

Problem getting the file information from the file system.

- 23 **JSON\_STORE\_REPLACE\_DOCUMENTS\_FAILURE**  
Problem replacing documents from a collection.
- 22 **JSON\_STORE\_REMOVE\_WITH\_QUERIES\_FAILURE**  
Problem removing documents from a collection.
- 21 **JSON\_STORE\_STORE\_DATA\_PROTECTION\_KEY\_FAILURE**  
Problem storing the Data Protection Key (DPK).
- 20 **JSON\_STORE\_INVALID\_JSON\_STRUCTURE**  
Problem indexing input data.
- 12 **INVALID\_SEARCH\_FIELD\_TYPES**  
Check that the types that you are passing to the searchFields are **stringinteger, number, or boolean**.
- 11 **OPERATION\_FAILED\_ON\_SPECIFIC\_DOCUMENT**  
An operation on an array of documents, for example the replace method can fail while it works with a specific document. The document that failed is returned and the transaction is rolled back.
- 10 **ACCEPT\_CONDITION\_FAILED**  
The accept function that the user provided returned false.
- 9 **OFFSET\_WITHOUT\_LIMIT**  
To use offset, you must also specify a limit.
- 8 **INVALID\_LIMIT\_OR\_OFFSET**  
Validation error, must be a positive integer.
- 7 **INVALID\_USERNAME**  
Validation error (Must be [A-Z] or [a-z] or [0-9] only).
- 6 **USERNAME\_MISMATCH\_DETECTED**  
To log out, a JSONStore user must call the closeAll method first. There can be only one user at a time.
- 5 **DESTROY\_REMOVE\_PERSISTENT\_STORE\_FAILED**  
A problem with the destroy method while it tried to delete the file that holds the contents of the store.
- 4 **DESTROY\_REMOVE\_KEYS\_FAILED**  
Problem with the destroy method while it tried to clear the keychain (iOS).
- 3 **INVALID\_KEY\_ON\_PROVISION**  
Passed the wrong password to an encrypted store.
- 2 **PROVISION\_TABLE\_SEARCH\_FIELDS\_MISMATCH**  
Search fields are not dynamic. It is not possible to change search fields without calling the destroy method or the removeCollection method before you call the init or openmethod with the new search fields. This error can occur if you change the name or type of the search field. For example: {key: 'string'} to {key: 'number'} or {myKey: 'string'} to {theKey: 'string'}.
- 1 **PERSISTENT\_STORE\_FAILURE**  
Generic Error. A malfunction in native code, most likely calling the init method.
- 0 **SUCCESS**  
In some cases, JSONStore native code returns 0 to indicate success.
- 1 **BAD\_PARAMETER\_EXPECTED\_INT**  
Validation error.

- 2 BAD\_PARAMETER\_EXPECTED\_STRING**  
Validation error.
- 3 BAD\_PARAMETER\_EXPECTED\_FUNCTION**  
Validation error.
- 4 BAD\_PARAMETER\_EXPECTED\_ALPHANUMERIC\_STRING**  
Validation error.
- 5 BAD\_PARAMETER\_EXPECTED\_OBJECT**  
Validation error.
- 6 BAD\_PARAMETER\_EXPECTED\_SIMPLE\_OBJECT**  
Validation error.
- 7 BAD\_PARAMETER\_EXPECTED\_DOCUMENT**  
Validation error.
- 8 FAILED\_TO\_GET\_UNPUSHED\_DOCUMENTS\_FROM\_DB**  
The query that selects all documents that are marked dirty failed. An example in SQL of the query would be: **SELECT \* FROM [collection] WHERE \_dirty > 0.**
- 9 NO\_ADAPTER\_LINKED\_TO\_COLLECTION**  
To use functions like the push and load methods in the JSONStoreCollection class, an adapter must be passed to the init method.
- 10 BAD\_PARAMETER\_EXPECTED\_DOCUMENT\_OR\_ARRAY\_OF\_DOCUMENTS**  
Validation error
- 11**  
**INVALID\_PASSWORD\_EXPECTED\_ALPHANUMERIC\_STRING\_WITH\_LENGTH\_GREATER\_THAN\_ZERO**  
Validation error
- 12 ADAPTER\_FAILURE**  
Problem calling `WL.Client.invokeProcedure`, specifically a problem in connecting to the MobileFirst Server adapter. This error is different from a failure in the adapter that tries to call a backend.
- 13 BAD\_PARAMETER\_EXPECTED\_DOCUMENT\_OR\_ID**  
Validation error
- 14 CAN\_NOT\_REPLACE\_DEFAULT\_FUNCTIONS**  
Calling the enhance method in the JSONStoreCollection class to replace an existing function (find and add) is not allowed.
- 15 COULD\_NOT\_MARK\_DOCUMENT\_PUSHED**  
Push sends the document to an adapter but JSONStore fails to mark the document as not dirty.
- 16 COULD\_NOT\_GET\_SECURE\_KEY**  
To initiate a collection with a password there must be connectivity to the MobileFirst Server because it returns a 'secure random token'. IBM Worklight 5.0.6 and later allows developers to generate the secure random token locally passing `{localKeyGen: true}` to the init method via the options object.
- 17 FAILED\_TO\_LOAD\_INITIAL\_DATA\_FROM\_ADAPTER**  
Could not load data because `WL.Client.invokeProcedure` called the failure callback.
- 18 FAILED\_TO\_LOAD\_INITIAL\_DATA\_FROM\_ADAPTER\_INVALID\_LOAD\_OBJ**  
The load object that was passed to the init method did not pass the validation.

- 19 INVALID\_KEY\_IN\_LOAD\_OBJECT**  
There is a problem with the key used in the load object when you call the add method.
- 20 UNDEFINED\_PUSH\_OPERATION**  
No procedure is defined for pushing dirty documents to the server. For example: the `init` method (new document is dirty, `operation = 'add'`) and the `push` method (finds the new document with `operation = 'add'`) were called, but no add key with the add procedure was found in the adapter that is linked to the collection. Linking an adapter is done inside the `init` method.
- 21 INVALID\_ADD\_INDEX\_KEY**  
Problem with extra search fields.
- 22 INVALID\_SEARCH\_FIELD**  
One of your search fields is invalid. Verify that none of the search fields that are passed in are `_id,json,_deleted`, or `_operation`.
- 23 ERROR\_CLOSING\_ALL**  
Generic Error. An error occurred when native code called the `closeAll` method.
- 24 ERROR\_CHANGING\_PASSWORD**  
Unable to change the password. The old password passed was wrong, for example.
- 25 ERROR\_DURING\_DESTROY**  
Generic Error. An error occurred when native code called the `destroy` method.
- 26 ERROR\_CLEARING\_COLLECTION**  
Generic Error. An error occurred in when native code called the `removeCollection` method.
- 27 INVALID\_PARAMETER\_FOR\_FIND\_BY\_ID**  
Validation error.
- 28 INVALID\_SORT\_OBJECT**  
The provided array for sorting is invalid because one of the JSON objects is invalid. The correct syntax is an array of JSON objects, where each object contains only a single property. This property searches the field with which to sort, and whether it is ascending or descending. For example: `{searchField1 : "ASC"}`.
- 29 INVALID\_FILTER\_ARRAY**  
The provided array for filtering the results is invalid. The correct syntax for this array is an array of strings, in which each string is either a search field or an internal JSONStore field. For more information, see "Store internals" on page 8-170.
- 30 BAD\_PARAMETER\_EXPECTED\_ARRAY\_OF\_OBJECTS**  
Validation error when the array is not an array of only JSON objects.
- 31 BAD\_PARAMETER\_EXPECTED\_ARRAY\_OF\_CLEAN\_DOCUMENTS**  
Validation error.
- 32 BAD\_PARAMETER\_WRONG\_SEARCH\_CRITERIA**  
Validation error.

## JSONStore examples

Learn about how to get started with JSONStore examples.

### Objective-C API examples

You can use JSONStore for MobileFirst applications.



The following sections contain example implementations for iOS devices with JSONStore APIs. Other helpful topics include:

- “JSONStore overview” on page 8-161 - Learn about key concepts.
- “JSONStore API concepts” on page 8-165 - Learn about general information about the APIs that apply to all implementations of the JSONStore API.
- “Troubleshooting JSONStore” on page 8-168 - Learn how to debug and understand possible errors.
- “JSONStore advanced topics” on page 8-178 - Learn about security, multiple user support, performance, and concurrency.
- JSONStore Class Reference - Learn about JSONStore APIs for Objective-C.
- “Work with external data” on page 8-181 - Explains how to get data from an external source and send changes back to the external source.

### Initialize and open connections, get an Accessor, and add data

```
// Create the collections object that will be initialized.
JSONStoreCollection* people = [[JSONStoreCollection alloc] initWithName:@"people"];
[people setSearchField:@"name" withType:JSONStore_String];
[people setSearchField:@"age" withType:JSONStore_Integer];

// Optional options object.
JSONStoreOpenOptions* options = [JSONStoreOpenOptions new];
[options setUsername:@"carlos"]; //Optional username, default 'jsonstore'
[options setPassword:@"123"]; //Optional password, default no password

// This object will point to an error if one occurs.
NSError* error = nil;

// Open the collections.
[[JSONStore sharedInstance] openCollections:@[people] withOptions:options error:&error];

// Add data to the collection
NSArray* data = @[@{@"name" : @"carlos", @"age": @10}];
int newDocsAdded = [[people addData:data andMarkDirty:YES withOptions:nil error:&error] intValue];
```

### Initialize with a secure random token from the server

```
[WLSecurityUtils getRandomStringFromServerWithBytes:32
 timeout:1000
 completionHandler:^(NSURLResponse *response,
 NSData *data,
 NSError *connectionError) {

// You might want to see the response and the connection error
// before moving forward.

// Get the secure random string by using the data that is
// returned from the generator on the server.
NSString* secureRandom = [[NSString alloc] initWithData:data encoding:NSUTF8StringEncoding];

JSONStoreCollection* ppl = [[JSONStoreCollection alloc] initWithName:@"people"];
[ppl setSearchField:@"name" withType:JSONStore_String];
[ppl setSearchField:@"age" withType:JSONStore_Integer];

// Optional options object.
JSONStoreOptions* options = [JSONStoreOptions new];
[options setUsername:@"carlos"]; //Optional username, default 'jsonstore'
[options setPassword:@"123"]; //Optional password, default no password
[options setSecureRandom:secureRandom]; //Optional, default one will be generated locally

// This points to an error if one occurs.
NSError* error = nil;

[[JSONStore sharedInstance] openCollections:@[ppl] withOptions:options error:&error];

// Other JSONStore operations (e.g. add, remove, replace, etc.) go here.
}];
```

## Find - locate documents inside the Store

```
// Get the accessor to an already initialized collection.
JSONStoreCollection* people = [[JSONStore sharedInstance] getCollectionWithName:@"people"];

// This object will point to an error if one occurs.
NSError* error = nil;

// Add additional find options (optional).
JSONStoreQueryOptions* options = [JSONStoreQueryOptions new];
[options setLimit:@10]; // Returns a maximum of 10 documents, default no limit.
[options setOffset:@0]; // Skip 0 documents, default no offset.

// Search fields to return, default: ['_id', 'json'].
[options filterSearchField:@"_id"];
[options filterSearchField:@"json"];

// How to sort the returned values , default no sort.
[options sortBySearchFieldAscending:@"name"];
[options sortBySearchFieldDescending:@"age"];

// Find all documents that match the query part.
JSONStoreQueryPart* queryPart1 = [[JSONStoreQueryPart alloc] init];
[queryPart1 searchField:@"name" equal:@"carlos"];
[queryPart1 searchField:@"age" lessOrEqualThan:@10];

NSArray* results = [people findWithQueryParts:@[queryPart1] andOptions:options error:&error];

// results = @[@{@"_id" : @1, @"json" : @{@"name": @"carlos", @"age" : @10}}];

for (NSDictionary* result in results) {

 NSString* name = [result valueForKeyPath:@"json.name"]; // carlos.
 int age = [[result valueForKeyPath:@"json.age"] intValue]; // 10
 NSLog(@"Name: %@, Age: %d", name, age);
}
```

## Replace - change the documents that are already stored inside a Collection

```
// Get the accessor to an already initialized collection.
JSONStoreCollection* people = [[JSONStore sharedInstance] getCollectionWithName:@"people"];

// Find all documents that match the queries.
NSArray* docs = @[@{@"_id" : @1, @"json" : @{@"name": @"carlitos", @"age" : @99}}];

// This object will point to an error if one occurs.
NSError* error = nil;

// Perform the replacement.
int docsReplaced = [[people replaceDocuments:docs andMarkDirty:NO error:&error] intValue];
```

## Remove - delete all documents that match the query

```
// Get the accessor to an already initialized collection.
JSONStoreCollection* people = [[JSONStore sharedInstance] getCollectionWithName:@"people"];

// This object will point to an error if one occurs.
NSError* error = nil;

// Find document with _id equal to 1 and remove it.
int docsRemoved = [[people removeWithIds:@[@1] andMarkDirty:NO error:&error] intValue];
```

## Count - gets the total number of documents that match a query

```
// Get the accessor to an already initialized collection.
JSONStoreCollection* people = [[JSONStore sharedInstance] getCollectionWithName:@"people"];

// Count all documents that match the query.
// The default query is @{} which will
// count every document in the collection.
JSONStoreQueryPart *queryPart = [[JSONStoreQueryPart alloc] init];
[queryPart searchField:@"name" equal:@"carlos"];

// This object will point to an error if one occurs.
NSError* error = nil;

// Perform the count.
int countResult = [[people countWithQueryParts:@[queryPart] error:&error] intValue];
```

## Destroy - wipes data for all users, destroys the internal storage, and clears security artifacts

```
// This object will point to an error if one occurs.
NSError* error = nil;

// Perform the destroy.
[[JSONStore sharedInstance] destroyDataAndReturnError:&error];
```

## Security - close access to all opened Collections for the current user

```
// This object will point to an error if one occurs.
NSError* error = nil;

// Close access to all collections in the store.
[[JSONStore sharedInstance] closeAllCollectionsAndReturnError:&error];
```

## Security - change the password that is used to access a Store

```
// The password should be user input.
// It is hardcoded in the example for brevity.
NSString* oldPassword = @"123";
NSString* newPassword = @"456";
NSString* username = @"carlos";

// This object will point to an error if one occurs.
NSError* error = nil;

// Perform the change password operation.
[[JSONStore sharedInstance] changeCurrentPassword:oldPassword withNewPassword:newPassword forUsername:username error:&error];

// Remove the passwords from memory.
oldPassword = nil;
newPassword = nil;
```

## Push - get all documents that are marked as dirty, send them to a MobileFirst adapter, and mark them clean

```
// Get the accessor to an already initialized collection.
JSONStoreCollection* people = [[JSONStore sharedInstance] getCollectionWithName:@"people"];

// This object will point to an error if one occurs
NSError* error = nil;

// Return all documents marked dirty
NSArray* dirtyDocs = [people allDirtyAndReturnError:&error];

// ACTION REQUIRED: Handle the dirty documents here
// (e.g. send them to a MobileFirst Adapter).

// Mark dirty documents as clean
int numCleaned = [[people markDocumentsClean:dirtyDocs error:&error] intValue];
```

## Pull - get new data from a MobileFirst adapter

```
// Get the accessor to an already initialized collection.
JSONStoreCollection* people = [[JSONStore sharedInstance] getCollectionWithName:@"people"];

// This object will point to an error if one occurs.
NSError* error = nil;

// ACTION REQUIRED: Get data (e.g. MobileFirst Adapter).
// For this example, it is hardcoded.
NSArray* data = @[@{@"id" : @1, @"ssn": @"111-22-3333", @"name": @"carlos"}];

int numChanged = [[people changeData:data withReplaceCriteria:@{@"id", @"ssn"} addNew:YES markDirty:NO error:&error] intValue];
```

## Check whether a document is dirty

```
// Get the accessor to an already initialized collection.
JSONStoreCollection* people = [[JSONStore sharedInstance] getCollectionWithName:@"people"];

// This object will point to an error if one occurs.
NSError* error = nil;

// Check if document with _id '1' is dirty.
BOOL isDirtyResult = [people isDirtyWithDocumentId:1 error:&error];
```

## Check the number of dirty documents

```
// Get the accessor to an already initialized collection.
JSONStoreCollection* people = [[JSONStore sharedInstance] getCollectionWithName:@"people"];

// This object will point to an error if one occurs.
NSError* error = nil;

// Check if document with _id '1' is dirty.
int dirtyDocsCount = [[people countAllDirtyDocumentsWithError:&error] intValue];
```

## Remove a Collection

```
// Get the accessor to an already initialized collection.
JSONStoreCollection* people = [[JSONStore sharedInstance] getCollectionWithName:@"people"];

// This object will point to an error if one occurs.
NSError* error = nil;

// Remove the collection.
[people removeCollectionWithError:&error];
```

## Clear all data that is inside a Collection

```
// Get the accessor to an already initialized collection.
JSONStoreCollection* people = [[JSONStore sharedInstance] getCollectionWithName:@"people"];

// This object will point to an error if one occurs.
NSError* error = nil;

// Remove the collection.
[people clearCollectionWithError:&error];
```

## Start a transaction, add some data, remove a document, commit the transaction and roll back the transaction if there is a failure

```
// Get the accessor to an already initialized collection.
JSONStoreCollection* people = [[JSONStore sharedInstance] getCollectionWithName:@"people"];

// These objects will point to errors if they occur.
NSError* error = nil;
NSError* addError = nil;
NSError* removeError = nil;

// You can call every JSONStore API method inside a transaction except:
// open, destroy, removeCollection and closeAll.
[[JSONStore sharedInstance] startTransactionAndReturnError:&error];

[people addData:@{@"name" : @"carlos"}] andMarkDirty:NO withOptions:nil error:&addError];

[people removeWithIds:@[1] andMarkDirty:NO error:&removeError];

if (addError != nil || removeError != nil) {

 // Return the store to the state before start transaction was called.
 [[JSONStore sharedInstance] rollbackTransactionAndReturnError:&error];
} else {
 // Commit the transaction thus ensuring atomicity.
 [[JSONStore sharedInstance] commitTransactionAndReturnError:&error];
}
```

## Get file information

```
// This object will point to an error if one occurs
NSError* error = nil;

// Returns information about files JSONStore uses to persist data.
NSArray* results = [[JSONStore sharedInstance] fileInfoAndReturnError:&error];
// => [{"isEncrypted" : @(true), "name" : @"carlos", "size" : @3072}]
```

## JSONStore advanced topics

Learn about JSONStore advanced topics.

### JSONStore security

You can secure all of the collections in a store by encrypting them.

To encrypt all of the collections in a store, pass a password to the open API.

Some security artifacts (such as salt) are stored in the keychain. The store is encrypted with a 256-bit Advanced Encryption Standard (AES) key. All keys are strengthened with Password-Based Key Derivation Function 2 (PBKDF2).

You can choose to encrypt data collections for an application, but you cannot switch between encrypted and plain-text formats, or to mix formats within a store.

The key that protects the data in the store is based on the user password that you provide. The key does not expire, but you can change it by calling the `changePassword` API.

The data protection key (DPK) is the key that is used to decrypt the contents of the store. The DPK is kept in the iOS keychain even if the application is uninstalled. To remove both the key in the keychain and everything else that JSONStore puts in the application, use the `destroy` API.

The first time that JSONStore opens a collection with a password, which means that the developer wants to encrypt data inside the store, JSONStore needs a random token. That random token can be obtained from the client or from the server.

The native iOS implementation generates a cryptographically secure token locally by default, or you can pass one through the `secureRandom` option.

The trade-off is between opening a store offline and trusting the client to generate that random token (less secure), or opening the store with access to the MobileFirst Server (requires connectivity) and trusting the server (more secure).

### **JSONStore multiple user support**

With JSONStore, you can create multiple stores that contain different collections in a single MobileFirst application.

The `open` (Native iOS) API can take an options object with a user name. Different stores are separate files in the file system. The user name is used as the file name of the store. These separate stores can be encrypted with different passwords for security and privacy reasons. Calling the `closeAll` API removes access to all the collections. It is also possible to change the password of an encrypted store by calling the `changePassword` API.

An example use case would be various employees that share a physical device (for example an iPad) and MobileFirst application. In addition, if the employees work different shifts and handle private data from different customers while they use the MobileFirst application, multiple user support is useful.

### **JSONStore performance**

Learn about the factors that can affect JSONStore performance.

#### **Network**

- Ideally, getting and sending data from and to a MobileFirst adapter should be done when the application is using a WiFi network.
- Check network connectivity before you perform operations, such as sending all dirty documents to a MobileFirst adapter.
- The amount of data that is sent over the network to a client heavily affects performance. Send only the data that is required by the application, instead of copying everything inside your backend database.

- If you are using a MobileFirst adapter, consider setting the `compressResponse` flag to `true`. That way, responses are compressed, which generally uses less bandwidth and has a faster transfer time than without compression.

## Memory

- One way to mitigate possible memory issues is by using `limit` and `offset` when you use the `find` API. That way, you limit the amount of memory that is allocated for the results and can implement things like pagination (show `X` number of results per page).
- Instead of using long key names that are eventually serialized and deserialized as `Strings`, consider mapping those long key names into smaller ones (for example: `myVeryVeryVerLongKeyName` to `k` or `key`). Ideally, you map them to short key names when you send them from the adapter to the client, and map them to the original long key names when you send data back to the backend.
- Consider splitting the data inside a store into various collections. Have small documents over various collections instead of monolithic documents in a single collection. This consideration depends on how closely related the data is and the use cases for said data.
- When you use the `add` API with an array of objects, it is possible to run into memory issues. To mitigate this issue, call these methods with fewer `JSON` objects at a time.
- Allow Automatic Reference Counting to work, but do not depend on it entirely.

## CPU

- The amount of search fields and extra search fields that are used affect performance when you call the `add` method, which does the indexing. Only index the values that are used in queries for the `find` method.
- By default, `JSONStore` tracks local changes to its documents. This behavior can be disabled, thus saving a few cycles, by setting the `markDirty` flag to `false` when you use the `add`, `remove`, and `replace` APIs.
- Enabling security adds some overhead to the open APIs and other operations that work with documents inside the collection. Consider whether security is genuinely required. For example, the open API is much slower with encryption because it must generate the encryption keys that are used for encryption and decryption.
- The `replace` and `remove` APIs depend on the collection size as they must go through the whole collection to replace or remove all occurrences. Because it must go through each record, it must decrypt every one of them, which makes it much slower when encryption is used. This performance hit is more noticeable on large collections.
- The `count` API is relatively expensive. However, you can keep a variable that keeps the count for that collection. Update it every time that you store or remove things from the collection.
- The `find` APIs (`find`, `findAll`, and `findById`) are affected by encryption, since they must decrypt every document to see whether it is a match or not. For `find` by query, if a limit is passed, it is potentially faster as it stops when it reaches the limit of results. `JSONStore` does not need to decrypt the rest of the documents to figure out if any other search results remain.

## More information

For more information about `JSONStore` performance, see the `JSONStore` performance blog post.

## JSONStore concurrency

Learn about JSONStore concurrency.

### Objective-C

When you use the Native iOS API for JSONStore, all operations are added to a synchronous dispatch queue. This behavior ensures that operations that touch the store are executed in order on a thread that is not the main thread. For more information, see the Apple documentation at Grand Central Dispatch (GCD).

### Work with external data

Learn about the different concepts that are required to work with external data.

For the actual API examples, see “JSONStore examples” on page 8-174.

### Pull

Many systems use the term *pull* to refer to getting data from an external source.

There are three important pieces:

#### External Data Source

This source can be a database, a REST or SOAP API, or many others. The only requirement is that it must be accessible from either the MobileFirst Server or directly from the client application. Ideally, you want this source to return data in JSON format.

#### Transport Layer

This source is how you get data from the external source into your internal source, a JSONStore collection inside the store. One alternative is a MobileFirst adapter.

#### Internal Data Source API

This source is the JSONStore APIs that you can use to add JSON data to a collection.

**Note:** You can populate the internal store with data that is read from a file, an input field, or hardcoded data in a variable. It does not have to come exclusively from an external source that requires network communication.

### Push

Many systems use the term *push* to refer to sending data to an external source.

There are three important pieces:

#### Internal Data Source API

This source is the JSONStore API that returns documents with local-only changes (dirty).

#### Transport Layer

This source is how you want to contact the external data source to send the changes.

#### External Data Source

This source is typically a database, REST or SOAP endpoint, among others, that receives the updates that the client made to the data.

## Example push scenario

All of the following code examples are written in pseudocode that looks similar to JavaScript.

**Note:** Use MobileFirst adapters for the Transport Layer. Some of the advantages of using MobileFirst adapters are XML to JSON, security, filtering, and decoupling of server-side code and client-side code.

### Internal Data Source API: JSONStore

After you have an accessor to the collection, you can call the `getAllDirty` API to get all documents that are marked as dirty. These documents have local-only changes that you want to send to the external data source through a transport layer.

```
var accessor = WL.JSONStore.get('people');

accessor.getAllDirty()

.then(function (dirtyDocs) {
 // ...
});
```

The `dirtyDocs` argument looks like the following example:

```
[{_id: 1,
 json: {id: 1, ssn: '111-22-3333', name: 'Carlos'},
 _operation: 'add',
 _dirty: '1395774961,12902'}]
```

The fields are:

#### **`_id`**

Internal field that JSONStore uses. Every document is assigned a unique one.

#### **`json`**

The data that was stored.

#### **`_operation`**

The last operation that was performed on the document. Possible values are add, store, replace, and remove.

#### **`_dirty`**

A time stamp that is stored as a number to represent when the document was marked dirty.

### Transport Layer: MobileFirst adapter

You can choose to send dirty documents to a MobileFirst adapter. Assume that you have a `people` adapter that is defined with an `updatePeople` procedure.

```
.then(function (dirtyDocs) {

 return WL.Client.invokeProcedure({
 adapter : 'people',
 procedure : 'updatePeople',
 parameters : [dirtyDocs]
 });
})

.then(function (responseFromAdapter) {
 // ...
})
```



**Note:** You might want to take advantage of the `compressResponse`, `timeout`, and other parameters that can be passed to the `invokeProcedure` API. On the MobileFirst Server, the adapter has the `updatePeople` procedure, which might look like the following example:

```
function updatePeople (dirtyDocs) {

 var input = {
 method : 'post',
 path : '/people',
 body: {
 contentType : 'application/json',
 content : JSON.stringify(dirtyDocs)
 }
 };

 return WL.Server.invokeHttp(input);
}
```

Instead of relaying the output from the `getAllDirty` API on the client, you might have to update the payload to match a format that is expected by the backend. You might have to split the replacements, removals, and inclusions into separate backend API calls.

Alternatively, you can iterate over the `dirtyDocs` array and check the `_operation` field. Then, send replacements to one procedure, removals to another procedure, and inclusions to another procedure. The previous example sends all dirty documents in bulk to the MobileFirst adapter.

```
var len = dirtyDocs.length;
var arrayOfPromises = [];

while (len-- > 0) {

 var currentDirtyDoc = dirtyDocs[len];

 switch (currentDirtyDoc._operation) {

 case 'add':
 case 'store':

 arrayOfPromises.push(WL.Client.invokeProcedure({
 adapter : 'people',
 procedure : 'addPerson',
 parameters : [currentDirtyDoc]
 }));

 break;

 case 'replace':
 case 'refresh':

 arrayOfPromises.push(WL.Client.invokeProcedure({
 adapter : 'people',
 procedure : 'replacePerson',
 parameters : [currentDirtyDoc]
 }));

 break;

 case 'remove':
 case 'erase':

 arrayOfPromises.push(WL.Client.invokeProcedure({
 adapter : 'people',
 procedure : 'removePerson',
```

```

 parameters : [currentDirtyDoc]
 }));
}
}

$.when.apply(this, arrayOfPromises)
 .then(function () {
 var len = arguments.length;

 while (len-- > 0) {
 // Look at the responses in arguments[len]
 }
 });

```

Alternatively, you can skip the MobileFirst adapter and contact the REST endpoint directly.

```

 .then(function (dirtyDocs) {

 return $.ajax({
 type: 'POST',
 url: 'http://example.org/updatePeople',
 data: dirtyDocs
 });
 })

 .then(function (responseFromEndpoint) {
 // ...
 });

```

### External Data Source: Backend REST endpoint

The backend accepts or rejects changes, and then relays a response back to the client. After the client looks at the response, it can pass documents that were updated to the markClean API.

```

 .then(function (responseFromAdapter) {

 if (responseFromAdapter.isSuccessful) {
 WL.JSONStore.get('people').markClean(dirtyDocs);
 }
 })

 .then(function () {
 // ...
 })

```

After documents are marked as clean, they do not show up in the output from the getAllDirty API.

## JSONStore security utilities

Learn about JSONStore security utilities.

### JSONStore security utilities overview

The MobileFirst client-side API provides some security utilities to help protect your user's data. Features like JSONStore are great if you want to protect JSON objects. However, it is not recommended to store binary blobs in a JSONStore collection.

Instead, store binary data on the file system, and store the file paths and other metadata inside a JSONStore collection. If you want to protect files like images, you can encode them as base64 strings, encrypt it, and write the output to disk. When it is time to decrypt the data, you can look up the metadata in a JSONStore collection, read the encrypted data from the disk, and decrypt it using the metadata that was stored. This metadata can include the key, salt, Initialization Vector (IV), type of file, path to the file, and others.

At a high level, the SecurityUtils API provides the following APIs:

- Key generation - Instead of passing a password directly to the encryption function, this key generation function uses Password Based Key Derivation Function v2 (PBKDF2) to generate a strong 256-bit key for the encryption API. It takes a parameter for the number of iterations. The higher the number, the more time it takes an attacker to brute force your key. Use a value of at least 10,000. The salt must be unique and it helps ensure that attackers have a harder time using existing hash information to attack your password. Use a length of 32 bytes.
- Encryption - Input is encrypted by using the Advanced Encryption Standard (AES). The API takes a key that is generated with the key generation API. Internally, it generates a secure IV, which is used to add randomization to the first block cipher. Text is encrypted. If you want to encrypt an image or other binary format, turn your binary into base64 text by using these APIs. This encryption function returns an object with the following parts:
  - ct (cipher text, which is also called the encrypted text)
  - IV
  - v (version, which allows the API to evolve while still being compatible with an earlier version)
- Decryption - Takes the output from the encryption API as input, and decrypts the cipher or encrypted text into plain text.
- Remote random string - Gets a random hex string by contacting a random generator on the MobileFirst Server. The default value is 20 bytes, but you can change the number up to 64 bytes.
- Local random string - Gets a random hex string by generating one locally, unlike the remote random string API, which requires network access. The default value is 32 bytes and there is not a maximum value. The operation time is proportional to the number of bytes.
- Encode base64 - Takes a string and applies base64 encoding. Incurring a base64 encoding by the nature of the algorithm means that the size of the data is increased by approximately 1.37 times the original size.
- Decode base64 - Takes a base64 encoded string and applies base64 decoding.

## JSONStore security utilities setup

Ensure that you import the following files to use the JSONStore security utilities APIs.

### iOS

```
#import "WLSecurityUtils.h"
```

## JSONStore security utilities examples

Learn about JSONStore security utilities examples.

### JSONStore security utilities iOS examples:

Learn about JSONStore security utilities iOS examples.

## Encryption and decryption

```
// User provided password, hardcoded only for simplicity.
NSString* password = @"HelloPassword";

// Random salt with recommended length.
NSString* salt = [WLSecurityUtils generateRandomStringWithBytes:32];

// Recommended number of iterations.
int iterations = 10000;
```

```

// Populated with an error if one occurs.
NSError* error = nil;

// Call that generates the key.
NSString* key = [WLSecurityUtils generateKeyWithPassword:password
 andSalt:salt
 andIterations:iterations
 error:&error];

// Text that is encrypted.
NSString* originalString = @"My secret text";
NSDictionary* dict = [WLSecurityUtils encryptText:originalString
 withKey:key
 error:&error];

// Should return: 'My secret text'.
NSString* decryptedString = [WLSecurityUtils decryptWithKey:key
 andDictionary:dict
 error:&error];

```

### Encode and decode base64

```

// Input string.
NSString* originalString = @"Hello world!";

// Encode to base64.
NSData* originalStringData = [originalString dataUsingEncoding:NSUTF8StringEncoding];
NSString* encodedString = [WLSecurityUtils base64StringFromData:originalStringData length:originalString.length];

// Should return: 'Hello world!'.
NSString* decodedString = [[NSString alloc] initWithData:[WLSecurityUtils base64DataFromString:encodedString] encoding:NSUTF8StringEncoding];

```

### Get remote random

```

[WLSecurityUtils getRandomStringFromServerWithBytes:32
 timeout:1000
 completionHandler:^(NSURLResponse *response, NSData *data, NSError *connectionError) {

// You might want to see the response and the connection error before moving forward.

// Get the secure random string.
NSString* secureRandom = [[NSString alloc] initWithData:data encoding:NSUTF8StringEncoding];
}];

```

### Get local random

```

NSString* secureRandom = [WLSecurityUtils generateRandomStringWithBytes:32];

```

---

## Storing mobile data in Cloudant

You can store data for your mobile application in a Cloudant database, which is an advanced NoSQL database that is capable of handling a wide variety of data types, such as JSON, full-text, and geospatial data. The SDK is available for Objective-C.

### Cloudant benefits

#### Rapidly develop apps with a simple programming model

Use native iOS mobile APIs for offline synchronization, queries, and secure integration.

#### Manage data anywhere, any time

Store data for the users of your app directly on their devices for offline use. When their device comes online, replication can synchronize the database from the local copy to the remote and local copies of the user's data.

#### Securely store and retrieve enterprise data

Use access controls to create public and private databases. You can restrict access to a single user or you can provide shared access.

#### Scale horizontally and geographically

Cloudant scales to provide highly available data. Data is automatically partitioned, clustered, and replicated.

## Options for using Cloudant

The MobileFirst Cloudant extensions are available if you are developing a native iOS application in Swift or Objective-C.

With the SDK, you can store data for your mobile application locally on the device and remotely in any Cloudant environment. The available options for a Cloudant environment follow:

- IBM MobileFirst Platform Cloudant Data Layer Local Edition installation (single node included)
- Cloudant.com database instance (separate charging and licensing)
- Cloudant NoSQL DB service on IBM Bluemix (separate charging and licensing)
- Cloudant Data Layer Local Edition installation (separate charging and licensing)

## SDK options

Use the Cloudant Toolkit and IMFData SDKs in your mobile application to access data in the Cloudant database.

### Basic approach:Cloudant Toolkit SDK

With the basic approach, data access is directly to the Cloudant database on cloudant.com. This database can either be without a security configuration, or you can configure an API key.

The core functionality for working with Cloudant is in the Cloudant Toolkit and its associated dependencies:

#### Cloudant Toolkit core functions

##### CloudantToolkit.framework

Dependencies: CDTDatastore, CloudantQueryObjc

With the Cloudant Toolkit SDK, you can perform the following data functions:

- Store native objects or document revisions.
- Store to both a remote database or to the device with the same APIs.
- Query data for local and remote databases.
- Replicate data between the local device and remote database for offline access with Cloudant Sync.

### Advanced approach: IMFData SDK

If you want to add more security to your mobile app, use the advanced approach. In this scenario, you use the IMFData SDK and access is controlled by the MobileFirst Data Proxy. The security is integrated with the OAuth security capabilities in MobileFirst.

#### IMFData functions

##### IMFData.framework

Dependencies: CloudantSync.h,IMFData/IMFData.h,CloudantToolkit/CloudantToolkit.h

For more information about setting up the IMFData SDK in your development environment, see “Obtaining the IMFData SDK” on page 8-190.

Your code interacts with the authorization manager to obtain an OAuth token. This token represents the mobile user that is interacting with Cloudant. For more information, see “Configuring access to Cloudant.”

The Apache CouchDB security model is used, but the implementation is handled by the SDK.

## Cloudant versus JSONStore

You might consider using JSONStore instead of Cloudant in the following scenarios:

- When you are storing data on the mobile device that needs to be encrypted.
- When you need to synchronize data between the device and the enterprise.
- When you are developing a hybrid application.

For more information about JSONStore, see “JSONStore” on page 8-161.

## Configuring access to Cloudant

You can access Cloudant directly, or you can access Cloudant through the MobileFirst Data Proxy that is integrated with the OAuth security capabilities in MobileFirst.

### About this task

Consider your options for security on your Cloudant database:

#### Public database - no security

If you are using a Cloudant database on cloudant.com, you can set up a public database with no security in the Cloudant dashboard. You can then use the APIs in the Cloudant Toolkit SDK in your mobile application.

#### Quick security setup

If you are using a Cloudant database on cloudant.com, you can set up security with an API key. You can then use the Cloudant dashboard or APIs in the Cloudant Toolkit SDK to configure permissions. For more information, see “Configuring API keys.”

#### OAuth integration

For OAuth integration, you must first set up the MobileFirst Data Proxy. To use OAuth integration, you must use the IMFData SDK. For more information, see “Configuring OAuth security” on page 8-189.

## Configuring API keys

Set up direct access to the Cloudant database on cloudant.com with an API key.

### Procedure

1. Set up an API key.

To start developing with Cloudant directly, you must have appropriate credentials. In development, you might use your Cloudant account user or Cloudant Local admin user and password. However, setting up an API key is preferred.

In the Cloudant dashboard, configure an API key and password. You can then grant the appropriate permissions to the database that you are using in your application. For more information, see Cloudant documentation: Authentication and authorization.

2. Initialize a Cloudant remote database by embedding the API Key and password in the URL for the remote database.

Remote URL database example for Cloudant:

```
https://<apikey>:<password>@myaccount.cloudant.com/<database>
```

Remote URL database example for MobileFirst Platform Cloudant Local:

```
http://<apikey>:<password>@mycloudantlocal.mycompany.com/<database>
```

This URL is referred to as the *CLOUDANT\_PROXY\_URL* when you initialize the IMFData SDK.

## Configuring OAuth security

Set up access with the OAuth capabilities and MobileFirst Data Proxy.

### Before you begin

Install the MobileFirst Data Proxy. For more information, see “Installing and configuring the MobileFirst Data Proxy” on page 6-153.

### About this task

The MobileFirst Data Proxy is protected by the trust association interceptor (TAI). All requests to the proxy require an OAuth token with a grant scope of cloudant and an associated user identity.

### Procedure

1. Obtain an OAuth token.

Add an authentication adapter to your MobileFirst project. For more information, see Adapter-based authentication.

The realm for the adapter must either define the realm name as cloudant or define a grantScope of cloudant.

```
<realm name="cloudant" loginModule="myUserAuthLoginModule">
 <className>com.worklight.core.auth.ext.AdapterAuthenticator</className>
</realm>
<realm name="myUserAuthRealm" loginModule="myUserAuthLoginModule">
 <className>com.worklight.core.auth.ext.AdapterAuthenticator</className>
 <parameter name="grantScope" value="cloudant"/>
</realm>
```

If you already have a custom identity realm, you can also create a cloudant realm that duplicates the existing definition and reuses the same authenticator:

```
<realms>
 <realm loginModule="CustomAuthLoginModule" name="cloudant">
 <className>com.worklight.integration.auth.AdapterAuthenticator</className>
 <parameter name="login-function" value="CustomAuthAdapter.onAuthRequired"/>
 <parameter name="logout-function" value="CustomAuthAdapter.onLogout"/>
 </realm>

 <realm loginModule="CustomAuthLoginModule" name="customIdentityRealm">
 <className>com.worklight.integration.auth.AdapterAuthenticator</className>
 <parameter name="login-function" value="CustomAuthAdapter.onAuthRequired"/>
 <parameter name="logout-function" value="CustomAuthAdapter.onLogout"/>
 </realm>
</realms>

<loginModules>
 <loginModule name="CustomAuthLoginModule">
 <className>com.worklight.core.auth.ext.NonValidatingLoginModule</className>
 </loginModules>
```

2. Define and register a challenge handler that handles challenges to obtain the cloudant scope. See the client-side examples that are described in the following information: Adapter-based authentication.
3. To use the MobileFirst Data Proxy for security protection, you must use the IMFData SDK.

For more information, see “Obtaining the IMFData SDK.”

When you initialize the IMFData SDK, you provide the URL of the MobileFirst Data Proxy.

The databases that you create with the IMFDataManager API are primed with the proxy URL. You can obtain an OAuth token with the cloudant scope through coordination with the MobileFirst native authorization manager. This token is then propagated on all requests to the MobileFirst Data Proxy.

## Results

For more information about setting up and initializing the IMFData SDK, see “Obtaining the IMFData SDK.”

## Obtaining the IMFData SDK

To use the MobileFirst Cloudant extensions in your native mobile app, you must set up the SDK in your iOS development environment.

### Before you begin

You must have the URL of the Cloudant instance to which you are connecting. This value is referred to as *CLOUDANT\_PROXY\_URL*. For more information, see “Configuring access to Cloudant” on page 8-188.

### Procedure

Pull the most recent frameworks with CocoaPods to add the SDK to your application. An example Podfile is in the default MobileFirst Platform project template.

1. Install CocoaPods with the following command in Terminal:

```
$ sudo gem install cocoapods
```

2. Enter the following command in Terminal to complete the setup of CocoaPods:

```
$ pod setup
```

3. Create a file that is called Podfile in your Xcode project folder. In that file, list the SDK dependencies that you need. An example Podfile follows:

```
source 'https://github.com/CocoaPods/Specs.git'
platform :ios, '7.0'
pod 'IMFDataLocal', '1.0.0'
pod 'CloudantToolkitLocal', '1.0.0'
```

This file is also in the default MobileFirst Platform project template in the *iOS-Cloudant-Data-Layer-SDK-Podfile* file.

4. Go to your project folder and install the dependencies with the following command:



```
$ pod install
```

That command installs your dependencies and creates a new Xcode workspace.

**Important:** Ensure that you always open the new Xcode workspace, instead of the original Xcode project file.

5. Add the import statement to your app.

Include the import statement in the relevant classes of your app. For a Swift application, include the imports in your bridging header.

```
#import <CloudantToolkit/CloudantToolkit.h>
#import <CloudantSync.h>
#import <IMFData/IMFData.h>
```

6. Initialize the SDK.

```
// Initialize the IMFDataManager
IMFDataManager *manager = [IMFDataManager initializeWithUrl:CLLOUDANT_PROXY_URL];
// Initialize the IMFDataManager
let manager:IMFDataManager = IMFDataManager.initializeWithUrl(CLOUDANT_PROXY_URL)
```

To determine the value for *CLLOUDANT\_PROXY\_URL*:

- If you are using a Cloudant database on cloudant.com, use the URL of your Cloudant instance.
- If you are using MobileFirst Data Proxy, the URL of the proxy is configured during installation. The URL includes the context root that you defined, and is */imf-data-proxy* by default. For more information, see “Ant tasks for installation of MobileFirst Data Proxy” on page 14-27

## What to do next

After you initialize the data manager, you can start using data functions in your app. A good place to start is at “Creating databases.”

## Creating databases

Store a local copy of data on the client device and persist the data to Cloudant periodically.

### About this task

With the data manager APIs, you can create data objects that are pre-configured to work with Cloudant.

### Accessing local data stores

You can use a local data store to store data on the client device for fast access, even when offline.

### Procedure

To create Store objects to access a local database, supply a name for the data store.

**Important:** The database name must be in lower case.

```
//Get reference to data manager
IMFDataManager *manager = [IMFDataManager sharedInstance];
NSString *name = @"automobiledb";
NSError *error = nil;
```

```

//Create local store
CDTStore *store = [manager localStore:name error:&error];
//Get reference to data manager
let manager = IMFDataManager.sharedInstance()
let name = "automobiledb"

var error:NSError?
var store:CDTStore? = manager.localStore(name, error: &error)

```

## Creating remote data stores

### Procedure

To create remote Store objects, supply the data store name.

```

// Get reference to data manager
IMFDataManager *manager = [IMFDataManager sharedInstance];
NSString *name = @"automobiledb";

// Create remote store
[manager remoteStore:name completionHandler:^(CDTStore *createdStore, NSError *error) {
 if(error){
 // Handle error
 }else{
 CDTStore *store = createdStore;
 NSLog(@"Successfully created store: %@", store.name);
 }
}];

//Get reference to data manager
let manager = IMFDataManager.sharedInstance()
let name = "automobiledb"

// Create remote store
manager.remoteStore(name, completionHandler: { (createdStore:CDTStore!, error:NSError!) -> Void in
 if nil != error {
 //Handle error
 } else {
 var store:CDTStore = createdStore
 println("Successfully created store: \(store.name)")
 }
})

```

### What to do next

If you configured both a local and remote data store, use replication to synchronize the data between the device and Cloudant. For more information, see “Supporting offline storage and synchronization” on page 8-201.

## Setting user permissions

You can set user permissions on remote databases.

### About this task

If you are using OAuth authentication, you can set user permissions on a remote store with the data manager API. The user must be authenticated with IBM MobileFirst Platform. For more information, see “Configuring OAuth security” on page 8-189.

## Procedure

Set user permissions on the remote store.

```
// Get reference to data manager
IMFDataManager *manager = [IMFDataManager sharedInstance];

// Set permissions for current user on a store
[manager setCurrentUserPermissions: DB_ACCESS_GROUP_MEMBERS forStoreName: @"automobiledb" completionHandler:^(BOOL success, NSError *error) {
 if(error){
 // Handle error
 }else{
 // setting permissions was successful
 }
}];

// Get reference to data manager
let manager = IMFDataManager.sharedInstance()

// Set permissions for current user on a store
manager.setCurrentUserPermissions(DB_ACCESS_GROUP_ADMINS, forStoreName: name) { (success:Bool, error:NSError!) -> Void in
 if nil != error {
 // Handle error
 } else {
 // setting permissions was successful
 }
}
```

## Modeling data

Cloudant stores data as JSON documents. To store data as objects in your application, use the included data object mapper class that maps native objects to the underlying JSON document format.

### About this task

The data object mapper serializes top-level properties on native objects that have number, string, date, or primitive types. If you want to add serialization for a property with an unsupported data type, you can create a custom property serializer.

See the following sections for more information:

- “Modeling data for iOS apps”
- “Creating custom property serializers for iOS apps” on page 8-195

If the included data mapper does not provide all the required features for your application, you can configure the store to use a custom class that conforms to the object mapper protocol.

### Modeling data for iOS apps

In iOS apps, the `CDTDataObjectMapper` class maps native objects to the underlying JSON document format. When you create your data store with the IMFDataManager API, a `CDTDataObjectMapper` is created automatically and is set on the `CDTStore` object.

### About this task

The `CDTDataObjectMapper` class mapping includes top level properties of the following types: `NSNumber`, `NSString`, `NSDate`, and all primitive types.

## Procedure

1. Create a class that supports the requirements of the `CDTDataObjectMapper` class. The `CDTDataObjectMapper` class supports native objects that meet the following requirements:

- Conform to the `IMFDataObject` protocol.
- Have the `IMFDataObject` protocol metadata property set on the class interface.
- Extend `NSObject`.

The following `Automobile` class meets all the requirements. This class includes the properties of any automobile, such as the manufactured year, make and model and owner.

```
@interface Automobile : NSObject<CDTDataObject>

@property (strong, nonatomic, readwrite) CDTDataObjectMetadata *metadata;

@property NSInteger year;
@property NSString *model;
@property NSString *make;
@property Person *owner;

-(instancetype) initWithMake: (NSString*) make model: (NSString*) model year: (NSInteger) year;

@end
~~~

class Automobile: NSObject, CDTDataObject {

    //Required by the IMFDataObject protocol
    var metadata:CDTDataObjectMetadata?

    var year:Int
    var model:NSString
    var make:NSString
    var owner:Person?

    init(make:String, model:String, year:Int) {
        self.year = year
        self.model = model
        self.make = make
    }

    override convenience init() {
        self.init(make:"", model:"",year:0)
    }
}

2. Register the class and data type with the CDTDataObjectMapper.

// Using an existing store
CDTStore *store = existingStore;

[store.mapper setDataType:@"Automobile" forClassName:NSStringFromClass([Automobile class])];

// Use an existing store
let store:CDTStore = existingStore

store.mapper.setDataType("Automobile", forClassName: NSStringFromClass(Automobile.classForCoder()))
```

## Results

CRUD operations that are run against the `CDTStore` class can use `NSObject` objects.

## Creating custom property serializers for iOS apps

The `CDTDataObjectMapper` serializes only top-level properties on an object that have the data type `NSNumber`, `NSString`, `NSDate`, or primitive types. If you want to add serialization for a property with an unsupported data type, you can create a custom property serializer.

### Procedure

1. Implement a class that conforms to the `CDTPropertySerializer` protocol.

The `CDTPropertySerializer` protocol provides the methods that are required to convert between JSON values and native property values. The return value of the `propertyValueToJSONValue` method must be a valid JSON object, according to Objective-C standards. The `Automobile` class has a property of type `Person`. The `Person` class is not a supported type for the `CDTDataObjectMapper` class. The `CDTDataObjectMapper` class skips the `owner` property in the `Automobile` class. The interface for the `Person` class follows:

```
@interface Person : NSObject

@property NSString *firstName;
@property NSString *lastName;

@end

class Person: NSObject {

    var firstName:NSString = ""
    var lastName:NSString = ""

}
```

To serialize the `owner` property of the `Automobile` class, add a `CDTPropertySerializer` class to the `CDTDataObjectMapper`. The following code snippet implements a custom serializer for `Person` objects. The `PersonSerializer` conforms to the `CDTPropertySerializer` protocol.

```
@interface PersonSerializer : NSObject<CDTPropertySerializer>

@end

@implementation PersonSerializer

-(id) propertyValueToJSONValue: (id) propertyValue error: (NSError**) error
{
    if(propertyValue && [propertyValue isKindOfClass:[Person class]]){
        Person *person = (Person*)propertyValue;

        NSMutableDictionary *personMap = [NSMutableDictionary dictionary];
        [personMap setObject:person.firstName forKey:@"firstName"];
        [personMap setObject:person.lastName forKey:@"lastName"];
        return personMap;
    }else{
        return nil;
    }
}

-(id) jsonValueToPropertyValue: (id) jsonValue error: (NSError**) error
{
    if(jsonValue && [jsonValue isKindOfClass:[NSDictionary class]]){
        NSDictionary *personMap = (NSDictionary*)jsonValue;

        Person *person = [[Person alloc] init];
        person.firstName = [personMap objectForKey:@"firstName"];
        person.lastName = [personMap objectForKey:@"lastName"];
        return person;
    }else{

```

```

        return nil;
    }
}

@end

class PersonSerializer: NSObject, CDTPropertySerializer {
    func propertyValueToJSONValue(propertyValue: AnyObject!, error: NSErrorPointer) -> AnyObject! {
        if let person = propertyValue as? Person {
            var personMap = ["firstName":person.firstName, "lastName":person.lastName]
            return personMap
        } else {
            return nil
        }
    }

    func jsonValueToPropertyValue(jsonValue: AnyObject!, error: NSErrorPointer) -> AnyObject! {
        if let personMap = jsonValue as? NSDictionary {
            var person:Person = Person()
            person.firstName = personMap["firstName"] as! NSString
            person.lastName = personMap["lastName"] as! NSString

            return person
        } else {
            return nil
        }
    }
}

```

2. Add the PersonSerializer class to the custom property serializers for the CDTDataObjectMapper class.

```

// Using an existing store
CDTStore *store = existingStore;

// The ObjectMapper must be a DataObjectMapper instance or a subclass
CDTDataObjectMapper *mapper = (CDTDataObjectMapper*) store.mapper;
[mapper setPropertySerializer: [[PersonSerializer alloc] init] forClassName:NSStringFromClass([Person class])
withDataType:@"Person"];

// Using an existing store
let store:CDTStore = existingStore

// The ObjectMapper must be a DataObjectMapper instance or a subclass
var mapper:CDTDataObjectMapper = store.mapper as! CDTDataObjectMapper
mapper.setPropertySerializer(PersonSerializer(), forClassName: NSStringFromClass(Person.classForCoder()),
withDataType: "Person")

```

## Performing CRUD operations

You can modify the content of a data store.

### About this task

You can save, delete, and fetch objects from the data store. To create a persisted object, an object mapper must be set and the data type must be registered. All code snippets that use the Automobile class must first register the data type with the object mapper. For more information, see “Modeling data” on page 8-193.

### Creating data

You can save new objects and save changes to existing objects. Use the same operation for both new and existing objects.

### Procedure

Save an object.

```

// Use an existing store
CDTStore *store = existingStore;

// Create your Automobile to save
Automobile *automobile = [[Automobile alloc] initWithMake:@"Toyota" model:@"Corolla" year: 2006];

[store save:automobile completionHandler:^(id savedObject, NSError *error) {
    if (error) {
        // save was not successful, handler received an error
    } else {
        // use the result
        Automobile *savedAutomobile = savedObject;
        NSLog(@"saved revision: %@", savedAutomobile);
    }
}];

// Use an existing store
let store:CDTStore = existingStore

// Create your object to save
let automobile = Automobile(make: "Toyota", model: "Corolla", year: 2006)

store.save(automobile, completionHandler: { (savedObject:AnyObject!, error:NSError!) -> Void in
    if nil != error {
        //Save was not successful, handler received an error
    } else {
        // Use the result
        println("Saved revision: \(savedObject)")
    }
})

```

## Reading data

You can fetch an object.

## Procedure

Read objects.

```

CDTStore *store = existingStore;
NSString *automobileId = existingAutomobileId;

// Fetch Automobile from Store
[store fetchById:automobileId completionHandler:^(id object, NSError *error) {
    if (error) {
        // fetch was not successful, handler received an error
    } else {
        // use the result
        Automobile *savedAutomobile = object;
        NSLog(@"fetched automobile: %@", savedAutomobile);
    }
}];

// Using an existing store and Automobile
let store:CDTStore = existingStore
let automobileId:String = existingAutomobileId

// Fetch Automobile from Store
store.fetchById(automobileId, completionHandler: { (object:AnyObject!, error:NSError!) -> Void in
    if nil != error {
        // Fetch was not successful, handler received an error
    } else {
        // Use the result
        var savedAutomobile:Automobile = object as! Automobile
        println("Fetched automobile: \(savedAutomobile)")
    }
})

```

## Updating data

To update an object, run a save on an existing object. Because the item already exists, it is updated.

### Procedure

Update objects.

```
// Use an existing store and Automobile
CDTStore *store = existingStore;
Automobile *automobile = existingAutomobile;

// Update some of the values in the Automobile
automobile.year = 2015;

// Save Automobile to the store
[store save:automobile completionHandler:^(id savedObject, NSError *error) {
    if (error) {
        // save was not successful, handler received an error
    } else {
        // use the result
        Automobile *savedAutomobile = savedObject;
        NSLog(@"saved automobile: %@", savedAutomobile);
    }
}];

// Use an existing store and Automobile
let store:CDTStore = existingStore
let automobile:Automobile = existingAutomobile

// Update some of the values in the Automobile
automobile.year = 2015

// Save Automobile to the store
store.save(automobile, completionHandler: { (savedObject:AnyObject!, error:NSError!) -> Void in
    if nil != error {
        // Update was not successful, handler received an error
    } else {
        // Use the result
        let savedAutomobile:Automobile = savedObject as! Automobile
        println("Updated automobile: \(savedAutomobile)")
    }
}
```

## Deleting data

To delete an object, pass the object to the - delete:completionHandler method.

### Procedure

Delete objects. To delete an object, pass the object that you want to delete to the store.

```
// Using an existing store and Automobile
CDTStore *store = existingStore;
Automobile *automobile = existingAutomobile;

// Delete the Automobile object from the store
[store delete:automobile completionHandler:^(NSString *deletedObjectId, NSString *deletedRevisionId, NSError *error) {
    if (error) {
        // delete was not successful, handler received an error
    } else {
        // use the result
        NSLog(@"deleted Automobile doc-%@-rev-%@", deletedObjectId, deletedRevisionId);
    }
}];
```



```

// Using an existing store and Automobile
let store:CDTStore = existingStore
let automobile:Automobile = existingAutomobile

// Delete the Automobile object
store.delete(automobile, completionHandler: { (deletedObjectId:String!, deletedRevisionId:String!, error:NSError
-> Void in
    if nil != error {
        // delete was not successful, handler received an error
    } else {
        // use the result
        println("deleted document doc-\(deletedObjectId)-rev-\(deletedRevisionId)")
    }
})
})

```

## Creating indexes

To perform queries, you must create an index.

### About this task

You can create indexes for local and remote data stores with the same methods.

### Procedure

- Create an index that includes the data type. Indexing with the data type is useful when an object mapper is set on the data store.

```

// Use an existing store
CDTStore *store = existingStore;

// The data type to use for the Automobile class
NSString *dataType = [store.mapper dataTypeForClassName:NSStringFromClass([Automobile class])];

// Create the index
[store createIndexWithDataType:dataType fields:@[@"year", @"make"] completionHandler:^(NSError *error) {
    if(error){
        // Handle error
    }else{
        // Continue application flow
    }
}];

// A store that has been previously created.
let store:CDTStore = existingStore

// The data type to use for the Automobile class
let dataType:String = store.mapper.dataTypeForClassName(NSStringFromClass(Automobile.classForCoder()))

// Create the index
store.createIndexWithDataType(dataType, fields: ["year","make"]) { (error:NSError!) -> Void in
    if nil != error {
        // Handle error
    } else {
        // Continue application flow
    }
}

```

- Delete indexes.

```

// Use an existing store
CDTStore *store = existingStore;
NSString *indexName = existingIndexName;

// Delete the index
[store deleteIndexWithName:indexName completionHandler:^(NSError *error) {
    if(error){
        // Handle error
    }
}];

```

```

    }else{
        // Continue application flow
    }
}];
// Use an existing store
let store:CDTStore = existingStore
let indexName:String = existingIndexName

// Delete the index
store.deleteIndexWithName(indexName, completionHandler: { (error:NSError!) -> Void in
    if nil != error {
        // Handle error
    } else {
        // Continue application flow
    }
})

```

- Delete a data type index:

```

// Use an existing store
CDTStore *store = existingStore;

// The data type to use for the Automobile class
NSString *dataType = [store.mapper dataTypeForClassName:[NSStringFromClass([Automobile class])]];

// Delete the index
[store deleteIndexWithDataType:dataType completionHandler:^(NSError *error) {
    if(error){
        // Handle error
    }else{
        // Continue application flow
    }
}];

// Use an existing store
let store:CDTStore = existingStore

// The data type to use for the Automobile class
let dataType:String = store.mapper.dataTypeForClassName(NSStringFromClass(Automobile.classForCoder()))

// Delete the index
store.deleteIndexWithDataType(dataType, completionHandler: { (error:NSError!) -> Void in
    if nil != error {
        // Handle error
    } else {
        // Continue application flow
    }
})

```

## Querying data

You can query for objects that have an object mapper.

### Before you begin

The Cloudant Toolkit SDK includes a default object mapper. For more information, see “Modeling data” on page 8-193.

### Procedure

Create and run a query.

The Cloudant query API provides convenience methods for querying with NSPredicate and for querying by data type.

Create an NSPredicate with the query predicate and then run the query against a CDTStore object.

```

// Use an existing store
CDTStore *store = existingStore;

NSPredicate *queryPredicate = [NSPredicate predicateWithFormat:@"(year = 2006)"];
CDTCloudantQuery *query = [[CDTCloudantQuery alloc]
initWithDataType:[store.mapper dataTypeForClassName:[NSStringFromClass([Automobile class])] withPredicate:queryPredicate];

[store performQuery:query completionHandler:^(NSArray *results, NSError *error) {
    if(error){
        // Handle error
    }else{
        // Use result of query. Result will be Automobile objects.
    }
}];

// Use an existing store
let store:CDTStore = existingStore

let queryPredicate:NSPredicate = NSPredicate(format:"(year = 2006)")
let query:CDTCloudantQuery = CDTCloudantQuery(dataType: "Automobile", withPredicate: queryPredicate)

store.performQuery(query, completionHandler: { (results:[AnyObject]!, error:NSError!) -> Void in
    if nil != error {
        // Handle error
    } else {
        // Use result of query. Result will be Automobile objects.
    }
})

```

## Supporting offline storage and synchronization

You can synchronize the data on a mobile device with a remote database instance. You can either pull updates from a remote database to the local database on the mobile device, or push local database updates to a remote database.

### About this task

With the data manager API, you can generate replication objects to control replications between a local store and a remote store.

When you run pull replication, the local database on the mobile device is updated with data from a remote database instance.

When you run push replication, the data from the local database on the mobile device sends data to a remote database.

### Running pull replication Procedure

Run pull replication.

```

// store is an existing CDTStore object created using IMFDataManager remoteStore
__block NSError *replicationError;
CDTPullReplication *pull = [manager pullReplicationForStore: store.name];
CDTReplicator *replicator = [manager.replicatorFactory oneWay:pull error:&replicationError];
if(replicationError){
    // Handle error
}else{
    // replicator creation was successful
}

[replicator startWithError:&replicationError];
if(replicationError){
    // Handle error
}else{

```

```

    // replicator start was successful
}

// (optionally) monitor replication via polling
while (replicator.isActive) {
    [NSThread sleepForTimeInterval:1.0f];
    NSLog(@"replicator state : %@", [CDTReplicator stringForReplicatorState:replicator.state]);
}

// Use an existing store
let store:CDTStore = existingStore

// store is an existing CDTStore object created using IMFDataManager remoteStore
var replicationError:NSError?
let pull:CDTPullReplication = manager.pullReplicationForStore(store.name)
let replicator:CDTReplicator = manager.replicatorFactory.oneWay(pull, error: &replicationError)
if nil != replicationError {
    // Handle error
} else {
    // replicator creation was successful
}

replicator.startWithError(&replicationError)
if nil != replicationError {
    // Handle error
} else {
    // replicator start was successful
}

// (optionally) monitor replication via polling
while replicator.isActive() {
    NSThread.sleepForTimeInterval(1.0)
    println("replicator state : \(CDTReplicator.stringForReplicatorState(replicator.state))")
}

```

## Running push replication Procedure

Run push replication.

```

// store is an existing CDTStore object created using IMFDataManager localStore
_block NSError *replicationError;
CDTPushReplication *push = [manager pushReplicationForStore: store.name];
CDTReplicator *replicator = [manager.replicatorFactory oneWay:push error:&replicationError];
if(replicationError){
    // Handle error
} else {
    // replicator creation was successful
}

[replicator startWithError:&replicationError];
if(replicationError){
    // Handle error
} else {
    // replicator start was successful
}

// (optionally) monitor replication via polling
while (replicator.isActive) {
    [NSThread sleepForTimeInterval:1.0f];
    NSLog(@"replicator state : %@", [CDTReplicator stringForReplicatorState:replicator.state]);
}

// Use an existing store
let store:CDTStore = existingStore

// store is an existing CDTStore object created using IMFDataManager localStore
var replicationError:NSError?

```

```

let push:CDTPushReplication = manager.pushReplicationForStore(store.name)
let replicator:CDTReplicator = manager.replicatorFactory.oneWay(push, error: &replicationError)
if nil != replicationError {
    // Handle error
} else {
    // replicator creation was successful
}

replicator.startWithError(&replicationError)
if nil != replicationError {
    // Handle error
} else {
    // replicator start was successful
}

// (optionally) monitor replication via polling
while replicator.isActive() {
    NSThread.sleepForTimeInterval(1.0)
    println("replicator state : \(CDTReplicator.stringForReplicatorState(replicator.state))")
}

```

---

## Push notification

Push notification is the ability of a mobile device to receive messages that are pushed from a server. The most common form of notification is SMS (Short Message Service). Notifications are received regardless of whether the application is currently running.

Notifications can take several forms, and are platform-dependent:

- Alert: a pop-up text message
- Badge, Tile: a graphical representation that includes a short text or image
- Banner, Toast: a pop-up text message at the top of the device display that disappears after it has been read
- Audio alert

The MobileFirst unified push notification mechanism enables the sending of mobile notifications to mobile phones. Notifications are sent through the vendor infrastructure. For example, iPhone notifications are sent from the MobileFirst Server to specialized Apple servers, and from there to the relevant phones. The unified push notification mechanism in IBM MobileFirst Platform Foundation for iOS makes the entire process of communicating with the users and devices completely transparent to the developer.

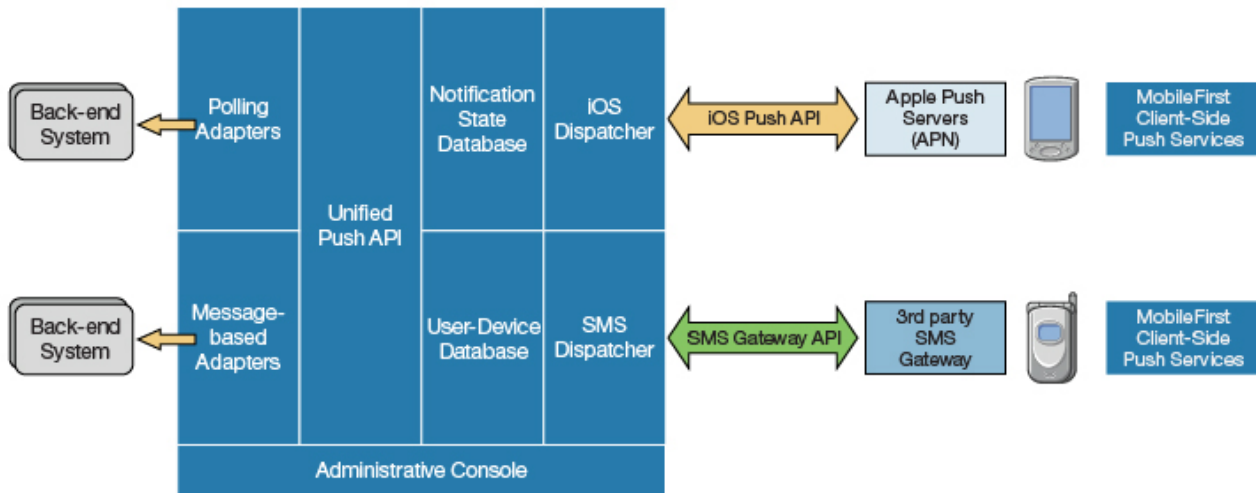

Figure 8-21. Push notification mechanism

iOS apps use the Apple Push Notification Service (APNS). For more information about setting up push notification, see “Setting up push notifications” on page 8-206.

### Proxy settings

Use the proxy settings to set the optional proxy through which notifications are sent to APNS. You can set the proxy by using the `push.apns.proxy.*` configuration properties. For more information, see “Configuration of MobileFirst applications on the server” on page 10-48.

### Architecture

Unlike other IBM MobileFirst Platform Foundation for iOS services, the push server requires outbound connections to Apple server using port that is defined by Apple.

For more information, see “Possible MobileFirst push notification architectures.”

## Possible MobileFirst push notification architectures

IBM MobileFirst Platform Foundation for iOS supports two different methods of implementing push notifications, which are based on how the enterprise back end provides the messages to the MobileFirst Server.

Two common ways exist to create an IBM MobileFirst Platform Foundation for iOS push notification architecture:

- The Java Message Service (JMS) polling method, in which messages are pulled from the JMS message queue and sent by the MobileFirst Server
- The enterprise back end method, in which an enterprise back end uses a MobileFirst adapter to deliver messages to a MobileFirst Server cluster

### JMS polling architecture

This architecture relies on the enterprise backend to deliver messages to a single instance of MobileFirst Server by using a JMS message queue. The developer must

create an IBM MobileFirst Platform Foundation for iOS JMS adapter, which pulls messages from the queue and calls the IBM MobileFirst Platform Foundation for iOS server-side push notification API to process the messages.

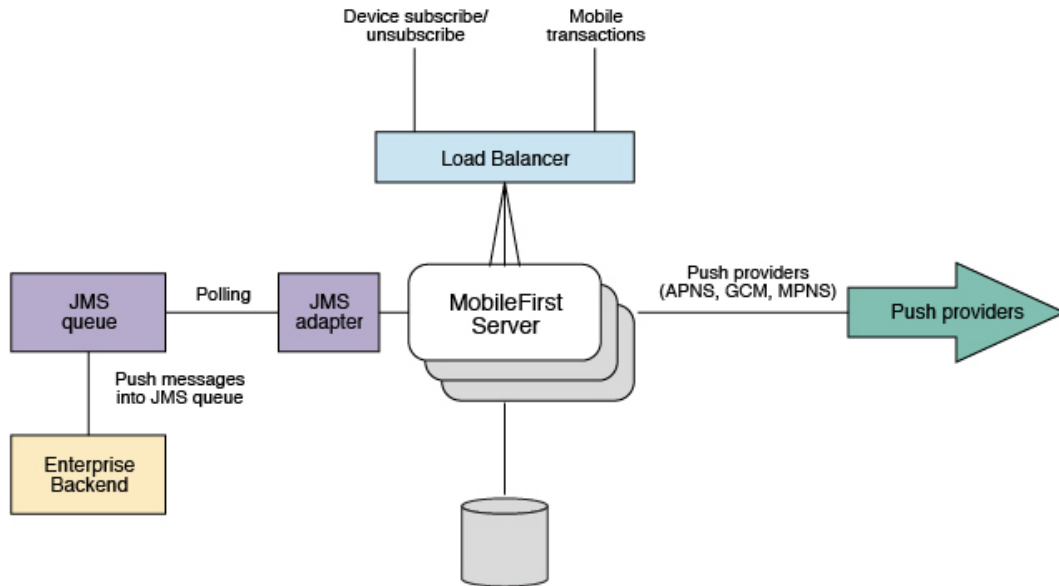

Figure 8-22. JMS polling push notification architecture

When this architecture is used, the flow is as follows:

1. Messages are put into the JMS queue by the enterprise backend.
2. The MobileFirst Server polls the JMS queue by using the JMS adapter, retrieving messages in short batches and sending them to the push providers.
3. A single MobileFirst Server instance pulls from the JMS queue and sends the push notifications. Even in a MobileFirst Server cluster, only one MobileFirst Server polls.
4. The process is implemented by using a MobileFirst JMS adapter, which functions as follows:
  - In a MobileFirst Server cluster, the single polling MobileFirst Server is selected randomly, by using the IBM MobileFirst Platform Foundation for iOS cluster-sync mechanism.
  - If the server that pulls from the JMS queue is shut down, another server takes its place.

This is the standard architecture. *Pros* of this method are that it involves an asynchronous queue, into which you can put the messages that you want to send. These messages are then processed and pulled later by the MobileFirst Server. *Cons* of this method are that only one server is sending the push notifications, so the maximum messages-per-second throughput is fixed.

### Enterprise backend calling the MobileFirst Server architecture

This architecture relies on the enterprise backend to deliver messages to a MobileFirst Server cluster by calling a MobileFirst adapter procedure.

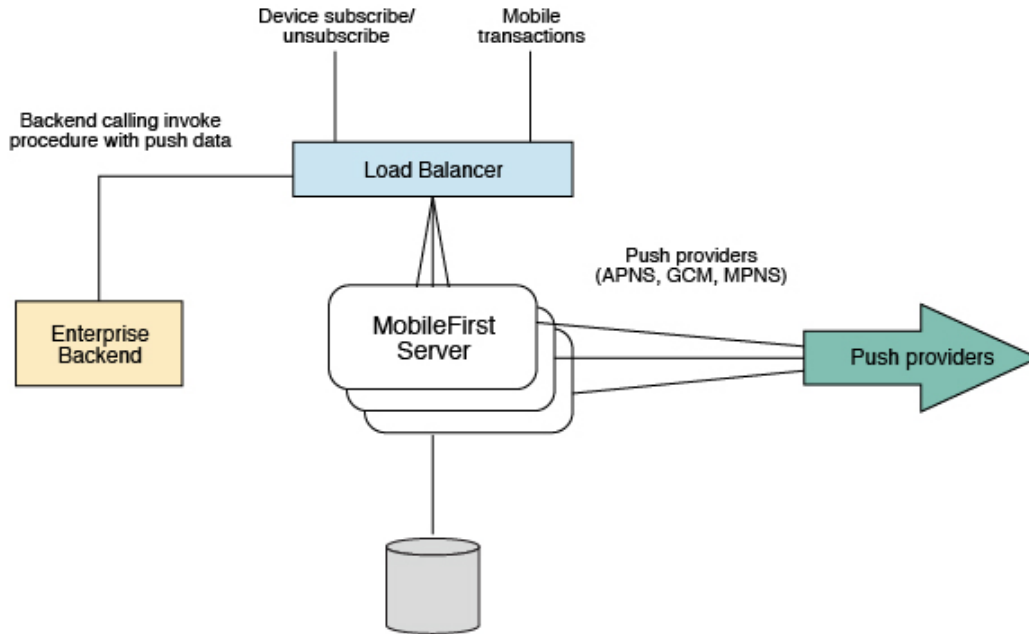

Figure 8-23. Enterprise backend push notification architecture

When this architecture is used, the flow is as follows:

1. The request is routed to one of the MobileFirst Server instances, which sends a push message to a provider.
2. In this flow, all MobileFirst Server instances can send push notifications, but for a specific request only one of the server instances performs the task.
3. The enterprise backend initiates calls to the load balancer.

*Pros* of this method are that all MobileFirst Server can be used to send push notifications, so you can add more servers if you must send more messages per second. *Cons* of this method are that every push message is a transaction on the MobileFirst Server. You can mitigate this overhead by sending a number of messages together or by having the MobileFirst adapter procedure that is invoked call the backend for a batch of messages rather than single messages.

## Setting up push notifications

You can send push notifications to mobile devices via the MobileFirst Server.

### Setting up push notifications for iOS

To set up push notifications for iOS devices, you must use the Apple Push Notification Service (APNS). To use APNS, you must be a registered Apple iOS Developer and obtain an Apple APNS certificate for your application.

### Before you begin

Ensure that the following servers are accessible from MobileFirst Server:

- Sandbox servers:
  - gateway.sandbox.push.apple.com:2195
  - feedback.sandbox.push.apple.com:2196
- Production servers:



- gateway.push.apple.com:2195
- feedback.push.apple.com:2196

**Procedure**

1. Follow the required steps to obtain your APNS certificate and password. For more information, see the developerWorks article Understanding and setting up artifacts required to use iOS devices and APNS in a development environment.
2. Place the Apple APNS certificate file at the root of the application folder, in which the application-descriptor.xml file is held.
3. Install the Entrust CA root certificate by using SSL port 443.

While you work in development mode, rename your certificate file to apns-certificate-sandbox.p12. When you move to production, rename your certificate file to apns-certificate-production.p12. In both cases, place the certificate file in the environment root folder or in the application root folder. When the hybrid application has both iPhone and iPad environments, separate certificates are necessary for push notification. In that case, place those certificates in the corresponding environment folders.

**Note:** The environment root folder takes the highest priority.

For more information, see the iOS Developer Library.

4. In the application-descriptor.xml file, for <iPhone> set the following attributes for the <pushSender> element:

Attribute	Description
password	The APNS certificate password received from Apple.

**Results**

Your push notification setup is now complete.

**Broadcast notifications**

Broadcast notifications are notification messages that are targeted to all the devices that have the MobileFirst application installed and configured for push notifications.

Broadcast notifications are enabled by default with any MobileFirst application that is enabled for push notification. For more information about configuring your application for push notifications, see “Setting up push notifications” on page 8-206.

Any MobileFirst application that is enabled for push notification has a predefined subscription to the Push.ALL tag, which is used by MobileFirst Server to broadcast notification messages to all the devices. To disable broadcast notification for iOS native app, use unsubscribeTag method of WLPush class, with the tag name Push.ALL.

For more information about sending broadcast notification, see “Broadcast notification” on page 8-214 section in “Sending push notifications” on page 8-214.

## Event source-based notifications

Event source-based notifications are notification messages that are targeted to devices with a user subscription.

An event source can either poll notifications from the backend system, or wait for the backend system to explicitly push a new notification. The process of the event source-based notifications is as follows: :

1. Notifications are retrieved by the MobileFirst adapter event source, either by poll or by push from the backend system.
2. The adapter processes the notification and sends it to an Apple push service mediator.
3. The push service mediator sends a push notification to the device.
4. The device processes the received notification.

To start receiving push notifications, an application must subscribe to an event source. The event source is a push notification channel to which mobile applications can register. You can create an event source by declaring a notification event source in the MobileFirst adapter JavaScript code at a global level, outside any JavaScript function. For example,

```
WL.Server.createEventSource({
  name: 'PushEventSource',
  onDeviceSubscribe: 'deviceSubscribeFunc',
  onDeviceUnsubscribe: 'deviceUnsubscribeFunc',
  securityTest: 'PushApplication-strong-mobile-securityTest'
});
```

For more information about createEventSource method, see WL.Server class.

After the creation of the event source, you can proceed with the push notification subscriptions that is described in “Subscribing to an event source.”

For more information about sending event source-based notification, see Event source-based notification section in “Sending push notifications” on page 8-214.

### Subscribing to an event source

Before a device can start receiving push notifications, it must first subscribe to a push notification event source. When the user approves the push notification subscription, the device is registered with an appropriate push server.

#### About this task

There are two levels of subscription: user subscription and device subscription.

- *User subscription* is an entity that contains a user ID, a device ID, and an event source ID. It represents the intent of the user to receive notification from a specific event source.
- A *device subscription* belongs to a user subscription, and exists in the scope of a specific user and event source. A user subscription can have several device subscriptions.

The user subscription for an event source is created when the user first subscribes to the event source from any device. The event source is declared in the MobileFirst adapter that is used by the application for push notification services.

After the user approves a push notification subscription, the device is registered with an Apple push server to obtain a token that is used to identify the device.

The token is in the following form: Allow notifications for application X on device Y. The device then sends a subscription request to the MobileFirst Server.

For iOS native application, use the methods of WLPush class.

### Procedure

1. When the application first connects to the MobileFirst Server from the device, the device registers with a push service mediator and obtains a device token. This process is done automatically by IBM MobileFirst Platform Foundation for iOS.
2. When the token is obtained, the `onReadyToSubscribe` callback function that is defined in the application is notified that a device is ready to subscribe to push notifications.
3. After the `onReadyToSubscribe` callback is notified, the application subscribes to a tag by using the `subscribe` API.
4. Optional: If push notifications are no longer required, you can unsubscribe. The device subscription is deleted either by an application that calls the `unsubscribe` API, or when the push mediator informs the MobileFirst Server that the device is permanently inaccessible.

### Results

While the user subscription exists, the MobileFirst Server can produce push notifications for the subscribed user.

### What to do next

The event source-based notifications can be delivered by the adapter code to all or some of the devices that the user subscribed from. For more information, see Event source-based notification section in “Sending push notifications” on page 8-214.

## Interactive notifications

Interactive notifications allow the users to take actions when a notification is arrived without opening the application. When an interactive notification arrived, the device shows the action buttons along with the notification message. Currently, the interactive notifications are supported on iOS devices with version 8 onwards. If an interactive notification is sent to iOS devices with version lesser than 8, the notification actions are not displayed.

### Sending interactive push notification

Prepare the notification and send notification. For more information, see “Sending push notifications” on page 8-214.

You can set a string to indicate the category of notification with the notification object. Based on the category value, the notification action buttons are displayed.

To set the category in event source notifications, there are two options:

- Create notification JSON object and set category in that object:  

```
var notification = { badge:1, category: 'poll', ...};
```
- Create notification object by using the `WL.Server.createDefaultNotification` API and set category on the notification object:  

```
notification.APNS.category= 'poll';
```

For more information, see the `WL.Server.createDefaultNotification` and `WL.Server.notifyAllDevices` APIs in `WL.Server` class.

In Broadcast, Tag-based and Uni-cast notifications set the type while you create the notification object:

```
notification.settings.apns.category = 'poll';
```

For more information, see the `WL.Server.sendMessage` API in `WL.Server` class.

## Handling interactive push notifications in native iOS application

You must follow these steps to receive interactive notifications:

1. Enable the application capability to perform background tasks on receiving the remote notifications. This step is required if some of the actions are background-enabled.
2. In the `AppDelegate` (application: `didRegisterForRemoteNotificationsWithDeviceToken` application:), set the categories before you set the `deviceToken` on `WLPush` Object.

```
if([application respondsToSelector:@selector(registerUserNotificationSettings:)]) {
    UIUserNotificationType userNotificationTypes = UIUserNotificationTypeNone | UIUserNotificationTypeSound |
    UIUserNotificationTypeAlert | UIUserNotificationTypeBadge;

    NSMutableUserNotificationAction *acceptAction = [[NSMutableUserNotificationAction alloc] init];
    acceptAction.identifier = @"OK";
    acceptAction.title = @"OK";

    NSMutableUserNotificationAction *rejetAction = [[NSMutableUserNotificationAction alloc] init];
    rejetAction.identifier = @"NOK";
    rejetAction.title = @"NOK";

    NSMutableUserNotificationCategory *category = [[NSMutableUserNotificationCategory alloc] init];
    category.identifier = @"poll";
    [category setActions:@[acceptAction,rejetAction] forContext:UIUserNotificationActionContextDefault];
    [category setActions:@[acceptAction,rejetAction] forContext:UIUserNotificationActionContextMinimal];

    NSSet *catgories = [NSSet setWithObject:category];
    [application registerUserNotificationSettings:[UIUserNotificationSettings settingsForTypes:userNotificationTypes
    categories:catgories]];
}
```

3. Implement new callback method on `AppDelegate`:

```
-(void)application:(UIApplication *)application handleActionWithIdentifier:(NSString *)identifier
forRemoteNotification:(NSDictionary *)userInfo completionHandler:(void (^)())completionHandler
```

4. This new callback method is invoked when user clicks the action button.
5. The implementation of this method must perform the action that is associated with the specified identifier and execute the block in the **completionHandler** parameter.

## Tag-based notification

Tag notifications are notification messages that are targeted to all the devices that are subscribed to a particular tag.

Tags-based notifications allow segmentation of notifications based on subject areas or topics. Notification recipients can choose to receive notifications only if it is about a subject or topic that is of interest. Therefore, tags-based notification provides a means to segment recipients. This feature enables ability to define tags and then send and receive messages by tags. A message is targeted to only the devices that are subscribed to a tag.

You must first create the tags for the application, set up the tag subscriptions and then initiate the tag-based notifications. For more information, see .

For more information about sending tag-based notification, see “Tag-based notification” on page 8-214 section in “Sending push notifications” on page 8-214.

## Silent notifications

Silent notifications are notifications that do not display alerts or otherwise disturb the user. When a silent notification arrives, the application handling code runs in background without bringing the application to foreground. Currently, the silent notifications are supported on iOS devices with version 7 onwards. If the silent notification is sent to iOS devices with version lesser than 7, the notification is ignored if the application is running in background. If the application is running in the foreground, then the notification callback method is invoked.

### Sending silent push notification

Prepare the notification and send notification. For more information, see “Sending push notifications” on page 8-214.

The three types of notifications that are supported for iOS are represented by constants DEFAULT, SILENT, and MIXED. When the type is not explicitly specified, the DEFAULT type is assumed.

For MIXED type notifications, a message is displayed on the device while, in the background, the app awakens and processes a silent notification. The callback method for MIXED type notifications gets called twice - once when the silent notification reaches the device and once when the application is opened by tapping on the notification.

To set the type in event source notifications, create notification object by using the WL.Server.createDefaultNotification API and set type on the notification object:

```
notification.APNS.type = "DEFAULT" | "SILENT" | "MIXED";
```

For more information, see the WL.Server.createDefaultNotification and WL.Server.notifyAllDevices APIs in WL.Server class.

If the notification is event source-based, the silent notifications are ignored if they arrive before the application registers the callback.

In Broadcast, Tag-based and Uni-cast notifications set the type while you create the notification object:

```
notification.APNS.type = "DEFAULT" | "SILENT" | "MIXED";
```

For more information, see the WL.Server.sendMessage API in WL.Server class.

If the notification is silent, the alert, sound, and badge are ignored.

### Handling silent push notifications in native iOS application

You must follow these steps to receive silent notifications:

1. Enable the application capability to perform background tasks on receiving the remote notifications.

2. Implement new callback method on AppDelegate (application: `didReceiveRemoteNotification:fetchCompletionHandler:`) to receive silent notifications when the application is running on background.
3. In the callback, check whether the notification is silent or not by checking that the key `content-available` is set to 1.
4. After you finish processing the notification, you must call the block in the **handler** parameter immediately. Otherwise, your app will be terminated. Your app has up to 30 seconds to process the notification and call the specified completion handler block.

## Unicast notifications

Unicast notifications are notification messages that are targeted to a particular device or a **userID**.

Unicast notifications do not require any additional setup and are enabled by default when the MobileFirst application is enabled for push notifications. For more information about configuring your application for push notifications, see “Setting up push notifications” on page 8-206.

For more information about sending unicast notification, see “Unicast notification” on page 8-215 section in “Sending push notifications” on page 8-214.

## Web-based SMS subscription

Subscription, and unsubscription, to SMS notifications can be performed by making HTTP GET requests to the subscribe SMS servlet. The subscribe SMS servlet can be used for SMS subscriptions without the requirement for a user to have an app installed on their device.

Enter the following URL to access the subscribe SMS servlet:

```
http://<hostname>:<port>/<context>/subscribeSMS
```

This URL can be used to subscribe and unsubscribe.

You must create an application and an event source within an adapter and deploy them on the IBM MobileFirst Platform Server before you make calls to the subscribe SMS servlet. For more information about how to create an event source, see the `createEventSource` method in the `WL.Server` class.

Table 8-16. Subscribe SMS servlet URL parameters

URL parameter	URL parameter description
<b>option</b>	Optional string. Subscribe or unsubscribe action to perform. The default option is <code>subscribe</code> . If any non-blank string other than <code>subscribe</code> is supplied, the <code>unsubscribe</code> action is performed.
<b>eventSource</b>	Mandatory string. The name of the event source. The event source name is in the format <code>AdapterName.EventSourceName</code> .
<b>alias</b>	Optional string. A short ID defining the event source during subscription. This ID is the same ID as provided in <code>WL.Client.Push.subscribeSMS</code> .
<b>phoneNumber</b>	Mandatory string. User phone number to which SMS notifications are sent. The phone number can contain digits (0-9), plus sign (+), minus sign (-), and space (Δ) characters only.

Table 8-16. Subscribe SMS servlet URL parameters (continued)

URL parameter	URL parameter description
<b>userName</b>	Optional string. Name of the user. If no user name is provided during subscription, an anonymous subscription is created by using the phone number as the user name. If a user name is provided during subscription, it must also be provided during unsubscription.
<b>appId</b>	Mandatory string for subscribe. The ID of the application that contains the SMS gateway definition. The application ID is constructed from the application name, application environment, and application version.

**Note:** If any parameter value contains special characters, this parameter must be encoded by using URL encoding, also known as percent encoding, before the URL is constructed. Parameter values containing only the following characters do not need to be encoded:

a-z, A-Z, 0-9, period (.), plus sign (+), minus sign (-), and underscore (\_)

Subscriptions that are created by using the subscribe SMS servlet are independent of subscriptions that are created by using a device. For example, it is possible to have two subscriptions for the same phone number and user name; one created by using the device and one created by using the subscribe SMS servlet. If there are two subscriptions for the same phone number and user name, unsubscription by using the subscribe SMS servlet unsubscribes only the subscription that is made through the subscribe SMS servlet. However, unsubscription by using the IBM MobileFirst Platform Operations Console unsubscribes both subscriptions.

## Security

It is important to secure the subscribe SMS servlet because it is possible for entities with malicious intent to call the servlet and create spurious subscriptions. By default, IBM MobileFirst Platform Foundation for iOS protects static resources such as the subscribe SMS servlet. The `authenticationConfig.xml` file is configured to reject all requests to the subscribe SMS servlet with a rejecting login module. To allow restricted access to the subscribe SMS servlet, MobileFirst administrators must modify the `authenticationConfig.xml` file with appropriate authenticator and login modules.

For example, the following configuration in the `authenticationConfig.xml` file ensures only requests with a specific user name in the header of the HTTP request are allowed:

```
<staticResources>
  <resource id="subscribeServlet" securityTest="SubscribeServlet">
    <urlPatterns>/subscribeSMS*</urlPatterns>
  </resource>
  ...
</staticResources>

<securityTests>
  <customSecurityTest name="SubscribeServlet">
    <test realm="SubscribeServlet" isInternalUserID="true"/>
  </customSecurityTest>
  ...
</securityTests>

<realms>
  <realm name="SubscribeServlet" loginModule="headerLogin">
    <className>com.worklight.core.auth.ext.HeaderAuthenticator</className>
```

```

    </realm>
    ...
</realms>

<loginModules>
  <loginModule name="headerLogin">
    <className>com.worklight.core.auth.ext.HeaderLoginModule</className>
    <parameter name="user-name-header" value="username"/>
  </loginModule>
  ...
</loginModules>

```

## Sending push notifications

When you have set up push notification, whether event-source based, tag-based, or broadcast-enabled, you can send push notifications from the server.

### Broadcast notification

Before you can send a broadcast notification, you must set up broadcast notifications for the required applications. For more information, see “Broadcast notifications” on page 8-207.

You can send a broadcast notification in the following way:

- Use the `sendMessage` method of the `WL.Server` class. The **`applicationId`** and **`notificationOptions`** parameters are mandatory.
- The **`notificationOptions.target`** object must not be specified or empty.

### Event source-based notification

Before you can send event source-based notification, you must set up the subscriptions. For more information, see “Subscribing to an event source” on page 8-208.

An event source can either poll notifications from the backend system, or wait for the backend system to explicitly push a new notification. In this example, a `submitNotifications()` adapter function is called by a backend system as an external API to send notifications.

```

function submitNotification(userId, notificationText) {
  var userSubscription = WL.Server.getUserNotificationSubscription('PushAdapter.PushEventSource', user);
  if (userSubscription === null) {
    return { result: "No subscription found for user :: " + userId };
  }

  var badgeDigit = 1;
  var notification = WL.Server.createDefaultNotification(notificationText, badgeDigit, {custom:"data"});
  WL.Server.notifyAllDevices(userSubscription, notification);
  return {
    result: "Notification sent to user :: " + userId
  };
}

```

For more information about the various APIs to send notifications, see `WL.Server`.

### Tag-based notification

Before you can send tag-based notifications, you must set up tag subscriptions. For more information, see .

You can send a tag-based notification in the following way:



- Use the `sendMessage` method of the `WL.Server` class. The `applicationId` and `notificationOptions` parameters are mandatory.
- Specify the `tagNames` as an array in the `notificationOptions.target.tagNames` object.

## Unicast notification

You can send a unicast notification to a particular device in the following way:

- Use the `sendMessage` method of the `WL.Server` class. The `applicationId` and `notificationOptions` parameters are mandatory.
- The `deviceId(s)` as an array in the `notificationOptions.target.deviceIds` object.

You can send a unicast notification to a particular user in the following way:

- Use the `sendMessage` method of the `WL.Server` class. The `applicationId` and `notificationOptions` parameters are mandatory.
- The `userId(s)` as an array in the `notificationOptions.target.userIds` object.

**Note:** The notification message can target multiple devices or users by specifying multiple `deviceIDs` or `userIDs` in the `notificationOptions.tager.deviceIds` or `notificationOptions.target.userIds`.

## Platform or environment-based notification

You can send a platform or environment-based notification in the following way:

- Use the `sendMessage` method of the `WL.Server` class. The `applicationId` and `notificationOptions` parameters are mandatory.
- Specify the platform, A (Apple), in the `notificationOptions.target.platforms` object.

## Restriction

**Restriction:** The `sendMessage` method does not support SMS notification. For more information, see “Sending SMS push notifications.”

## Sending SMS push notifications

In addition to standard push notifications, you can also send Short Message Service (SMS) messages, more commonly known as text messages, to user devices. To receive SMS notifications, users must first subscribe to a push notification event source.

### About this task

The SMS notification framework extends the push notification framework. SMS support is provided for Apple devices that support SMS functions. IBM MobileFirst Platform Foundation for iOS includes the capability to send SMS notifications to all platforms that provide SMS support.

### Procedure

1. An SMS notification infrastructure is set up.

A MobileFirst adapter acts as a connector to an app that is running on a mobile device.

2. The user of the mobile device sends a subscribe request from the application to the event source that is declared in the MobileFirst adapter, by using the client-side `WL.Client.Push.subscribeSMS` method.
3. The user subscription to the event source is registered at the MobileFirst Server.
4. When the back-end service must notify the user, it calls a method in the MobileFirst adapter.
5. The adapter checks whether an SMS subscription exists for that user and, if it does, sends the SMS alert message through a preconfigured SMS aggregator.
6. Optional: If SMS notifications are no longer necessary, you can unsubscribe. The subscription is deleted either by an application that calls the `WL.Client.Push.unsubscribeSMS` method, or by using the Admin console. For more information, see *Administering push notifications with the MobileFirst Operations Console*.

For a detailed scenario-based example that shows SMS messaging, see the developerWorks article *Send SMS push notifications to your mobile app using IBM MobileFirst Platform Foundation for iOS*.

## **Sending push notifications from WebSphere Application Server – IBM DB2**

To issue push notifications from a WebSphere Application Server that uses IBM DB2 as its database, a custom property must be added.

### **About this task**

If you use WebSphere Application Server with an IBM DB2 database, errors can arise when you try to send push notifications. To resolve this situation, you must add a custom property in WebSphere Application Server, at the data source level.

### **Procedure**

1. Log in to the WebSphere Application Server admin console.
2. Select **Resources > JDBC > Data sources > DataSource name > Custom properties** and click **New**.
3. In the **Name** field, enter `allowNextOnExhaustedResultSet`.
4. In the **Value** field, type `1`.
5. Change the type to `java.lang.Integer`.
6. Click **OK** to save your changes.
7. Select custom property **resultSetHoldability**.
8. In the **Value** field, type `1`.
9. Click **OK** to save your changes.

## **Configuring a polling event source to send push notifications**

Polling event sources can be used to generate notification events, such as push notifications, that the MobileFirst client framework can subscribe to.

### **About this task**

The MobileFirst adapter framework provides the ability to implement event sources, which can be used to generate notification events such as push notifications. However, notifications must be retrieved from a back-end system

before they can be sent out. Event sources can either poll notifications from the back-end system, or wait for the back-end system to explicitly push a new notification.

This task describes how to create a polling event source, and use it to send push notifications. A polling event source is a long-running task that has the following mandatory properties:

- Event source name
- Polling interval
- Polling function

## Procedure

- Consider the following simple example. The diagram shows a sample for a basic polling event source:

```
1 WL.Logger.info("Creating event source");
2 WL.Server.createEventSource({
3     name: "MyPollingEventSource",
4     poll: {
5         interval: 3, // Interval in seconds
6         onPoll: "doSomething" // Function to be invoked
7     }
8 });
9
10
11 function doSomething(){
12     WL.Logger.info(new Date() + " :: Doing something");
13 }
```

The `doSomething()` function is invoked every three seconds. If you deploy this adapter to the MobileFirst Server, you see the following logs in the server console:

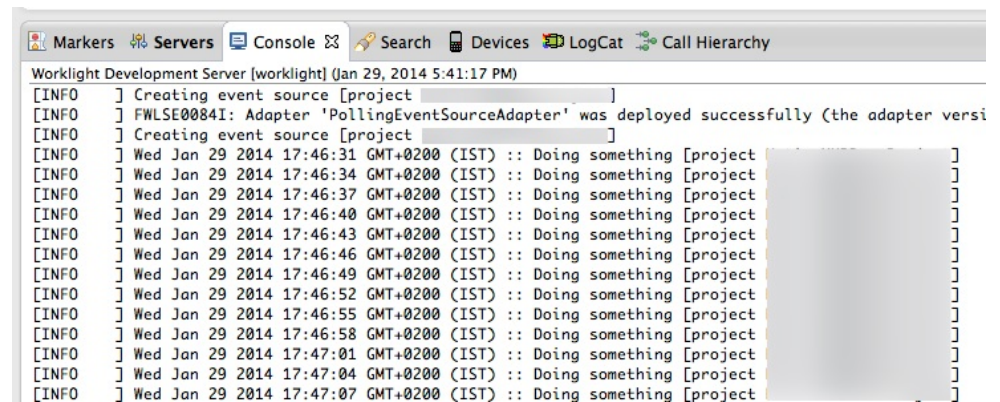

```
Worklight Development Server [worklight] (Jan 29, 2014 5:41:17 PM)
[INFO ] Creating event source [project ]
[INFO ] FWLSE0084I: Adapter 'PollingEventSourceAdapter' was deployed successfully (the adapter versi
[INFO ] Creating event source [project ]
[INFO ] Wed Jan 29 2014 17:46:31 GMT+0200 (IST) :: Doing something [project ]
[INFO ] Wed Jan 29 2014 17:46:34 GMT+0200 (IST) :: Doing something [project ]
[INFO ] Wed Jan 29 2014 17:46:37 GMT+0200 (IST) :: Doing something [project ]
[INFO ] Wed Jan 29 2014 17:46:40 GMT+0200 (IST) :: Doing something [project ]
[INFO ] Wed Jan 29 2014 17:46:43 GMT+0200 (IST) :: Doing something [project ]
[INFO ] Wed Jan 29 2014 17:46:46 GMT+0200 (IST) :: Doing something [project ]
[INFO ] Wed Jan 29 2014 17:46:49 GMT+0200 (IST) :: Doing something [project ]
[INFO ] Wed Jan 29 2014 17:46:52 GMT+0200 (IST) :: Doing something [project ]
[INFO ] Wed Jan 29 2014 17:46:55 GMT+0200 (IST) :: Doing something [project ]
[INFO ] Wed Jan 29 2014 17:46:58 GMT+0200 (IST) :: Doing something [project ]
[INFO ] Wed Jan 29 2014 17:47:01 GMT+0200 (IST) :: Doing something [project ]
[INFO ] Wed Jan 29 2014 17:47:04 GMT+0200 (IST) :: Doing something [project ]
[INFO ] Wed Jan 29 2014 17:47:07 GMT+0200 (IST) :: Doing something [project ]
```

The log shows that the `doSomething()` function is invoked at 3-second intervals.

- This second example shows a more realistic example of a polling event source:

```

1  /*
2  * Create an eventSource.
3  */
4  WL.Server.createEventSource({
5      name: "MyPollingEventSource",
6      poll: {
7          interval: 3, // Interval in seconds
8          onPoll: "sendNotifications" // Function to be invoked
9      }
10 });
11
12 /*
13 * Polling function. Gets messages from HTTP backend and sends them one by one
14 */
15 function sendNotifications() {
16     // Use adapter capabilities to retrieve messages from backend
17     var response = WL.Server.invokeHttp({/* invocation options */});
18     var messages = response.messages;
19
20     // Iterate received messages
21     for (var i = 0; i < messages.length; i++) {
22
23         // Get single message object
24         var message = messages[i];
25
26         // Retrieve userSubscription object
27         var userSubscription = WL.Server.getUserNotificationSubscription("MyAdapter.MyPollingEventSource", message.userId);
28
29         if (userSubscription) {
30             // Create default notification body and send it to all devices belonging to specific user
31             var notification = WL.Server.createDefaultNotification(message.text, message.badge, message.payload);
32             WL.Server.notifyAllDevices(userSubscription, notification);
33         } else {
34             WL.Logger.error("Subscription for userId=" + message.userId + " not found. Notification discarded.");
35         }
36     }
37 }
38 }

```

The sample includes the following key elements:

- Lines 7 - 8: The polling event source continuously invokes a `sendNotifications()` function with a 3-second interval.
- Lines 18 - 19: Every time the `sendNotifications()` function is invoked it requests messages data from the back-end. The sample shows an HTTP back-end, but it could be any other type of back-end that MobileFirst adapters support; for example, SQL. The code assumes that the following JSON markup is returned by the back-end. However, since the MobileFirst adapter knows how to automatically convert data to JSON, the back-end data could also be XML.

```

{
  messages: [{
    userId: "John",
    text: "New incoming transition",
    badge: 2,
    payload: {}
  }, {
    userId: "Bob",
    text: "Please approve withdrawal",
    badge: 5,
    payload: {}
  }
]
}

```

- Line 22: The code iterates over the received messages array.
- Line 25: Every message contains the user ID of a user that the notification should be sent to.
- Line 28: Using this user ID, the code tries to obtain a `userSubscription` object.
- Lines 30 - 33: If a `userSubscription` object is found for the specified user ID, a new notification is created and is sent to all user devices.
- Line 35. If a `userSubscription` object is not found for the specified user ID, an error is logged.

An important feature of a polling event source is that unlike regular adapter procedures, the polling function is triggered by the MobileFirst Server itself, and not by the incoming request. Therefore any data or APIs related to request or session context are not available or functional. For example, APIs such as

WL.Server.getActiveUser() or WL.Server.getClientRequest() are not functional. Also, you do not need to expose polling function in the adapter XML file.

## Using two-way SMS communication

SMS two-way communication enables communication between a mobile phone and the MobileFirst Server, over an SMS channel. SMS messages that originate from the mobile device can be sent to the MobileFirst Server through an external SMS gateway. The MobileFirst Server can then send a response message back to the originating mobile device.

### Before you begin

To run SMS two-way communication, the mobile device must support SMS functions.

### About this task

Keywords or shortcodes should be configured with the third-party SMS gateway. The gateway should be configured to forward SMS messages to the SMS servlet of the MobileFirst Server, either directly or through a reverse proxy URL, based on the topology in your environment:

```
http://hostname:port/context/receiveSMS
```

The SMS messages that are sent from mobile phones are forwarded to an adapter procedure on the MobileFirst Server, which is configured by the developer. The adapter procedure can include the logic to process the request, or the procedure can forward the request to a back-end system for processing. The response is returned by using the MobileFirst notification framework. For more information, see Push notification.

The two-way SMS architecture is summarized in the following figure:

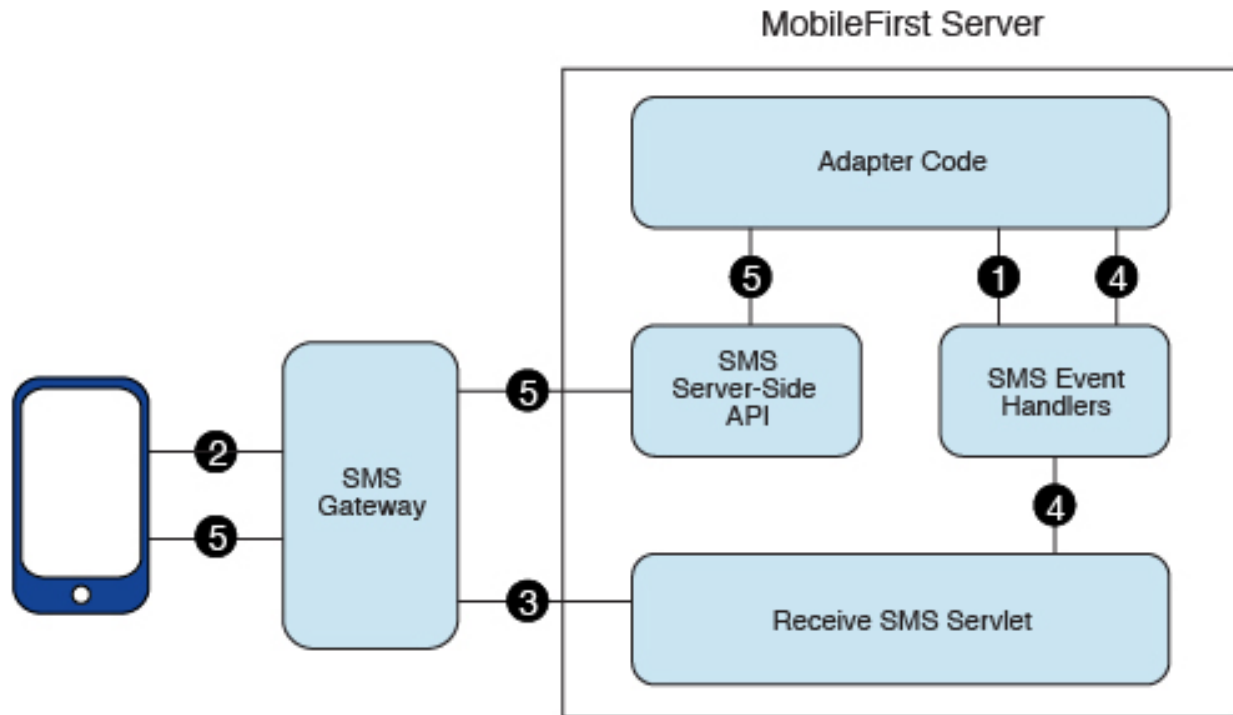

Figure 8-24. Two-way SMS architecture

1. The adapter registers SMS event handlers on the MobileFirst Server.
2. SMS messages are sent from mobile devices to the SMS gateway, which is configured with an SMS servlet of MobileFirst Server.
3. The SMS gateway forwards SMS messages to a configured MobileFirst URL.
4. An SMS servlet on MobileFirst Server matches the parameters with filters that are defined in SMS event handlers, and calls an adapter callback procedure.
5. The adapter processes SMS messages and sends an SMS message to the mobile device by using the SMS API.

You use a series of server API methods to send and receive SMS messages:

**WL.Server.createSMSEventHandler**

Create an SMS event handler.

**WL.Server.setEventHandlers**

Set event handlers to implement callbacks for received events.

**WL.Server.subscribeSMS**

Subscribe a phone number to the specified event source.

**WL.Server.unsubscribeSMS**

Unsubscribe the phone number from the specified event source.

**WL.Server.getSMSSubscription**

Return an SMS subscription object for a phone number.

## Troubleshooting push notification problems

Find information to help resolve push notification issues that you might encounter.

## iOS Push

Table 8-17. iOS Push issues

Problem	Actions to take
<p>The push notification fails to send, and you see the following exception in the server log:</p> <pre>com.notnoop.exceptions.InvalidSSLConfig: java.io.IOException: Error in loading the keystore: Private key decryption error: (java.security.InvalidKeyException: Illegal key size)  at com.notnoop.apns.internal.Utilities .newSSLContext(Utilities.java:88)  at com.ibm.pushworks.server.notification.apns .ApplicationConnection.createBuilderWithCertificate (ApplicationConnection.java:180) at com.ibm.pushworks.server.notification.apns .ApplicationConnection .&lt;init&gt;(ApplicationConnection.java:59)  ...</pre>	<p>To resolve this problem, complete the following steps.</p> <ol style="list-style-type: none"><li>1. Download the unrestricted version of the JCE policy files.<ol style="list-style-type: none"><li>a. Log in to Unrestricted SDK JCE policy files.</li><li>b. Select <b>Unrestricted JCE Policy files for SDK</b> for all newer versions (Version 1.4.2 and higher).</li><li>c. Click <b>Continue</b> and finish the download process. There are 3 files in the .zip file:<ul style="list-style-type: none"><li>• readme.txt</li><li>• local_policy.jar</li><li>• US_export_policy.jar</li></ul></li></ol></li><li>2. Update the JCE policy files for the server environment.<ol style="list-style-type: none"><li>a. Stop the server.</li><li>b. Use the new local_policy.jar file and the new US_export_policy.jar file to replace the old local_policy.jar file and the US_export_policy.jar file that are found in the &lt;jdk_path&gt;/jre/lib/security folder. <b>Note:</b> The &lt;jdk_path&gt; might be bundled with the server.</li><li>c. Restart the server.</li></ol></li></ol>

---

## MobileFirst security framework

A collection of topics that describe OAuth-based and classic security features in IBM MobileFirst Platform Foundation for iOS.

### OAuth-based security model

Topics that describe OAuth-based security features in IBM MobileFirst Platform Foundation for iOS.

#### Overview

The OAuth 2.0 protocol is based on acquiring an access token, which encapsulates the authorization that is granted to the client. In that context, the IBM MobileFirst Platform Server serves as an authorization server and is able to generate such tokens. The client can then use these tokens to access resources on a resource server, which can be either the MobileFirst Server itself, or an external server. The resource servers perform validation on the token to make sure that the client can be granted access to the requested resource. This separation between resource server and authorization server in the new OAuth-based model allows you to enforce MobileFirst security on resources that are running outside the MobileFirst Server.

To support backward compatibility, the classic (pre-V7.0) MobileFirst security model is still in use in the flows that are based on the existing MobileFirst APIs (for example, invokeProcedure in Java). The new client APIs trigger flows that conform to the OAuth-based security model. IBM MobileFirst Platform Foundation

for iOS V7.0 provides seamless integration between the two security models. The platform allows you to mix classic and new APIs in the same application, while keeping a consistent security context on the server side.

## **End-to-end authorization flow**

The new MobileFirst end-to-end authorization flow is based on the OAuth specification and comprises the following phases:

1. Acquiring a token (see Figure 1): In this phase, the client obtains a token from the authorization server, following these steps:
  - a. Registration: This phase occurs once in the lifetime of a mobile app that is installed on a device. In this phase, the client registers itself with the MobileFirst Server. When application authenticity has been configured, it is activated during registration.
  - b. Authorization: In this phase, the client has to undergo specific security checks, according to the scope of the authorization request. These are implemented using the building blocks of the classic MobileFirst security model - authentication realms on the server side, and challenge handlers on the client side. All the security checks supported by MobileFirst can be used in this phase (built-in realms such as remoteDisable and others, custom realms, and adapter-based authentication).
  - c. Token generation: After successful authorization, the client is redirected to the token endpoint, where it is authenticated using the PKI trust that was established during the registration phase. The endpoint then generates two sets of tokens and sends them back to the client: an access token, which encapsulates all the security checks that the client has passed in the authorization phase and an ID token, which contains information regarding the user and device identity of the client.



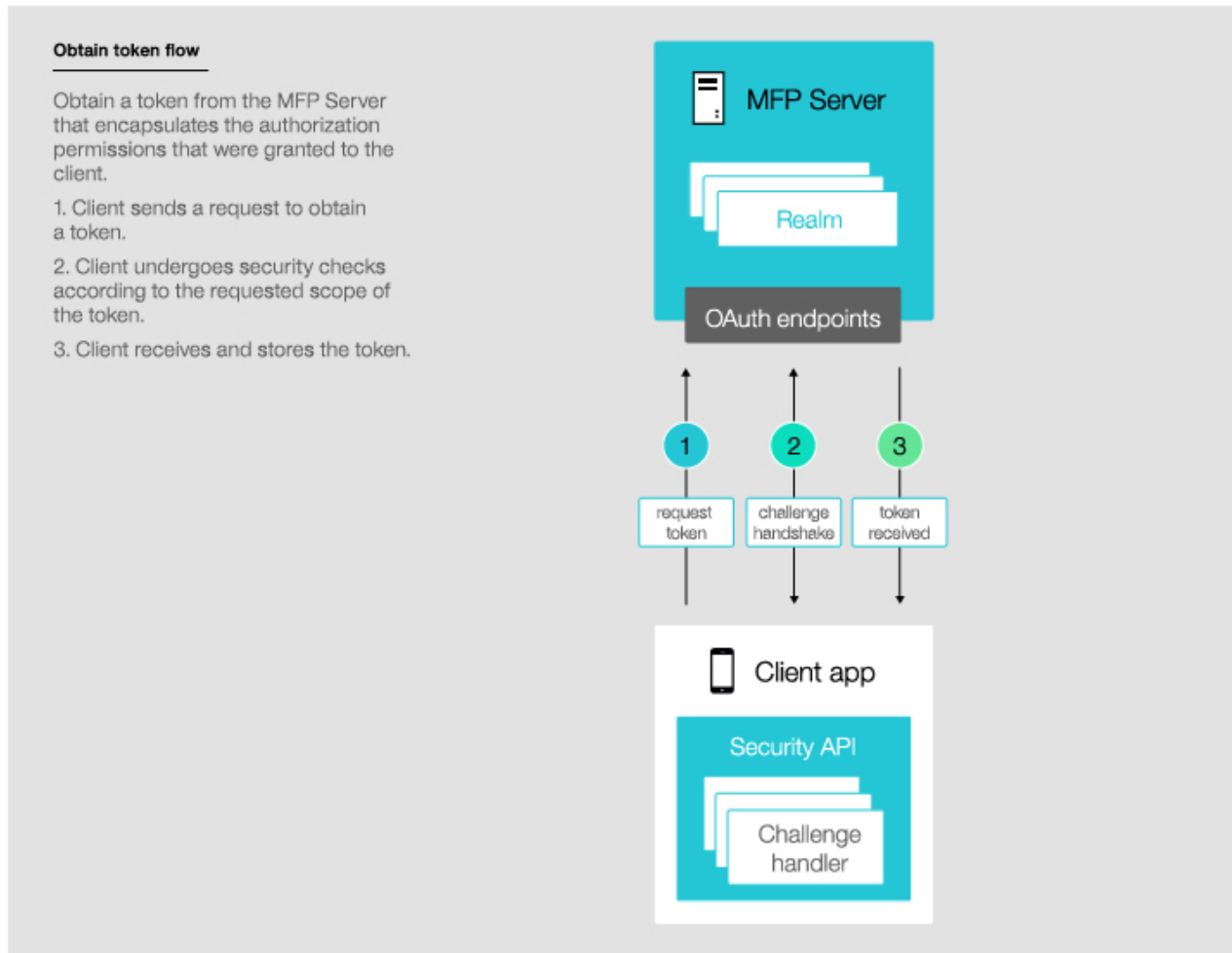

Figure 8-25. Obtain token flow

2. Using a token to access protected resources: Protected resources can run on the MobileFirst Server (see Figure 2) or on external servers (see Figure 3). Resources on external servers can be protected by using the validation modules that are provided with MobileFirst: the Node.js validation module for protecting Node.js resources and the Trust association interceptor (TAI) for protecting Java resources, or by developing your own custom filter as shown in the Token validation endpoint example. These modules validate the access token and ID token in incoming requests, making sure that only authorized clients are served. To consume such protected resources, the client has to first acquire the token from the MobileFirst Server, and then add the tokens as an authorization header to outgoing requests.

The new client APIs enable the client to access protected resources while transparently handling the handshake with the authorization server.

### Protecting MFP resources

RESTful adapters are protected by OAuth-based security.

1. Client sends a request with the authorization header (token).
2. Validation module validates the token.
3. Validation module proceeds to adapter invocation.

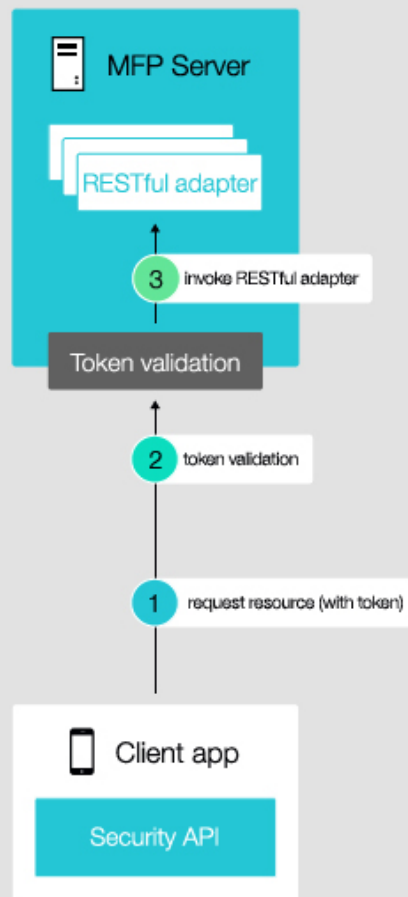

Figure 8-26. Protecting a resource on the MobileFirst Server

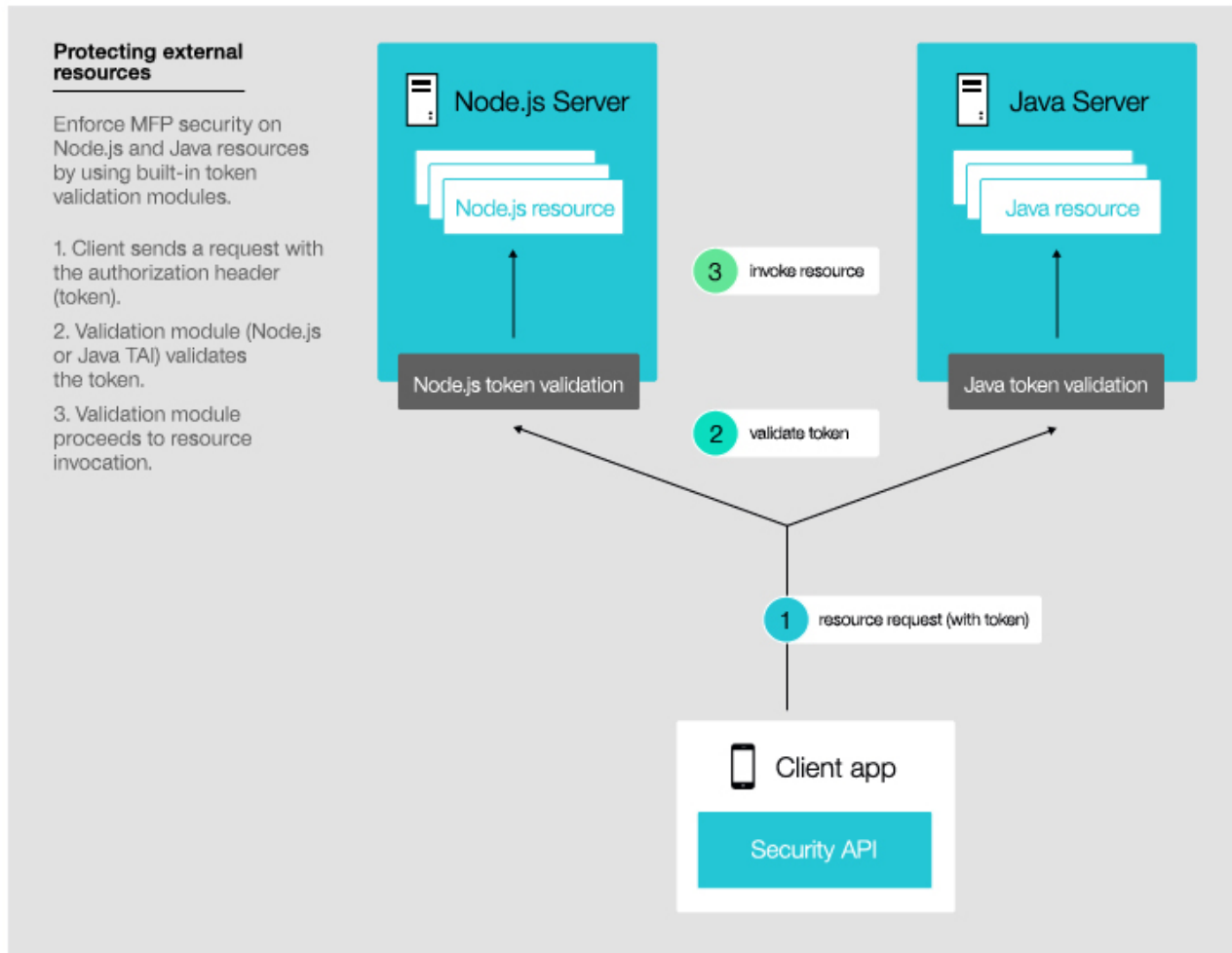

Figure 8-27. Protecting a resource on an external server

## Protecting resources with OAuth-based security

It is possible to enforce MobileFirst security on resources running on the MobileFirst Server, as well as on resources running on any, external resource server. MobileFirst V7.0 provides several types of validation modules to enforce security on resources. These modules perform the following validation logic:

- Integrity: Digital signature for both ID token and access token is verified.
- Token expiration: Both tokens are tested for expiration. An expired token will fail the validation.
- Scope: Required scope for the resource is verified. The token has to contain the scope tokens (realm names) that are defined in the scope, and these scope tokens have to be valid (meaning, not expired).
- Mandatory scope: In addition to the scope defined by the resource, the access token must contain the valid scope that is required by the application. This scope contains the realms, which are defined in the security test that is protecting the application.

Note that each scope token (realm name) has its own expiration time, which can be different than the expiration time of the containing access token. To pass validation, both a scope token and its containing token must not be expired. The expiration period of a scope token (realm name) is defined by the expiration

attribute of the login module that is associated with the realm. For more information about configuring expiration of login modules, see “Configuring login modules” on page 8-282. For information about configuring access token expiration, see Application descriptor of iOS applications.

Consider the following example: a resource `/somePath/myResource/doSomething` is protected by the scope `{myCustomRealm myLoginRealm}`. All requests to this resource will be intercepted by the validation module, so a valid token with a scope that contains `myCustomRealm` and `myLoginRealm` must be present in the request. In case such a token exists, the request is granted, and the resource is consumed. Otherwise, the validation module rejects the request. In this case, the client (through the client API) interacts with the MobileFirst Server to obtain the token, which requires successful authentication to the specified realms. After acquiring the token, the client resends the request, which now passes the token validation, and the resource is consumed.

#### **Protecting internal resources - RESTful adapters**

MobileFirst V7.0 enables you to enforce MobileFirst security on resources that are running on the MobileFirst Server, that is, Java and JavaScript RESTful adapters. For more information, see Security configuration of a JAX-RS resource.

#### **Protecting external resources**

With MobileFirst V7.0, you can enforce MobileFirst security on resources running outside the MobileFirst Server. To this end, you can use the built-in Node.js and Java validation modules, or implement your own custom validation module in the technology of your choice, using the online validation endpoint:

##### **Node filter**

The `passport-mfp-token-validation` module provides a passport validation strategy for protecting apps on a Node.js server. For more information, see “Protecting resources on Node.js servers” on page 8-230.

##### **TAI filter**

You can use the IBM MobileFirst™ Platform Foundation OAuth trust association interceptor (TAI) to protect application resources on WebSphere® Application Server or WebSphere Application Server Liberty. For more information, see “Protecting resources on WebSphere Application Server or WebSphere Application Server Liberty” on page 8-232.

##### **Custom filter**

The token validation endpoint on the MobileFirst Server validates tokens that are issued by the authorization server. For more information, see “Protecting resources with the token validation endpoint” on page 8-238.

### **Specifying the user identity realm in OAuth-based flows**

Although user authorization may include authorization with several realms, only one of these realms is defined as the user identity realm, and that realm determines the user identity. In an OAuth-based flow, the user identity realm is set according to the `userIdentityRealms` definition in the application descriptor. Note that in the classic (pre-V7.0) flows, the user identity realm is selected according to the definition in the security test. See `customSecurityTest`. In OAuth-based flows, information about the user identity, which is set by the `userIdentityRealms`

attribute, is part of the data contained in the “ID token” on page 8-229.

## Combining classic and OAuth-based security models

MobileFirst Server V7.0 provides a smooth integration between the classic and OAuth-based security models.

Essentially, both flows share the same security context on the server side, and so any security state of a specific realm (such as expiration, or login status) is consistently shared between the flows. This allows you, the developer, to mix classic and OAuth-based security APIs, while providing a unified experience for the end user.

Consider, for example, a client application that calls an adapter procedure protected by some realm myCustomRealm and then retrieves a token for a scope that includes the same realm. In this case, the user will have to pass the myCustomRealm security check only on the first call, and will get the relevant token on the second call, without having to re-authenticate.

Some issues need to be considered when using both models in the same flow, or on the same resource:

- Device SSO:

The configuration of the Device SSO feature is based on the device and user identity realms that are defined in the security test, which is protecting the resource. However, OAuth resources are not protected by security tests and do not have a single defined user realm per resource, so the standard MobileFirst device SSO behavior does not apply to them. For more information, see “Device single sign-on (SSO)” on page 8-294..

- The login/logout API:

The WLClient login/logout API enables a user to log in to and log out of a specific realm, by updating the server side security state. However, in the new OAuth-based security model, security credentials are also kept in the access token on the client side. The result is that using this API will cause an inconsistent state, for example, in which the client is logged out of a realm on the server side but still holds a valid token for that realm on the client side. To solve this inconsistency, it is recommended to re-obtain the access token, by using the obtainAuthorizationHeaderForScope method, after successful login or logout.

For example, consider a client that passed the security checks for Realm1 and Realm2, and later calls logout(Realm2). In this case, the access token on the client would still contain the security credentials for both Realm1 and Realm2, and the client could use this token to access protected resources. To refresh the token, that is, to obtain a token for Realm1 only, the client calls obtainAuthorizationHeaderForScope without the logged out realm Realm2.

iOS example:

```
[[WLClient sharedInstance]logout:@"MyRealm" withDelegate:self];

-(void)onSuccess:(WLResponse *)response{
    // re-obtain the token
    [[WLAuthorizationManager sharedInstance]obtainAuthorizationHeaderForScope:nil completionHandler:^(WLResponse *response, NSError *error) {
        // successful logout logic
    }];
}
```

## Test token endpoint

The test token endpoint enables you to get a valid token via a REST call, without having to set up a mobile client. For more information, see “The test token endpoint” on page 8-241.

## Public key endpoint

The public key endpoint gets the server's public key. The public key is used, for example, for the verification of digitally signed OAuth tokens. The path for the endpoint is as follows:

```
/authorization/v1/publickey
```

The endpoint returns the public key information using the JWK standard format. For more information, see JSON Web Key. The following is an example of a result returned by this endpoint:

```
{
  "e": "AQAB",
  "n": "AM0Dd7xAdv6H-ygL7r8qCLdE-3I2kk45zgZtDd_qs8fvnYfdiqTSV4_2t60GG8CV5Ce41PMpIwmL410X9IZnv
hxoYiFcMSaOeIqoe-rJA0uZuw2rHhXZ3WVCeKezRVcCOYsQN-mQK0mfz5_3o-ev0UYwXkS0wBB11Ehq
IwVDwOieg2JMG10EXsPZfkNZI-HU4oMi i-TrNLzRWkMmLvm09hL5zosUNA15veCKph2WpmSm2S61nDhH7gLEoymDnTEjPY5Aoh2i
nI-36RGYVMUUb046CrNUYuIob0iXlLzBIhuICpfVdxT_x7stKX5C9BFMTB4GkOHP5cUv7Nz1dDhIPu8",
  "kty": "RSA"
}
```

**Note:** The server uses an RSA key type, and therefore the kty attribute is always RSA.

## Preview mode

The new OAuth-based flows are also available in preview mode. However, in this mode, the registration phase is protected by an anti-cross site request forgery realm, wl\_antiXSRFRealm, and not application authenticity.

**Note:** Preview mode is not available in production environments.

## Exposed endpoints

You can enable white- and blacklists to the endpoints of the MobileFirst Server. For a list of endpoints for use with the OAuth-based security model, see “Endpoints of the IBM MobileFirst Platform Server production server” on page 6-272.

## Security client APIs

MobileFirst V7.0 provides client APIs that conform to the new OAuth-based security model.

- There is an API for consuming protected resources, which transparently supports the interaction with the MobileFirst Server (obtaining the token requested by the resource).
  - In Objective-C: WLResourceRequest
- In addition, APIs are provided to create a custom client implementation that is able to interact with the validation modules and MobileFirst Server. See the following example:
  - “Custom requests to resources using Objective-C” on page 8-242

## OAuth-based tokens

Learn about token response, MobileFirst Server authorization headers, access tokens, and ID tokens.

### Access token

The access token is a digitally signed token that describes the authorization permissions of a client. The token contains the following noteworthy attributes:

- **expiration:** Expiration of the access token in seconds. An expired token is not valid.
- **scope:** Scope of the authorization permissions of this token. The scope comprises a list of scope tokens.
- **scope tokens:** Scope tokens are mapped to MobileFirst realms (a scope token is the name of a MobileFirst realm). Each such scope token represents a successful authentication that the client has undergone during the authorization phase. Each scope token has an expiration of its own (in seconds).

### ID token

The ID token is a digitally signed token, implementing the OIDC specification. It contains information about the device, application, and user identity. The device and application identity are defined in the registration phase and are always present in the ID token. The user identity is defined according to `userIdentityRealms`, as described in The application descriptor. In case there is no such realm defined, the ID token contains no user identity, meaning that the user is “anonymous”.

To learn more about using the data in the ID token, see [Protecting resources on WebSphere Application Server](#) or [WebSphere Application Server Liberty](#), [“Protecting resources on Node.js servers”](#) on page 8-230, [“Protecting resources with the token validation endpoint”](#) on page 8-238, and [“Implementing the adapter's JAX-RS service”](#) on page 8-87.

### MobileFirst Server authorization header

After the client has acquired an access token, it can use the token in requests to protected resources. As described in the OAuth 2.0 Bearer Token Usage specification, the client uses the “Bearer” authentication scheme to transmit the access token in the authorization HTTP header. The following is an example of the value of the authorization header:

```
Authorization: Bearer yI6ICJodHRwOi8vc2VydmVyLmV4YW1...
```

### Successful token response

The access token and ID token are generated in the token endpoint after the authorization phase and sent to the client.

A successful token response from the MobileFirst authorization server looks like this:

```
HTTP/1.1 200 OK
Content-Type: application/json
Cache-Control: no-store
Pragma: no-cache
{
  "token_type": "Bearer",
  "expires_in": 3600,
```

```

"access_token": "yI6ICJodHRwOi8vc2VydmlvLmV4YW1...",
"id_token": "eyJhbGciOiJSUzI1NiIsImtpZCI6Ij...",
"scope": "wl_directUpdateRealm wl_remotedisableRealm wl_antiXSRFRealm wl_deviceNoProvisioningRealm wl_anonymousUserRealm"
}

```

**Note:**

- `token_type` is always "Bearer", as defined in the OAuth 2.0 Bearer Token Usage specification.
- `expires_in` is the expiration time of the access token, in seconds.
- `scope` is the list of the scope tokens (realms) that is included in the access token.

## Protecting external resources

You can protect application resources that are located on WebSphere Application Server, WebSphere Application Server Liberty or Node.js servers by using OAuth security.

### Protecting resources on Node.js servers:

You can protect your resources that are running on Node.js servers with OAuth-based IBM MobileFirst Platform Foundation for iOS security.

### mfpStrategy

The `passport-mfp-token-validation` npm module provides a passport validation strategy and a verification function to validate access tokens and ID tokens that are issued by the MobileFirst server.

```
passport.use (new mfpStrategy(options));
```

The **options** parameter contains one or more of the following options:

- **publicKeyServerUrl:** (Mandatory) Specifies the URL of the MobileFirst Server from which the public key will be retrieved to verify the tokens.

**Note:** Alternatively, you can pass the public key server URL as a parameter to the `passport.authenticate` method. (This method is used in the Example.)

- **scope:** Space-separated string to define the list of realm names that are required for accessing the resource. If no scope is specified, only the mandatory scope will be checked in the token.

**Note:** Alternatively, you can pass the scope as a parameter to the `passport.authenticate` method. (See Example.)

- **cacheSize:** The maximum number of tokens allowed. The default value is 500.
- **logger:** Defines a logger instance. The default value is the IBM default logger, which outputs log messages to the console.
- **analytics.onpremise:**
  - **url:** The url that specifies the location of the operational analytics server. For example, `http://localhost:10080/worklight-analytics-service/data`.
  - **username:** The username if credentials are required.
  - **password:** The password if credentials are required.

For more information on npm passports, see Passport Readme. For more information about the **passport.authenticate** method, see Authenticate.



## Example

The following example shows how to use **mfpStrategy** in a node application:

```
var express = require('express'),
    passport = require('passport-mfp-token-validation').Passport,
    mfpStrategy = require('passport-mfp-token-validation').Strategy;
//the configuration ('config') is optional if you wish to report
//events to the Analytics Server.
var config = {
  url : 'http://localhost:10080/worklight-analytics-service/data'
  username : 'admin',
  password : 'admin'
};

passport.use(new mfpStrategy({publicKeyServerUrl:'http://localhost:10080/WLProject',
analytics : {onpremise: config}}));

var app = express();
app.use(passport.initialize());

// protect api with MFP strategy using scope Realm1 Realm2 Realm3
app.get('/v1/apps/:appid/service', passport.authenticate('mobilefirst-strategy',
  {session: false , scope: 'Realm1 Realm2 Realm3' } ),
  function(req, res){
    res.send(200, req.securityContext);
  }
);

app.listen(3000);
```

To start the example, issue the following commands:

```
$ npm install express
$ npm install passport
$ npm install passport-mfp-token-validation
```

## Token verification

The `passport-mfp-token-validation` module verifies the authorization header of the request. The authorization header consists of the following elements:

*Bearer Access\_token ID\_token*

where

**Bearer** (Mandatory) Is the required string for the token type, as defined in the OAuth 2.0 specification.

*Access\_token*

(Mandatory) Encapsulates all of the security checks that the client has passed in the authorization phase.

*ID\_token*

(Optional) Contains information about the user and device identity of the client.

*Bearer* and *Access\_token* are mandatory. *ID\_token* is optional. The `passport-mfp-token-validation` module will verify the token with the public key that is retrieved from the authorization server. If the token is verified successfully, the `securityContext` and `user` objects will be attached to the request object.

## **securityContext**

After a successful validation, a security context object is added to the current request.

The securityContext object contains the following fields:

- **imf.sub**: The **sub** value of the ID token or the unique ID of the client if there is no ID token.
- **imf.user**: The **user** value that is extracted from the ID token. If there is no ID token, this field holds a blank object.
- **imf.device**: The **device** value that is extracted from the ID token. If there is no ID token, this field holds a blank object.
- **imf.application**: The **application** value that is extracted from the ID token. If there is no ID token, this field holds a blank object.

**user** The user object in the request is returned by the passport framework. Its value is the same as the value of `imf.user` in the securityContext object.

## Protecting resources on WebSphere Application Server or WebSphere Application Server Liberty:

You can protect your resources that are running on WebSphere Application Server or WebSphere Application Server Liberty servers with OAuth-based IBM MobileFirst Platform Foundation for iOS security.

### Overview

To enable MobileFirst OAuth security for resources on WebSphere Application Server or WebSphere Application Server Liberty servers, complete the following steps:

1. Configure OAuthTAI
2. Set the security role
3. Install and configure OAuthTAI on the server
4. Add the tokens to the authorization header
5. Use the security context to access resources

### Configure OAuthTAI

The OAuthTAI feature is configured by using XML. For WebSphere Application Server Liberty, you add the XML to the `server.xml` file. For WebSphere Application Server, you save it in a separate file.

The OAuthTAI element is the root element. The following sections describe the OAuthTAI attributes and subelements:

#### OAuthTAI attributes

##### cacheSize

(Optional) Maximum number of tokens allowed. The default is 500.

#### OAuthTAI subelements

##### securityConstraint

(Mandatory) The value of `securityConstraint` must be a number 1 to *n*.

##### securityConstraint attributes

##### securedURLs

(Mandatory) If multiple URLs are specified in `securedURLs`, separate each URL by a space. The following types of URLs are supported:

- Exact match URL. For example, `/context-root/a/xyz`
- Path match URL. For example, `/context-root/*`
- Wild card match URL. For example, `/context-root/*/xyz`

### **httpMethods**

(Optional) Default value: ALL. The `httpMethods` attribute is case insensitive. Its value can be one or more of the following strings: ALL, DELETE, GET, POST,PUT,HEAD,OPTIONS,TRACE, or CONNECT. If multiple methods are specified, separate the methods by a space.

### **scope**

(Optional) If `scope` is not specified, the only checking that is done is to make sure that the mandatory scopes are not expired.

The following is an example:

```
<?xml version="1.0" encoding="UTF-8"?>
  <OAuthTAI>
    <securityConstraint httpMethods="GET POST" securedURLs="/mfp-oauth-java-tests/*"
      scope="Realm1 Realm2"/>
    <securityConstraint httpMethods="DELETE" securedURLs="/another-context-root/*"/>
  </OAuthTAI>
```

### **Set the security role**

To protect the web resources used by your application, you must specify `TAIUserRole` as the Java Platform, Enterprise Edition (Java EE) security role. You can specify `TAIUserRole` as the Java EE security role in one of two ways: in the `web.xml` file or as an annotation.

To specify the `TAIUserRole` in the `web.xml` file, define `TAIUserRole` in the `security-role` element, and then use this role to secure the web resource in the `security-constraint` element. For example:

```
<security-constraint>
  <web-resource-collection>
    <web-resource-name>BaseServlet</web-resource-name>
    <url-pattern>/Test/devices</url-pattern>
  </web-resource-collection>
  <auth-constraint>
    <role-name>TAIUserRole</role-name>
  </auth-constraint>
</security-constraint>
<security-role id="SecurityRole_TAIUserRole" >
  <description>This is the role that MFP OAuthTAI uses to protect the resource. It must be mapped to 'All Authenticated in Application' in WAS and to 'ALL_AUTHENTICATED_USERS' in Liberty.</description>
  <role-name>TAIUserRole</role-name>
</security-role>
```

To specify `TAIUserRole` with an annotation:

```
@WebServlet("/Test/devices")
@ServletSecurity(@HttpConstraint(rolesAllowed={"TAIUserRole"}))
public class BaseServlet extends HttpServlet {
    // servlet code ...
}
```

## Install and configure OAuthTAI in WebSphere Application Server or WebSphere Application Server Liberty

### Installing OAuthTAI in WebSphere Application Server Liberty

1. Copy the file *product\_install\_dir*/WorklightServer/external-server-libraries/com.ibm.worklight.oauth.tai\_1.0.0.jar to *usr/extension/lib*, where

*product\_install\_dir*  
is the installation directory for MobileFirst Server.

*usr* is the user directory for the WebSphere Application Server Liberty profile (default name *usr*).

2. Copy the file *OAuthTai-1.0.mf* from the directory *WorklightServer/external-server-libraries* to the directory *usr/extension/lib/features*.
3. Edit the *server.xml* file to add the OAuthTAI -1.0 feature. For example:

```
<featureManager>
  <feature>appSecurity-2.0</feature>
  <feature>usr:OAuthTai-1.0</feature>
  <!--other necessary features-->
</featureManager>
```

4. Edit the *server.xml* file to add the OAuthTAI feature. Note that the security role *TAIUserRole* is mapped to a special subject named *ALL\_AUTHENTICATED\_USERS*. For example:

```
<usr_OAuthTAI id="myOAuthTAI">
  <securityConstraint httpMethods="GET POST" securedURLs="/worklight-oauth-java-tests/*"
    scope="Realm1 Realm2"/>
  <securityConstraint httpMethods="DELETE" securedURLs="/another-context-root/*"/>
</usr_OAuthTAI>

  <basicRegistry id="basic" realm="BasicRealm" />

  <application type="war" id="basicauth" name="basicauth" location="${server.config.dir}/apps/basicauth.war">
  <application-bnd>
  <security-role name="TAIUserRole">
    <special-subject type="ALL_AUTHENTICATED_USERS" />
  </security-role>
  </application-bnd>
</application>
```

5. Add the URL to the authorization server into the environment variables of your deployment. One way of doing so is to add the entry into the *server.env* file, which is located in the same directory as the *server.xml* file. Add the following, where

```
publicKeyServerUrl=URL_to_authorization_server.
```

*URL\_to\_authorization\_server* is the URL to the MobileFirst authorization server.

### Installing OAuthTAI in WebSphere Application Server

1. Copy *project\_root\_dir/target/com.ibm.worklight.oauth.tai\_1.0.0.jar* to *product\_install\_dir/lib/ext*.
2. Open the WebSphere Application Server console.
3. Click **Security > Global Security > Authentication**, and select **Enable LTPA**.
4. Click **Security > Global Security > Application security > Enable application security**.
5. Configure the trust association.

- a. Click **Security > Global Security > Web and SIP security > Trust association**.
- b. Click **Enable trust association**.
- c. Under **Interceptors**, click **New**, and create a new interceptor with the following values:
  - **Interceptor class name:** `com.worklight.oauth.tai.OAuthTAI`
  - **Custom properties:** `configFileLocation = OAuthTAI_config_file_dir/filename.xml`  
 where  
`OAuthTAI_config_file_dir/filename.xml` is the directory path and file name of the XML configuration file that you already created. See the configuration file example .

6. Create an environment entry that points to the authorization server.
  - a. In the WebSphere Application Server console, click **Servers > Server Types > WebSphere application servers > your\_server\_name > Server Infrastructure > Java and Process Management > Process Definition > Additional Properties > Environment Entries**.
  - b. Create the following environment variable:

`publicKeyServerUrl=authorization_server_URL`

where

`authorization_server_URL`

is the URL to the MobileFirst authorization server.

7. Map the security role.
  - a. In the WebSphere Application Server console, click **Applications > Application Types > WebSphere enterprise applications > your\_application\_name > Details Properties > Security role to user/group mapping**.
  - b. Map the role that is allowed to access your application to **All Authenticated in Application's Realm**. (For example, `TAIUserRole` as in sample above.)
8. Restart WebSphere Application Server.

### Add the tokens to the authorization header of your request

Add the following line to the authorization header of your request:

`Authorization: Bearer Access_token ID_token`

where

**Bearer** (Mandatory) Is the required string for the token type, as defined in the OAuth 2.0 specification.

`Access_token`

(Mandatory) Encapsulates all of the security checks that the client has passed in the authorization phase.

`ID_token`

(Optional) Contains information about the user and device identity of the client.

When the application attempts to access resources protected by OAuth TAI, the following validation checks occur:

Validation item	Result if invalid
The authorization header exists.	A 401 error is returned, with the response header WWW-Authenticate: Bearer realm="imfAuthentication", scope="{required_scopes_list}"
The authorization header starts with the string Bearer.	A 400 error is returned, with the response header WWW-Authenticate: Bearer realm="imfAuthentication", error="invalid_request", scope="{required_scopes_list}"
The signature of the access token and the ID token are valid and not expired, and they can be decoded.	A 401 error is returned, with the response header WWW-Authenticate: Bearer realm="imfAuthentication", error="invalid_request", scope="{required_scopes_list}"
Validation of scope. This includes the following: <ul style="list-style-type: none"> <li>• Verification of the scope in the access token.</li> <li>• Whether the mandatory scope is expired.</li> <li>• Whether the scope is expired.</li> <li>• Whether the access token contains all of the required realm names.</li> </ul>	A 403 error is returned, with the response header WWW-Authenticate: Bearer realm="imfAuthentication", error="insufficient_scope", error_description="{detail_information_of_error}.", scope="{required_scopes_list}"

### The security context object

After successful validation, a security context is available to your application. The security context is a JSON object that contains the following properties:

**Subject: `securityContext.get("imf.sub");`**

The subject is a string which uniquely identifies the application installation on a device and the authenticated user. uniquely identifies the application installation on a device and the authenticated user.

**User Identity: (Optional)`securityContext.get("imf.user");`**

The user identity is a JSON object which contains information about the authenticated user. For anonymous tokens, the user identity is null. The user identity contains the following properties:

- **"id"**: (Mandatory) The user identity of the authenticated user identity realm.
- **"authBy"**: (Mandatory): The name of the authenticated user identity realm.
- **"displayName"**: (Optional) The user's display name as set when authenticating the user identity realm. This property may be null.
- **"attributes"**: (Optional) Additional data that can be set when authenticating the user identity realm. This property may be null.

**Application information:`securityContext.get("imf.application");`**

Application information, including **"id"**, **"environment"**, and **"version"**. For example:

```
{"id":"com.MobileFirst.TestApp","environment":"iOSNative","version":"1.0"}
```

**Device information:`securityContext.get("imf.device");`**

Device information, including **"id"**, **"platform"**, **"model"** and **"osVersion"**. For example:

```
{"id":"E3D422A2-437C-438C-87FF-D6E7DF94725D","platform":"iOS","model":"iPhone Simulator","osVersion":"8.1"}
```

### Example

```

JSONObject securityContext = callerWLCredential.getSecurityContext();
String subject = securityContext.get("imf.sub");
JSONObject imfUser = securityContext.get("imf.user");
JSONObject imfDevice = securityContext.get("imf.device");
JSONObject imfApplication = securityContext.get("imf.application");

```

The WSCredential and WLCredential APIs provide credential functionality.

#### **com.ibm.websphere.security.cred.WSCredential**

The WSCredential interface defines a credential that represents an authenticated principal to WebSphere Application Server or WebSphere Application Server Liberty. For example:

```

Subject callerSubject = WSSubject.getCallerSubject();
WSCredential callerCredential = callerSubject.getPublicCredentials
(WSCredential.class).iterator().next();

```

For more information about WSCredential, see the WSCredential documentation for your version of WebSphere Application Server or WebSphere Application Server Liberty. For example, see WSCredential for WebSphere Application Server Network Deployment 8.5.

#### **com.worklight.oauth.tai.WLCredential**

The WLCredential interface provides APIs to get the MobileFirst specific principal details.

```

WLCredential callerWLCredential = callerSubject.getPublicCredentials
(WLCredential.class).iterator().next();

```

### **IBM MobileFirst Platform Foundation for iOS OAuthTAI in development mode**

In development mode, you can copy the jar and the manifest file from the following locations, depending on your development environment:

#### **MobileFirst Studio**

The root of every project contains a folder named `externalServerLibraries`. This folder contains both the TAI jar file (`com.ibm.worklight.oauth.tai_1.0.0.jar`) and the manifest file (`OAuthTai-1.0.mf`).

#### **MobileFirst Platform Command Line Interface for iOS**

The TAI jar file (`com.ibm.worklight.oauth.tai_1.0.0.jar`) and the manifest file (`OAuthTai-1.0.mf`) are located in the `CLI_install_dir/public` folder,

where

`CLI_install_dir`

is the path where MobileFirst Platform Command Line Interface for iOS is installed. Both files are also copied into the `/externalServerLibraries` folder in any new MobileFirst project created by the command-line interface.

### **Reporting analytics**

The Token lib library can report analytic events to IBM MobileFirst Platform Operational Analytics. You must configure the Resource Server that contains the Token lib with your Analytics URL and credentials.

The MobileFirst Operational Analytics server is protected by basic authentication. When you installed this server, you configured the data entry point and basic

authentication credentials. To configure the Resource Server, you must provide the Analytics credentials through JNDI properties, specifically the URL to the data entry point, the user name, and password. These properties are set with the following property names:

- imf.analytics.url
- imf.analytics.username
- imf.analytics.password

If your Resource Server is running on WebSphere Application Server Liberty, you must configure these properties by using JNDI by adding entries to your `server.xml` file. For example:

```
<jndiEntry jndiName="imf.analytics.username" value="admin"/>
```

If your Resource Server is running on WebSphere Application Server, you must configure these properties as Environment Entries. In the WebSphere Application Server Console, go to **Servers > Server Types > Websphere application servers > <your server> > Server Infrastructure > Java and Process Management > Process Definition > Additional Properties > Environment Entries > New**. This value is the location where you had to set `publicKeyServerUrl` when you set up OAuthTAI.

#### **Protecting resources with the token validation endpoint:**

The token validation endpoint on the IBM MobileFirst Platform Server validates tokens that are issued by the authorization server.

The token endpoint implements the OAuth 2.0 token introspection specification and validates access tokens and ID tokens. Using this endpoint, you can write a custom filter in any language to protect resources that are external to the MobileFirst Server. The filter delegates the token validation to the endpoint. An example of a custom filter in Node.js is shown at the end of this topic.



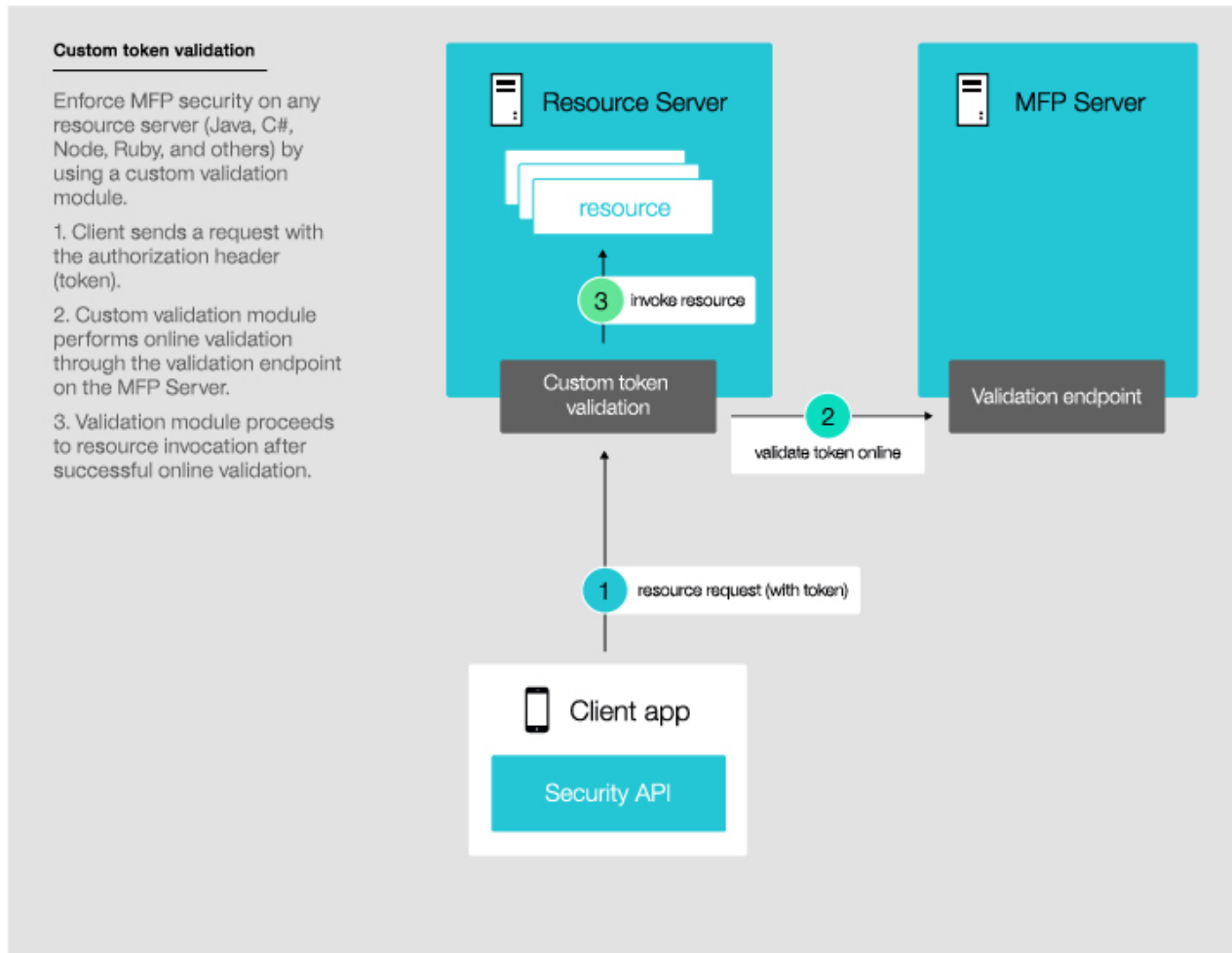

Figure 8-28. Custom token validation

The endpoint has the same processing logic as the built-in Node.js filter and TAI filter.

*Usage:* The URL pattern for accessing the endpoint is as follows:

`http(s)://<server_ip>:<server_port>/<project_name>/authorization/v1/token/introspection`

The endpoint responds to a POST request with the following parameters:

**token** Mandatory. The MobileFirst access token to be checked.

**id\_token**

Optional. The MobileFirst ID token to be checked.

**required\_scope**

Optional. If specified, the endpoint should ensure that the access token covers that scope.

*Response:* If the token validates successfully, the validation endpoint responds with a JSON object that is in application/json format and that has the following top-level members:

```
{
  "active": true,
  "exp" : timestamp,
```

```

    "scope" : "scope1 scope2 scope3",
    "user_id" : userid,
    "security_context" : securityContext,
  }

```

**active** Indicates whether the token is valid or not.

**exp** Indicates the expiration time of the token.

**scope** Indicates the scopes of the token.

**user\_id**

Indicates the unique identity of the token. If an ID token is provided, the value is a subfield of the ID token. If not, the value is the prn field in the access token.

**security\_context**

Contains the decoded information from the access token and ID token.

In case of validation failure, the response conforms to the OAuth 2.0 specification, meaning that the status is 40\* and WWW-Authenticate is added to the response header. The header looks like this:

```
WWW-Authenticate: Bearer realm="<realm name>", error="<error code>"[, error_description="<error description>"][, scope="<scope>"]
```

*Example:* The following example demonstrates a Node.js custom filter that uses the endpoint:

```

//Implementation of custom Filter
var express = require('express');
var http = require('http');
//For creating form-data queries
var querystring = require('querystring');
var app = express();

app.get('/resource/test0', function(req, res) {
  var authorizationHeader = req.headers["authorization"];
  //Authorization header - Bearer <accessToken> <idToken>
  var accessToken;
  var idToken;
  if(typeof authorizationHeader != 'undefined'){
    var tokenSplit = authorizationHeader.split(" ");
    accessToken = tokenSplit[0] + " " + tokenSplit[1];
    idToken = tokenSplit[2];
  }
  var form = {
    token : accessToken,
    idToken : idToken
  }

  var formData = querystring.stringify(form);
  var options = {
    hostname : "10.0.0.12",
    port : 10080,
    path : "/Test/authorization/v1/token/validation",
    method : 'POST',
    'Content-Type': 'application/x-www-form-urlencoded',
    'Content-Length': formData.length
  };

  var reqToWL = http.request(options, function(resFromWL) {
    resFromWL.on('data', function(introspectionData) {
      if(!introspectionData.active){
        console.log(JSON.parse(introspectionData));
        console.log("Token is invalid");
        var status = resFromWL.statusCode;
        var wwwAuthenticate = resFromWL.headers["www-authenticate"];

```

```

        //Set the header and send the response received from the MobileFirst server
        res.set("WWW-Authenticate",wwwAuthenticate);
        res.status(status).send();
    }else{
        console.log("Token is valid");
        var name = introspectionData.security_context.imf.user.displayName;
        //Send the response with the payload
        res.send({secretMessage:"hello "+name,payload:introspectionData});
    }
    });
});
reqToWL.on('error', function(e) {
    console.log('problem with request to WL server: ' + e.message);
});

// write data to request body
reqToWL.write(formData);
reqToWL.end();
});

app.listen(3000);
console.log("app is listening at " + 3000);

```

## The test token endpoint

The test token endpoint enables you to get a valid token via a REST call, without having to set up a mobile client.

The OAuth model that is used in IBM MobileFirst Platform Foundation for iOS requires a MobileFirst client API to be running in the mobile application that interacts with the MobileFirst Server to obtain the access token. Setting up the mobile app often means unnecessary overhead, particularly in back end testing situations. Use the test token endpoint to get a valid token through a REST call (by using tools such as Postman or cURL), without a mobile client.

**Note:** The test token endpoint is available only in the development version of IBM MobileFirst Platform Foundation for iOS.

## Usage

The endpoint provides a valid token with a default expiration of two hours and a scope that includes all the realms that are defined in your `authenticationConfig.xml` file.

The URL pattern for accessing the endpoint is as follows:

```
http(s)://<server_ip>:<server_port>/<project_name>/authorization/v1/testtoken
```

The endpoint responds to a POST request with the following parameters:

### accessTokenExpiration

Number of seconds for the token expiration.

### tokenFormat: Header/Token

Response format:

1. Header (default): returns a JSON object that can be copied directly to REST apps (such as Postman) as a header, for example:  
{Authorization: Bearer eyJhbG...}
2. Token: returns the OAuth token as defined by the spec:

```
{
  "scope": "SubscribeServlet wl_directUpdateRealm wl_authenticityRealm SampleAppRealm wl_remoteDisableRealm
wl_antiXSRFRealm wl_deviceAutoProvisioningRealm wl_deviceNoProvisioningRealm wl_anonymousUserRealm",
```

```

"token_type": "bearer",
"expires_in": 1421262002284,
"id_token": "eyJhbG...",
"access_token": "eyJhb.."
}

```

## Custom requests to resources using Objective-C

This sample illustrates how to get data from a protected resource by using a custom NSURLRequest and the MobileFirst AuthorizationManager API.

Inside the didReceiveResponse delegate, the authorizationManager determines whether this response is a MobileFirst protocol response. If so, the user gets the scope, obtains the authorization header for this scope, and requests the protected resource one more time.

```

-(IBAction)sendCustomRequestToResource:(id)sender {
    // The URL of the resource with filter
    NSString *nodeResourceString = @"http://localhost:3000/v1/apps/1234/test";

    // Create the first request to the resource - will fail due to authentication.
    NSURLRequest *request = [NSURLRequest requestWithURL:[NSURL URLWithString:nodeResourceString]];

    // Create url connection and fire request with a delegate
    NSURLConnection *conn = [[NSURLConnection alloc] initWithRequest:request delegate:self];
}

-(void) connection:(NSURLConnection *)connection didReceiveResponse:(NSURLResponse *)response{
    WLAAuthorizationManager *authorizationManager = [WLAAuthorizationManager sharedInstance];

    // Check that the response conforms to the MFP protocol
    if([authorizationManager isAuthorizationRequiredForResponse:response]){
        // Get required scope from response
        NSString *scope = [authorizationManager authorizationScopeForResponse:response];

        //Obtain authorization header for the scope
        [[WLAAuthorizationManager sharedInstance] obtainAuthorizationHeaderForScope:scope
        completionHandler:^(WLResponse *w1Response, NSError *w1Error) {
            if (!w1Error) {
                // Create the request.
                NSMutableURLRequest *mutRequest = [NSMutableURLRequest
                requestWithURL:[NSURL URLWithString:@"http://localhost:3000/v1/apps/1234/test"]];

                // Add the Authorization header that was obtained
                [mutRequest addValue:authorizationManager.cachedAuthorizationHeader forHTTPHeaderField:@"authorization"];
                NSError *requestError; // Error from resource (if any) will be here

                // Create URL connection and fire request with a delegate
                NSURLConnection *conn = [[NSURLConnection alloc] initWithRequest:mutRequest delegate:self];
            } else {
                // Error obtaining Authorization header from MFP Server
                NSLog(@"%@",[w1Error localizedDescription]);
            }
        }];
    }
    else{
        //This is the applicative response from the resource
        NSLog(@"Meta-data response from resource: %@",[response description]);
    }
}

```

## Classic security model

Topics that describe classic (pre-V7.0) security features in IBM MobileFirst Platform Foundation for iOS.

The following sections provide high-level information about the MobileFirst security model.

## Goals and structure of MobileFirst security framework

The MobileFirst security framework serves two main goals. It controls access to the protected resources, and it propagates the user (or server) identity to the back-end systems through the adapter framework.

It is key to the success of the application that the MobileFirst security framework does not include its own user registry, credentials storage, or access control management. Instead, it delegates all those functions to the existing enterprise security infrastructure. This delegation allows MobileFirst Server to integrate smoothly as a presentation tier into the existing enterprise landscape. Integration with the existing security infrastructure is an important feature of the MobileFirst security framework, and supports custom extensions that allow integration with virtually any security mechanism.

Another feature of the IBM MobileFirst Platform Foundation for iOS security framework is support of multi-factor authentication. It means that any protected resource can require multiple checks to control access. A typical example of multi-factor authentication is the combination of device, application, and user authentication.

Each type of security check has its own configuration, and a configured check is called a *realm*. Multiple realms can be grouped in a named entity that is called a *security test*. Each protected resource refers to the security test. All the configuration entities are defined in a single configuration file so that the definitions can be reused across different protected resources.

An implementation of security checks usually includes a client part and a server part. The two parts interact with each other according to their private protocol. This protocol is usually a sequence of 1) challenges that are sent by the server and 2) responses that are returned by the client.

The IBM MobileFirst Platform Foundation for iOS security framework provides a *wire protocol*. This protocol allows the combination of challenges and responses of multiple security checks during a single request-and-response round trip. The protocol serves two important purposes: it allows the number of extra round trips between the client and server to be minimized, and it separates the application logic and the security checks implementation.

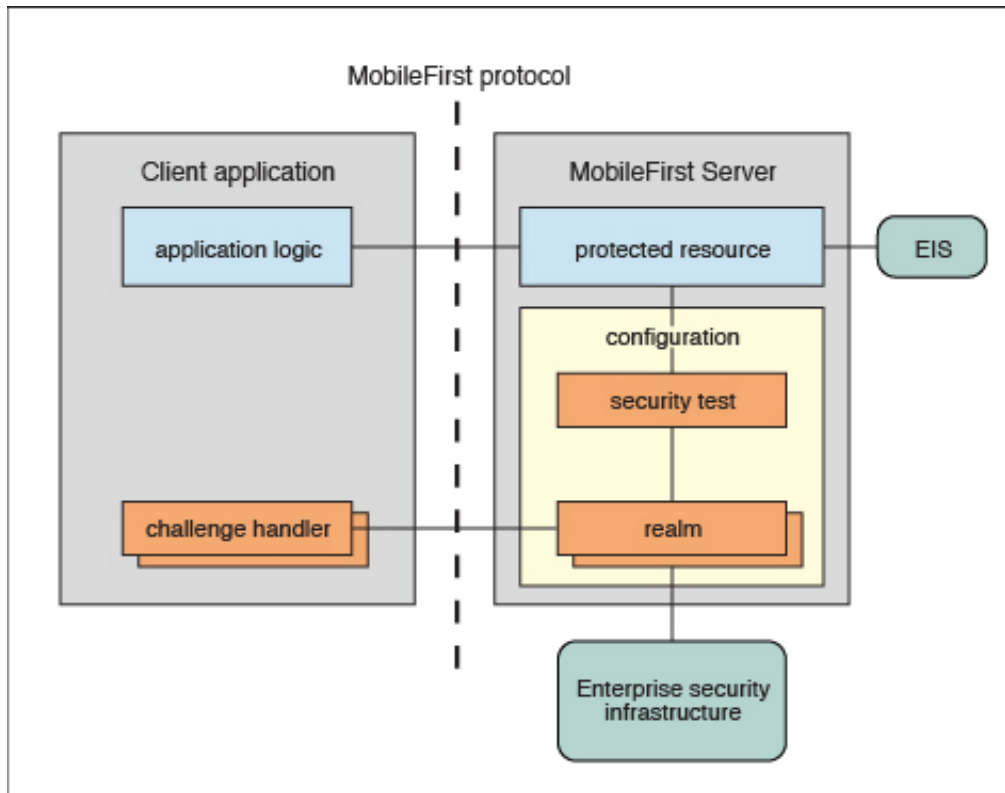

## Protected resources and authentication context

A protected resource can be any of the following items:

- **Application**  
Any request to the application requires successful authentication in all realms of the security test that is defined in the application descriptor.
- **Adapter procedure**  
Procedure invocation requires successful authentication in all realms of the security test that is defined in the adapter descriptor. The user identity and credentials that are obtained during such authentication can be propagated to the enterprise information system represented by this adapter.
- **Event source**  
Subscription to push notifications requires successful authentication in all realms of the security test that are defined in the event source definition (in adapter JavaScript).
- **Static resource**  
Static resources are defined as URL patterns in the authentication configuration file. They allow protection of "static" web applications such as the MobileFirst Operations Console.

During the session, an application can access different resources. The results of the authentication in different realms are stored in the session authentication context. These results are then shared among all of the protected resources in the scope of the current session.

## Realms and security tests

A realm represents a fully configured security check that must be completed before it can allow access to a protected resource. The semantics of the checks are not limited to the authentication, but can implement any logic that can serve as protection for the server-side application resources, for example:

- User authentication
- Device authentication and provisioning
- Application authenticity check
- Remote disable of the ability to connect to MobileFirst Server
- Direct update
- Anti-XSRF check (cross-site request forgery)

The realms are defined in the authentication configuration file on the MobileFirst project level. A realm consists of two parts: the *authenticator* and the *login module*. The authenticator obtains the credentials from the client, and the login module validates those credentials, and builds the user identity.

The realms are grouped into security tests, which are defined in the same authentication configuration files. The security test defines not only the group of realms, but also the order in which they must be checked. For example, it often makes sense not to ask for the user credentials until you make sure that the application itself is authentic.

Since some realms are relevant only to mobile or only to web environments, the configuration of a security test can be non-trivial. IBM MobileFirst Platform Foundation for iOS provides simplified security test configurations for mobile and web environments. It is also possible to create a custom security test from scratch.

## MobileFirst protocol and client challenge handlers

Each security check defines its own protocol, which is a sequence of challenges that are sent by the server and responses that are sent by the client. On the server side, the component that implements this private protocol is the *authenticator*. On the client side, the corresponding component is called the *challenge handler*.

When the client request tries to access a protected resource, MobileFirst Server checks all the appropriate realms. Several realms can decide to send a challenge. Challenges from multiple realms are composed into a single response and sent back to the client.

MobileFirst client infrastructure extracts the individual challenges from the response, and routes them to the appropriate challenge handlers. When a challenge handler finishes the processing, it submits its response to the MobileFirst client infrastructure. As an example, this occurs when the challenge handler obtains the user name and password from a login user interface. When all the responses are received, the MobileFirst client infrastructure resends the original request with all the challenge responses.

MobileFirst Server extracts those responses from the request and passes them to the appropriate authenticators. If an authenticator is satisfied, it reports a success, and MobileFirst Server calls the login module. If the login module succeeds in validating all of the credentials, the realm is considered successfully authenticated.

If all the realms of the security test are successfully authenticated, MobileFirst Server allows the request processing to proceed.

If a realm check fails, its authenticator sends another (or the same) challenge to the client, and the whole process repeats.

Combining multiple challenges and responses into a single response and request maximizes security efficiency by reducing the number of extra round trips. For example, the checks for device authentication, application authenticity, and direct update can be done in a single round trip.

The fact the MobileFirst client infrastructure automatically resends the original request with the challenge responses allows separation between the application logic and security aspects. Though any application request can result in a security challenge, the application logic must not include any special processing for that case. The challenge handlers are not related to the application context and can focus on the security-related logic.

## Integration with container security

MobileFirst Server is technically a web application hosted by an application server (such as WebSphere Application Server). Thus, it is often desirable to reuse authentication capabilities of the application server for MobileFirst Server, and vice versa. Since this task can be non-trivial, it is important to understand the differences between IBM MobileFirst Platform Foundation for iOS and Web Container authentication models:

- The Java Platform, Enterprise Edition model allows only one authentication scheme for a web application. Multiple resource collections are defined by URL patterns, with authentication constraints defined by a white list of role names.
- The MobileFirst model, by contrast, allows protection of each resource by multiple authentication checks, and the resources are not necessarily identified by the URL pattern. In some cases, authentication can be triggered dynamically during the request processing.

As a result, the authentication integration between MobileFirst Server and the Java Platform, Enterprise Edition container is implemented as a custom IBM MobileFirst Platform Foundation for iOS realm. This realm can interact with the container and obtain and set its authenticated principal.

MobileFirst Server includes a set of login modules and authenticators for WebSphere Application Server full profile and WebSphere Application Server Liberty profile that implement this integration with LTPA tokens. The integration works as follows:

- If the caller *principal* (an entity that can be authenticated) of the servlet request is already set, the container authentication was successful, and the same principal is set as the MobileFirst user identity. This case assumes that the MobileFirst WAR file has appropriate login configuration and resource collection definitions. Including this information can be tricky because the `web.xml` file for MobileFirst project is generated automatically, and those definitions would be overwritten in every build.
- If the incoming request contains a Lightweight Third Party Authentication (LTPA) token, the login module validates it, and creates the MobileFirst user identity.
- If the request does not contain an LTPA token, the authenticator requests the user name and password from the client. The login module validates them and



creates the MobileFirst user identity. In addition, it creates the LTPA token, and sends it back to the client as a cookie. In this case, the authentication capabilities of WebSphere Application Server are reused by MobileFirst realms in the form of Java utilities that implement validation and building of an LTPA token.

## Integration with web gateways

Web gateways like DataPower and IBM Security Access Manager provide user authentication so that only authenticated requests can reach the internal applications. The internal applications can obtain the result of the authentication that is done by the gateway from a special header, for example, an LTPA token.

When MobileFirst Server is protected by a web gateway, it means that the client requests first encounter the gateway. The gateway sends back a login form and validates the credentials, and if the validation is successful, submits the request to the MobileFirst Server. This sequence implies the following requirements on the MobileFirst security elements:

- The client-side challenge handler must be able to present the gateway's login form, submit the credentials, and recognize the login failure and success.
- The authentication configuration must include the realm that can obtain and validate the token that is provided by the gateway.
- The security test configuration must take into account that the user authentication is always done first. For example, there is no point in using the device single sign-on (SSO) feature because the user credentials are requested by the gateway.

Further information on security, as it is implemented in IBM MobileFirst Platform Foundation for iOS, is provided in the following overview of security features. There are links to the relevant sections of the documentation, which pertain to them.

## Integration with IBM Security Access Manager

IBM Security Access Manager can be integrated with IBM MobileFirst Platform Foundation for iOS to provide the following protections by using risk-based access decisions to protect MobileFirst applications and adapters as listed here:

- User authentication
- SSO
- Identity attributes
- Fine-grained authorization

SSO can be achieved to the mobile client and in adapter server connections. The context-based access policies can be defined to provide identity assurance and strong authentication with a one time password (OTP) for adapter-based transactions in IBM MobileFirst Platform Foundation for iOS and application authentication.

For more information about IBM Security Access Manager, see IBM Security Access Manager for IBM MobileFirst Platform Foundation for iOS.

## MobileFirst application authenticity overview

An overview of application authenticity features and procedures within IBM MobileFirst Platform Foundation for iOS

IBM MobileFirst Platform Foundation for iOS framework provides a number of security mechanisms. One of them is a security test for application authenticity. Most MobileFirst security mechanisms are based on the same concept: obtaining identity through challenge handling. Just as the user authentication realm is used to obtain and validate the identity of a user, an application authenticity realm is used to obtain and validate the identity of an application. Therefore, this process is referred to as *application authenticity*.

Any entity can access HTTP services (APIs) that are available from MobileFirst Server by issuing an HTTP request. Therefore, it is suggested that you protect relevant services with a number of security tests. Application authenticity makes sure that any application that tries to connect to MobileFirst Server is authentic and was not tampered with or modified by some attacker.

Starting with IBM MobileFirst Platform Foundation for iOS V7.0, you can enable one of three levels of authentication for your app: none, basic, and extended. For more information on enabling extended app authentication, see “Configuring extended app authenticity checking” on page 10-51. Extended application-authenticity validation is not supported for iOS apps that are installed from the Apple app store. See the Extended application authenticity for iOS known limitation.

### **Authenticity process**

Application authenticity checks use the same transport protocol as other MobileFirst authentication framework realms:

1. The application makes an initial request to MobileFirst Server.
2. MobileFirst Server goes through the authentication configuration and finds that this application must be protected by an application authenticity realm.
3. MobileFirst Server generates a challenge token and returns it to application.
4. The application receives the challenge token.
5. The application processes the challenge token and generates a challenge response.
6. The application submits the challenge response to MobileFirst Server.
7. If the challenge response is valid, MobileFirst Server serves the application with the required data.
8. If the challenge response is invalid, MobileFirst Server refuses to serve the application.

### **Authenticity considerations during migration to MobileFirst Server V7.0**

In versions prior to MobileFirst Platform Foundation V7.0, there was an option to control application authenticity from the MobileFirst Operations Console. This option is no longer available starting from V7.0. Existing applications configured with an authenticity realm and a security test in `authenticationConfig.xml` and a security test and security attributes in the `application-descriptor.xml` file are checked for authenticity at runtime when migrated to MobileFirst Server V7.0, ignoring any previous authenticity control mode that was specified in an older version of MobileFirst Operation Console.

### **Enabling an application authenticity check (example)**

The following example shows the steps for enabling application authenticity on iOS:

1. Modify the `authenticationConfig.xml` file to add relevant authenticity realms to your security tests:
  - If you use `<mobileSecurityTest>`, you must add the `<testAppAuthenticity/>` child element to this file.
  - If you use `<customSecurityTest>`, you must add `<test realm="wl_authenticityRealm"/>` child element to the file.

After you have updated your `authenticationConfig.xml` file, rebuild, and redeploy the `.war` file.

2. Modify the `application-descriptor.xml` file of your application.

**Remember:** In the `application-descriptor.xml` file, you must also define a security test. For more information, see “Security tests.”

3. After you have updated the required elements, rebuild and redeploy your application to MobileFirst Server.

## Security tests

A security test defines a security configuration for a protected resource. Predefined tests are supplied for standard web and mobile security requirements. You can write your own custom security tests and define the sequence in which they are implemented. In web and mobile security tests, you cannot define the sequence in which realms are processed. If you want to define the sequence, you must write your own custom security test and use the **step** property.

A security test specifies one or more authentication realms and an authentication realm can be used by any number of security tests. A protectable resource can be protected by any number of realms.

A protected resource is protected by a security test. When a client attempts to access a protected resource, IBM MobileFirst Platform Foundation for iOS checks whether the client is already authenticated according to all realms of the security test. If the client is not yet authenticated, IBM MobileFirst Platform Foundation for iOS triggers the process of authentication for all unauthenticated realms.

Before you define security tests, define the authentication realms that the tests use.

Define a security test for each environment in the `application-descriptor.xml` file, by using the property `securityTest="test_name"`. If no security test is defined for a specific environment, only a minimal set of default platform tests is run.

You can define three types of security test:

### **webSecurityTest**

A test that is predefined to contain realms that are related to web security.

Use a `webSecurityTest` to protect web applications.

A `webSecurityTest` must contain one `testUser` element with a realm definition for user authentication. The identity that is obtained from this realm is considered to be a user identity.

By default, a `webSecurityTest` includes protection against cross-site request forgery (XSRF) attacks.

### **mobileSecurityTest**

A test that is predefined to contain realms that are related to mobile security.

Use a `mobileSecurityTest` to protect mobile applications.

A `mobileSecurityTest` must contain one `testUser` element with a realm definition for user authentication. The identity that is obtained from this realm is considered to be a user identity.

A `mobileSecurityTest` must contain one `testDevice` element with a realm definition for device authentication. The identity that is obtained from this realm is considered to be a device identity.

By default, a `mobileSecurityTest` includes protection against XSRF attacks, automatic checking for Direct Updates every session, and the ability to remotely disable, from the MobileFirst Operations Console, the ability for the app to connect to MobileFirst Server.

### **customSecurityTest**

A custom security test. No predefined realms are added. Only tests that are included are tested.

Use a `customSecurityTest` to define your own security requirements and the sequence and grouping in which they occur.

You can define any number of tests within a `customSecurityTest`. Each test specifies one realm. To define a realm as a user identity realm, add the property `isInternalUserId="true"` to the test. The `isInternalUserID` attribute means that this realm is used for user identification for reporting and push subscriptions. There must be exactly one such realm for every security configuration that is applied to a mobile or web resource.

For a device auto provisioning realm, the `isInternalDeviceID` attribute means that this realm is used for device identification for reporting, push subscriptions, and device SSO features. There must be exactly one such realm for every security configuration that is applied to a mobile resource.

**Important:** When you use device auto provisioning in `customSecurityTests`, an authenticity realm must also be present within the tests, otherwise provisioning cannot succeed.

To specify the order in which a client must authenticate in the different realms, add the property `step="n"` to each test, where *n* indicates the sequence. If a sequence is not specified, then all tests are done in a single step.

**Note:** Application authenticity and Device provisioning are not supported in Java Platform, Micro Edition (Java ME).

### **Sample security tests**

This section describes what a `webSecurityTest` and a `mobileSecurityTest` contain.

The `webSecurityTest` contains:

- The following realms, enabled by default: `wl_anonymousUserRealm` and `wl_antiXSRFRealm`.
- The user realm that you must specify.

The `mobileSecurityTest` contains:

- The following realms, enabled by default: `wl_anonymousUserRealm`, `wl_antiXSRFRealm`, `wl_directUpdateRealm`, `wl_remotedisableRealm` and `wl_deviceNoProvisioningRealm`.
- The user and device realms that you must specify.

A customSecurityTest has no realms that are enabled by default. You must define all realms that you want your customSecurityTest to contain.

For a webSecurityTest:

```
<webSecurityTest name="webTest">
  <testUser realm="wl_anonymousUserRealm"/>
</webSecurityTest>
```

The equivalent as a customSecurityTest:

```
<customSecurityTest name="webTest">
  <test realm="wl_antiXSRFRealm" />
  <test realm="wl_anonymousUserRealm" isInternalUserId="true" />
</customSecurityTest>
```

For a mobileSecurityTest:

```
<mobileSecurityTest name="mobileTest">
  <testUser realm="wl_anonymousUserRealm"/>
  <testDeviceId provisioningType="none" />
</mobileSecurityTest>
```

The equivalent as a customSecurityTest:

```
<customSecurityTest name="mobileTest">
  <test realm="wl_antiXSRFRealm" />
  <test realm="wl_remoteDisableRealm" />
  <test realm="wl_anonymousUserRealm" isInternalUserID="true" />
  <test realm="wl_deviceNoProvisioningRealm" isInternalUserID="true" />
</customSecurityTest>
```

Usually, you add your own realm to your configuration to authenticate users. The following example shows a configuration where the realm named MyUserAuthRealm is the realm that the developer added.

### **Example with your own realm name as a realm definition for testUser:**

For a webSecurityTest:

```
<webSecurityTest name="webTest">
  <testUser realm="MyUserAuthRealm"/>
</webSecurityTest>
```

The equivalent as a customSecurityTest

```
<customSecurityTest name="webTest">
  <test realm="wl_antiXSRFRealm" />
  <test realm="MyUserAuthRealm" isInternalUserId="true" />
</customSecurityTest>
```

For a mobileSecurityTest:

```
<mobileSecurityTest name="mobileTest">
  <testUser realm="MyUserAuthRealm"/>
  <testDeviceId provisioningType="none" />
</mobileSecurityTest>
```

The equivalent as a customSecurityTest:

```
<customSecurityTest name="mobileTest">
  <test realm="wl_antiXSRFRealm" />
  <test realm="wl_remoteDisableRealm" />
  <test realm="MyUserAuthRealm" isInternalUserID="true" />
  <test realm="wl_deviceNoProvisioningRealm" isInternalUserID="true" />
</customSecurityTest>
```

## Authentication realms

Resources are protected by *authentication realms*. Authentication processes can be interactive or non-interactive.

An authentication realm defines the process to be used to authenticate users, and consists of the following steps:

1. Specification of how to collect user credentials, for example, by using a form, using basic HTTP authentication or using SSO.
2. Specification of how to verify the user credentials, for example, checking that the password matches the user name, or by using an LDAP server or some other authentication server.
3. Specification of how to build the user identity, that is, how to build objects that contain all the necessary user properties.

The same realm can be used in different security tests. In this case, clients must undergo the authentication process that is defined for the realm only once.

Authentication processes can be interactive or non-interactive, as demonstrated in the following authentication process examples:

- An example of interactive authentication is a login form that is displayed when a user attempts to access a protected resource. The authentication process includes verifying the user credentials.
- An example of non-interactive authentication is a user cookie that the authentication process looks for when a user attempts to access a protected resource. If there is a cookie, this cookie is used to authenticate the user. If there is no cookie, a cookie is created, and this cookie is used to authenticate the user in the future.

### User certificate authentication realm:

The user certificate authentication realm authenticates the user with X.509 certificates that are generated with the MobileFirst Server together with your public key infrastructure (PKI).

### Anti-cross site request forgery (anti-XSRF) realm:

The `wl_antiXSRFRealm` protects against cross-site request forgery attacks.

In a cross-site request forgery attack, unauthorized commands are transmitted from a web browser that is trusted by the targeted web site. To protect against this, IBM MobileFirst Platform Foundation for iOS provides an anti-cross site request forgery realm, `wl_antiXSRFRealm`. This realm is enabled by default in the `webSecurityTest` and the `mobileSecurityTest`.

The anti-XSRF realm is relevant only for web environments, when the application runs in a browser. It is not relevant for installed mobile applications. Also, the anti-XSRF realm does not protect against session hijacking.

The anti-XSRF technique is based on the same-origin constraint policy, which requires that after an initial request, all subsequent requests come from the same source as the initial one. A script that is loaded from a different origin is assumed to be an attacker script.

When a new session is initiated, the first request to MobileFirst Server receives an HTTP 401 ("Unauthorized") response that contains the `WL-Instance_Id` token. The

MobileFirst framework extracts this token and uses it as a header on all subsequent requests. If this header is not present in these subsequent requests, HTTP 401 is returned again, and access to resources is denied.

The server-side realm implementation ensures that each incoming request has the correct value in the WL-Instance\_Id header. If the header is missing or has an incorrect value, the realm again returns a 401 response with the challenge that contains the correct value for WL-Instance\_Id. However, due to the same-origin constraint policy, the targeted web site does not allow the attacking web site to read the challenge.

The server returns a challenge and does not destroy the session in the case of a missing or incorrect token because this situation can be a result of a legitimate use case. For example, if a session is timed-out on the server side, the client might send a request with an expired token. Or, a session race condition might occur in which the client sends two or more requests simultaneously when the session is not established or is timed out. A legitimate client should be able to recover from these situations automatically, so the server sends the same challenge in the case of failure.

For more information, see [Cross-site request forgery](#).

**Note:** If code that uses the anti-XSRF realm attempts to access a resource that is protected by OAuth authentication, and the client has a valid token, the MobileFirst Server is not called. As a result, the server does not check whether the request contains the header. The MobileFirst Server is called when the token expires or when the anti-XSRF realm inside the token expires. When the realm expires, the anti-XSRF authenticator is invoked and the server checks whether the request contains the header. For more information about OAuth authentication, see [MobileFirst OAuth-based security model](#).

---

## Simple data sharing

Learn about the Simple Data Sharing feature.

### Simple data sharing overview

Learn about the Simple Data Sharing feature.

The Simple Data Sharing feature makes it possible to securely share lightweight information among a family of applications on a single device. This feature uses native APIs that are already present in the different mobile SDKs to provide one unified developer API. This MobileFirst API abstracts the different platform complexities, making it easier for developers to quickly implement code that allows for inter-application communication.

This feature is supported on iOS applications.

After you enable the Simple Data Sharing feature, you can use the provided native APIs to exchange simple string tokens among a family of applications on a device.

When used with the MobileFirst device single sign-on (SSO) feature, the Simple Data Sharing feature enhances the ability of these features to share security credentials among applications in the same family. For example, you can share user authentication cookies among a family of applications to allow device SSO to work when a reverse proxy is used.

For more information about device SSO with a reverse proxy, see “Configuring device single sign-on with a reverse proxy” on page 8-299.

## Simple data sharing general terminology

Learn about simple data sharing general terminology.

### MobileFirst application family

An application family is a way to associate a group of applications which share the same level of trust. Applications in the same family can securely and safely share information with each other.

To be considered part of the same MobileFirst application family, all applications in the same family must comply with the following requirements:

- Specify the same value for the application family in the application descriptor.
  - For iOS applications, this requirement is synonymous to the access group entitlements value and the `wlAppFamily` value in the `worklight.plist` file.
- Applications must be signed by the same signing identity. This requirement means that only applications from the same organization can use this feature.
  - For iOS applications, this requirement means the same Application ID prefix, provisioning profile, and signing identity is used to sign the application.

Aside from the IBM MobileFirst Platform Foundation for iOS provided APIs, applications in the same MobileFirst application family can also use the data sharing APIs that are available through their respective native mobile SDK APIs.

### String tokens

Sharing string tokens across applications of the same MobileFirst application family can now be accomplished in native iOS applications through the Simple Data Sharing feature.

String tokens are considered simple strings, such as passwords or cookies. Using large strings results in considerable performance degradation.

Consider encrypting tokens when you use the APIs for added security. For more information, see “JSONStore security utilities” on page 8-184.

## Enabling the Simple Data Sharing feature

Learn how to enable the Simple Data Sharing feature.

### Enabling the Simple Data Sharing feature for iOS native applications

Update iOS native applications to enable the Simple Data Sharing feature.

#### Before you begin

For more information about how to develop iOS native applications, see “Developing native applications for iOS” on page 8-4.

**Note:** Only applications from the same organization can use this feature.



## About this task

To enable simple data sharing, you must modify your iOS native application.

### Procedure

1. Enable the Simple Data Sharing option by specifying the application family name in the `worklight.plist` file with the `wlAppFamily` property.
2. In Xcode, add a Keychain Access Group with the same name as your `wlAppFamily`.

The application-identifier entitlement must be the same for all applications in your family.

**Note:** By default, MobileFirst applications are part of the `worklight.group` access group that is defined in the entitlement property file. Ensure that this group continues to be the first group in the list.

3. Ensure that applications that are part of the same family share the same Application ID prefix. For more information, see [Managing Multiple App ID Prefixes in the iOS Developer Library](#).
4. Save and sign applications. Ensure that all applications in this group are signed by the same iOS certificate and provisioning profiles.
5. Repeat the steps for all applications that you want to make part of the same application family.

### Results

You can now use the native Simple Data Sharing APIs to share simple strings among the group of applications in the same family. For more information, see the [Simple Data Sharing Objective-C APIs in the WLSimpleDataSharing class](#).

## Simple data sharing API concepts

Learn about simple data sharing API concepts.

Sharing string tokens across applications of the same MobileFirst application family can be accomplished in iOS native applications. This API is meant for sharing simple strings securely.

The Simple Data Sharing APIs allow any application in the same family to set, get, and clear key-value pairs from a common place. The Simple Data Sharing APIs are similar for every platform, and provide an abstraction layer, hiding the complexities that exist with each native SDK's APIs, making it easy to use.

The following examples show how you can set, get, and delete tokens from the shared credential storage for the different environments.

### iOS native applications

```
[WLSimpleDataSharing setSharedToken: myName value: myValue];  
NSString* token = [WLSimpleDataSharing getSharedToken: myName];  
[WLSimpleDataSharing clearSharedToken: myName];
```

For more information about the native iOS APIs, see [WLSimpleDataSharing Class Reference](#).

## Troubleshooting simple data sharing

Find information to help resolve issues that you might encounter when you use the Simple Data Sharing feature.

*Table 8-18. Troubleshooting the Simple Data Sharing feature.* This table lists possible problems and actions to take to troubleshoot the Simple Data Sharing feature.

Problem	Actions to take
Unable to access shared data when you use the Simple Data Sharing APIs.	Ensure that all applications in the same family are all redeployed under the same MobileFirst application family name. For more information, see “Enabling the Simple Data Sharing feature” on page 8-254.
Unable to get MobileFirst device SSO to work with a reverse proxy.	<ol style="list-style-type: none"><li>1. Ensure that you enabled the Simple Data Sharing feature. For more information, see “Enabling the Simple Data Sharing feature” on page 8-254.</li><li>2. Ensure that all applications in the same family specified the necessary reverse proxy authentication cookie.</li></ol> For more information, see “Configuring device single sign-on with a reverse proxy” on page 8-299.
Unable to specify cookie or user certificate sharing.	You must first enable the MobileFirst Simple Data Sharing feature and specify a MobileFirst application family before you can enable device SSO or user certificate authentication sharing options. For more information, see “Enabling the Simple Data Sharing feature” on page 8-254.

## Simple data sharing limitations and special considerations

Learn about the limitations and special considerations of the Simple Data Sharing feature.

### Security considerations

Because this feature allows for data access among a group of applications, special care must be taken to protect access to the device from unauthorized users.

Consider the following security aspects:

#### Device Lock

For added security, ensure that devices are secured by a device password, passcode, or pin, so that access to the device is secured if the device is lost or stolen.

#### Jailbreak Detection

Consider using a mobile device management solution to ensure that devices in your enterprise are not jailbroken or rooted.

#### Encryption

Consider encrypting any tokens before you share them for added security. For more information, see “JSONStore security utilities” on page 8-184.

## Size limit

This feature is meant for sharing of small strings, such as passwords or cookies. Be cognizant not to abuse this feature, as there are performance implications with such attempts to encrypt and decrypt or read and write any large values of data.

---

## Authenticators and login modules

An authenticator collects client credentials. A login module validates them.

An *authenticator* is a server component which is used to collect credentials from the client. The authenticator passes the credentials to a *login module*, which validates them and builds a client identity object. Both authenticators and login modules are components of the application's *realm*.

An authenticator can, for example, collect any type of information accessible from an HTTP request object, such as cookies or any data in headers or the body of the request.

A login module can validate the credentials that are passed to it in various ways. For example:

- Using a web service
- Looking up the client ID in a database
- Using an LTPA token

A number of predefined authenticators and login modules are supplied. If these do not meet your needs, you can write your own in Java.

---

## Mobile device authentication

You can require mobile devices to authenticate themselves. Device identity is used in several places within IBM MobileFirst Platform Foundation for iOS. You can use provisioning, which is the process of obtaining a security certificate. There are three modes of the provisioning process.

### Unique device ID

The unique device ID is used by IBM MobileFirst Platform Foundation for iOS for device ID-related features, such as security, device SSO, reports, and push notifications.

#### On iOS

- To calculate the unique device ID, a globally unique ID (GUID) is used that is generated during device authentication process.
- The unique device ID can be unique either to the application or to all applications from the same vendor.
- The unique device ID is stored in the device keychain.

**Note:** The availability of the unique device ID depends on the operating system of the device, and on the application vendor. A vendor who provides multiple applications that can be installed on the same device might then choose whether to require provisioning for each individual application or for a group of applications. If several applications are from the same vendor, they can have the same unique device ID. If these applications are from different vendors, they have different unique device IDs.

To access the unique device ID on the device and on the MobileFirst back-end server, some security controls are performed. The device ID is not a secret data and can be passed to the server in one of the two following ways:

- As is, for a non-secure device authentication.
- Accompanied with credentials, for a secure device authentication. In that case, the device ID is digitally signed with a X509 certificate. This certificate results of the provisioning process that takes place the first time the application runs on the device.

The unique device ID is stored in the raw data reports that are generated by IBM MobileFirst Platform Foundation for iOS. There are no special access controls available on these reports, as the unique device ID is not considered sensitive data. For more information about raw data reports, see “Using raw data reports” on page 12-76.

For more information about mobile device provisioning, see the tutorials on the Getting Started page.

## Scope of mobile device authentication

In addition to requiring users to authenticate before they access certain resources, you can also require mobile devices to authenticate before apps installed on them can access the MobileFirst Server.

Device and application authentication is a process that allows making claims of type "this is application A installed on device D".

Device and application authentication is relevant only for applications that are installed on mobile devices.

## Mobile device provisioning

When a MobileFirst application first runs on a mobile device, it creates a pair of PKI-based keys. It then uses the keys to sign the public characteristics of the device and application, and sends them to the MobileFirst Server for authentication purposes.

A key pair alone is not sufficient to sign these public characteristics because any app can create a key pair. In order for a key pair to be trusted, it must be signed by an external trusted authority to create a certificate. The process of obtaining such a certificate is called *provisioning*.

When a certificate is obtained, the app can then store the key pair in the device keystore, access to which is protected by the operating system.

The provisioning process has three modes:

### No provisioning

In this mode, the provisioning process does not happen. This mode is usually suitable during the development cycle, to temporarily disable the provisioning for the application. Technically, the client application does not trigger the provisioning process, and the server does not verify the client certificate.

### Auto-provisioning

In this mode, the MobileFirst Server automatically issues a certificate for

the device and application data that is provided by the client application. Use this option only when the MobileFirst application authenticity features are enabled.

### **Custom provisioning**

In this mode, the MobileFirst Server is augmented with custom logic that controls the device and application provisioning process. This logic can involve integration with an external system, such as a mobile device manager (MDM). The external system can issue the client certificate based on an activation code that is obtained from the app, or can instruct the MobileFirst Server to do so.

**Note:**

## **Device auto-provisioning**

Device auto-provisioning has three aspects:

- Provisioning granularity: the scope of the provisioned entity.
- Pre required login: the realms that a client must be authenticated with before it can get permission to perform provisioning.
- CA Certificate: the parent certificate, which issues device certificates for the provisioning process.

The default behavior is as follows:

- Provisioning granularity: a single application.
- Pre required login: a login is required to the authentication realm, if any, defined for the current security test.
- CA Certificate: a MobileFirst CA Certificate, which is embedded into the platform.

Whether it is obtained by an auto-provisioning or custom provisioning process, the certificate is stored by the client app on the device, and used for signing the payload sent to the MobileFirst Server. The MobileFirst Server validates the client certificate, regardless of how it is obtained.

The server sends a request for ID, which the client responds to with a certificate-signed payload. If the client does not have the certificate, then a request is sent to the MobileFirst Server automatically to get a certificate, and after that is done, the client automatically sends the signed payload.

After the server sends the ok response, the original request is sent automatically.

## **Granularity of provisioning**

The key pair that is used to sign the device and app properties can represent a single application, a group of applications, or an entire device. For example:

### **Single application**

A company's provisioning process requires separate activation for each application that is installed on the device. In this case, the application is the provisionable entity, and each application must generate its own key pair.

### **Group of applications**

A company develops different groups of applications to employees in different geographical regions. If the activation is required per region, the

key pair would represent the group of applications that belong to that region. All applications from the same group use the same key pair for their signatures.

**Entire device**

In this case, the key pair represents the whole device. All the applications from the same vendor that are installed on that device use the same key pair.

---

## The authentication configuration file

All types of authentication component are configured in the authentication configuration file.

Authentication components, security tests, realms, login modules, and authenticators are all configured in the authenticationConfig.xml authentication configuration file, which is in the /server/conf directory of your MobileFirst project. A web security test or mobile security test must contain a **<testUser>** element that specifies the realm name. The definition of a realm includes the class name of an authenticator, and a reference to a login module, and refers to a collection of resource managers that recognizes a common set of user credentials and authorizations. Authenticators are the entities that authenticate clients. Authenticators collect client information, and then use login modules to verify this information.

Table 8-19. Predefined realms: properties of the **<test realm>** element.

Realm reference	Login module reference	Description
wl_anonymousUserRealm	WeakDummy	This realm is the default user realm. As having a user identity is mandatory for a user to use IBM MobileFirst Platform Foundation for iOS properly, use this realm if you do not require any special identification of users. This realm gives the user a random unique user ID to be used for various features in the server, such as reports and audit, identification of access to back-end systems, and push notification. This realm is transparent, that is, it does not require any user interaction.
wl_antiXSRFRealm	WLANtiXSRFLoginModule	This realm is used to avoid cross-site request forgery attacks. When a new session is initiated, the first request to MobileFirst Server gets an HTTP 401 response that contains the WL-Instance-Id token. The MobileFirst framework extracts this token and uses it as a header on all subsequent requests. If this header is not present in these subsequent requests, HTTP 401 is returned again. This security mechanism makes sure that all subsequent requests are coming from the same source as the initial one.

Table 8-19. Predefined realms: properties of the <test realm> element. (continued)

Realm reference	Login module reference	Description
<b>wl_authenticityRealm</b>	<b>wl_authenticityLoginModule</b>	This realm is used to verify that application is authentic and it was not modified by a third party. The basic authenticity check is based on certificates that are used to sign applications. Extended application authenticity is based on the application binary file.
<b>wl_deviceAutoProvisioningRealm</b>	<b>WLDeviceAutoProvisioningLoginModule</b>	The description of this parameter is the same as for <b>wl_deviceNoProvisioningRealm</b> , but the obtained device identity is automatically provisioned by the MobileFirst Server. This realm must be used with <b>wl_authenticityRealm</b> .
<b>wl_deviceNoProvisioningRealm</b>	<b>WLDeviceNoProvisioningLoginModule</b>	A default <i>device identity</i> realm. Device identity is similar to user identity, but it is provided by the device itself. Device identity is relevant for hybrid and native smartphone environments only. The device identity is a must for functionality such as push notifications, and reports. This parameter means that the obtained device identity is used as is, without provisioning.
<b>wl_directUpdateRealm</b>	<b>WLDirectUpdateNullLoginModule</b>	This realm is used to enable the direct update feature. The direct update feature allows for updating of application web resources (not native code) on client devices without the need for users to explicitly download and install the new version. This realm is useful when a fix or an enhancement is done to the web resources of the application and you do not want to start a full release cycle for it. It can be configured to test for updates once per session, per each request, or disabled..

wl_remote_DisableRealm	WLRemoteDisableNullLoginModule	This realm is used to block applications with specific application environments or versions from accessing resources on the server, or to notify clients with some mandatory message that is related to the server. This realm is typically used when a new application version is released and you no longer want the applications with the older versions to connect to the server. In this case, for example, you want to give directions to the clients on how to obtain the new version of the application with a link to its market download page. Another typical use of this realm is when you find a problem with an application security and you want to immediately block access from this application to sensitive data until the problem is fixed. You can configure the contents of the block or notification message and give a link to more information or the new version. For more information about remote disable, see "Remotely disabling application connectivity" on page 11-3.
------------------------	--------------------------------	--------------------------------------------------------------------------------------------------------------------------------------------------------------------------------------------------------------------------------------------------------------------------------------------------------------------------------------------------------------------------------------------------------------------------------------------------------------------------------------------------------------------------------------------------------------------------------------------------------------------------------------------------------------------------------------------------------------------------------------------------------------------------------------------------------------------------------------------------------------------------------------------------------------------------------------------------------------------------------------------------------

MobileFirst static resources (other than Application Center) such as the MobileFirst Operations Console are also configured in the authentication configuration file, in the **<resource>** element.

The configuration file has the following structure:

```
<?xml version="1.0" encoding="UTF-8"?>
<tns:loginConfiguration xmlns:tns="http://www.worklight.com/auth/config" xmlns:xsi="http://www.w3.org/2001/XMLSchema-instance">
  <staticResources>
    <resource>...</resource>
    <resource>...</resource>
  </staticResources>
  <securityTests>
    <customSecurityTest>...</customSecurityTest>
    <customSecurityTest>...</customSecurityTest>
  </securityTests>
  <realms>
    <realm>...</realm>
    <realm>...</realm>
  </realms>
  <loginModules>
    <loginModule>...</loginModule>
    <loginModule>...</loginModule>
  </loginModules>
</tns:loginConfiguration>
```

## Configuring authenticators and realms

Authenticators are defined within the realm that uses them.

Realms are defined in **<realm>** elements in the authenticationConfig.xml file. The **<realms>** element contains a separate **<realm>** subelement for each realm.

Modify realms by using the authentication configuration editor.



The <realm> element has the following attributes:

Table 8-20. The <realm> element attributes

Attribute	Description
name	Mandatory. The unique name by which the realm is referenced by the protected resources.
loginModule	Mandatory. The name of the login module that is used by the realm.

The <realm> element has the following subelements:

Table 8-21. The <realm> element subelements

Element	Description
<className>	Mandatory. The class name of the authenticator.  For details of the supported authenticators, see the following topics.
<parameter>	Optional. Represents the name-value pairs that are passed to the authenticator upon instantiation.  This element might be displayed multiple times.
<onLoginUrl>	Optional. Defines the path to which the client is forwarded upon successful login.  If this element is not specified, then depending on the authenticator type, either the current request processing is continued, or a saved request is restored.

## Implementing basic authenticators

You can implement basic authentication in mobile applications.

### About this task

The basic authenticator implements basic HTTP authentication. Basic authentication is an industry-standard method that is used to collect user name and password information.

In accordance with standard basic authentication, MobileFirst Server sends an HTTP Not Authorized (401) response to the client, with the header: `WWW-Authenticate: Basic realm="realmName"`. When MobileFirst Server receives the response from the client, it extracts the base64-encoded credentials from the Authorization header of the request and decodes them. A login module validates the credentials that have been received.

**Note:** You can use basic authentication for web applications only, not for mobile applications.

The fully qualified Java class name for the basic authenticator is:  
`com.worklight.core.auth.ext.BasicAuthenticator`

### Parameters

The basic authenticator has the following parameter:

Parameter	Description
<basic-realm-name>	Mandatory. A string that is sent to the client as a realm name, and presented by the browser in the login dialog.

### Flow

The following diagram illustrates the flow in the basic authentication process:

Figure 8-29. Basic authentication process

### Procedure

1. Configure the authenticationConfig.xml file. For more information, see “The authentication configuration file” on page 8-260.
2. Code the server side.

**Note:** If you want to protect an adapter procedure with basic authentication, you must declare it in the adapter XML file. See the example in this page.

3. Associate the basic authenticator with a login module. MobileFirst Platform Command Line Interface for iOS provides several predefined login modules. For an example, see Non-validating login module.
4. Code the client side, if necessary.

### Example

The following example demonstrates how to implement a simple basic authentication mechanism. An adapter procedure is protected by a basic authenticator, and when the user attempts to invoke the procedure from the application, the browser displays a login dialog and the authentication process starts.

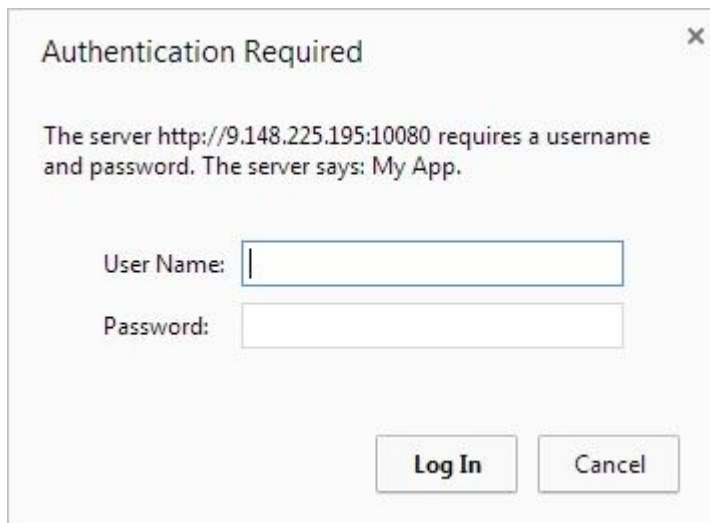

Figure 8-30. Login dialog for authentication

### Configuration of the authenticationConfig.xml file

```
<securityTests>
  <customSecurityTest name="DummyAdapter-securityTest">
    <test isInternalUserID="true" realm="MyAppRealm"/>
  </customSecurityTest>
</securityTests>
```

```

        </customSecurityTest>
    </securityTests>

    <realms>
        <realm name="MyAppRealm" loginModule="StrongDummy">
            <className>com.worklight.core.auth.ext.BasicAuthenticator</className>
            <parameter name="basic-realm-name" value="My App"/>
        </realm>
    </realms>

    <loginModules>
        <loginModule name="StrongDummy">
            <className>com.worklight.core.auth.ext.NonValidatingLoginModule
            </className>
        </loginModule>
    </loginModules>

```

**Note:**

The realm uses the StrongDummy login module, which is implemented by the class NonValidatingLoginModule (see Non-validating login module). "Non-validating" means that the user credentials are not checked against any list of user names and passwords. In other words: any combination of user name and password is valid.

**Coding the server side**

1. Create a MobileFirst adapter.
2. Add a procedure and protect it with the custom security test that you created earlier. This procedure's implementation can return some hard-coded value, for example:

```
<procedure name="getSecretData" securityTest="DummyAdapter-securityTest"/>
```

**Coding the client side**

1. Create a MobileFirst application.
2. Write a call to the adapter procedure that you added on the server side, for example:

```

var invocationData = {
    adapter: <adapterName>,
    procedure: "getSecretData",
    parameters: []
};

WL.Client.invokeProcedure(invocationData, {
    onSuccess : successCallback,
    onFailure : failCallback
});

```

## Implementing form-based authenticators

You can authenticate users of mobile applications by using a login form.

**About this task**

In form-based authentication, if an application tries to access a protected resource, the server returns the HTML code of a login form. Even though a form of this kind is most suited to desktop and web environments (where you display the returned login form), you can also use form-based authentication in mobile applications.

The fully qualified Java class name of the form-based authenticator is: `com.worklight.core.auth.ext.FormBasedAuthenticator`.

This authenticator type presents a login form to the user. The login form must contain `j_username` and `j_password` fields, the `j_security_check` submit action, and the POST submit method.

A login module validates the credentials that are provided. If the login fails, the user is redirected to an error page.

### Parameters

The form-based authenticator has the following parameters:

Parameter	Description
<b>login-page</b>	<p>Path to a user-defined login page template, relative to the web application context under the <code>conf</code> directory. A sample <code>login.html</code> template file is provided under this directory when you create a MobileFirst project.</p> <p>The authenticator renders the login page template with the error messages. To display the error message, use the placeholder <code>\${errorMessage}</code> in the login page template.</p>
<b>auth-redirect</b>	<p>Path to a user-defined login page (html/jsp) relative to the web application context. IBM MobileFirst Platform Foundation for iOS redirects to the page when the user credentials are needed.</p>

Both the **login-page** and **auth-redirect** parameter are optional, but if you decide to use them, use either one or the other. You cannot use them together. You can also use neither. In this case, IBM MobileFirst Platform Foundation for iOS uses its default login page template.

### Flow

The following diagram illustrates the flow in the form-based authentication process:

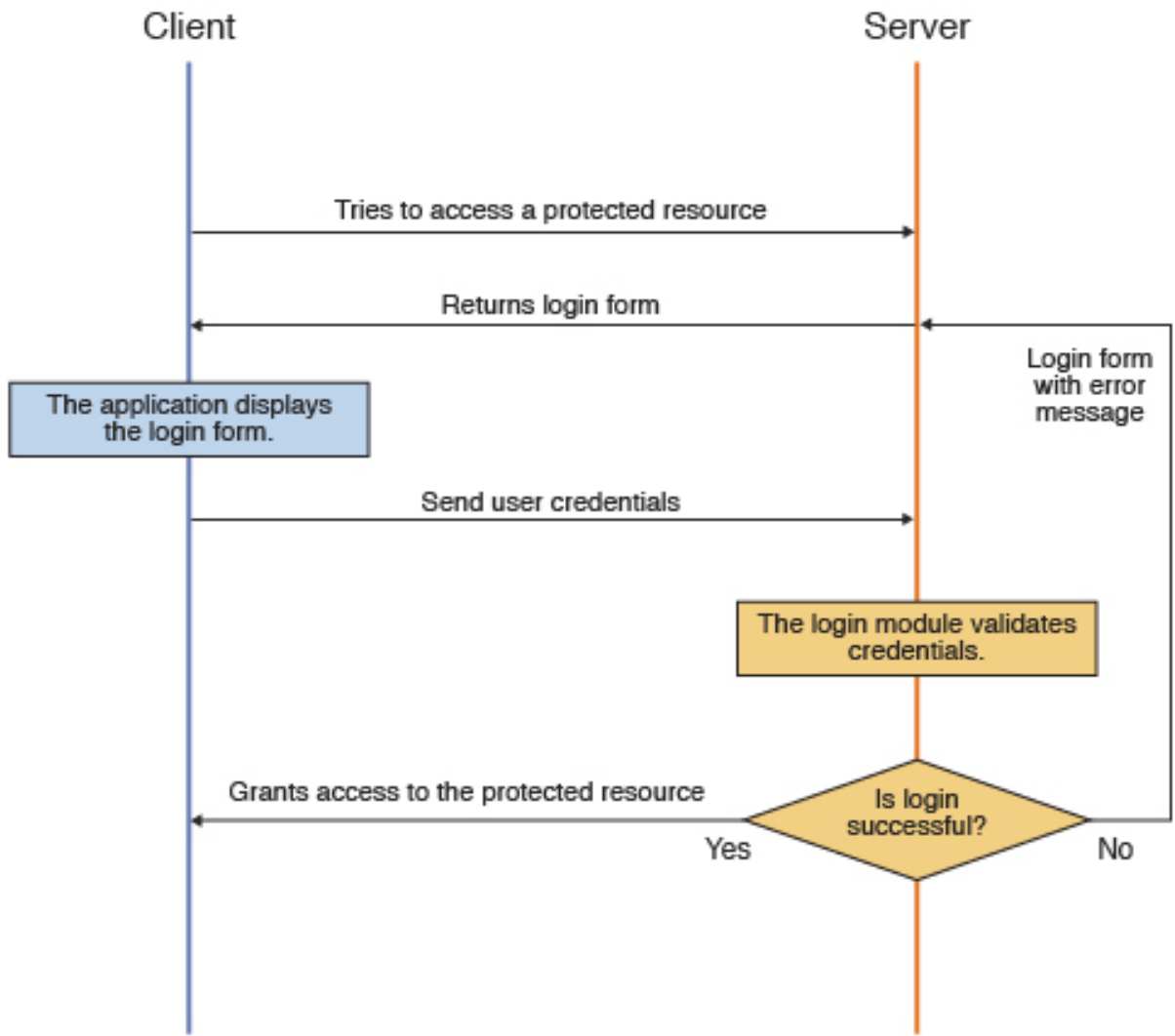

Figure 8-31. Form-based authentication process

### Procedure

1. Configure the `authenticationConfig.xml` file. For more information, see “The authentication configuration file” on page 8-260.
2. Code the server side. To work, the form-based authenticator must be associated with a login module. MobileFirst Platform Command Line Interface for iOS provides several predefined login modules. For an example, see Non-validating login module.

**Note:** If you want to protect an adapter procedure with form-based authentication, you must declare it in the adapter XML file. See the example in this page.

3. Code the client side.

You must declare a challenge handler in the application to handle challenges from the form-based configured realm. The following sample shows one way to implement a challenge handler class:

```
var sampleAppRealmChallengeHandler = WL.Client.createChallengeHandler("SampleAppRealm");
```

The challenge handler must implement the following functions:

- `isCustomResponse`: this function is called each time that a response is received from the server. It is used to detect whether the response contains data that is related to this challenge handler. It must return either `true` or `false`. Here is a simple example:

```
sampleAppRealmChallengeHandler.isCustomResponse = function(response) {
    return false;
};
```
- `handleChallenge`: this function is used to perform required actions, such as hide application screen and show login screen. `handleChallenge` is called by the framework, if `isCustomResponse` returns `true`. Here is a simple implementation, as an example:

```
sampleAppRealmChallengeHandler.handleChallenge = function(response) {
};
```

The challenge handler can also optionally implement the following, additional functions:

- `submitLoginForm`: this function sends the collected credentials to a specific URL. You can also specify request parameters, headers, and callback.
- `submitSuccess`: this function notifies the MobileFirst framework that the authentication finished successfully. The MobileFirst framework then automatically issues the original request that triggered the authentication.
- `submitFailure`: this function notifies the MobileFirst framework that the authentication process failed to finish. The MobileFirst framework then disposes of the original request that triggered the authentication.

## Example

The following example demonstrates how to implement a simple form-based authentication mechanism that is based on a user name and a password. In the example, an adapter procedure is protected by a form-based authenticator, and when the user attempts to call the procedure from the application, the login form is displayed and the authentication process starts.

### Configuration of the `authenticationConfig.xml` file

```
<securityTests>
  <customSecurityTest name="DummyAdapter-securityTest">
    <test isInternalUserID="true" realm="SampleAppRealm"/>
  </customSecurityTest>
</securityTests>

<realms>
  <realm name="SampleAppRealm" loginModule="StrongDummy">
    <className>com.worklight.core.auth.ext.FormBasedAuthenticator</className>
    <parameter name="login-page" value="login.html"/>
  </realm>
</realms>

<loginModules>
  <loginModule name="StrongDummy">
    <className>com.worklight.core.auth.ext.NonValidatingLoginModule</className>
  </loginModule>
</loginModules>
```

### Coding the server side

Perform the following steps:

1. Create a MobileFirst adapter.
2. Add a procedure and protect it with the custom security test that you created earlier. The implementation can return some hard-coded value, for example:

```
<procedure name="getSecretData" securityTest="DummyAdapter-securityTest"/>
```

### Coding the client side

Perform the following steps:

1. Create a MobileFirst application.
2. Create a challenge handler in the application, to handle challenges from the SampleAppRealm realm, for example:

```
var sampleAppRealmChallengeHandler = WL.Client.createChallengeHandler("SampleAppRealm");
```

3. Implement the mandatory `isCustomResponse` and `handleChallenge` functions (and other, optional functions) of the challenge handler, as described previously.

### What to do next

For a more extensive example of implementing form-based authentication, see the tutorial on the Getting Started page.

## Implementing custom authenticators

You can use default MobileFirst login modules and authenticators, or customize your own.

### About this task

You can write custom login modules and authenticators when those that IBM MobileFirst Platform Foundation for iOS supplies do not match your requirements.

### Procedure

1. Configure the `authenticationConfig.xml` file.

For more information, see “The authentication configuration file” on page 8-260.

2. Code the server side.

You create custom login modules and authenticators as instances of Java classes, which you must place in the `server/java` folder of the project. They are server-side entities and they are packed inside the WAR file of the project. The authenticator, login module, and user identity instances are stored in a session scope, so that they exist while the session is active.

#### Authenticator interface and methods

Your custom authenticator class must implement the `com.worklight.server.auth.api.WorkLightAuthenticator` interface. The `WorkLightAuthenticator` interface extends the `java.io.Serializable` interface, so as a result, your custom authenticator implements `java.io.Serializable`. This means that your custom authenticator must have no non-serializable members and also declare a `serialVersionUID` version number, as recommended in the `Serializable` Interface Java documentation.

The custom authenticator must implement the following methods:

- `init`: This method is called when the authenticator instance is created. It receives the options that are specified in the realm definition in the `authenticationConfig.xml` file.
- `processRequest`: This method is called for each request from an unauthenticated session. The method must return an

AuthenticationResult status. While the request is processed, the method might retrieve data from the request and write data to the response.

The AuthenticationResult status can return the following values:

- SUCCESS: The credentials were successfully collected and the login module can now validate them.
- CLIENT\_INTERACTION\_REQUIRED: The client must still supply authentication data.
- REQUEST\_NOT\_RECOGNIZED: The authenticator is not handled.
- processAuthenticationFailure: This method is called if the login module returns a failure for the validation of credentials.
- processRequestAlreadyAuthenticated: This method is called for each request from a session that has already been authenticated. It returns an AuthenticationResult value for authenticated requests.
- getAuthenticationData: Login modules use this method to retrieve the credentials that are collected by an authenticator.
- changeResponseOnSuccess: This method is called after the login module successfully validates credentials. Use this method to notify a client application of the success of the authentication, for example to modify the response before it is returned to the client. This method must return true if the response was modified or false otherwise.
- clone: This method creates a deep copy of the object members.

### Login module interface and methods

Your custom login module class must implement the `com.worklight.server.auth.api.WorkLightAuthLoginModule` interface. The `WorkLightAuthLoginModule` interface extends the `java.io.Serializable` interface, so as a result, your custom `LoginModule` implements `java.io.Serializable`. This means that your `LoginModule` must have no non-serializable fields and also declare a `serialVersionUID` version number, as recommended in the `Serializable Interface Java` documentation.

The login module must implement the following methods:

- `init`: This method is called when the login module instance is created. This method receives the options that are specified in the login module definition of the `authenticationConfig.xml` file.
- `login`: This method is called after the authenticator returns SUCCESS status. It receives an `authenticationData` object from the authenticator and validates the credentials that are collected by the authenticator. If the credentials are valid, the method returns true. If the credential validation fails, the method returns false or raises a runtime exception. In this case, the exception string that is returned to the authenticator as an `errorMessage` parameter.
- `createIdentity`: This method is called after the credentials are successfully validated. The method creates and returns a `UserIdentity` object, which contains information about the authenticated user, such as unique user name, display name, Java security roles, and custom user attributes.
- `logout`: Use this method to clean up cached data and class members after the user logs out.
- `abort`: Use this method to clean up cached data and class members after the user stops the authentication flow.



- clone: This method creates a deep copy of the object members.

### 3. Code the client side.

You must declare a challenge handler in the application to handle challenges from the custom authenticator realm. The following sample shows one way to implement a challenge handler class:

```
var myChallengeHandler = WL.Client.createChallengeHandler("CustomAuthenticatorRealm");
```

The challenge handler must implement the following methods:

- isCustomResponse: This method is called each time that a response is received from the server. It detects whether the response contains data that is related to this challenge handler. It must return true or false. Here is a simple example:

```
sampleAppRealmChallengeHandler.isCustomResponse = method(response) {
    return false;
};
```

- handleChallenge: Use this method for such actions as hide application screen and show login screen. If the isCustomResponse method returns true, the handleChallenge method is called by the framework. Here is a simple implementation, as an example:

```
sampleAppRealmChallengeHandler.handleChallenge = method(response) {
};
```

Optionally, the challenge handler can also implement the following methods:

- submitLoginForm: This method sends the collected credentials to a specific URL. You can also specify request parameters, headers, and callback.
- submitSuccess: This method notifies the MobileFirst framework that the authentication finished successfully. The MobileFirst framework then automatically issues the original request that triggered the authentication.
- submitFailure: This method notifies the MobileFirst framework that the authentication process failed. The MobileFirst framework then disposes of the original request that triggered the authentication.

## Example

The following example shows how to implement a custom authenticator and login module. In the example, an adapter procedure is protected by a custom authenticator. When the user attempts to call the procedure from the application, the application requests the user's credentials and the authentication process starts.

### Configuration of the authenticationConfig.xml file

```
<securityTests>
  <customSecurityTest name="DummyAdapter-securityTest">
    <test isInternalUserID="true" realm="CustomAuthenticatorRealm"/>
  </customSecurityTest>
</securityTests>

<realms>
  <realm name="CustomAuthenticatorRealm" loginModule="CustomLoginModule">
    <className>com.mypackage.MyCustomAuthenticator</className>
  </realm>
</realms>

<loginModules>
  <loginModule name="CustomLoginModule">
    <className>com.mypackage.MyCustomLoginModule</className>
  </loginModule>
</loginModules>
```

## Coding the server side

Code the following elements on the server side: adapter, authenticator, and login module.

- Adapter:
  1. Create a MobileFirst adapter.
  2. Add a procedure and protect it with the custom security test that you created earlier. The implementation can return some hardcoded value. For example:

```
<procedure name="getSecretData" securityTest="DummyAdapter-securityTest"/>
```

- Authenticator:
  1. Create a MyCustomAuthenticator.java class in the server/java/com/mypackage folder. This class must implement the com.worklight.server.auth.api.WorkLightAuthenticator interface, as follows:

```
public class MyCustomAuthenticator implements WorkLightAuthenticator{
```

2. Add the generated serialVersionUID constant to the class.

3. Implement the mandatory methods of the class.

- processRequest: This method retrieves the user name and password credentials that are passed as request parameters. Check the credentials for basic validity, collect the credentials, and return SUCCESS. If a problem occurs with the received credentials, add an errorMessage to the response and return the CLIENT\_INTERACTION\_REQUIRED status message. If the request does not contain authentication data, add the authStatus:required property to the response and again, return a CLIENT\_INTERACTION\_REQUIRED status message.

```
public AuthenticationResult processRequest(HttpServletRequest request, HttpServletResponse response,
boolean isAccessToProtectedResource) throws IOException, ServletException {
    if (request.getRequestURI().contains("my_custom_auth_request_url")){
        String username = request.getParameter("username");
        String password = request.getParameter("password");

        if (null != username && null != password && username.length() > 0 && password.length() > 0){
            this.username = request.getParameter("username");
            this.password = request.getParameter("password");
            return AuthenticationResult.createFrom(AuthenticationStatus.SUCCESS);
        } else {
            response.setContentType("application/json; charset=UTF-8");
            response.setHeader("Cache-Control", "no-cache, must-revalidate");
            response.getWriter().print("{\"authStatus\":\"required\",
            \"errorMessage\":\"Please enter username and password\"}");
            return AuthenticationResult.createFrom(AuthenticationStatus.CLIENT_INTERACTION_REQUIRED);
        }
    }

    if (!isAccessToProtectedResource)
        return AuthenticationResult.createFrom(AuthenticationStatus.REQUEST_NOT_RECOGNIZED);

    response.setContentType("application/json; charset=UTF-8");
    response.setHeader("Cache-Control", "no-cache, must-revalidate");
    response.getWriter().print("{\"authStatus\":\"required\"}");
    return AuthenticationResult.createFrom(AuthenticationStatus.CLIENT_INTERACTION_REQUIRED);
}
```

- processAuthenticationFailure: This method writes an error message to a response body and returns the CLIENT\_INTERACTION\_REQUIRED status message.

```
public AuthenticationResult processAuthenticationFailure(HttpServletRequest
request, HttpServletResponse response, String errorMessage) throws IOException, ServletException {
    response.setContentType("application/json; charset=UTF-8");
```

```

response.setHeader("Cache-Control", "no-cache, must-revalidate");
response.getWriter().print("{\"authStatus\": \"required\", \"errorMessage\": \"" + errorMessage + "\"}");
return AuthenticationResult.createFrom(AuthenticationStatus.CLIENT_INTERACTION_REQUIRED);
}

```

- Login module:

1. Create a `MyCustomLoginModule.java` class in the `server/java/com/mypackage` folder. This class must implement the `com.worklight.server.auth.api.WorkLightAuthLoginModule` interface.

```
public class MyCustomLoginModule implements WorkLightAuthLoginModule{
```

2. Implement the mandatory methods of the class.

- `login`: This method retrieves the user name and password credentials that the authenticator stored previously. In this example, the login module validates the credentials against hardcoded values. You can implement your own validation rules. If the credentials are valid, the login method returns `true`. For example:

```

public boolean login(Map<String> authenticationData) {
    USERNAME = (String) authenticationData.get("username");
    PASSWORD = (String) authenticationData.get("password");
    if (USERNAME.equals("wluser") && PASSWORD.equals("12345"))
        return true;
    else throw new RuntimeException("Invalid credentials"); }
</String>

```

- `createIdentity`: This method is called when the login method returns `true`. It is used to create a `UserIdentity` object. In that object, you can store your own custom attributes and use them later in Java or adapter code. The `UserIdentity` object contains user information. Its constructor is as follows:

```
public UserIdentity(String loginModule, String name, String displayName, Set<String> roles, Map<String, Object> attributes, Object credentials)
```

Here is an example of how to implement this method:

```

public UserIdentity createIdentity(String loginModule) {
    HashMap<String, Object> customAttributes = new HashMap<String, Object>();
    customAttributes.put("AuthenticationDate", new Date());

    UserIdentity identity = new UserIdentity(loginModule, USERNAME, null, null, customAttributes, PASSWORD);
    return identity;
}

```

## Coding the client side

Follow these steps:

1. Create a MobileFirst application.
2. Create a challenge handler in the application to handle challenges from the custom authenticator realm. For example:

```

var myAppRealmChallengeHandler =
WL.Client.createChallengeHandler ("CustomAuthenticatorRealm");

```

3. Implement the mandatory `isCustomResponse` and `isCustomResponse` methods, and optional methods of the challenge handler, as described in Step 3.

## What to do next

For a more extensive example of implementing custom authentication and login, see module *Custom Authenticator and Login Module in hybrid applications* in “Tutorials, samples, and additional resources” on page 5-1.

## Header authenticator

Description and syntax of the header authenticator.

### Description

The header authenticator is not interactive. The header authenticator must be used with the Header login module.

### Class Name

`com.worklight.core.auth.ext.HeaderAuthenticator`

### Parameters

None.

```
<realm name="RealmHeader" loginModule="HeaderLoginModule">
<className> com.worklight.core.auth.ext.HeaderAuthenticator </className>
</realm>
```

## Persistent cookie authenticator

Description and syntax of the persistent cookie authenticator.

### Description

The persistent cookie authenticator looks for a specific cookie in any request that is sent to it. If the request does not contain the cookie, the authenticator creates a cookie, and sends it in the response. This authenticator is not interactive, that is, it does not ask the user for credentials, and is mainly used in environment realms.

### Class Name

`com.worklight.core.auth.ext.PersistentCookieAuthenticator`

### Parameters

The persistent cookie authenticator class has the following parameter:

Parameter	Description
<code>&lt;cookie-name&gt;</code>	Optional. The name of the persistent cookie. If this parameter is not specified, the default name, <code>WL_PERSISTENT_COOKIE</code> , is used.

```
<realm name="PersistentCookie" loginModule="dummy">
<className> com.worklight.core.auth.ext.PersistentCookieAuthenticator </className>
</realm>
```

## Implementing adapter-based authenticators

You can authenticate users of mobile applications by using an adapter-based authenticator.

### About this task

Adapter-based authentication enables you to develop custom authentication logic by using a JavaScript function within a MobileFirst adapter.

Adapter-based authentication is flexible and customizable. The following diagram illustrates one possible implementation. The process is illustrated and described as

follows.

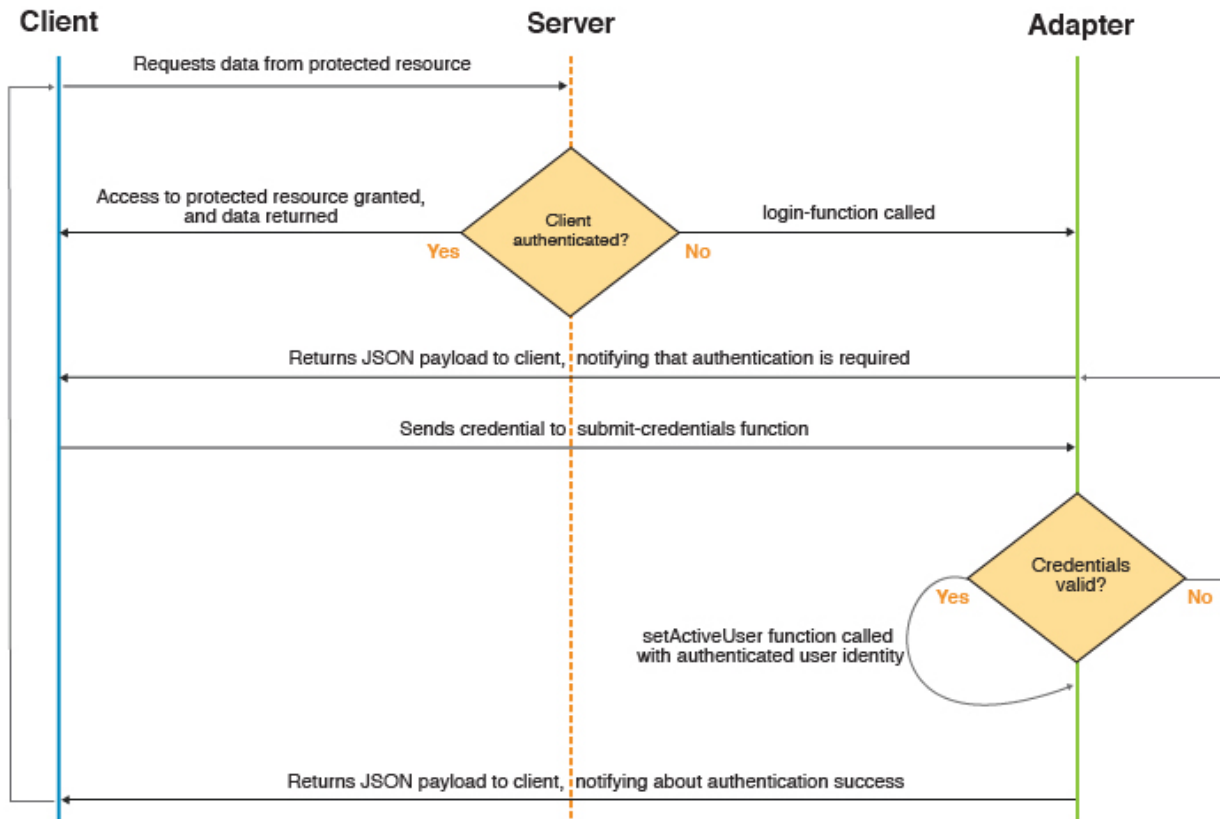

Figure 8-32. Adapter-based authentication process

1. The client makes a request to the resource that is protected by adapter authentication.
2. MobileFirst Server checks whether the client is already authenticated.
  - a. If it is, the requested data is returned.
  - b. Otherwise, authentication continues.
3. The adapter procedure that is defined in `authenticationConfig.xml` as a `login-function` is called.
4. The `login-function` procedure is used to return a custom JSON payload to the client.
5. The client processes the custom JSON payload and sends its credentials to the adapter procedure used for authentication.
6. The adapter procedure that is used for authentication receives credentials and validates them.
  - a. If validation fails, the flow returns to step 4.
  - b. Otherwise, authentication continues.
7. The adapter procedure that is used for authentication creates a user identity and returns a success status to the client.
8. The client receives the success status and issues the original request.
9. The flow returns to step 2.

For more information, see “The authentication configuration file” on page 8-260.

## Procedure

1. Configure the `authenticationConfig.xml` file.
  - Add security tests to the `<securityTest>` section of the file. Because the security test that you are using is protecting an adapter procedure, you use the `<customSecurityTest>` parameter.
  - Add authentication realms to the `<realms>` section. For the `className` parameter, use the `com.worklight.integration.auth.AdapterAuthenticator` to indicate that the server-side part of the authenticator is defined in the adapter. Define two parameter-value pairs for login and logout:
    - `login-function`: whenever the MobileFirst authentication framework detects an attempt to access a protected resource, the `login-function` is called automatically.
    - `logout-function`: when logout is detected (explicit or session timeout), the `logout-function` is called automatically.

In both cases, the value syntax is `adapterName.functionName`.

- Add a login module to the `<loginModules>` section. All of the validation logic that is done in a login module is performed in the adapter's JavaScript code and you need no further validation. For that reason, adapter-based authentication must be used with a `NonValidatingLoginModule` only. No additional validation is performed by the IBM MobileFirst Platform, and the developer takes responsibility for the validation of credentials within the adapter. For more information, see `Non-validating login module`.
2. Code the server side.

The fully qualified name of the Java class for adapter authenticators is `com.worklight.integration.auth.AdapterAuthenticator`. It takes the mandatory **login-function** parameter and the optional **logout-function** parameters. Both parameters specify adapter function names. The syntax is: `adapter-name.function-name`, for example, `myAuthAdapter.onAuthRequired`. You need to implement the `login-function` and `logout-function` in your `adapter.js` source file. In the example, these parameters are implemented as `AuthAdapter.onAuthRequired` and `AuthAdapter.onLogout`.

### Note:

- Both `login-function` and `logout-function` should only be used internally by a MobileFirst Server. For this reason, it is important that you do not expose them as procedures in the adapter XML file.
- In contrast, the function that receives credentials is directly called by a client. Therefore, you must expose the function in the adapter XML file. When the challenge handler invokes the submit call, the handler is responsible for handling all the possible responses. In particular, if the submit call returns a challenge, the challenge is passed to the invocation callback, and is not processed by the security framework. To prevent a situation in which the invocation callback cannot handle the challenge, disable the authentication requirement for the submit procedure by using the `wl_unprotected` security test.
- Alternatively, you can define a more sophisticated security test for this function. Just make sure that the security context on the client side is sufficient to answer the challenge. One way to do this is to enrich the client security context by a call to `WL.Client.connect` before the adapter is called.

- If your MobileFirst Server runs on WebSphere® Application Server, version 7 (any release) or releases of WebSphere Application Server Liberty 8.5 prior to Fix Pack 2, the application server's Web container custom flag  
`com.ibm.ws.webcontainer.suppressLoggingServiceRuntimeExcep`

must be set to true. The default is false. If this flag is not changed, then the adapter will fail to authenticate and an exception will occur. For more information, see APAR PM74090 or APAR PM79934 for WebSphere Application Server.

In addition to implementing login-function and logout-function, you also need to implement an adapter function that receives credentials from the client, validate them, and create a user identity, for example, function `submitCredentials (user, password)`.

- **The login function**

The login-function parameter specifies the name of the JavaScript function to be invoked once the login process is triggered. The triggering can happen either when the client application explicitly invokes the `WL.Client.login` API, or when an unauthenticated attempt to access a resource protected by the adapter authentication realm is made. Use this function to return a payload to the client to notify it about the required authentication. The login-function receives original request headers that are converted to JSON as a first function argument so that they can be used to decide on the kind of authentication that is needed, for example. Then it is the login-function that returns the response to the client, instead of the original function

- **The logout function**

The logout-function parameter specifies the name of the JavaScript function to be invoked once logout from the realm has occurred. The logout can be triggered by having the client application call the `WL.Client.logout` API, or when the MobileFirst Server decides to invalidate the session (for example, a session timeout). The logout-function receives no arguments.

- **The submit credentials function**

This is the function that actually performs the authentication. The client should call this function with arguments containing user credentials or authentication data. It should then validate the credentials and once validated, this function should use `WL.Server.setActiveUser(realm, identity)` to register the authenticated identity. The function can include a flag or message in the response to let the application know if the login was successful or not. If not, it is advised to programatically limit the number of login trials in your application.

3. Code the client side.

- a. Create a MobileFirst application, with an element for displaying the application content and an element for authentication. For example, when authentication is required, the application hides the applicative element and shows the authentication element. When authentication is complete, it does the opposite.
- b. Create a challenge handler, by using the `WL.Client.createChallengeHandler` method to create a challenge handler object. You must *implement* the following mandatory methods: `isCustomResponse`, `handleChallenge`. In addition, the following mandatory methods are available in every challenge handler that you must *use*: `submitAdapterAuthentication`, `submitSuccess`, `submitFailure`.

**Note:**

You must attach each of these mandatory challenge handler functions to its object. For example: `myChallengeHandler.submitSuccess`.

**Example**

The following example demonstrates how to implement an adapter-based authentication mechanism that relies on a user name and a password.

**Configuration of the authenticationConfig.xml file**

```
<securityTests>
  <customSecurityTest name="SingleStepAuthAdapter-securityTest">
    <test isInternalUserID="true" realm="SingleStepAuthRealm"/>
  </customSecurityTest>
</securityTests>

<realms>
  <realm loginModule="AuthLoginModule" name="SingleStepAuthRealm">
    <className>com.worklight.integration.auth.AdapterAuthenticator</className>
    <parameter name="login-function"
      value="SingleStepAuthAdapter.onAuthRequired"/>
    <parameter name="logout-function"
      value="SingleStepAuthAdapter.onLogout"/>
  </realm>
</realms>

<loginModules>
  <loginModule name="AuthLoginModule">
    <className>com.worklight.core.auth.ext.NonValidatingLoginModule
    </className>
  </loginModule>
</loginModules>
```

**Code the server side authentication**

Perform the following steps:

1. Create an adapter that takes care of the authentication process. In this example, it is `SingleStepAuthAdapter`.
2. `SingleStepAuthAdapter` could include the following two procedures, for example:

```
<procedure name="submitAuthentication" securityTest="wl_unprotected"/>
<procedure name="getSecretData" securityTest="SingleStepAuthAdapter-securityTest"/>
```

- The `submitAuthentication` procedure takes care of the authentication process and authentication is not required to call it.
- The `getSecretData` procedure is available to authenticated users only.

3. Define the `onAuthRequired` function:

```
function onAuthRequired(headers, errorMessage) {
  errorMessage = errorMessage ? errorMessage : null;

  return {
    authRequired: true,
    errorMessage: errorMessage
  };
}
```

- This function receives the response headers and an optional `errorMessage` parameter. The object that is returned by this function is sent to the client application. The `authRequired:true` and `errorMessage:errorMessage` pairs define a custom challenge object that is sent to the application.



- The `authRequired:true` property is used in a challenge handler to detect that the server is requesting authentication.
  - Whenever the MobileFirst framework detects an unauthenticated attempt to access a protected resource, the `onAuthRequired` function is called, as you defined in the `authenticationConfig.xml` file.
4. Define the `submitAuthentication` function. The function is called by the client app to validate the user name and password.

```

/* In this sample, the credentials are validated against some
 * hardcoded values, but any other validation mode is valid,
 * for example by using SQL or web services. */
if (username=="worklight" && password === "worklight"){

/* If the validation passed successfully, the WL.Server.setActiveUser method
 * is called to create an authenticated session for the SingleStepAuthRealm,
 * with user data stored in a userIdentity object. You can add your own custom
 * properties to the user identity attributes. */
var userIdentity = {
    userId: username,
    displayName: username,
    attributes: {
        foo: "bar"
    }
};

WL.Server.setActiveUser("SingleStepAuthRealm", userIdentity);

/* An object is sent to the application, stating that the authentication
 * screen is no longer required. */
return {
    authRequired: false
};
}

/* If the credentials validation fails, an object that is built
 * by the onAuthRequired function is returned to the application
 * with a suitable error message. */
return onAuthRequired(null, "Invalid login credentials");
}

```

5. Define the `getSecretData` function. For the purposes of demonstration, at the conclusion of successful authentication, you could return a hard-coded value:

```

function getSecretData() {
    return {
        secretData: "Very very secret data"
    };
}

```

6. Define the `onLogout` function, to be called automatically on logout. It can perform a cleanup, for example.

```

function onLogout(){
    WL.Logger.debug("Logged out");
}

```

### Code the client side authentication

Perform the following steps:

1. Create a MobileFirst application.
2. You might create some HTML code, for example, to display application content only after authentication is complete.
3. Create the challenge handler. Use the `WL.Client.createChallengeHandler` method to create a challenge handler object; supply a realm name as a parameter. For example:

```

var singleStepAuthRealmChallengeHandler =
    WL.Client.createChallengeHandler("SingleStepAuthRealm");

/* The isCustomResponse function of the challenge handler
 * is called each time a response is received from the server.
 * That function is used to detect whether the response contains
 * data that is related to this challenge handler. The function returns true or false.
 */

singleStepAuthRealmChallengeHandler.isCustomResponse = function(response) {
    if (!response||!response.responseJSON||response.responseText === null) {
        return false;
    }
    if (typeof(response.responseJSON.authRequired) !== 'undefined'){
        return true;
    } else {
        return false;
    }
};

```

4. Define a `handleChallenge` function. That function behaves differently according to the result of the `authRequired` function in the previous step.

```

/* If the isCustomResponse function returns true, the
 * framework calls the handleChallenge function. This function
 * is used to perform required actions, such as to hide the
 * application screen or show the login screen. */
singleStepAuthRealmChallengeHandler.handleChallenge =
    function(response){
        var authRequired = response.responseJSON.authRequired;

        if (authRequired == true){
            $("#AppDiv").hide();
            $("#AuthDiv").show();
            $("#AuthPassword").empty();
            $("#AuthInfo").empty();

            if (response.responseJSON.errorMessage)
                $("#AuthInfo").html(response.responseJSON.errorMessage);

        } else if (authRequired == false){
            $("#AppDiv").show();
            $("#AuthDiv").hide();
            singleStepAuthRealmChallengeHandler.submitSuccess();
        }
    };
$("#authCancelButton").click(function(){
    singleStepAuthRealmChallengeHandler.submitFailure();
});

```

The code in this step demonstrates two of three additional challenge handler functions that you need to use:

- The `submitSuccess` function notifies the MobileFirst framework that the authentication process completed successfully. The MobileFirst framework then automatically issues the original request that triggered authentication.
- The `submitFailure` function notifies the MobileFirst framework that the authentication process completed with failure. The MobileFirst framework then disposes of the original request that triggered authentication.

5. The third challenge handler function you must use is `submitAdapterAuthentication`. It sends collected credentials to a

specific adapter procedure. It has the same signature as the `WL.Client.invokeProcedure` function. Here is an example:

```
$("#AuthSubmitButton").bind('click', function () {
    var username = $("#AuthUsername").val();
    var password = $("#AuthPassword").val();

    var invocationData = {
        adapter : "SingleStepAuthAdapter",
        procedure : "submitAuthentication",
        parameters : [ username, password ]
    };

    singleStepAuthRealmChallengeHandler.submitAdapterAuthentication(invocationData, {});
});
```

## What to do next

For a more extensive example of implementing adapter-based authentication, see the tutorials on the Getting Started page.

## LTPA authenticator

Description and syntax for the LTPA authenticator.

### Description

Use the Lightweight Third-Party Authentication authenticator to integrate with the WebSphere Application Server LTPA mechanisms.

**Note:** This authenticator is supported only on WebSphere Application Server. To avoid unnecessary errors on other application servers, the authenticator is commented out in the default `authenticationConfig.xml` file that is created with an empty MobileFirst project. To use it, remove the comments first.

This authenticator can be used with the `WASLTPAModule` login module.

### Class Name

`com.worklight.core.auth.ext.WebSphereFormBasedAuthenticator`

### Parameters

The adapter authenticator class has the following parameters:

Parameter	Description
<b>login-page</b>	Mandatory. The login page URL relative to the web application context.
<b>error-page</b>	Optional. The error page URL relative to the web application context. If this parameter is not set, the URL from the <code>login-page</code> is also used for the error-page.
<b>cookie-domain</b>	Optional. A String such as <code>example.com</code> , which specifies the domain in which the LTPA SSO cookie applies. If this parameter is not set, no domain attribute is set on the cookie. The single sign-on is then restricted to the application server host name and does not work with other hosts in the same domain. <b>Note:</b> This parameter is deprecated. Define this parameter in the <code>&lt;loginModule&gt;</code> entry for the <code>WebSphereLoginModule</code> instead. If the parameter is defined in both places, the value in the <code>&lt;loginModule&gt;</code> entry takes precedence.

Parameter	Description
<b>httponly-cookie</b>	Optional. A String with a value of either true or false, which specifies whether the cookie has the HttpOnly attribute set. This attribute helps to prevent cross-site scripting attacks. <b>Note:</b> This parameter is deprecated. Define this parameter in the <loginModule> entry for the WebSphereLoginModule instead. If the parameter is defined in both places, the value in the <loginModule> entry takes precedence.
<b>cookie-name</b>	Optional. A String that specifies the name of the LTPA SSO cookie. If this parameter is not set, the default cookie name is LtpaToken. <b>Note:</b> This parameter is deprecated. Define this parameter in the <loginModule> entry for the WebSphereLoginModule instead. If the parameter is defined in both places, the value in the <loginModule> entry takes precedence.

### Example

```
<realm name="WASLTPARealm" loginModule="WASLTPAModule">
  <className>com.worklight.core.auth.ext.WebSphereFormBasedAuthenticator</className>
  <parameter name="login-page" value="/login.html"/>
  <parameter name="error-page" value="/loginError.html"/>
</realm>
```

## Configuring login modules

Login modules are defined in <loginModule> elements in the authenticationConfig.xml file.

The <loginModules> element contains a separate <loginModule> subelement for each login module.

The <loginModule> element has the following attributes:

Attribute	Description
expirationInSeconds	Optional. Defines the expiration period of realms that use this login module. Note that authentication to a login module is only valid within the same client session. Therefore, a client that has successfully authenticated with the login module remains authenticated until the end of the expiration period, or until the end of the session, whichever occurs first. The default expiration is the special value "-1", which indicates that there is no set expiration period and the login remains valid until the end of the client session.
name	Mandatory. The unique name by which realms reference the login module.

Attribute	Description
audit	<p>Optional. Defines whether login attempts that use the login module are logged in the audit log. The log file is <i>Worklight Project Name/server/log/audit/audit.log</i>.</p> <p>Valid values are:</p> <p><b>true</b> Login and logout attempts are logged in the audit log.</p> <p><b>false</b> Default. Login and logout attempts are not logged in the audit log.</p>

The MobileFirst security framework provides several built-in realms (for example, `directUpdate` and `remoteDisable`). In order to modify the default expiration period of these realms, open the `worklight.properties` file, uncomment the line corresponding to the realm, and change the expiration value. The following shows the relevant sections in `worklight.properties`:

```
#####
# Expiration time for built-in realms
#####
# Use these properties to configure the expiration time (in seconds) for Worklight's built-in realms.
# A value of -1 means the realm will remain authenticated as long as the server session doesn't time out.
#wl.realm.expiration.directUpdate=-1
#wl.realm.expiration.remoteDisable=300
#wl.realm.expiration.deviceAutoProvisioning=-1
#wl.realm.expiration.deviceNoProvisioning=-1
#wl.realm.expiration.antiXSRF=-1
#wl.realm.expiration.authenticity=-1
#wl.realm.expiration.anonymousUser=-1
```

The `<loginModule>` element has the following subelements:

Element	Description
<code>&lt;className&gt;</code>	<p>Mandatory. The class name of the login module.</p> <p>For details of the supported login modules, see the following topics.</p>
<code>&lt;parameter&gt;</code>	<p>Optional. An initialization property of the login module. The supported properties and their semantics depend on the login module class.</p> <p>This element can occur multiple times.</p>

## Non-validating login module

The non-validating login module accepts any user name and password passed by the authenticator.

### Class Name

`com.worklight.core.auth.ext.NonValidatingLoginModule`

## Parameters

None

```
<loginModule name="dummy">  
<className> com.worklight.core.auth.ext.NonValidatingLoginModule </className>  
</loginModule>
```

## Single identity login module

The single identity login module is used to grant access to a protected resource to a single user, the identity of which is defined in the `worklight.properties` file. Use this module only for test purposes.

### Class Name

`com.worklight.core.auth.ext.SingleIdentityLoginModule`

## Parameters

None

## Configuration

The `worklight.properties` file must contain the following properties:

Key	Description
<code>console.username</code>	Name of the user who can access the protected resource.
<code>console.password</code>	Password of the user who can access the protected resource. The password can be encrypted as indicated in "Storing properties in encrypted format" on page 10-56.

## Header login module

The Header login module is always used with the Header authenticator. It validates the request by looking for specific headers.

### Class Name

`com.worklight.core.auth.ext.HeaderLoginModule`

## Parameters

The Header login module has the following parameters:

Parameter	Description
<code>user-name-header</code>	Mandatory. The name of the header that contains the user name. If the request does not contain this header, the authentication fails.
<code>display-name-header</code>	Optional. The name of the header that contains the display name. If this parameter is not specified, the user name is used as the display name.

```

<loginModule name="HeaderLoginModule" audit="true">
  <className>com.worklight.core.auth.ext.HeaderLoginModule</className>
  <parameter name="user-name-header" value="userid"/>
  <parameter name="display-name-header" value="username"/>
</loginModule>

```

## WASLTPAModule login module

The WASLTPAModule login module enables integration with WebSphere Application Server LTPA mechanisms.

**Note:** This login module is only supported on WebSphere Application Server. To avoid unnecessary errors when IBM MobileFirst Platform Foundation for iOS is run on other application servers, the login module is commented out in the default authenticationConfig.xml file that is created with an empty MobileFirst project. To use it, remove the comments first.

### Class Name

com.worklight.core.auth.ext.WebSphereLoginModule

### Parameters

The login module class has the following parameters:

Parameter	Description
<b>cookie-domain</b>	Optional. A String such as example.com, which specifies the domain in which the LTPA SSO cookie applies. If this parameter is not set, no domain attribute is set on the cookie. The single sign-on is then restricted to the application server host name and does not work with other hosts in the same domain.
<b>httponly-cookie</b>	Optional. A String with a value of either true or false, which specifies whether the cookie has the HttpOnly attribute set. This attribute helps to prevent cross-site scripting attacks.
<b>cookie-name</b>	Optional. A String that specifies the name of the LTPA SSO cookie. If this parameter is not set, the default cookie name is LtpaToken.
<b>role</b>	Optional. A String that specifies the Java EE role that the authenticated user must belong to for the login to be successful. If the parameter is not specified, no role checking is performed.

**Note:** When you specify a role parameter, the role must be defined in the MobileFirst web application deployment descriptor (web.xml). A set of users or groups must be mapped to that role by using the usual WebSphere Application Server mechanisms.

```

<loginModule name="WASLTPAModule">
  <className>com.worklight.core.auth.ext.WebSphereLoginModule</className>
  <parameter name="role" value="wluser"/>
  <parameter name="cookie-domain" value="example.com"/>
  <parameter name="httponly-cookie" value="true"/>
  <parameter name="cookie-name" value="LtpaToken2"/>
</loginModule>

```

## LDAP login module

You can use the LDAP login module to authenticate users against LDAP servers, for example Active Directory, or OpenLDAP.

LDAP login module implements a `UserNamePasswordLoginModule` interface, so you must use it with an authenticator that implements a `UsernamePasswordAuthenticator` interface.

## Class Name

`com.worklight.core.auth.ext.LdapLoginModule`

## Parameters

You must set the following parameters for the LDAP login module:

Parameter	Description	Sample values
<code>ldapProviderUrl</code>	Mandatory. The IP address or the URL of the LDAP server.	<code>ldap://10.0.1.2</code> <code>ldaps://10.0.1.3</code>
<code>ldapTimeoutMs</code>	Mandatory. The connection timeout to the LDAP server in milliseconds.	2000
<code>ldapSecurityAuthentication</code>	Mandatory. The LDAP security authentication type. The value is usually <code>simple</code> . Consult your LDAP administrator to obtain the relevant authentication type.	<code>none</code> <code>simple</code> <code>strong</code>
<code>validationType</code>	Mandatory. The type of validation. The value can be <code>exists</code> , <code>searchPattern</code> , or <code>custom</code> . See the following table for more details.	<code>exists</code> <code>searchPattern</code> <code>custom</code>
<code>ldapSecurityPrincipalPattern</code>	Mandatory. Depending on the LDAP server type, this parameter might require security credentials that you must supply in several formats. Some LDAP servers require only the user name, for example <code>john</code> , and others require the user name and the domain, for example <code>john@server.com</code> . You use this property to define the pattern to create your user name based credentials. You can use the <code>{username}</code> placeholder.	<code>{username}</code> <code>{username}@myserver.com</code> <code>CN={username},DC=myserver,DC=com</code>
<code>ldapSearchFilterPattern</code>	Optional. This parameter is required only if the value of the <code>validationType</code> parameter is <code>searchPattern</code> . You use this parameter to define a search filter pattern that is run when a successful LDAP binding is established. The user validation is successful if the search returns one or more entries. You can use the <code>{username}</code> placeholder. The syntax might change depending on the LDAP server type.	<code>(sAMAccountName={username})</code>  <code>(&amp;(objectClass=user)</code> <code>(sAMAccountName={username})</code> <code>(memberOf=CN=Sales,OU=Groups,</code> <code>OU=MyCompany,DC=myserver,DC=com))</code>



Parameter	Description	Sample values
ldapSearchBase	Optional. This parameter is required only if the validationType parameter is searchPattern. Use this parameter to define the base of the LDAP search.	dc=myserver,dc=com
ldapReferral	Optional. This parameter indicates to the service providers how to handle referrals. If a value is not specified for this property, then no value is assigned to it.  Possible values are: <ul style="list-style-type: none"> <li>• ignore - referrals are ignored</li> <li>• follow - referrals are automatically followed</li> <li>• throw - each referral causes a ReferralException to be thrown</li> </ul>	ignore

#### Sample LDAP login module definition:

```
<loginModule name="LDAPLoginModule">
  <className>com.worklight.core.auth.ext.LdapLoginModule</className>
  <parameter name="ldapProviderUrl" value="ldap://10.0.1.2"/>
  <parameter name="ldapTimeoutMs" value="2000"/>
  <parameter name="ldapSecurityAuthentication" value="simple"/>
  <parameter name="validationType" value="searchPattern"/>
  <parameter name="ldapSecurityPrincipalPattern" value="{username}@myserver.com"/>
  <parameter name="ldapSearchFilterPattern" value="(&objectClass=user)(sAMAccountName={username})
(memberof=CN=Sales,OU=Groups,OU=MyCompany,DC=myserver,DC=com)"/>
  <parameter name="ldapSearchBase" value="dc=myserver,dc=com"/>
  <parameter name="ldapReferral" value="ignore"/>
</loginModule>
```

#### Values of the validationType parameter

Value	Description
exists	The login module tries to establish the LDAP binding with the supplied credentials. The credentials validation is successful if the binding is successfully established.
searchPattern	The login module tries to do the exists validation. When the validation succeeds, the login module issues a search query to the LDAP server context, according to the ldapSearchFilterPattern and ldapSearchBase parameters. The credentials validation is successful if the search query returns one or more entries.
custom	With this value, you can implement custom validation logic. The login module tries to do the exists validation. When the validation succeeds, the login module calls a public boolean doCustomValidation(LdapContext ldapCtx, String username) method. To override this method, you must create a custom Java class in your MobileFirst project and extend from com.worklight.core.auth.ext.UserNamePasswordLoginModule. See the following example.

#### Sample custom validation implementation:

```
package mycode;
import javax.naming.ldap.LdapContext;
import com.worklight.core.auth.ext;
```

```

public class MyCustomLdapLoginModule extends LdapLoginModule {

    @Override
    public boolean doCustomValidation(LdapContext ldapCtx, String username, String password) {

        boolean success = true;

        // Do some custom validations here using ldapCtx, validationProperties and username
        // Return true in case of validation success and false otherwise

        return success;
    }
}

```

**Note:**

After you implement your custom extension of `LdapLoginModule`, use it as a `className` value of `LoginModule` in your `AuthenticationConfig.xml` file.

## Configuring device auto provisioning

You can change the default behavior of device auto provisioning with regards to granularity of the provisioning, and pre-required realms for provisioning. You can also change the CA certificate (root certificate) that is used to issue certificates for provisioned devices.

### Procedure

- To change the default behavior of provisioning granularity and pre-required realms, define a new realm for device provisioning and add the following `<realm>` element to the `<realms>` element in the `authenticationConfig.xml` file. Then, use it in your security test of choice:

```

<realm name="wl_myProvisioningRealm"
    loginModule="WLDeviceAutoProvisioningLoginModule">
    <className>com.worklight.core.auth.ext.DeviceAutoProvisioningAuthenticator</className>
    <parameter name="provisioned-entity" value="application" />
    <parameter name="pre-required-realms" value="wl_authenticityRealm" />
</realm>

```

where *provisioned-entity* can have one of the following values:

- application
- device
- group:<group-name>, where *group-name* is the name of the provisioning application group

and *pre-required-realms* is a comma-separated list of realm names that are required to be successfully logged in to before provisioning is allowed to begin.

**Note:** Applications must be signed by the same signing credentials and (on iOS) share the same bundleID prefix.

- To use a CA certificate other than the default MobileFirst CA certificate, configure the following properties.

**wl.ca.keystore.path**

The path to the keystore, relative to the server folder in the MobileFirst Project, for example: `conf/default.keystore`.

**wl.ca.keystore.type**

The type of the keystore file. Valid values are jks or pkcs12.

**wl.ca.keystore.password**

The password to the keystore file, for example: worklight.

**wl.ca.key.alias**

The alias of the entry where the private key and certificate are stored, in the keystore, for example: keypair1.

**wl.ca.key.alias.password**

The password to the alias in the keystore for example: worklight.

For information about how to specify MobileFirst configuration properties, see “Configuration of MobileFirst applications on the server” on page 10-48

- To enable multiple applications to share the same certificate, define a **bundleId** attribute in the application descriptor.

## Configuring and implementing custom device provisioning

Custom device provisioning is an extension of auto device provisioning. The main difference between auto and custom provisioning is that you can perform custom validation of the certificate signing request (CSR) during the provisioning process and custom validation of the certificate during each device authentication process.

The custom device provisioning must be implemented in the JavaScript code of an adapter. Specify the names of the `validate-csr` and `validate-certificate` functions in the `authenticationConfig.xml` file as realm and login module parameters:

```
<securityTests>
  <mobileSecurityTest name="CustomDeviceProvisioningSecurityTest">
    <testAppAuthenticity/>
    <testDeviceId provisioningType="custom" realm="CustomDeviceProvisioningRealm"/>
  </mobileSecurityTest>
</securityTests>

<realms>
  <realm name="CustomDeviceProvisioningRealm" loginModule="CustomDeviceProvisioningLoginModule">
    <className>com.worklight.core.auth.ext.DeviceAutoProvisioningAuthenticator</className>
    <parameter name="validate-csr-function" value="ProvisioningAdapter.validateCSR"/>
  </realm>
</realms>

<loginModules>
  <loginModule name="CustomDeviceProvisioningLoginModule">
    <className>com.worklight.core.auth.ext.DeviceAutoProvisioningLoginModule</className>
    <parameter name="validate-certificate-function" value="ProvisioningAdapter.validateCertificate"/>
  </loginModule>
</loginModules>
```

The `validate-csr-function` checks that the certificate signing request (CSR) sent by the client is complete and contains the correct information that is needed for the certification of the device. This logic might also validate some properties of CSR against internal or external services / directories.

The `validate-certificate-function` verifies that the certificate was issued with the right certificate authority (CA). The logic might also verify that the certificate contains all the necessary data about the device for this custom device authentication realm.

For more information about how to implement these functions, see the tutorials on the Getting Started page.

It is important to understand the concept of mobile device authentication and auto provisioning. For more information about mobile device authentication, see “Mobile device authentication” on page 8-257.

With custom device provisioning, you can also implement custom variations of the CSR during the initial provisioning flow and of the certificate at each application start.

You must configure the server and the client for custom device provisioning.

## Implementing server-side components for custom device provisioning

You can implement server-side components for custom device provisioning.

### About this task

To implement server-side components for custom device provisioning, complete the following steps.

### Procedure

1. Create an adapter and name it ProvisioningAdapter.
2. Add two functions with the following signatures to the adapter’s JavaScript file:
  - The `validateCSR(clientDN, csrContent)` function is called only during initial device provisioning. The function is used to check whether the device is authorized to be provisioned. After the device is provisioned, this function is not called again.
  - The `validateCertificate(certificate, customAttributes)` function is called each time that the mobile application establishes a new session with the MobileFirst Server. The function is used to validate that the certificate that the application or device possesses is still valid and that the application or device is allowed to communicate with the MobileFirst Server.

**Note:** These functions are called internally by the MobileFirst authentication framework. Do not declare them in the adapter’s XML file.

3. Configure the `authenticationConfig.xml` file.
  - a. Add a realm and name it `CustomDeviceProvisioningRealm` to the `authenticationConfig.xml` file.
    - Use `CustomDeviceProvisioningLoginModule` for the `loginModule`.
    - Use the `auto provisioning authenticator className` parameter.
    - Add a `validate-csr-function` parameter.
    - The value of this parameter points to an adapter function that validates the certificate signing request (CSR).

```
<realms>
  <realm name="CustomDeviceProvisioningRealm"
    loginModule="CustomDeviceProvisioningLoginModule">
    <className>com.worklight.core.auth.ext.DeviceAutoProvisioningAuthenticator</className>
    <parameter name="validate-csr-function"
      value="ProvisioningAdapter.validateCSR" />
  </realm>
</realms>
```

- b. Add the `loginModule` named `CustomDeviceProvisioningLoginModule`.

- Use the auto provisioning login module `className` parameter.
- Add a `validate-certificate-function` parameter.
- The value of this parameter points to an adapter function that validates the certificate.

```
<loginModules>
  <loginModule name="CustomDeviceProvisioningModule">
    <className>com.worklight.core.auth.ext.DeviceAutoProvisioningLoginModule</className>
    <parameter name="validate-certificate-function"
      value="ProvisioningAdapter.validateCertificate" />
  </loginModule>
</loginModules>
```

c. Create a `securityTest` named `mobileSecurityTest`.

- Add a mandatory `<testAppAuthenticity />` test.
- Add a mandatory `<testDeviceId />` test.
- Specify `provisioningType="custom"`.
- Specify `realm="CustomDeviceProvisioningRealm"`.

```
<securityTests>
  <mobileSecurityTest name="CustomDeviceProvisioningSecurityTest">
    <testAppAuthenticity />
    <testDeviceId provisioningType="custom" realm="CustomDeviceProvisioningRealm" />
  </mobileSecurityTest>
</securityTests>
```

## Results

You implemented server-side components for custom device provisioning.

## Example

### validateCSR function

The following example shows the `validateCSR` function:

```
function validateCSR(clientDN, csrContent) {
  WL.Logger.log("validateCSR :: clientDN :: " + JSON.stringify(clientDN));
  WL.Logger.log("validateCSR :: csrContent :: " + JSON.stringify(csrContent));

  var activationCode = csrContent.activationCode;

  // This is a place to perform validation of csrContent and update clientDN if required.
  // You can do it using adapter backend connectivity
  if (activationCode == "worklight") {
    response = {
      isSuccessful: true,
      clientDN: clientDN + ",CN=someCustomData",
      attributes: {
        customAttribute: "some-custom-attribute"
      }
    };
  } else {
    response = {
      isSuccessful: false,
      errors: ["Invalid activation code"]
    };
  }

  return response;
}
```

### validateCertificate function

The following example shows the `validateCertificate` function:

```
function validateCertificate(certificate, customAttributes) {
  WL.Logger.log("validateCertificate :: certificate :: " + JSON.stringify(certificate));
  WL.Logger.log("validateCertificate :: customAttributes :: " + JSON.stringify(customAttributes));

  // Additional custom certificate validations can be performed here.
```

```
        return {
            isSuccessful: true
        };
    }
}
```

## What to do next

You can implement client-side components for custom device provisioning. For more information about implementing client-side components, see “Implementing client-side components for custom device provisioning.” For more information about custom device provisioning, see tutorial on the Getting Started page.

## Implementing client-side components for custom device provisioning

You can implement client-side components for custom device provisioning.

The following prerequisites are required for device provisioning:

- MobileFirst Server from MobileFirst Enterprise Edition or IBM MobileFirst Platform Foundation Consumer Edition.
- In the Application Center console, application authentication must be set to enabled, blocking.

The included MobileFirst Development Server can be used for device provisioning.

The following sections describe the implementation of the client-side components in iOS applications.

### Implementing client-side components for native iOS:

You can implement client-side components for custom device provisioning in native iOS.

### Before you begin

For more information about the prerequisites, see “Implementing client-side components for custom device provisioning.”

### About this task

To implement client-side components for custom device provisioning, complete the following steps.

### Procedure

1. Create a MobileFirst native API application for iOS.
2. Configure the application for the Application Authenticity test. The authenticity test works only with IBM MobileFirst Platform Foundation Consumer Edition and IBM MobileFirst Platform Foundation Enterprise Edition. For more information about application authenticity, see “MobileFirst application authenticity overview” on page 8-247.
3. Create an iOS native application and use the `wlConnectWithDelegate` function to connect to the server.
4. For the `wlConnectWithDelegate` function to trigger authentication, specify the MobileFirst native API application as a protected resource by adding a custom security test or mobile security test in the application descriptor.

```
<nativeIOSApp securityTest="MySecurityTest" version="1.0">
```

5. Add a new class CustomChallengeHandler and register it in the main by using `[[WLClient sharedInstance] registerChallengeHandler:[customChallengeHandler initWithRealm:@"wl_myCustomProvisioningRealm"]]`.
6. Implement the following methods, which are required by the challenge handler for device provisioning.

#### **createCustomCsr(challenge)**

This method is responsible for returning custom properties that are added to the certificate signing request (CSR). Add a custom **activationCode** property, which is used in the adapter's `validateCSR` function.

#### **handleSuccess(identity)**

This method is called when certificate validation is successfully completed by the `validateCertificate` adapter function.

#### **handleFailure()**

This method is called when certificate validation fails. You must call `clearDeviceProvisioningCertificate()` from this method to delete the stored certificate on the device.

Here is a sample implementation of a challenge handler for custom device provisioning:

```
@interface CustomChallengeHandler : BaseProvisioningChallengeHandler <WLDelegate>{
@private
    ViewController *vc;
}
- (id)initWithController: (ViewController *)mainView;
- (void) createCustomCsr : (NSDictionary *) challenge;
@property (nonatomic, strong)NSString *passcode;
@end

@implementation CustomChallengeHandler
- (id)initWithController: (ViewController *) mainView{
    if ( self = [super init] )
    {
        vc = mainView;
    }
    return self;
}
-(void) createCustomCsr : (NSDictionary *) challenge {
    [vc updateMessage:@"\nCreating custom Csr"];
    [vc updateMessage:[NSString stringWithFormat:@"\t Passcode :: %@", self.passcode]

    NSMutableDictionary* answer =[[NSMutableDictionary alloc] init];
    [answer setValue:self.passcode forKey:@"activationCode"];
    [self submitCsr:answer :challenge];
}
-(void)onSuccess:(WLResponse *)response {
    [vc updateMessage:@"Device authentication with custom device provisioning was successfully completed"];
    [vc updateMessage:response.description];
}
-(void)onFailure:(WLFailResponse *)response{
    [vc updateMessage:@"Server has rejected your device. You must reinstall the application and perform device provisioning again."];
    [vc updateMessage:response.description];
}
@end
```

## Results

You have implemented client-side components for custom device provisioning in native iOS.

## What to do next

You can implement server-side components for custom device provisioning. For more information, see “Implementing server-side components for custom device provisioning” on page 8-290. For more information about custom device provisioning, see the tutorial on the Getting Started page.

---

## Device single sign-on (SSO)

Single sign-on (SSO) enables users to access multiple resources (that is, applications and adapter procedures) by authenticating only once.

When a user successfully logs in through an SSO-enabled login module, the user gains access to all resources that are using the same login module, without having to authenticate again for each of them. The authenticated state remains alive as long as requests to resources protected by the login module are being issued within the timeout period, which is identical to the session timeout period.

### Device authentication

The SSO feature requires the use of device authentication. This means that for a protected resource that needs to be protected with SSO, there must also be a device authentication realm in the securityTest protecting the resource in the authenticationConfig.xml file. Device authentication should take place before the SSO-enabled user authentication.

### Performance

When you use the single sign-on feature, the load on the database might increase, and you might have to adjust the database configuration.

### Implementing a custom authentication to support SSO

To allow SSO to operate on your custom authentication classes (authenticator and loginModule) you must:

1. Make all fields in your class transient except for those fields that are being used by the following methods:
  - `WorklightAuthenticator.processRequestAlreadyAuthenticated(HttpServletRequest, HttpServletResponse)`
  - `WorklightAuthLoginModule.logout()`
2. Mark the authenticator and loginModule classes (and any class referred to by those classes that is not transient after you perform step 1) with the class annotation `@DeviceSSO(supported = true)`.

### Device SSO in the OAuth-based security model

OAuth resources are not protected by security tests and do not have a single defined user realm per resource, therefore the standard MobileFirst device SSO behavior does not apply for them.



However, in order to obtain an access token in the MobileFirst OAuth-based security model, the client is also required to pass the application's security test. If SSO is configured for this security test, it will function for the MobileFirst OAuth-based security model as it does for the classical MobileFirst security model.

## Configuring device single sign-on

Single sign-on (SSO) is a property of a login module. You can enable single sign-on for custom security tests and for mobile security tests.

### About this task

You can enable single sign-on from a `<mobileSecurityTest>` element or from a `<loginModule>` element of the `authenticationConfig.xml` configuration file. For custom security tests, you enable single sign-on on the `<loginModule>` element. For mobile security tests, you enable single sign-on on the `testUser` realm of the `<mobileSecurityTest>` element.

Basically, you configure SSO in the same way for native iOS applications as for hybrid applications. However, for native SSO to work on iOS, this additional step is mandatory: In Xcode, add a Keychain Access Group with the same name for all apps that participate in device SSO.

### Procedure

Take the following points into consideration, depending on how you choose to configure device single sign-on:

- When you configure `<mobileSecurityTest>` elements, enable single sign-on from the `<securityTest>` element by setting the value of the `sso` attribute to `true`. You can enable SSO for user realms only. If the `sso` attribute is not specified, it is assumed to be set to `false`. For example:

```
<mobileSecurityTest name="mst">
  <testDeviceId provisioningType="none"/>
  <testUser realm="myUserRealm" sso="true"/>
</mobileSecurityTest>
```

- When you configure `<customSecurityTest>` elements, enable single sign-on by configuring an `ssoDeviceLoginModule` property on the user login module in the authentication configuration file, where `ssoDeviceLoginModule` is the name of the login module that is used for the device authentication realm. For example:

```
<loginModule name="MySSO" ssoDeviceLoginModule="WLDeviceNoProvisioningLoginModule">
  <className>com.worklight.core.auth.ext.NonValidatingLoginModule</className>
</loginModule>
```

In this example, "MySSO" is the name of the user login module for which single sign-on is being enabled so that its login can be shared.

"WLDeviceNoProvisioningLoginModule" is the name of the login module that handles device authentication; in this case, with no provisioning. To use auto-provisioning as the device login module, set the `ssoDeviceLoginModule` property to the value "WLDeviceAutoProvisioningLoginModule". With custom provisioning, you define the name when you create the custom provisioning login module.

- When you configure `<customSecurityTest>` elements, you must configure the user realm at least one step later than the device realm. This is necessary to ensure that the SSO feature operates correctly. When you configure SSO on `<mobileSecurityTest>`, the platform takes care of this prioritization automatically. The following example illustrates a correct `<customSecurityTest>` configuration:

```
<customSecurityTest name="adapter">
  <test realm="wl_deviceNoProvisioningRealm" isInternalDeviceID="true" step="1"/>
  <test realm="MySSO" isInternalUserID="true" step="2"/>
</customSecurityTest>
```

- For Windows Phone 8, the following items must be implemented:
  - The Publisher ID specified in the WManifest.xml file must be the same for all applications that participate in the single sign-on.
  - The following line must be added to the WManifest.xml file:

```
<Capability Name='ID_CAP_IDENTITY_DEVICE' />
```

- A cleanup task cleans the database of orphaned and expired single-sign-on login contexts. To configure the cleanup task interval, use the **sso.cleanup.taskFrequencyInSeconds** server property and assign the required task interval value, expressed in seconds. For information about how to specify MobileFirst configuration properties, see “Configuration of MobileFirst applications on the server” on page 10-48.

## Results

Device single sign-on implementations are successful if they conform to any of the following valid configurations. Avoid inconsistent states that result from configurations with built-in conflicts, as described below. Inconsistent states can result in the MobileFirst project failing to start.

### Valid configurations:

- The <loginModule> element does not specify the **ssoDeviceLoginModule** attribute, and all mobile security tests that use this login module for their user realms have sso="false". In this case, SSO is disabled for all applications that are protected by security tests (mobile or custom) with this login module for a user realm. For example:

```
<securityTests>
  <mobileSecurityTest name="FormTest">
    <testDeviceId provisioningType="none"/>
    <testUser realm="SampleAppRealm" sso="false"/>
  </mobileSecurityTest>
  <mobileSecurityTest name="AnotherFormTest">
    <testDeviceId provisioningType="none"/>
    <testUser realm="SampleAppRealm" sso="false"/>
  </mobileSecurityTest>
</securityTests>
<realms>
  <realm name="SampleAppRealm" loginModule="StrongDummy">
    <className>com.worklight.core.auth.ext.FormBasedAuthenticator</className>
  </realm>
</realms>
<loginModules>
  <loginModule name="StrongDummy">
    <className>com.worklight.core.auth.ext.NonValidatingLoginModule</className>
  </loginModule>
</loginModules>
```

- The <loginModule> element does not specify the **ssoDeviceLoginModule** attribute, and all mobile security tests that use this login module for their user realms have sso="true". In this case, SSO is enabled for all applications that are protected by security tests (mobile or custom) with this login module for a user realm. For example:

```
<securityTests>
  <mobileSecurityTest name="FormTest">
    <testDeviceId provisioningType="none"/>
    <testUser realm="SampleAppRealm" sso="true"/>
  </mobileSecurityTest>
```

```

    <mobileSecurityTest name="AnotherFormTest">
      <testDeviceId provisioningType="none"/>
      <testUser realm="SampleAppRealm" sso="true"/>
    </mobileSecurityTest>
  </securityTests>
</realms>
  <realm name="SampleAppRealm" loginModule="StrongDummy">
    <className>com.worklight.core.auth.ext.FormBasedAuthenticator</className>
  </realm>
</realms>
<loginModules>
  <loginModule name="StrongDummy">
    <className>com.worklight.core.auth.ext.NonValidatingLoginModule</className>
  </loginModule>
</loginModules>

```

- The <loginModule> element specifies the **ssoDeviceLoginModule** attribute, and all mobile security tests that use this login module for their user realms have sso="true". In this case, SSO is enabled for all applications that are protected by security tests (mobile or custom) with this login module for a user realm. For example:

```

<securityTests>
  <mobileSecurityTest name="FormTest">
    <testDeviceId provisioningType="none"/>
    <testUser realm="SampleAppRealm" sso="true"/>
  </mobileSecurityTest>
  <mobileSecurityTest name="AnotherFormTest">
    <testDeviceId provisioningType="none"/>
    <testUser realm="SampleAppRealm" sso="true"/>
  </mobileSecurityTest>
</securityTests>
<realms>
  <realm name="SampleAppRealm" loginModule="StrongDummy">
    <className>com.worklight.core.auth.ext.FormBasedAuthenticator</className>
  </realm>
</realms>
<loginModules>
  <loginModule name="StrongDummy" ssoDeviceLoginModule="WLDeviceAutoProvisioningLoginModule">
    <className>com.worklight.core.auth.ext.NonValidatingLoginModule</className>
  </loginModule>
</loginModules>

```

### Single sign-on inconsistent state

Avoid conflicts in the single sign-on configuration of a login module. Such conflicts cause inconsistency in the single sign-on state of the login module, and can lead to unexpected results.

A conflict can exist between the configuration of a <loginModule> element and the configuration of a <mobileSecurityTest> element. Such conflict can happen when you enable single sign-on of a login module in the <loginModule> element and then disable single sign-on for the same login module, by using it in a <mobileSecurityTest> without specifying sso="true" for the realm of this <loginModule>. For example:

```

<securityTests>
  <mobileSecurityTest name="FormTest">
    <testDeviceId provisioningType="none"/>
    <testUser realm="SampleAppRealm"/>
  </mobileSecurityTest>
</securityTests>
<realms>
  <realm name="SampleAppRealm" loginModule="StrongDummy">
    <className>com.worklight.core.auth.ext.FormBasedAuthenticator</className>
  </realm>
</realms>

```

```

<loginModules>
  <loginModule name="StrongDummy" ssoDeviceLoginModule="WLDeviceAutoProvisioningLoginModule">
    <className>com.worklight.core.auth.ext.NonValidatingLoginModule</className>
  </loginModule>
</loginModules>

```

Another case of conflict can happen between different <mobileSecurityTest> elements, when two <mobileSecurityTest> elements use the same login module, with conflicting values for the **sso** attribute. In this example, the same realm contains conflicting **sso** enablement states in two <mobileSecurityTest> elements.

```

<securityTests>
  <mobileSecurityTest name="FormTest">
    <testDeviceId provisioningType="none"/>
    <testUser realm="SampleAppRealm"/>
  </mobileSecurityTest>
  <mobileSecurityTest name="FormTestWithSso">
    <testDeviceId provisioningType="none"/>
    <testUser realm="SampleAppRealm" sso="true"/>
  </mobileSecurityTest>
</securityTests>

```

Here is another example, in which the same login module is used for different realms with conflicting SSO enablement states in two <mobileSecurityTest> elements:

```

<securityTests>
  <mobileSecurityTest name="FormTest">
    <testDeviceId provisioningType="none"/>
    <testUser realm="SampleAppRealm"/>
  </mobileSecurityTest>
  <mobileSecurityTest name="FormTestWithSso">
    <testDeviceId provisioningType="none"/>
    <testUser realm="SampleAppRealmWithSso" sso="true"/>
  </mobileSecurityTest>
</securityTests>
<realms>
  <realm name="SampleAppRealm" loginModule="StrongDummy">
    <className>com.worklight.core.auth.ext.FormBasedAuthenticator</className>
  </realm>
  <realm name="SampleAppRealmWithSso" loginModule="StrongDummy">
    <className>com.worklight.core.auth.ext.FormBasedAuthenticator</className>
  </realm>
</realms>

```

## What to do next

When you use a reverse proxy, more configuration and settings are necessary. Either of the following options allow device SSO to work with a reverse proxy.

### Device single sign-on with the IBM Security Access Manager Web reverse proxy

Additional configuration and settings are required when you use the IBM Security Access Manager Web reverse proxy.

You can configure the IBM Security Access Manager Web reverse proxy or IBM Security Access Manager WebSEAL when you enable device SSO to delegate user authentication to the MobileFirst Device SSO realm. For more information about the required configurations and samples, see IBM Security Access Manager for IBM MobileFirst Platform Foundation for iOS.

This option is supported on all mobile platforms and you can use the IBM Security Access Manager features such as Risk-Based Access (RBA), Context-Based Access (CBA), Strong Authentication (One-time password), and Identity aware applications (OAuth) to further enhance security.

## Configuring device single sign-on with a reverse proxy

Additional configuration and settings are required when you use a reverse proxy.

### Before you begin

Ensure that you configured device single sign-on as explained in “Configuring device single sign-on” on page 8-295.

### About this task

#### Device SSO and reverse proxies

Device single sign-on with a reverse proxy can also be achieved with the “Simple data sharing” on page 8-253 feature. The Simple Data Sharing feature allows a set of applications to share authentication cookies that allow access through the reverse proxy and delegate authentication to the MobileFirst Server Device SSO realm.

With the Simple Data Sharing feature, you can tell the MobileFirst client runtime environment to share credentials among applications in the same MobileFirst application family. Because you are working with security tokens, you must ensure that access to the applications is protected by other mechanisms. For example, ensure that the device is not jailbroken, and that the device is password-protected. For more information, see “Simple data sharing limitations and special considerations” on page 8-256.

The following steps show how to configure device single sign-on with a reverse proxy.

### Procedure

1. Enable the Simple Data Sharing feature as explained in “Enabling the Simple Data Sharing feature” on page 8-254.
2. For hybrid applications, follow these steps.
  - a. Ensure that you select the MobileFirst device SSO option.
  - b. Specify a comma-separated list of cookie names that you want IBM MobileFirst Platform Foundation for iOS to remember and share among the applications in your specified family.

#### Enable MobileFirst Device SSO - Reverse Proxy

Enable this option when you use a device single sign-on (SSO) enabled security realm and a reverse proxy. Specify the reverse proxy user authentication cookie(s) to share among members of the same application family.

Cookies:

3. For native applications, follow these steps.
  - a. Add the `wlShareCookies` property in the MobileFirst properties file.

- b. Specify a comma-separated list of cookie names that you want IBM MobileFirst Platform Foundation for iOS to remember and share among the applications in your specified family.

```
wlShareCookies = PD-S-SESSION-ID
```

Each application in the MobileFirst family must be enabled for simple data sharing, and must also specify the cookie, which it agrees to share and reuse. For example, you can specify any one of the PD-\*SESSION-ID cookies for IBM Security Access Manager or the Ltpatoken or Ltpatoken2 cookies for IBM WebSphere DataPower.

## Results

You have configured device single sign-on with a reverse proxy.

---

## Developing accessible applications

To develop *accessible* applications, easily used by people with disabilities, this topic helps you to learn about resources available to improve the accessibility of your apps.

When you build an application for your business, it is important to consider the user experience of individuals with a disability or impairment. Taking steps to consider enablement of tools like screen magnification, audio assistance, or other assistive technologies can extend the reach of your business.

In general, mobile applications can be made highly accessible. This following sections provide resources to help you make your mobile application as accessible as possible. IBM MobileFirst Platform Foundation for iOS provides a strong foundation for building accessible applications because it supports industry standards and allows you to leverage them.

### Native application accessibility

If your application is native, the ability to make it accessible is determined by the capabilities of the target platform itself. The links that follow provide resources for the supported mobile platforms, laying out available options and capabilities.

- **iOS**
  - Accessibility in iOS
  - Understanding Accessibility on iOS
  - iOS. A wide range of features for a wide range of needs.

---

## Client-side log capture

Applications in the field occasionally experience problems that require a developer's attention to fix. It is often difficult to reproduce problems in the field. Developers who worked on the code for the problem application often do not have the environment or exact device with which to test. In these situations, it is helpful to be able to retrieve debug logs from the client devices as the problems occur in the environment in which they happen.

Starting in IBM Worklight V6.2.0, developers that use MobileFirst client-side APIs who want to capture both platform (IBM MobileFirst Platform Foundation for iOS)

and application (your code) logs for debug and problem determination should use the appropriate client-side APIs. By doing so, debug log data is made available for capture and sending to the server.

## Introduction to client-side logging

The APIs that are available with MobileFirst client libraries include a logger in JavaScript and iOS native code base. The logger API is similar to commonly used logger APIs, such as `console.log` (JavaScript), `java.util.logging` (Java), and `NSLog` (Objective-C). The MobileFirst logger API has the additional capability of persistently capturing logged data for sending to the server to be used for analytics gathering and developer inspection. Use the logger APIs to report log data at appropriate levels so that developers who inspect logs can triage and fix problems without having to reproduce problems in their labs.

There are seven levels. From least verbose to most verbose, they are FATAL, ERROR, WARN, INFO, LOG, DEBUG, TRACE.

Example usage of level-appropriate messages:

- Use TRACE for method entry and exit points.
- Use DEBUG for method result output.
- Use LOG for class instantiation.
- Use INFO for initialization reporting.
- Use WARN to log deprecated usage warnings.
- Use ERROR for unexpected exceptions or unexpected network protocol errors.
- Use FATAL for unrecoverable crashes or hangs.

## Default log feature behavior

- Log capture is ON.
- During development, the default log level is DEBUG.
  - On iOS, development mode means that the DEBUG macros is defined.
- In production, the default log level is FATAL.
  - On iOS, production mode means that the DEBUG macros is not defined.
- Log persistent client-side buffer maximum size is 100k bytes.
  - Log entries are treated as a first in, first out (FIFO) queue; oldest log entries are deleted to make room for more recent log entries.
- Log configuration set at the server by the MobileFirst administrator is piggybacked on responses to explicit `WLClient` connect and `invokeProcedure` API calls, and is applied automatically.
- All captured log data, if any, is sent to the MobileFirst Server during each successful client network `init` sequence and `invokeProcedure` response, with a 60 second minimum interval between sends.
  - Turn this automatic behavior on or off by using one or more of the following options:
    - `Logger.setAutoSendLogs(boolean)`
    - `OCLogger.setAutoSendLogs(boolean)`
    - `WL.Logger.config({autoSendLogs: boolean})`
  - After automatic behavior is turned off, you must explicitly call the `send` method (in both the `Logger` and `Analytics` classes) in your application to send any persistently captured client logs to the MobileFirst Server.

**Note:** For example, when capture is ON and the logger level is configured to FATAL, the logger captures uncaught exceptions and only logs at the FATAL level. It would not capture logs at ERROR, WARN, or INFO that may lead up to that failure. Alternatively, a more verbose logger level would also capture non-FATAL level logs leading up to the FATAL entry.

## During development

- Developers should make liberal and reasonable use of the client-side logger APIs.
- Client-side logs that are uploaded to the embedded Liberty server in IBM MobileFirst Platform Foundation for iOS are written to files under the `clientlogs` folder. This folder is a peer to the `logs` folder of the embedded server.
  - Verifying this behavior is a good way to confirm the expected behavior of your usage of the API.

## In production

- Logger configuration is controllable from the MobileFirst Operations Console. Configuration that is retrieved from the server is used as an override of the locally set configuration. Clients revert to the pre-override configuration when the MobileFirst administrator removes the logger configuration and the client retrieves the instruction from the server.

## Things to consider

During application development, consider the following questions.

### Should capture be always on or always off?

The default setting of capture is ON. When capture is on, all logs at the specified level or filter are captured in a persisted rotating log buffer. You can change the default of the capture setting by using the logger API.

Consider that turning capture on at a verbose logger level has an impact to resource consumption:

- CPU
- File system space
- frequency of network usage when captured log data is also being sent to the server
- size of network payload when captured log data is also being sent to the server

### At what level should you set the logger?

There are seven levels. From least verbose to most verbose, they are FATAL, ERROR, WARN, INFO, LOG, DEBUG, TRACE.

For example, when capture is ON and the logger level is configured to FATAL, the logger captures uncaught exceptions and only logs at the FATAL level. It will not capture logs at ERROR, WARN, or INFO that may lead up to that failure. Alternatively, a more verbose logger level will also capture non-FATAL level logs leading up to the FATAL entry.

Consider that verbose logger levels, when capture is ON, can affect:

- frequency of network usage
- size of the payload that is sent to the server
- application performance, and therefore user experience



### How frequently should clients check with the server for logger configuration changes?

By default, client applications check for updated logger configuration during the MobileFirst client network `init` sequence, which is not necessarily application startup or application foreground events.

The `init` sequence can be infrequent, depending on the design of your application. For example, the `init` sequence might happen only at check-out in a retail shopping application. In this example, the application can check for new configuration on every `onForeground` event to ensure that it retrieves and applies the configuration soon after the MobileFirst administrator sets in the **Catalog** tab of the MobileFirst Operations Console.

For example, to retrieve and apply configuration overrides from the server when the client comes to the foreground, you can place the `WLClient updateConfigFromServer` function call:

- `applicationDidBecomeActive` (iOS)

### How can you guarantee that all captured log data on the client gets to the server?

The short answer is that there is no way to guarantee preservation of all captured data. Clients might be running the application offline and simultaneously accumulating captured log data. Because the client is offline with limited file system space, older log data must be purged in favor of preserving more recent log data, which is the behavior of the log capture feature.

You can make a best effort at ensuring that all captured data gets to the server by applying one or more of the following strategies:

- Call the `send` function on a time interval.
- Trigger a call to the `send` function on application lifecycle events, like pause and resume events.
- Batch the `send` call with other application network activity, like `invokeProcedure`. This approach allows the device radio to sleep and preserve battery.
- Increase the capacity of the persistent log buffer on the client by calling the `setMaxFileSize` function.

### How can you capture logs from your application only, and exclude logger entries from MobileFirst code?

If your application code is making good use of the MobileFirst logger API, and you want to capture logs from your application only, you can use a consistent package name or consistent set of package names for your logger instances. For example:

```
• // iOS
  OCLoggerDebugWithPackage(@"MyPackage", @"this is a debug message");
  // or Info, Log, Warn, and so on
```

or

```
// iOS
OCLogger* logger = [OCLogger getInstanceWithPackage:@"MyPkg"];
[logger debug:@"this is a debug message"];
// or Info, Log, Warn, and so on
```

Then, set the filters on the logger to allow logging only for your package or packages:

```
• // iOS
  [OCLogger setFilters:@{@"MyAppPkg": @(OCLogger_DEBUG)}];
```

### How can you never collect or send logs from deployed apps in the field?

Call `setCapture(false)` as early as possible in your application lifecycle code to set the default behavior. Avoid the **Client Log Profiles** tab of the MobileFirst Operations Console.

## Server preparation for uploaded log data

You must prepare your server to receive uploaded client log data.

Upon receiving uploaded client logs, the MobileFirst production server passes the uploaded data to the Operational Analytics component feature and to an adapter that you create and deploy. Neither of these options are present in a production MobileFirst Server; you must install and configure them. To receive and persist uploaded client logs at the MobileFirst Server, you must take at least one of the following two actions:

1. Install the IBM MobileFirst Platform Operational Analytics as described in “Installing the IBM MobileFirst Platform Operational Analytics” on page 6-145.
2. Deploy an adapter that is named `WLCClientLogReceiver` or the name that corresponds to the value of the `wl.clientlogs.adapter.name` JNDI property.

If you deploy an adapter to receive uploaded client logs, the adapter must be an HTTP adapter that is named `WLCClientLogReceiver` or the value of the `wl.clientlogs.adapter.name` JNDI property. The adapter must have at least one procedure that must be named `log`. The `log` procedure is passed two parameters: `deviceInfo` (a JSON object) and `logMessages` (a JSON array). For more information about implementing adapter procedures, see “Implementing adapter procedures” on page 8-149.

The procedure element in the `WLCClientLogReceiver.xml` file for `log`:

```
<procedure name="log" />
```

The implementation of the adapter determines the destination of the uploaded log content.

One convenient way to persistently record uploaded client logs is to place the `audit="true"` attribute in the adapter's procedure element. This flag instructs the MobileFirst Server to report all adapter invocations and parameter arguments inline to the server log file:

```
<procedure name="log" audit="true" />
```

Alternatively, you process the parameters that are passed into the `log` procedure explicitly.

## Server security

By default, there is no security that protects the `loguploader` servlet that receives uploaded client logs and analytics at the MobileFirst Server. You can configure the security tests that protect the servlet in the `authenticationConfig.xml` file. But to avoid unexpectedly prompting the user for authentication credentials when you send logs, you have two choices:

1. Use a security test that requires no custom challenge handler code and no user interaction, and freely call the logger `send` function.
2. Ensure that the security test in front of the servlet remains the same as the security test of the application, and be careful about placement of extra logger `send` function calls.

If you choose to change the security test, and you choose option one, an explicit call to the logger send function does not result in an unexpected authentication challenge prompt or other authentication failure. The logger send function is safe to place throughout your application.

If you choose to change the security test, and you choose option two, a carelessly placed call to the logger send function might result in an unexpected authentication challenge prompt or other authentication failure. In this case, explicit calls to the logger send function in your application must be placed carefully. If your client applications call the logger send function explicitly, ensure that they do so after authentication succeeds. For example, call the logger send function in the `invokeProcedure onSuccess` callback of an adapter invocation that is protected by the same security test as the log receiver servlet.

## Logging sensitive data

The logger library does not automatically protect against logging sensitive data. Data is stored in plain text, but is only readable within the context of the application that is using the logger API. Avoid logging sensitive data

## Uploaded client logs

In the embedded Liberty development server, the uploaded client logs are written to a file that corresponds with that client's unique attributes. The uploaded client log file is written, or appended, at the following path, which is a peer to the `logs` folder:

```
clientlogs/[os]/[os_version]/[app_id]/[app_version]/[device_id].log
```

Uploaded logs are not written to the file system in MobileFirst production servers.

## Client-side log capture configuration from MobileFirst Operations Console

In the redesigned MobileFirst Operations Console, administrators can use the Client Log Profile link of a runtime environment to adjust client logger configuration.

Administrators can adjust the log level and log package filters for any combination of operating system, operating system version, application, application version, and device model.

When the MobileFirst administrator creates a configuration profile, the log configuration is concatenated with responses to explicit `WLClient connect` and `invokeProcedure` API calls, and is applied automatically.

When the MobileFirst administrator removes a configuration profile, on the next client application `WLClient connect` and `invokeProcedure` API calls, the client reverts to its configuration before the server configuration profile override.

## What is provided on the client side

OCLogger

**Note:** Native iOS code that calls `nslog` directly is not captured in the client-side logs. Developers must use `OCLogger` to capture client-side logs. For more information about the `OCLogger` API, see “Objective-C client-side API for iOS apps” on page 9-2.

---

## MobileFirst Filtered Export

You can use the MobileFirst Filtered Export option to export only the required MobileFirst project resources to an archive file on the local system. Filtered Export ignores the files that are generated at build time, resulting in a smaller file than the previous method of exporting.

### Before you begin

To complete this export, you must select a valid MobileFirst project. Any other project is not eligible for Filtered Export.

### Procedure

1. Right-click the MobileFirst project, then select **Export**.
2. In the Export window that appears, expand **IBM MobileFirst**.
3. Select **MobileFirst Filtered Export**.
4. Click **Next**.
5. Click **Browse** to complete the file path of the **To archive file** field. The only valid file extension is `.zip`.
6. Click **Finish**.

---

## API reference

To develop your iOS applications, refer to the MobileFirst API in Objective-C.

---

### MobileFirst client-side API

This collection of topics contains a description of the application programming interface (API) for use in writing client applications with IBM MobileFirst Platform Foundation for iOS.

You can use MobileFirst client-side API capabilities to improve application development, and MobileFirst server-side API to improve client/server integration and communication between mobile applications and back-end systems.

With the MobileFirst client-side API, your mobile application has access to various MobileFirst features during run time, by using libraries that are bundled into the application. The libraries integrate your mobile application with MobileFirst Server by using predefined communication interfaces. The libraries also provide unified access to native device functionality, which simplifies application development.

The MobileFirst client-side API provide access to MobileFirst functions across multiple device platforms and development approaches. Applications that are built by using web technologies can access MobileFirst Server through the APIs by using JavaScript, and application using native components can access the APIs directly by using Java and Objective-C. Mobile applications developed with the native development approach benefit from simplified application security and the integration features of MobileFirst tooling.

MobileFirst client-side API components also provide the following features, which improve application development.

#### Client to server integration

Client to server integration ensures transparent communication between a mobile application that is built with MobileFirst technology, and MobileFirst Server. MobileFirst mobile applications always use an SSL-enabled connection to the server, including for authentication. With such an integration, you can manage your applications and implement security features such as remotely disabling the ability to connect to MobileFirst Server, or updating the web resources of an application.

#### Encrypted data store

This encrypted data store is located on the device and can access private data by using an API. This helps prevent malicious users to access private data, because all they can obtain is highly encrypted data. The encryption uses ISO/IEC 18033-3 security standards, such as AES256 or PKCS#5, that complies with the United States National Security Agency regulations for transmitting confidential or secret information. The key that is used to encrypt the information is unique to the current user of the application and the device. MobileFirst Server issues a special key when a new encrypted data store is created.

## JSONStore

A JSONStore store is included in IBM MobileFirst Platform Foundation for iOS to synchronize mobile application data with related data on the back-end. JSONStore provides an offline-capable, key-value database that can be synchronized. JSONStore implements the application local read, write, update, and delete operations and use the MobileFirst adapter technology to synchronize the related back-end data.

## Runtime skinning

Runtime skinning is a feature that helps you incorporate an adaptive design that you can adapt to each mobile device. The MobileFirst runtime skin is a user-interface variant that you can apply during application run time, which is based on device properties such as operating system, screen resolution, and form factor. This type of user-interface abstraction helps you develop applications for multiple mobile device models at the same time.

## Location services API

IBM MobileFirst Platform Foundation for iOS provides a number of functions for location services. Location services enable you to use Geo and WiFi positions to perform various actions.

## Objective-C client-side API for iOS apps

Use this API to develop native app for iOS environment.

You can access MobileFirst services from iOS applications by using this Objective-C client-side API.

**Note:** To develop native iOS applications, you can also use Apple Swift. This language is compatible with Objective-C. For more information about using MobileFirst API from within the Swift project, see “Creating a Swift project” on page 8-8.

You can also find the description of the API in the following file: Objective-C client-side API for iOS apps.

---

## MobileFirst server-side API

Use the server-side API that IBM MobileFirst Platform Foundation for iOS defines to modify the behavior of the servers that your mobile applications rely on.

MobileFirst Server provides a set of mobile capabilities with the use of client/server integration and communication between mobile applications and back-end systems.

## Server-side application code

You can develop server-side application code and optimize performance, security, and maintenance. By developing server-side application code, your mobile application has direct access to back-end transactional capabilities and cloud-based services. This improves error handling, and enhances security by including more custom steps for request validation or process authorization.

## Built-in JSON translation capability

A built-in JSON translation capability reduces the footprint of data transferred between the mobile application and MobileFirst Server. JSON is a lightweight and human-readable data interchange format. Because JSON messages have a smaller footprint than other comparable data-interchange formats, such as XML, they can be more quickly parsed and generated by mobile devices. In addition, MobileFirst Server can automatically convert hierarchical data to the JSON format to optimize delivery and consumption.

## Built-in security framework

You can use encryption and obfuscation techniques with a built-in security framework to protect both user-specific and application business logic. A built-in security framework provides easy connectivity or integration into your existing enterprise security mechanisms. This security framework handles connection credentials for back-end connectivity, so the mobile application can use a back-end service, without having to know how to authenticate with it. The authentication credentials stay with MobileFirst Server, and do not stay on the mobile device. If you are running MobileFirst Server with IBM WebSphere Application Server, you can use enterprise-class security and enable Single-Sign-On (SSO) by using IBM Lightweight Third Party Authentication (LTPA).

## Adapter library

You can use the adapter library to connect to various back-end systems, such as web services, databases, and messaging applications. For example, IBM MobileFirst Platform Foundation for iOS provides adapters for SOAP or XML over HTTP, JDBC, and JMS. Extra adapters simplify integration with IBM WebSphere Cast Iron, which in turn supplies connectors for various cloud-based or on-premise services and systems. With the adapter library, you can define complex lookup procedures and combine data from multiple back-end services. This aggregation helps to reduce overall traffic between a mobile application and MobileFirst Server.

## Unified push notification

You can use unified push notification, which simplifies the notification process because the application remains platform-neutral. Unified push notification is an abstraction layer for sending notifications to mobile devices by using either the device vendor's infrastructure or MobileFirst Server SMS capabilities. The user of a mobile application can subscribe to notifications through the mobile application. This request, which contains information about the device and platform, is sent to the MobileFirst Server. The system administrator can manage subscriptions, push or poll notifications from back-end systems, and use the Application Center to send notifications to mobile devices.

## JavaScript server-side API

The MobileFirst server-side JavaScript API comprises a series of packages.

For more information about these packages and their content, expand the entry for this topic in the **Contents** panel, and see the *Overview* topic and the *Classes* topic listed there.

You can also find the description of the API in the following file: JavaScript server-side API.

## Java server-side API

The MobileFirst server-side Java API comprises a series of packages.

For more information about these packages and their content, expand the entry for this topic in the **Contents** panel, and see the *Overview* topic listed there.

You can also find the description of the API in the following file: Java server-side API.

---

## MobileFirst OAuth TAI API

Use this API when your application uses OAuth TAI (Trust Association Interceptors) security. It contains the WLCredential class, which stores the IBM MobileFirst token information of an authenticated principal.

You can also find the description of the API in the following file: OAuth TAI API

---

## REST Services API

The REST API provides several services to administer the runtime environments concerning adapters, applications, devices, audit, transactions, security, and push notifications.

The REST service API for adapters and applications for each runtime environment is located in `/management-apis/1.0/runtimes/runtime-name/`, where *runtime-name* is the name of the runtime environment that is administered through the REST service. Then, the type of object addressed by the service is identified together with the appropriate method. For example, `/management-apis/1.0/runtimes/runtime-name/Adapters` (POST) refers to the service for deploying an adapter.

### Adapter Binary (GET, HEAD)

Retrieves the binary of a specific adapter.

#### Description

It supports range requests to deliver only a range of the bytes of the adapter. Clients can use this feature to resume a download after interruption.

#### Roles

Users in the following roles are authorized to perform this operation:

- **worklightadmin**
- **worklightdeployer**

#### Method

GET, HEAD

#### Path

`/otu/1.0/one-time-url-hash/runtimes/runtime-name/downloads/adapters/adapter-name`



## Example

`https://www.example.com/worklightadmin/otu/1.0/ffabc301/runtimes/myruntime/downloads/adapters/myadapter?locale=de_DE`

## Path Parameters

### **runtime-name**

The name of the runtime. This is the context root of the runtime web application, without the leading slash.

### **adapter-name**

The name of the adapter.

### **one-time-url-hash**

The one-time-url hash code.

## Query Parameters

Query parameters are optional.

### **locale**

The locale used for error messages.

## Produces

application/octet-stream

## Response

The binary data of the specified adapter.

## Errors

400

The request is invalid.

403

The user is not authorized to call this service.

404

The corresponding runtime or the adapter is not found.

416

The requested range of bytes is not satisfiable.

500

An internal error occurred.

## Adapter (DELETE)

Deletes a specific adapter.

### Description

This transaction can run synchronously or asynchronously. If processed asynchronously, the REST service returns before the transaction is completed. In this case, you can query the transaction result later with the transaction REST service.

## Roles

Users in the following roles are authorized to perform this operation:

- **worklightadmin**
- **worklightdeployer**

## Method

DELETE

## Path

*/management-apis/1.0/runtimes/runtime-name/adapters/adapter-name*

## Example

[https://www.example.com/worklightadmin/management-apis/1.0/runtimes/myruntime/adapters/myadapter?async=false&locale=de\\_DE](https://www.example.com/worklightadmin/management-apis/1.0/runtimes/myruntime/adapters/myadapter?async=false&locale=de_DE)

## Path Parameters

### **runtime-name**

The name of the runtime. This is the context root of the runtime web application, without the leading slash.

### **adapter-name**

The name of the adapter.

## Query Parameters

Query parameters are optional.

### **async**

Whether the transaction is processed synchronously or asynchronously. Allowed values are true and false. The default is synchronous processing.

### **locale**

The locale used for error messages.

## Produces

application/json, application/xml, text/xml

## Response

The metadata of the deleted adapter.

## JSON Example

```
{
  "ok" : false,
  "productVersion" : "7.0.0",
  "transaction" : {
    "appServerId" : "Tomcat",
    "description" : {
      "filename" : "myadapter.adapter",
      "name" : "myadapter",
    },
  },
  "errors" : [
    {
      "details" : "An internal error occured.",
    }
  ]
}
```

```

    },
    ...
  ],
  "id" : 1,
  "project" : {
    "name" : "myproject",
  },
  "status" : "FAILURE",
  "timeCreated" : "2014-04-13T00:18:36.979Z",
  "timeUpdated" : "2014-04-14T00:18:36.979Z",
  "type" : "DELETE_ADAPTER",
  "userName" : "demouser",
},
}

```

## XML Example

```

<?xml version="1.0" encoding="UTF-8"?>
<delete-adapter-result
  ok="false"
  productVersion="7.0.0">
  <transaction
    appServerId="Tomcat"
    id="1"
    status="FAILURE"
    timeCreated="2014-04-13T00:18:36.979Z"
    timeUpdated="2014-04-14T00:18:36.979Z"
    type="DELETE_ADAPTER"
    userName="demouser">
    <description
      filename="myadapter.adapter"
      name="myadapter"/>
    <errors>
      <error details="An internal error occured."/>
      ...
    </errors>
    <project name="myproject"/>
  </transaction>
</delete-adapter-result>

```

## Response Properties

The response has the following properties:

**ok** Whether the transaction was successful.

**productVersion**  
The exact product version.

**transaction**  
The details of the transaction.

The *transaction* has the following properties:

**appServerId**  
The id of the web application server.

**description**  
The details of the adapter.

**errors**  
The errors occurred during the transaction.

**id** The id of the transaction.

**project**  
The current project.

**status**

The state of the transaction: PENDING, PREPARING, COMMITTING, REJECTING, SUCCESS, FAILURE, CANCELED. Synchronous transactions can have the state SUCCESS and FAILURE. Asynchronous transactions can also have the other states.

**timeCreated**

The date in ISO 8601 format when the adapter was created.

**timeUpdated**

The date in ISO 8601 format when the adapter was updated.

**type**

The type of the transaction, here always DELETE\_ADAPTER.

**userName**

The user that initiated the transaction.

The *description* has the following properties:

**filename**

The optional file name of the adapter.

**name**

The name of the adapter.

The *error* has the following properties:

**details**

The main error message.

The *project* has the following properties:

**name**

The name of the project, which is the context root of the runtime.

**Errors**

403

The user is not authorized to call this service.

404

The corresponding runtime or the adapter is not found.

500

An internal error occurred.

**Adapter (GET)**

Retrieves metadata of a specific adapter.

**Roles**

Users in the following roles are authorized to perform this operation:

- **worklightadmin**
- **worklightdeployer**
- **worklightmonitor**
- **worklightoperator**

## Method

GET

## Path

*/management-apis/1.0/runtimes/runtime-name/adapters/adapter-name*

## Example

`https://www.example.com/worklightadmin/management-apis/1.0/runtimes/myruntime/adapters/myadapter?locale=de_DE`

## Path Parameters

### **runtime-name**

The name of the runtime. This is the context root of the runtime web application, without the leading slash.

### **adapter-name**

The name of the adapter.

## Query Parameters

Query parameters are optional.

### **locale**

The locale used for error messages.

## Produces

application/json, application/xml, text/xml

## Response

The metadata of the specified adapter.

## JSON Example

```
{
  "deployTime" : "2014-04-13T00:18:36.979Z",
  "description" : "My first sample adapter",
  "link" : "https://www.example.com/worklightadmin/management-apis/1.0/runtimes/myruntime/adapters/myadapter",
  "name" : "myadapter",
  "platformVersion" : "6.1.0.00.20131126-0630",
  "procedures" : [ "getSomething", ... ],
  "productVersion" : "7.0.0",
  "projects" : [
    {
      "name" : "myproject",
    },
    ...
  ],
  "urls" : [
    {
      "formParameters" : [
        {
          "defaultValue" : "n/a",
          "javaType" : "java.lang.String",
          "name" : "param",
        },
        ...
      ],
    },
    ...
  ],
}
```

```

    "javaClass" : "com.example.MyRestWrapper",
    "javaMethodName" : "multiplyNumbers",
    "method" : "POST",
    "pathParameters" : [
      {
        "defaultValue" : "n/a",
        "javaType" : "java.lang.String",
        "name" : "param",
      },
      ...
    ],
    "queryParams" : [
      {
        "defaultValue" : "n/a",
        "javaType" : "java.lang.String",
        "name" : "param",
      },
      ...
    ],
    "uri" : "/multiply",
  },
  ...
],
}

```

## XML Example

```

<?xml version="1.0" encoding="UTF-8"?>
<adapter
  deployTime="2014-04-13T00:18:36.979Z"
  description="My first sample adapter"
  link="https://www.example.com/worklightadmin/management-apis/1.0/runtimes/myruntime/adapters/myadapter"
  name="myadapter"
  platformVersion="6.1.0.00.20131126-0630"
  productVersion="7.0.0">
  <procedures>
    <procedure>getSomething</procedure>
    ...
  </procedures>
  <projects>
    <project name="myproject"/>
    ...
  </projects>
  <urls>
    <url
      javaClass="com.example.MyRestWrapper"
      javaMethodName="multiplyNumbers"
      method="POST"
      uri="/multiply">
      <formParameters>
        <formParameter
          defaultValue="n/a"
          javaType="java.lang.String"
          name="param"/>
        ...
      </formParameters>
      <pathParameters>
        <pathParameter
          defaultValue="n/a"
          javaType="java.lang.String"
          name="param"/>
        ...
      </pathParameters>
      <queryParams>
        <queryParameter
          defaultValue="n/a"
          javaType="java.lang.String"

```

```

        name="param"/>
        ...
    </queryParams>
</url>
    ...
</urls>
</adapter>

```

## Response Properties

The response has the following properties:

### **deployTime**

The date in ISO 8601 format when the adapter was deployed.

### **description**

The description of the adapter.

### **link**

The URL to access detail information about the adapter.

### **name**

The name of the adapter.

### **platformVersion**

The exact version number of the IBM MobileFirst Platform Foundation development tools (Studio) that built the adapter.

### **procedures**

The JavaScript procedures of the adapter.

### **productVersion**

The exact product version.

### **projects**

The projects the adapter belong to.

### **urls**

The API documentation of the URLs of the REST API provided by the adapter.

The *project* has the following properties:

### **name**

The name of the project, which is the context root of the runtime.

The *url* has the following properties:

### **formParameters**

The form parameters.

### **javaClass**

The Java class

### **javaMethodName**

The Java method

### **method**

The HTTP method.

### **pathParameters**

The path parameters.

### **queryParams**

The query parameters.

**uri**

The URI of the REST API.

The *REST API parameter* has the following properties:

**defaultValue**

The default value.

**javaType**

The Java type name.

**name**

The name of the parameter.

**Errors**

403

The user is not authorized to call this service.

404

The corresponding runtime or the adapter is not found.

500

An internal error occurred.

## Adapter (POST)

Deploys an adapter.

### Description

It first checks whether the input adapter is valid. Then, it transfers the adapter to the database and to the runtime.

This transaction can run synchronously or asynchronously. If processed asynchronously, the REST service returns before the transaction is completed. In this case, you can query the transaction result later with the transaction REST service.

### Roles

Users in the following roles are authorized to perform this operation:

- **worklightadmin**
- **worklightdeployer**

### Method

POST

### Path

`/management-apis/1.0/runtimes/runtime-name/adapters`

### Example

`https://www.example.com/worklightadmin/management-apis/1.0/runtimes/myruntime/adapters?async=false&locale=de_DE`



## Path Parameters

### **runtime-name**

The name of the runtime. This is the context root of the runtime web application, without the leading slash.

## Query Parameters

Query parameters are optional.

### **async**

Whether the transaction is processed synchronously or asynchronously. Allowed values are true and false. The default is synchronous processing.

### **locale**

The locale used for error messages.

## Consumes

multipart/form-data

## Produces

application/json, application/xml, text/xml

## Response

The metadata of the deployed adapter.

## JSON Example

```
{
  "ok" : false,
  "productVersion" : "7.0.0",
  "transaction" : {
    "appServerId" : "Tomcat",
    "description" : {
      "alreadyDeployed" : false,
      "filename" : "myadapter.adapter",
      "name" : "myadapter",
    },
    "errors" : [
      {
        "details" : "An internal error occured.",
      },
      ...
    ],
    "id" : 1,
    "project" : {
      "name" : "myproject",
    },
    "status" : "FAILURE",
    "timeCreated" : "2014-04-13T00:18:36.979Z",
    "timeUpdated" : "2014-04-14T00:18:36.979Z",
    "type" : "UPLOAD_ADAPTER",
    "userName" : "demouser",
  },
}
```

## XML Example

```
<?xml version="1.0" encoding="UTF-8"?>
<deploy-adapter-result
  ok="false"
```

```

productVersion="7.0.0">
<transaction
  appServerId="Tomcat"
  id="1"
  status="FAILURE"
  timeCreated="2014-04-13T00:18:36.979Z"
  timeUpdated="2014-04-14T00:18:36.979Z"
  type="UPLOAD_ADAPTER"
  userName="demouser">
  <description
    alreadyDeployed="false"
    filename="myadapter.adapter"
    name="myadapter"/>
  <errors>
    <error details="An internal error occured."/>
    ...
  </errors>
  <project name="myproject"/>
</transaction>
</deploy-adapter-result>

```

## Response Properties

The response has the following properties:

**ok** Whether the transaction was successful.

**productVersion**

The exact product version.

**transaction**

The details of the transaction.

The *transaction* has the following properties:

**appServerId**

The id of the web application server.

**description**

The details of the adapter.

**errors**

The errors occurred during the transaction.

**id** The id of the transaction.

**project**

The current project.

**status**

The state of the transaction: PENDING, PREPARING, COMMITTING, REJECTING, SUCCESS, FAILURE, CANCELED. Synchronous transactions can have the state SUCCESS and FAILURE. Asynchronous transactions can also have the other states.

**timeCreated**

The date in ISO 8601 format when the adapter was created.

**timeUpdated**

The date in ISO 8601 format when the adapter was updated.

**type**

The type of the transaction, here always UPLOAD\_ADAPTER.

**userName**

The user that initiated the transaction.

The *description* has the following properties:

**alreadyDeployed**

Whether a version of the adapter was already previously deployed.

**filename**

The optional file name of the adapter.

**name**

The name of the adapter.

The *error* has the following properties:

**details**

The main error message.

The *project* has the following properties:

**name**

The name of the project, which is the context root of the runtime.

## Errors

403

The user is not authorized to call this service.

404

The corresponding runtime is not found or not running.

500

An internal error occurred.

## Adapters (GET)

Retrieves metadata for the list of deployed adapters.

### Roles

Users in the following roles are authorized to perform this operation:

- **worklightadmin**
- **worklightdeployer**
- **worklightmonitor**
- **worklightoperator**

### Method

GET

### Path

*/management-apis/1.0/runtimes/runtime-name/adapters*

### Example

[https://www.example.com/worklightadmin/management-apis/1.0/runtimes/myruntime/adapters?locale=de\\_DE&offset=0&orderBy=name&pageSize=100](https://www.example.com/worklightadmin/management-apis/1.0/runtimes/myruntime/adapters?locale=de_DE&offset=0&orderBy=name&pageSize=100)

## Path Parameters

### **runtime-name**

The name of the runtime. This is the context root of the runtime web application, without the leading slash.

## Query Parameters

Query parameters are optional.

### **locale**

The locale used for error messages.

### **offset**

The offset from the beginning of the list if only a part of the list (a page) should be returned.

### **orderBy**

The sort mode. By default, the elements are sorted in increasing order. If the sort mode starts with - (minus sign), the elements are sorted in decreasing order. Possible sort modes are: name, deployTime. The default sort mode is: name.

### **pageSize**

The number of elements if only a part of the list (a page) should be returned. The default value is 100.

## Produces

application/json, application/xml, text/xml

## Response

The metadata of the deployed adapters.

## JSON Example

```
{
  "items" : [
    {
      "deployTime" : "2014-04-13T00:18:36.979Z",
      "description" : "My first sample adapter",
      "link" : "https://www.example.com/worklightadmin/management-apis/1.0/runtimes/myruntime/adapters/myadapter",
      "name" : "myadapter",
      "platformVersion" : "6.1.0.00.20131126-0630",
      "procedures" : [ "getSomething", ... ],
      "projects" : [
        {
          "name" : "myproject",
        },
        ...
      ],
      "urls" : [
        {
          "formParameters" : [
            {
              "defaultValue" : "n/a",
              "javaType" : "java.lang.String",
              "name" : "param",
            },
            ...
          ],
          "javaClass" : "com.example.MyRestWrapper",
          "methodName" : "multiplyNumbers",
        },
        ...
      ],
    },
    ...
  ],
  "javaClass" : "com.example.MyRestWrapper",
  "methodName" : "multiplyNumbers",
}
```

```

    "method" : "POST",
    "pathParameters" : [
      {
        "defaultValue" : "n/a",
        "javaType" : "java.lang.String",
        "name" : "param",
      },
      ...
    ],
    "queryParameters" : [
      {
        "defaultValue" : "n/a",
        "javaType" : "java.lang.String",
        "name" : "param",
      },
      ...
    ],
    "uri" : "/multiply",
  },
  ...
],
},
...
],
"pageSize" : 100,
"productVersion" : "7.0.0",
"startIndex" : 0,
"totalListSize" : 33,
}

```

## XML Example

```

<?xml version="1.0" encoding="UTF-8"?>
<adapters
  pageSize="100"
  productVersion="7.0.0"
  startIndex="0"
  totalListSize="33">
  <items>
    <item
      deployTime="2014-04-13T00:18:36.979Z"
      description="My first sample adapter"
      link="https://www.example.com/worklightadmin/management-apis/1.0/runtimes/myruntime/adapters/myadapter"
      name="myadapter"
      platformVersion="6.1.0.00.20131126-0630">
      <procedures>
        <procedure>getSomething</procedure>
        ...
      </procedures>
    <projects>
      <project name="myproject"/>
      ...
    </projects>
    <urls>
      <url
        javaClass="com.example.MyRestWrapper"
        javaMethodName="multiplyNumbers"
        method="POST"
        uri="/multiply">
        <formParameters>
          <formParameter
            defaultValue="n/a"
            javaType="java.lang.String"
            name="param"/>
          ...
        </formParameters>
        <pathParameters>

```

```

    <pathParameter
      defaultValue="n/a"
      javaType="java.lang.String"
      name="param"/>
    ...
  </pathParameters>
  <queryParameters>
    <queryParameter
      defaultValue="n/a"
      javaType="java.lang.String"
      name="param"/>
    ...
  </queryParameters>
</url>
...
</urls>
</item>
...
</items>
</adapters>

```

## Response Properties

The response has the following properties:

### **items**

The array of adapter metadata

### **pageSize**

The page size if only a page of adapters is returned.

### **productVersion**

The exact product version.

### **startIndex**

The start index in the total list if only a page of adapters is returned.

### **totalListSize**

The total number of adapters.

The *adapter* has the following properties:

### **deployTime**

The date in ISO 8601 format when the adapter was deployed.

### **description**

The description of the adapter.

### **link**

The URL to access detail information about the adapter.

### **name**

The name of the adapter.

### **platformVersion**

The exact version number of the IBM MobileFirst Platform Foundation development tools (Studio) that built the adapter.

### **procedures**

The JavaScript procedures of the adapter.

### **projects**

The projects the adapter belong to.

### **urls**

The API documentation of the URLs of the REST API provided by the adapter.

The *project* has the following properties:

**name**

The name of the project, which is the context root of the runtime.

The *url* has the following properties:

**formParameters**

The form parameters.

**javaClass**

The Java class

**javaMethodName**

The Java method

**method**

The HTTP method.

**pathParameters**

The path parameters.

**queryParameters**

The query parameters.

**uri**

The URI of the REST API.

The *REST API parameter* has the following properties:

**defaultValue**

The default value.

**javaType**

The Java type name.

**name**

The name of the parameter.

**Errors**

403

The user is not authorized to call this service.

404

The corresponding runtime is not found.

500

An internal error occurred.

## Adobe Air Application Binary (GET)

Retrieves the Adobe Air binary of a specific app version.

### Description

It supports range requests to deliver only a range of the bytes of the app version. Clients can use this feature to resume a download after interruption.

## Roles

Users in the following roles are authorized to perform this operation:

- **worklightadmin**
- **worklightdeployer**
- **worklightmonitor**
- **worklightoperator**

## Method

GET

## Path

*/otu/1.0/one-time-url-hash/runtimes/runtime-name/downloads/air/application-name/application-version*

## Example

`https://www.example.com/worklightadmin/otu/1.0/ffabc301/runtimes/myruntime/downloads/air/myapplication/1.0?locale=de_DE`

## Path Parameters

### **runtime-name**

The name of the runtime. This is the context root of the runtime web application, without the leading slash.

### **application-name**

The name of the application.

### **application-version**

The application version number.

### **one-time-url-hash**

The one-time-url hash code.

## Query Parameters

Query parameters are optional.

### **locale**

The locale used for error messages.

## Produces

application/octet-stream

## Response

The binary data of the specified app version.

## Errors

400

The request is invalid.

403



The user is not authorized to call this service.

404

The corresponding runtime or the app version is not found.

416

The requested range of bytes is not satisfiable.

500

An internal error occurred.

## APNS Credentials (DELETE)

Deletes Apple Push Notification Service (APNS) credentials of the application with the application ID, environment, and version.

### Roles

Users in the following roles are authorized to perform this operation:

- **worklightadmin**
- **worklightdeployer**
- **worklightmonitor**
- **worklightoperator**

### Method

DELETE

### Path

*/management-apis/1.0/runtimes/runtime-name/notifications/applications/application-name/apnsConf/application-env/application-version/*

### Example

[https://www.example.com/worklightadmin/management-apis/1.0/runtimes/myruntime/notifications/applications/myapplication/apnsConf/android/1.0/?locale=de\\_DE](https://www.example.com/worklightadmin/management-apis/1.0/runtimes/myruntime/notifications/applications/myapplication/apnsConf/android/1.0/?locale=de_DE)

### Path Parameters

#### **runtime-name**

The name of the runtime. This is the context root of the runtime web application, without the leading slash.

#### **application-name**

The name of the application.

#### **application-env**

The application environment.

#### **application-version**

The application version number.

### Query Parameters

Query parameters are optional.

#### **locale**

The locale used for error messages.

## Produces

application/json, application/xml, text/xml

## Response

The delete status of APNS credentials.

## JSON Example

```
{
  "productVersion" : {
    "productVersion" : "7.0.0",
  },
  "project" : {
    "name" : "PushNotifications",
  },
  "status" : "Success",
  "type" : "DELETE_PUSH_CREDENTIALS",
}
```

## XML Example

```
<?xml version="1.0" encoding="UTF-8"?>
<deleteAPNSCredentialsStatus
  status="Success"
  type="DELETE_PUSH_CREDENTIALS">
  <productVersion productVersion="7.0.0"/>
  <project name="PushNotifications"/>
</deleteAPNSCredentialsStatus>
```

## Response Properties

The response has the following properties:

### **productVersion**

The exact product version.

### **project**

Project name.

### **status**

The APNS credentials are deleted successfully.

### **type**

Transaction type.

The *productVersion* has the following properties:

### **productVersion**

The exact product version

The *project* has the following properties:

### **name**

Name of the project

## Errors

403

The user is not authorized to call this service.

404

The corresponding runtime is not found or not running.

500

An internal error occurred.

## APNS Credentials (GET)

Retrieves Apple Push Notification Service (APNS) credentials of the application with the application ID, environment, and version.

### Roles

Users in the following roles are authorized to perform this operation:

- **worklightadmin**
- **worklightdeployer**
- **worklightmonitor**
- **worklightoperator**

### Method

GET

### Path

*/management-apis/1.0/runtimes/runtime-name/notifications/applications/application-name/apnsConf/application-env/application-version/*

### Example

[https://www.example.com/worklightadmin/management-apis/1.0/runtimes/myruntime/notifications/applications/myapplication/apnsConf/android/1.0/?locale=de\\_DE](https://www.example.com/worklightadmin/management-apis/1.0/runtimes/myruntime/notifications/applications/myapplication/apnsConf/android/1.0/?locale=de_DE)

### Path Parameters

#### **runtime-name**

The name of the runtime. This is the context root of the runtime web application, without the leading slash.

#### **application-name**

The name of the application.

#### **application-env**

The application environment.

#### **application-version**

The application version number.

### Query Parameters

Query parameters are optional.

#### **locale**

The locale used for error messages.

### Produces

application/json, application/xml, text/xml

## Response

The APNS credentials of the application such as certificate information, password, and product version.

### JSON Example

```
{
  "certificateExpirationDate" : 2015-05-05T06:29:10.000Z,
  "certificateFileName" : "apns-certificate-sandbox.p12",
  "password" : "password",
  "productVersion" : "7.0.0",
  "sandbox" : true,
}
```

### XML Example

```
<?xml version="1.0" encoding="UTF-8"?>
<apnsCredentials
  certificateExpirationDate="2015-05-05T06:29:10.000Z"
  certificateFileName="apns-certificate-sandbox.p12"
  password="password"
  productVersion="7.0.0"
  sandbox="true"/>
```

## Response Properties

The response has the following properties:

### **certificateExpirationDate**

The expiry date of Certificate.

### **certificateFileName**

The name of the certificate.

### **password**

The password of the certificate.

### **productVersion**

The exact product version.

### **sandbox**

The sandbox is true if certificate is of sandbox type.

## Errors

403

The user is not authorized to call this service.

404

The corresponding runtime is not found or not running.

500

An internal error occurred.

## APNS Credentials (PUT)

Sets Apple Push Notification Service (APNS) credentials of the application with the application ID, environment, version, password, certificate file name, and certificate.

## Description

The payload is the form data in which password, certificate file name, and certificate are submitted.

## Roles

Users in the following roles are authorized to perform this operation:

- **worklightadmin**
- **worklightdeployer**
- **worklightmonitor**
- **worklightoperator**

## Method

PUT

## Path

*/management-apis/1.0/runtimes/runtime-name/notifications/applications/application-name/apnsConf/application-env/application-version/*

## Example

[https://www.example.com/worklightadmin/management-apis/1.0/runtimes/myruntime/notifications/applications/myapplication/apnsConf/android/1.0/?locale=de\\_DE](https://www.example.com/worklightadmin/management-apis/1.0/runtimes/myruntime/notifications/applications/myapplication/apnsConf/android/1.0/?locale=de_DE)

## Path Parameters

### **runtime-name**

The name of the runtime. This is the context root of the runtime web application, without the leading slash.

### **application-name**

The name of the application.

### **application-env**

The application environment.

### **application-version**

The application version number.

## Query Parameters

Query parameters are optional.

### **locale**

The locale used for error messages.

## Consumes

multipart/form-data

## Produces

application/json, application/xml, text/xml

## Form-data Parameters

### **certificateFileName**

(string) The certificate file name.

### **password**

(string) The certificate password.

### **certificate**

(File) The certificate file.

## Response

The status of set APNS credentials.

## JSON Example

```
{
  "productVersion" : {
    "productVersion" : "7.0.0",
  },
  "project" : {
    "name" : "PushNotifications",
  },
  "status" : "Success",
  "type" : "SET_APNS_CREDENTIALS",
}
```

## XML Example

```
<?xml version="1.0" encoding="UTF-8"?>
<setAPNSCredentialsStatus
  status="Success"
  type="SET_APNS_CREDENTIALS">
  <productVersion productVersion="7.0.0"/>
  <project name="PushNotifications"/>
</setAPNSCredentialsStatus>
```

## Response Properties

The response has the following properties:

### **productVersion**

The exact product version.

### **project**

Project name.

### **status**

The APNS credentials are saved successfully.

### **type**

Transaction type.

The *productVersion* has the following properties:

### **productVersion**

The exact product version

The *project* has the following properties:

### **name**

Name of the project

## Errors

403

The user is not authorized to call this service.

404

The corresponding runtime is not found or not running.

500

An internal error occurred.

## App Version Access Rule (PUT)

Sets the access rule of a specific app version.

### Description

The access rule specifies the behavior when a user accesses the application on the device.

This transaction can run synchronously or asynchronously. If processed asynchronously, the REST service returns before the transaction is completed. In this case, you can query the transaction result later with the transaction REST service.

### Roles

Users in the following roles are authorized to perform this operation:

- **worklightadmin**
- **worklightdeployer**
- **worklightoperator**

### Method

PUT

### Path

*/management-apis/1.0/runtimes/runtime-name/applications/application-name/application-env/application-version/accessRule*

### Example

[https://www.example.com/worklightadmin/management-apis/1.0/runtimes/myruntime/applications/myapplication/ios/1.0/accessRule?async=false&locale=de\\_DE](https://www.example.com/worklightadmin/management-apis/1.0/runtimes/myruntime/applications/myapplication/ios/1.0/accessRule?async=false&locale=de_DE)

### Path Parameters

#### **runtime-name**

The name of the runtime. This is the context root of the runtime web application, without the leading slash.

#### **application-name**

The name of the application.

#### **application-env**

The application environment.

**application-version**

The application version number.

**Query Parameters**

Query parameters are optional.

**async**

Whether the transaction is processed synchronously or asynchronously. Allowed values are true and false. The default is synchronous processing.

**locale**

The locale used for error messages.

**Consumes**

application/json, application/xml, text/xml

**Produces**

application/json, application/xml, text/xml

**Payload****JSON Example**

```
{
  "action" : "NOTIFY",
  "downloadLink" : "ibmappctr://myapp",
  "message" : "Please update!",
  "multiLanguageMessage" : [
    {
      "locale" : "de",
      "message" : "Bitte updaten!",
    },
    ...
  ],
}
```

**XML Example**

```
<?xml version="1.0" encoding="UTF-8"?>
<accessrule
  action="NOTIFY"
  downloadLink="ibmappctr://myapp"
  message="Please update!">
  <multiLanguageMessage>
    <localizedMessage
      locale="de"
      message="Bitte updaten!"/>
    ...
  </multiLanguageMessage>
</accessrule>
```

**Payload Properties**

The payload has the following properties:

**action**

The action to be performed. It can have the following values: NOTIFY (notify the user of some message), BLOCK (block the execution the application), DELETE (remove the access rule).



**downloadLink**

An optional link displayed with the message where to download a new version of the application.

**message**

The message to be displayed when the action is NOTIFY or BLOCK.

**multiLanguageMessage**

Messages in additional languages

The *multilanguage message* has the following properties:

**locale**

The locale of the message.

**message**

The translated message.

**Response**

The metadata of the app version and its access rule.

**JSON Example**

```
{
  "ok" : false,
  "productVersion" : "7.0.0",
  "transaction" : {
    "appServerId" : "Tomcat",
    "description" : {
      "action" : "NOTIFY",
      "appVersion" : {
        "applicationName" : "myapplication",
        "environment" : "ios",
        "version" : "1.0",
      },
      "createdAtDate" : "2014-02-13T00:18:36.979Z",
      "message" : "This version is no longer supported.",
    },
    "errors" : [
      {
        "details" : "An internal error occurred.",
      },
      ...
    ],
    "id" : 1,
    "project" : {
      "name" : "myproject",
    },
    "status" : "FAILURE",
    "timeCreated" : "2014-04-13T00:18:36.979Z",
    "timeUpdated" : "2014-04-14T00:18:36.979Z",
    "type" : "SET_APPLICATION_ENV_VERSION_ACCESS_RULE",
    "userName" : "demouser",
  },
}
```

**XML Example**

```
<?xml version="1.0" encoding="UTF-8"?>
<set-appversion-accessrule-result
  ok="false"
  productVersion="7.0.0">
  <transaction
    appServerId="Tomcat"
    id="1"
```

```

status="FAILURE"
timeCreated="2014-04-13T00:18:36.979Z"
timeUpdated="2014-04-14T00:18:36.979Z"
type="SET_APPLICATION_ENV_VERSION_ACCESS_RULE"
userName="demouser">
<description
  action="NOTIFY"
  createdAtDate="2014-02-13T00:18:36.979Z"
  message="This version is no longer supported.">
  <appVersion
    applicationName="myapplication"
    environment="iphone"
    version="1.0"/>
</description>
<errors>
  <error details="An internal error occured."/>
  ...
</errors>
<project name="myproject"/>
</transaction>
</set-appversion-accessrule-result>

```

## Response Properties

The response has the following properties:

**ok** Whether the transaction was successful.

**productVersion**

The exact product version.

**transaction**

The details of the transaction.

The *transaction* has the following properties:

**appServerId**

The id of the web application server.

**description**

The details of the application.

**errors**

The errors occurred during the transaction.

**id** The id of the transaction.

**project**

The current project.

**status**

The state of the transaction: PENDING, PREPARING, COMMITTING, REJECTING, SUCCESS, FAILURE, CANCELED. Synchronous transactions can have the state SUCCESS and FAILURE. Asynchronous transactions can also have the other states.

**timeCreated**

The date in ISO 8601 format when the adapter was created.

**timeUpdated**

The date in ISO 8601 format when the adapter was updated.

**type**

The type of the transaction, here always SET\_APPLICATION\_ENV\_VERSION\_ACCESS\_RULE.

**userName**

The user that initiated the transaction.

The *description* has the following properties:

**action**

The action to be done when a disabled app version is accessed. Possible values are: NOTIFY, BLOCK, NA, DELETE.

**appVersion**

The corresponding app version

**createdAtDate**

The date in ISO 8601 format when the app version access rule was created.

**downloadLink**

The download link where to obtain a new version of the application.

**message**

The message to be displayed when a disabled app version is accessed.

The *app version* has the following properties:

**applicationName**

The name of the application.

**environment**

The environment of the application.

**version**

The version of the application.

The *error* has the following properties:

**details**

The main error message.

The *project* has the following properties:

**name**

The name of the project, which is the context root of the runtime.

**Errors**

400

The payload is invalid.

403

The user is not authorized to call this service.

404

The corresponding runtime or the app version is not found.

500

An internal error occurred.

**App Version (DELETE)**

Deletes a specific app version.

## Description

This transaction can run synchronously or asynchronously. If processed asynchronously, the REST service returns before the transaction is completed. In this case, you can query the transaction result later with the transaction REST service.

## Roles

Users in the following roles are authorized to perform this operation:

- **worklightadmin**
- **worklightdeployer**

## Method

DELETE

## Path

*/management-apis/1.0/runtimes/runtime-name/applications/application-name/application-env/application-version*

## Example

[https://www.example.com/worklightadmin/management-apis/1.0/runtimes/myruntime/applications/myapplication/iphone/1.0?async=false&locale=de\\_DE](https://www.example.com/worklightadmin/management-apis/1.0/runtimes/myruntime/applications/myapplication/iphone/1.0?async=false&locale=de_DE)

## Path Parameters

### **runtime-name**

The name of the runtime. This is the context root of the runtime web application, without the leading slash.

### **application-name**

The name of the application.

### **application-env**

The application environment.

### **application-version**

The application version number.

## Query Parameters

Query parameters are optional.

### **async**

Whether the transaction is processed synchronously or asynchronously. Allowed values are true and false. The default is synchronous processing.

### **locale**

The locale used for error messages.

## Produces

application/json, application/xml, text/xml

## Response

The metadata of the deleted app version.

### JSON Example

```
{
  "ok" : false,
  "productVersion" : "7.0.0",
  "transaction" : {
    "appServerId" : "Tomcat",
    "description" : {
      "applicationName" : "myapplication",
      "environment" : "iphone",
      "version" : "1.0",
    },
    "errors" : [
      {
        "details" : "An internal error ocured.",
      },
      ...
    ],
    "id" : 1,
    "project" : {
      "name" : "myproject",
    },
    "status" : "FAILURE",
    "timeCreated" : "2014-04-13T00:18:36.979Z",
    "timeUpdated" : "2014-04-14T00:18:36.979Z",
    "type" : "DELETE_APPLICATION_ENV_VERSION",
    "userName" : "demouser",
  },
}
```

### XML Example

```
<?xml version="1.0" encoding="UTF-8"?>
<delete-appversion-result
  ok="false"
  productVersion="7.0.0">
  <transaction
    appServerId="Tomcat"
    id="1"
    status="FAILURE"
    timeCreated="2014-04-13T00:18:36.979Z"
    timeUpdated="2014-04-14T00:18:36.979Z"
    type="DELETE_APPLICATION_ENV_VERSION"
    userName="demouser">
    <description
      applicationName="myapplication"
      environment="iphone"
      version="1.0"/>
    <errors>
      <error details="An internal error ocured."/>
      ...
    </errors>
    <project name="myproject"/>
  </transaction>
</delete-appversion-result>
```

### Response Properties

The response has the following properties:

**ok** Whether the transaction was successful.

**productVersion**

The exact product version.

**transaction**

The details of the transaction.

The *transaction* has the following properties:

**appServerId**

The id of the web application server.

**description**

The details of the application.

**errors**

The errors occurred during the transaction.

**id** The id of the transaction.

**project**

The current project.

**status**

The state of the transaction: PENDING, PREPARING, COMMITTING, REJECTING, SUCCESS, FAILURE, CANCELED. Synchronous transactions can have the state SUCCESS and FAILURE. Asynchronous transactions can also have the other states.

**timeCreated**

The date in ISO 8601 format when the adapter was created.

**timeUpdated**

The date in ISO 8601 format when the adapter was updated.

**type**

The type of the transaction, here always DELETE\_APPLICATION\_ENV\_VERSION.

**userName**

The user that initiated the transaction.

The *description* has the following properties:

**applicationName**

The name of the application.

**environment**

The environment of the application.

**version**

The version of the application.

The *error* has the following properties:

**details**

The main error message.

The *project* has the following properties:

**name**

The name of the project, which is the context root of the runtime.

**Errors**

403

The user is not authorized to call this service.

404

The corresponding runtime or the app version is not found.

500

An internal error occurred.

## App Version Lock (PUT)

Locks a specific app version.

### Description

A locked app version cannot be updated anymore.

### Roles

Users in the following roles are authorized to perform this operation:

- **worklightadmin**
- **worklightdeployer**
- **worklightoperator**

### Method

PUT

### Path

*/management-apis/1.0/runtimes/runtime-name/applications/application-name/  
application-env/application-version/lock*

### Example

[https://www.example.com/worklightadmin/management-apis/1.0/runtimes/myruntime/  
applications/myapplication/android/1.0/lock?locale=de\\_DE](https://www.example.com/worklightadmin/management-apis/1.0/runtimes/myruntime/applications/myapplication/android/1.0/lock?locale=de_DE)

### Path Parameters

#### **runtime-name**

The name of the runtime. This is the context root of the runtime web application, without the leading slash.

#### **application-name**

The name of the application.

#### **application-env**

The application environment.

#### **application-version**

The application version number.

### Query Parameters

Query parameters are optional.

#### **locale**

The locale used for error messages.

## Consumes

application/json

## Produces

application/json, application/xml, text/xml

## Payload

### JSON Example

```
{
  "lock" : true,
  "warning" : "true",
}
```

### Payload Properties

The payload has the following properties:

#### **lock**

Whether the app version is locked.

#### **warning**

When a warning happens, provides the details.

## Response

### JSON Example

```
{
  "ok" : true,
  "warning" : "true",
}
```

### XML Example

```
<?xml version="1.0" encoding="UTF-8"?>
<set-appversion-lock-result
  ok="true"
  warning="true"/>
```

### Response Properties

The response has the following properties:

**ok** Whether the operation was successful.

#### **warning**

When a warning happens, provides the details.

## Errors

400

The payload is invalid.

403

The user is not authorized to call this service.

404



The corresponding runtime or the app version is not found.

500

An internal error occurred.

## Application Binary (GET, HEAD)

Retrieves the binary of a specific app version.

### Description

It supports range requests to deliver only a range of the bytes of the app version. Clients can use this feature to resume a download after interruption.

### Roles

Users in the following roles are authorized to perform this operation:

- **worklightadmin**
- **worklightdeployer**

### Method

GET, HEAD

### Path

*/otu/1.0/one-time-url-hash/runtimes/runtime-name/downloads/applications/application-name/application-env/application-version*

### Example

[https://www.example.com/worklightadmin/otu/1.0/ffabc301/runtimes/myruntime/downloads/applications/myapplication/android/1.0?locale=de\\_DE](https://www.example.com/worklightadmin/otu/1.0/ffabc301/runtimes/myruntime/downloads/applications/myapplication/android/1.0?locale=de_DE)

### Path Parameters

#### **runtime-name**

The name of the runtime. This is the context root of the runtime web application, without the leading slash.

#### **application-name**

The name of the application.

#### **application-env**

The application environment.

#### **application-version**

The application version number.

#### **one-time-url-hash**

The one-time-url hash code.

### Query Parameters

Query parameters are optional.

#### **locale**

The locale used for error messages.

## Produces

application/octet-stream

## Response

The binary data of the specified app version.

## Errors

400

The request is invalid.

403

The user is not authorized to call this service.

404

The corresponding runtime or the app version is not found.

416

The requested range of bytes is not satisfiable.

500

An internal error occurred.

## Application (DELETE)

Deletes a specific application and all its app versions.

### Description

This transaction can run synchronously or asynchronously. If processed asynchronously, the REST service returns before the transaction is completed. In this case, you can query the transaction result later with the transaction REST service.

### Roles

Users in the following roles are authorized to perform this operation:

- **worklightadmin**
- **worklightdeployer**

### Method

DELETE

### Path

*/management-apis/1.0/runtimes/runtime-name/applications/application-name*

### Example

[https://www.example.com/worklightadmin/management-apis/1.0/runtimes/myruntime/applications/myapplication?async=false&locale=de\\_DE](https://www.example.com/worklightadmin/management-apis/1.0/runtimes/myruntime/applications/myapplication?async=false&locale=de_DE)

## Path Parameters

### **runtime-name**

The name of the runtime. This is the context root of the runtime web application, without the leading slash.

### **application-name**

The name of the application.

## Query Parameters

Query parameters are optional.

### **async**

Whether the transaction is processed synchronously or asynchronously. Allowed values are true and false. The default is synchronous processing.

### **locale**

The locale used for error messages.

## Produces

application/json, application/xml, text/xml

## Response

The metadata of the deleted application.

## JSON Example

```
{
  "ok" : false,
  "productVersion" : "7.0.0",
  "transaction" : {
    "appServerId" : "Tomcat",
    "description" : {
      "applicationName" : "myapplication",
    },
    "errors" : [
      {
        "details" : "An internal error occurred.",
      },
      ...
    ],
    "id" : 1,
    "project" : {
      "name" : "myproject",
    },
    "status" : "FAILURE",
    "timeCreated" : "2014-04-13T00:18:36.979Z",
    "timeUpdated" : "2014-04-14T00:18:36.979Z",
    "type" : "DELETE_APPLICATION",
    "userName" : "demouser",
  },
}
```

## XML Example

```
<?xml version="1.0" encoding="UTF-8"?>
<delete-application-result
  ok="false"
  productVersion="7.0.0">
  <transaction
    appServerId="Tomcat"
    id="1"
```

```

status="FAILURE"
timeCreated="2014-04-13T00:18:36.979Z"
timeUpdated="2014-04-14T00:18:36.979Z"
type="DELETE_APPLICATION"
userName="demouser">
<description applicationName="myapplication"/>
<errors>
  <error details="An internal error occured."/>
  ...
</errors>
<project name="myproject"/>
</transaction>
</delete-application-result>

```

## Response Properties

The response has the following properties:

**ok** Whether the transaction was successful.

**productVersion**

The exact product version.

**transaction**

The details of the transaction.

The *transaction* has the following properties:

**appServerId**

The id of the web application server.

**description**

The details of the application.

**errors**

The errors occurred during the transaction.

**id** The id of the transaction.

**project**

The current project.

**status**

The state of the transaction: PENDING, PREPARING, COMMITTING, REJECTING, SUCCESS, FAILURE, CANCELED. Synchronous transactions can have the state SUCCESS and FAILURE. Asynchronous transactions can also have the other states.

**timeCreated**

The date in ISO 8601 format when the adapter was created.

**timeUpdated**

The date in ISO 8601 format when the adapter was updated.

**type**

The type of the transaction, here always DELETE\_APPLICATION.

**userName**

The user that initiated the transaction.

The *description* has the following properties:

**applicationName**

The name of the application.

The *error* has the following properties:

### details

The main error message.

The *project* has the following properties:

#### name

The name of the project, which is the context root of the runtime.

## Errors

403

The user is not authorized to call this service.

404

The corresponding runtime or the application is not found.

500

An internal error occurred.

## Application (GET)

Retrieves metadata of a specific application.

### Roles

Users in the following roles are authorized to perform this operation:

- **worklightadmin**
- **worklightdeployer**
- **worklightmonitor**
- **worklightoperator**

### Method

GET

### Path

*/management-apis/1.0/runtimes/runtime-name/applications/application-name*

### Example

[https://www.example.com/worklightadmin/management-apis/1.0/runtimes/myruntime/applications/myapplication?locale=de\\_DE](https://www.example.com/worklightadmin/management-apis/1.0/runtimes/myruntime/applications/myapplication?locale=de_DE)

### Path Parameters

#### runtime-name

The name of the runtime. This is the context root of the runtime web application, without the leading slash.

#### application-name

The name of the application.

### Query Parameters

Query parameters are optional.

## locale

The locale used for error messages.

## Produces

application/json, application/xml, text/xml

## Response

The metadata of the specified application.

## JSON Example

```
{
  "description" : "My first sample application",
  "displayName" : "My Sample Application",
  "environments" : [
    {
      "applicationEnvironmentDataAccess" : {
        "action" : "NOTIFY",
        "createdTime" : "2014-04-13T00:18:36.979Z",
        "message" : "This version is no longer supported.",
      },
      "authenticityConfig" : "BASIC",
      "buildTime" : "2014-03-29T00:18:36.979Z",
      "deployTime" : "2014-04-13T00:18:36.979Z",
      "deviceProvisioningRealm" : "myProvRealm",
      "envPlatformVersion" : "7.0.0",
      "environment" : "iphone",
      "link" : "https://www.example.com/worklightadmin/management-apis/1.0/runtimes/
myruntime/applications/myapplication/iphone/1.0",
      "prevBuildTime" : "2014-03-29T00:18:36.979Z",
      "securityTest" : "mobileTest",
      "supportRemoteDisable" : true,
      "supportsAuthenticity" : true,
      "userAuthenticationRealm" : "myAuthRealm",
      "version" : "1.0",
      "versionLocked" : false,
    },
    ...
  ],
  "link" : "https://www.example.com/worklightadmin/management-apis/1.0/runtimes/
myruntime/applications/myapplication",
  "name" : "myapplication",
  "platformVersion" : "6.1.0.00.20131126-0630",
  "productVersion" : "7.0.0",
  "projects" : [
    {
      "name" : "myproject",
    },
    ...
  ],
}
```

## XML Example

```
<?xml version="1.0" encoding="UTF-8"?>
<application
  description="My first sample application"
  displayName="My Sample Application"
  link="https://www.example.com/worklightadmin/management-apis/1.0/runtimes/
myruntime/applications/myapplication"
  name="myapplication"
  platformVersion="6.1.0.00.20131126-0630"
  productVersion="7.0.0">
  <environments>
```

```

<environment
  authenticityConfig="BASIC"
  buildTime="2014-03-29T00:18:36.979Z"
  deployTime="2014-04-13T00:18:36.979Z"
  deviceProvisioningRealm="myProvRealm"
  envPlatformVersion="7.0.0"
  environment="iphone"
  link="https://www.example.com/worklightadmin/management-apis/1.0/runtimes/
myruntime/applications/myapplication/iphone/1.0"
  prevBuildTime="2014-03-29T00:18:36.979Z"
  securityTest="mobileTest"
  supportRemoteDisable="true"
  supportsAuthenticity="true"
  userAuthenticationRealm="myAuthRealm"
  version="1.0"
  versionLocked="false">
  <applicationEnvironmentDataAccess
    action="NOTIFY"
    createdTime="2014-04-13T00:18:36.979Z"
    message="This version is no longer supported."/>
  </environment>
  ...
</environments>
<projects>
  <project name="myproject"/>
  ...
</projects>
</application>

```

## Response Properties

The response has the following properties:

### **description**

The description of the application.

### **displayName**

The display name of the application.

### **environments**

The array of application environments.

### **link**

The URL to access detail information about the application.

### **name**

The name of the application.

### **platformVersion**

The exact version number of the IBM MobileFirst Platform Foundation development tools (Studio) that built the application.

### **productVersion**

The exact product version.

### **projects**

The projects the application belong to.

The *environment* has the following properties:

### **applicationEnvironmentDataAccess**

The access rule to be executed when the app version is disabled.

### **authenticityConfig**

The application authenticity configuration. Possible values are: NONE, BASIC, EXTENDED.

**buildTime**

The time stamp when the app version was built.

**deployTime**

The date in ISO 8601 format when the application was deployed.

**deviceProvisioningRealm**

The name of the realm used for device provisioning.

**envPlatformVersion**

The version of the platform of the environment.

**environment**

The platform environment of the app version: iphone.

**link**

The URL to access detail information about the application version.

**prevBuildTime**

The time stamp when the app that was previously deployed was built.

**publishUrl**

For web applications, this is the URL under which the web application was published.

**securityTest**

The name of the security test for a protected resource.

**supportRemoteDisable**

true if the application version supports remote disabling.

**supportsAuthenticity**

true if the application version supports authentication.

**userAuthenticationRealm**

The name of the realm used to authenticate users.

**version**

The version number of the app version.

**versionLocked**

Whether the version is locked.

The *applicationEnvironmentDataAccess* has the following properties:

**action**

The action to be done when a disabled app version is accessed. Possible values are: NOTIFY, BLOCK, NA.

**createdTime**

The date in ISO 8601 format when the app version access rule was created.

**downloadLink**

The download link where to obtain a new version of the application.

**message**

The message to be displayed when a disabled app version is accessed.

**multiLanguageMessage**

Internationalized variants of the message to be displayed when a disabled app version is accessed.

The *project* has the following properties:



**name**

The name of the project, which is the context root of the runtime.

**Errors**

403

The user is not authorized to call this service.

404

The corresponding runtime is not found or not running, or the application is not found.

500

An internal error occurred.

**Application (POST)**

Deploys an application.

**Description**

It first checks whether the input application is valid. Then, it transfers the application to the database and to the runtime.

This transaction can run synchronously or asynchronously. If processed asynchronously, the REST service returns before the transaction is completed. In this case, you can query the transaction result later with the transaction REST service.

**Roles**

Users in the following roles are authorized to perform this operation:

- **worklightadmin**
- **worklightdeployer**

**Method**

POST

**Path**

`/management-apis/1.0/runtimes/runtime-name/applications`

**Example**

`https://www.example.com/worklightadmin/management-apis/1.0/runtimes/myruntime/applications?async=false&locale=de_DE`

**Path Parameters****runtime-name**

The name of the runtime. This is the context root of the runtime web application, without the leading slash.

**Query Parameters**

Query parameters are optional.

**async**

Whether the transaction is processed synchronously or asynchronously.  
 Allowed values are true and false. The default is synchronous processing.

**locale**

The locale used for error messages.

**Consumes**

multipart/form-data

**Produces**

application/json, application/xml, text/xml, text/html

**Response**

The metadata of the deployed application.

**JSON Example**

```
{
  "ok" : false,
  "productVersion" : "7.0.0",
  "transaction" : {
    "appServerId" : "Tomcat",
    "description" : {
      "appVersionsAlreadyDeployed" : [
        {
          "applicationName" : "myapplication",
          "environment" : "iphone",
          "version" : "1.0",
        },
        ...
      ],
      "appVersionsDeployed" : [
        {
          "applicationName" : "myapplication",
          "environment" : "iphone",
          "version" : "1.0",
        },
        ...
      ],
      "filename" : "myapplication.wlapp",
    },
    "errors" : [
      {
        "details" : "An internal error occured.",
      },
      ...
    ],
    "id" : 1,
    "project" : {
      "name" : "myproject",
    },
    "status" : "FAILURE",
    "timeCreated" : "2014-04-13T00:18:36.979Z",
    "timeUpdated" : "2014-04-14T00:18:36.979Z",
    "type" : "UPLOAD_APPLICATION",
    "userName" : "demouser",
  },
}
```

## XML Example

```
<?xml version="1.0" encoding="UTF-8"?>
<deploy-application-result
  ok="false"
  productVersion="7.0.0">
  <transaction
    appServerId="Tomcat"
    id="1"
    status="FAILURE"
    timeCreated="2014-04-13T00:18:36.979Z"
    timeUpdated="2014-04-14T00:18:36.979Z"
    type="UPLOAD_APPLICATION"
    userName="demouser">
    <description filename="myapplication.wlapp">
      <appVersionsAlreadyDeployedArray>
        <appVersionsAlreadyDeployed
          applicationName="myapplication"
          environment="iphone"
          version="1.0"/>
        ...
      </appVersionsAlreadyDeployedArray>
      <appVersionsDeployedArray>
        <appVersionsDeployed
          applicationName="myapplication"
          environment="iphone"
          version="1.0"/>
        ...
      </appVersionsDeployedArray>
    </description>
    <errors>
      <error details="An internal error occured."/>
      ...
    </errors>
    <project name="myproject"/>
  </transaction>
</deploy-application-result>
```

## Response Properties

The response has the following properties:

**ok** Whether the transaction was successful.

**productVersion**  
The exact product version.

**transaction**  
The details of the transaction.

The *transaction* has the following properties:

**appServerId**  
The id of the web application server.

**description**  
The details of the application.

**errors**  
The errors occurred during the transaction.

**id** The id of the transaction.

**project**  
The current project.

**status**

The state of the transaction: PENDING, PREPARING, COMMITTING, REJECTING, SUCCESS, FAILURE, CANCELED. Synchronous transactions can have the state SUCCESS and FAILURE. Asynchronous transactions can also have the other states.

**timeCreated**

The date in ISO 8601 format when the adapter was created.

**timeUpdated**

The date in ISO 8601 format when the adapter was updated.

**type**

The type of the transaction, here always UPLOAD\_APPLICATION.

**userName**

The user that initiated the transaction.

The *description* has the following properties:

**appVersionsAlreadyDeployed**

The app versions that were already previously deployed and remain unchanged.

**appVersionsDeployed**

The app versions deployed.

**filename**

The optional file name of the application.

The *app version* has the following properties:

**applicationName**

The name of the application.

**environment**

The environment of the application.

**version**

The version of the application.

The *error* has the following properties:

**details**

The main error message.

The *project* has the following properties:

**name**

The name of the project, which is the context root of the runtime.

**Errors**

403

The user is not authorized to call this service.

404

The corresponding runtime is not found or not running.

500

An internal error occurred.

## Applications (GET)

Retrieves metadata for the list of deployed applications.

### Roles

Users in the following roles are authorized to perform this operation:

- **worklightadmin**
- **worklightdeployer**
- **worklightmonitor**
- **worklightoperator**

### Method

GET

### Path

`/management-apis/1.0/runtimes/runtime-name/applications`

### Example

`https://www.example.com/worklightadmin/management-apis/1.0/runtimes/myruntime/applications?locale=de_DE&offset=0&orderBy=name&pageSize=100`

### Path Parameters

#### **runtime-name**

The name of the runtime. This is the context root of the runtime web application, without the leading slash.

### Query Parameters

Query parameters are optional.

#### **locale**

The locale used for error messages.

#### **offset**

The offset from the beginning of the list if only a part of the list (a page) should be returned.

#### **orderBy**

The sort mode. By default, the elements are sorted in increasing order. If the sort mode starts with - (minus sign), the elements are sorted in decreasing order. Possible sort modes are: name. The default sort mode is: name.

#### **pageSize**

The number of elements if only a part of the list (a page) should be returned. The default value is 100.

### Produces

application/json, application/xml, text/xml

### Response

The metadata of the deployed applications.

## JSON Example

```
{
  "items" : [
    {
      "description" : "My first sample application",
      "displayName" : "My Sample Application",
      "environments" : [
        {
          "applicationEnvironmentDataAccess" : {
            "action" : "NOTIFY",
            "createdTime" : "2014-04-13T00:18:36.979Z",
            "message" : "This version is no longer supported.",
          },
          "authenticityConfig" : "BASIC",
          "buildTime" : "2014-03-29T00:18:36.979Z",
          "deployTime" : "2014-04-13T00:18:36.979Z",
          "deviceProvisioningRealm" : "myProvRealm",
          "envPlatformVersion" : "7.0.0",
          "environment" : "iphone",
          "link" : "https://www.example.com/worklightadmin/management-apis/1.0/runtimes/
myruntime/applications/myapplication/iphone/1.0",
          "prevBuildTime" : "2014-03-29T00:18:36.979Z",
          "securityTest" : "mobileTest",
          "supportRemoteDisable" : true,
          "supportsAuthenticity" : true,
          "userAuthenticationRealm" : "myAuthRealm",
          "version" : "1.0",
          "versionLocked" : false,
        },
        ...
      ],
      "link" : "https://www.example.com/worklightadmin/management-apis/1.0/runtimes/
myruntime/applications/myapplication",
      "name" : "myapplication",
      "platformVersion" : "6.1.0.00.20131126-0630",
      "projects" : [
        {
          "name" : "myproject",
        },
        ...
      ],
    },
    ...
  ],
  "pageSize" : 100,
  "productVersion" : "7.0.0",
  "startIndex" : 0,
  "totalListSize" : 33,
}
```

## XML Example

```
<?xml version="1.0" encoding="UTF-8"?>
<applications
  pageSize="100"
  productVersion="7.0.0"
  startIndex="0"
  totalListSize="33">
  <items>
    <item
      description="My first sample application"
      displayName="My Sample Application"
      link="https://www.example.com/worklightadmin/management-apis/1.0/runtimes/
myruntime/applications/myapplication"
      name="myapplication"
      platformVersion="6.1.0.00.20131126-0630">
    <environments>
```

```

    <environment
      authenticityConfig="BASIC"
      buildTime="2014-03-29T00:18:36.979Z"
      deployTime="2014-04-13T00:18:36.979Z"
      deviceProvisioningRealm="myProvRealm"
      envPlatformVersion="7.0.0"
      environment="iphone"
      link="https://www.example.com/worklightadmin/management-apis/1.0/runtimes/
myruntime/applications/myapplication/iphone/1.0"
      prevBuildTime="2014-03-29T00:18:36.979Z"
      securityTest="mobileTest"
      supportRemoteDisable="true"
      supportsAuthenticity="true"
      userAuthenticationRealm="myAuthRealm"
      version="1.0"
      versionLocked="false">
      <applicationEnvironmentDataAccess
        action="NOTIFY"
        createdTime="2014-04-13T00:18:36.979Z"
        message="This version is no longer supported."/>
    </environment>
    ...
  </environments>
  <projects>
    <project name="myproject"/>
    ...
  </projects>
</item>
...
</items>
</applications>

```

## Response Properties

The response has the following properties:

### **items**

The array of application metadata

### **pageSize**

The page size if only a page of applications is returned.

### **productVersion**

The exact product version.

### **startIndex**

The start index in the total list if only a page of applications is returned.

### **totalListSize**

The total number of applications.

The *application* has the following properties:

### **description**

The description of the application.

### **displayName**

The display name of the application.

### **environments**

The array of application environments.

### **link**

The URL to access detail information about the application.

**name**

The name of the application.

**platformVersion**

The exact version number of the IBM MobileFirst Platform Foundation development tools (Studio) that built the application.

**projects**

The projects the application belong to.

The *environment* has the following properties:

**applicationEnvironmentDataAccess**

The access rule to be executed when the app version is disabled.

**authenticityConfig**

The application authenticity configuration. Possible values are: NONE, BASIC, EXTENDED.

**buildTime**

The time stamp when the app version was built.

**deployTime**

The date in ISO 8601 format when the application was deployed.

**deviceProvisioningRealm**

The name of the realm used for device provisioning.

**envPlatformVersion**

The version of the platform of the environment.

**environment**

The platform environment of the app version: iphone.

**link**

The URL to access detail information about the application version.

**prevBuildTime**

The time stamp when the app that was previously deployed was built.

**publishUrl**

For web applications, this is the URL under which the web application was published.

**securityTest**

The name of the security test for a protected resource.

**supportRemoteDisable**

true if the application version supports remote disabling.

**supportsAuthenticity**

true if the application version supports authentication.

**userAuthenticationRealm**

The name of the realm used to authenticate users.

**version**

The version number of the app version.

**versionLocked**

Whether the version is locked.

The *applicationEnvironmentDataAccess* has the following properties:



**action**

The action to be done when a disabled app version is accessed. Possible values are: NOTIFY, BLOCK, NA.

**createdTime**

The date in ISO 8601 format when the app version access rule was created.

**downloadLink**

The download link where to obtain a new version of the application.

**message**

The message to be displayed when a disabled app version is accessed.

**multiLanguageMessage**

Internationalized variants of the message to be displayed when a disabled app version is accessed.

The *project* has the following properties:

**name**

The name of the project, which is the context root of the runtime.

**Errors**

403

The user is not authorized to call this service.

404

The corresponding runtime is not found or not running.

500

An internal error occurred.

## Associate beacons and triggers (DELETE)

Deletes the association of beacons and triggers with the UUID, major number, minor number and triggerName.

**Description**

Deleting a beacon or beacon-trigger would delete the corresponding beacon-to-trigger associations as well.

**Roles**

Users in the following roles are authorized to perform this operation:

- **worklightadmin**
- **worklightdeployer**
- **worklightmonitor**
- **worklightoperator**

**Method**

DELETE

## Path

*/management-apis/1.0/runtimes/runtime-name/beaconTriggerAssociations/applications/application-name*

## Example

```
https://www.example.com/worklightadmin/management-apis/1.0/runtimes/myruntime/
beaconTriggerAssociations/applications/myapplication?locale=de_DE&major=1
&minor=4439&
triggerName=DwellInsideLoanSection&uuid=3d402cf0-3691-4bd9-97ff-0b0a93a160ef
```

## Path Parameters

### **runtime-name**

The name of the runtime. This is the context root of the runtime web application, without the leading slash.

### **application-name**

The name of the application.

## Query Parameters

Query parameters are optional.

### **locale**

The locale used for error messages.

### **major**

Mandatory. The major number of the beacon whose trigger-association must be deleted.

### **minor**

Mandatory. The minor number of the beacon whose trigger-association must be deleted.

### **triggerName**

Mandatory. The name of the beacon trigger whose beacon-association must be deleted.

### **uuid**

Mandatory. The UUID of the beacon whose trigger-association must be deleted.

## Produces

application/json, application/xml, text/xml

## Response

The status of the delete of the beacon trigger association.

## JSON Example

```
{
  "beaconTriggerAssociations" : {
    "major" : 1,
    "minor" : 4439,
    "triggerName" : "DwellInsideLoanSection",
    "uuid" : "3d402cf0-3691-4bd9-97ff-0b0a93a160ef",
  },
  "productVersion" : "7.0.0",
  "transaction" : {
    "appServerId" : "Tomcat",
```

```

"errors" : [
  {
  },
  ...
],
"id" : 1,
"project" : {
  "name" : "myproject",
},
"status" : "SUCCESS",
"timeCreated" : "2014-11-14T05:21:13.404Z",
"timeUpdated" : "2014-11-14T05:21:13.456Z",
"type" : "DELETE_BEACON_AND_TRIGGER_ASSOCIATION",
"userName" : "demouser",
"warnings" : [
  {
  },
  ...
],
},
}

```

## XML Example

```

<?xml version="1.0" encoding="UTF-8"?>
<delete-beacon-trigger-association-result productVersion="7.0.0">
  <beaconTriggerAssociations
    major="1"
    minor="4439"
    triggerName="DwellInsideLoanSection"
    uuid="3d402cf0-3691-4bd9-97ff-0b0a93a160ef"/>
  <transaction
    appServerId="Tomcat"
    id="1"
    status="SUCCESS"
    timeCreated="2014-11-14T05:21:13.404Z"
    timeUpdated="2014-11-14T05:21:13.456Z"
    type="DELETE_BEACON_AND_TRIGGER_ASSOCIATION"
    userName="demouser">
    <errors>
      <error/>
      ...
    </errors>
    <project name="myproject"/>
    <warnings>
      <warning/>
      ...
    </warnings>
  </transaction>
</delete-beacon-trigger-association-result>

```

## Response Properties

The response has the following properties:

### **beaconTriggerAssociations**

The details of the beacon trigger association that is deleted.

### **productVersion**

The exact product version.

### **transaction**

The details of the transaction.

The *beaconTriggerAssociations* has the following properties:

**major**

The major number of the beacon whose trigger-associations must be deleted.

**minor**

The minor number of the beacon whose trigger-associations must be deleted.

**triggerName**

An unique name for this beacon trigger.

**uuid**

The UUID of beacon whose trigger-associations must be deleted

The *transaction* has the following properties:

**appServerId**

The id of the web application server.

**errors**

Errors, if any, that occurred during the transaction.

**id** The id of the transaction.

**project**

The current project.

**status**

The state of the transaction: SUCCESS, FAILURE.

**timeCreated**

The date in ISO 8601 format when the transaction was started.

**timeUpdated**

The date in ISO 8601 format when the transaction was completed.

**type**

The type of the transaction: DELETE\_BEACON\_AND\_TRIGGER\_ASSOCIATION.

**userName**

The user that initiated the transaction.

**warnings**

Warnings, if any, that occurred during the transaction.

The *project* has the following properties:

**name**

The name of the project, which is the context root of the runtime.

**Errors**

401

Unauthorized - The caller is either not authenticated or not authorized to make this request.

404

Not Found - Either: a) beacon with specified by UUID, major and minor is not found, OR b) trigger with specified triggerName is not found.

500

An internal error occurred.

## Associate beacons and triggers (GET)

Retrieves the association of beacons and triggers with the UUID, major number, minor number, and triggerName.

### Description

The beacons and triggers associations are retrieved based on the following query parameters:

- None are specified: Returns all beacon and trigger associations of this application.
- Only triggerName is specified: Returns the associations of the specified trigger with any of the beacons.
- Only UUID is specified with/without triggerName (major and minor number are not specified): Returns the associations of the specified/any trigger with any of the beacons that have matching UUID.
- Only UUID and major number are specified with/without triggerName (minor is not specified): Returns the associations of the specified/any trigger with any of the beacons that have matching UUID and major number.
- Only UUID and minor number are specified with/without triggerName (major is not specified): Returns the associations of the specified/any trigger with any of the beacons that have matching UUID and minor number.
- UUID, major, and minor number are specified with/without triggerName: Returns the associations of the specified/any trigger with the specified beacon.

### Roles

Users in the following roles are authorized to perform this operation:

- **worklightadmin**
- **worklightdeployer**
- **worklightmonitor**
- **worklightoperator**

### Method

GET

### Path

*/management-apis/1.0/runtimes/runtime-name/beaconTriggerAssociations/applications/application-name*

### Example

```
https://www.example.com/worklightadmin/management-apis/1.0/runtimes/myruntime/beaconTriggerAssociations/applications/myapplication?errorIfNotFound=true&locale=de_DE&major=1&minor=4439&triggerName=DwellInsideLoanSection&uuid=3d402cf0-3691-4bd9-97ff-0b0a93a160ef
```

### Path Parameters

#### **runtime-name**

The name of the runtime. This is the context root of the runtime web application, without the leading slash.

**application-name**

The name of the application.

**Query Parameters**

Query parameters are optional.

**errorIfNotFound**

If this flag is set to true (default value) with any of the uuid/major/minor/triggerName parameters specified, and there are no matching beacon trigger associations, then 'HTTP 404 Not Found' error is returned instead of an empty list in the output.

**locale**

The locale used for error messages.

**major**

The major number of the beacon whose trigger-associations must be fetched.

**minor**

The minor number of the beacon whose trigger-associations must be fetched.

**triggerName**

The name of beacon trigger whose beacon-associations must be fetched.

**uuid**

The UUID of the beacon whose trigger-associations must be fetched.

**Produces**

application/json, application/xml, text/xml

**Response**

The details of all the beacon trigger associations that are retrieved.

**JSON Example**

```

{
  "beaconTriggerAssociations" : [
    {
      "major" : 1,
      "minor" : 4439,
      "triggerName" : "DwellInsideLoanSection",
      "uuid" : "3d402cf0-3691-4bd9-97ff-0b0a93a160ef",
    },
    ...
  ],
  "productVersion" : "7.0.0",
}

```

**XML Example**

```

<?xml version="1.0" encoding="UTF-8"?>
<list-beacon-trigger-associations-result productVersion="7.0.0">
  <beaconTriggerAssociations>
    <beaconTriggerAssociation
      major="1"
      minor="4439"
      triggerName="DwellInsideLoanSection"
      uuid="3d402cf0-3691-4bd9-97ff-0b0a93a160ef"/>
    ...
  </beaconTriggerAssociations>
</list-beacon-trigger-associations-result>

```

## Response Properties

The response has the following properties:

### **beaconTriggerAssociations**

The array of beacon trigger associations.

### **productVersion**

The exact product version.

The *beaconTriggerAssociations* has the following properties:

### **major**

The major number of the beacon.

### **minor**

The minor number of the beacon.

### **triggerName**

The unique name of the beacon trigger.

### **uuid**

The UUID of the beacon.

## Errors

401

Unauthorized - The caller is either not authenticated or not authorized to make this request.

404

The `errorIfNotFound` flag is set to true (or not specified) and one of the following conditions happened: a) a beacon with the specified UUID, major, and minor number is not found, or b) the trigger with specified `triggerName` is not found, or c) no association found between the specified beacon and trigger. If the `errorIfNotFound` flag is set to false and there are no matching beacon-trigger associations, then an empty list is returned instead of 404 error.

406

Unsupported Accept type - The content type specified in Accept header is not `application/json`, `application/xml` or `text/xml`.

500

An internal error occurred.

## Associate beacons and triggers (PUT)

Associates the specified beacons with the specified triggers.

### Description

Use this API to specify a trigger and the list of beacons to associate with it. Or to specify a beacon and the list of triggers to associate with it.

### Roles

Users in the following roles are authorized to perform this operation:

- **worklightadmin**
- **worklightdeployer**
- **worklightmonitor**

- **worklightoperator**

## Method

PUT

## Path

*/management-apis/1.0/runtimes/runtime-name/beaconTriggerAssociations/applications/application-name*

## Example

[https://www.example.com/worklightadmin/management-apis/1.0/runtimes/myruntime/beaconTriggerAssociations/applications/myapplication?locale=de\\_DE](https://www.example.com/worklightadmin/management-apis/1.0/runtimes/myruntime/beaconTriggerAssociations/applications/myapplication?locale=de_DE)

## Path Parameters

### **runtime-name**

The name of the runtime. This is the context root of the runtime web application, without the leading slash.

### **application-name**

The name of the application.

## Query Parameters

Query parameters are optional.

### **locale**

The locale used for error messages.

## Consumes

application/json, application/xml, text/xml

## Produces

application/json, application/xml, text/xml

## Payload

The payload has values for the beacons and the trigger names. It can be in JSON or XML format.

## JSON Example

```
{
  "beacons" : [
    {
      "major" : 1,
      "minor" : 4439,
      "uuid" : "3d402cf0-3691-4bd9-97ff-0b0a93a160ef",
    },
    ...
  ],
  "triggers" : [
    {
      "triggerName" : "DwellInsideLoanSection",
    }
  ]
}
```



```
    },  
    ...  
  ],  
}
```

## XML Example

```
<?xml version="1.0" encoding="UTF-8"?>  
<beaconTriggerAssociations>  
  <beacons>  
    <beacon  
      major="1"  
      minor="4439"  
      uuid="3d402cf0-3691-4bd9-97ff-0b0a93a160ef"/>  
    ...  
  </beacons>  
  <triggers>  
    <trigger triggerName="DwellInsideLoanSection"/>  
    ...  
  </triggers>  
</beaconTriggerAssociations>
```

## Payload Properties

The payload has the following properties:

### beacons

List of beacons to which each of the listed triggers must be associated with.  
Each beacon is identified by its UUID, major and minor number.

### triggers

List of triggers to which each of the listed beacons must be associated with.  
Each beacon-trigger is identified by its triggerName.

The *beaconTriggers* has the following properties:

### triggerName

The name of beacon-trigger.

The *beacons* has the following properties:

### major

The major number of the beacon.

### minor

The minor number of the beacon.

### uuid

The UUID of the beacon.

## Response

The status of the association of beacons and triggers.

## JSON Example

```
{  
  "beaconTriggerAssociations" : [  
    {  
      "major" : 1,  
      "minor" : 4439,  
      "triggerName" : "DwellInsideLoanSection",  
      "uuid" : "3d402cf0-3691-4bd9-97ff-0b0a93a160ef",  
    },  
    ...  
  ],  
}
```

```

    ],
    "productVersion" : "7.0.0",
    "transaction" : {
      "appServerId" : "Tomcat",
      "errors" : [
        {
        },
        ...
      ],
      "id" : 1,
      "project" : {
        "name" : "myproject",
      },
      "status" : "SUCCESS",
      "timeCreated" : "2014-11-14T05:21:13.404Z",
      "timeUpdated" : "2014-11-14T05:21:13.456Z",
      "type" : "ASSOCIATE_BEACONS_AND_TRIGGERS",
      "userName" : "demouser",
      "warnings" : [
        {
        },
        ...
      ],
    },
  },
}

```

## XML Example

```

<?xml version="1.0" encoding="UTF-8"?>
<add-beacon-trigger-associations-result productVersion="7.0.0">
  <beaconTriggerAssociations>
    <beaconTriggerAssociation
      major="1"
      minor="4439"
      triggerName="DwellInsideLoanSection"
      uuid="3d402cf0-3691-4bd9-97ff-0b0a93a160ef"/>
    ...
  </beaconTriggerAssociations>
  <transaction
    appServerId="Tomcat"
    id="1"
    status="SUCCESS"
    timeCreated="2014-11-14T05:21:13.404Z"
    timeUpdated="2014-11-14T05:21:13.456Z"
    type="ASSOCIATE_BEACONS_AND_TRIGGERS"
    userName="demouser">
    <errors>
      <error/>
      ...
    </errors>
    <project name="myproject"/>
    <warnings>
      <warning/>
      ...
    </warnings>
  </transaction>
</add-beacon-trigger-associations-result>

```

## Response Properties

The response has the following properties:

### **beaconTriggerAssociations**

The list of the beacon trigger associations that are created.

### **productVersion**

The exact product version.

**transaction**

The details of the transaction.

The *beaconTriggerAssociations* has the following properties:

**major**

The major number of the beacon that is associated with a specified beacon-trigger.

**minor**

The minor number of the beacon that is associated with a specified beacon-trigger.

**triggerName**

An unique name for this beacon trigger.

**uuid**

The UUID of the beacon that is associated with a specified beacon-trigger.

The *transaction* has the following properties:

**appServerId**

The id of the web application server.

**errors**

Errors, if any, that occurred during the transaction.

**id** The id of the transaction.

**project**

The current project.

**status**

The state of the transaction: SUCCESS, FAILURE.

**timeCreated**

The date in ISO 8601 format when the transaction was started.

**timeUpdated**

The date in ISO 8601 format when the transaction was completed.

**type**

The type of the transaction: ASSOCIATE\_BEACONS\_AND\_TRIGGERS.

**userName**

The user that initiated the transaction.

**warnings**

Warnings, if any, that occurred during the transaction.

The *project* has the following properties:

**name**

The name of the project, which is the context root of the runtime.

**Errors**

400

Bad Request - The request could not be understood by the server due to malformed syntax.

401

Unauthorized - The caller is either not authenticated or not authorized to make this request.

404

Not Found - One/more of the specified beacons or beacon-triggers not found.

406

Unsupported Accept type - The content type specified in Accept header is not application/json, application/xml or text/xml.

415

Unsupported Media Type - The server is refusing to service the request because the request payload is not in application/json or application/xml or text/xml types.

500

An internal error occurred.

## Beacon Trigger (DELETE)

Deletes the beacon trigger by using the triggerName.

### Roles

Users in the following roles are authorized to perform this operation:

- **worklightadmin**
- **worklightdeployer**
- **worklightmonitor**
- **worklightoperator**

### Method

DELETE

### Path

*/management-apis/1.0/runtimes/runtime-name/beaconTriggers/trigger-name*

### Example

[https://www.example.com/worklightadmin/management-apis/1.0/runtimes/myruntime/beaconTriggers/mytrigger?locale=de\\_DE](https://www.example.com/worklightadmin/management-apis/1.0/runtimes/myruntime/beaconTriggers/mytrigger?locale=de_DE)

### Path Parameters

#### **runtime-name**

The name of the runtime. This is the context root of the runtime web application, without the leading slash.

#### **trigger-name**

The name of the beacon trigger.

### Query Parameters

Query parameters are optional.

#### **locale**

The locale used for error messages.

### Produces

application/json, application/xml, text/xml

## Response

The status of the delete of the beacon trigger.

### JSON Example

```
{
  "beaconTrigger" : {
    "actionPayload" : {
      "alert" : "Avail lowest interest rate of just 7.5% on home loans!",
    },
    "dwellingTime" : 5000,
    "proximityState" : "Far",
    "triggerName" : "DwellInsideLoanSection",
    "triggerType" : "Enter",
  },
  "productVersion" : "7.0.0",
  "transaction" : {
    "appServerId" : "Tomcat",
    "errors" : [
      {
      },
      ...
    ],
    "id" : 1,
    "project" : {
      "name" : "myproject",
    },
    "status" : "SUCCESS",
    "timeCreated" : "2014-11-14T05:21:13.404Z",
    "timeUpdated" : "2014-11-14T05:21:13.456Z",
    "type" : "DELETE_BEACON_TRIGGER",
    "userName" : "demouser",
    "warnings" : [
      {
      },
      ...
    ],
  },
},
}
```

### XML Example

```
<?xml version="1.0" encoding="UTF-8"?>
<delete-beacon-trigger-result productVersion="7.0.0">
  <beaconTrigger
    dwellingTime="5000"
    proximityState="Far"
    triggerName="DwellInsideLoanSection"
    triggerType="Enter">
    <actionPayload alert="Avail lowest interest rate of just 7.5% on home loans!"/>
  </beaconTrigger>
  <transaction
    appServerId="Tomcat"
    id="1"
    status="SUCCESS"
    timeCreated="2014-11-14T05:21:13.404Z"
    timeUpdated="2014-11-14T05:21:13.456Z"
    type="DELETE_BEACON_TRIGGER"
    userName="demouser">
    <errors>
      <error/>
      ...
    </errors>
    <project name="myproject"/>
    <warnings>
      <warning/>
    </warnings>
  </transaction>
</delete-beacon-trigger-result>
```

```
...
</warnings>
</transaction>
</delete-beacon-trigger-result>
```

## Response Properties

The response has the following properties:

### **beaconTrigger**

The details of the beacon trigger that is deleted.

### **productVersion**

The exact product version.

### **transaction**

The details of the transaction.

The *beaconTrigger* has the following properties:

### **actionPayload**

The details of an action to be taken when the trigger is activated.

### **dwellingTime**

Optional: Applicable only for triggerTypes: DwellInside and DwellOutside. It should be specified in milliseconds and defines how long the device must be inside, or outside a beacon region before the dwellInside or dwellOutside trigger is activated. Mandatory with triggerType of DwellInside and DwellOutside.

### **proximityState**

Optional: The proximity state that is specified for a beacon trigger. It can be either Immediate, Near, or Far. The default value is Far.

### **triggerName**

An unique name for this beacon trigger.

### **triggerType**

The type of beacon trigger. The value of the type can be either Enter, Exit, DwellInside, or DwellOutside.

The *actionPayload* has the following properties:

### **alert**

The alert message to be sent when a trigger is activated.

The *transaction* has the following properties:

### **appServerId**

The id of the web application server.

### **errors**

Errors, if any, that occurred during the transaction.

**id** The id of the transaction.

### **project**

The current project.

### **status**

The state of the transaction: SUCCESS, FAILURE.

### **timeCreated**

The date in ISO 8601 format when the transaction was started.

**timeUpdated**

The date in ISO 8601 format when the transaction was completed.

**type**

The type of the transaction: DELETE\_BEACON\_TRIGGER.

**userName**

The user that initiated the transaction.

**warnings**

Warnings, if any, that occurred during the transaction.

The *project* has the following properties:

**name**

The name of the project, which is the context root of the runtime.

**Errors**

401

Unauthorized - The caller is either not authenticated or not authorized to make this request.

404

Not Found - A beacon trigger with the specified triggerName is not found.

500

An internal error occurred.

## Beacon Trigger (GET)

Retrieves the beacon trigger with the triggerName.

**Roles**

Users in the following roles are authorized to perform this operation:

- **worklightadmin**
- **worklightdeployer**
- **worklightmonitor**
- **worklightoperator**

**Method**

GET

**Path**

*/management-apis/1.0/runtimes/runtime-name/trigger-name*

**Example**

[https://www.example.com/worklightadmin/management-apis/1.0/runtimes/myruntime/trigger-name/mytrigger?locale=de\\_DE](https://www.example.com/worklightadmin/management-apis/1.0/runtimes/myruntime/trigger-name/mytrigger?locale=de_DE)

**Path Parameters****runtime-name**

The name of the runtime. This is the context root of the runtime web application, without the leading slash.

**trigger-name**

The name of the beacon trigger.

**Query Parameters**

Query parameters are optional.

**locale**

The locale used for error messages.

**Produces**

application/json, application/xml, text/xml

**Response**

The details of the beacon trigger that is retrieved.

**JSON Example**

```
{
  "beaconTrigger" : {
    "actionPayload" : {
      "alert" : "Avail lowest interest rate of just 7.5% on home loans.",
    },
    "dwellingTime" : 5000,
    "proximityState" : "Near",
    "triggerName" : "DwellInsideLoanSection",
    "triggerType" : "Enter",
  },
  "productVersion" : "7.0.0",
}
```

**XML Example**

```
<?xml version="1.0" encoding="UTF-8"?>
<show-beacon-trigger-result productVersion="7.0.0">
  <beaconTrigger
    dwellingTime="5000"
    proximityState="Near"
    triggerName="DwellInsideLoanSection"
    triggerType="Enter">
    <actionPayload alert="Avail lowest interest rate of just 7.5% on home loans."/>
  </beaconTrigger>
</show-beacon-trigger-result>
```

**Response Properties**

The response has the following properties:

**beaconTrigger**

The beacon trigger that was found.

**productVersion**

The exact product version.

The *beaconTrigger* has the following properties:

**actionPayload**

The details of the action that is taken when the trigger is activated.

**dwellingTime**

Available only for triggerTypes: DwellInside and DwellOutside. It is the time



in milliseconds that specifies how long the device must be inside, or outside the associated beacon region before the DwellInside or DwellOutside trigger is activated.

**proximityState**

The proximity state that was specified for the beacon trigger. It is either Immediate, Near, or Far.

**triggerName**

The unique name of the beacon trigger.

**triggerType**

The type of beacon trigger. It is either Enter, Exit, DwellInside, or DwellOutside.

The *actionPayload* has the following properties:

**alert**

The alert message that is shown on the mobile device of user when this trigger is activated.

**Errors**

401

Unauthorized - The caller is either not authenticated or not authorized to make this request.

404

Not Found - No beacon-trigger found with matching triggerName.

406

Unsupported Accept type - The content type specified in Accept header is not application/json, application/xml or text/xml.

500

An internal error occurred.

**Beacon Triggers (GET)**

Retrieves all the beacon triggers.

**Roles**

Users in the following roles are authorized to perform this operation:

- **worklightadmin**
- **worklightdeployer**
- **worklightmonitor**
- **worklightoperator**

**Method**

GET

**Path**

/management-apis/1.0/runtimes/*runtime-name*/beaconTriggers

## Example

`https://www.example.com/worklightadmin/management-apis/1.0/runtimes/myruntime/beaconTriggers?locale=de_DE`

## Path Parameters

### **runtime-name**

The name of the runtime. This is the context root of the runtime web application, without the leading slash.

## Query Parameters

Query parameters are optional.

### **locale**

The locale used for error messages.

## Produces

application/json, application/xml, text/xml

## Response

The details of all the beacon triggers that are retrieved.

## JSON Example

```
{
  "beaconTriggers" : [
    {
      "actionPayload" : {
        "alert" : "Avail lowest interest rate of just 7.5% on home loans.",
      },
      "dwellingTime" : 5000,
      "proximityState" : "Near",
      "triggerName" : "DwellInsideLoanSection",
      "triggerType" : "Enter",
    },
    ...
  ],
  "productVersion" : "7.0.0",
}
```

## XML Example

```
<?xml version="1.0" encoding="UTF-8"?>
<list-beacon-triggers-result productVersion="7.0.0">
  <beaconTriggers>
    <beaconTrigger
      dwellingTime="5000"
      proximityState="Near"
      triggerName="DwellInsideLoanSection"
      triggerType="Enter">
      <actionPayload alert="Avail lowest interest rate of just 7.5% on home loans."/>
    </beaconTrigger>
    ...
  </beaconTriggers>
</list-beacon-triggers-result>
```

## Response Properties

The response has the following properties:

**beaconTriggers**

The array of the beacon triggers.

**productVersion**

The exact product version.

The *beaconTriggers* has the following properties:

**actionPayload**

The details of the action that is taken when the trigger is activated.

**dwellingTime**

Available only for triggerTypes: DwellInside and DwellOutside. It is the time in milliseconds that specifies how long the device must be inside, or outside the associated beacon region before the DwellInside or DwellOutside trigger is activated.

**proximityState**

The proximity state that was specified for the beacon trigger. It is either Immediate, Near, or Far.

**triggerName**

The unique name of the beacon trigger.

**triggerType**

The type of beacon trigger. It is either Enter, Exit, DwellInside, or DwellOutside.

The *actionPayload* has the following properties:

**alert**

The alert message that is shown on the mobile device of user when this trigger is activated.

**Errors**

401

Unauthorized - The caller is either not authenticated or not authorized to make this request.

406

Unsupported Accept type - The content type specified in Accept header is not application/json, application/xml or text/xml.

500

An internal error occurred.

**Beacon Triggers (POST)**

Adds a new beacon trigger by using the *triggerName*, *triggerType*, *proximityState*, and *actionPayload* properties.

**Roles**

Users in the following roles are authorized to perform this operation:

- **worklightadmin**
- **worklightdeployer**
- **worklightmonitor**
- **worklightoperator**

## Method

POST

## Path

/management-apis/1.0/runtimes/*runtime-name*/beaconTriggers

## Example

https://www.example.com/worklightadmin/management-apis/1.0/runtimes/myruntime/beaconTriggers?locale=de\_DE

## Path Parameters

### **runtime-name**

The name of the runtime. This is the context root of the runtime web application, without the leading slash.

## Query Parameters

Query parameters are optional.

### **locale**

The locale used for error messages.

## Consumes

application/json, application/xml, text/xml

## Produces

application/json, application/xml, text/xml

## Payload

The payload has values for the triggerName, triggerType, proximityState, dwellingTime, and actionPayload properties. It can be in JSON or XML format

## JSON Example

```
{
  "actionPayload" : {
    "alert" : "Avail lowest interest rate of just 7.5% on home loans!",
  },
  "dwellingTime" : 5000,
  "proximityState" : "Far",
  "triggerName" : "DwellInsideLoanSection",
  "triggerType" : "Enter",
}
```

## XML Example

```
<?xml version="1.0" encoding="UTF-8"?>
<beaconTrigger
  dwellingTime="5000"
  proximityState="Far"
  triggerName="DwellInsideLoanSection"
  triggerType="Enter">
  <actionPayload alert="Avail lowest interest rate of just 7.5% on home loans!"/>
</beaconTrigger>
```

## Payload Properties

The payload has the following properties:

### **actionPayload**

The details of an action to be taken when the trigger is activated.

### **dwellingTime**

Optional: Applicable only for triggerTypes: DwellInside and DwellOutside. It should be specified in milliseconds and defines how long the device must be inside, or outside a beacon region before the dwellInside or dwellOutside trigger is activated. Mandatory with triggerType of DwellInside and DwellOutside.

### **proximityState**

Optional: The proximity state that is specified for a beacon trigger. It can be either Immediate, Near, or Far. The default value is Far.

### **triggerName**

An unique name for this beacon trigger (consisting of alphanumeric or underscore characters and beginning with an alphabet).

### **triggerType**

The type of beacon trigger. The value of the type can be either Enter, Exit, DwellInside, or DwellOutside.

The *actionPayload* has the following properties:

### **alert**

The alert message to be sent when a trigger is activated.

## Response

The status of the adding of the beacon trigger.

## JSON Example

```
{
  "beaconTrigger" : {
    "actionPayload" : {
      "alert" : "Avail lowest interest rate of just 7.5% on home loans!",
    },
    "dwellingTime" : 5000,
    "proximityState" : "Far",
    "triggerName" : "DwellInsideLoanSection",
    "triggerType" : "Enter",
  },
  "productVersion" : "7.0.0",
  "transaction" : {
    "appServerId" : "Tomcat",
    "errors" : [
      {
      },
      ...
    ],
    "id" : 1,
    "project" : {
      "name" : "myproject",
    },
    "status" : "SUCCESS",
    "timeCreated" : "2014-11-14T05:21:13.404Z",
    "timeUpdated" : "2014-11-14T05:21:13.456Z",
    "type" : "ADD_BEACON_TRIGGER",
    "userName" : "demouser",
  }
}
```

```

    "warnings" : [
      {
        },
        ...
      ],
    },
  }

```

## XML Example

```

<?xml version="1.0" encoding="UTF-8"?>
<set-beacon-trigger-result productVersion="7.0.0">
  <beaconTrigger
    dwellingTime="5000"
    proximityState="Far"
    triggerName="DwellInsideLoanSection"
    triggerType="Enter">
    <actionPayload alert="Avail lowest interest rate of just 7.5% on home loans!"/>
  </beaconTrigger>
  <transaction
    appServerId="Tomcat"
    id="1"
    status="SUCCESS"
    timeCreated="2014-11-14T05:21:13.404Z"
    timeUpdated="2014-11-14T05:21:13.456Z"
    type="ADD_BEACON_TRIGGER"
    userName="demouser">
    <errors>
      <error/>
      ...
    </errors>
    <project name="myproject"/>
    <warnings>
      <warning/>
      ...
    </warnings>
  </transaction>
</set-beacon-trigger-result>

```

## Response Properties

The response has the following properties:

### **beaconTrigger**

The details of the beacon trigger that is created.

### **productVersion**

The exact product version.

### **transaction**

The details of the transaction.

The *beaconTrigger* has the following properties:

### **actionPayload**

The details of an action to be taken when the trigger is activated.

### **dwellingTime**

Optional: Applicable only for triggerTypes: DwellInside and DwellOutside. It should be specified in milliseconds and defines how long the device must be inside, or outside a beacon region before the dwellInside or dwellOutside trigger is activated. Mandatory with triggerType of DwellInside and DwellOutside.

**proximityState**

Optional: The proximity state that is specified for a beacon trigger. It can be either Immediate, Near, or Far. The default value is Far.

**triggerName**

An unique name for this beacon trigger.

**triggerType**

The type of beacon trigger. The value of the type can be either Enter, Exit, DwellInside, or DwellOutside.

The *actionPayload* has the following properties:

**alert**

The alert message to be sent when a trigger is activated.

The *transaction* has the following properties:

**appServerId**

The id of the web application server.

**errors**

Errors, if any, that occurred during the transaction.

**id** The id of the transaction.

**project**

The current project.

**status**

The state of the transaction: SUCCESS, FAILURE.

**timeCreated**

The date in ISO 8601 format when the transaction was started.

**timeUpdated**

The date in ISO 8601 format when the transaction was completed.

**type**

The type of the transaction: ADD\_BEACON\_TRIGGER.

**userName**

The user that initiated the transaction.

**warnings**

Warnings, if any, that occurred during the transaction.

The *project* has the following properties:

**name**

The name of the project, which is the context root of the runtime.

**Errors**

400

Bad Request - The request could not be understood by the server due to malformed syntax.

401

Unauthorized - The caller is either not authenticated or not authorized to make this request.

406

Unsupported Accept type - The content type specified in Accept header is not application/json, application/xml or text/xml.

409

Conflict - There is already an existing trigger with the specified triggerName.

415

Unsupported Media Type - The server is refusing to service the request because the request payload is not in application/json or application/xml or text/xml types.

500

An internal error occurred.

## Beacon Triggers (PUT)

Updates the beacon trigger that is specified by using the triggerName property. Other properties (triggerType, proximityState, dwellingTime, and actionPayload) are optional. Only those that need to be updated must be specified.

### Roles

Users in the following roles are authorized to perform this operation:

- **worklightadmin**
- **worklightdeployer**
- **worklightmonitor**
- **worklightoperator**

### Method

PUT

### Path

/management-apis/1.0/runtimes/*runtime-name*/beaconTriggers

### Example

[https://www.example.com/worklightadmin/management-apis/1.0/runtimes/myruntime/beaconTriggers?locale=de\\_DE](https://www.example.com/worklightadmin/management-apis/1.0/runtimes/myruntime/beaconTriggers?locale=de_DE)

### Path Parameters

#### **runtime-name**

The name of the runtime. This is the context root of the runtime web application, without the leading slash.

### Query Parameters

Query parameters are optional.

#### **locale**

The locale used for error messages.

### Consumes

application/json, application/xml, text/xml

### Produces

application/json, application/xml, text/xml



## Payload

The payload has values for the `triggerName`, `triggerType`, `proximityState`, `dwellingTime`, and `actionPayload` properties. It can be in JSON or XML format.

### JSON Example

```
{
  "actionPayload" : {
    "alert" : "Avail lowest interest rate of just 7.25% on home loans!",
  },
  "triggerName" : "DwellInsideLoanSection",
}
```

### XML Example

```
<?xml version="1.0" encoding="UTF-8"?>
<beaconTrigger triggerName="DwellInsideLoanSection">
  <actionPayload alert="Avail lowest interest rate of just 7.25% on home loans!"/>
</beaconTrigger>
```

## Payload Properties

The payload has the following properties:

### **actionPayload**

The details of an action to be taken when the trigger is activated.

### **triggerName**

An unique name for this beacon trigger.

The *actionPayload* has the following properties:

### **alert**

The alert message to be sent when a trigger is activated.

## Response

The status of the update of the beacon trigger.

### JSON Example

```
{
  "beaconTrigger" : {
    "actionPayload" : {
      "alert" : "Avail lowest interest rate of just 7.25% on home loans!",
    },
    "dwellingTime" : 5000,
    "proximityState" : "Far",
    "triggerName" : "DwellInsideLoanSection",
    "triggerType" : "Enter",
  },
  "productVersion" : "7.0.0",
  "transaction" : {
    "appServerId" : "Tomcat",
    "errors" : [
      {
      },
      ...
    ],
    "id" : 1,
    "project" : {
      "name" : "myproject",
    },
  },
  "status" : "SUCCESS",
}
```

```

    "timeCreated" : "2014-11-14T05:21:13.404Z",
    "timeUpdated" : "2014-11-14T05:21:13.456Z",
    "type" : "UPDATE_BEACON_TRIGGER",
    "userName" : "demouser",
    "warnings" : [
      {
      },
      ...
    ],
  },
}

```

## XML Example

```

<?xml version="1.0" encoding="UTF-8"?>
<set-beacon-trigger-result productVersion="7.0.0">
  <beaconTrigger
    dwellingTime="5000"
    proximityState="Far"
    triggerName="DwellInsideLoanSection"
    triggerType="Enter">
    <actionPayload alert="Avail lowest interest rate of just 7.25% on home loans!"/>
  </beaconTrigger>
  <transaction
    appServerId="Tomcat"
    id="1"
    status="SUCCESS"
    timeCreated="2014-11-14T05:21:13.404Z"
    timeUpdated="2014-11-14T05:21:13.456Z"
    type="UPDATE_BEACON_TRIGGER"
    userName="demouser">
    <errors>
      <error/>
      ...
    </errors>
    <project name="myproject"/>
    <warnings>
      <warning/>
      ...
    </warnings>
  </transaction>
</set-beacon-trigger-result>

```

## Response Properties

The response has the following properties:

### **beaconTrigger**

The details of the beacon trigger that is updated.

### **productVersion**

The exact product version.

### **transaction**

The details of the transaction.

The *beaconTrigger* has the following properties:

### **actionPayload**

The details of an action to be taken when the trigger is activated.

### **dwellingTime**

Optional: Applicable only for triggerTypes: DwellInside and DwellOutside. It should be specified in milliseconds and defines how long the device must be

inside, or outside a beacon region before the `dwellInside` or `dwellOutside` trigger is activated. Mandatory with `triggerType` of `DwellInside` and `DwellOutside`.

**proximityState**

Optional: The proximity state that is specified for a beacon trigger. It can be either `Immediate`, `Near`, or `Far`. The default value is `Far`.

**triggerName**

An unique name for this beacon trigger.

**triggerType**

The type of beacon trigger. The value of the type can be either `Enter`, `Exit`, `DwellInside`, or `DwellOutside`.

The *actionPayload* has the following properties:

**alert**

The alert message to be sent when a trigger is activated.

The *transaction* has the following properties:

**appServerId**

The id of the web application server.

**errors**

Errors, if any, that occurred during the transaction.

**id** The id of the transaction.

**project**

The current project.

**status**

The state of the transaction: `SUCCESS`, `FAILURE`.

**timeCreated**

The date in ISO 8601 format when the transaction was started.

**timeUpdated**

The date in ISO 8601 format when the transaction was completed.

**type**

The type of the transaction: `UPDATE_BEACON_TRIGGER`.

**userName**

The user that initiated the transaction.

**warnings**

Warnings, if any, that occurred during the transaction.

The *project* has the following properties:

**name**

The name of the project, which is the context root of the runtime.

**Errors**

400

Bad Request - The request could not be understood by the server due to malformed syntax.

401

Unauthorized - The caller is either not authenticated or not authorized to make this request.

404

Not Found - A beacon-trigger with specified triggerName does not exist.

406

Unsupported Accept type - The content type specified in Accept header is not application/json, application/xml or text/xml.

415

Unsupported Media Type - The server is refusing to service the request because the request payload is not in application/json or application/xml or text/xml types.

500

An internal error occurred.

## Beacons (DELETE)

Deletes the beacon by using the UUID, the major number, and minor number.

### Description

Each of these query parameters (uuid, major and minor) are mandatory. If any of them are missing, the request fails with 400 Bad Request.

### Roles

Users in the following roles are authorized to perform this operation:

- **worklightadmin**
- **worklightdeployer**
- **worklightmonitor**
- **worklightoperator**

### Method

DELETE

### Path

/management-apis/1.0/beacons

### Example

[https://www.example.com/worklightadmin/management-apis/1.0/beacons?locale=de\\_DE&major=1&minor=4439&uuid=3d402cf0-3691-4bd9-97ff-0b0a93a160ef](https://www.example.com/worklightadmin/management-apis/1.0/beacons?locale=de_DE&major=1&minor=4439&uuid=3d402cf0-3691-4bd9-97ff-0b0a93a160ef)

### Query Parameters

Query parameters are optional.

#### locale

The locale used for error messages.

#### major

Mandatory. The major number of the beacon.

#### minor

Mandatory. The minor number of the beacon.

**uuid**

Mandatory. The UUID of the beacon.

**Produces**

application/json, application/xml, text/xml

**Response**

The status of the delete of the beacon. The transaction details might be empty if there are no runtimes deployed.

**JSON Example**

```
{
  "beacon" : {
    "major" : 1,
    "minor" : 4439,
    "uuid" : "3d402cf0-3691-4bd9-97ff-0b0a93a160ef",
  },
  "ok" : false,
  "productVersion" : "7.0.0",
  "transactions" : [
    {
      "appServerId" : "Tomcat",
      "errors" : [
        {
        },
        ...
      ],
      "id" : 1,
      "project" : {
        "name" : "myproject",
      },
      "status" : "SUCCESS",
      "timeCreated" : "2014-11-14T05:21:13.404Z",
      "timeUpdated" : "2014-11-14T05:21:13.456Z",
      "type" : "DELETE_BEACON",
      "userName" : "demouser",
      "warnings" : [
        {
        },
        ...
      ],
    },
    ...
  ],
}
```

**XML Example**

```
<?xml version="1.0" encoding="UTF-8"?>
<remove-beacon-result
  ok="false"
  productVersion="7.0.0">
  <beacon
    major="1"
    minor="4439"
    uuid="3d402cf0-3691-4bd9-97ff-0b0a93a160ef"/>
  <transactions>
    <transaction
      appServerId="Tomcat"
      id="1"
      status="SUCCESS"
      timeCreated="2014-11-14T05:21:13.404Z"
```

```

timeUpdated="2014-11-14T05:21:13.456Z"
type="DELETE_BEACON"
userName="demouser">
<errors>
  <error/>
  ...
</errors>
<project name="myproject"/>
<warnings>
  <warning/>
  ...
</warnings>
</transaction>
...
</transactions>
</remove-beacon-result>

```

## Response Properties

The response has the following properties:

### **beacon**

The details of the beacon that is deleted.

**ok** Whether all transactions were successful.

### **productVersion**

The exact product version.

### **transactions**

The details of the transactions, one for each runtime.

The *beacon* has the following properties:

### **major**

The major number of the beacon.

### **minor**

The minor number of the beacon.

### **uuid**

The UUID of the beacon.

The *transaction* has the following properties:

### **appServerId**

The id of the web application server.

### **errors**

Errors, if any, that occurred during the transaction.

**id** The id of the transaction.

### **project**

The current project.

### **status**

The state of the transaction: SUCCESS, FAILURE.

### **timeCreated**

The date in ISO 8601 format when the transaction was started.

### **timeUpdated**

The date in ISO 8601 format when the transaction was completed.

**type**

The type of the transaction: DELETE\_BEACON.

**userName**

The user that initiated the transaction.

**warnings**

Warnings, if any, that occurred during the transaction.

The *project* has the following properties:

**name**

The name of the project, which is the context root of the runtime.

**Errors**

400

Bad Request - The request could not be understood by the server due to missing mandatory parameters `uuid`, `major`, `minor`.

401

Unauthorized - The caller is either not authenticated or not authorized to make this request.

404

A beacon with the specified `uuid+major+minor` numbers is not found.

500

An internal error occurred.

**Beacons (GET)**

Retrieves the beacon with the UUID, major number, and minor number.

**Description**

The beacons are retrieved based on which of the query parameters are mentioned:

- UUID, major number, and minor number are all specified: returns the details of a specific beacon.
- Only UUID and major number are specified: returns the details of all beacons with matching UUID and major number.
- Only UUID and minor number are specified: returns the details of all beacons with matching UUID and minor number.
- Only UUID is specified: returns the details of all beacons with matching UUID.
- None are specified: returns the details of all beacons.

**Roles**

Users in the following roles are authorized to perform this operation:

- **worklightadmin**
- **worklightdeployer**
- **worklightmonitor**
- **worklightoperator**

## Method

GET

## Path

/management-apis/1.0/beacons

## Example

```
https://www.example.com/worklightadmin/management-apis/1.0/
beacons?errorIfNotFound=true&locale=de_DE&major=1&minor=4439&
uuid=3d402cf0-3691-4bd9-97ff-0b0a93a160ef
```

## Query Parameters

Query parameters are optional.

### **errorIfNotFound**

If this flag is set to true (default value), and uuid and/or major/minor parameters are specified for which there are no matching beacons, then 'HTTP 404 Not Found' error is returned instead of an empty list in the output.

### **locale**

The locale used for error messages.

### **major**

The major number of the beacon.

### **minor**

The minor number of the beacon.

### **uuid**

The UUID of the beacon.

## Produces

application/json, application/xml, text/xml

## Response

The details of all the beacons that are retrieved.

## JSON Example

```
{
  "beacons" : [
    {
      "customData" : {
        "beaconLocation" : "loanSection",
        "branchName" : "Indiranagar, Bangalore",
      },
      "latitude" : 12.952,
      "longitude" : 77.644,
      "major" : 1,
      "minor" : 4439,
      "uuid" : "3d402cf0-3691-4bd9-97ff-0b0a93a160ef",
    },
    ...
  ],
  "productVersion" : 7.0.0,
}
```



## XML Example

```
<?xml version="1.0" encoding="UTF-8"?>
<list-beacons-result productVersion="7.0.0">
  <beacons>
    <beacon
      latitude="12.952"
      longitude="77.644"
      major="1"
      minor="4439"
      uuid="3d402cf0-3691-4bd9-97ff-0b0a93a160ef">
      <customData
        beaconLocation="loanSection"
        branchName="Indiranagar, Bangalore"/>
    </beacon>
    ...
  </beacons>
</list-beacons-result>
```

## Response Properties

The response has the following properties:

### **beacons**

The array of beacons

### **productVersion**

The exact product version.

The *beacons* has the following properties:

### **customData**

Optional: Any other customer-specific data that is associated with this beacon like branch/store where this beacon is deployed.

### **latitude**

Optional latitude where the beacon is deployed.

### **longitude**

Optional longitude where the beacon is deployed.

### **major**

The major number of the beacon.

### **minor**

The minor number of the beacon.

### **uuid**

The UUID of the beacon.

The *customData* has the following properties:

### **beaconLocation**

The physical location of the beacon.

### **branchName**

The branch where the beacon is installed.

## Errors

401

Unauthorized - The caller is either not authenticated or not authorized to make this request.

404

A beacon with the specified uuid and/or major/minor is not found and errorIfNotFound flag was either not specified or was set to true.

406

Unsupported Accept type - The content type specified in Accept header is not application/json, application/xml or text/xml.

500

An internal error occurred.

## Beacons (PUT)

Registers (Adds/Updates) the beacon that is identified by UUID, major number, and minor number in the payload.

### Roles

Users in the following roles are authorized to perform this operation:

- **worklightadmin**
- **worklightdeployer**
- **worklightmonitor**
- **worklightoperator**

### Method

PUT

### Path

/management-apis/1.0/beacons

### Example

[https://www.example.com/worklightadmin/management-apis/1.0/beacons?locale=de\\_DE](https://www.example.com/worklightadmin/management-apis/1.0/beacons?locale=de_DE)

### Query Parameters

Query parameters are optional.

#### **locale**

The locale used for error messages.

### Consumes

application/json, application/xml, text/xml

### Produces

application/json, application/xml, text/xml

### Payload

The payload can be in JSON or XML format and has values for UUID, major number, minor number, latitude, longitude, and customData properties.

## JSON Example

```
{
  "customData" : {
    "beaconLocation" : "loanSection",
    "branchName" : "Indiranagar, Bangalore",
  },
  "latitude" : "12.95213",
  "longitude" : "77.64482",
  "major" : 1,
  "minor" : 4439,
  "uuid" : "3d402cf0-3691-4bd9-97ff-0b0a93a160ef",
}
```

## XML Example

```
<?xml version="1.0" encoding="UTF-8"?>
<beacon
  latitude="12.95213"
  longitude="77.64482"
  major="1"
  minor="4439"
  uuid="3d402cf0-3691-4bd9-97ff-0b0a93a160ef">
  <customData
    beaconLocation="loanSection"
    branchName="Indiranagar, Bangalore"/>
</beacon>
```

## Payload Properties

The payload has the following properties:

### **customData**

Optional: Any other customer-specific data that is associated with this beacon like branch/store where this beacon is deployed.

### **latitude**

Optional latitude where the beacon is deployed.

### **longitude**

Optional longitude where the beacon is deployed.

### **major**

The major number of the beacon (positive number in the range 0-65535 inclusive).

### **minor**

The minor number of the beacon (positive number in the range 0-65535 inclusive).

### **uuid**

UUID of beacon. UUID must be specified in canonical form and has 32 hexadecimal digits. The digits are specified in five groups and separated by hyphens, in the form 8-4-4-4-12 for a total of 36 characters (32 alphanumeric characters and 4 hyphens).

The *customData* has the following properties:

### **beaconLocation**

The physical location of the beacon.

### **branchName**

The branch where the beacon is installed.

## Response

The status of the add/update of the beacon. The transaction details might be empty if there are no runtimes deployed.

## JSON Example

```
{
  "beacon" : {
    "customData" : {
      "beaconLocation" : "loanSection",
      "branchName" : "Indiranagar, Bangalore",
    },
    "latitude" : "12.952",
    "longitude" : "77.644",
    "major" : 1,
    "minor" : 4439,
    "uuid" : "3d402cf0-3691-4bd9-97ff-0b0a93a160ef",
  },
  "ok" : true,
  "productVersion" : "7.0.0",
  "transactions" : [
    {
      "appServerId" : "Tomcat",
      "errors" : [
        {
        },
      ],
      ...
    },
    {
      "id" : 1,
      "project" : {
        "name" : "myproject",
      },
      "status" : "SUCCESS",
      "timeCreated" : "2014-11-14T05:21:13.404Z",
      "timeUpdated" : "2014-11-14T05:21:13.456Z",
      "type" : "REGISTER_BEACON",
      "userName" : "demouser",
      "warnings" : [
        {
        },
      ],
      ...
    },
  ],
  ...
},
...
]
```

## XML Example

```
<?xml version="1.0" encoding="UTF-8"?>
<set-beacon-result
  ok="true"
  productVersion="7.0.0">
  <beacon
    latitude="12.952"
    longitude="77.644"
    major="1"
    minor="4439"
    uuid="3d402cf0-3691-4bd9-97ff-0b0a93a160ef">
    <customData
      beaconLocation="loanSection"
      branchName="Indiranagar, Bangalore"/>
  </beacon>
  <transactions>
    <transaction
      appServerId="Tomcat"
```

```

    id="1"
    status="SUCCESS"
    timeCreated="2014-11-14T05:21:13.404Z"
    timeUpdated="2014-11-14T05:21:13.456Z"
    type="REGISTER_BEACON"
    userName="demouser">
    <errors>
      <error/>
      ...
    </errors>
    <project name="myproject"/>
    <warnings>
      <warning/>
      ...
    </warnings>
  </transaction>
  ...
</transactions>
</set-beacon-result>

```

## Response Properties

The response has the following properties:

### **beacon**

The details of the beacon that is added/updated.

**ok** Whether all transactions were successful.

### **productVersion**

The exact product version.

### **transactions**

The details of the transactions, one for each runtime.

The *beacon* has the following properties:

### **customData**

Optional: Any other customer-specific data that is associated with this beacon like branch/store where this beacon is deployed.

### **latitude**

Optional latitude where the beacon is deployed.

### **longitude**

Optional longitude where the beacon is deployed.

### **major**

The major number of the beacon.

### **minor**

The minor number of the beacon.

### **uuid**

The UUID of the beacon.

The *customData* has the following properties:

### **beaconLocation**

The physical location of the beacon.

### **branchName**

The branch where the beacon is installed.

The *transaction* has the following properties:

**appServerId**

The id of the web application server.

**errors**

Errors, if any, that occurred during the transaction.

**id** The id of the transaction.

**project**

The current project.

**status**

The state of the transaction: SUCCESS, FAILURE.

**timeCreated**

The date in ISO 8601 format when the transaction was started.

**timeUpdated**

The date in ISO 8601 format when the transaction was completed.

**type**

The type of the transaction: REGISTER\_BEACON.

**userName**

The user that initiated the transaction.

**warnings**

Warnings, if any, that occurred during the transaction.

The *project* has the following properties:

**name**

The name of the project, which is the context root of the runtime.

**Errors**

400

Bad Request - The request could not be understood by the server due to malformed syntax or missing mandatory UUID, major and minor values.

401

Unauthorized - The caller is either not authenticated or not authorized to make this request.

406

Unsupported Accept type - The content type specified in Accept header is not application/json, application/xml or text/xml.

415

Unsupported Media Type - The server is refusing to service the request because the request payload is not in application/json or application/xml or text/xml types.

500

An internal error occurred.

## Device Application Status (PUT)

Changes the status of a specific application on a specific device.

## Description

A device can be marked as enabled or disabled for a specific device. Disabled applications cannot access the server.

This transaction can run synchronously or asynchronously. If processed asynchronously, the REST service returns before the transaction is completed. In this case, you can query the transaction result later with the transaction REST service.

## Roles

Users in the following roles are authorized to perform this operation:

- **worklightadmin**
- **worklightdeployer**
- **worklightoperator**

## Method

PUT

## Path

*/management-apis/1.0/runtimes/runtime-name/devices/device-id/applications/application-name*

## Example

[https://www.example.com/worklightadmin/management-apis/1.0/runtimes/myruntime/devices/12345-6789/applications/myapplication?async=false&locale=de\\_DE](https://www.example.com/worklightadmin/management-apis/1.0/runtimes/myruntime/devices/12345-6789/applications/myapplication?async=false&locale=de_DE)

## Path Parameters

### **runtime-name**

The name of the runtime. This is the context root of the runtime web application, without the leading slash.

### **application-name**

The name of the application.

### **device-id**

The device id.

## Query Parameters

Query parameters are optional.

### **async**

Whether the transaction is processed synchronously or asynchronously. Allowed values are true and false. The default is synchronous processing.

### **locale**

The locale used for error messages.

## Consumes

application/json

## Produces

application/json, application/xml, text/xml

## Payload

### JSON Example

```
{
  "status" : "ENABLED",
}
```

### Payload Properties

The payload has the following properties:

#### status

The status of the application: ENABLED or DISABLED.

## Response

The metadata of the transaction.

### JSON Example

```
{
  "ok" : false,
  "productVersion" : "7.0.0",
  "transaction" : {
    "appServerId" : "Tomcat",
    "description" : {
      "appName" : "myapplication",
      "deviceId" : "12345-6789",
      "status" : "ENABLED",
    },
    "errors" : [
      {
        "details" : "An internal error occured.",
      },
      ...
    ],
    "id" : 1,
    "project" : {
      "name" : "myproject",
    },
    "status" : "FAILURE",
    "timeCreated" : "2014-04-13T00:18:36.979Z",
    "timeUpdated" : "2014-04-14T00:18:36.979Z",
    "type" : "CHANGE_DEVICE_APPLICATION_STATUS",
    "userName" : "demouser",
  },
}
```

### XML Example

```
<?xml version="1.0" encoding="UTF-8"?>
<set-applicationdevice-status-result
  ok="false"
  productVersion="7.0.0">
<transaction
  appServerId="Tomcat"
  id="1"
  status="FAILURE"
  timeCreated="2014-04-13T00:18:36.979Z"
  timeUpdated="2014-04-14T00:18:36.979Z"
```



```

    type="CHANGE_DEVICE_APPLICATION_STATUS"
    userName="demouser">
    <description
      appName="myapplication"
      deviceId="12345-6789"
      status="ENABLED"/>
    <errors>
      <error details="An internal error occured."/>
      ...
    </errors>
    <project name="myproject"/>
  </transaction>
</set-applicationdevice-status-result>

```

## Response Properties

The response has the following properties:

**ok** Whether the transaction was successful.

**productVersion**

The exact product version.

**transaction**

The details of the transaction.

The *transaction* has the following properties:

**appServerId**

The id of the web application server.

**description**

The details of the status change.

**errors**

The errors occurred during the transaction.

**id** The id of the transaction.

**project**

The current project.

**status**

The state of the transaction: PENDING, PREPARING, COMMITTING, REJECTING, SUCCESS, FAILURE, CANCELED. Synchronous transactions can have the state SUCCESS and FAILURE. Asynchronous transactions can also have the other states.

**timeCreated**

The date in ISO 8601 format when the adapter was created.

**timeUpdated**

The date in ISO 8601 format when the adapter was updated.

**type**

The type of the transaction, here always CHANGE\_DEVICE\_APPLICATION\_STATUS.

**userName**

The user that initiated the transaction.

The *description* has the following properties:

**appName**

The application name.

**deviceId**

The device id.

**status**

The status of the application: ENABLED or DISABLED.

The *error* has the following properties:

**details**

The main error message.

The *project* has the following properties:

**name**

The name of the project, which is the context root of the runtime.

**Errors**

400

The payload is invalid.

403

The user is not authorized to call this service.

404

The corresponding runtime or the device is not found.

500

An internal error occurred.

**Device (DELETE)**

Deletes all metadata of a specific device.

**Description**

This transaction can run synchronously or asynchronously. If processed asynchronously, the REST service returns before the transaction is completed. In this case, you can query the transaction result later with the transaction REST service.

**Roles**

Users in the following roles are authorized to perform this operation:

- **worklightadmin**
- **worklightdeployer**
- **worklightoperator**

**Method**

DELETE

**Path**

*/management-apis/1.0/runtimes/runtime-name/devices/device-id*

**Example**

[https://www.example.com/worklightadmin/management-apis/1.0/runtimes/myruntime/devices/12345-6789?async=false&locale=de\\_DE](https://www.example.com/worklightadmin/management-apis/1.0/runtimes/myruntime/devices/12345-6789?async=false&locale=de_DE)

## Path Parameters

### **runtime-name**

The name of the runtime. This is the context root of the runtime web application, without the leading slash.

### **device-id**

The device id.

## Query Parameters

Query parameters are optional.

### **async**

Whether the transaction is processed synchronously or asynchronously. Allowed values are true and false. The default is synchronous processing.

### **locale**

The locale used for error messages.

## Produces

application/json, application/xml, text/xml

## Response

The metadata of the deleted device.

## JSON Example

```
{
  "ok" : false,
  "productVersion" : "7.0.0",
  "transaction" : {
    "appServerId" : "Tomcat",
    "description" : {
      "deviceId" : "12345-6789",
      "status" : "LOST",
    },
  },
  "errors" : [
    {
      "details" : "An internal error occurred.",
    },
    ...
  ],
  "id" : 1,
  "project" : {
    "name" : "myproject",
  },
  "status" : "FAILURE",
  "timeCreated" : "2014-04-13T00:18:36.979Z",
  "timeUpdated" : "2014-04-14T00:18:36.979Z",
  "type" : "REMOVE_DEVICE",
  "userName" : "demouser",
},
}
```

## XML Example

```
<?xml version="1.0" encoding="UTF-8"?>
<remove-device-result
  ok="false"
  productVersion="7.0.0">
  <transaction
    appServerId="Tomcat"
```

```

    id="1"
    status="FAILURE"
    timeCreated="2014-04-13T00:18:36.979Z"
    timeUpdated="2014-04-14T00:18:36.979Z"
    type="REMOVE_DEVICE"
    userName="demouser">
    <description
      deviceId="12345-6789"
      status="LOST"/>
    <errors>
      <error details="An internal error occured."/>
      ...
    </errors>
    <project name="myproject"/>
  </transaction>
</remove-device-result>

```

## Response Properties

The response has the following properties:

**ok** Whether the transaction was successful.

**productVersion**

The exact product version.

**transaction**

The details of the transaction.

The *transaction* has the following properties:

**appServerId**

The id of the web application server.

**description**

The details of the device.

**errors**

The errors occurred during the transaction.

**id** The id of the transaction.

**project**

The current project.

**status**

The state of the transaction: PENDING, PREPARING, COMMITTING, REJECTING, SUCCESS, FAILURE, CANCELED. Synchronous transactions can have the state SUCCESS and FAILURE. Asynchronous transactions can also have the other states.

**timeCreated**

The date in ISO 8601 format when the adapter was created.

**timeUpdated**

The date in ISO 8601 format when the adapter was updated.

**type**

The type of the transaction, here always REMOVE\_DEVICE.

**userName**

The user that initiated the transaction.

The *description* has the following properties:

**deviceId**

The device id.

**status**

The status of the device: ACTIVE, LOST, STOLEN, EXPIRED, DISABLED.

The *error* has the following properties:

**details**

The main error message.

The *project* has the following properties:

**name**

The name of the project, which is the context root of the runtime.

**Errors**

403

The user is not authorized to call this service.

404

The corresponding runtime or the device is not found.

500

An internal error occurred.

## Device Status (PUT)

Changes the status of a specific device.

**Description**

A device can be marked as active, lost, stolen, disabled, or expired. Lost, stolen or disabled devices cannot access the server. A device is marked expired if it has not connected to the MobileFirst server for 90 days.

This transaction can run synchronously or asynchronously. If processed asynchronously, the REST service returns before the transaction is completed. In this case, you can query the transaction result later with the transaction REST service.

**Roles**

Users in the following roles are authorized to perform this operation:

- **worklightadmin**
- **worklightdeployer**
- **worklightoperator**

**Method**

PUT

**Path**

*/management-apis/1.0/runtimes/runtime-name/devices/device-id*

## Example

[https://www.example.com/worklightadmin/management-apis/1.0/runtimes/myruntime/devices/12345-6789?async=false&locale=de\\_DE](https://www.example.com/worklightadmin/management-apis/1.0/runtimes/myruntime/devices/12345-6789?async=false&locale=de_DE)

## Path Parameters

### **runtime-name**

The name of the runtime. This is the context root of the runtime web application, without the leading slash.

### **device-id**

The device id.

## Query Parameters

Query parameters are optional.

### **async**

Whether the transaction is processed synchronously or asynchronously. Allowed values are true and false. The default is synchronous processing.

### **locale**

The locale used for error messages.

## Consumes

application/json

## Produces

application/json, application/xml, text/xml

## Payload

### JSON Example

```
{
  "status" : "LOST",
}
```

## Payload Properties

The payload has the following properties:

### **status**

The new status of the device: ACTIVE, LOST, STOLEN, EXPIRED, DISABLED.

## Response

The metadata of the transaction.

### JSON Example

```
{
  "ok" : false,
  "productVersion" : "7.0.0",
  "transaction" : {
    "appServerId" : "Tomcat",
    "description" : {
      "deviceId" : "12345-6789",
      "status" : "LOST",
    },
  },
}
```

```

"errors" : [
  {
    "details" : "An internal error occured.",
  },
  ...
],
"id" : 1,
"project" : {
  "name" : "myproject",
},
"status" : "FAILURE",
"timeCreated" : "2014-04-13T00:18:36.979Z",
"timeUpdated" : "2014-04-14T00:18:36.979Z",
"type" : "CHANGE_DEVICE_STATUS",
"userName" : "demouser",
},
}

```

## XML Example

```

<?xml version="1.0" encoding="UTF-8"?>
<set-device-status-result
  ok="false"
  productVersion="7.0.0">
  <transaction
    appServerId="Tomcat"
    id="1"
    status="FAILURE"
    timeCreated="2014-04-13T00:18:36.979Z"
    timeUpdated="2014-04-14T00:18:36.979Z"
    type="CHANGE_DEVICE_STATUS"
    userName="demouser">
    <description
      deviceId="12345-6789"
      status="LOST"/>
    <errors>
      <error details="An internal error occured."/>
      ...
    </errors>
    <project name="myproject"/>
  </transaction>
</set-device-status-result>

```

## Response Properties

The response has the following properties:

**ok** Whether the transaction was successful.

**productVersion**  
The exact product version.

**transaction**  
The details of the transaction.

The *transaction* has the following properties:

**appServerId**  
The id of the web application server.

**description**  
The details of the status change.

**errors**  
The errors occurred during the transaction.

**id** The id of the transaction.

**project**

The current project.

**status**

The state of the transaction: PENDING, PREPARING, COMMITTING, REJECTING, SUCCESS, FAILURE, CANCELED. Synchronous transactions can have the state SUCCESS and FAILURE. Asynchronous transactions can also have the other states.

**timeCreated**

The date in ISO 8601 format when the adapter was created.

**timeUpdated**

The date in ISO 8601 format when the adapter was updated.

**type**

The type of the transaction, here always CHANGE\_DEVICE\_STATUS.

**userName**

The user that initiated the transaction.

The *description* has the following properties:

**deviceId**

The device id.

**status**

The status of the device: ACTIVE, LOST, STOLEN, EXPIRED, DISABLED.

The *error* has the following properties:

**details**

The main error message.

The *project* has the following properties:

**name**

The name of the project, which is the context root of the runtime.

**Errors**

400

The payload is invalid.

403

The user is not authorized to call this service.

404

The corresponding runtime or the device is not found.

500

An internal error occurred.

**Devices (GET)**

Retrieves metadata for the list of devices that accessed this project.

**Roles**

Users in the following roles are authorized to perform this operation:

- **worklightadmin**



- **worklightdeployer**
- **worklightmonitor**
- **worklightoperator**

## Method

GET

## Path

*/management-apis/1.0/runtimes/runtime-name/devices*

## Example

`https://www.example.com/worklightadmin/management-apis/1.0/runtimes/myruntime/devices?locale=de_DE&offset=0&orderBy=uid&pageSize=100&query=Jeremy`

## Path Parameters

### **runtime-name**

The name of the runtime. This is the context root of the runtime web application, without the leading slash.

## Query Parameters

Query parameters are optional.

### **locale**

The locale used for error messages.

### **offset**

The offset from the beginning of the list if only a part of the list (a page) should be returned.

### **orderBy**

The sort mode. By default, the elements are sorted in increasing order. If the sort mode starts with - (minus sign), the elements are sorted in decreasing order. Possible sort modes are: uid, friendlyName, deviceModel, deviceEnvironment, status, lastAccessed. The default sort mode is: uid.

### **pageSize**

The number of elements if only a part of the list (a page) should be returned. The default value is 100.

### **query**

A device friendly name or a user to search for.

## Produces

application/json, application/xml, text/xml

## Response

The metadata of the devices that accessed this project.

## JSON Example

```
{
  "items" : [
    {
      "applicationDeviceAssociations" : [
```

```

        {
          "appName" : "myapplication",
          "deviceId" : "12345-6789",
          "deviceStatus" : "LOST",
          "status" : "ENABLED",
        },
        ...
      ],
      "deviceEnvironment" : "iphone",
      "deviceModel" : "iPhone 5",
      "deviceOs" : "4.4",
      "friendlyName" : "Jeremy's Personal Phone",
      "id" : "12345-6789",
      "lastAccessed" : "2014-05-13T00:18:36.979Z",
      "status" : "LOST",
      "uid" : "Jeremy",
    },
    ...
  ],
  "pageSize" : 100,
  "productVersion" : "7.0.0",
  "startIndex" : 0,
  "totalListSize" : 33,
}

```

## XML Example

```

<?xml version="1.0" encoding="UTF-8"?>
<devices
  pageSize="100"
  productVersion="7.0.0"
  startIndex="0"
  totalListSize="33">
  <items>
    <item
      deviceEnvironment="iphone"
      deviceModel="iPhone 5"
      deviceOs="4.4"
      friendlyName="Jeremy's Personal Phone"
      id="12345-6789"
      lastAccessed="2014-05-13T00:18:36.979Z"
      status="LOST"
      uid="Jeremy">
      <applicationDeviceAssociations>
        <applicationDeviceAssociation
          appName="myapplication"
          deviceId="12345-6789"
          deviceStatus="LOST"
          status="ENABLED"/>
        ...
      </applicationDeviceAssociations>
    </item>
    ...
  </items>
</devices>

```

## Response Properties

The response has the following properties:

### **items**

The array of device metadata

### **pageSize**

The page size if only a page of devices is returned.

**productVersion**

The exact product version.

**startIndex**

The start index in the total list if only a page of devices is returned.

**totalListSize**

The total number of devices.

The *device* has the following properties:

**applicationDeviceAssociations**

The applications on the device.

**deviceEnvironment**

The platform environment of the app version: iphone.

**deviceModel**

The device model.

**deviceOs**

The device operating system.

**friendlyName**

The friendly name of the device.

**id** The device id.

**lastAccessed**

The date in ISO 8601 format when the device was last accessed.

**status**

The status of the device: ACTIVE, LOST, STOLEN, EXPIRED, DISABLED.

**uid**

The user name of the device.

The *device application* has the following properties:

**appName**

The name of the application.

**deviceId**

The device id.

**deviceStatus**

The status of the device: ACTIVE, LOST, STOLEN, EXPIRED, DISABLED.

**status**

The status of the application: ENABLED or DISABLED.

**Errors**

403

The user is not authorized to call this service.

404

The corresponding runtime is not found or not running.

500

An internal error occurred.

## Event Source (GET)

Retrieves metadata for the event source.

### Roles

Users in the following roles are authorized to perform this operation:

- **worklightadmin**
- **worklightdeployer**
- **worklightmonitor**
- **worklightoperator**

### Method

GET

### Path

*/management-apis/1.0/runtimes/runtime-name/notifications/eventsources/adapter-name/eventsource-name*

### Example

[https://www.example.com/worklightadmin/management-apis/1.0/runtimes/myruntime/notifications/eventsources/myadapter/myeventsource?locale=de\\_DE](https://www.example.com/worklightadmin/management-apis/1.0/runtimes/myruntime/notifications/eventsources/myadapter/myeventsource?locale=de_DE)

### Path Parameters

#### **runtime-name**

The name of the runtime. This is the context root of the runtime web application, without the leading slash.

#### **adapter-name**

The name of the adapter.

#### **eventsource-name**

The name of the event source.

### Query Parameters

Query parameters are optional.

#### **locale**

The locale used for error messages.

### Produces

application/json, application/xml, text/xml

### Response

The metadata of the event source.

## JSON Example

```
{
  "numberOfMessagesSent" : 1,
  "numberOfSubscribedUsers" : 1,
  "productVersion" : "7.0.0",
  "qname" : "SampleAdapter.SampleEventSource",
}
```

## XML Example

```
<?xml version="1.0" encoding="UTF-8"?>
<eventsources
  numberOfMessagesSent="1"
  numberOfSubscribedUsers="1"
  productVersion="7.0.0"
  qname="SampleAdapter.SampleEventSource"/>
```

## Response Properties

The response has the following properties:

### **numberOfMessagesSent**

Number of messages sent to this event source.

### **numberOfSubscribedUsers**

Number of subscribed users of this event source.

### **productVersion**

The exact product version.

### **qname**

The name of the event source.

## Errors

403

The user is not authorized to call this service.

404

The corresponding runtime is not found or not running.

500

An internal error occurred.

## Event Sources (GET)

Retrieves metadata for the list of event sources.

## Roles

Users in the following roles are authorized to perform this operation:

- **worklightadmin**
- **worklightdeployer**
- **worklightmonitor**
- **worklightoperator**

## Method

GET

## Path

/management-apis/1.0/runtimes/*runtime-name*/notifications/eventsources

## Example

https://www.example.com/worklightadmin/management-apis/1.0/runtimes/myruntime/notifications/eventsources?locale=de\_DE

## Path Parameters

### **runtime-name**

The name of the runtime. This is the context root of the runtime web application, without the leading slash.

## Query Parameters

Query parameters are optional.

### **locale**

The locale used for error messages.

## Produces

application/json, application/xml, text/xml

## Response

The metadata of the event sources.

## JSON Example

```
{
  "eventsources" : [
    {
      "numberOfMessagesSent" : 1,
      "numberOfSubscribedUsers" : 1,
      "qname" : "myadapter.myeventsource",
    },
    ...
  ],
  "productVersion" : "7.0.0",
}
```

## XML Example

```
<?xml version="1.0" encoding="UTF-8"?>
<eventsources productVersion="7.0.0">
  <eventsources>
    <eventsource
      numberOfMessagesSent="1"
      numberOfSubscribedUsers="1"
      qname="myadapter.myeventsource"/>
    ...
  </eventsources>
</eventsources>
```

## Response Properties

The response has the following properties:

### **eventsources**

The array of event source metadata

**productVersion**

The exact product version.

The *eventsSource* has the following properties:

**numberOfMessagesSent**

Number of messages sent to this event source.

**numberOfSubscribedUsers**

Number of subscribed users of this event source.

**qname**

The name of the event source.

**Errors**

403

The user is not authorized to call this service.

404

The corresponding runtime is not found or not running.

500

An internal error occurred.

## Farm topology members (GET)

Retrieves the list of members of the farm.

**Roles**

Users in the following roles are authorized to perform this operation:

- **worklightadmin**
- **worklightdeployer**
- **worklightmonitor**
- **worklightoperator**

**Method**

GET

**Path**

*/management-apis/1.0/runtimes/runtime-name/farm*

**Example**

[https://www.example.com/worklightadmin/management-apis/1.0/runtimes/myruntime/farm?locale=de\\_DE](https://www.example.com/worklightadmin/management-apis/1.0/runtimes/myruntime/farm?locale=de_DE)

**Path Parameters****runtime-name**

The name of the runtime. This is the context root of the runtime web application, without the leading slash.

## Query Parameters

Query parameters are optional.

### locale

The locale used for error messages.

## Produces

application/json, application/xml, text/xml

## Response

The list of nodes registered in the current farm topology

## JSON Example

```
{
  "nodes" : [
    {
      "adminUser" : "johndoe",
      "appServerType" : "LIBERTY",
      "heartbeatTime" : "2014-12-08T23:32:04.700Z",
      "host" : "192.168.0.4",
      "pk" : {
        "projectName" : "mytestproject",
        "serverId" : "Farm_Node_3",
      },
      "port" : "8686",
      "status" : "ALIVE",
      "tomcatPort" : "8989",
    },
    ...
  ],
  "numberOfNodes" : 3,
  "productVersion" : "7.0",
}
```

## XML Example

```
<?xml version="1.0" encoding="UTF-8"?>
<farm-members
  numberOfNodes="3"
  productVersion="7.0">
  <nodes>
    <node
      adminUser="johndoe"
      appServerType="LIBERTY"
      heartbeatTime="2014-12-08T23:32:04.700Z"
      host="192.168.0.4"
      port="8686"
      status="ALIVE"
      tomcatPort="8989">
      <pk
        projectName="mytestproject"
        serverId="Farm_Node_3"/>
    </node>
    ...
  </nodes>
</farm-members>
```

## Response Properties

The response has the following properties:



**nodes**

The array of farm nodes

**numberOfNodes**

The total number of nodes.

**productVersion**

The exact product version.

The *farm node* has the following properties:

**adminUser**

The user id to use for REST

**appServerType**

The server type of this node

**heartbeatTime**

The last heartbeat time

**host**

The hostname of this node

**pk** The primary key of this node

**port**

The port to use for REST or RMI

**status**

The status of this node

**tomcatPort**

The port to use for RMI if behind a firewall

The *farm node pk* has the following properties:

**projectName**

The MobileFirst runtime related to this farm member

**serverId**

The server identifier of this farm member

**Errors**

403

The user is not authorized to call this service.

404

The corresponding runtime is not found.

500

An internal error occurred.

## Farm topology members (DELETE)

Unregisters a farm node.

### Description

This service removes a farm node. By default, the service will remove a farm node only if it is marked as being Down. If you want to force the deletion, even if the farm member is marked as being Alive, you should set the force argument to true.

## Roles

Users in the following roles are authorized to perform this operation:

- **worklightadmin**

## Method

DELETE

## Path

*/management-apis/1.0/runtimes/runtime-name/farm/server-id*

## Example

[https://www.example.com/worklightadmin/management-apis/1.0/runtimes/myruntime/farm/farm\\_member\\_1?force=false&locale=de\\_DE](https://www.example.com/worklightadmin/management-apis/1.0/runtimes/myruntime/farm/farm_member_1?force=false&locale=de_DE)

## Path Parameters

### **runtime-name**

The name of the runtime. This is the context root of the runtime web application, without the leading slash.

### **server-id**

The server id of the farm member to remove

## Query Parameters

Query parameters are optional.

### **force**

Whether the service should unregister a farm member, even if it is marked as being Alive. The default is false.

### **locale**

The locale used for error messages.

## Produces

application/json, application/xml, text/xml

## Response

The status of the unregistration of the farm member

## JSON Example

```
{
  "ok" : true,
  "productVersion" : "7.0",
}
```

## XML Example

```
<?xml version="1.0" encoding="UTF-8"?>
<remove-farm-member-result
  ok="true"
  productVersion="7.0"/>
```

## Response Properties

The response has the following properties:

**ok** Whether the operation was successful.

**productVersion**

The exact product version.

## Errors

403

The user is not authorized to call this service.

404

The corresponding farm member is not found.

500

An internal error occurred.

## GCM Credentials (DELETE)

Deletes Google Cloud Messaging (GCM) credentials of the application with the application ID, environment, and version.

## Roles

Users in the following roles are authorized to perform this operation:

- **worklightadmin**
- **worklightdeployer**
- **worklightmonitor**
- **worklightoperator**

## Method

DELETE

## Path

*/management-apis/1.0/runtimes/runtime-name/notifications/applications/application-name/gcmConf/application-env/application-version/*

## Example

[https://www.example.com/worklightadmin/management-apis/1.0/runtimes/myruntime/notifications/applications/myapplication/gcmConf/android/1.0/?locale=de\\_DE](https://www.example.com/worklightadmin/management-apis/1.0/runtimes/myruntime/notifications/applications/myapplication/gcmConf/android/1.0/?locale=de_DE)

## Path Parameters

**runtime-name**

The name of the runtime. This is the context root of the runtime web application, without the leading slash.

**application-name**

The name of the application.

**application-env**

The application environment.

**application-version**

The application version number.

**Query Parameters**

Query parameters are optional.

**locale**

The locale used for error messages.

**Produces**

application/json, application/xml, text/xml

**Response**

The delete status of GCM credentials.

**JSON Example**

```
{
  "productVersion" : {
    "productVersion" : "7.0.0",
  },
  "project" : {
    "name" : "PushNotifications",
  },
  "status" : "Success",
  "type" : "DELETE_PUSH_CREDENTIALS",
}
```

**XML Example**

```
<?xml version="1.0" encoding="UTF-8"?>
<deleteGCMCredentialsStatus
  status="Success"
  type="DELETE_PUSH_CREDENTIALS">
  <productVersion productVersion="7.0.0"/>
  <project name="PushNotifications"/>
</deleteGCMCredentialsStatus>
```

**Response Properties**

The response has the following properties:

**productVersion**

The exact product version.

**project**

Project name.

**status**

The GCM credentials are deleted successfully.

**type**

Transaction type.

The *productVersion* has the following properties:

**productVersion**

The exact product version

The *project* has the following properties:

**name**  
Name of the project

## Errors

403  
The user is not authorized to call this service.

404  
The corresponding runtime is not found or not running.

500  
An internal error occurred.

## GCM Credentials (GET)

Retrieves Google Cloud Messaging (GCM) credentials of the application with the application ID, environment, and version.

### Roles

Users in the following roles are authorized to perform this operation:

- **worklightadmin**
- **worklightdeployer**
- **worklightmonitor**
- **worklightoperator**

### Method

GET

### Path

*/management-apis/1.0/runtimes/runtime-name/notifications/applications/  
application-name/gcmConf/application-env/application-version/*

### Example

[https://www.example.com/worklightadmin/management-apis/1.0/runtimes/myruntime/notifications/applications/myapplication/gcmConf/android/1.0/?locale=de\\_DE](https://www.example.com/worklightadmin/management-apis/1.0/runtimes/myruntime/notifications/applications/myapplication/gcmConf/android/1.0/?locale=de_DE)

### Path Parameters

**runtime-name**  
The name of the runtime. This is the context root of the runtime web application, without the leading slash.

**application-name**  
The name of the application.

**application-env**  
The application environment.

**application-version**  
The application version number.

## Query Parameters

Query parameters are optional.

### **locale**

The locale used for error messages.

## Produces

application/json, application/xml, text/xml

## Response

The GCM Credentials of the application with the application ID, environment, and version.

## JSON Example

```
{
  "apiKey" : "AIzaSyDSJrULbNZZZzzZzzyX7ZTmnoRLkwiU",
  "productVersion" : "7.0.0",
  "senderId" : "999999999999",
}
```

## XML Example

```
<?xml version="1.0" encoding="UTF-8"?>
<gcmCredentials
  apiKey="AIzaSyDSJrULbNZZZzzZzzyX7ZTmnoRLkwiU"
  productVersion="7.0.0"
  senderId="999999999999"/>
```

## Response Properties

The response has the following properties:

### **apiKey**

The key value received from GCM.

### **productVersion**

The exact product version.

### **senderId**

The project ID received from GCM.

## Errors

403

The user is not authorized to call this service.

404

The corresponding runtime is not found or not running.

500

An internal error occurred.

## GCM Credentials (PUT)

Set Google Cloud Messaging (GCM) credentials of the application with the application ID, environment, and version.

## Roles

Users in the following roles are authorized to perform this operation:

- **worklightadmin**
- **worklightdeployer**
- **worklightmonitor**
- **worklightoperator**

## Method

PUT

## Path

*/management-apis/1.0/runtimes/runtime-name/notifications/applications/application-name/gcmConf/application-env/application-version/*

## Example

[https://www.example.com/worklightadmin/management-apis/1.0/runtimes/myruntime/notifications/applications/myapplication/gcmConf/android/1.0/?locale=de\\_DE](https://www.example.com/worklightadmin/management-apis/1.0/runtimes/myruntime/notifications/applications/myapplication/gcmConf/android/1.0/?locale=de_DE)

## Path Parameters

### **runtime-name**

The name of the runtime. This is the context root of the runtime web application, without the leading slash.

### **application-name**

The name of the application.

### **application-env**

The application environment.

### **application-version**

The application version number.

## Query Parameters

Query parameters are optional.

### **locale**

The locale used for error messages.

## Consumes

application/json

## Produces

application/json, application/xml, text/xml

## Payload

The payload in JSON format has values for apiKey and senderId.

## JSON Example

```
{
  "apiKey" : "AizaSyDSJrrrrrrrrrrZZZZZZX7ZTmnoRLkwiU",
  "senderId" : "1099999999999",
}
```

## Payload Properties

The payload has the following properties:

### apiKey

The key value received from GCM.

### senderId

The project ID received from GCM.

## Response

The status of set GCM credentials.

## JSON Example

```
{
  "productVersion" : {
    "productVersion" : "7.0.0",
  },
  "project" : {
    "name" : "PushNotifications",
  },
  "status" : "Success",
  "type" : "SET_GCM_CREDENTIALS",
}
```

## XML Example

```
<?xml version="1.0" encoding="UTF-8"?>
<setGCMCredentialsStatus
  status="Success"
  type="SET_GCM_CREDENTIALS">
  <productVersion productVersion="7.0.0"/>
  <project name="PushNotifications"/>
</setGCMCredentialsStatus>
```

## Response Properties

The response has the following properties:

### productVersion

The exact product version.

### project

Project name.

### status

The GCM credentials are saved successfully.

### type

Transaction type.

The *productVersion* has the following properties:

### productVersion

The exact product version



The *project* has the following properties:

**name**

Name of the project

## Errors

403

The user is not authorized to call this service.

404

The corresponding runtime is not found or not running.

500

An internal error occurred.

## Mediator (GET)

Retrieves metadata of the mediator.

### Roles

Users in the following roles are authorized to perform this operation:

- **worklightadmin**
- **worklightdeployer**
- **worklightmonitor**
- **worklightoperator**

### Method

GET

### Path

*/management-apis/1.0/runtimes/runtime-name/notifications/mediators/mediator-name*

### Example

[https://www.example.com/worklightadmin/management-apis/1.0/runtimes/myruntime/notifications/mediators/Google?locale=de\\_DE](https://www.example.com/worklightadmin/management-apis/1.0/runtimes/myruntime/notifications/mediators/Google?locale=de_DE)

### Path Parameters

**runtime-name**

The name of the runtime. This is the context root of the runtime web application, without the leading slash.

**mediator-name**

The name of the mediator.

### Query Parameters

Query parameters are optional.

**locale**

The locale used for error messages.

## Produces

application/json, application/xml, text/xml

## Response

The metadata of the mediator.

## JSON Example

```
{
  "productVersion" : "7.0.0",
  "type" : "Google",
}
```

## XML Example

```
<?xml version="1.0" encoding="UTF-8"?>
<mediators
  productVersion="7.0.0"
  type="Google"/>
```

## Response Properties

The response has the following properties:

### **productVersion**

The exact product version.

### **type**

The type of the mediator.

## Errors

403

The user is not authorized to call this service.

404

The corresponding runtime is not found or not running.

500

An internal error occurred.

## Mediators (GET)

Retrieves the list of all supported mediators for sending notifications.

## Roles

Users in the following roles are authorized to perform this operation:

- **worklightadmin**
- **worklightdeployer**
- **worklightmonitor**
- **worklightoperator**

## Method

GET

## Path

/management-apis/1.0/runtimes/*runtime-name*/notifications/mediators

## Example

[https://www.example.com/worklightadmin/management-apis/1.0/runtimes/myruntime/notifications/mediators?locale=de\\_DE](https://www.example.com/worklightadmin/management-apis/1.0/runtimes/myruntime/notifications/mediators?locale=de_DE)

## Path Parameters

### **runtime-name**

The name of the runtime. This is the context root of the runtime web application, without the leading slash.

## Query Parameters

Query parameters are optional.

### **locale**

The locale used for error messages.

## Produces

application/json, application/xml, text/xml

## Response

The list of all supported mediators for sending notifications.

## JSON Example

```
{
  "mediators" : [
    {
      "type" : "Google",
    },
    ...
  ],
  "productVersion" : "7.0.0",
}
```

## XML Example

```
<?xml version="1.0" encoding="UTF-8"?>
<mediators productVersion="7.0.0">
  <mediators>
    <mediator type="Google"/>
    ...
  </mediators>
</mediators>
```

## Response Properties

The response has the following properties:

### **mediators**

The array of mediator metadata

### **productVersion**

The exact product version.

The *mediator* has the following properties:

**type**

The type of the mediator.

**Errors**

403

The user is not authorized to call this service.

404

The corresponding runtime is not found or not running.

500

An internal error occurred.

## MPNS Credentials (DELETE)

Deletes MPNS credentials of the application with the application ID, environment, and version.

**Roles**

Users in the following roles are authorized to perform this operation:

- **worklightadmin**
- **worklightdeployer**
- **worklightmonitor**
- **worklightoperator**

**Method**

DELETE

**Path**

*/management-apis/1.0/runtimes/runtime-name/notifications/applications/  
application-name/mpnsConf/application-env/application-version/*

**Example**

[https://www.example.com/worklightadmin/management-apis/1.0/runtimes/myruntime/notifications/applications/myapplication/mpnsConf/android/1.0/?locale=de\\_DE](https://www.example.com/worklightadmin/management-apis/1.0/runtimes/myruntime/notifications/applications/myapplication/mpnsConf/android/1.0/?locale=de_DE)

**Path Parameters****runtime-name**

The name of the runtime. This is the context root of the runtime web application, without the leading slash.

**application-name**

The name of the application.

**application-env**

The application environment.

**application-version**

The application version number.

## Query Parameters

Query parameters are optional.

### locale

The locale used for error messages.

## Produces

application/json, application/xml, text/xml

## Response

The delete status of MPNS credentials.

## JSON Example

```
{
  "productVersion" : {
    "productVersion" : "7.0.0",
  },
  "project" : {
    "name" : "PushNotifications",
  },
  "status" : "Success",
  "type" : "DELETE_PUSH_CREDENTIALS",
}
```

## XML Example

```
<?xml version="1.0" encoding="UTF-8"?>
<deleteMPNScredentials
  status="Success"
  type="DELETE_PUSH_CREDENTIALS">
  <productVersion productVersion="7.0.0"/>
  <project name="PushNotifications"/>
</deleteMPNScredentials>
```

## Response Properties

The response has the following properties:

### productVersion

The exact product version.

### project

Project name.

### status

The MPNS credentials are deleted successfully.

### type

Transaction type.

The *productVersion* has the following properties:

### productVersion

The exact product version

The *project* has the following properties:

### name

Name of the project

## Errors

403

The user is not authorized to call this service.

404

The corresponding runtime is not found or not running.

500

An internal error occurred.

## MPNS Credentials (GET)

Retrieves MPNS credentials of the application with the application ID, environment, and version.

### Roles

Users in the following roles are authorized to perform this operation:

- **worklightadmin**
- **worklightdeployer**
- **worklightmonitor**
- **worklightoperator**

### Method

GET

### Path

*/management-apis/1.0/runtimes/runtime-name/notifications/applications/application-name/mpnsConf/application-env/application-version/*

### Example

[https://www.example.com/worklightadmin/management-apis/1.0/runtimes/myruntime/notifications/applications/myapplication/mpnsConf/android/1.0/?locale=de\\_DE](https://www.example.com/worklightadmin/management-apis/1.0/runtimes/myruntime/notifications/applications/myapplication/mpnsConf/android/1.0/?locale=de_DE)

### Path Parameters

#### **runtime-name**

The name of the runtime. This is the context root of the runtime web application, without the leading slash.

#### **application-name**

The name of the application.

#### **application-env**

The application environment.

#### **application-version**

The application version number.

### Query Parameters

Query parameters are optional.

**locale**

The locale used for error messages.

**Produces**

application/json, application/xml, text/xml

**Response**

The MPNS Credentials of the application with the application ID, environment, and version.

**JSON Example**

```
{
  "authenticated" : true,
  "keyAlias" : "aliasName",
  "keyAliasPassword" : "password",
  "productVersion" : "7.0.0",
  "serviceName" : "wl.ibm.push",
}
```

**XML Example**

```
<?xml version="1.0" encoding="UTF-8"?>
<mpnsCredentials
  authenticated="true"
  keyAlias="aliasName"
  keyAliasPassword="password"
  productVersion="7.0.0"
  serviceName="wl.ibm.push"/>
```

**Response Properties**

The response has the following properties:

**authenticated**

Returns whether the push configuration is authenticated.

**keyAlias**

The alias used to access the keystore specified in the worklight.properties.

**keyAliasPassword**

The password for the key alias.

**productVersion**

The exact product version.

**serviceName**

The common name (CN) found in the MPNS certificate's Subject value.

**Errors**

403

The user is not authorized to call this service.

404

The corresponding runtime is not found or not running.

500

An internal error occurred.

## MPNS Credentials (PUT)

Set MPNS credentials of the application with the application ID, environment, version, keyAlias, keyAliasPassword, and serviceName.

### Roles

Users in the following roles are authorized to perform this operation:

- **worklightadmin**
- **worklightdeployer**
- **worklightmonitor**
- **worklightoperator**

### Method

PUT

### Path

*/management-apis/1.0/runtimes/runtime-name/notifications/applications/  
application-name/mpnsConf/application-env/application-version/*

### Example

[https://www.example.com/worklightadmin/management-apis/1.0/runtimes/myruntime/notifications/applications/myapplication/mpnsConf/android/1.0/?locale=de\\_DE](https://www.example.com/worklightadmin/management-apis/1.0/runtimes/myruntime/notifications/applications/myapplication/mpnsConf/android/1.0/?locale=de_DE)

### Path Parameters

#### **runtime-name**

The name of the runtime. This is the context root of the runtime web application, without the leading slash.

#### **application-name**

The name of the application.

#### **application-env**

The application environment.

#### **application-version**

The application version number.

### Query Parameters

Query parameters are optional.

#### **locale**

The locale used for error messages.

### Consumes

application/json

### Produces

application/json, application/xml, text/xml



## Payload

The payload in JSON format has values for `keyAlias`, `keyAliasPassword`, and `serviceName`.

### JSON Example

```
{
  "authenticated" : true,
  "keyAlias" : "aliasName",
  "keyAliasPassword" : "password",
  "serviceName" : "wl.ibm.push",
}
```

## Payload Properties

The payload has the following properties:

### **authenticated**

Returns whether the push configuration is authenticated.

### **keyAlias**

The alias is used to access the keystore that is specified in the `worklight.properties` file.

### **keyAliasPassword**

The password for your key alias.

### **serviceName**

The common name (CN) found in the MPNS certificate's Subject value.

## Response

The status of set MPNS credentials.

### JSON Example

```
{
  "productVersion" : {
    "productVersion" : "7.0.0",
  },
  "project" : {
    "name" : "PushNotifications",
  },
  "status" : "Success",
  "type" : "SET_MPNS_CREDENTIALS",
}
```

### XML Example

```
<?xml version="1.0" encoding="UTF-8"?>
<setMPNScredentialsStatus
  status="Success"
  type="SET_MPNS_CREDENTIALS">
  <productVersion productVersion="7.0.0"/>
  <project name="PushNotifications"/>
</setMPNScredentialsStatus>
```

## Response Properties

The response has the following properties:

### **productVersion**

The exact product version.

**project**

Project name.

**status**

The MPNS credentials are saved successfully.

**type**

Transaction type.

The *productVersion* has the following properties:

**productVersion**

The exact product version

The *project* has the following properties:

**name**

Name of the project

**Errors**

403

The user is not authorized to call this service.

404

The corresponding runtime is not found or not running.

500

An internal error occurred.

## Push Device Registration (DELETE)

Deletes the device with the device ID and application ID.

**Roles**

Users in the following roles are authorized to perform this operation:

- **worklightadmin**
- **worklightdeployer**
- **worklightmonitor**
- **worklightoperator**

**Method**

DELETE

**Path**

*/management-apis/1.0/runtimes/runtime-name/notifications/applications/application-name/devices/device-id*

**Example**

[https://www.example.com/worklightadmin/management-apis/1.0/runtimes/myruntime/notifications/applications/myapplication/devices/12345-6789?locale=de\\_DE](https://www.example.com/worklightadmin/management-apis/1.0/runtimes/myruntime/notifications/applications/myapplication/devices/12345-6789?locale=de_DE)

## Path Parameters

### **runtime-name**

The name of the runtime. This is the context root of the runtime web application, without the leading slash.

### **application-name**

The name of the application.

### **device-id**

The device id.

## Query Parameters

Query parameters are optional.

### **locale**

The locale used for error messages.

## Produces

application/json, application/xml, text/xml

## Response

Deletes the device with the device ID and application ID.

## JSON Example

```
{
  "productVersion" : {
    "productVersion" : "7.0.0",
  },
  "project" : {
    "name" : "PushNotifications",
  },
  "status" : "Success",
  "type" : "REMOVE_DEVICE",
}
```

## XML Example

```
<?xml version="1.0" encoding="UTF-8"?>
<deleteDevice
  status="Success"
  type="REMOVE_DEVICE">
  <productVersion productVersion="7.0.0"/>
  <project name="PushNotifications"/>
</deleteDevice>
```

## Response Properties

The response has the following properties:

### **productVersion**

The exact product version.

### **project**

Project name.

### **status**

The device is deleted successfully.

**type**

Transaction type.

The *productVersion* has the following properties:

**productVersion**

The exact product version

The *project* has the following properties:

**name**

Name of the project

**Errors**

403

The user is not authorized to call this service.

404

The corresponding runtime is not found or not running.

500

An internal error occurred.

## Push Device Registration (GET)

Retrieves metadata of the device with the given device ID.

**Roles**

Users in the following roles are authorized to perform this operation:

- **worklightadmin**
- **worklightdeployer**
- **worklightmonitor**
- **worklightoperator**

**Method**

GET

**Path**

*/management-apis/1.0/runtimes/runtime-name/notifications/applications/application-name/devices/device-id*

**Example**

[https://www.example.com/worklightadmin/management-apis/1.0/runtimes/myruntime/notifications/applications/myapplication/devices/12345-6789?locale=de\\_DE](https://www.example.com/worklightadmin/management-apis/1.0/runtimes/myruntime/notifications/applications/myapplication/devices/12345-6789?locale=de_DE)

**Path Parameters****runtime-name**

The name of the runtime. This is the context root of the runtime web application, without the leading slash.

**application-name**

The name of the application.

**device-id**

The device id.

**Query Parameters**

Query parameters are optional.

**locale**

The locale used for error messages.

**Produces**

application/json, application/xml, text/xml

**Response**

The metadata of the device with the given device ID.

**JSON Example**

```
{
  "deviceId" : "testdevice",
  "platform" : "G",
  "productVersion" : "7.0.0",
  "token" : "testtoken",
  "userId" : "worklight",
}
```

**XML Example**

```
<?xml version="1.0" encoding="UTF-8"?>
<devices
  deviceId="testdevice"
  platform="G"
  productVersion="7.0.0"
  token="testtoken"
  userId="worklight"/>
```

**Response Properties**

The response has the following properties:

**deviceId**

The unique id of the device.

**platform**

The device platform.

**productVersion**

The exact product version.

**token**

The unique push token of the device.

**userId**

The userId of the device.

**Errors**

403

The user is not authorized to call this service.

404

The corresponding runtime is not found or not running.

500

An internal error occurred.

## Push Device Subscription (DELETE)

Delete subscriptions of a combination of application, tag name, and device ID.

### Description

The subscriptions that are deleted are for a combination of application, tag name, and device ID.

### Roles

Users in the following roles are authorized to perform this operation:

- **worklightadmin**
- **worklightdeployer**
- **worklightmonitor**
- **worklightoperator**

### Method

DELETE

### Path

*/management-apis/1.0/runtimes/runtime-name/notifications/applications/application-name/subscriptions*

### Example

[https://www.example.com/worklightadmin/management-apis/1.0/runtimes/myruntime/notifications/applications/myapplication/subscriptions?deviceId=45ccfd8e-ca97-3e9a-ad47-16f87c9e395b&locale=de\\_DE&tag-Name=Gold](https://www.example.com/worklightadmin/management-apis/1.0/runtimes/myruntime/notifications/applications/myapplication/subscriptions?deviceId=45ccfd8e-ca97-3e9a-ad47-16f87c9e395b&locale=de_DE&tag-Name=Gold)

### Path Parameters

#### **runtime-name**

The name of the runtime. This is the context root of the runtime web application, without the leading slash.

#### **application-name**

The name of the application.

### Query Parameters

Query parameters are optional.

#### **deviceId**

The unique deviceId of the device.

#### **locale**

The locale used for error messages.

#### **tag-Name**

The tag name.

## Produces

application/json, application/xml, text/xml

## Response

The status of delete subscriptions.

### JSON Example

```
{
  "productVersion" : {
    "productVersion" : "7.0.0",
  },
  "project" : {
    "name" : "PushNotifications",
  },
  "status" : "Success",
  "type" : "DELETE_SUBSCRIPTIONS",
}
```

### XML Example

```
<?xml version="1.0" encoding="UTF-8"?>
<deleteSubscriptionsStatus
  status="Success"
  type="DELETE_SUBSCRIPTIONS">
  <productVersion productVersion="7.0.0"/>
  <project name="PushNotifications"/>
</deleteSubscriptionsStatus>
```

## Response Properties

The response has the following properties:

### **productVersion**

The exact product version.

### **project**

Project name.

### **status**

The subscription is deleted successfully.

### **type**

Transaction type.

The *productVersion* has the following properties:

### **productVersion**

The exact product version

The *project* has the following properties:

### **name**

Name of the project

## Errors

403

The user is not authorized to call this service.

404

The corresponding runtime is not found or not running.

500

An internal error occurred.

## Push Device Subscription (GET)

Retrieves metadata of the subscriptions.

### Description

The subscriptions can be obtained for application, for a particular tag, for a particular deviceId and a combination of application, tag name and deviceId

### Roles

Users in the following roles are authorized to perform this operation:

- **worklightadmin**
- **worklightdeployer**
- **worklightmonitor**
- **worklightoperator**

### Method

GET

### Path

*/management-apis/1.0/runtimes/runtime-name/notifications/applications/application-name/subscriptions*

### Example

[https://www.example.com/worklightadmin/management-apis/1.0/runtimes/myruntime/notifications/applications/myapplication/subscriptions?deviceId=testdevice&locale=de\\_DE&offset=1&size=6&tag-Name=testtag](https://www.example.com/worklightadmin/management-apis/1.0/runtimes/myruntime/notifications/applications/myapplication/subscriptions?deviceId=testdevice&locale=de_DE&offset=1&size=6&tag-Name=testtag)

### Path Parameters

#### **runtime-name**

The name of the runtime. This is the context root of the runtime web application, without the leading slash.

#### **application-name**

The name of the application.

### Query Parameters

Query parameters are optional.

#### **deviceId**

The unique id of the device.

#### **locale**

The locale used for error messages.

#### **offset**

The offset from the beginning of the list if only a part of the list (a page) should be returned.



**size**

The number of elements to be returned.

**tag-Name**

The name of the tag.

**Produces**

application/json, application/xml, text/xml

**Response**

The metadata of the subscriptions.

**JSON Example**

```
{
  "offset" : 1,
  "productVersion" : "7.0.0",
  "size" : 6,
  "subscriptions" : [
    {
      "deviceId" : "testdevice",
      "tag-Name" : "testtag",
    },
    ...
  ],
  "totalListSize" : 6,
}
```

**XML Example**

```
<?xml version="1.0" encoding="UTF-8"?>
<pushDevicesubscription
  offset="1"
  productVersion="7.0.0"
  size="6"
  totalListSize="6">
  <subscriptions>
    <subscription
      deviceId="testdevice"
      tag-Name="testtag"/>
    ...
  </subscriptions>
</pushDevicesubscription>
```

**Response Properties**

The response has the following properties:

**offset**

The offset from the beginning of the list if only a part of the list (a page) should be returned.

**productVersion**

The exact product version.

**size**

The number of elements to be returned.

**subscriptions**

The array of subscription metadata

**totalListSize**

The total number of subscriptions.

The *pushDevicesubscription* has the following properties:

**deviceId**

The unique id of the device.

**tag-Name**

The name of the tag.

**Errors**

403

The user is not authorized to call this service.

404

The corresponding runtime is not found or not running.

500

An internal error occurred.

## Push Devices Registration (GET)

Retrieves metadata for the list of devices of an application.

**Roles**

Users in the following roles are authorized to perform this operation:

- **worklightadmin**
- **worklightdeployer**
- **worklightmonitor**
- **worklightoperator**

**Method**

GET

**Path**

*/management-apis/1.0/runtimes/runtime-name/notifications/applications/application-name/devices*

**Example**

[https://www.example.com/worklightadmin/management-apis/1.0/runtimes/myruntime/notifications/applications/myapplication/devices?locale=de\\_DE&offset=1&size=6](https://www.example.com/worklightadmin/management-apis/1.0/runtimes/myruntime/notifications/applications/myapplication/devices?locale=de_DE&offset=1&size=6)

**Path Parameters**

**runtime-name**

The name of the runtime. This is the context root of the runtime web application, without the leading slash.

**application-name**

The name of the application.

**Query Parameters**

Query parameters are optional.

**locale**

The locale used for error messages.

**offset**

The offset from the beginning of the list if only a part of the list (a page) should be returned.

**size**

The number of elements to be returned.

**Produces**

application/json, application/xml, text/xml

**Response**

The metadata of the devices of an application.

**JSON Example**

```
{
  "devices" : [
    {
      "deviceId" : "testdevice",
      "platform" : "G",
      "token" : "testtoken",
      "userId" : "worklight",
    },
    ...
  ],
  "offset" : 1,
  "productVersion" : "7.0.0",
  "size" : 6,
  "totalListSize" : 6,
}
```

**XML Example**

```
<?xml version="1.0" encoding="UTF-8"?>
<devices
  offset="1"
  productVersion="7.0.0"
  size="6"
  totalListSize="6">
  <devices>
    <device
      deviceId="testdevice"
      platform="G"
      token="testtoken"
      userId="worklight"/>
    ...
  </devices>
</devices>
```

**Response Properties**

The response has the following properties:

**devices**

The array of device metadata

**offset**

The offset from the beginning of the list if only a part of the list (a page) should be returned.

**productVersion**

The exact product version.

**size**

The number of elements to be returned.

**totalListSize**

The total number of devices.

The *pushDeviceRegistration* has the following properties:

**deviceId**

The unique id of the device.

**platform**

The device platform.

**token**

The unique push token of the device.

**userId**

The userId of the device.

**Errors**

403

The user is not authorized to call this service.

404

The corresponding runtime is not found or not running.

500

An internal error occurred.

## Push Enabled Applications (GET)

Retrieves metadata for the list of deployed push enabled applications.

**Roles**

Users in the following roles are authorized to perform this operation:

- **worklightadmin**
- **worklightdeployer**
- **worklightmonitor**
- **worklightoperator**

**Method**

GET

**Path**

*/management-apis/1.0/runtimes/runtime-name/notifications/applications*

**Example**

[https://www.example.com/worklightadmin/management-apis/1.0/runtimes/myruntime/notifications/applications?locale=de\\_DE](https://www.example.com/worklightadmin/management-apis/1.0/runtimes/myruntime/notifications/applications?locale=de_DE)

## Path Parameters

### runtime-name

The name of the runtime. This is the context root of the runtime web application, without the leading slash.

## Query Parameters

Query parameters are optional.

### locale

The locale used for error messages.

## Produces

application/json, application/xml, text/xml

## Response

The metadata of the deployed push enabled applications.

## JSON Example

```
{
  "applications" : [
    {
      "applicationEnvironments" : [
        {
          "deviceCount" : 1,
          "mediatorType" : "Google",
          "numberOfMessagesSent" : 1,
          "userCount" : 1,
        },
        ...
      ],
      "deviceCount" : 1,
      "displayName" : "SampleApplication",
      "userCount" : 1,
    },
    ...
  ],
  "productVersion" : "7.0.0",
}
```

## XML Example

```
<?xml version="1.0" encoding="UTF-8"?>
<pushnotification productVersion="7.0.0">
  <applications>
    <application
      deviceCount="1"
      displayName="SampleApplication"
      userCount="1">
      <applicationEnvironments>
        <applicationEnvironment
          deviceCount="1"
          mediatorType="Google"
          numberOfMessagesSent="1"
          userCount="1"/>
        ...
      </applicationEnvironments>
    </application>
    ...
  </applications>
</pushnotification>
```

## Response Properties

The response has the following properties:

### **applications**

The array of push enabled application metadata

### **productVersion**

The exact product version.

The *application* has the following properties:

### **applicationEnvironments**

The array of application environments.

### **deviceCount**

Number of subscribed devices of this application.

### **displayName**

The name of the application.

### **userCount**

Number of subscribed users of this application.

The *applicationEnvironment* has the following properties:

### **deviceCount**

Number of subscribed devices of this application environment.

### **mediatorType**

The name of the application environment.

### **numberOfMessagesSent**

Number of messages sent for this application environment.

### **userCount**

Number of subscribed users of this application environment.

## Errors

403

The user is not authorized to call this service.

404

The corresponding runtime is not found or not running.

500

An internal error occurred.

## Push Tags (DELETE)

Deletes tag of the application with the application ID and tag.

## Roles

Users in the following roles are authorized to perform this operation:

- **worklightadmin**
- **worklightdeployer**
- **worklightmonitor**
- **worklightoperator**

## Method

DELETE

## Path

*/management-apis/1.0/runtimes/runtime-name/notifications/applications/application-name/tags/tag-name*

## Example

[https://www.example.com/worklightadmin/management-apis/1.0/runtimes/myruntime/notifications/applications/myapplication/tags/mytag?locale=de\\_DE](https://www.example.com/worklightadmin/management-apis/1.0/runtimes/myruntime/notifications/applications/myapplication/tags/mytag?locale=de_DE)

## Path Parameters

### **runtime-name**

The name of the runtime. This is the context root of the runtime web application, without the leading slash.

### **application-name**

The name of the application.

### **tag-name**

The name of the tag.

## Query Parameters

Query parameters are optional.

### **locale**

The locale used for error messages.

## Produces

application/json, application/xml, text/xml

## Response

The delete status of delete tag.

## JSON Example

```
{
  "productVersion" : {
    "productVersion" : "7.0.0",
  },
  "project" : {
    "name" : "PushNotifications",
  },
  "status" : "Success",
  "type" : "DELETE_TAGS",
}
```

## XML Example

```
<?xml version="1.0" encoding="UTF-8"?>
<deleteTagStatus
  status="Success"
  type="DELETE_TAGS">
  <productVersion productVersion="7.0.0"/>
  <project name="PushNotifications"/>
</deleteTagStatus>
```

## Response Properties

The response has the following properties:

**productVersion**

The exact product version.

**project**

Project name.

**status**

The tags are deleted successfully.

**type**

Transaction type.

The *productVersion* has the following properties:

**productVersion**

The exact product version

The *project* has the following properties:

**name**

Name of the project

## Errors

403

The user is not authorized to call this service.

404

The corresponding runtime is not found or not running.

500

An internal error occurred.

## Push Tags (GET)

Retrieves tags of the application with the application ID.

### Roles

Users in the following roles are authorized to perform this operation:

- **worklightadmin**
- **worklightdeployer**
- **worklightmonitor**
- **worklightoperator**

### Method

GET

### Path

*/management-apis/1.0/runtimes/runtime-name/notifications/applications/application-name/tags*



## Example

[https://www.example.com/worklightadmin/management-apis/1.0/runtimes/myruntime/notifications/applications/myapplication/tags?locale=de\\_DE](https://www.example.com/worklightadmin/management-apis/1.0/runtimes/myruntime/notifications/applications/myapplication/tags?locale=de_DE)

## Path Parameters

### **runtime-name**

The name of the runtime. This is the context root of the runtime web application, without the leading slash.

### **application-name**

The name of the application.

## Query Parameters

Query parameters are optional.

### **locale**

The locale used for error messages.

## Produces

application/json, application/xml, text/xml

## Response

The Tags of the application with details such as description, name, and product version.

## JSON Example

```
{
  "description" : "This is a Gold tag.",
  "name" : "Gold",
  "productVersion" : "7.0.0",
}
```

## XML Example

```
<?xml version="1.0" encoding="UTF-8"?>
<tags
  description="This is a Gold tag."
  name="Gold"
  productVersion="7.0.0"/>
```

## Response Properties

The response has the following properties:

### **description**

The description of the Tag.

### **name**

The name of the Tag.

### **productVersion**

The exact product version.

## Errors

403

The user is not authorized to call this service.

404

The corresponding runtime is not found or not running.

500

An internal error occurred.

## Push Tags (POST)

Create Tags of the application with the application ID.

### Roles

Users in the following roles are authorized to perform this operation:

- **worklightadmin**
- **worklightdeployer**
- **worklightmonitor**
- **worklightoperator**

### Method

POST

### Path

*/management-apis/1.0/runtimes/runtime-name/notifications/applications/application-name/tags*

### Example

[https://www.example.com/worklightadmin/management-apis/1.0/runtimes/myruntime/notifications/applications/myapplication/tags?locale=de\\_DE](https://www.example.com/worklightadmin/management-apis/1.0/runtimes/myruntime/notifications/applications/myapplication/tags?locale=de_DE)

### Path Parameters

#### **runtime-name**

The name of the runtime. This is the context root of the runtime web application, without the leading slash.

#### **application-name**

The name of the application.

### Query Parameters

Query parameters are optional.

#### **locale**

The locale used for error messages.

### Consumes

application/json

### Produces

application/json, application/xml, text/xml

## Payload

The payload in JSON format has values for name and description.

### JSON Example

```
{
  "description" : "This is a Gold tag.",
  "name" : "Gold",
}
```

### Payload Properties

The payload has the following properties:

#### **description**

The description of the tag.

#### **name**

The name of the tag.

## Response

The status of create tags.

### JSON Example

```
{
  "productVersion" : {
    "productVersion" : "7.0.0",
  },
  "project" : {
    "name" : "PushNotifications",
  },
  "status" : "Success",
  "type" : "CREATE_TAGS",
}
```

### XML Example

```
<?xml version="1.0" encoding="UTF-8"?>
<createTagsStatus
  status="Success"
  type="CREATE_TAGS">
  <productVersion productVersion="7.0.0"/>
  <project name="PushNotifications"/>
</createTagsStatus>
```

### Response Properties

The response has the following properties:

#### **productVersion**

The exact product version.

#### **project**

Project name.

#### **status**

The tags are created successfully.

#### **type**

Transaction type.

The *productVersion* has the following properties:

**productVersion**

The exact product version

The *project* has the following properties:

**name**

Name of the project

**Errors**

403

The user is not authorized to call this service.

404

The corresponding runtime is not found or not running.

500

An internal error occurred.

## Push Tags (PUT)

Update Tags of the application with the application ID and tag.

### Roles

Users in the following roles are authorized to perform this operation:

- **worklightadmin**
- **worklightdeployer**
- **worklightmonitor**
- **worklightoperator**

### Method

PUT

### Path

*/management-apis/1.0/runtimes/runtime-name/notifications/applications/application-name/tags/tag-name*

### Example

[https://www.example.com/worklightadmin/management-apis/1.0/runtimes/myruntime/notifications/applications/myapplication/tags/mytag?locale=de\\_DE](https://www.example.com/worklightadmin/management-apis/1.0/runtimes/myruntime/notifications/applications/myapplication/tags/mytag?locale=de_DE)

### Path Parameters

**runtime-name**

The name of the runtime. This is the context root of the runtime web application, without the leading slash.

**application-name**

The name of the application.

**tag-name**

The name of the tag.

## Query Parameters

Query parameters are optional.

### locale

The locale used for error messages.

## Consumes

application/json

## Produces

application/json, application/xml, text/xml

## Payload

The payload in JSON format has values for name and description. The tag description is updated based on the given tag name.

## JSON Example

```
{
  "description" : "This is modified description of the Gold tag.",
  "name" : "Gold",
}
```

## Payload Properties

The payload has the following properties:

### description

The description of the tag.

### name

The name of the tag.

## Response

The status of update tags.

## JSON Example

```
{
  "productVersion" : {
    "productVersion" : "7.0.0",
  },
  "project" : {
    "name" : "PushNotifications",
  },
  "status" : "Success",
  "type" : "UPDATE_TAGS",
}
```

## XML Example

```
<?xml version="1.0" encoding="UTF-8"?>
<updateTagsStatus
  status="Success"
  type="UPDATE_TAGS">
  <productVersion productVersion="7.0.0"/>
  <project name="PushNotifications"/>
</updateTagsStatus>
```

## Response Properties

The response has the following properties:

**productVersion**

The exact product version.

**project**

Project name.

**status**

The tags are updated successfully.

**type**

Transaction type.

The *productVersion* has the following properties:

**productVersion**

The exact product version

The *project* has the following properties:

**name**

Name of the project

## Errors

403

The user is not authorized to call this service.

404

The corresponding runtime is not found or not running.

500

An internal error occurred.

## Runtime (DELETE)

Deletes a specific runtime.

### Description

The purpose of this API is to allow to cleanup the database. You can delete a runtime only when it is stopped. A runtime that is currently active cannot be deleted.

### Roles

Users in the following roles are authorized to perform this operation:

- **worklightadmin**

### Method

DELETE

### Path

*/management-apis/1.0/runtimes/runtime-name*

## Example

[https://www.example.com/worklightadmin/management-apis/1.0/runtimes/myruntime?locale=de\\_DE&mode=empty](https://www.example.com/worklightadmin/management-apis/1.0/runtimes/myruntime?locale=de_DE&mode=empty)

## Path Parameters

### **runtime-name**

The name of the runtime. This is the context root of the runtime web application, without the leading slash.

## Query Parameters

Query parameters are optional.

### **locale**

The locale used for error messages.

### **mode**

Whether to delete the runtime only if it has no applications or adapters. Possible values are `empty` (delete only when empty) and `always` (delete even when not empty, the default).

## Produces

application/json, application/xml, text/xml

## Errors

403

The user is not authorized to call this service.

409

The corresponding runtime cannot be deleted. Possible reasons:  
It is still running, hence you must stop the runtime first.  
It is not empty but you passed the mode `empty` to delete only an empty runtime.

500

An internal error occurred.

## Runtime (GET)

Retrieves metadata for a specific runtime.

## Roles

Users in the following roles are authorized to perform this operation:

- `worklightadmin`
- `worklightdeployer`
- `worklightmonitor`
- `worklightoperator`

## Method

GET

## Path

/management-apis/1.0/runtimes/*runtime-name*

## Example

[https://www.example.com/worklightadmin/management-apis/1.0/runtimes/myruntime?expand=true&locale=de\\_DE](https://www.example.com/worklightadmin/management-apis/1.0/runtimes/myruntime?expand=true&locale=de_DE)

## Path Parameters

### **runtime-name**

The name of the runtime. This is the context root of the runtime web application, without the leading slash.

## Query Parameters

Query parameters are optional.

### **expand**

Set to true to show details of the applications and adapters. The default is false

### **locale**

The locale used for error messages.

## Produces

application/json, application/xml, text/xml

## Response

The metadata for the runtime.

## JSON Example

```
{
  "adapters" : [
    {
      "deployTime" : "2014-04-13T00:18:36.979Z",
      "description" : "My first sample adapter",
      "link" : "https://www.example.com/worklightadmin/management-apis/1.0/runtimes/myruntime/adapters/myadapter",
      "name" : "myadapter",
      "platformVersion" : "6.1.0.00.20131126-0630",
      "procedures" : [ "getSomething", ... ],
      "projects" : [
        {
          "name" : "myproject",
        },
        ...
      ],
      "urls" : [
        {
          "formParameters" : [
            {
              "defaultValue" : "n/a",
              "javaType" : "java.lang.String",
              "name" : "param",
            },
            ...
          ],
          "javaClass" : "com.example.MyRestWrapper",
          "javaMethodName" : "multiplyNumbers",
        },
        ...
      ],
    }
  ],
}
```



```

        "method" : "POST",
        "pathParameters" : [
            {
                "defaultValue" : "n/a",
                "javaType" : "java.lang.String",
                "name" : "param",
            },
            ...
        ],
        "queryParameters" : [
            {
                "defaultValue" : "n/a",
                "javaType" : "java.lang.String",
                "name" : "param",
            },
            ...
        ],
        "uri" : "/multiply",
    },
    ...
],
},
...
],
"applications" : [
    {
        "description" : "My first sample application",
        "displayName" : "My Sample Application",
        "environments" : [
            {
                "applicationEnvironmentDataAccess" : {
                    "action" : "NOTIFY",
                    "createdTime" : "2014-04-13T00:18:36.979Z",
                    "message" : "This version is no longer supported.",
                },
                "authenticityConfig" : "BASIC",
                "buildTime" : "2014-03-29T00:18:36.979Z",
                "deployTime" : "2014-04-13T00:18:36.979Z",
                "deviceProvisioningRealm" : "myProvRealm",
                "envPlatformVersion" : "7.0.0",
                "environment" : "iphone",
                "link" : "https://www.example.com/worklightadmin/management-apis/1.0/runtimes/
myruntime/applications/myapplication/iphone/1.0",
                "prevBuildTime" : "2014-03-29T00:18:36.979Z",
                "securityTest" : "mobileTest",
                "supportRemoteDisable" : true,
                "supportsAuthenticity" : true,
                "userAuthenticationRealm" : "myAuthRealm",
                "version" : "1.0",
                "versionLocked" : false,
            },
            ...
        ],
        "link" : "https://www.example.com/worklightadmin/management-apis/1.0/runtimes/
myruntime/applications/myapplication",
        "name" : "myapplication",
        "platformVersion" : "6.1.0.00.20131126-0630",
        "projects" : [
            {
                "name" : "myproject",
            },
            ...
        ],
    },
    ...
],
},
...
],
"auditEnabled" : true,

```

```

"bitlyApiKey" : "",
"bitlyUsername" : "",
"name" : "myruntime",
"numberOfActiveDevices" : 100,
"numberOfDecommissionedDevices" : 5,
"platformVersion" : "6.1.0.00.20131126-0630",
"productVersion" : "7.0.0",
"running" : true,
"serverVersion" : "7.0.0",
"synchronizationStatus" : "ok",
"topology" : "STANDALONE",
}

```

## XML Example

```

<?xml version="1.0" encoding="UTF-8"?>
<runtime
  auditEnabled="true"
  bitlyApiKey=""
  bitlyUsername=""
  name="myruntime"
  numberOfActiveDevices="100"
  numberOfDecommissionedDevices="5"
  platformVersion="6.1.0.00.20131126-0630"
  productVersion="7.0.0"
  running="true"
  serverVersion="7.0.0"
  synchronizationStatus="ok"
  topology="STANDALONE">
  <adapters>
    <adapter
      deployTime="2014-04-13T00:18:36.979Z"
      description="My first sample adapter"
      link="https://www.example.com/worklightadmin/management-apis/1.0/runtimes/
myruntime/adapters/myadapter"
      name="myadapter"
      platformVersion="6.1.0.00.20131126-0630">
      <procedures>
        <procedure>getSomething</procedure>
        ...
      </procedures>
      <projects>
        <project name="myproject"/>
        ...
      </projects>
      <urls>
        <url
          javaClass="com.example.MyRestWrapper"
          javaMethodName="multiplyNumbers"
          method="POST"
          uri="/multiply">
          <formParameters>
            <formParameter
              defaultValue="n/a"
              javaType="java.lang.String"
              name="param"/>
            ...
          </formParameters>
          <pathParameters>
            <pathParameter
              defaultValue="n/a"
              javaType="java.lang.String"
              name="param"/>
            ...
          </pathParameters>
          <queryParameters>
            <queryParameter

```

```

        defaultValue="n/a"
        javaType="java.lang.String"
        name="param"/>
    ...
</queryParams>
</url>
...
</urls>
</adapter>
...
</adapters>
<applications>
  <application
    description="My first sample application"
    displayName="My Sample Application"
    link="https://www.example.com/worklightadmin/management-apis/1.0/runtimes/
myruntime/applications/myapplication"
    name="myapplication"
    platformVersion="6.1.0.00.20131126-0630">
    <environments>
      <environment
        authenticityConfig="BASIC"
        buildTime="2014-03-29T00:18:36.979Z"
        deployTime="2014-04-13T00:18:36.979Z"
        deviceProvisioningRealm="myProvRealm"
        envPlatformVersion="7.0.0"
        environment="iphone"
        link="https://www.example.com/worklightadmin/management-apis/1.0/runtimes/
myruntime/applications/myapplication/iphone/1.0"
        prevBuildTime="2014-03-29T00:18:36.979Z"
        securityTest="mobileTest"
        supportRemoteDisable="true"
        supportsAuthenticity="true"
        userAuthenticationRealm="myAuthRealm"
        version="1.0"
        versionLocked="false">
      <applicationEnvironmentDataAccess
        action="NOTIFY"
        createTime="2014-04-13T00:18:36.979Z"
        message="This version is no longer supported."/>
      </environment>
    ...
  </environments>
  <projects>
    <project name="myproject"/>
    ...
  </projects>
</application>
...
</applications>
</runtime>

```

## Response Properties

The response has the following properties:

### **adapters**

The array of adapters (shown only with `expand=true`).

### **applications**

The array of applications (shown only with `expand=true`).

### **auditEnabled**

Whether audit is enabled.

**bitlyApiKey**

The key for the Bitly service.

**bitlyUsername**

The user name for the Bitly service.

**name**

The name of the runtime. This is the context root of the runtime web application, without the leading slash.

**numberOfActiveDevices**

The number of active devices using this runtime.

**numberOfAdapters**

The number of adapters deployed in this runtime (shown only with `expand=false`).

**numberOfApplications**

The number of applications deployed in this runtime (shown only with `expand=false`).

**numberOfDecommissionedDevices**

The number of devices decommissioned for this runtime.

**platformVersion**

The exact version number of the IBM MobileFirst Platform Foundation development tools (Studio) that built the project WAR file.

**productVersion**

The exact product version.

**running**

Whether the runtime is currently active or has stopped.

**serverVersion**

The exact IBM MobileFirst Platform Server version number from which `worklight-jee-library.jar` is taken.

**synchronizationStatus**

The status of the nodes of the runtime. Can contain the values "ok" if all nodes of the runtime are running without error, "synchronizing" if some node is in progress of synchronizing, or an error message if some nodes failed to synchronize.

**topology**

Server topology. Can contain the values "STANDALONE", "CLUSTER" or "FARM"

The *adapter* has the following properties:

**deployTime**

The date in ISO 8601 format when the adapter was deployed.

**description**

The description of the adapter.

**link**

The URL to access detail information about the adapter.

**name**

The name of the adapter.

**platformVersion**

The exact version number of the IBM MobileFirst Platform Foundation development tools (Studio) that built the adapter.

**procedures**

The JavaScript procedures of the adapter.

**projects**

The projects the adapter belong to.

**urls**

The API documentation of the URLs of the REST API provided by the adapter.

The *project* has the following properties:

**name**

The name of the project, which is the context root of the runtime.

The *url* has the following properties:

**formParameters**

The form parameters.

**javaClass**

The Java class

**javaMethodName**

The Java method

**method**

The HTTP method.

**pathParameters**

The path parameters.

**queryParameters**

The query parameters.

**uri**

The URI of the REST API.

The *REST API parameter* has the following properties:

**defaultValue**

The default value.

**javaType**

The Java type name.

**name**

The name of the parameter.

The *application* has the following properties:

**description**

The description of the application.

**displayName**

The display name of the application.

**environments**

The array of application environments.

**link**

The URL to access detail information about the application.

**name**

The name of the application.

**platformVersion**

The exact version number of the IBM MobileFirst Platform Foundation development tools (Studio) that built the application.

**projects**

The projects the application belong to.

The *environment* has the following properties:

**applicationEnvironmentDataAccess**

The access rule to be executed when the app version is disabled.

**authenticityConfig**

The application authenticity configuration. Possible values are: NONE, BASIC, EXTENDED.

**buildTime**

The time stamp when the app version was built.

**deployTime**

The date in ISO 8601 format when the application was deployed.

**deviceProvisioningRealm**

The name of the realm used for device provisioning.

**envPlatformVersion**

The version of the platform of the environment.

**environment**

The platform environment of the app version: iphone.

**link**

The URL to access detail information about the application version.

**prevBuildTime**

The time stamp when the app that was previously deployed was built.

**publishUrl**

For web applications, this is the URL under which the web application was published.

**securityTest**

The name of the security test for a protected resource.

**supportRemoteDisable**

true if the application version supports remote disabling.

**supportsAuthenticity**

true if the application version supports authentication.

**userAuthenticationRealm**

The name of the realm used to authenticate users.

**version**

The version number of the app version.

**versionLocked**

Whether the version is locked.

The *applicationEnvironmentDataAccess* has the following properties:

**action**

The action to be done when a disabled app version is accessed. Possible values are: NOTIFY, BLOCK, NA.

**createdTime**

The date in ISO 8601 format when the app version access rule was created.

**downloadLink**

The download link where to obtain a new version of the application.

**message**

The message to be displayed when a disabled app version is accessed.

**multiLanguageMessage**

Internationalized variants of the message to be displayed when a disabled app version is accessed.

**Errors**

403

The user is not authorized to call this service.

404

The corresponding runtime is not found.

500

An internal error occurred.

## Runtime Lock (DELETE)

Forces the release of the transaction lock of a runtime.

### Description

This API should not be used in normal operations.

Transactions are performed sequentially. Hence each transaction such as deploying an application or adapter takes the runtime lock. The next transaction waits until the lock is released. After a serious crash, it may happen that the lock is still taken even though the corresponding transaction crashed. The lock will get automatically released after 30 minutes. However, with this API, you can force the release of the lock earlier.

Forcing the release of the lock when a transaction is currently active may corrupt the system. You should use this API only when you are sure that no transaction is currently active.

### Roles

Users in the following roles are authorized to perform this operation:

- **worklightadmin**

### Method

DELETE

## Path

/management-apis/1.0/runtimes/*runtime-name*/lock

## Example

[https://www.example.com/worklightadmin/management-apis/1.0/runtimes/myruntime/lock?locale=de\\_DE](https://www.example.com/worklightadmin/management-apis/1.0/runtimes/myruntime/lock?locale=de_DE)

## Path Parameters

### **runtime-name**

The name of the runtime. This is the context root of the runtime web application, without the leading slash.

## Query Parameters

Query parameters are optional.

### **locale**

The locale used for error messages.

## Produces

application/json, application/xml, text/xml

## Response

### JSON Example

```
{
  "busy" : false,
}
```

### XML Example

```
<?xml version="1.0" encoding="UTF-8"?>
<lock busy="false"/>
```

## Response Properties

The response has the following properties:

### **busy**

Whether the runtime is still busy with a transaction after forcing the release of the lock.

## Errors

403

The user is not authorized to call this service.

500

An internal error occurred.

## Runtime Lock (GET)

Retrieves information about the transaction lock of a runtime.



## Description

Transactions are performed sequentially. Hence each transaction such as deploying an application or adapter takes the runtime lock. The next transaction waits until the lock is released. This API allowed to retrieve whether a runtime is currently busy with a transaction.

## Roles

Users in the following roles are authorized to perform this operation:

- **worklightadmin**
- **worklightdeployer**
- **worklightmonitor**
- **worklightoperator**

## Method

GET

## Path

*/management-apis/1.0/runtimes/runtime-name/lock*

## Example

[https://www.example.com/worklightadmin/management-apis/1.0/runtimes/myruntime/lock?locale=de\\_DE](https://www.example.com/worklightadmin/management-apis/1.0/runtimes/myruntime/lock?locale=de_DE)

## Path Parameters

### **runtime-name**

The name of the runtime. This is the context root of the runtime web application, without the leading slash.

## Query Parameters

Query parameters are optional.

### **locale**

The locale used for error messages.

## Produces

application/json, application/xml, text/xml

## Response

### JSON Example

```
{
  "busy" : true,
}
```

### XML Example

```
<?xml version="1.0" encoding="UTF-8"?>
<lock busy="true"/>
```

## Response Properties

The response has the following properties:

### **busy**

Whether the runtime is currently busy with a transaction.

## Errors

403

The user is not authorized to call this service.

500

An internal error occurred.

## Runtimes (GET)

Retrieves metadata for the list of runtimes.

## Roles

Users in the following roles are authorized to perform this operation:

- **worklightadmin**
- **worklightdeployer**
- **worklightmonitor**
- **worklightoperator**

## Method

GET

## Path

/management-apis/1.0/runtimes

## Example

[https://www.example.com/worklightadmin/management-apis/1.0/runtimes?fullInfo=true&locale=de\\_DE&mode=db](https://www.example.com/worklightadmin/management-apis/1.0/runtimes?fullInfo=true&locale=de_DE&mode=db)

## Query Parameters

Query parameters are optional.

### **fullInfo**

The default value `false` returns basic list of properties of a runtime, while the value `true` returns all properties of this runtime (see a GET on a single runtime for the complete list of properties).

### **locale**

The locale used for error messages.

### **mode**

The default mode `running` retrieves only the running runtimes, while the mode `db` retrieves also the runtimes stored in the database that might not be running.

## Produces

application/json, application/xml, text/xml

## Response

The metadata for the list of runtimes.

## JSON Example

```
{
  "productVersion" : "7.0.0",
  "projects" : [
    {
      "auditEnabled" : true,
      "link" : "https://www.example.com/worklightadmin/
management-apis/1.0/runtimes/myruntime",
      "name" : "myruntime",
      "numberOfActiveDevices" : 100,
      "numberOfAdapters" : 1,
      "numberOfApplications" : 1,
      "numberOfDecommissionedDevices" : 5,
      "running" : true,
      "synchronizationStatus" : "ok",
      "topology" : "STANDALONE",
    },
    ...
  ],
}
```

## XML Example

```
<?xml version="1.0" encoding="UTF-8"?>
<projectconfiguration productVersion="7.0.0">
  <projects>
    <project
      auditEnabled="true"
      link="https://www.example.com/worklightadmin/
management-apis/1.0/runtimes/myruntime"
      name="myruntime"
      numberOfActiveDevices="100"
      numberOfAdapters="1"
      numberOfApplications="1"
      numberOfDecommissionedDevices="5"
      running="true"
      synchronizationStatus="ok"
      topology="STANDALONE"/>
    ...
  </projects>
</projectconfiguration>
```

## Response Properties

The response has the following properties:

### **productVersion**

The exact product version.

### **projects**

The array of runtimes.

The *runtime* has the following properties:

### **auditEnabled**

Whether audit is enabled.

**link**

The URL to access detail information about the runtime.

**name**

The name of the runtime. This is the context root of the runtime web application, without the leading slash.

**numberOfActiveDevices**

The number of active devices using this runtime.

**numberOfAdapters**

The number of adapters deployed in this runtime.

**numberOfApplications**

The number of applications deployed in this runtime.

**numberOfDecommissionedDevices**

The number of devices decommissioned for this runtime.

**running**

Whether the runtime is currently active or has stopped.

**synchronizationStatus**

The status of the nodes of the runtime. Can contain the values "ok" if all nodes of the runtime are running without error, "synchronizing" if some node is in progress of synchronizing, or an error message if some nodes failed to synchronize.

**topology**

Server topology. Can contain the values "STANDALONE", "CLUSTER" or "FARM"

**Errors**

403

The user is not authorized to call this service.

500

An internal error occurred.

**Send Bulk Messages (POST)**

Send bulk messages with different options to be specified.

**Roles**

Users in the following roles are authorized to perform this operation:

- **worklightadmin**
- **worklightdeployer**
- **worklightmonitor**
- **worklightoperator**

**Method**

POST

## Path

*/management-apis/1.0/runtimes/runtime-name/notifications/applications/application-name/messages/bulk*

## Example

[https://www.example.com/worklightadmin/management-apis/1.0/runtimes/myruntime/notifications/applications/myapplication/messages/bulk?locale=de\\_DE](https://www.example.com/worklightadmin/management-apis/1.0/runtimes/myruntime/notifications/applications/myapplication/messages/bulk?locale=de_DE)

## Path Parameters

### runtime-name

The name of the runtime. This is the context root of the runtime web application, without the leading slash.

### application-name

The name of the application.

## Query Parameters

Query parameters are optional.

### locale

The locale used for error messages.

## Consumes

application/json

## Produces

application/json, application/xml, text/xml

## Payload

The payload in JSON format has values for array of messages, target, and settings.

## JSON Example

```
{
  "//ArrayOfMessageBody" : [
    {
      "messages" : {
        "alert" : "Test message",
      },
      "settings" : {
        "apns" : {
          "badge" : 1,
          "iosActionKey" : "Ok",
          "payload" : "",
          "sound" : "song.mp3",
        },
        "gcm" : {
          "delayWhileIdle" : ,
          "payload" : "",
          "sound" : "song.mp3",
          "timeToLive" : ,
        },
        "mpns" : {
          "raw" : {
            "payload" : {
            },
          },
        },
      },
    }
  ],
}
```

```

    },
    "title" : {
      "backBackgroundImage" : "Blue.jpg",
      "backContent" : "Back Title Content",
      "backTitle" : "Back Title",
      "backgroundImage" : "Red.jpg",
      "count" : 1,
      "title" : "Push Notification",
    },
    "toast" : {
      "param" : "/Page2.xaml?NavigatedFrom=Toast Notification",
      "title" : "Hello",
    },
  },
},
},
"target" : {
  "consumerIds" : [ "MyConsumerId1", ... ],
  "deviceIds" : [ "MyDeviceId1", ... ],
  "platforms" : [ "A,G", ... ],
  "tagNames" : [ "Gold", ... ],
},
},
...
],
}

```

## Payload Properties

The payload has the following properties:

### //ArrayOfMessageBody

The array of message

The *bulk-messages* has the following properties:

### messages

The array of message

### settings

The settings are the different attributes of the notification.

### target

Set of targets can be consumer Ids, devices, platforms, or tags.

The *message* has the following properties:

### alert

A string to be displayed in the alert.

The *settings* has the following properties:

### apns

Attributes for sending message to an iOS device.

### mpns

Attributes for sending message to an MPNS device.

The *apns* has the following properties:

### badge

An integer value to be displayed in a badge on the application icon.

### iosActionKey

The label of the dialog box button that allows the user to open the app upon receiving the notification.

**payload**

A JSON block that is transferred to the application if the application is opened by the user when the notification is received, or if the application is already open.

**sound**

The name of a file to play when the notification arrives.

The *gcm* has the following properties:

**delayWhileIdle**

A Boolean value that indicates that the message must not be sent if the device is idle. The server waits for the device to become active before the message is sent.

**payload**

A JSON block that is transferred to the application if the application is opened by the user when the notification is received, or if the application is already open.

**sound**

The name of a file to play when the notification arrives.

**timeToLive**

The duration (in seconds) that the message is kept on GCM storage if the device is offline. Default value is 4 weeks, and must be set as a JSON number.

The *mpns* has the following properties:

**raw**

Raw.

**title**

Title.

**toast**

Toast.

The *raw* has the following properties:

**payload**

A JSON block that is transferred to the application if the application is opened by the user when the notification is received, or if the application is already open.

The *title* has the following properties:

**backBackgroundImage**

URL of the back image on a medium flip Tile.

**backContent**

Content that displays on the back of a medium flip Tile.

**backTitle**

Title that displays on the back of a flip Tile.

**backgroundImage**

URL of the front image on a medium flip Tile.

**count**

An integer value from 1 to 99. If the value of count is not set or it is set to 0, the circle image and value do not display in the Tile. This property is also known as badge.

**title**

A string that indicates the title of the application. The title fits on a single line of text and must not be wider than the Tile. Approximately 15 characters can fit in the title before it is truncated.

The *toast* has the following properties:

**param**

Toast notification content.

**title**

Toast notification title.

The *target* has the following properties:

**consumerIds**

The array of consumer Ids.

**deviceIds**

JSON array of the device ids. Devices with these ids receive the notification.

**platforms**

JSON array of platforms. Devices running on these platforms receive the notification. Supported values are A, G, and M.

**tagNames**

JSON array of tags. Devices that are subscribed to these tags receive the notification.

## Response

The status of send messages.

### JSON Example

```
{
  "productVersion" : {
    "productVersion" : "7.0.0",
  },
  "project" : {
    "name" : "PushNotifications",
  },
  "status" : "Success",
  "type" : "SET_PUSH_NOTIFICATION_ENABLED",
}
```

### XML Example

```
<?xml version="1.0" encoding="UTF-8"?>
<sendMessagesStatus
  status="Success"
  type="SET_PUSH_NOTIFICATION_ENABLED">
  <productVersion productVersion="7.0.0"/>
  <project name="PushNotifications"/>
</sendMessagesStatus>
```

## Response Properties

The response has the following properties:

**productVersion**

The exact product version.



**project**

Project name.

**status**

Message submitted for delivery.

**type**

Transaction type.

The *productVersion* has the following properties:

**productVersion**

The exact product version

The *project* has the following properties:

**name**

Name of the project

**Errors**

403

The user is not authorized to call this service.

404

The corresponding runtime is not found or not running.

500

An internal error occurred.

## Send Message (POST)

Send message with different options to be specified.

**Roles**

Users in the following roles are authorized to perform this operation:

- **worklightadmin**
- **worklightdeployer**
- **worklightmonitor**
- **worklightoperator**

**Method**

POST

**Path**

*/management-apis/1.0/runtimes/runtime-name/notifications/applications/application-name/messages*

**Example**

[https://www.example.com/worklightadmin/management-apis/1.0/runtimes/myruntime/notifications/applications/myapplication/messages?locale=de\\_DE](https://www.example.com/worklightadmin/management-apis/1.0/runtimes/myruntime/notifications/applications/myapplication/messages?locale=de_DE)

## Path Parameters

### **runtime-name**

The name of the runtime. This is the context root of the runtime web application, without the leading slash.

### **application-name**

The name of the application.

## Query Parameters

Query parameters are optional.

### **locale**

The locale used for error messages.

## Consumes

application/json

## Produces

application/json, application/xml, text/xml

## Payload

The payload in JSON format has values for message, target, and settings.

## JSON Example

```
{
  "message" : {
    "alert" : "Test message",
  },
  "settings" : {
    "apns" : {
      "badge" : 1,
      "iosActionKey" : "Ok",
      "payload" : "",
      "sound" : "song.mp3",
    },
    "gcm" : {
      "delayWhileIdle" : ,
      "payload" : "",
      "sound" : "song.mp3",
      "timeToLive" : ,
    },
    "mpns" : {
      "raw" : {
        "payload" : {
        },
      },
      "title" : {
        "backBackgroundImage" : "Blue.jpg",
        "backContent" : "Back Title Content",
        "backTitle" : "Back Title",
        "backgroundImage" : "Red.jpg",
        "count" : 1,
        "title" : "Push Notification",
      },
    },
    "toast" : {
      "param" : "/Page2.xml?NavigatedFrom=Toast Notification",
      "title" : "Hello",
    },
  },
}
```

```

    },
  },
  "target" : {
    "consumerIds" : [ "MyConsumerId1", ... ],
    "deviceIds" : [ "MyDeviceId1", ... ],
    "platforms" : [ "A,G", ... ],
    "tagNames" : [ "Gold", ... ],
  },
}

```

## Payload Properties

The payload has the following properties:

### **message**

The alert message to be sent

### **settings**

The settings are the different attributes of the notification.

### **target**

Set of targets can be consumer Ids, devices, platforms, or tags.

The *message* has the following properties:

### **alert**

A string to be displayed in the alert.

The *settings* has the following properties:

### **apns**

Attributes for sending message to an iOS device.

### **mpns**

Attributes for sending message to an MPNS device.

The *apns* has the following properties:

### **badge**

An integer value to be displayed in a badge on the application icon.

### **iosActionKey**

The label of the dialog box button that allows the user to open the app upon receiving the notification.

### **payload**

A JSON block that is transferred to the application if the application is opened by the user when the notification is received, or if the application is already open.

### **sound**

The name of a file to play when the notification arrives.

The *gcm* has the following properties:

### **delayWhileIdle**

A Boolean value that indicates that the message must not be sent if the device is idle. The server waits for the device to become active before the message is sent.

**payload**

A JSON block that is transferred to the application if the application is opened by the user when the notification is received, or if the application is already open.

**sound**

The name of a file to play when the notification arrives.

**timeToLive**

The duration (in seconds) that the message is kept on GCM storage if the device is offline. Default value is 4 weeks, and must be set as a JSON number.

The *mpns* has the following properties:

**raw**

Raw.

**title**

Title.

**toast**

Toast.

The *raw* has the following properties:

**payload**

A JSON block that is transferred to the application if the application is opened by the user when the notification is received, or if the application is already open.

The *title* has the following properties:

**backBackgroundImage**

URL of the back image on a medium flip Tile.

**backContent**

Content that displays on the back of a medium flip Tile.

**backTitle**

Title that displays on the back of a flip Tile.

**backgroundImage**

URL of the front image on a medium flip Tile.

**count**

An integer value from 1 to 99. If the value of count is not set or it is set to 0, the circle image and value do not display in the Tile. This property is also known as badge.

**title**

A string that indicates the title of the application. The title fits on a single line of text and must not be wider than the Tile. Approximately 15 characters can fit in the title before it is truncated.

The *toast* has the following properties:

**param**

Toast notification content.

**title**

Toast notification title.

The *target* has the following properties:

**consumerIds**

The array of consumer Ids.

**deviceIds**

JSON array of the device ids. Devices with these ids receive the notification.

**platforms**

JSON array of platforms. Devices running on these platforms receive the notification. Supported values are A, G, and M.

**tagNames**

JSON array of tags. Devices that are subscribed to these tags receive the notification.

**Response**

The status of send message.

**JSON Example**

```
{
  "productVersion" : {
    "productVersion" : "7.0.0",
  },
  "project" : {
    "name" : "PushNotifications",
  },
  "status" : "Success",
  "type" : "SET_PUSH_NOTIFICATION_ENABLED",
}
```

**XML Example**

```
<?xml version="1.0" encoding="UTF-8"?>
<sendMessageStatus
  status="Success"
  type="SET_PUSH_NOTIFICATION_ENABLED">
  <productVersion productVersion="7.0.0"/>
  <project name="PushNotifications"/>
</sendMessageStatus>
```

**Response Properties**

The response has the following properties:

**productVersion**

The exact product version.

**project**

Project name.

**status**

Message submitted for delivery.

**type**

Transaction type.

The *productVersion* has the following properties:

**productVersion**

The exact product version

The *project* has the following properties:

**name**  
Name of the project

## Errors

403  
The user is not authorized to call this service.

404  
The corresponding runtime is not found or not running.

500  
An internal error occurred.

## Transaction (GET)

Retrieves information of a specific transaction.

### Roles

Users in the following roles are authorized to perform this operation:

- **worklightadmin**
- **worklightdeployer**
- **worklightmonitor**
- **worklightoperator**

### Method

GET

### Path

*/management-apis/1.0/runtimes/runtime-name/transactions/transaction-id*

### Example

[https://www.example.com/worklightadmin/management-apis/1.0/runtimes/myruntime/transactions/1?locale=de\\_DE](https://www.example.com/worklightadmin/management-apis/1.0/runtimes/myruntime/transactions/1?locale=de_DE)

### Path Parameters

**runtime-name**  
The name of the runtime. This is the context root of the runtime web application, without the leading slash.

**transaction-id**  
The transaction id.

### Query Parameters

Query parameters are optional.

**locale**  
The locale used for error messages.

## Produces

application/json, application/xml, text/xml

## Response

The information of the specified transaction.

### JSON Example

```
{
  "appServerId" : "Tomcat",
  "description" : {
  },
  "errors" : [
    {
      "details" : "An internal error occured.",
    },
    ...
  ],
  "id" : 1,
  "productVersion" : "7.0.0",
  "project" : {
    "name" : "myproject",
  },
  "status" : "FAILURE",
  "timeCreated" : "2014-04-13T00:18:36.979Z",
  "timeUpdated" : "2014-04-14T00:18:36.979Z",
  "type" : "DELETE_ADAPTER",
  "userName" : "demouser",
}
```

### XML Example

```
<?xml version="1.0" encoding="UTF-8"?>
<transaction
  appServerId="Tomcat"
  id="1"
  productVersion="7.0.0"
  status="FAILURE"
  timeCreated="2014-04-13T00:18:36.979Z"
  timeUpdated="2014-04-14T00:18:36.979Z"
  type="DELETE_ADAPTER"
  userName="demouser">
  <description/>
  <errors>
    <error details="An internal error occured."/>
    ...
  </errors>
  <project name="myproject"/>
</transaction>
```

## Response Properties

The response has the following properties:

### **appServerId**

The id of the web application server.

### **description**

The details of the transaction, depending on the transaction type.

### **errors**

The errors occurred during the transaction.

**id** The id of the transaction.

**productVersion**

The exact product version.

**project**

The current project.

**status**

The state of the transaction: PENDING, PREPARING, COMMITTING, REJECTING, SUCCESS, FAILURE, CANCELED. Synchronous transactions can have the state SUCCESS and FAILURE. Asynchronous transactions can also have the other states.

**timeCreated**

The date in ISO 8601 format when the adapter was created.

**timeUpdated**

The date in ISO 8601 format when the adapter was updated.

**type**

The type of the transaction.

**userName**

The user that initiated the transaction.

The *error* has the following properties:

**details**

The main error message.

The *project* has the following properties:

**name**

The name of the project, which is the context root of the runtime.

**Errors**

403

The user is not authorized to call this service.

404

The corresponding runtime or the transaction is not found.

500

An internal error occurred.

**Transactions (GET)**

Retrieves information of failed transactions.

**Roles**

Users in the following roles are authorized to perform this operation:

- **worklightadmin**
- **worklightdeployer**
- **worklightmonitor**
- **worklightoperator**

**Method**

GET



## Path

/management-apis/1.0/runtimes/*runtime-name*/transactions/errors

## Example

[https://www.example.com/worklightadmin/management-apis/1.0/runtimes/myruntime/transactions/errors?locale=de\\_DE&offset=0&orderBy=created&pageSize=100](https://www.example.com/worklightadmin/management-apis/1.0/runtimes/myruntime/transactions/errors?locale=de_DE&offset=0&orderBy=created&pageSize=100)

## Path Parameters

### **runtime-name**

The name of the runtime. This is the context root of the runtime web application, without the leading slash.

## Query Parameters

Query parameters are optional.

### **locale**

The locale used for error messages.

### **offset**

The offset from the beginning of the list if only a part of the list (a page) should be returned.

### **orderBy**

The sort mode. By default, the elements are sorted in increasing order. If the sort mode starts with - (minus sign), the elements are sorted in decreasing order. Possible sort modes are: created, updated, type, status, user, server. The default sort mode is: created.

### **pageSize**

The number of elements if only a part of the list (a page) should be returned. The default value is 100.

## Produces

application/json, application/xml, text/xml, application/zip

## Response

The information of the transactions.

## JSON Example

```
{
  "items" : [
    {
      "appServerId" : "Tomcat",
      "description" : {
      },
      "errors" : [
        {
          "details" : "An internal error occurred.",
        },
        ...
      ],
      "id" : 1,
      "project" : {
        "name" : "myproject",
      },
      "status" : "FAILURE",
    }
  ]
}
```

```

        "timeCreated" : "2014-04-13T00:18:36.979Z",
        "timeUpdated" : "2014-04-14T00:18:36.979Z",
        "type" : "DELETE_ADAPTER",
        "userName" : "demouser",
    },
    ...
],
"pageSize" : 100,
"productVersion" : "7.0.0",
"startIndex" : 0,
"totalListSize" : 33,
}

```

## XML Example

```

<?xml version="1.0" encoding="UTF-8"?>
<transactions
  pageSize="100"
  productVersion="7.0.0"
  startIndex="0"
  totalListSize="33">
  <items>
    <item
      appServerId="Tomcat"
      id="1"
      status="FAILURE"
      timeCreated="2014-04-13T00:18:36.979Z"
      timeUpdated="2014-04-14T00:18:36.979Z"
      type="DELETE_ADAPTER"
      userName="demouser">
      <description/>
      <errors>
        <error details="An internal error occured."/>
        ...
      </errors>
      <project name="myproject"/>
    </item>
    ...
  </items>
</transactions>

```

## Response Properties

The response has the following properties:

### **items**

The array of transactions

### **pageSize**

The page size if only a page of transactions is returned.

### **productVersion**

The exact product version.

### **startIndex**

The start index in the total list if only a page of transactions is returned.

### **totalListSize**

The total number of transactions.

The *transaction* has the following properties:

### **appServerId**

The id of the web application server.

**description**

The details of the transaction, depending on the transaction type.

**errors**

The errors occurred during the transaction.

**id** The id of the transaction.

**project**

The current project.

**status**

The state of the transaction: PENDING, PREPARING, COMMITTING, REJECTING, SUCCESS, FAILURE, CANCELED. Synchronous transactions can have the state SUCCESS and FAILURE. Asynchronous transactions can also have the other states.

**timeCreated**

The date in ISO 8601 format when the adapter was created.

**timeUpdated**

The date in ISO 8601 format when the adapter was updated.

**type**

The type of the transaction.

**userName**

The user that initiated the transaction.

The *error* has the following properties:

**details**

The main error message.

The *project* has the following properties:

**name**

The name of the project, which is the context root of the runtime.

**Errors**

403

The user is not authorized to call this service.

404

The corresponding runtime is not found.

500

An internal error occurred.

**Unsubscribe SMS (POST)**

Unsubscribes the list of given phone numbers for SMS.

**Roles**

Users in the following roles are authorized to perform this operation:

- **worklightadmin**
- **worklightdeployer**

## Method

POST

## Path

/management-apis/1.0/runtimes/*runtime-name*/notifications/unsubscribeSMS

## Example

[https://www.example.com/worklightadmin/management-apis/1.0/runtimes/myruntime/notifications/unsubscribeSMS?locale=de\\_DE](https://www.example.com/worklightadmin/management-apis/1.0/runtimes/myruntime/notifications/unsubscribeSMS?locale=de_DE)

## Path Parameters

### **runtime-name**

The name of the runtime. This is the context root of the runtime web application, without the leading slash.

## Query Parameters

Query parameters are optional.

### **locale**

The locale used for error messages.

## Consumes

application/json

## Produces

application/json, application/xml, text/xml

## Payload

The payload with comma separated list of phone numbers.

## JSON Example

```
{
  "numbers" : "1234,5678",
}
```

## Payload Properties

The payload has the following properties:

### **numbers**

Comma separated list of phone numbers.

## Response

The response status of SMS unsubscription.

## JSON Example

```
{
  "failure" : "5678",
  "success" : "1234",
}
```

## XML Example

```
<?xml version="1.0" encoding="UTF-8"?>
<unsubscribeSMS
  failure="5678"
  success="1234"/>
```

## Response Properties

The response has the following properties:

### **failure**

Comma separated list of phone numbers which are not deleted.

### **success**

Comma separated list of phone numbers which are successfully deleted.

## Errors

403

The user is not authorized to call this service.

404

The corresponding runtime is not found or not running.

500

An internal error occurred.

## WNS Credentials (DELETE)

Deletes Windows Push Notification Services (WNS) credentials of the application with the application ID, environment, and version.

## Roles

Users in the following roles are authorized to perform this operation:

- **worklightadmin**
- **worklightdeployer**
- **worklightmonitor**
- **worklightoperator**

## Method

DELETE

## Path

*/management-apis/1.0/runtimes/runtime-name/notifications/applications/  
application-name/wnsConf/application-env/application-version/*

## Example

[https://www.example.com/worklightadmin/management-apis/1.0/runtimes/myruntime/notifications/applications/myapplication/wnsConf/android/1.0/?locale=de\\_DE](https://www.example.com/worklightadmin/management-apis/1.0/runtimes/myruntime/notifications/applications/myapplication/wnsConf/android/1.0/?locale=de_DE)

## Path Parameters

### **runtime-name**

The name of the runtime. This is the context root of the runtime web application, without the leading slash.

### **application-name**

The name of the application.

### **application-env**

The application environment.

### **application-version**

The application version number.

## Query Parameters

Query parameters are optional.

### **locale**

The locale used for error messages.

## Produces

application/json, application/xml, text/xml

## Response

The delete status of WNS credentials.

## JSON Example

```
{
  "productVersion" : {
    "productVersion" : "7.0.0",
  },
  "project" : {
    "name" : "PushNotifications",
  },
  "status" : "Success",
  "type" : "DELETE_PUSH_CREDENTIALS",
}
```

## XML Example

```
<?xml version="1.0" encoding="UTF-8"?>
<deleteWNSCredentialsStatus
  status="Success"
  type="DELETE_PUSH_CREDENTIALS">
  <productVersion productVersion="7.0.0"/>
  <project name="PushNotifications"/>
</deleteWNSCredentialsStatus>
```

## Response Properties

The response has the following properties:

### **productVersion**

The exact product version.

### **project**

Project name.

**status**

The WNS credentials are deleted successfully.

**type**

Transaction type.

The *productVersion* has the following properties:

**productVersion**

The exact product version

The *project* has the following properties:

**name**

Name of the project

**Errors**

403

The user is not authorized to call this service.

404

The corresponding runtime is not found or not running.

500

An internal error occurred.

## WNS Credentials (GET)

Retrieves Windows Push Notification Services (WNS) credentials of the application with the application ID, environment, and version.

**Roles**

Users in the following roles are authorized to perform this operation:

- **worklightadmin**
- **worklightdeployer**
- **worklightmonitor**
- **worklightoperator**

**Method**

GET

**Path**

*/management-apis/1.0/runtimes/runtime-name/notifications/applications/application-name/wnsConf/application-env/application-version/*

**Example**

[https://www.example.com/worklightadmin/management-apis/1.0/runtimes/myruntime/notifications/applications/myapplication/wnsConf/android/1.0/?locale=de\\_DE](https://www.example.com/worklightadmin/management-apis/1.0/runtimes/myruntime/notifications/applications/myapplication/wnsConf/android/1.0/?locale=de_DE)

## Path Parameters

### **runtime-name**

The name of the runtime. This is the context root of the runtime web application, without the leading slash.

### **application-name**

The name of the application.

### **application-env**

The application environment.

### **application-version**

The application version number.

## Query Parameters

Query parameters are optional.

### **locale**

The locale used for error messages.

## Produces

application/json, application/xml, text/xml

## Response

The WNS Credentials of the application with the application ID, environment, and version.

## JSON Example

```
{
  "clientSecret" : "82e4569er",
  "packageSID" : "ms-app://s-123-566-78910",
  "productVersion" : "7.0.0",
}
```

## XML Example

```
<?xml version="1.0" encoding="UTF-8"?>
<wnsCredentials
  clientSecret="82e4569er"
  packageSID="ms-app://s-123-566-78910"
  productVersion="7.0.0"/>
```

## Response Properties

The response has the following properties:

### **clientSecret**

The client secret received from WNS.

### **packageSID**

The unique identifier of the app received from WNS.

### **productVersion**

The exact product version.



## Errors

403

The user is not authorized to call this service.

404

The corresponding runtime is not found or not running.

500

An internal error occurred.

## WNS Credentials (PUT)

Sets Windows Push Notification Services (WNS) credentials of the application with the application ID, environment, and version.

### Roles

Users in the following roles are authorized to perform this operation:

- **worklightadmin**
- **worklightdeployer**
- **worklightmonitor**
- **worklightoperator**

### Method

PUT

### Path

*/management-apis/1.0/runtimes/runtime-name/notifications/applications/application-name/wnsConf/application-env/application-version/*

### Example

[https://www.example.com/worklightadmin/management-apis/1.0/runtimes/myruntime/notifications/applications/myapplication/wnsConf/android/1.0/?locale=de\\_DE](https://www.example.com/worklightadmin/management-apis/1.0/runtimes/myruntime/notifications/applications/myapplication/wnsConf/android/1.0/?locale=de_DE)

### Path Parameters

#### **runtime-name**

The name of the runtime. This is the context root of the runtime web application, without the leading slash.

#### **application-name**

The name of the application.

#### **application-env**

The application environment.

#### **application-version**

The application version number.

### Query Parameters

Query parameters are optional.

**locale**

The locale used for error messages.

**Consumes**

application/json

**Produces**

application/json, application/xml, text/xml

**Payload**

The payload in JSON format has values for packageSID and clientSecret.

**JSON Example**

```
{
  "clientSecret" : "82e4569er",
  "packageSID" : "ms-app://s-123-566-78910",
}
```

**Payload Properties**

The payload has the following properties:

**clientSecret**

The client secret received from WNS.

**packageSID**

The unique identifier of the app received from WNS.

**Response**

The status of set WNS credentials.

**JSON Example**

```
{
  "productVersion" : {
    "productVersion" : "7.0.0",
  },
  "project" : {
    "name" : "PushNotifications",
  },
  "status" : "Success",
  "type" : "SET_WNS_CREDENTIALS",
}
```

**XML Example**

```
<?xml version="1.0" encoding="UTF-8"?>
<setWNSCredentialsStatus
  status="Success"
  type="SET_WNS_CREDENTIALS">
  <productVersion productVersion="7.0.0"/>
  <project name="PushNotifications"/>
</setWNSCredentialsStatus>
```

**Response Properties**

The response has the following properties:

**productVersion**  
The exact product version.

**project**  
Project name.

**status**  
The WNS credentials are saved successfully.

**type**  
Transaction type.

The *productVersion* has the following properties:

**productVersion**  
The exact product version

The *project* has the following properties:

**name**  
Name of the project

## Errors

403  
The user is not authorized to call this service.

404  
The corresponding runtime is not found or not running.

500  
An internal error occurred.

---

## MobileFirst Cloudant API reference

Cloudant is an advanced NoSQL database that is capable of handling a wide variety of data types, such as JSON, full-text, and geospatial data. You can use the Cloudant APIs to access a Cloudant database from your mobile application.

For more information about the SDK and Cloudant, see “Storing mobile data in Cloudant” on page 8-186.

## Objective-C API for MobileFirst Cloudant extensions

Use the Objective-C API reference if you are developing a native iOS application in Swift or Objective-C that accesses a Cloudant database.

You can use the IMFData Framework for iOS and the CloudantToolkit Framework for iOS to make your data persistent in the cloud.

- You can also find description of the API of the IMFData Framework for iOS in the following file: Objective-C API for MobileFirst Cloudant extensions: IMFData
- You can also find description of the API of the CloudantToolkit Framework for iOS in the following file: Objective-C API for MobileFirst Cloudant extensions: Cloudant Toolkit



---

## Deploying MobileFirst projects

**Note:** Before you can deploy the project to the production environment, you must install the MobileFirst Administration Components as described in “Installing the MobileFirst Server administration” on page 6-43.

You can deploy several MobileFirst runtime environments (that is, several project WAR files) to an application server just as you would deploy any Java EE application. Each deployed project must have a unique name and a unique context path.

**Note:** An Administration Service must be installed on the application server where you install a runtime environment. Otherwise, the runtime environment cannot download its applications and adapters and cannot start.

You can choose between having several projects use the same database server, or making each project use a different database server. If you configure several projects to use the same database, you must configure each data source to connect to an independent data storage structure (for example, different schemas on DB2, or different user names on Oracle). Database sharing is not relevant for MySQL and Apache Derby.

Several instances of MobileFirst Server with different versions of IBM MobileFirst Platform Foundation for iOS installed can share the same application server and the same MobileFirst Administration Service. However, they must be migrated to be compatible with the current version of the Administration Service. For more information about migration, see “Migrating a project WAR file for use with a new MobileFirst Server” on page 10-39.

---

## Deploying MobileFirst applications to test and production environments

When you have developed an application, deploy it to a separate test and production environment.

### About this task

When you finish a development cycle of your application, you usually deploy it to a testing environment, and then to a production environment.

The tools that you can use to deploy apps and adapters across development, QA, and production environments are described in the following topics.

### Deploying an application from development to a test or production environment

After you have developed an application, you want to move from your development environment and deploy a MobileFirst project to a test or production environment.

## Before you begin

You have built a MobileFirst project that contains one or more applications in MobileFirst tools. A WAR file and a set of `.wlap` files are created in the `bin` folder of your MobileFirst project. You now want to deploy the project and the applications to a test or production environment.

- A WAR file is created by MobileFirst tools for every MobileFirst project, regardless of the number of apps it contains.
- If you build an entire app, a file that is called `app-name.wlap` is created, containing the code and resources of all environments that are supported by your app. For example: `myApp-all.wlap`.
- If you build an app only for specific environments, a file that is called `app-name-env-version.wlap` is created per environment. For example: `myApp-iphone-1.0.wlap`.

## About this task

First, you prepare the application or applications for deployment, and then you deploy them. You can deploy many apps within the same project. The following instructions lead you through this process.

## Procedure

1. Install the MobileFirst Server administration components as described in “Installing the MobileFirst Server administration” on page 6-43.  
You can have several MobileFirst runtime environments that are managed by the same MobileFirst Operations Console. Verify that you have deployment rights for IBM MobileFirst Platform Foundation for iOS, such as the role of **worklightdeployer** or **worklightadmin**. For more information, see “Configuring user authentication for MobileFirst Server administration” on page 6-82.
2. For each application in the project, change the settings in the `application-descriptor.xml` file to match your production environment.  
If necessary depending on the functions of the app, change the following settings.
  - Settings screen
  - Device provisioning
  - Application authenticity
  - User authentication
3. You might want to look at the settings in the `worklight.properties` file, which is in `server/conf`. Those settings define the default values for the configuration properties on the server. When you deploy your MobileFirst project on the server, you can replace the default settings that are in the `worklight.properties` file with values that are relevant for the production environment. For more information, see “Configuring a MobileFirst project in production by using JNDI environment entries” on page 10-60.
4. Create the project WAR file in either of two ways:
  - Right-click the application and click **Run As > Run on MobileFirst Development Server**.
  - Use the Ant script tool that is described in “Ant tasks for building and deploying applications and adapters” on page 10-69.

The project WAR file is generated in the `bin` folder.

5. Configure a database and deploy the project WAR to the application server with one of these two methods:
  - With the MobileFirst Server Configuration Tool. For more information, see “Deploying, updating, or undeploying MobileFirst Server by using the Server Configuration Tool” on page 10-9.
  - With Ant tasks for configuring a database for a MobileFirst project and deploying a MobileFirst project WAR file to an application server. With this method, you can also configure the project on the server by using JNDI environment entries.
    - The documentation of the Ant tasks for configuring a database is at “Creating and configuring the databases with Ant tasks” on page 10-13.
    - The documentation of the Ant tasks for deploying a project WAR file is at “Deploying a project WAR file and configuring the application server with Ant tasks” on page 10-14.
    - The list of JNDI environment entries that can be configured is at “Configuring a MobileFirst project in production by using JNDI environment entries” on page 10-60.
    - You can find sample Ant files that use these Ant tasks in the MobileFirst distribution in *product\_install\_dir/WorklightServer/configuration-samples*. Their file names use the naming convention *configure-appServer-database.xml*. For more information, see “Sample configuration files” on page 14-35.
      - a. First call **configuredatabase**, the **databases** target in the sample Ant files.
      - b. Then call **configureapplicationserver**, the **install** target in the sample Ant files.
6. If you wish to enable extended authenticity checking, follow the steps in “Configuring extended app authenticity checking” on page 10-51.
7. Open the MobileFirst Operations Console of the target environment.
 

If the MobileFirst Operations Console is installed with the default context root, its URL is of the form `https://your-remote-server:server-port/worklightconsole`. If HTTPS is not supported in your application server, it is the unsecured URL `http://your-remote-server:server-port/worklightconsole`.

**Important:** If you access the MobileFirst Operations Console through HTTP instead of HTTPS, your MobileFirst administration user password is compromised.
8. From the MobileFirst Operations Console, deploy the relevant *.wlap* files from the *bin* folder of your MobileFirst project. If you enabled extended authenticity checking in step 6, deploy the *.wlap* files that resulted from that procedure, instead.
  - For more information about how to deploy an application by using MobileFirst Operations Console, see “Deploying apps” on page 10-78.
  - You can also deploy the app to the target environment by using the MobileFirst Server administration command-line tools. For more information about how to deploy an app by using the provided command-line tools, see “Administering MobileFirst applications through Ant” on page 11-11 and “Administering MobileFirst applications through the command line” on page 11-36.
9. Deploy the adapters from the development environment.
  - a. Navigate to the *bin* folder in your project.

- b. Copy the .adapter file or files.
- c. From the MobileFirst Operations Console, deploy the .adapter files from the bin folder of your project.
  - For more information about how to deploy an adapter by using MobileFirst Operations Console, see “Deploying adapters” on page 10-79.
  - You can also deploy the adapter to the target environment by using the MobileFirst Server administration command-line tools. For more information about how to deploy an app by using the provided command-line tools, see “Administering MobileFirst applications through Ant” on page 11-11 and “Administering MobileFirst applications through the command line” on page 11-36.

## Results

A message is displayed, indicating whether the deployment action succeeded or failed.

## Building a project WAR file with Ant

You can build the project WAR file by using Ant tasks.

Before you can run Ant tasks, make sure that Apache Ant is installed. The minimum supported version of Ant is listed in “System requirements” on page 2-7.

Apache Ant 1.8.4 is included in MobileFirst Server. In the *product\_install\_dir/shortcuts/* directory, the following scripts are provided:

- For UNIX / Linux: ant
- For Windows: ant.bat

These scripts are ready to run, which means that they do not require specific environment variables. If the JAVA\_HOME environment variable is set, the scripts accept it.

**Note:** Since IBM Worklight Foundation V6.2.0, the *worklight-ant-builder.jar* file is included in the IBM MobileFirst Platform Command Line Interface for iOS, whereas in earlier versions, it was included in MobileFirst Server. By default, *worklight-ant-builder.jar* is installed in the following location: *<CLI Install Path>/public/worklight-ant-builder.jar*. For example, on OSX, the default CLI Install Path is */Applications/IBM/Worklight-CLI*. If you use the default installation path, the Ant task is installed here: */Applications/IBM/Worklight-CLI/public/worklight-ant-builder.jar*.

The Ant task for building a MobileFirst project WAR file has the following structure:

```
<?xml version="1.0" encoding="UTF-8"?>
<project name="myProject" default="all">
  <taskdef resource="com/worklight/ant/defaults.properties">
    <classpath>
      <pathelement location="cli_install_dir/public/worklight-ant-builder.jar"/>
    </classpath>
  </taskdef>
  <target name="all">
    <war-builder projectfolder="."
      destinationfolder="bin/war"
      warfile="bin/project.war"
      classesFolder="classes-folder"/>
  </target>
</project>
```



The <war-builder> element has the following attributes:

- The `projectFolder` attribute specifies the path to your project.
- The `destinationFolder` attribute specifies a folder for holding temporary files.
- The `warfile` attribute specifies the destination and file name of the generated .war file
- The `classesFolder` attribute specifies a folder with compiled Java classes to add to the .war file. .jar files in the `projectFolder\server\lib` directory are added automatically

## Deploying the project WAR file

For the MobileFirst runtime environment to start, you must deploy it to the server where the Administration Services application is installed. If you use WebSphere Application Server Network Deployment, you can alternatively install the MobileFirst runtime environment in a server or cluster of the cell other than the one where the Administration Services application that manages this runtime is installed. If you do so, you must start the server or cluster where the Administration Services application is installed before the one where the MobileFirst runtime environment is installed.

### Before you start

See “Planning deployment of administration components and runtimes” on page 6-7 for the supported deployment topologies.

Install the MobileFirst Server by following the procedure in “Installing MobileFirst Server” on page 6-2.

If you have a farm topology, configure the server farm by following the procedure in “Installing a server farm” on page 6-97.

The database and application server prerequisites for this task are described in “Installation prerequisites” on page 6-4.

You must build a MobileFirst project WAR file by using MobileFirst Platform Command Line Interface for iOS, or by following the instructions in “Building a project WAR file with Ant” on page 10-4. The WAR file contains the default configuration values for the server, and some resources for the MobileFirst applications and adapters.

- For project WAR files built with earlier versions than V6.2.0.x: The project WAR file must be built with the same version of Worklight Studio as the version used to build the apps that are deployed on the Worklight Server.
- For project WAR files that were built with V6.2.0 and later, and deployed to Worklight Server V6.2.0.1 and later, apps and adapters that were built with any version, 5.0.6.x and above (but not later than the project WAR version itself), can be deployed.

You can deploy a MobileFirst project in one the following ways:

- By using the Server Configuration Tool.
- By using a set of Ant tasks that are supplied with MobileFirst Server to deploy a project WAR file and configure your databases and application servers.
- By creating and configuring the databases manually, and deploying the project WAR file manually.

### Optional creation of databases

If you want to activate the option to install the project runtime databases when you run the Ant tasks or the Server Configuration Tool, you must have certain

database access rights that entitle you to create the databases, or the users, or both, that are required by the project runtime component.

If you have sufficient database administration credentials, and if you enter the administrator user name and password in the installer when prompted, the installation tools can create the databases for you. Otherwise, you must ask your database administrator to create the required database for you. In this case, the database must be created before you start the installation tools.

The following topics describe the procedure for the supported database management systems.

**Important:** The manual creation of databases is optional if you install MobileFirst Server with the Server Configuration Tool or the Ant tasks because the Server Configuration Tool and the Ant tasks can create the databases automatically.

### **Creating the DB2 databases:**

This section explains the procedures used to create the DB2 databases.

#### **Before you begin**

You perform this procedure to create the databases before you run Ant tasks or the Server Configuration Tool to populate them. For a fully manual database installation, see “Configuring the DB2 databases manually” on page 10-17 instead.

#### **About this task**

**Note:** The Reports database (WLREPORT below) is deprecated in IBM MobileFirst Platform Foundation for iOS V7.0.0. Use “Operational analytics” on page 12-8 instead.

The <configureDatabase> Ant task can create the databases for you if you enter the name and password of a user account on the database server that has the DB2 SYSADM or SYSCTRL privilege, and the account can be accessed through SSH. Otherwise, the database administrator can create the databases for you. For more information, see the DB2 Solution user documentation.

You can replace the database names (here WRKLGHT and WLREPORT) and passwords with database names and passwords of your choosing.

**Important:** You can name your databases and user differently, or set a different password, but ensure that you enter the appropriate database names, user name, and password correctly across the DB2 database setup. DB2 has a database name limit of 8 characters on all platforms, and has a user name and password length limit of 8 characters for Unix and Linux systems, and 30 characters for Windows.

You can also choose to have the data for WRKLGHT database and the data for WLREPORT database be stored in a single database, as different schemas. To this effect, in the following procedure, use a single database name of your choosing instead of WRKLGHT and WLREPORT.

#### **Procedure**

1. Create a system user, for example, named wuser in a DB2 admin group such as DB2USERS, using the appropriate commands for your operating system. Give it a password, for example, wuser. If you want multiple MobileFirst projects to

connect to the same database, use a different user name for each connection. Each database user has a separate default schema. For more information about database users, see the DB2 documentation and the documentation for your operating system.

2. Open a DB2 command line processor, with a user that has SYSADM or SYSCTRL permissions:

- On Windows systems, click **Start > IBM DB2 > Command Line Processor**
- On Linux or UNIX systems, navigate to `~/sql1lib/bin` and enter `./db2`.
- Enter database manager and SQL statements similar to the following example to create the two databases:

```
CREATE DATABASE WRKLGHT COLLATE USING SYSTEM PAGESIZE 32768
CONNECT TO WRKLGHT
GRANT CONNECT ON DATABASE TO USER wuser
DISCONNECT WRKLGHT
CREATE DATABASE WLREPORT COLLATE USING SYSTEM PAGESIZE 32768
CONNECT TO WLREPORT
GRANT CONNECT ON DATABASE TO USER wuser
DISCONNECT WLREPORT
QUIT
```

Where *wuser* is the name of the system user that you previously created. If you defined a different user name, replace *wuser* accordingly.

3. It is also possible to use only one database (with pagesize settings compatible with what is previously listed), and to create the databases for IBM MobileFirst Platform Foundation for iOS in different schemas. In that case, only one database is required. If the IMPLICIT\_SCHEMA authority is granted to the user created in step 1 (the default in the database creation script in step 2), no further action is required. If the user does not have the IMPLICIT\_SCHEMA authority, you need to create a SCHEMA for the runtime database tables and objects and a SCHEMA for the reports database tables and objects.

### Creating the MySQL databases:

This section explains the procedures used to create the MySQL databases.

#### Before you begin

You perform this procedure to create the databases before you run Ant tasks or the Server Configuration Tool to populate them. For a fully manual database installation, see “Configuring the MySQL databases manually” on page 10-28 instead.

#### About this task

**Note:** The Reports database (WLREPORT below) is deprecated in IBM MobileFirst Platform Foundation for iOS V7.0.0. Use “Operational analytics” on page 12-8 instead. Note that setting up the Reports database is optional in this release and prior releases.

The `<configureDatabase>` Ant task can create the databases for you if you enter the name and password of the superuser account. For more information, see Securing the Initial MySQL Accounts on your MySQL database server. Your database administrator can also create the databases for you. When you manually create the databases, you can replace the database names (here WRKLGHT and WLREPORT) and the password with database names and a password of your choosing. Note that MySQL database names are case-sensitive on UNIX.

## Procedure

1. Start the MySQL command-line tool.
2. Enter the following commands:

```
CREATE DATABASE WRKLGHT CHARACTER SET utf8 COLLATE utf8_general_ci;
GRANT ALL PRIVILEGES ON WRKLGHT.* TO 'worklight'@'Worklight-host' IDENTIFIED BY 'password';
GRANT ALL PRIVILEGES ON WRKLGHT.* TO 'worklight'@'localhost' IDENTIFIED BY 'password';
FLUSH PRIVILEGES;
CREATE DATABASE WLREPORT CHARACTER SET utf8 COLLATE utf8_general_ci;
GRANT ALL PRIVILEGES ON WLREPORT.* TO 'worklight'@'Worklight-host' IDENTIFIED BY 'password';
GRANT ALL PRIVILEGES ON WLREPORT.* TO 'worklight'@'localhost' IDENTIFIED BY 'password';
FLUSH PRIVILEGES;
```

Where *worklight* before the @ sign is the user name, *password* after IDENTIFIED BY is the user password, and *Worklight-host* is the name of the host on which IBM MobileFirst Platform Foundation for iOS runs.

## Creating the Oracle databases:

You can use the <configureDatabase> Ant task to create the Oracle databases, except for the Oracle 12c database type.

## Before you begin

You perform this procedure to create the databases before you run Ant tasks or the Server Configuration Tool to populate them. For a fully manual database installation, see “Configuring the Oracle databases manually” on page 10-33 instead.

## About this task

**Note:** The Reports database (WLREPORTS below) is deprecated in IBM MobileFirst Platform Foundation for iOS V7.0.0. Use “Operational analytics” on page 12-8 instead. Note that setting up the Reports database is optional in this release and prior releases.

The <configureDatabase> Ant task can create the databases, except for the Oracle 12c database type, or the users and schemas inside an existing database if you enter the name and password of the Oracle administrator on the database server, and the account can be accessed through SSH. Otherwise, the database administrator can create the databases or users and schemas for you. When you manually create the databases or users, you can use database names, user names, and a password of your choosing. Note that lowercase characters in Oracle user names might not be supported.

## Procedure

1. If you do not already have a database named ORCL, use the Oracle Database Configuration Assistant (DBCA) and follow the steps in the wizard to create a new database named ORCL:
  - a. Use global database name *ORCL\_your\_domain*, and system identifier (SID) ORCL.
  - b. On the **Custom Scripts** tab of the step **Database Content**, do not run the SQL scripts, because you must first create a user account.
  - c. On the **Character Sets** tab of the step **Initialization Parameters**, select **Use Unicode (AL32UTF8) character set and UTF8 - Unicode 3.0 UTF-8 national character set**.
  - d. Complete the procedure, accepting the default values.

If the Oracle installation is on a UNIX or Linux machine, make sure that the database will be started the next time the Oracle installation is restarted. To this effect, make sure the line in `/etc/oratab` that corresponds to the database ends with a Y, not with an N.

2. Create database users either by using Oracle Database Control, or by using the Oracle SQLPlus command-line interpreter.

- Using Oracle Database Control.

- a. Create the user for the runtime database:

- 1) Connect as SYSDBA.
- 2) Go to the **Users** page: click **Server**, then **Users** in the **Security** section.
- 3) Create a user, for example, named *WORKLIGHT*. If you want multiple MobileFirst projects to connect to the same general-purpose database you created in step 1, use a different user name for each connection. Each database user has a separate default schema.
- 4) Assign the following attributes:
  - Profile: **DEFAULT**
  - Authentication: **password**
  - Default tablespace: **USERS**
  - Temporary tablespace: **TEMP**
  - Status: **Unlocked**
  - Add system privilege: **CREATE SESSION**
  - Add system privilege: **CREATE SEQUENCE**
  - Add system privilege: **CREATE TABLE**
  - Add quota: **Unlimited for tablespace USERS**

- b. Repeat step "a" to create a user, for example, named *WORKLIGHTREPORTS* for the MobileFirst report database.

- Using the Oracle SQLPlus command-line interpreter.

The commands in the following example create a user named *WORKLIGHT* and a user named *WORKLIGHTREPORTS*:

```
CONNECT SYSTEM/<SYSTEM_password>@ORCL
CREATE USER WORKLIGHT IDENTIFIED BY 'WORKLIGHT_password' DEFAULT TABLESPACE USERS QUOTA UNLIMITED ON USERS;
GRANT CREATE SESSION, CREATE SEQUENCE, CREATE TABLE TO WORKLIGHT;
DISCONNECT;
```

```
CONNECT SYSTEM/<SYSTEM_password>@ORCL
CREATE USER WORKLIGHTREPORTS IDENTIFIED BY 'WORKLIGHTREPORTS_password' DEFAULT TABLESPACE USERS QUOTA UNLIMITED ON USERS;
GRANT CREATE SESSION, CREATE SEQUENCE, CREATE TABLE TO WORKLIGHTREPORTS;
DISCONNECT;
```

## Deploying, updating, or undeploying MobileFirst Server by using the Server Configuration Tool

The Server Configuration Tool is a graphical tool that you can use to deploy, update, or undeploy a MobileFirst Server instance to or from an application server and database.

If you use this tool in production to upgrade a MobileFirst Server, you must complete more actions to upgrade the server, as described in “Upgrading to MobileFirst Server V7.0.0 in a production environment” on page 7-4.

Before you use this tool, verify that the user who runs the Server Configuration Tool has the privileges that are described in “File system prerequisites” on page 6-5.

The Server Configuration Tool provides the same capabilities as the Ant tasks that are described in “Ant tasks for installation of MobileFirst Operations Console and Administration Services” on page 14-10 and “Ant tasks for installation of MobileFirst runtime environments” on page 14-16. Compared to Ant tasks, the Server Configuration Tool is limited to a set of operations that are described in the following list:

- The supported databases are IBM DB2, Oracle, and MySQL.

**Restriction:** The Derby database is not supported.

- It is not possible to define JNDI deployment properties, such as **publicWorkLightHostname** or other properties that are listed in “Configuring a MobileFirst project in production by using JNDI environment entries” on page 10-60. To define those properties, use Ant files. You can use the Server Configuration Tool to export an Ant file from a server configuration and then add JNDI deployment properties to it manually. (See “Other operations available in the Server Configuration Tool” on page 10-12.)
- The Server Configuration Tool must be started on the computer where your application server is installed.
- The Server Configuration Tool maintains a deployment status of configuration server components, whether they are deployed or not. This status is not accurate if the MobileFirst Server components are modified outside the Server Configuration Tool.
- The Server Configuration Tool is available only on Windows and Linux (x86). It is also available on Mac OS for test or demonstration purposes, but the MobileFirst Server is not supported for production in this environment.
- You can use the Server Configuration Tool to install MobileFirst Server to WebSphere Application Server Network Deployment (clusters, servers), to a stand-alone WebSphere Application Server instance, or to a Liberty or Tomcat server. However, you cannot use the Server Configuration Tool to install MobileFirst Server to a server farm.
- You cannot use the Server Configuration Tool to add a runtime to an Administration Service that was installed or upgraded with Ant tasks and not with the Server Configuration Tool.

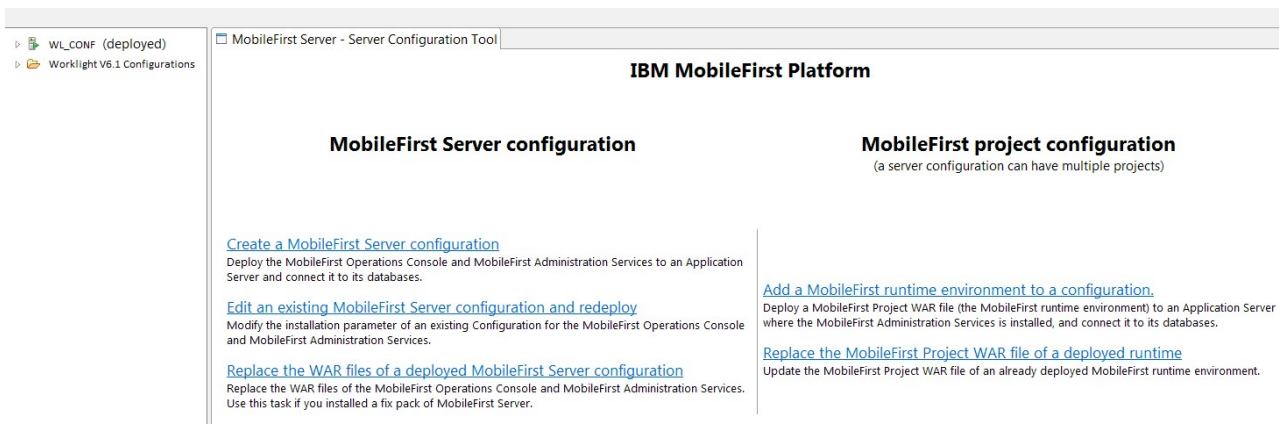

Figure 10-1. Server Configuration Tool main window

## Running the Server Configuration Tool

You can start the Server Configuration Tool in the following ways:

### On Linux

- By using the desktop menu shortcut **Server Configuration Tool**.
- In a File Manager, click the file `mf_server_install_dir/shortcuts/configuration-tool.sh`.

**Note:** `mf_server_install_dir` is the directory where you install MobileFirst Server. `mf_server` is the shortcut for MobileFirst Server.

- From a shell command line, run the command `mf_server_install_dir/shortcuts/configuration-tool.sh`.

### On Windows

- By using the **Start > IBM MobileFirst Platform Server > Server Configuration Tool** menu command.
- In Windows Explorer, double-click the file `mf_server_install_dir/shortcuts/configuration-tool.bat`.
- In a console window, run `mf_server_install_dir/shortcuts/configuration-tool.bat`.

### On Mac OS X

**Restriction:** MobileFirst Server is not supported for production in this environment.

- In the Finder, double-click the file `mf_server_install_dir/shortcuts/configuration-tool.sh`.
- In a Terminal window, run `mf_server_install_dir/shortcuts/configuration-tool.sh`.

## Main tasks

### Create a MobileFirst Server configuration

For more information, see “Installing MobileFirst Server administration with the Server Configuration Tool” on page 6-51.

After a MobileFirst Server configuration is created, you can do the following tasks:

### Edit an existing MobileFirst Server configuration and redeploy

Use this task to edit and modify an existing MobileFirst Server configuration. If you select this action, the work flow is as follows:

1. You are prompted to select one of the configurations visible in the Navigation view.
2. If passwords are required to redeploy the configuration, you are prompted to enter them.
3. After you enter the passwords, the configuration is checked for errors.
4. If errors are found, a report is displayed.
5. You can then edit the configuration.
6. If the configuration contains no errors, the **Redeploy** button is enabled.
7. When you click **Redeploy**, the MobileFirst administration components are uninstalled from the application server, and reinstalled with the new parameters.

### **Add a MobileFirst runtime environment to a configuration**

Use this task to add a MobileFirst runtime environment to a MobileFirst Server configuration.

To create a new MobileFirst runtime environment, complete the following steps:

1. Select a MobileFirst Server configuration.
2. Select **File > Add MobileFirst runtime environment**.
3. Enter a descriptive name for the MobileFirst runtime environment.
4. Select the path for the MobileFirst project WAR file to be deployed.
5. Step through the wizard to describe the target database management system.

If you need to create a database for your MobileFirst runtime environment, the Server Configuration Tool can create it for you. If you provide the requested administrator password when you are prompted in the Database Creation Request panel, the database for MobileFirst runtime environment is created. Alternatively, you can ask your database administrator to create the database manually by following the instructions in “Optional creation of databases” on page 10-5.

6. After you provide all the necessary information, the **Deploy** button is enabled. When you click **Deploy**, the following effects take place:
  - a. The configuration file is saved.
  - b. If the database contains no MobileFirst tables, these tables are created.
  - c. If the database contains MobileFirst tables for an older version of the product, the tables are upgraded to the current version.
  - d. If the database operations succeed, the MobileFirst Server is deployed to the application server.
  - e. If the WAR file needs to be migrated to the current version, it is migrated.

### **Replace the project WAR file of a deployed runtime**

Use this task to update the WAR files and libraries of the MobileFirst administration components. For example, apply a fix pack to the installation directory of MobileFirst Server.

### **Replace the WAR file of a deployed MobileFirst Server configuration**

If you applied a fix pack to your installation of MobileFirst Server, use this task to update the console and administration WAR files of a deployed configuration.

## **Other operations available in the Server Configuration Tool**

### **Export a Configuration**

When you click **File > Export Configuration as Ant files**, Ant files are exported. These Ant files contain tasks that take the following actions for the MobileFirst Operations Console and Administration Services, and for each MobileFirst runtime environment of the configuration:

- Create or update the databases
- Deploy the WAR file
- Update the WAR file
- Undeploy the WAR file



A **help** target, the default target of the Ant project, describes the different targets available. You might want to export a configuration for the following reasons:

- To add deployment JNDI properties, then run the Ant file in command-line mode with Apache Ant.
- To run the Ant file on a computer without a graphical user interface.
- To perform the MobileFirst Server operations in batch mode (from the command line and without using a graphical user interface).

If you modify the MobileFirst Server status outside the Server Configuration Tool, the status for this configuration is no longer accurate.

### **Migrate a V6.1.0 Configuration**

Configurations that were created with IBM Worklight V6.1.0 are displayed in a folder called **Worklight 6.1 Configurations**. To migrate such configurations to IBM MobileFirst Platform Foundation for iOS V7.0.0, complete the following steps:

1. Select the configuration.
2. Right-click to open a contextual menu.
3. Select **Migrate a V6.1 configuration**. An IBM MobileFirst Platform Foundation for iOS V7.0.0 configuration is created.
4. Review all the pages of the wizard. In Database Additional Settings, you must enter information for the new administration database.
5. When all the pages are reviewed, click **Migrate**.

The IBM Worklight runtime environment V6.1.0 is removed from the application server. The databases are migrated, the MobileFirst Operations Console and Administration Services are deployed, and the MobileFirst runtime environment is deployed.

### **Change the working directory where the configurations are stored**

Click **File > Preferences** and select a different working directory.

## **Using Ant tasks to deploy the project WAR file**

### **Creating and configuring the databases with Ant tasks:**

If you did not manually create databases, you can use Ant tasks to create and configure your databases.

#### **About this task**

If you did not use the procedure in “Optional creation of databases” on page 10-5 to create the databases manually, complete the following steps.

#### **Procedure**

1. Review the sample configuration files in “Sample configuration files” on page 14-35, and copy the Ant file that corresponds to your database. The files for creating a database are named after the following pattern:

```
create-database-database.xml
```

For more information, see table 1, Table 14-62 on page 14-35, in “Sample configuration files” on page 14-35.

2. Follow step 4 of the page “Sample configuration files” on page 14-35 to edit the Ant file and replace the placeholder values for the properties at the top of the file.

3. Run the following commands to create the databases.

```
ant -f create-database-database.xml databases
```

You can find the Ant command in *product\_install\_dir/shortcuts*.

If the databases are created, and you must create only the databaseTABLES.

4. Edit the Ant script that you use later to create and configure the databases.
5. Review the sample configuration files in “Sample configuration files” on page 14-35, and copy the Ant file that corresponds to your database. The files for configuring an existing database are named after this pattern:

```
configure-appServer-database.xml
```

For more information, see table 1, Table 14-62 on page 14-35, in “Sample configuration files” on page 14-35.

6. See step 4 of the page “Sample configuration files” on page 14-35 to edit the Ant file and replace the placeholder values for the properties at the top of the file.
7. Run the following commands to create the databases.

```
ant -f configure-appServer-database.xml databases
```

You can find the Ant command in *product\_install\_dir/shortcuts*.

### What to do next

See also:

- “Ant **configuredatabase** task reference” on page 14-1
- “Sample configuration files” on page 14-35

### Deploying a project WAR file and configuring the application server with Ant tasks:

Use Ant tasks to deploy the project WAR file to an application server, and configure data sources, properties, and database drivers that are used by IBM MobileFirst Platform Foundation for iOS. A set of Ant tasks is supplied with IBM MobileFirst Platform Server.

### Before you begin

See “Planning deployment of administration components and runtimes” on page 6-7 for the supported deployment topologies.

Before you deploy your project WAR file and configure the application server, you must complete the following procedures:

- “Installing MobileFirst Server” on page 6-2.
- “Installing a server farm” on page 6-97, to configure the server farm if you have a farm topology.
- “Creating and configuring the databases with Ant tasks” on page 10-13

If you deploy different project WAR files, each WAR file must have its own set of tables. Either the database, or the schema where the tables are stored, must be different. For Oracle, the database user must be different.

You must run the Ant task on the computer where the application server is installed, or the Network Deployment Manager for WebSphere Application Server

Network Deployment. If you want to start the Ant task from a computer on which Worklight Server is not installed, you must copy the file *mf\_server\_install\_dir/WorklightServer/worklight-ant-deployer.jar* to that computer.

**Note:** The *mf\_server\_install\_dir* placeholder is the directory where you installed IBM MobileFirst Platform Server.

### Procedure

1. Review the environment ID that you used to install the MobileFirst Server administration. This environment ID is installed as a JNDI property. For more information about the list of JNDI properties, see “List of JNDI properties for MobileFirst Server administration” on page 6-86.

**Important:** If the MobileFirst Server administration used an environment ID, install the project WAR file with the same environment ID. Otherwise, that project WAR file cannot be managed by the MobileFirst Server administration.

2. Edit the Ant script that you use later to deploy the Project WAR File.
  - a. Review the sample configuration files in “Sample configuration files” on page 14-35, and copy the Ant file that corresponds to your database. The files for deploying a project WAR file are named after the following pattern:  
`configure-appServer-database.xml`

For more information, see table 1, Table 14-62 on page 14-35, in “Sample configuration files” on page 14-35.

**Note:** If your file name follows the pattern `configure-appServer-database.xml`, you can reuse it for “Creating and configuring the databases with Ant tasks” on page 10-13,

- b. Follow step 4 of the page “Sample configuration files” on page 14-35 to edit the Ant file and replace the placeholder values for the properties at the top of the file.
3. If the MobileFirst Server administration uses an environment ID, and you run an Ant task for the installation, add an `environmentID` attribute to the following Ant tasks, which are used for the administration installation:

- `installworklightadmin`
- `updateworklightadmin`
- `uninstallworklightadmin`
- `configureapplicationserver`
- `updateapplicationserver`
- `unconfigureapplicationserver`

For more information, see “Ant tasks for installation of MobileFirst runtime environments” on page 14-16 and “Ant tasks for installation of MobileFirst Operations Console and Administration Services” on page 14-10.

**Important:** The value of the attribute must be the same as the one used for the MobileFirst Server administration.

4. To deploy the project WAR file, run the following command:  
`ant -f configure-appServer-database.xml install`

You can find the Ant command in *mf\_server\_install\_dir/shortcuts*

## What to do next

See also:

- “Ant tasks for installation of MobileFirst runtime environments” on page 14-16
- “Sample configuration files” on page 14-35
- “Using Ant tasks to install MobileFirst Server administration” on page 6-53
- “Encrypting database password with Ant tasks for Liberty” on page 14-9

*Configuring WebSphere Application Server Network Deployment servers:*

Specific considerations when you configure WebSphere Application Server Network Deployment servers through Ant tasks are documented in this section.

To install a MobileFirst project into a set of WebSphere Application Server Network Deployment servers, run the `<configureapplicationserver>` Ant task on the computer where the deployment manager is running.

### Procedure

1. Specify a database type other than Apache Derby. IBM MobileFirst Platform Foundation for iOS supports Apache Derby only in embedded mode, and this choice is incompatible with deployment through WebSphere Application Server Network Deployment.
2. As value of the `profile` attribute, specify the deployment manager profile.  
**Attention:** Do not specify an application server profile and then a single managed server. Doing so causes the deployment manager to overwrite the configuration of the server. This is true whether you install on the computer on which the deployment manager is running or on a different computer.
3. Specify an inner element, depending on where you want the MobileFirst Runtime Component to be installed. The following table lists the available elements:

**Note:** You must choose the same inner element to install the MobileFirst Administration Services. You must install an instance of the MobileFirst Administration Service on each server where the MobileFirst Runtime Component is installed.

Table 10-1. Inner elements of `<was>` for network deployment

Element	Explanation
cell	Install the MobileFirst project into all application servers of the cell.
cluster	Install the MobileFirst project into all application servers of the specified cluster.
node	Install the MobileFirst project into all application servers of the specified node that are not in a cluster.
server	Install the MobileFirst project into the specified server, which is not in a cluster.

4. After starting the `<configureapplicationserver>` Ant task, restart the affected servers:
  - You must restart the servers that were running and on which the MobileFirst project application was installed. To restart these servers with the deployment manager console, select **Applications > Application Types > WebSphere enterprise applications > IBM\_Worklight\_Console > Target specific application status**.
  - You do not have to restart the deployment manager or the node agents.

## Results

The configuration has no effect outside the set of servers in the specified scope. The JDBC providers, JDBC data sources, and shared libraries are defined with the specified scope. The entities that have a cell-wide scope (the applications and, for DB2, the authentication alias) use the specified `id` attribute as a suffix in their name; it makes their name unique. So, you can install MobileFirst Server in different configurations or even different versions of MobileFirst Server, in different clusters of the same cell.

**Note:** Because the JDBC driver is installed only in the specified set of application servers, the **Test connection** button for the JDBC data sources in the WebSphere Application Server administrative console of the deployment manager might not work.

### Adding a server to a cluster

When you add a server to a cluster that has a MobileFirst project installed on it, you must repeat some configuration manually. For each affected server, add a specific web container custom property:

1. Click **Servers > Server Types > Application Servers**, and select the server.
2. Click **Web Container Settings > Web container**.
3. Click **Custom properties**.
4. Click **New**.
5. Enter the property values listed in the following table:

Table 10-2. Web container custom property values

Property	Value
Name	<code>com.ibm.ws.webcontainer.invokeFlushAfterService</code>
Value	<code>false</code>
Description	See <a href="http://www.ibm.com/support/docview.wss?uid=swg1PM50111">http://www.ibm.com/support/docview.wss?uid=swg1PM50111</a> .

6. Click **OK**.
7. Click **Save**.

## Deploying the project WAR file manually

### Creating and configuring the databases manually:

You can manually create and configure the IBM MobileFirst Platform Foundation for iOS databases.

**Note:** The Reports database and the sample BIRT Reports are deprecated in IBM MobileFirst Platform Foundation for iOS V7.0.0. Use “Operational analytics” on page 12-8 instead.

#### *Configuring the DB2 databases manually:*

You configure the DB2 databases manually by creating the databases, creating the database tables, and then configuring the relevant application server to use this database setup.

## Procedure

1. Create the databases. This step is described in “Creating the DB2 databases” on page 10-6.
2. Create the tables in the databases. This step is described in “Setting up your DB2 databases manually.”
3. Perform the application server-specific setup as the following list shows.

**Note:** At this stage, you can choose to provide a database user with limited privileges to better secure access to the Application Server database during runtime operations. To create a database user with restricted privileges, see “Restricting database user permissions for IBM MobileFirst Platform Server runtime operations” on page 6-20.

*Setting up your DB2 databases manually:*

You can set up the database manually instead of using Ant tasks.

## About this task

**Note:** The Reports database (WLREPORT below) is deprecated in IBM MobileFirst Platform Foundation for iOS V7.0.0. Use “Operational analytics” on page 12-8 instead.

Set up your DB2 database by creating the database schema. The following procedure creates the schemas for WRKLGHT and WLREPORT in different databases, but it is possible to group them in the same database. In this case, skip step 5.

## Procedure

1. Create a system user, **worklight**, in a DB2 admin group such as **DB2USERS**, by using the appropriate commands for your operating system. Give it the password **password**. For more information, see the DB2 documentation and the documentation for your operating system.

**Important:** You can name your user differently, or set a different password, but ensure that you enter the appropriate user name and password correctly across the DB2 database setup. DB2 has a user name and password length limit of 8 characters for UNIX and Linux systems, and 30 characters for Windows.

**Note:** If you want multiple instances of IBM MobileFirst Platform Server to connect to the same database, use a different user name for each connection. Each database user has a separate default schema.

2. Open a DB2 command line processor, with a user that has **SYSADM** or **SYSCTRL** permissions:
  - On Windows systems, click **Start > IBM DB2 > Command Line Processor**.
  - On Linux or UNIX systems, go to `~/sqllib/bin` and enter `./db2`.
3. Enter the following database manager and SQL statements to create a database that is called **WRKLGHT**:

```
CREATE DATABASE WRKLGHT COLLATE USING SYSTEM PAGESIZE 32768
CONNECT TO WRKLGHT
GRANT CONNECT ON DATABASE TO USER worklight
QUIT
```

Where **worklight** is the name of the system user that you previously created. If you defined a different user name, replace **worklight** with the user name.

4. Run DB2 with the following commands to create the **WRKLGHT** tables:

```
db2 CONNECT TO WRKLGHT USER worklight USING password
db2 SET CURRENT SCHEMA = 'WRKSCHM'
db2 -vf product_install_dir/WorklightServer/databases/create-worklight-db2.sql -t
```

Where **worklight** after **USER** is the name of the system user with "CONNECT" access to the **WRKLGHT** database that you previously created, and **password** after **USING** is this user's password. If you defined either a different user name, or a different password, or both, replace **worklight**, or **password**, or both.

DB2 has a user name and password length limit of 8 characters for UNIX and Linux systems, and 30 characters for Windows.

**Important:** If you do not specify the user name and password, DB2 assumes that the user is the current user, and creates the tables by using this current user's schema. If the current user differs from the settings in **worklight**, then the current user is denied access to the tables in the database.

5. Enter the following database manager and SQL statements to create a database that is called **WLREPORT**:

```
CREATE DATABASE WLREPORT COLLATE USING SYSTEM PAGESIZE 32768
CONNECT TO WLREPORT
GRANT CONNECT ON DATABASE TO USER worklight
QUIT
```

6. Run DB2 with the following commands to create the **WLREPORT** tables:

```
db2 CONNECT TO WLREPORT USER worklight USING password
db2 SET CURRENT SCHEMA = 'WLRESCHM'
db2 -vf product_install_dir/WorklightServer/databases/create-worklightreports-db2.sql -t
```

*Configuring Liberty profile for DB2 manually:*

If you want to manually set up and configure your DB2 database with WebSphere Application Server Liberty profile, use the following procedure.

### Before you begin

**Note:** The Reports database (WLREPORT below) is deprecated in IBM MobileFirst Platform Foundation for iOS V7.0.0. Use "Operational analytics" on page 12-8 instead. Note that setting up the Reports database is optional in this release and prior releases.

Complete the DB2 Database Setup procedure before continuing.

### Procedure

1. Add the DB2 JDBC driver JAR file (download it from DB2 JDBC Driver Versions, or fetch it from the directory `DB2_INSTALL_DIR/java` on the DB2 server) to `$LIBERTY_HOME/wlp/usr/shared/resources/db2`. If that directory does not exist, create it.
2. Configure the data source in the `$LIBERTY_HOME/wlp/usr/servers/worklightServer/server.xml` file (`worklightServer` can be replaced in this path by the name of your server) as follows:

```
<!-- Declare the jar files for DB2 access through JDBC. -->
<library id="DB2Lib">
  <fileset dir="${shared.resource.dir}/db2" includes="*.jar"/>
</library>

<!-- Declare the runtime database -->
<dataSource jndiName="worklight/jdbc/WorklightDS" transactional="false">
  <jdbcDriver libraryRef="DB2Lib"/>
  <properties.db2.jcc databaseName="WRKLGHT" currentSchema="WRKSCHM">
```

```

serverName="db2server" portNumber="50000"
user="worklight" password="password"/>
</dataSource>

<!-- Declare the reports database -->
<dataSource jndiName="worklight/jdbc/WorklightReportsDS" transactional="false">
  <jdbcDriver libraryRef="DB2Lib"/>
  <properties.db2.jcc databaseName="WLREPORT" currentSchema="WLRESCHM"
serverName="db2server" portNumber="50000"
user="worklight" password="password"/>
</dataSource>

```

Where **worklight** after **user=** is the name of the system user with "CONNECT" access to the **WRKLGHT** and **WLREPORT** databases that you previously created, and **password** after **password=** is this user's password. If you defined either a different user name, or a different password, or both, replace these entries accordingly. Also, replace **db2server** with the host name of your DB2 server (for example, localhost, if it is on the same machine).

**Note:** The database user that is provided in step 2 does not need extended privileges on the databases. If you need to implement restrictions on the database, you can set here a user that has the restricted privileges that are listed in "Restricting database user permissions for IBM MobileFirst Platform Server runtime operations" on page 6-20.

DB2 has a user name and password length limit of 8 characters for UNIX and Linux systems, and 30 characters for Windows.

The `jndiName` attributes must depend on the context root that you select for the MobileFirst Server application, following the instructions in "Configuring the Liberty profile manually" on page 10-40. If the context root is `/app_context`, use `jndiName="app_context/jdbc/WorklightDS"` and `jndiName="app_context/jdbc/WorklightReportsDS"` respectively.

3. You can encrypt the database password with the `securityUtility` program in `<liberty_install_dir>/bin`.

**Note:** You have one password for each database: runtime (by default **WRKLGHT**) and reports (by default **WLREPORT**).

*Configuring WebSphere Application Server for DB2 manually:*

If you want to manually set up and configure your DB2 database with WebSphere Application Server, use the following procedure.

### About this task

**Note:** The Reports database (WLREPORT below) is deprecated in IBM MobileFirst Platform Foundation for iOS V7.0.0. Use "Operational analytics" on page 12-8 instead. Note that setting up the Reports database is optional in this release and prior releases.

Complete the DB2 database Setup procedure before continuing.

### Procedure

1. Determine a suitable directory for the JDBC driver JAR file in the WebSphere Application Server installation directory.
  - For a standalone server, you can use a directory such as `WAS_INSTALL_DIR/optionalLibraries/IBM/project-name/db2`.



- For deployment to a WebSphere Application Server Network Deployment cell, use `WAS_INSTALL_DIR/profiles/profile-name/config/cells/cell-name/project-name/db2`.
- For deployment to a WebSphere Application Server Network Deployment cluster, use `WAS_INSTALL_DIR/profiles/profile-name/config/cells/cell-name/clusters/cluster-name/project-name/db2`.
- For deployment to a WebSphere Application Server Network Deployment node, use `WAS_INSTALL_DIR/profiles/profile-name/config/cells/cell-name/nodes/node-name/project-name/db2`.
- For deployment to a WebSphere Application Server Network Deployment server, use `WAS_INSTALL_DIR/profiles/profile-name/config/cells/cell-name/nodes/node-name/servers/server-name/project-name/db2`.

If the directory for the JDBC driver JAR file does not exist, you must create it.

2. Add the DB2 JDBC driver JAR file to the directory that you determined in step 1.

You can retrieve the file in one of two ways:

- Download it from DB2 JDBC Driver Versions.
- Fetch it from the `db2_install_dir/java` on the DB2 server directory.

3. Set up the JDBC provider:
  - a. In the WebSphere Application Server console, click **Resources > JDBC > JDBC Providers**.
  - b. Select the appropriate scope from the **Scope** combination box.
  - c. Click **New**.
  - d. Set **Database type** to **DB2**.
  - e. Set **Provider type** to **DB2 Using IBM JCC Driver**.
  - f. Set **Implementation Type** to **Connection pool data source**.
  - g. Set **Name** to **DB2 Using IBM JCC Driver**.
  - h. Click **Next**.
  - i. Set the **Class path** to the set of JAR files in the directory that you determined in step 1, one per line, replacing `WAS_INSTALL_DIR/profiles/profile-name` with the WebSphere Application Server variable reference `${USER_INSTALL_ROOT}`.
  - j. Do not set **Native library path**.
  - k. Click **Next**.
  - l. Click **Finish**.
  - m. The JDBC provider is created.
  - n. Click **Save**.
4. Create a data source for the runtime database:
  - a. Click **Resources > JDBC > Data Sources**.
  - b. Select the appropriate scope from the **Scope** combination box.
  - c. Click **New** to create a data source.
  - d. Set the **Data source name** to **Worklight Database**.
  - e. Set **JNDI Name** to **jdbc/WorklightDS**.
  - f. Click **Next**.
  - g. Enter properties for the data source, for example:
    - **Driver type:** 4
    - **Database Name:** WRKLGHT

- **Server name:** localhost
  - **Port number:** 50000 (default)
- Leave **Use this data source in (CMP)** selected.
- h. Click **Next**.
  - i. Create **JAAS-J2C** authentication data, specifying the DB2 user name and password as its properties. If necessary, go back to the data source creation wizard, by repeating steps 4a on page 10-21 to 4h.
  - j. Select the authentication alias that you created in the **Component-managed authentication alias** combination box (not in the **Container-managed authentication alias** combination box).
  - k. Click **Next** and **Finish**.
  - l. Click **Save**.
  - m. In **Resources > JDBC > Data sources**, select the new data source.
  - n. Click **WebSphere Application Server data source properties**.
  - o. Select the **Non-transactional data source** check box.
  - p. Click **OK**.
  - q. Click **Save**.
  - r. Click **Custom properties** for the data source, select property **currentSchema**, and set the value to the schema used to create the data source tables (WRKSCHM and WLRESCHM in this example).
5. Create a data source for the reports database:
    - a. Click **Resources > JDBC > Data Sources**.
    - b. Select the appropriate scope from the **Scope** combination box.
    - c. Click **New** to create a data source.
    - d. Set the **Data source name** to **Worklight Reports Database**.
    - e. Set **JNDI Name** to **jdbc/WorklightReportsDS**.
    - f. Click **Next**.
    - g. Enter properties for the data source, for example:
      - **Driver type:** 4
      - **Database Name:** WLREPORT
      - **Server name:** localhost
      - **Port number:** 50000 (default)
 Leave **Use this data source in (CMP)** selected.
    - h. Click **Next**.
    - i. If you need a different DB2 user name and password for the reports database than for the runtime database, create **JAAS-J2C** authentication data, specifying the DB2 user name and password as its properties. If necessary, go back to the data source creation wizard, by repeating steps 5a to 5h.
    - j. Select the authentication alias that you created in the **Component-managed authentication alias** combination box (not in the **Container-managed authentication alias** combination box).
    - k. Click **Next** and **Finish**.
    - l. Click **Save**.
    - m. In **Resources > JDBC > Data sources**, select the new data source.
    - n. Click **WebSphere Application Server data source properties**.
    - o. Select the **Non-transactional data source** check box.
    - p. Click **OK**.

- q. Click **Save**.
  - r. Click **Custom properties** for the data source, select property **currentSchema**, and set the value to the schema used to create the data source tables (WRKSCHM and WLRESCHM in this example).
6. Test the data source connection by selecting each **Data Source** and clicking **Test Connection**.
  7. For WebSphere Application Server Network Deployment, click **System administration** > **Nodes**, select the nodes, and click **Full Synchronize**.

*Configuring Apache Tomcat for DB2 manually:*

If you want to manually set up and configure your DB2 database with Apache Tomcat server, use the following procedure.

### About this task

**Note:** The Reports database (WLREPORT below) is deprecated in IBM MobileFirst Platform Foundation for iOS V7.0.0. Use “Operational analytics” on page 12-8 instead. Note that setting up the Reports database is optional in this release and prior releases.

Complete the DB2 Database Setup procedure before continuing.

### Procedure

1. Add the DB2 JDBC driver JAR file to \$TOMCAT\_HOME/lib.  
You can retrieve the file in one of two ways:
  - Download it from DB2 JDBC Driver Versions
  - Fetch it from the *db2\_install\_dir/java* directory on the DB2 server.
2. Prepare an XML statement that defines the data source, as shown in the following code example. Insert this statement in the *server.xml* file, as indicated in “Configuring Apache Tomcat manually” on page 10-46.

```
<Resource auth="Container"
  driverClassName="com.ibm.db2.jcc.DB2Driver"
  name="jdbc/WorklightDS"
  username="worklight"
  password="password"
  type="javax.sql.DataSource"
  url="jdbc:db2://db2server:50000/WRKLGHT:currentSchema=WRKSCHM;"/>
<Resource auth="Container"
  driverClassName="com.ibm.db2.jcc.DB2Driver"
  name="jdbc/WorklightReportsDS"
  username="worklight"
  password="password"
  type="javax.sql.DataSource"
  url="jdbc:db2://db2server:50000/WLREPORT:currentSchema=WLRESCHM;"/>
```

Where **worklight** after **username=** is the name of the system user with "CONNECT" access to the **WRKLGHT** and **WLREPORT** databases that you previously created, and **password** after **password=** is this user's password. If you have defined either a different user name, or a different password, or both, replace **worklight** accordingly. Also, replace **db2server** with the host name of your DB2 server (for example, localhost, if it is on the same machine).

**Note:** The database user that is provided in this step does not need extended privileges on the databases. If you need to implement restrictions on the database, you can set here a user that has the restricted privileges that are

listed in “Restricting database user permissions for IBM MobileFirst Platform Server runtime operations” on page 6-20.

DB2 has a user name and password length limit of 8 characters for UNIX and Linux systems, and 30 characters for Windows.

*Configuring the Apache Derby databases manually:*

You configure the Apache Derby databases manually by creating the databases and database tables, and then configuring the relevant application server to use this database setup.

### **Procedure**

1. Create the databases and the tables within them. This step is described in “Setting up your Apache Derby databases manually.”
2. Configure the application server to use this database setup. Go to one of the following topics:
  - “Configuring Liberty Profile for Derby manually” on page 10-25
  - “Configuring WebSphere Application Server for Derby manually” on page 10-25
  - “Configuring Apache Tomcat for Derby manually” on page 10-28

*Setting up your Apache Derby databases manually:*

You can set up your Apache Derby database manually instead of by running Ant tasks.

### **About this task**

**Note:** The Reports database (WLREPORT below) is deprecated in IBM MobileFirst Platform Foundation for iOS V7.0.0. Use “Operational analytics” on page 12-8 instead. Note that setting up the Reports database is optional in this release and prior releases.

Set up your Apache Derby database by creating the database schema.

### **Procedure**

1. In the location where you want the database to be created, run `ij.bat` on Windows systems or `ij.sh` on UNIX and Linux systems.

**Note:** The `ij` program is part of Apache Derby. If you do not already have it installed, you can download it from Apache Derby: Downloads.

For supported versions of Apache Derby, see “System requirements” on page 2-7.

The script displays `ij` version number.

2. At the command prompt, enter the following commands:

```
connect 'jdbc:derby:WRKLIGHT;user=WORKLIGHT;create=true';
run 'product_install_dir/WorklightServer/databases/create-worklight-derby.sql';
connect 'jdbc:derby:WLREPORT;user=WORKLIGHT;create=true';
run 'product_install_dir/WorklightServer/databases/create-worklightreports-derby.sql';
quit;
```

### *Configuring Liberty Profile for Derby manually:*

If you want to manually set up and configure your Apache Derby database with WebSphere Application Server Liberty Profile, use the following procedure.

#### **About this task**

**Note:** The Reports database (WLREPORT below) is deprecated in IBM MobileFirst Platform Foundation for iOS V7.0.0. Use “Operational analytics” on page 12-8 instead. Note that setting up the Reports database is optional in this release and prior releases.

Complete the Apache Derby database setup procedure before continuing.

#### **Procedure**

Configure the data source in the \$LIBERTY\_HOME/usr/servers/worklightServer/server.xml file (worklightServer may be replaced in this path by the name of your server) as follows:

```
<!-- Declare the jar files for Derby access through JDBC. -->
<library id="derbyLib">
  <fileset dir="C:/Drivers/derby" includes="derby.jar" />
</library>

<!-- Declare the Worklight Server project database -->
<dataSource jndiName="worklight/jdbc/WorklightDS" transactional="false" statementCacheSize="10">
  <jdbcDriver libraryRef="derbyLib"
    javax.sql.ConnectionPoolDataSource="org.apache.derby.jdbc.EmbeddedConnectionPoolDataSource40"/>
  <properties.derby.embedded databaseName="DERBY_DATABASES_DIR/WRKLGHT" user="WORKLIGHT"
    shutdownDatabase="false" connectionAttributes="upgrade=true"/>
  <connectionManager connectionTimeout="180"
    maxPoolSize="10" minPoolSize="1"
    reapTime="180" maxIdleTime="1800"
    agedTimeout="7200" purgePolicy="EntirePool" />
</dataSource>

<!-- Declare the Worklight Server reports database -->
<dataSource jndiName="worklight/jdbc/WorklightReportsDS" transactional="false" statementCacheSize="10">
  <jdbcDriver libraryRef="derbyLib"
    javax.sql.ConnectionPoolDataSource="org.apache.derby.jdbc.EmbeddedConnectionPoolDataSource40"/>
  <properties.derby.embedded databaseName="DERBY_DATABASES_DIR/WLREPORT" user="WORKLIGHT"
    shutdownDatabase="false" connectionAttributes="upgrade=true"/>
  <connectionManager connectionTimeout="180"
    maxPoolSize="10" minPoolSize="1"
    reapTime="180" maxIdleTime="1800"
    agedTimeout="7200" purgePolicy="EntirePool" />
</dataSource>
```

The jndiName attributes must depend on the context root that you select for the MobileFirst Server application, following the instructions in “Configuring the Liberty profile manually” on page 10-40. If the context root is /app\_context, use jndiName="app\_context/jdbc/WorklightDS" and jndiName="app\_context/jdbc/WorklightReportsDS" respectively.

### *Configuring WebSphere Application Server for Derby manually:*

You can set up and configure your Apache Derby database manually with WebSphere Application Server.

## About this task

**Note:** The Reports database (WLREPORT below) is deprecated in IBM MobileFirst Platform Foundation for iOS V7.0.0. Use “Operational analytics” on page 12-8 instead. Note that setting up the Reports database is optional in this release and prior releases.

Complete the Apache Derby database setup procedure before continuing.

## Procedure

1. Determine a suitable directory for the JDBC driver JAR file in the WebSphere Application Server installation directory.
  - For a standalone server, you can use a directory such as `WAS_INSTALL_DIR/optionalLibraries/IBM/project-name/derby`.
  - For deployment to a WebSphere Application Server Network Deployment cell, use `WAS_INSTALL_DIR/profiles/profile-name/config/cells/cell-name/project-name/derby`.
  - For deployment to a WebSphere Application Server Network Deployment cluster, use `WAS_INSTALL_DIR/profiles/profile-name/config/cells/cell-name/clusters/cluster-name/project-name/derby`.
  - For deployment to a WebSphere Application Server Network Deployment node, use `WAS_INSTALL_DIR/profiles/profile-name/config/cells/cell-name/nodes/node-name/project-name/derby`.
  - For deployment to a WebSphere Application Server Network Deployment server, use `WAS_INSTALL_DIR/profiles/profile-name/config/cells/cell-name/nodes/node-name/servers/server-name/project-name/derby`.

If the directory for the JDBC driver JAR file does not exist, you must create it.

2. Add the Derby JAR file from `product_install_dir/ApplicationCenter/tools/lib/derby.jar` to the directory that you determined in step 1.
3. Set up the JDBC provider.
  - a. In the WebSphere Application Server console, click **Resources > JDBC > JDBC Providers**.
  - b. Select the appropriate scope from the **Scope** combination box.
  - c. Click **New**.
  - d. Set **Database type** to **User-defined**.
  - e. Set **Class Implementation name** to `org.apache.derby.jdbc.EmbeddedConnectionPoolDataSource40`.
  - f. Set **Name** to **Worklight - Derby JDBC Provider**.
  - g. Set **Description** to **Derby JDBC provider for Worklight**.
  - h. Click **Next**.
  - i. Set the **Class path** to the JAR file in the directory that you determined in step 1, replacing `WAS_INSTALL_DIR/profiles/profile-name` with the WebSphere Application Server variable reference `${USER_INSTALL_ROOT}`.
  - j. Click **Finish**.
4. Create the data source for the runtime database.
  - a. In the WebSphere Application Server console, click **Resources > JDBC > Data sources**.
  - b. Select the appropriate scope from the **Scope** combination box.
  - c. Click **New**.
  - d. Set **Data source Name** to **Worklight Database**.

- e. Set **JNDI name** to jdbc/WorklightDS.
  - f. Click **Next**.
  - g. Select the existing JDBC provider that is named **Worklight - Derby JDBC Provider**.
  - h. Click **Next**.
  - i. Click **Next**.
  - j. Click **Finish**.
  - k. Click **Save**.
  - l. In the table, click the **Worklight Database** data source that you created.
  - m. Under **Additional Properties**, click **Custom properties**.
  - n. Click **databaseName**.
  - o. Set **Value** to the path to the WRKLGHT database that is created by the configuredatabase ant task.
  - p. Click **OK**.
  - q. Click **Save**.
  - r. At the top of the page, click **Worklight Database**.
  - s. Under **Additional Properties**, click **WebSphere Application Server data source properties**.
  - t. Select **Non-transactional datasource**.
  - u. Click **OK**.
  - v. Click **Save**.
  - w. In the table, select the **Worklight Database** data source that you created.
  - x. Click **test connection** (only if you are not on the console of a WAS Deployment Manager).
5. Set up the data source for the reports database.
- a. In the WebSphere Application Server console, click **Resources > JDBC > Data sources**.
  - b. Select the appropriate scope from the **Scope** combination box.
  - c. Click **New**.
  - d. Set **Data source name** to **Worklight Reports Database**.
  - e. Set **JNDI name** to jdbc/WorklightReportsDS.
  - f. Click **Next**.
  - g. Select the existing JDBC provider that is named **Worklight - Derby JDBC Provider**.
  - h. Click **Next**.
  - i. Click **Next**.
  - j. Click **Finish**.
  - k. Click **Save**.
  - l. In the table, click the **Worklight Reports Database** data source that you created.
  - m. Under **Additional properties**, click **Custom properties**.
  - n. Click **databaseName**.
  - o. Set **Value** to the path to the WLREPORT database that is created by the configuredatabase ant task.
  - p. Click **OK**.
  - q. Click **Save**.

- r. At the top of the page, click **Worklight Reports Database**.
  - s. Under **Additional Properties**, click **WebSphere Application Server data source properties**.
  - t. Select **Non-transactional datasource**.
  - u. Click **OK**.
  - v. Click **Save**.
  - w. In the table, select the **Worklight Reports Database** data source that you created.
  - x. Optional: Only if you are not on the console of a WebSphere Application Server Deployment Manager, click **test connection**.
6. For WebSphere Application Server Network Deployment, click **System administration > Nodes**, select the nodes, and click **Full Synchronize**.

*Configuring Apache Tomcat for Derby manually:*

If you want to manually set up and configure your Apache Derby database with the Apache Tomcat server, use the following procedure.

### About this task

**Note:** The Reports database (WLREPORT below) is deprecated in IBM MobileFirst Platform Foundation for iOS V7.0.0. Use “Operational analytics” on page 12-8 instead. Note that setting up the Reports database is optional in this release and prior releases.

Complete the Apache Derby database setup procedure before continuing.

### Procedure

1. Add the Derby JAR file from *product\_install\_dir/ApplicationCenter/tools/lib/derby.jar* to the directory `$TOMCAT_HOME/lib`.
2. Prepare an XML statement that defines the data source, as shown in the following code example. Insert this statement in the `server.xml` file, as indicated in “Configuring Apache Tomcat manually” on page 10-46.

```
<Resource auth="Container"
  driverClassName="org.apache.derby.jdbc.EmbeddedDriver"
  name="jdbc/WorklightDS"
  username="WORKLIGHT"
  password=""
  type="javax.sql.DataSource"
  url="jdbc:derby:DERBY_DATABASES_DIR/WRKLGHT"/>
<Resource auth="Container"
  driverClassName="org.apache.derby.jdbc.EmbeddedDriver"
  name="jdbc/WorklightReportsDS"
  username="WORKLIGHT"
  password=""
  type="javax.sql.DataSource"
  url="jdbc:derby:DERBY_DATABASES_DIR/WLREPORT"/>
```

*Configuring the MySQL databases manually:*

You configure the MySQL databases manually by creating the databases, creating the database tables, and then configuring the relevant application server to use this database setup.



## Procedure

1. Create the databases. This step is described in “Creating the MySQL databases” on page 10-7.
2. Create the tables in the databases. This step is described in “Setting up your MySQL databases manually.”
3. Perform the application server-specific setup as the following list shows.

*Setting up your MySQL databases manually:*

You can set up the database manually instead of using the Ant tasks.

## About this task

**Note:** The Reports database (WLREPORT below) is deprecated in IBM MobileFirst Platform Foundation for iOS V7.0.0. Use “Operational analytics” on page 12-8 instead. Note that setting up the Reports database is optional in this release and prior releases.

Complete the following procedure to set up your MySQL databases.

## Procedure

1. Create the database schema.
  - a. Run a MySQL command line client with the option `-u root`.
  - b. Enter the following commands:

```
CREATE DATABASE WRKLGHT CHARACTER SET utf8 COLLATE utf8_general_ci;
GRANT ALL PRIVILEGES ON WRKLGHT.* TO 'worklight'@'Worklight-host' IDENTIFIED BY 'worklight';
GRANT ALL PRIVILEGES ON WRKLGHT.* TO 'worklight'@'localhost' IDENTIFIED BY 'worklight';
FLUSH PRIVILEGES;
CREATE DATABASE WLREPORT CHARACTER SET utf8 COLLATE utf8_general_ci;
GRANT ALL PRIVILEGES ON WLREPORT.* TO 'worklight'@'Worklight-host' IDENTIFIED BY 'worklight';
GRANT ALL PRIVILEGES ON WLREPORT.* TO 'worklight'@'localhost' IDENTIFIED BY 'worklight';
FLUSH PRIVILEGES;
```

```
USE WRKLGHT;
SOURCE product_install_dir/WorklightServer/databases/create-worklight-mysql.sql;
```

```
USE WLREPORT;
SOURCE product_install_dir/WorklightServer/databases/create-worklightreports-mysql.sql;
```

Where **worklight** before the "at" sign (@) is the user name, **worklight** after **IDENTIFIED BY** is its password, and **Worklight-host** is the name of the host on which IBM MobileFirst Platform Foundation for iOS runs.

2. Add the following property to your MySQL option file:  
`max_allowed_packet=256M`  
For more information about `max_allowed_packet`, see the MySQL documentation, section Packet Too Large.
3. Add the following property to your MySQL option file: `innodb_log_file_size = 250M`  
For more information about `innodb_log_file_size`, see the MySQL documentation, section `innodb_log_file_size`.  
For more information about option files, see the MySQL documentation.

*Configuring Liberty profile for MySQL manually:*

If you want to manually set up and configure your MySQL database with WebSphere Application Server Liberty profile, use the following procedure.

## Before you begin

**Note:** The Reports database (WLREPORT below) is deprecated in IBM MobileFirst Platform Foundation for iOS V7.0.0. Use “Operational analytics” on page 12-8 instead. Note that setting up the Reports database is optional in this release and prior releases.

Complete the MySQL database setup procedure before continuing.

### Procedure

1. Add the MySQL JDBC driver JAR file to \$LIBERTY\_HOME/wlp/usr/shared/resources/mysql. If that directory does not exist, create it.
2. Configure the data source in the \$LIBERTY\_HOME/usr/servers/worklightServer/server.xml file (worklightServer may be replaced in this path by the name of your server) as follows:

```
<!-- Declare the jar files for MySQL access through JDBC. -->
<library id="MySQLLib">
  <fileset dir="{shared.resource.dir}/mysql" includes="*.jar"/>
</library>

<!-- Declare the Worklight Server project database -->
<dataSource jndiName="worklight/jdbc/WorklightDS" transactional="false">
  <jdbcDriver libraryRef="MySQLLib"/>
  <properties databaseName="WRKLGHT"
    serverName="mysqlserver" portNumber="3306"
    user="worklight" password="password"/>
</dataSource>

<!-- Declare the Worklight Server reports database -->
<dataSource jndiName="worklight/jdbc/WorklightReportsDS" transactional="false">
  <jdbcDriver libraryRef="MySQLLib"/>
  <properties databaseName="WLREPORT"
    serverName="mysqlserver" portNumber="3306"
    user="worklight" password="password"/>
</dataSource>
```

Where **worklight** after **user=** is the user name, **password** after **password=** is this user's password, and **mysqlserver** is the host name of your MySQL server. If you have defined either a different user name, or a different password, or both, replace these entries accordingly. Also, replace **mysqlserver** with the host name of your MySQL server (for example, localhost, if it is on the same machine).

**Note:** The database user that is provided in this step does not need extended privileges on the databases. If you need to implement restrictions on the database, you can set here a user that has the restricted privileges that are listed in “Restricting database user permissions for IBM MobileFirst Platform Server runtime operations” on page 6-20.

The jndiName attributes must depend on the context root that you select for the MobileFirst Server application, following the instructions in “Configuring the Liberty profile manually” on page 10-40. If the context root is /app\_context, use jndiName="app\_context/jdbc/WorklightDS" and jndiName="app\_context/jdbc/WorklightReportsDS" respectively.

3. You can encrypt the database password with the securityUtility program in <liberty\_install\_dir>/bin.

**Note:** You have one password for each database: runtime (by default WRKLGHT) and reports (by default WLREPORT).

*Configuring WebSphere Application Server for MySQL manually:*

If you want to manually set up and configure your MySQL database for Application Center with WebSphere Application Server, use the following procedure.

### **About this task**

**Note:** The Reports database (WLREPORT below) is deprecated in IBM MobileFirst Platform Foundation for iOS V7.0.0. Use “Operational analytics” on page 12-8 instead. Note that setting up the Reports database is optional in this release and prior releases.

Complete the MySQL database setup procedure before continuing.

**Note:** MySQL in combination with WebSphere Application Server Liberty profile or WebSphere Application Server full profile is not classified as a supported configuration. For more information, see WebSphere Application Server Support Statement. We suggest that you use IBM DB2 or another database supported by WebSphere Application Server to benefit from a configuration that is fully supported by IBM Support.

### **Procedure**

1. Determine a suitable directory for the JDBC driver JAR file in the WebSphere Application Server installation directory.
  - For a standalone server, you can use a directory such as `WAS_INSTALL_DIR/optionalLibraries/IBM/project-name/mysql`.
  - For deployment to a WebSphere Application Server Network Deployment cell, use `WAS_INSTALL_DIR/profiles/profile-name/config/cells/cell-name/project-name/mysql`.
  - For deployment to a WebSphere Application Server Network Deployment cluster, use `WAS_INSTALL_DIR/profiles/profile-name/config/cells/cell-name/clusters/cluster-name/project-name/mysql`.
  - For deployment to a WebSphere Application Server Network Deployment node, use `WAS_INSTALL_DIR/profiles/profile-name/config/cells/cell-name/nodes/node-name/project-name/mysql`.
  - For deployment to a WebSphere Application Server Network Deployment server, use `WAS_INSTALL_DIR/profiles/profile-name/config/cells/cell-name/nodes/node-name/servers/server-name/project-name/mysql`.

If the directory for the JDBC driver JAR file does not exist, you must create it.

2. Add the MySQL JDBC driver JAR file that you downloaded from Download Connector/J to the directory determined in step 1.
3. Set up the JDBC provider:
  - a. In the WebSphere Application Server console, click **Resources > JDBC > JDBC Providers**.
  - b. Select the appropriate scope from the **Scope** combination box.
  - c. Click **New**.
  - d. Create a **JDBC provider** named **MySQL**.
  - e. Set **Database type** to **User defined**.
  - f. Set **Scope** to **Cell**.
  - g. Set **Implementation class** to `com.mysql.jdbc.jdbc2.optional.MysqlConnectionPoolDataSource`.

- h. Set the **Class path** to the JAR file in the directory that you determined in step 1, replacing *WAS\_INSTALL\_DIR/profiles/profile-name* with the WebSphere Application Server variable reference `${USER_INSTALL_ROOT}`.
  - i. Save your changes.
4. Create a data source for the runtime database:
    - a. Click **Resources > JDBC > Data sources**.
    - b. Select the appropriate scope from the **Scope** combination box.
    - c. Click **New** to create a data source.
    - d. Type any name (for example, Worklight Database).
    - e. Set **JNDI Name** to `jdbc/WorklightDS`.
    - f. Use the existing **JDBC Provider MySQL**, defined in the previous step.
    - g. Set Scope to **New**.
    - h. On the **Configuration** tab, select **Non-transactional data source**.
    - i. Click **Next** a number of times, leaving all other settings as defaults.
    - j. Save your changes.
  5. Create a data source for the reports database:
    - a. Click **Resources > JDBC > Data sources**.
    - b. Select the appropriate scope from the **Scope** combination box.
    - c. Click **New** to create a data source.
    - d. Type any name (for example, Worklight Report Database).
    - e. Set **JNDI Name** to `jdbc/WorklightReportsDS`.
    - f. Use the existing **JDBC Provider MySQL**, defined in the previous step.
    - g. Set Scope to **New**.
    - h. On the **Configuration** tab, select **Non-transactional data source. New**.
    - i. Click **Next** a number of times, leaving all other settings as defaults.
    - j. Save your changes.
  6. Set the custom properties of each new data source.
    - a. Select the new data source.
    - b. Click **Custom properties**.
    - c. Set the following properties:
      - `portNumber = 3306`
      - `relaxAutoCommit=true`
      - `databaseName = WRKLGHT or WLREPORT` respectively
      - `serverName = the host name of the MySQL server`
      - `user = the user name of the MySQL server`
      - `password = the password associated with the user name`

**Note:** The database user that is listed in this step does not need extended privileges on the databases. If you need to implement restrictions on the database, you can set here a user that has the restricted privileges that are listed in "Restricting database user permissions for IBM MobileFirst Platform Server runtime operations" on page 6-20.
  7. Set the WAS custom properties of each new data source.
    - a. In **Resources > JDBC > Data sources**, select the new data source.
    - b. Click **WebSphere Application Server data source properties**.
    - c. Select the **Non-transactional data source** check box.
    - d. Click **OK**.
    - e. Click **Save**.

8. For WebSphere Application Server Network Deployment, click **System administration** > **Nodes**, select the nodes, and click **Full Synchronize**.

*Configuring Apache Tomcat for MySQL manually:*

If you want to manually set up and configure your MySQL database with the Apache Tomcat server, use the following procedure.

#### **About this task**

**Note:** The Reports database (WLREPORT below) is deprecated in IBM MobileFirst Platform Foundation for iOS V7.0.0. Use “Operational analytics” on page 12-8 instead. Note that setting up the Reports database is optional in this release and prior releases.

Complete the MySQL database setup procedure before continuing.

#### **Procedure**

1. Add the MySQL Connector/J JAR file to the \$TOMCAT\_HOME/lib directory.
2. Prepare an XML statement that defines the data source, as shown in the following code example. Insert this statement in the server.xml file, as indicated in “Configuring Apache Tomcat manually” on page 10-46.

```
<Resource name="jdbc/WorklightDS"
  auth="Container"
  type="javax.sql.DataSource"
  maxActive="100"
  maxIdle="30"
  maxWait="10000"
  username="worklight"
  password="worklight"
  driverClassName="com.mysql.jdbc.Driver"
  url="jdbc:mysql://mysqlserver:3306/WRKLGHT"/>
<Resource name="jdbc/WorklightReportsDS"
  auth="Container"
  type="javax.sql.DataSource"
  maxActive="100"
  maxIdle="30"
  maxWait="10000"
  username="worklight"
  password="worklight"
  driverClassName="com.mysql.jdbc.Driver"
  url="jdbc:mysql://mysqlserver:3306/WLREPORT"/>
```

Where **worklight** after **username=** is the user name of the MySQL server, **worklight** after **password=** is this user's password, and **mysqlserver** is the host name of your MySQL server (for example, localhost, if it is on the same machine).

**Note:** The database user that is listed in this step does not need extended privileges on the databases. If you need to implement restrictions on the database, you can set here a user that has the restricted privileges that are listed in “Restricting database user permissions for IBM MobileFirst Platform Server runtime operations” on page 6-20.

*Configuring the Oracle databases manually:*

You configure the Oracle databases manually by creating the databases, creating the database tables, and then configuring the relevant application server to use this database setup.

## Procedure

1. Create the databases. This step is described in “Creating the Oracle databases” on page 10-8.
2. Create the tables in the databases. This step is described in “Setting up your Oracle databases manually.”
3. Perform the application server-specific setup as the following list shows.

*Setting up your Oracle databases manually:*

You can set up the database manually instead of using Ant tasks.

## About this task

**Note:** The Reports database (WLREPORTS below) is deprecated in IBM MobileFirst Platform Foundation for iOS V7.0.0. Use “Operational analytics” on page 12-8 instead. Note that setting up the Reports database is optional in this release and prior releases.

Complete the following procedure to set up your Oracle databases.

## Procedure

1. Ensure that you have at least one Oracle database.  
In many Oracle installations, the default database has the SID (name) ORCL. For best results, set the character set of the database to **Unicode (AL32UTF8)**.  
If the Oracle installation is on a UNIX or Linux computer, make sure that the database is started the next time the Oracle installation is restarted. To this effect, make sure that the line in /etc/oratab that corresponds to the database ends with a Y, not with an N.
2. Create the user WORKLIGHT, either by using Oracle Database Control, or by using the Oracle SQLPlus command-line interpreter.
  - To create the user for the runtime database/schema (by default Worklight), by using Oracle Database Control, proceed as follows:
    - a. Connect as SYSDBA.
    - b. Go to the Users page.
    - c. Click **Server**, then **Users** in the Security section.
    - d. Create a user, named WORKLIGHT with the following attributes:

```
Profile: DEFAULT
Authentication: password
Default tablespace: USERS
Temporary tablespace: TEMP
Status: Unlocked
Add system privilege: CREATE SESSION
Add system privilege: CREATE SEQUENCE
Add system privilege: CREATE TABLE
Add quota: Unlimited for tablespace USERS
```
    - e. Repeat the previous step to create the user WORKLIGHTREPORTS for the reports database/schema and a user WORKLIGHT for the runtime database/schema.
  - To create the two users by using Oracle SQLPlus, enter the following commands:

```
CONNECT SYSTEM/SYSTEM_password@ORCL
CREATE USER WORKLIGHT IDENTIFIED BY WORKLIGHT_password DEFAULT TABLESPACE USERS QUOTA UNLIMITED ON USERS;
GRANT CREATE SESSION, CREATE SEQUENCE, CREATE TABLE TO WORKLIGHT;
DISCONNECT;
```

```
CONNECT SYSTEM/SYSTEM_password@ORCL
CREATE USER WORKLIGHTREPORTS IDENTIFIED BY WORKLIGHTREPORTS_password DEFAULT TABLESPACE USERS QUOTA UNLIMITED ON USERS;
GRANT CREATE SESSION, CREATE SEQUENCE, CREATE TABLE TO WORKLIGHTREPORTS;
DISCONNECT;
```

3. Create the database tables for the runtime database and reports database:

- a. Using the Oracle SQLPlus command-line interpreter, create the tables for the runtime database by running the create-worklight-oracle.sql file:

```
CONNECT WORKLIGHT/product_password@ORCL
@product_install_dir/WorklightServer/databases/create-worklight-oracle.sql
DISCONNECT;
```

- b. Using the Oracle SQLPlus command-line interpreter, create the tables for the reports database by running the create-worklightreports-oracle.sql file:

```
CONNECT WORKLIGHTREPORTS/<WORKLIGHTREPORTS_password>@ORCL
@product_install_dir/WorklightServer/databases/create-worklightreports-oracle.sql
DISCONNECT;
```

4. Download and configure the Oracle JDBC driver:

- a. Download the JDBC driver from the Oracle website at Oracle: JDBC, SQLJ, Oracle JPublisher and Universal Connection Pool (UCP).
- b. Ensure that the Oracle JDBC driver is in the system path. The driver file is ojdbc6.jar.

*Configuring Liberty Profile for Oracle manually:*

If you want to manually set up and configure your Oracle database with WebSphere Application Server Liberty profile, use the following procedure.

**Before you begin**

**Note:** The Reports database (WLREPORTS below) is deprecated in IBM MobileFirst Platform Foundation for iOS V7.0.0. Use “Operational analytics” on page 12-8 instead. Note that setting up the Reports database is optional in this release and prior releases.

Complete the Oracle database setup procedure before continuing.

**Procedure**

1. Add the Oracle JDBC Driver JAR file to \$LIBERTY\_HOME/wlp/usr/shared/resources/oracle. If that directory does not exist, create it.
2. If you are using JNDI, configure the data sources in the \$LIBERTY\_HOME/wlp/usr/servers/worklightServer/server.xml file (worklightServer may be replaced in this path by the name of your server) as shown in the following JNDI code example:

```
<!-- Declare the jar files for Oracle access through JDBC. -->
<library id="OracleLib">
  <fileset dir="{shared.resource.dir}/oracle" includes="*.jar"/>
</library>

<!-- Declare the Worklight Server project database -->
<dataSource jndiName="worklight/jdbc/WorklightDS" transactional="false">
  <jdbcDriver libraryRef="OracleLib"/>
  <properties.oracle driverType="thin" databaseName="ORCL"
    serverName="oserver" portNumber="1521"
    user="WORKLIGHT" password="WORKLIGHT_password"/>
</dataSource>
```

```

<!-- Declare the Worklight Server reports database -->
<dataSource jndiName="worklight/jdbc/WorklightReportsDS" transactional="false">
  <jdbcDriver libraryRef="OracleLib"/>
  <properties.oracle driverType="thin" databaseName="ORCL"
    serverName="oserver" portNumber="1521"
    user="WORKLIGHTREPORTS" password="WORKLIGHTREPORTS_password"/>
</dataSource>

```

Where **WORKLIGHT** and **WORKLIGHTREPORTS** after **user=** are the names of the users with "CONNECT" access to the **WRKLGHT** and **WLREPORT** databases that you previously created, and **password** after **password=** are this users' passwords. If you defined either different user names, or different passwords, or both, replace these entries accordingly. Also, replace **oserver** with the host name of your Oracle server (for example, localhost, if it is on the same machine).

**Note:**

- For more information on how to connect the Liberty server to the Oracle database with a service name, or with a URL, see the WebSphere Application Server Liberty Core 8.5.5 documentation, section **properties.oracle**.
- The database users that are provided in this step do not need extended privileges on the databases. If you need to implement restrictions on the database, you can set here a user that has the restricted privileges that are listed in "Restricting database user permissions for IBM MobileFirst Platform Server runtime operations" on page 6-20.

The jndiName attributes must depend on the context root that you select for the MobileFirst Server application, following the instructions in "Configuring the Liberty profile manually" on page 10-40. If the context root is /app\_context, use jndiName="app\_context/jdbc/WorklightDS" and jndiName="app\_context/jdbc/WorklightReportsDS".

3. You can encrypt the database password with the securityUtility program in <liberty\_install\_dir>/bin.

**Note:** You have one password for each database: runtime (by default WRKLGHT) and reports (by default WLREPORT).

*Configuring WebSphere Application Server for Oracle manually:*

If you want to manually set up and configure your Oracle database with WebSphere Application Server, use the following procedure.

**About this task**

**Note:** The Reports database (WLREPORTS below) is deprecated in IBM MobileFirst Platform Foundation for iOS V7.0.0. Use "Operational analytics" on page 12-8 instead. Note that setting up the Reports database is optional in this release and prior releases.

Complete the Oracle database setup procedure before continuing.

**Procedure**

1. Determine a suitable directory for the JDBC driver JAR file in the WebSphere Application Server installation directory.
  - For a standalone server, you can use a directory such as `WAS_INSTALL_DIR/optionalLibraries/IBM/project-name/oracle`.



- For deployment to a WebSphere Application Server Network Deployment cell, use `WAS_INSTALL_DIR/profiles/profile-name/config/cells/cell-name/project-name/oracle`.
- For deployment to a WebSphere Application Server Network Deployment cluster, use `WAS_INSTALL_DIR/profiles/profile-name/config/cells/cell-name/clusters/cluster-name/project-name/oracle`.
- For deployment to a WebSphere Application Server Network Deployment node, use `WAS_INSTALL_DIR/profiles/profile-name/config/cells/cell-name/nodes/node-name/project-name/oracle`.
- For deployment to a WebSphere Application Server Network Deployment server, use `WAS_INSTALL_DIR/profiles/profile-name/config/cells/cell-name/nodes/node-name/servers/server-name/project-name/oracle`.

If the directory for the JDBC driver JAR file does not exist, you must create it.

2. Add the Oracle `ojdbc6.jar` file downloaded from JDBC and Universal Connection Pool (UCP) to the directory that you determined in step 1.
3. Set up the JDBC provider:
  - a. In the WebSphere Application Server console, click **Resources > JDBC > JDBC Providers**.
  - b. Select the appropriate scope from the **Scope** combination box.
  - c. Click **New**.
  - d. Complete the JDBC Provider fields as indicated in the following table:

Table 10-3. JDBC Provider field values

Field	Value
Database type	Oracle
Provider type	Oracle JDBC Driver
Implementation type	Connection pool data source
Name	Oracle JDBC Driver

- e. Click **Next**.
  - f. Set the **Class path** to the JAR file in the directory that you determined in step 1, replacing `WAS_INSTALL_DIR/profiles/profile-name` with the WebSphere Application Server variable reference `${USER_INSTALL_ROOT}`.
  - g. Click **Next**.  
The JDBC provider is created.
4. Create a data source for the runtime database:
  - a. Click **Resources > JDBC > Data sources**.
  - b. Select the appropriate scope from the **Scope** combination box.
  - c. Click **New**.
  - d. Set **Data source name** to **Oracle JDBC Driver DataSource**.
  - e. Set **JNDI name** to `jdbc/WorklightDS`.
  - f. Click **Next**.
  - g. Click **Select an existing JDBC provider** and select **Oracle JDBC driver** from the list.
  - h. Click **Next**.
  - i. Set the URL value to `jdbc:oracle:thin:@oserver:1521:ORCL`, where **oserver** is the host name of your Oracle server (for example, localhost, if it is on the same machine).
  - j. Click **Next** twice.

- k. Click **Resources > JDBC > Data sources > Oracle JDBC Driver DataSource > Custom properties**.
  - l. Set **oracleLogPackageName** to **oracle.jdbc.driver**.
  - m. Set **user** = **WORKLIGHT**.
  - n. Set **password** = **WORKLIGHT\_password**.
  - o. Click **OK** and save the changes.
  - p. In **Resources > JDBC > Data sources**, select the new data source.
  - q. Click **WebSphere Application Server data source properties**.
  - r. Select **Non-transactional data source**.
  - s. Click **OK**.
  - t. Click **Save**.
5. Create a data source for the reports database, following the instructions in step 2, but using the JNDI name **jdbc/WorklightReportsDS** and the user name **WORKLIGHTREPORTS** and its corresponding password.

**Note:** The database users **WORKLIGHT** and **WORKLIGHTREPORTS** that are provided in this step do not need extended privileges on the databases. If you need to implement restrictions on the database, you can set here a user that has the restricted privileges that are listed in “Restricting database user permissions for IBM MobileFirst Platform Server runtime operations” on page 6-20.

6. For WebSphere Application Server Network Deployment, click **System administration > Nodes**, select the nodes, and click **Full Synchronize**.

*Configuring Apache Tomcat for Oracle manually:*

If you want to manually set up and configure your Oracle database with the Apache Tomcat server, use the following procedure.

### About this task

**Note:** The Reports database (WLREPORTS below) is deprecated in IBM MobileFirst Platform Foundation for iOS V7.0.0. Use “Operational analytics” on page 12-8 instead. Note that setting up the Reports database is optional in this release and prior releases.

Complete the Oracle database setup procedure before continuing.

### Procedure

1. Add the Oracle JDBC driver JAR file to the directory **\$TOMCAT\_HOME/lib**.
2. Prepare an XML statement that defines the data source, as shown in the following code example. Insert this statement in the **server.xml** file, as indicated in “Configuring Apache Tomcat manually” on page 10-46.

```
<Resource name="jdbc/WorklightDS"
  auth="Container"
  type="javax.sql.DataSource"
  driverClassName="oracle.jdbc.driver.OracleDriver"
  url="jdbc:oracle:thin:@oserver:1521:ORCL"
  username="WORKLIGHT"
  password="WORKLIGHT_password"/>
<Resource name="jdbc/WorklightReportsDS"
  auth="Container"
  type="javax.sql.DataSource"
  driverClassName="oracle.jdbc.driver.OracleDriver"
```

```
url="jdbc:oracle:thin:@oserver:1521:ORCL"
username="WORKLIGHTREPORTS"
password="WORKLIGHTREPORTS_password"/>
```

Where **WORKLIGHT** and **WORKLIGHTREPORTS** after **username=** are the names of the users with "CONNECT" access to the **WRKLGHT** and **WLREPORT** databases that you previously created, and **password** after **password=** are this users' passwords. If you defined either different user names, or different passwords, or both, replace these entries accordingly. Also, replace **oserver** with the host name of your Oracle server (for example, localhost, if it is on the same machine).

**Note:** The database users that are provided in this step do not need extended privileges on the databases. If you need to implement restrictions on the database, you can set here a user that has the restricted privileges that are listed in "Restricting database user permissions for IBM MobileFirst Platform Server runtime operations" on page 6-20.

### Deploying a project WAR file and configuring the application server manually:

The procedure to manually deploy your app to an application server depends on the type of application server being configured, as detailed here. Depending on the version of the product that was used to build the project WAR file and the version of MobileFirst Server, you might need to migrate the WAR file first.

When the version of IBM MobileFirst Platform Foundation for iOS produces a WAR file that is not compatible with the version of MobileFirst Server, you must migrate the project WAR file to the current MobileFirst Server version to ensure a successful manual deployment. All fix packs of a product version are compatible in that sense, and so you do not need to migrate associated project WAR files.

These manual configuration instructions assume that you are familiar with your application server.

**Note:** Using the Ant task to deploy the project WAR file and configure the application server is more reliable than installing and configuring manually, and should be used whenever possible.

*Migrating a project WAR file for use with a new MobileFirst Server:*

Use Ant tasks to migrate a project WAR file so that you can deploy it manually to a new version of MobileFirst Server.

You migrate a project WAR file by running a `<migrate>` Ant task, which is included in the `worklight-ant-deployer.jar` library. You can migrate `.war` files that are developed in V5.0.6 of this product and later. To run the Ant task, you invoke it from an Ant XML file similar to the following example:

```
<?xml version="1.0" encoding="UTF-8"?>
<project name="MigrateWarFile" default="migrate" basedir=".">
  <target name="migrate">
    <echo message="Loading Ant Tool" />
    <taskdef resource="com/worklight/ant/defaults.properties">
      <classpath>
        <pathelement location="worklight-ant-deployer.jar" />
      </classpath>
    </taskdef>
    <migrate sourceWarFile="d:/myOldWarFolder/myProject.war" destWarFile="d:/myNewWarFolder/myMigratedProject.war"/>
  </target>
</project>
```

The `<migrate>` task accepts the following input parameters:

**sourceWarFile**

(mandatory) The path to the source project WAR file. The path must not contain spaces.

**destWarFile**

(optional) The destination file for the migrated WAR file. Default value: `<source-war-folder>/migrated-to-<new version number>/<source-war-filename>`.

*Configuring the Liberty profile manually:*

To configure the WebSphere Application Server Liberty profile manually, you must modify the `server.xml` file and declarations for the runtime and the IBM MobileFirst Platform Operations Console.

**Before you begin**

See “Planning deployment of administration components and runtimes” on page 6-7 for the supported deployment topologies.

Review the environment IDs. Environment IDs are optional, but if you do specify one, the identifier must meet the following two conditions:

- Its value must be the same for each MobileFirst runtime environment that is managed by the same MobileFirst Server administration component.
- Its value must match the environment ID that is used when the MobileFirst Server administration component is installed.

The environment ID is defined as an application JNDI variable, prefixed by the context root of the application. See Step 5.

**About this task**

In addition to modifications for the databases that are described in “Creating and configuring the databases manually” on page 10-17, you must make the following modifications to the `server.xml` file.

**Note:** In the following procedure, when the example uses the `worklight.war` project file, use the name of your MobileFirst project, for example, `myProject.war`.

**Procedure**

1. In the installation directory of Liberty, open the *user data* directory.
  - If the installation directory of Liberty contains a `etc/server.env` file and if this file defines a `WLP_USER_DIR` variable, the *user data* directory is the value of this variable.
  - Otherwise, it is the `usr` directory in the installation directory of Liberty.
2. Copy the MobileFirst JAR file into the `shared/resources/lib/` directory that is in the *user data* directory.

If there is no `etc/server.env` file in the installation directory of Liberty, enter the following commands, according to your operating system:

- On UNIX and Linux:

```
mkdir -p WLP_DIR/usr/shared/resources/lib
cp product_install_dir/WorklightServer/worklight-jee-library.jar WLP_DIR/usr/shared/resources/lib
```

- On Windows:

```
mkdir WLP_DIR\usr\shared\resources\lib
copy /B product_install_dir\WorklightServer\worklight-jee-library.jar WLP_DIR\usr\shared\resources\
lib\worklight-jee-library.jar
```

3. Ensure that the `<featureManager>` element contains at least the following `<feature>` elements:

- For WebSphere Application Server Liberty profile V8.5.0.x:

```
<feature>ssl-1.0</feature>
<feature>servlet-3.0</feature>
<feature>jdbc-4.0</feature>
```

- For WebSphere Application Server Liberty profile V8.5.5.0 and later:

```
<feature>jdbc-4.0</feature>
<feature>servlet-3.0</feature>
<feature>ssl-1.0</feature>
```

4. Copy the `worklight.war` file to the `apps` directory of the Liberty server.

**Note:** The `apps` directory is in the same directory as the `server.xml` file.

5. Add the following declarations in the `<server>` element for the MobileFirst runtime and the MobileFirst Operations Console.

**Important:** The `id` attribute of the `privateLibrary` tag must identify a unique MobileFirst runtime. By convention, it takes this form: `<privateLibrary id="worklightlib_<context root">`

```
<!-- Declare the Worklight Server application. -->
<application id="worklight" name="worklight" location="worklight.war" type="war">
  <classloader delegation="parentLast">
    <privateLibrary id="worklightlib_worklight">
      <fileset dir="{shared.resource.dir}/lib" includes="worklight-jee-library.jar"/>
      <fileset dir="{wlp.install.dir}/lib" includes="com.ibm.ws.crypto.passwordutil_*.jar"/>
    </privateLibrary>
  </classloader>
</application>
```

```
<!-- Declare web container custom properties for the Worklight Server application. -->
<webContainer invokeFlushAfterService="false"/>
```

This declaration installs the MobileFirst Server application with the context root `/worklight`. If you want to assign a different context root `/app_context`, start the declaration with one of the following code snippets:

```
<application id="app_context" name="app_context" location="worklight.war" type="war">
```

Or:

```
<application id="worklight" name="worklight" location="worklight.war" context-root="/app_context" type="war">
```

In either case, also change the `privateLibrary` tag accordingly: `<privateLibrary id="worklightlib_app_context">`

6. If the database is Oracle, add the `commonLibraryRef` attribute to the class loader of the worklight runtime application.

```
...
<classloader delegation="parentLast" commonLibraryRef="OracleLib">
...
```

The name of the library reference (`OracleLib` in this example) must be the ID of the library that contains the JDBC JAR file. This ID is declared in the procedure that is documented in “Configuring Liberty profile for Oracle manually for MobileFirst Server administration” on page 6-69.

7. If the MobileFirst Server administration component uses an environment ID, declare that environment ID for MobileFirst Server application:

```
<jndiEntry jndiName="worklight/ibm.worklight.admin.environmentid" value="'ValueOfEnvironmentID'"/>
```

- worklight is the context root of the MobileFirst Server application. If you choose another value in previous step, replace worklight with that value.
- Replace ValueOfEnvironmentID with the value that is used for the MobileFirst Server administration component.

**Related tasks:**

“Configuring a MobileFirst project in production by using JNDI environment entries” on page 10-60

When you deploy a MobileFirst project to a MobileFirst Server, you can configure the project’s WAR file with JNDI environment entries to set product environment properties.

**Related information:**

 WebSphere Application Server documentation about Deploying application to the Liberty Profile

*Configuring WebSphere Application Server manually:*

To configure WebSphere Application Server manually, you must configure variables, custom properties, and class loader policies.

**Before you begin**

See “Planning deployment of administration components and runtimes” on page 6-7 for the supported deployment topologies.

**Find the SOAP port of the deployment manager (WebSphere Application Server Network Deployment only)**

These instructions assume that a stand-alone profile exists with an application server named “Worklight” and that the server is using the default ports.

For WebSphere Application Server Network Deployment, find the SOAP port of the deployment manager:

1. Open the System Administration/Deployment manager.
2. In Additional properties, open **Ports**.
3. Note the value of **SOAP\_CONNECTOR\_ADDRESS**. This value is needed to set the value of the **ibm.worklight.admin.jmx.dmgr.port** environment entry for the MobileFirst Administration Services.

**Review the environment IDs**

Specifying an environment ID is optional. However, if you specify an ID, use the same value for each MobileFirst runtime environment that is managed by the same MobileFirst Server administration component. Moreover, this value must match the environment ID that is used when the MobileFirst Server administration component is installed. For more information about the **ibm.worklight.admin.environmentid** JNDI property, see “Configuring a MobileFirst project in production by using JNDI environment entries” on page 10-60.

**Procedure**

1. Determine a suitable file name for the MobileFirst shared library in the WebSphere Application Server installation directory.

- For a standalone server, you can use a file name such as `WAS_INSTALL_DIR/optionalLibraries/IBM/project-name/worklight-jee-library.jar`.
- For deployment to a WebSphere Application Server Network Deployment cell, use `WAS_INSTALL_DIR/profiles/profile-name/config/cells/cell-name/project-name/worklight-jee-library.jar`.
- For deployment to a WebSphere Application Server Network Deployment cluster, use `WAS_INSTALL_DIR/profiles/profile-name/config/cells/cell-name/clusters/cluster-name/project-name/worklight-jee-library.jar`.
- For deployment to a WebSphere Application Server Network Deployment node, use `WAS_INSTALL_DIR/profiles/profile-name/config/cells/cell-name/nodes/node-name/project-name/worklight-jee-library.jar`.
- For deployment to a WebSphere Application Server Network Deployment server, use `WAS_INSTALL_DIR/profiles/profile-name/config/cells/cell-name/nodes/node-name/servers/server-name/project-name/worklight-jee-library.jar`.

If the directory does not exist, you must create it.

2. Copy the file `product_install_dir/WorklightServer/worklight-jee-library.jar` to the location that you determined in step 1.
3. Log on to the WebSphere Application Server administration console for your MobileFirst Server.  
The address is of the form `http://server.com:9060/ibm/console`, where *server* is the name of the server.
4. Create the MobileFirst shared library definition:
  - a. Click **Environment > Shared libraries**.
  - b. From the **Scope** list, select **Worklight server**.
  - c. Click **New**. The Configuration pane is displayed.
  - d. In the **Name** field, type `WL_PLATFORM_LIB`.
  - e. Optional: In the **Description** field, type a description of the library.
  - f. In the **Classpath** field, enter the file name that you determined in step 1, replacing `WAS_INSTALL_DIR/profiles/profile-name` with the WebSphere Application Server variable reference `${USER_INSTALL_ROOT}`.
  - g. In **Class Loading**, select the check box **Use an isolated class loader for this shared library**.
5. Create the MobileFirst JDBC data source and provider.  
See the instructions for the appropriate DBMS in “Creating and configuring the databases manually” on page 10-17.
6. Add a specific web container custom property.
  - a. Click **Servers > Server Types > Application Servers**, and select the server for IBM MobileFirst Platform Foundation for iOS.
  - b. Click **Web Container Settings > Web container**.
  - c. Click **Custom properties**.
  - d. Click **New**.
  - e. Enter the property values listed in the following table.

Table 10-4. Values for the web container custom property.

Property	Value
Name	<code>com.ibm.ws.webcontainer.invokeFlushAfterService</code>
Value	<code>false</code>

Table 10-4. Values for the web container custom property (continued).

Property	Value
Description	See <a href="http://www.ibm.com/support/docview.wss?uid=swg1PM50111">http://www.ibm.com/support/docview.wss?uid=swg1PM50111</a>

- f. Click **OK**.
- g. Click **Save**.
7. Install a MobileFirst project WAR file.

**Note:** In the following procedure, when the example uses `worklight.war`, use the name of your MobileFirst project, for example, `myProject.war`.

- a. Depending on your version of WebSphere Application Server, click one of the following options:
  - **Applications > New > New Enterprise Application**
  - **Applications > New Application > New Enterprise Application**
- b. Navigate to the MobileFirst Server installation directory `product_install_dir/WorklightServer`.
- c. Select `worklight.war`, and then click **Next**.
- d. On the "How do you want to install the application?" page, select **Detailed**, and then click **Next**.
- e. On the Application Security Warnings page, click **Continue**.
- f. Click **Continue** repeatedly until you reach Step 4 of the wizard: Map Shared Libraries.
- g. Select **Select** for `worklight_war` and click **Reference shared libraries**.
- h. From the Available list, select `WL_PLATFORM_LIB` and click **>**.
- i. Click **OK**.
- j. Click **Next** until you reach the "Map context roots for web modules" page.
- k. In the **Context Root** field, type `/worklight`.
- l. Click **Next**.
- m. In **Map environment Entries for Web Module**, you can assign the JNDI variables according to your configuration.
  - Set the variable `ibm.worklight.topology.platform` to WAS
  - Set the variable `ibm.worklight.admin.jmx.connector` to SOAP
  - If the environment ID is set for the Administration Services, set the variable `ibm.worklight.admin.environmentid` to the same value.
  - On a stand-alone WebSphere Application Server, set the value of `ibm.worklight.topology.clustermode` to Standalone
  - On WebSphere Application Server Network Deployment, set the variables as follows:
    - `ibm.worklight.topology.clustermode`: Cluster
    - `ibm.worklight.admin.jmx.dmgr.host`: the host name of the deployment manager
    - `ibm.worklight.admin.jmx.dmgr.port`: the SOAP port of the deployment manager
- n. Click **Finish**.
8. Optional: As an alternative to step 6, you can map the shared libraries as follows:



- a. Click **Applications > Application Types > WebSphere enterprise applications > worklight\_war**.
  - b. In the References section, click **Shared library references**.
  - c. Select **Select** for worklight\_war and click **Reference shared libraries**.
  - d. From the Available list, select WL\_PLATFORM\_LIB and click **>**.
  - e. Click **OK** twice to return to the worklight\_war configuration page.
  - f. Click the **Save** link.
9. Define the startup behavior.
- a. Click **Applications > Application Types > WebSphere enterprise applications > worklight\_war**.
  - b. Click **Startup behavior**.
  - c. In **Startup Order**, enter 2.

**Note:** The MobileFirst Administration service must already be available when the MobileFirst runtime starts.

10. Configure the class loader policies and then start the application:
- a. Click the **Manage Applications** link, or click **Applications > WebSphere Enterprise Applications**.
  - b. From the list of applications, click **worklight\_war**.
  - c. In the “Detail Properties” section, click the **Class loading and update detection** link.
  - d. In the “Class loader order” pane, click **Classes loaded with local class loader first (parent last)**.
  - e. Click **OK**.
  - f. In the Modules section, click **Manage Modules**.
  - g. From the list of modules, click the MobileFirst module.
  - h. In the “Class loader order” pane, click **Classes loaded with local class loader first (parent last)**.
  - i. Click **OK** twice.
  - j. Click **Save**.
  - k. Select **Select** for worklight\_war and click **Start**.
11. Review the server class loader policy: Click **Servers > Server Types > Application Servers > Worklight**
- If the class loader policy is set to **Multiple**, do nothing.
  - If the class loader policy is set to **Single** and the class loading mode is set to **parent-last**, do nothing.
  - If the class loader policy is set to **Single** and the class loading mode is set to **parent-first**, change the class loader policy to **Multiple**, and set the class loader order of all applications other than MobileFirst applications to **parent-first**.
12. For WebSphere Application Server Network Deployment, click **System administration > Nodes**, select the nodes, and click **Full Synchronize**.

## Results

You can now view the runtime component from the MobileFirst Administration Console that is installed in “Installing the MobileFirst Server administration” on page 6-43. The default URL of the MobileFirst Administration Console is `http://<server>:<port>/worklightconsole`, where *server* is the host name of your

server and *port* is the port number (default value 9080).

#### *Configuring Apache Tomcat manually:*

To configure Apache Tomcat manually, you must copy JAR and WAR files to Tomcat, add database drivers, edit the `server.xml` file, and then start Tomcat.

#### **Before you begin**

See “Planning deployment of administration components and runtimes” on page 6-7 for the supported deployment topologies.

Review the environment IDs. Specifying an environment ID is optional. If you specify an ID, use the same value for each MobileFirst runtime environment that is managed by the same MobileFirst Server administration component. Moreover, this value must match the environment ID that is used when the MobileFirst Server administration component is installed. For more information about the `ibm.worklight.admin.environmentid` JNDI property, see “Configuring a MobileFirst project in production by using JNDI environment entries” on page 10-60.

#### **Procedure**

1. Copy the MobileFirst JAR file to the Tomcat `lib` directory:
  - On UNIX and Linux systems: `cp product_install_dir/WorklightServer/worklight-jee-library.jar tomcat_install_dir/lib`
  - On Windows systems: `copy /B product_install_dir\WorklightServer\worklight-jee-library.jar tomcat_install_dir\lib\worklight-jee-library.jar`
2. Add the database drivers to the Tomcat `lib` directory. See the instructions for the appropriate DBMS in “Creating and configuring the databases manually” on page 10-17.
3. Copy the MobileFirst project WAR file to the Tomcat web application directory, `tomcat_install_dir/webapps`, and rename it according to the context root. For example:
  - If the context root is `/worklight`, rename it to `worklight.war`.
  - If the context root is `/`, rename it to `ROOT.war`.
4. Edit `tomcat_install_dir/conf/server.xml` to declare the context and properties of the MobileFirst application:

```
<!-- Declare the MobileFirst runtime environment. -->
<Context path="/worklight" docBase="worklight">
  <Environment name="ibm.worklight.topology.platform" value="Tomcat" type="java.lang.String" override="false"/>
  <Environment name="ibm.worklight.topology.clusterMode" value="Standalone" type="java.lang.String" override="false"/>
  <!-- Declare the worklight and worklight reports databases. -->
  <!-- <Resource name="jdbc/WorklightDS" type="javax.sql.DataSource" ... /> -->
  <!-- <Resource name="jdbc/WorklightReportsDS" type="javax.sql.DataSource" ... /> -->
</Context>
```

Where you must uncomment and complete the `<Resource>` element to declare the administration database as described in the following sections:

- “Configuring Apache Tomcat for DB2 manually” on page 10-23
- “Configuring Apache Tomcat for Derby manually” on page 10-28
- “Configuring Apache Tomcat for MySQL manually” on page 10-33
- “Configuring Apache Tomcat for Oracle manually” on page 10-38

Make sure that the path and `docBase` attributes are both consistent with the WAR file name. That is, if the WAR file name is `worklight.war`, set the path to

"/worklight" and the docBase to "worklight". Whereas if the WAR file name is R00T.war, set the path to "" and the docBase to "R00T".

If the environment ID is set for the Administration Services, set the variable *ibm.worklight.admin.environmentid* to the same value.

#### 5. Start Tomcat.

*Completing the deployment of a project WAR file:*

To complete the deployment, you may need to restart the application server.

When the project WAR file is deployed on the application server, you must restart the application server in the following circumstances:

- When you used the `<configureApplicationServer>` Ant task or the manual instructions for deploying the project WAR file:
  - If you are using WebSphere Application Server with DB2 as database type for one or both of the databases.
  - If you are using WebSphere Application Server Liberty profile or Apache Tomcat.
- When you used the `<updateApplicationServer>` Ant task:
  - If you are using WebSphere Application Server (full profile or Liberty profile) and the MobileFirst runtime library (`worklight-jee-library.jar`) is changed.
  - If you are using Apache Tomcat.

If you are using WebSphere Application Server Network Deployment and you deployed to managed servers through the deployment manager:

- You must restart the servers that were running during the deployment and on which the MobileFirst project web application has been installed.

To restart these servers with the deployment manager console, select **Applications > Application Types > WebSphere enterprise applications > IBM\_Worklight\_Console > Target specific application status**.
- You do not have to restart the deployment manager or the node agents.

## **Configuring multiple MobileFirst projects in different environments**

Different environments operate independently. For example, with this approach you can host a test environment, a pre-production environment, and a production environment on the same server or in the same WebSphere Application Server Network Deployment cell.

You can configure multiple projects, either with the same Administration Services and MobileFirst Operations Console, or with separate MobileFirst environments. An environment consists of the following web applications:

- The Administration Services web application,
- Optionally, the MobileFirst Operations Console web application,
- Some MobileFirst runtime environments or project web applications, each with the appropriate database schemas.

According to your installation method, you specify the environment as follows:

- If you install with Ant tasks, specify it through the attribute `environmentId` in the `<installworklightadmin>` and `<configureapplicationserver>` invocations.

- If you install manually, specify it through the JNDI property `ibm.worklight.admin.environmentid` of the Administration Services application, and of the project WAR file.

If you use this approach, you must respect the following constraints:

- Each Administration Services application must use a different administration database or schema.
- Each configuration for a MobileFirst runtime environment must use a different runtime database or schema, and its own reports database or schema.
- Each configuration for a MobileFirst runtime environment must be deployed with the same `environmentId` attribute as the corresponding Administration Services.
- If the application server is WebSphere Application Server Liberty profile, each MobileFirst project must use a different `contextroot` attribute and have a different base name for the `.war` file. But you can rename a `.war` file before you install it. The `id` attribute of the Ant tasks is not used in this case.
- If the application server is WebSphere Application Server full profile or WebSphere Application Server Network Deployment, each MobileFirst project must use either a different `environmentId` attribute or, when installed with Ant tasks and with the same `environmentId`, a different `id` attribute. Different deployments with the same `contextroot` attribute are possible, if they are deployed to separate sets of servers (for example, to different clusters or to different nodes).
- If the application server is Apache Tomcat, each MobileFirst project must use a different `contextroot` attribute. In addition, the versions of the JDBC drivers must be suitable for all declared data sources of the particular database type.

## Configuration of MobileFirst applications on the server

You can configure each MobileFirst application by specifying a set of configuration parameters on the server side.

MobileFirst application configuration parameters configure the database, push notifications, the use of SSL to secure communications between the server and the client application, and other settings.

When you develop a MobileFirst application, you use the `worklight.properties` file to specify most of the configuration parameters. This file is in the `server/conf` folder in the project. You use the `worklight.properties` file during development to test a particular configuration. For example, if you want to use the analytics features during development, you might set the `wl.analytics.url` property to a valid URL in the `worklight.properties` file.

When your MobileFirst project is built by MobileFirst Platform Command Line Interface for iOS, the project WAR file that is created in the project `bin` folder contains the configuration that is specified in the `worklight.properties` file. The values for the parameters that are specified in the `worklight.properties` file then define the default configuration of your application.

When you deploy your project (your WAR file) to the production or test environment, your configuration is certain to be different from the development environment. It is easy to modify the configuration to fit the new environment because the project WAR file defines JNDI environment entries for each parameter that can be configured in a production environment. You leave the values in the

worklight.properties file unchanged; instead, you specify the configuration during the deployment to the application server.

See “Configuring a MobileFirst project in production by using JNDI environment entries” on page 10-60 to learn about the JNDI environment entries that you can specify in a production environment. Properties that are relevant only in development environments are not available as JNDI entries.

Within the worklight.properties file, you can define some application-specific configuration properties; for example, to configure the URL of a service that is called from the mobile application and the URL is different in production, development, and test environments. See “Declaring and using application-specific configuration properties” on page 10-58 to learn how to create such configuration properties.

### Configuring the IBM MobileFirst Platform Server location

You can configure the MobileFirst Server location by specifying configuration properties.

In production, you must configure your server location in the following circumstances:

- You are using relative path for the **onLoginUrl** parameter in the authenticationConfig.xml file.
- You are generating the URL for mobile web and desktop browser apps from the console.

In most cases, production servers sit behind a reverse proxy; therefore, their machine IP address (which is the default value of **publicWorkLightHostname**) is not used for accessing them from the outside world.

To configure the MobileFirst Server location, set the values of the following properties:

Table 10-5. MobileFirst Server location properties

Property name	Description
<b>publicWorkLightHostname</b>	<p>The IP address or host name of the computer running IBM MobileFirst Platform Foundation for iOS.</p> <p>If the MobileFirst Server is behind a reverse proxy, the value is the IP address or host name of the reverse proxy.</p> <p>This property must be identical for nodes within the same cluster.</p> <p>Default: IP address of current server.</p>

Table 10-5. MobileFirst Server location properties (continued)

Property name	Description
<b>publicWorkLightPort</b>	<p>The port for accessing the MobileFirst Server.</p> <p>If the MobileFirst Server is behind a reverse proxy, the value is the port for accessing the reverse proxy.</p> <p>This property must be identical for nodes within the same cluster.</p> <p>Default: 10080.</p> <p>The &lt;configureApplicationServer&gt; Ant task sets a default value that depends on the application server.</p>
<b>publicWorkLightProtocol</b>	<p>The protocol for accessing the MobileFirst Server.</p> <p>The valid values are HTTP and HTTPS. If the MobileFirst Server is behind a reverse proxy, the value is the protocol for accessing the reverse proxy.</p> <p>This property must be identical for nodes within the same cluster.</p> <p>Default: HTTP.</p> <p>The &lt;configureApplicationServer&gt; Ant task sets a default value that depends on the application server.</p>

For descriptions of other configuration properties, see “Configuring a MobileFirst project in production by using JNDI environment entries” on page 10-60.

For information about how to specify configuration properties, see “Configuration of MobileFirst applications on the server” on page 10-48.

### Runtime database setup for development mode

IBM MobileFirst Platform Foundation for iOS uses defaults to access the runtime database, which kind is WRKLGHT by default. When you work in a development environment and use JDBC to connect to a database, you can use a set of property keys to change the settings.

#### Attention:

This method of declaring data sources is deprecated in a production environment and is only suitable when working in a development environment and using JDBC for database connections. To configure data sources when working in a production environment, see “Creating and configuring the databases manually” on page 10-17.

Property keys and values for JDBC-based properties

Property Key	Property Value
<b>w1.db.url</b>	JDBC path to the runtime database.

Property keys and values for JDBC-based properties

Property Key	Property Value
<code>wl.db.username</code>	Runtime database user name. Default: Worklight
<code>wl.db.password</code>	Runtime database password. Default: Worklight
<code>wl.db.driver</code>	The class that implements a JDBC driver for each vendor. For example:  MySQL: <code>com.mysql.jdbc.Driver</code>  Oracle: <code>oracle.jdbc.OracleDriver</code>  DB2: <code>com.ibm.db2.jcc.DB2Driver</code>  Derby: <code>org.apache.derby.jdbc.EmbeddedDriver</code>
<code>wl.reports.db.url(*)</code>	JDBC path to the reports database  Default: refers to runtime database. <b>Note:</b> Deprecated in V7.0.0. Use “Operational analytics” on page 12-8 instead.
<code>wl.reports.db.username(*)</code>	Reports database user name.  Default: refers to Worklight database. <b>Note:</b> Deprecated in V7.0.0. Use “Operational analytics” on page 12-8 instead.
<code>wl.reports.db.password(*)</code>	Reports database password  Default: refers to runtime database. <b>Note:</b> Deprecated in V7.0.0. Use “Operational analytics” on page 12-8 instead.

**Note:** (\*) By default all report mechanisms in MobileFirst Server use a single reports database. The reports database is set to be the same as the runtime database. For more information about how this default setting can be changed, see “Using raw data reports” on page 12-76.

### Configuring extended app authenticity checking

Checking extended application authenticity is an additional method of verifying that the MobileFirst application on the device has not been tampered with.

### Enabling extended authenticity checking

To enable extended authenticity checking, you must deploy a modified `.wlapp` file, instead of the original `.wlapp` file that is generated by the build process. To obtain the modified `.wlapp` file, use one of the following two facilities:

- The **enable-extended-authenticity** command of the `wladm` Ant task, as described in “Commands for apps” on page 11-18.

- Extended application-authenticity validation is not supported for iOS apps that are installed from the Apple app store. See the Extended application authenticity for iOS known limitation.
- The **enable extended-authenticity** command of the **wladm** program, as described in “Commands for apps” on page 11-44.

**Note:** Extended application-authenticity validation is currently not supported for iOS apps that are installed from the Apple app store. See the Extended application authenticity for iOS known limitation.

You need to specify the following files as inputs for those commands:

- The **.wlapp** file, from the **bin** folder of your MobileFirst project.
- The mobile application file for the device, that is, the corresponding **.ipa** file. If your application must support both 32-bit and 64-bit execution, provide a single **.ipa** file that includes both 32-bit and 64-bit code.

The resulting, modified **.wlapp** file is the file that you deploy to the MobileFirst Server.

**Note:**

- The extended application authenticity mechanism demands that there be a dedicated version of the **.wlapp** file per each version of the native app. Before you distribute a new version of the mobile application file (**.ipa**), you must perform the following actions:
  1. Update the application version number in the **application-descriptor.xml** file.
  2. Rebuild to create a new **.wlapp** file.
  3. Run one of the commands described previously to enable authenticity checking on the production-ready **.ipa** file and the new **.wlapp** file.
  4. Deploy the **.wlapp** file produced in step 3 to the MobileFirst Server.

### Disabling extended authenticity checking

To revert from extended authenticity checking to basic authenticity checking, deploy the original **.wlapp** file to the MobileFirst Server, for each of the desired environments.

### Enabling extended authenticity checking for apps that undergo app thinning

App thinning was introduced by Apple in iOS 9 for apps that are compiled with Xcode 7. App thinning reduces the size of files that are downloaded from the App Store. The feature might affect the extended authenticity features of IBM MobileFirst Platform Foundation for iOS apps because the binary file in the App Store might differ from the one that is downloaded to the client device.

In order to insure that the new **ipa** file that you upload to the App Store can take advantage of app thinning, without influencing extended authenticity, first install the latest interim fix. To enable this extended authenticity, you must perform the following actions:

1. Configure the original **.wlapp** file by using the **enable-extended-authenticity** command of the **wladm** program, as described earlier in this page.
2. Deploy the **.wlapp** file to the server for testing.



**Note:** App thinning does not take place in apps that were developed using earlier versions of iOS and Xcode.

## Push notification settings

When working with push notifications, you must use the correct proxy settings. For iOS, you use APNS proxy settings. SMS has its own set of proxy settings.

The following properties are required only when a proxy is used to route requests to APNS, GCM, or SMS push servers. When no proxy is used, it is not necessary to set the properties (the **\*.enabled** property value should be set to false).

APNS proxy settings	Value
<b>push.apns.proxy.enabled</b>	Shows whether APNS must be accessed through a proxy. Can be either true or false. The default is false.
<b>push.apns.proxy.type</b>	APNS proxy type. Must be SOCKS.
<b>push.apns.proxy.host</b>	APNS proxy host.
<b>push.apns.proxy.port</b>	APNS proxy port.
<b>push.apns.proxy.user</b>	Proxy user name, if the proxy requires authentication. Empty user name means no authentication.
<b>push.apns.proxy.password</b>	Proxy password, if the proxy requires authentication.

SMS proxy settings	Value
<b>push.sms.proxy.enabled</b>	Can be either true or false. Use true to send SMS notifications through proxy.
<b>push.sms.proxy.protocol</b>	SMS proxy protocol. Can be either http or https.
<b>push.sms.proxy.host</b>	SMS proxy host name.
<b>push.sms.proxy.port</b>	SMS proxy port. Use -1 for the default port.
<b>push.sms.proxy.user</b>	Proxy user name, for authentication. An empty user name means no authentication.
<b>push.sms.proxy.password</b>	Proxy password, if the proxy requires authentication.

## Analytics

Analytics properties files contain the parameters for how IBM MobileFirst Platform Foundation for iOS creates activity logs and sends them to a server for analysis.

You can modify how the MobileFirst Server forwards analytics data to the IBM MobileFirst Platform Operational Analytics by editing the following properties files.

Table 10-6. IBM MobileFirst Platform Operational Analytics properties..

Property Name	Default Value	Description
wl.analytics.console.url	None.	Optional. The URL that is exposed by the IBM MobileFirst Platform Operational Analytics that links to the Analytics console. Set this property if you want to access the Analytics console from the MobileFirst Operations Console. Example: <code>http://&lt;hostname&gt;:&lt;port&gt;/analytics/console</code>
wl.analytics.logs.forward	true	When the property is set to true, server logs that are recorded on the MobileFirst Server are captured and forwarded to the IBM MobileFirst Platform Operational Analytics.
wl.analytics.password	None.	Required. The password that is used if the data entry point for the IBM MobileFirst Platform Operational Analytics is protected with basic authentication.
wl.analytics.url	None.	Required. The URL that is exposed by the IBM MobileFirst Platform Operational Analytics that receives incoming analytics data. Example: <code>http://&lt;hostname&gt;:&lt;port&gt;/analytics-service/data</code>
wl.analytics.username	None.	Required. The user name that is used if the data entry point for the IBM MobileFirst Platform Operational Analytics is protected with basic authentication.

## WebSphere Application Server SSL configuration and HTTP adapters

By setting a property, you can make HTTP adapters take benefit of the WebSphere SSL configuration.

By default, HTTP adapters do not take benefit of the WebSphere SSL configuration by concatenating the Java Runtime Environment (JRE) truststore with the Worklight truststore as referenced by the **ssl.keystore.path**, **ssl.keystore.password**, and **ssl.keystore.type** properties. See “Configuring SSL between MobileFirst adapters and back-end servers by using self-signed certificates” on page 6-135. To have HTTP adapters use the WebSphere SSL configuration, set the **ssl.websphere.config** property to true. This value has the following effects, in order of precedence:

1. If the **ssl.keystore.path**, **ssl.keystore.password**, **ssl.keystore.type** properties are set, the adapter uses the truststore that is referenced in these properties without concatenating it with the JRE truststore.
2. If the **ssl.websphere.alias** property is set, the adapter uses the SSL configuration that is associated with the alias as set in this property.
3. If the **ssl.keystore.path**, **ssl.keystore.password**, **ssl.keystore.type**, and **ssl.websphere.alias** properties are not set, the WebSphere outbound dynamic configuration is used.

## SSL certificate keystore setup

Mobile applications often connect to multiple back-end systems. Some back-end systems require access through an HTTP adapter, and each back-end system can require a different SSL certificate for secure communication using HTTPS. These SSL certificates are stored in a keystore that is configured to the IBM MobileFirst Platform Server by using property keys.

IBM MobileFirst Platform Foundation for iOS provides a default keystore. You can choose to use this default keystore or replace it with your own keystore.

To configure an SSL certificate keystore, you must set the values of the property keys listed in the following table:

Table 10-7. JNDI environment entries for SSL certificate keystore

Property name	Description
<code>ssl.keystore.path</code>	Path to the keystore relative to the server folder in the MobileFirst project; for example: <code>conf/my-cert.jks</code> .
<code>ssl.keystore.type</code>	Type of keystore file. Valid values are <code>jks</code> or <code>pkcs12</code> .
<code>ssl.keystore.password</code>	Password to the keystore file.
<code>ssl.websphere.alias</code>	WebSphere SSL configuration alias used by the HTTP adapters
<code>ssl.websphere.config</code>	Set this property to true to have HTTP adapters use WebSphere SSL configuration. Default: <code>false</code> .

For descriptions of other MobileFirst configuration properties, see “Configuring a MobileFirst project in production by using JNDI environment entries” on page 10-60.

For information about how to specify MobileFirst configuration properties, see “Configuration of MobileFirst applications on the server” on page 10-48.

In addition to defining these three properties, configure the HTTP adapter XML file, which is located under `<Worklight Root Directory>\adapters\<HTTP adapter name>`. This file is described in “Structure of the adapter XML file” on page 8-96.

If you use SSL with mutual authentication between the MobileFirst Server and a back-end system, be aware of the following requirement:

- Define an alias and password for the private key of the keystore where the SSL certificate is stored. The alias and password are defined in the `<connectionPolicy>` element of the HTTP adapter XML file, `adaptername.xml`. The `<sslCertificateAlias>` and `<sslCertificatePassword>` subelements are described in “HTTP adapter connectionPolicy element” on page 8-101.

**Note:** The password that is specified in `ssl.keystore.password` is not the same password that is specified in `<sslCertificatePassword>`. `ssl.keystore.password` is used to access the keystore itself. `<sslCertificatePassword>` is used to access the correct SSL certificate within the keystore.

## Miscellaneous Settings

Configure the `serverSessionTimeout`, `bitly.username`, `bitly.apikey`, `compress.response.threshold`, and `adapters.saxparser.doctype.validation` parameters.

Property keys and values for the `serverSessionTimeout`, `bitly.username`, `bitly.apikey`, `compress.response.threshold`, and `adapters.saxparser.doctype.validation` parameters.

Property Key	Property Value
<code>serverSessionTimeout</code>	Client inactivity timeout, after which the MobileFirst session is invalidated.  Default is 10 minutes.
<code>bitly.username</code>	User name for accessing the bit.ly API for creating a shortened URL for mobile web apps through MobileFirst Operations Console.
<code>bitly.apikey</code>	The bit.ly API Key.
<code>compress.response.threshold</code>	The threshold size of the payload that is returned in response to an <code>invokeProcedure</code> call beyond which the response is compressed. The default value is 20480 bytes. Responses with payload larger than the <code>compress.response.threshold</code> are compressed by the server. To disable compression, set this value to a large value. Similarly, to compress every response, set this value to 0 (zero). If the payload is larger than the <code>compress.response.threshold</code> , the payload is compressed irrespective of whether or not compression was requested by the client through the <code>compressResponse</code> option.
<code>adapters.saxparser.doctype.validation</code>	True or False. If set to False, the adapter does not validate the XML response received from the back-end server. This might be useful in cases where the time required to validate could be expected to exceed the allowed timeout value. The default setting is True, meaning that the server validates the response.

## Storing properties in encrypted format

When you configure MobileFirst applications on the server, you must encrypt the properties that are too sensitive to be written in clear text.

There are two ways to encrypt properties:

- Within the properties file: See “Encryption within the properties file.” This option is the only one for Tomcat.
- By using the application server encoding tools: `PropFilePasswordEncoder` for WebSphere Application Server and `SecurityUtility` for Liberty profile. For WebSphere Application Server and Liberty profile. See “Encoding the JNDI properties” on page 10-57.

## Encryption within the properties file

The encryption facility that comes with IBM MobileFirst Platform Foundation for iOS uses the 128-bit symmetric-key algorithm that is defined by the AES specification.

## Storing properties in open or encrypted format

You can keep the properties that are contained in the `worklight.properties` file either in open or in encrypted form.

An encrypted property is determined by a suffix `.enc` appended to its name. For example:

```
console.password.enc=TYakEHRba3rIU7pNjxtDxoAdqijKIEt7cy4mCr0iaEj0rY080DK00yqR
```

The MobileFirst configuration is accessed for a property. If the property is not found, but the same encrypted property (with the `.enc` suffix) is defined, MobileFirst automatically decrypts the value, and returns it to the caller.

### Storing the master key

All encrypted values use the same secret key, which is stored in the special variable called **`worklight_enc_password`**. This variable is defined as an operating-system environment variable:

- On Windows systems: Set an environment variable under the user that runs MobileFirst Server. Under a Windows NT service, define the password as a service property by using the registry editor. For more information, see the Microsoft support website.
- On Linux systems: Set the environment variable.

### Encryption

You can encrypt MobileFirst properties by using the 128-bit symmetric-key algorithm that is defined by the AES specification.

- On Windows systems, use the `encrypt.bat` utility under `product_install_dir/WorklightServer`. This utility accepts a file that contains the properties to be encrypted and the encryption password. The utility outputs the encrypted values to the same file, so that sensitive data is deleted.
- On Linux systems, use the `encrypt.sh` utility.

The input file for the encryption is called `secret.properties` and contains the following data:

```
worklight_enc_password=abc123
certificate.password=certificatepwd123
wl.db.password=edf545
```

After you run the `encrypt.sh` tool, the `secret.properties` file contains the following data:

```
#Copy the contents of this file to the worklight.properties file.
#Keep the password value in the secure system property worklight_enc_password.
#Wed Nov 28 10:10:44 CST 2012
certificate.password.enc=dR41nMQDaNEQyLQ17b2RmpdE99HKpqaSJ6mce0uJgaY\=
wl.db.password.enc=6boxojGZsUNTxw00GgI6dg\=\=
```

### Encoding the JNDI properties

The preferred way to encrypt JNDI properties in WebSphere Application Server is to use the password encoding tools that are available with both application servers.

- For WebSphere Application Server: the `PropFilePasswordEncoder` tool
- For the Liberty profile: the `SecurityUtility` command

You can use the encoded value as the value of the JNDI properties.

For more information about how to encode properties with the application server tools, see the WebSphere Application Server documentation.

## Obsolete properties

Some properties are no longer required.

Table 10-8. Categories and list of obsolete properties

Category	Properties
Proxy settings	<code>proxy.enabled</code> , <code>proxy.nonProxyHosts</code> , <code>proxy.host</code> , <code>proxy.port</code> , <code>proxy.username</code> , <code>proxy.password</code> , <code>https.proxy.host</code> , <code>https.proxy.port</code>
Public resource server settings	<code>publicResourceServer.deployDestination</code> , <code>publicResourceServer.host</code> , <code>publicResourceServer.port</code> , <code>publicResourceServer.filesRootDir</code>
Environments	<code>environment.iphone</code> , <code>environment.embedded</code>
Certificate settings	<code>certificate.certificatesDirPath</code> , <code>certificate.keyStoreFilePath</code> , <code>certificate.keyAlias</code> , <code>certificate.keyStorePassword</code> , <code>certificate.keyAliasPassword</code> , <code>certificate.PFXFilePath</code> , <code>certificate.password</code> , <code>certificate.DERFilePath</code> , <code>certificate.P7BFilePath</code> , <code>vista.linux.ossIsigncodeFilepath</code>
Push notification settings	<code>push.apns.certificatePassword</code> , <code>push.gcm.senderID</code> , <code>push.gcm.senderPassword</code>
Miscellaneous settings	<code>devmode</code> , <code>guid</code> , <code>wlclientTimeout</code> , <code>backend.request.timeout</code> , <code>reports.produceReports</code> , <code>wl.db.initialSize</code> , <code>wl.db.maxActive</code> , <code>wl.db.maxIdle</code> , <code>wl.db.testOnBorrow</code> , <code>wl.db.autoddl</code>
Tomcat settings	<code>local.bindAddress</code> , <code>local.httpPort</code>
Single identity login module security settings	<code>console.username</code> , <code>console.password</code>

## Declaring and using application-specific configuration properties

Use the `${propertyName}` notation to reuse application-specific properties that are declared in the `worklight.properties` file.

As a developer, you might want to parameterize some elements in the configuration of the server side of your MobileFirst application so that an IT administrator can change the value in production. For example, a MobileFirst adapter might need to call a back-end service, and the URL of this service might be different in a production environment from its value in a development environment. In this scenario, you can create a new MobileFirst configuration property to store the URL, and the IT administrator can then set the final production value as a JNDI environment entry.

You can declare application-specific properties in the `worklight.properties` file. You can then reuse the value of those properties within the authentication configuration file (`authenticationConfig.xml`) and the adapter descriptor file (`adapter.xml`) by using the `${propertyName}` notation.

Here is an example for declaring a data source and reusing it in an adapter:

1. In the `worklight.properties` file, define a new (custom) property:  
`my.adapter.db.jndi.name=jdbc/MyAdapterDS`
2. You can then include a property declaration in the `adapter.xml` file:

```

<wl:adapter>
  ...
  <connectivity>
    <connectionPolicy xsi:type="sql:SQLConnectionPolicy">
      <dataSourceJNDIName>
        `${my.adapter.db.jndi.name}`
      </dataSourceJNDIName>
    </connectionPolicy>
  ...

```

Such properties are exposed as JNDI entries (see “Configuring a MobileFirst project in production by using JNDI environment entries” on page 10-60) for the project WAR file. In this example, the JNDI name of the adapter data source becomes parametric and can be changed from the server configuration files.

In `authenticationConfig.xml`, you can use `${propertyName}` notation for all realm and **loginModule** parameters. Here are examples (in bold typeface) for such properties:

```

<securityTests>
  <customSecurityTest name="MySecurityTest">
    <test realm="MySecurityRealm" isInternalUserID="true"/>
  </customSecurityTest>
</securityTests>

<realms>
  <realm name="MySecurityRealm" loginModule="MySecurityLoginModule">
    <className>com.test.auth.MyAuthenticator</className>
    <parameter name="login-mode" value="`${my.security.realm.mode}`"/>
    <parameter name="my-other-realm-param" value="`${my.security.realm.param}`"/>
  </realm>
</realms>

<loginModules>
  <loginModule name="MySecurityLoginModule">
    <className>com.test.auth.MyLoginModule</className>
    <parameter name="roles-allowed" value="`${my.security.allowed.roles}`"/>
    <parameter name="my-other-login-param" value="`${my.security.login.param}`"/>
  </loginModule>
</loginModules>

```

For more information about configuring realm parameters, see “Configuring authenticators and realms” on page 8-262. For **loginModule** parameters, see “Configuring login modules” on page 8-282.

In `adapter.xml`, you can use the `${propertyName}` notation in the following elements:

#### For HTTP adapters:

```

<connectivity>
  <connectionPolicy xsi:type="http:HTTPConnectionPolicyType">
    <protocol>`${my.protocol}`</protocol>
    <domain>`${my.domain}`</domain>
    <port>`${my.port}`</port>
  </connectionPolicy>
  <authentication>
    <ntlm workstation="`${local.hostname}`" />
    <serverIdentity>
      <username>`${my.server.identity.username}`</username>
    </serverIdentity>
  </authentication>
</connectivity>

```

```

        <password>${my.server.identity.password}</password>
    </serverIdentity>
</authentication>

<!-- Following properties used by adapter's key manager for choosing specific certificate from key store -->

<sslCertificateAlias>${my.ssl.certificate.alias}</sslCertificateAlias>
<sslCertificatePassword>${my.ssl.certificate.password}</sslCertificatePassword>

</connectionPolicy>

<loadConstraints maxConcurrentConnectionsPerNode="${max.connections.per.node}"/>
</connectivity>

```

#### For SQL adapters:

```

<connectivity>
  <connectionPolicy xsi:type="sql:SQLConnectionPolicy">

    <!-- Example for using a JNDI data source, replace with actual data source name -->
    <!-- <dataSourceJNDIName>${my.data.source.jndi.name}</dataSourceJNDIName> -->

    <!-- Example for using MySQL connector, do not forget to put the MySQL connector library in the project's lib folder -->
    <dataSourceDefinition>
      <driverClass>${my.driver.class.name}</driverClass>
      <url>${my.data.source.url}</url>
      <user>${my.data.source.username}</user>
      <password>${my.data.source.password}</password>
    </dataSourceDefinition>
  </connectionPolicy>
  <loadConstraints maxConcurrentConnectionsPerNode="${max.connections.per.node}"/>
</connectivity>

```

#### For JMS adapters:

```

<connectivity>
  <connectionPolicy xsi:type="jms:JMSConnectionPolicyType">

    <!-- uncomment this if you want to use an external JNDI repository -->
    <!-- <namingConnection url="${my.naming.connection.url}"
      initialContextFactory="${my.initial.context.factory}"
      user="${my.naming.connection.username}"
      password="${my.naming.connection.password}"/>
    -->

    <jmsConnection connectionFactory="${my.jms.connection.factory}"
      user="${my.jms.connection.username}"
      password="${my.jms.connection.password}"
    />
  </connectionPolicy>

  <loadConstraints maxConcurrentConnectionsPerNode="${max.connections.per.node}"/>
</connectivity>

```

For more information about configuring adapters, see “HTTP adapter connectionPolicy element” on page 8-101.

### Configuring a MobileFirst project in production by using JNDI environment entries

When you deploy a MobileFirst project to a MobileFirst Server, you can configure the project’s WAR file with JNDI environment entries to set product environment properties.



## About this task

JNDI environment entries cover all the properties that you can set in a production environment. You set the JNDI environment entries in one of two ways:

- Either by editing the configuration XML file for the deployer Ant tasks,
- Or by configuring the server's environment entries. On WebSphere Application Server full profile, you use the administration console. On WebSphere Application Server Liberty profile or Apache Tomcat, you edit the `server.xml` file.

Many of the MobileFirst configuration properties must have different values when the project is deployed to different environments. For example, the configuration properties that are used to specify the MobileFirst Server public URL (that is, **publicWorkLightHostname**, **publicWorkLightPort**, and **publicWorkLightProtocol**) might be different when the MobileFirst project is deployed to a staging server or to a production server. You can configure the project WAR file through JNDI environment entries.

**Note:** Some of the properties are relevant only in a development environment and are not available as JNDI entries.

**Note:** There are two ways to encrypt the JNDI properties that are listed in the following table, as described in “Storing properties in encrypted format” on page 10-56:

- You can define the property with the `.enc` suffix in the `worklight.properties` file that is packaged in the WAR file of the MobileFirst project. You can then override the encrypted value by using a JNDI property. With Apache Tomcat, this option is the only one available.
- On WebSphere Application Server full profile and Liberty profile, you can use the password encoding tools: `PropFilePasswordEncoder` for WebSphere Application Server and `SecurityUtility` for Liberty profile.

The following table lists the MobileFirst properties that are always available as JNDI entries:

Table 10-9. MobileFirst properties available as JNDI entries.

Property name	Description
<code>adapters.saxparser.doctype.validation</code>	Specifies whether the adapter should validate the XML response received from the back-end server. If set to <code>False</code> , the adapter does not validate the response. This might be useful in cases where the time required to validate could be expected to exceed the allowed timeout value. Default: <code>True</code>
<code>cluster.data.synchronization.taskFrequencyInSeconds</code>	Applications and adapters cluster data synchronization interval. Default: <code>2</code> .
<code>deployables.cleanup.taskFrequencyInSeconds</code>	Deployable folder cleanup task interval (in seconds). Default: <code>86400</code> .

Table 10-9. MobileFirst properties available as JNDI entries (continued).

Property name	Description
<b>ibm.worklight.admin.environmentid</b>	Optional. Environment identifier for the registration of the MBeans. Use this identifier when different instances of the MobileFirst Server are installed on the same application server. The identifier determines which Administration Services, which console, and which runtimes belong to the same installation. The Administration Services manage only the runtimes that have the same environment identifier.
<b>ibm.worklight.admin.jmx.connector</b>	Mandatory. JMX connector type, by default RMI/SOAP. WebSphere Application Server profile only.
<b>ibm.worklight.admin.jmx.dmgr.host</b>	Mandatory. Deployment Manager host name. WebSphere Application Server Network Deployment only.
<b>ibm.worklight.admin.jmx.dmgr.port</b>	Mandatory. Deployment Manager RMI or SOAP port. WebSphere Application Server Network Deployment only.
<b>ibm.worklight.admin.jmx.pwd</b>	Optional. WebSphere Application Server Farm: the user password of the SOAP connection.
<b>ibm.worklight.admin.jmx.user</b>	Optional. WebSphere Application Server Farm: the user name of the SOAP connection.
<b>ibm.worklight.admin.rmi.registryPort</b>	Optional. RMI registry port for the JMX connection through a firewall. Tomcat only.
<b>ibm.worklight.admin.rmi.serverPort</b>	Optional. RMI server port for the JMX connection through a firewall. Tomcat only.
<b>ibm.worklight.admin.serverid</b>	Optional. Server identifier. Must be different for each server in the farm. Server farms only.
<b>ibm.worklight.jndi.configuration</b>	Optional. If the JNDI configuration is injected into the WAR files or provided as a shared library, the value of this property is the name of the JNDI configuration. This value can also be specified as a system property. See "Predefining MobileFirst Server configuration for several deployment environments" on page 6-227.
<b>ibm.worklight.jndi.file</b>	Optional. If the JNDI configuration is stored as an external file, the value of this property is the path of a file that describes the JNDI configuration. This value can also be specified as a system property. See "Predefining MobileFirst Server configuration for several deployment environments" on page 6-227.
<b>ibm.worklight.topology.clustermode</b>	In addition to the server type, you must specify the server topology. The values that are allowed: <ul style="list-style-type: none"> <li>• Standalone</li> <li>• Cluster</li> <li>• Farm</li> </ul> The default value is Standalone.

Table 10-9. MobileFirst properties available as JNDI entries (continued).

Property name	Description
<b>ibm.worklight.topology.platform</b>	<p>Server type. The values can be:</p> <ul style="list-style-type: none"> <li>• Liberty</li> <li>• WAS</li> <li>• Tomcat</li> </ul> <p>If the default value is not set, the application tries to guess the server type.</p>
<b>publicWorkLightHostname</b>	<p>The IP address or host name of the computer that is running IBM MobileFirst Platform Foundation for iOS.</p> <p>If the MobileFirst Server is behind a reverse proxy, the value is the IP address or host name of the reverse proxy.</p> <p>This property must be identical for nodes within the same cluster.</p> <p>Default: IP address of current server.</p>
<b>publicWorkLightPort</b>	<p>The port for accessing the MobileFirst Server.</p> <p>If the MobileFirst Server is behind a reverse proxy, the value is the port for accessing the reverse proxy.</p> <p>This property must be identical for nodes within the same cluster.</p> <p>Default: 10080.</p> <p>The <b>configureApplicationServer</b> Ant task sets a default value that depends on the application server.</p>
<b>publicWorkLightProtocol</b>	<p>The protocol for accessing the MobileFirst Server.</p> <p>The valid values are HTTP and HTTPS. If the MobileFirst Server is behind a reverse proxy, the value is the protocol for accessing the reverse proxy.</p> <p>This property must be identical for nodes within the same cluster.</p> <p>Default: HTTP.</p> <p>The <b>configureApplicationServer</b> Ant task sets a default value that depends on the application server.</p>
<b>push.apns.proxy.enabled</b>	<p>Indicates whether APNS must be accessed through a proxy. Default: false.</p>
<b>push.apns.proxy.host</b>	<p>APNS proxy host.</p>
<b>push.apns.proxy.port</b>	<p>APNS proxy port.</p>
<b>push.apns.proxy.user</b>	<p>Proxy user name, if the proxy requires authentication. Empty user name means no authentication.</p>
<b>push.apns.proxy.password</b>	<p>Proxy password, if the proxy requires authentication.</p>

Table 10-9. MobileFirst properties available as JNDI entries (continued).

Property name	Description
<b>push.sms.proxy.enabled</b>	Indicates whether push SMS proxy is enabled. Default: false.
<b>push.sms.proxy.host</b>	Push SMS proxy host.
<b>push.sms.proxy.password</b>	Push SMS proxy password.
<b>push.sms.proxy.port</b>	Push SMS proxy port.
<b>push.sms.proxy.protocol</b>	Push SMS proxy protocol.
<b>push.sms.proxy.user</b>	Push SMS proxy user.
<b>serverSessionTimeout</b>	Idle session timeout in minutes. Default: 10.
<b>ssl.keystore.password</b>	SSL certificate keystore password.
<b>ssl.keystore.path</b>	SSL certificate keystore location. Default: conf/mfp-default.keystore.
<b>ssl.keystore.type</b>	SSL certificate keystore type. Valid keystore types: jks or PKCS12. Default: jks.
<b>ssl.websphere.alias</b>	WebSphere SSL configuration alias used by the HTTP adapters
<b>ssl.websphere.config</b>	Set this property to true to have HTTP adapters use WebSphere SSL configuration. Default: false.
<b>sso.cleanup.taskFrequencyInSeconds</b>	Interval (seconds) for a cleanup task that cleans the database of orphaned and expired single-sign-on login contexts. Default: 5
<b>wl.analytics.console.url</b>	Optional. The URL that is exposed by the IBM MobileFirst Platform Operational Analytics that links to the Analytics console. Set this property if you want to access the Analytics console from the MobileFirst Operations Console. Example: http://<hostname>:<port>/analytics/console
<b>wl.analytics.logs.forward</b>	Boolean value (true or false) that indicates whether to send all com.worklight.* logs to the operational analytics server. If this value is true, all logs that are specified in com.worklight settings are forwarded to the operational analytics server. The default value is true. This setting is only supported on MobileFirst production servers.
<b>wl.analytics.password</b>	The password that is used if the data entry point for the IBM MobileFirst Platform Operational Analytics is protected with basic authentication.

Table 10-9. MobileFirst properties available as JNDI entries (continued).

Property name	Description
<b>wl.analytics.url</b>	The URL that is exposed by the IBM MobileFirst Platform Operational Analytics that receives incoming analytics data. Example: <code>http://&lt;hostname&gt;:&lt;port&gt;/analytics-service/data</code> .
<b>wl.analytics.username</b>	The user name that is used if the data entry point for the IBM MobileFirst Platform Operational Analytics is protected with basic authentication.
<b>wl.ca.key.alias</b>	Alias of the entry where the private key and certificate are stored in the keystore. Default: <code>mfp-default-cert</code> .
<b>wl.ca.key.alias.password</b>	Password to the alias in the keystore.
<b>wl.ca.keystore.password</b>	Password to the keystore file.
<b>wl.ca.keystore.path</b>	Path to the keystore relative to the server folder in the MobileFirst project. Default: <code>conf/mfp-default.keystore</code> .
<b>wl.ca.keystore.type</b>	Type of keystore file. Valid values are <code>jks</code> or <code>pkcs12</code> . Default: <code>jks</code> .
<b>wl.clientlogs.adapter.name</b>	The name of the HTTP adapter that you want to use to receive client-side logs. If you do not specify this property, the default <code>WLClientLogReceiver</code> name is used.
<b>wl.device.archiveDecommissioned.when</b>	A value, in days, that defines when client devices that were decommissioned will be placed in an archive file when the decommissioning task is run. The archived client devices are written to a file in the MobileFirst Server <code>home\devices_archive</code> directory. The name of the file contains the time stamp when the archive file is created. Default: 90 days.
<b>wl.device.decommission.when</b>	The number of days of inactivity after which a client device is decommissioned by the device decommissioning task. Default: 90 days.
<b>wl.device.enableAccessManagement</b>	A Boolean value ( <code>true</code> or <code>false</code> ) that enables the Access Management features on the MobileFirst Server. If the Access Management features are enabled, each time a device attempts to connect to the server, it is checked against the backend for its access rights.
<b>wl.device.tracking.enabled</b>	A value that is used to enable or disable device tracking in IBM MobileFirst Platform Foundation for iOS. For performance reasons, you can disable this flag when IBM MobileFirst Platform Foundation for iOS is running only Business-to-Consumer (B2C) apps. When device tracking is disabled, the license reports are also disabled and no license metrics are generated.

Table 10-9. MobileFirst properties available as JNDI entries (continued).

Property name	Description
<code>mfp.adapter.invocation.url</code>	The URL to be used for invoking adapter procedures from inside Java adapters, or JavaScript adapters that are invoked using the <code>/rest</code> endpoint. If this property is not set, the URL of the currently executing request will be used (this is the default behavior). This value should contain the full URL, including the context root.

Custom user properties that are defined in the `worklight.properties` file are exposed too.

The `wl.db.*` and `wl.reports.db.*` properties are not available as JNDI environment entries because they are intended for use only during the development phase.

### Configuring with the Ant task

When you deploy and configure the project with the Ant task (as described in “Deploying a project WAR file and configuring the application server with Ant tasks” on page 10-14), it is possible to set values for MobileFirst configuration properties inside the `<configureapplicationserver>` tag. For example:

```
<configureapplicationserver shortcutsDir="${shortcuts.dir}">
  <property name="serverSessionTimeout" value="30"/>
  <property name="publicWorkLightHostname" value="www.example.com"/>
  <property name="publicWorkLightPort" value="80"/>
  <property name="publicWorkLightProtocol" value="http"/>
</configureapplicationserver>
```

### Manually configuring on the server

In some cases, when you do not want to or cannot redeploy the application, it is also possible to set values for MobileFirst configuration properties manually on the server configuration files (or console). This procedure is what the Ant task does behind the scenes. The manual configuration method is less recommended because in some cases (for example, when upgrading or redeploying), the application server might forget the configuration and the administrator must reconfigure it.

### Procedure

Complete the following tasks, depending on which application server is used:

- WebSphere Liberty profile:

Insert the following declarations in the `server.xml` file:

```
<application id="worklight" name="worklight" location="worklight.war"
  type="war" context-root="/app_context_path">
</application>
<jndiEntry value="9080" jndiName="app_context_path/publicWorkLightPort"/>
<jndiEntry value="www.example.com" jndiName="app_context_path/publicWorkLightHostname"/>
```

The context path (in the previous example: `app_context_path`) connects between the JNDI entry and a specific MobileFirst application. If multiple MobileFirst applications exist on the same server, you can define specific JNDI entries for each application by using the context path prefix. Typically, `app_context_path` is `"worklight"`.

- Apache Tomcat:

Insert the following declarations in the `server.xml` file:

```
<Context docBase="app_context_path" path="/app_context_path">
  <Environment name="publicWorkLightPort" override="false"
    type="java.lang.String" value="9080"/>
  <Environment name="publicWorkLightHostname" override="false"
    type="java.lang.String" value="www.example.com"/>
</Context>
```

**Note:** On Apache Tomcat, `override="false"` is mandatory.

With Apache Tomcat, the context path prefix is not needed because the JNDI entries are defined inside the `<Context>` element of an application.

- WebSphere Application Server:
  1. In the administration console, go to **Applications > Application Types > WebSphere enterprise applications > Worklight > Environment entries for Web modules**
  2. In the **Value** fields, enter values that are appropriate to your circumstances.

**Note:** Preconfigure JNDI properties in a property file as an alternative to setting JNDI environment entries by editing the deployer Ant task configuration XML file or by configuring the server environment entries through the WebSphere Application Server administration console or the `server.xml` file on WebSphere Application Server Liberty profile or Apache Tomcat. Holding JNDI properties in a property file makes it easier to transfer the entire configuration from one web application server to another. For example, you can configure a test web server; when the configuration is stable, you can easily transfer the configuration to the production web server by copying the property file to the production server. For details of this mechanism, see “Predefining MobileFirst Server configuration for several deployment environments” on page 6-227.

**Related reference:**

“Configuration of MobileFirst applications on the server” on page 10-48

You can configure each MobileFirst application by specifying a set of configuration parameters on the server side.

## SMS gateway configuration

An SMS gateway, or SMS aggregator, is a third-party entity which is used to forward SMS notification messages to a destination mobile phone number. IBM MobileFirst Platform Foundation for iOS routes the SMS notification messages through the SMS gateway.

To send SMS notifications from IBM MobileFirst Platform Foundation for iOS, one or more SMS gateways must be configured in the `SMSConfig.xml` file, which is in the `/server/conf` folder of your project. To configure an SMS gateway, you must set the values of the following elements, subelements, and attributes in the `SMSConfig.xml` file. The MobileFirst Server must be restarted when any changes are made in the `SMSConfig.xml` file.

Table 10-10. SMSConfig.xml elements and subelements

Element	Element Value
<b>gateway</b>	<p>Mandatory. The &lt;gateway&gt; element is the root element of the SMS gateway definition. It includes 6 attributes:</p> <ul style="list-style-type: none"> <li>• hostname</li> <li>• id</li> <li>• port</li> <li>• programName</li> <li>• toParamName</li> <li>• textParamName</li> </ul> <p>These attributes are described in Table 10-11.</p>
<b>parameter</b>	<p>Optional. The &lt;parameter&gt; subelement is dependent on the SMS gateway. Each SMS gateway may have its own set of parameters. The number of &lt;parameter&gt; subelements is dependent on SMS gateway-specific parameters. If an SMS gateway requires the user name and password to be set, then these parameters can be defined as &lt;parameter&gt; subelements.</p> <p>Each &lt;parameter&gt; subelement has the following attributes:</p> <ul style="list-style-type: none"> <li>• name</li> <li>• value</li> </ul>

Table 10-11. <gateway> element attributes

Attribute	Attribute Value
<b>hostname</b>	Mandatory. The host name of the configured SMS gateway.
<b>id</b>	Mandatory. A unique ID that identifies the SMS gateway. Application developers specify the ID in the application descriptor file, application-descriptor.xml, when they develop an application.
<b>port</b>	Optional. The port number of the SMS gateway. The default value is 80.
<b>programName</b>	<p>Optional. The name of the program that the SMS gateway expects. For example, if the SMS gateway expects the following URI:</p> <p>http://&lt;hostname&gt;:port/sendsms</p> <p>then <b>programName</b>="sendsms"</p>
<b>toParamName</b>	Optional. The name that is used by the SMS gateway to specify the destination mobile phone number. The default value is <i>to</i> . The destination mobile phone number is sent as a name-value pair when SMS notifications are sent; that is, <i>toParamName=destination mobile phone number</i> .



Table 10-11. <gateway> element attributes (continued)

Attribute	Attribute Value
textParamName	Optional. The name that is used by the SMS gateway to specify the SMS message text. The default value is <i>text</i> .

If the SMS gateway expects an HTTP post in the following format to forward SMS messages to a mobile device:

```
http://myhost:13011/cgi-bin/sendsms?to=destination mobile phone number&text=message text&username=fcsuser&password=fcspass
```

The SMSConfig.xml file is configured as follows:

```
<?xml version="1.0" encoding="UTF-8"?>
<sms:config xmlns:sms="http://www.worklight.com/sms/config" xmlns:xsi="http://www.w3.org/2001/XMLSchema-instance">

  <gateway hostname="myhost" id="kannelgw" port="13011" programName="cgi-bin/sendsms" toParamName="to" textParamName="text">
    <parameter name = "username" value = "fcsuser" />
    <parameter name = "password" value = "fcspass" />
  </gateway>

</sms:config>
```

## Ant tasks for building and deploying applications and adapters

A set of Ant tasks is supplied with MobileFirst Server and the IBM MobileFirst Platform Command Line Interface for iOS. You can use them to build and deploy your applications, adapters, and projects.

IBM MobileFirst Platform Foundation for iOS provides a set of Ant tasks that help you build and deploy adapters and applications to your MobileFirst Server. A typical use of these Ant tasks is to integrate them with a central build service that is called manually or periodically on a central build server.

### Prerequisites

Before you can run Ant tasks, make sure that Apache Ant is installed. The minimum supported version of Ant is listed in “System requirements” on page 2-7.

Apache Ant 1.8.4 is included in MobileFirst Server. In the *product\_install\_dir/shortcuts/* directory, the following scripts are provided.

- For UNIX / Linux: ant
- For Windows: ant.bat

These scripts are ready to run, which means that they do not require specific environment variables. If the JAVA\_HOME environment variable is set, the scripts accept it.

### Building applications and adapters

If you use Ant tasks, you can build both applications and adapters.

You can use the following examples of Ant XML files to build applications and adapters.

**Note:** Since V6.2.0, the `worklight-ant-builder.jar` file is included in the IBM MobileFirst Platform Command Line Interface for iOS as well as the MobileFirst Server, whereas in earlier versions, it was included only in Worklight Server. By default, `worklight-ant-builder.jar` is installed in the following location: `cli_install_dir/public/worklight-ant-builder.jar`. For example, on OSX, the default CLI Install Path is `/Applications/IBM/Worklight-CLI`. If you use the default installation path, the Ant task is installed here: `/Applications/IBM/Worklight-CLI/public/worklight-ant-builder.jar`.

In Worklight Server V6.2.0 and MobileFirst Server, the default location of `worklight-ant-builder.jar` is `mfp_server_install_dir/WorklightServer/worklight-ant-builder.jar`. This file has the same version as the server.

## Building a native API application

The Ant task for building a native API application has the following structure:

```
<?xml version="1.0" encoding="UTF-8"?>
<project basedir="." default="target-name">
  <taskdef resource="com/worklight/ant/defaults.properties">
    <classpath>
      <pathelement location="cli_install_dir/public/worklight-ant-builder.jar"/>
    </classpath>
  </taskdef>
  <target name="target-name">
    <native-app-builder
      sourceFolder="application-source-files-folder"
      outputFolder="output-folder"/>
  </target>
</project>
```

The `<native-app-builder>` element has the following attributes:

- The `sourceFolder` attribute specifies the root folder for the application, which contains the `application-descriptor.xml` file and other source files for the application.
- The `outputFolder` attribute specifies the folder to which the resulting `.wlapp` file is written.

## Building an adapter

The Ant task for building an adapter has the following structure:

```
<?xml version="1.0" encoding="UTF-8"?>
<project basedir="." default="target-name">
  <taskdef resource="com/worklight/ant/defaults.properties">
    <classpath>
      <pathelement location="cli_install_dir/public/worklight-ant-builder.jar"/>
    </classpath>
  </taskdef>

  <path id="base.path">
    <pathelement path="/Users/miguel/badjars"/>
  </path>

  <target name="target-name">
    <adapter-builder
      folder="adapter-source-files-folder"
      destinationFolder="destination-folder"
      classpathref="base.path"/>
  </target>
</project>
```

The <adapter-builder> element has the following attributes:

- The `folder` attribute specifies the folder that contains the source files of the adapter (its `.xml` and `.js` files).
- The `destinationfolder` attribute specifies the folder to which the resulting `.adapter` file is written.
- The `classpathref` attribute specifies a custom class path for the adapter builder. If this property is not specified, then the class path of the running Ant task is used to compile the code.

The `classpathref` attribute is required to be set for RESTful Java adapters. It is not mandatory for JavaScript adapters. You must add the `Worklight-jee-library.jar` to the class path for Java adapters. In the case of RESTful Java adapters, the task compiles the code in the `adapterRootFolder/src` directory and copies the compiled classes to the `adapterRootFolder/bin` directory. Any source files that are not Java are also copied. Error messages are printed in the console.

This Ant task requires that the `JAVA_HOME` environment variable is set to point to a JDK and not a JRE.

If you must build more than one adapter file, add an <adapter-builder> element for each adapter.

Example:

### Building a JavaScript adapter

```
<adapter-builder
  folder="adapterRootFolder"
  destinationfolder="destination-folder"/>
```

### Building a Java adapter without libs

```
<path id="my.path">
  <pathelement path="/product_install_dir/WorklightServer/worklight-jee-library.jar"/>
</path>
```

```
<adapter-builder
  folder="adapterRootFolder"
  destinationfolder="destination-folder"
  classpathref="my.path"/>
```

### Building a Java adapter with the server/lib and the adapter/lib folders in the class path

```
<path id="my.path">
  <pathelement path="/product_install_dir/WorklightServer/worklight-jee-library.jar"/>
  <fileset dir="adapterRootFolder/lib">
    <include name="*.jar" />
  </fileset>
  <fileset dir="projectRootFolder/server/lib">
    <include name="*.jar" />
  </fileset>
</path>
```

```
<adapter-builder
  folder="adapterRootFolder"
  destinationfolder="destination-folder"
  classpathref="my.path"/>
```

### Building the Starter project

To use the Ant script starter example, complete the following steps.

1. Download the Starter Application sample.

2. Add the build.xml file to the root folder of your project.
3. Complete the following properties inside the build.xml file with the correct values. These values depend on your computer and the location where IBM MobileFirst Platform Foundation for iOS is installed.

```
<!-- The admin console URL -->
<property name="mfp.admin.url" value="http://localhost:10080/worklightadmin"/>
<!-- The MobileFirst server host to be written in the app configuration file (wlconfig.properties or worklight.plist) -->
<property name="mfp.server.url" value="http://localhost:10080/worklight"/>
<!-- The MobileFirst builder jar - This jar contains all the builder ant tasks -->
<property name="mfp.ant.builder.jar" value="product_install_dir/WorklightServer/worklight-ant-builder.jar"/>
<!-- The MobileFirst deployer jar - This jar contains all the deployer ant tasks -->
<property name="mfp.ant.deployer.jar" value="product_install_dir/WorklightServer/worklight-ant-deployer.jar"/>
<!-- The MobileFirst server Java EE library jar - This jar is required for building the server/java folder
and for building Java adapters as well -->
<property name="mfp.jee.library.jar" value="product_install_dir/WorklightServer/worklight-jee-library-production.jar"/>
```

4. Ensure that the MobileFirst Server is running and that MobileFirst WAR is installed on it.
5. Run the **ant** command. The **ant** command builds and deploys the app and the adapter of the Starter Application project. It also builds, but does not deploy, the WAR.

```
<?xml version="1.0"?>
<project default="build-all-and-deploy" name="build-tools" basedir=".">
  <property name="mfp.runtime.name" value="worklight"/>
  <!-- The admin console URL -->
  <property name="mfp.admin.url" value="http://localhost:10080/worklightadmin"/>
  <!-- The MobileFirst server host to be written in the app configuration file (wlconfig.properties or worklight.plist) -->
  <property name="mfp.server.url" value="http://localhost:10080/worklight"/>
  <!-- The MobileFirst builder jar - This jar contains all the builder ant tasks -->
  <property name="mfp.ant.builder.jar" value="product_install_dir/WorklightServer/worklight-ant-builder.jar"/>
  <!-- The MobileFirst deployer jar - This jar contains all the deployer ant tasks -->
  <property name="mfp.ant.deployer.jar" value="product_install_dir/WorklightServer/worklight-ant-deployer.jar"/>
  <!-- The MobileFirst server Java EE library jar - This jar is required for building the server/java folder
and for building Java adapters as well -->
  <property name="mfp.jee.library.jar" value="product_install_dir/WorklightServer/worklight-jee-library-production.jar"/>
  <taskdef resource="com/worklight/ant/defaults.properties">
    <classpath>
      <pathelement location="{mfp.ant.builder.jar}"/>
    </classpath>
  </taskdef>
  <taskdef resource="com/worklight/ant/deployers/antlib.xml">
    <classpath>
      <pathelement location="{mfp.ant.deployer.jar}"/>
    </classpath>
  </taskdef>
  <target name="build-all-and-deploy">
    <antcall target="build-war"/>
    <antcall target="build-applications"/>
    <antcall target="build-adapters"/>
    <antcall target="deploy"/>
  </target>
  <target name="build-war">
    <path id="compiler-classpath">
      <pathelement location="{mfp.jee.library.jar}"/>
    </path>
    <mkdir dir="bin/classes"/>
    <javac classpath="{mfp.jee.library.jar}" destdir="bin/classes" srcdir="server/java">
      <classpath refid="compiler-classpath"/>
    </javac>
    <war-builder classesFolder="bin/classes" warfile="bin/StarterApplication.war" destinationFolder="bin" projectFolder="."/>
  </target>
  <target name="build-applications">
    <echo>Building Hybrid application "StarterApplication"...</echo>
    <app-builder environments="android,iphone,windowsphone8,desktopbrowser,ipad,mobilewebapp,windows8,common"
      nativeProjectPrefix="StarterApplication" outputFolder="bin" worklightserverhost="{mfp.server.url}"
      applicationFolder="apps/StarterApplication"/>
    <echo>Building Native iOS application "NativeiOS"...</echo>
    <native-app-builder worklightserverhost="{mfp.server.url}" outputFolder="bin" sourceFolder="apps/NativeiOS"/>
    <echo>Building Native Android application "NativeAndroid"...</echo>
    <native-app-builder worklightserverhost="{mfp.server.url}" outputFolder="bin" sourceFolder="apps/NativeAndroid"/>
    <echo>Building Native WP8 application "NativeWP8"...</echo>
    <native-app-builder worklightserverhost="{mfp.server.url}" outputFolder="bin" sourceFolder="apps/NativeWP8"/>
  </target>
  <target name="build-adapters">
    <antcall target="build-adapter">
```

```

    <param name="adapter.folder" value="adapters/StarterApplicationAdapter"/>
  </antcall>
</target>
<target name="build-adapter">
  <path id="compiler-classpath">
    <fileset dir="${adapter.folder}/lib">
      <include name="*.jar"/>
    </fileset>
    <fileset dir="server/lib">
      <include name="*.jar"/>
    </fileset>
    <pathelement location="{mfp.jee.library.jar}"/>
  </path>
  <echo>Building adapter ${adapter.name}</echo>
  <adapter-builder destinationfolder="bin" classpathref="compiler-classpath" folder="{adapter.folder}"/>
</target>
<target name="deploy">
  <wladm password="admin" user="admin" secure="false" url="{mfp.admin.url}">
    <deploy-adapter file="bin/StarterApplicationAdapter.adapter" runtime="{mfp.runtime.name}"/>
    <deploy-app file="bin/StarterApplication-all.wlapp" runtime="{mfp.runtime.name}"/>
  </wladm>
</target>
</project>

```

## Building applications from IBM Worklight V6.0.0 and deploying them to MobileFirst Server

Users who want to build applications and adapters from IBM Worklight V6.0.0 to their current version of MobileFirst Server must use two Ant scripts, one to build their artifacts and one to deploy them.

If you want to build apps and adapters from a IBM Worklight V6.0.0 project and deploy them to a MobileFirst Server, you might think that all you need to do is add a <taskdef> definition as shown in the following Ant task.

### Note:

- *WL600\_DIR* is the directory where you installed IBM Worklight V6.0.0.
- *product\_install\_dir* is the directory where you installed the current version of MobileFirst Server.

```

<taskdef resource="com/worklight/ant/defaults.properties">
  <classpath>
    <pathelement location="WL600_DIR/WorklightServer/worklight-ant.jar" />
  </classpath>
</taskdef>

<taskdef resource="com/worklight/ant/deployers/antlib.xml">
  <classpath>
    <pathelement location="product_install_dir/WorklightServer/worklight-ant-deployer.jar" />
  </classpath>
</taskdef>

```

However, the JAR files *worklight-ant.jar* and *worklight-ant-deployer.jar* conflict, because they contain classes with the same name in different versions. To solve this conflict, you must split the script into two different Ant files: one to build V6.0.0 artifacts and the other to deploy them to MobileFirst Server, as shown in the following examples.

### Ant script to build V6.0.0 artifacts

```

<project basedir="." default="build-and-deploy">

  <property name="project.name" value="MyProject" />
  <property name="wl.server" value="http://localhost:9080/${project.name}/" />
  <property name="wl.project.location" location="{basedir}/${project.name}" />
  <property name="output.location" location="{wl.project.location}/bin" />

  <property name="wl.adapter.name" location="MyAdapter" />
  <property name="wl.application.name" location="MyApplication" />

```

```

<property name="worklight-ant" location="worklight-ant.jar" />

<target name="init">
  <taskdef resource="com/worklight/ant/defaults.properties">
    <classpath>
      <pathelement location="\${worklight-ant}" />
    </classpath>
  </taskdef>
</target>

<target name="build">
  <adapter-builder folder="\${wl.project.location}/adapters/\${wl.adapter.name}" destinationFolder="\${output.location}"/>
  <app-builder applicationFolder="\${wl.project.location}/apps/\${wl.application.name}" outputFolder="\${output.location}"
worklightserverhost="\${wl.server}" nativeprojectprefix="\${project.name}"/>
</target>

<target name="deploy">
  <ant antfile="deploy.xml" inheritall="true" />
</target>

<target name="build-and-deploy" depends="init,build,deploy" />
</project>

```

### Ant script to deploy V6.0.0. artifacts to MobileFirst Server

```

<project basedir="." default="deploy">

  <property name="worklight-ant-deployer" location="worklight-ant-deployer.jar" />

  <target name="init">
    <taskdef resource="com/worklight/ant/defaults.properties">
      <classpath>
        <pathelement location="\${worklight-ant-deployer}" />
      </classpath>
    </taskdef>
  </target>

  <target name="deploy" depends="init">
    <wladm url="https://server-address:secure-port/worklightadmin" user="username" password="password">
      <deploy-app runtime="project-name" file="\${output.location}/\${wl.application.name}-all.wlapp"/>
      <deploy-adapter runtime="project-name" file="\${output.location}/\${wl.adapter.name}.adapter"/>
    </wladm>
  </target>
</project>

```

## Deploying applications and adapters

You can use Ant tasks to deploy MobileFirst applications and adapters.

The following sections show examples of Ant XML files that use the **wladm** Ant task to deploy applications and adapters. You can run these Ant files locally on the MobileFirst Server host computer or remotely on a different computer. To run them remotely on a different computer, you must first copy the file *product\_install\_dir/WorklightServer/worklight-ant-deployer.jar* to that computer.

### Deploying an application

**Note:** Before you use this Ant task, as a prerequisite step, you must deploy the corresponding MobileFirst project of the application. For more information, see “Deploying the project WAR file” on page 10-5.

A typical Ant script for deploying an application has the following structure:

```

<?xml version="1.0" encoding="UTF-8"?>
<project basedir="." default="target-name">
  <taskdef resource="com/worklight/ant/deployers/antlib.xml">
    <classpath>
      <pathelement location="product_install_dir/WorklightServer/worklight-ant-deployer.jar"/>
    </classpath>
  </taskdef>

```

```

    </classpath>
  </taskdef>
  <target name="target-name">
    <wladm url="https://server-address:secure-port/worklightadmin" user="username" password="password">
      <deploy-app runtime="project-name" file="myApp.wlapp"/>
    </wladm>
  </target>
</project>

```

The <wladm> element has the following attributes:

Table 10-12. Attributes of the <wladm> element

Attribute	Mandatory/ Optional	Description
<b>url</b>	Mandatory	The full URL of your MobileFirst Server web application for administration services
<b>user</b> and <b>password</b>	Mandatory	The credentials of a user in a <b>worklightadmin</b> or <b>worklightdeployer</b> role

The <deploy-app> element has the following attributes:

Table 10-13. Attributes of the <deploy-app> element

Attribute	Mandatory/ Optional	Description
<b>runtime</b>	Mandatory	The name of the MobileFirst runtime / project.
<b>file</b>	Mandatory	Contains the .wlapp file to deploy.

For more information about <wladm>, see “Administering MobileFirst applications through Ant” on page 11-11.

If you must deploy more than one .wlapp file, either add a <deploy-app> element for each file in a single <wladm> element, or add a <wladm> element for each file.

## Deploying an adapter

**Note:** Before you use this Ant task, as a prerequisite step, you must deploy the corresponding MobileFirst project of the adapter. For more information, see “Deploying the project WAR file” on page 10-5.

A typical Ant script for deploying an adapter has the following structure:

```

<?xml version="1.0" encoding="UTF-8"?>
<project basedir="." default="target-name">
  <taskdef resource="com/worklight/ant/deployers/antlib.xml">
    <classpath>
      <pathelement location="product_install_dir/WorklightServer/worklight-ant-deployer.jar"/>
    </classpath>
  </taskdef>
  <target name="target-name">
    <wladm url="https://server-address:secure-port/worklightadmin" user="username" password="password">
      <deploy-adapter runtime="project-name" file="myAdapter.adapter"/>
    </wladm>
  </target>
</project>

```

The <wladm> element has the following attributes:

Table 10-14. Attributes of the <wladm> element

Attribute	Mandatory/ Optional	Description
<b>url</b>	Mandatory	The full URL of your MobileFirst Server web application for administration services
<b>user</b> and <b>password</b>	Mandatory	The credentials of a user in a <b>worklightadmin</b> or <b>worklightdeployer</b> role

The <deploy-adapter> element has the following attributes:

Table 10-15. Attributes of the <deploy-adapter> element

Attribute	Mandatory/ Optional	Description
<b>runtime</b>	Mandatory	The name of the MobileFirst runtime / project.
<b>file</b>	Mandatory	Contains the .adapter file to deploy.

For more information about <wladm>, see “Administering MobileFirst applications through Ant” on page 11-11.

If you must deploy more than one .adapter file, either add a <deploy-adapter> element for each file in a single <wladm> element, or add a <wladm> element for each file.

## Deploying applications and adapters to MobileFirst Server

You can deploy customer-specific content (apps and adapters) only after the project WAR file is deployed and the server is started.

### About this task

Customer-specific content includes applications that must be served by IBM MobileFirst Platform Server and their underlying integration adapters. You can create apps and adapters by building them using IBM MobileFirst Platform Command Line Interface for iOS, or with the Ant tasks provided with IBM MobileFirst Platform Foundation for iOS to build them. The result of the build action is files with extension .wlap and .adapter respectively.

There are two ways to deploy applications and adapters to IBM MobileFirst Platform Operations Console:

- Use Ant tasks that are provided with IBM MobileFirst Platform Foundation for iOS, and described in “Ant tasks for building and deploying applications and adapters” on page 10-69 and “Deploying a project WAR file and configuring the application server with Ant tasks” on page 10-14.
- Use MobileFirst Operations Console to manually deploy apps and adapters.

You can deploy customer-specific content (apps and adapters) only after the project and MobileFirst administration WAR files are deployed and the server is started.



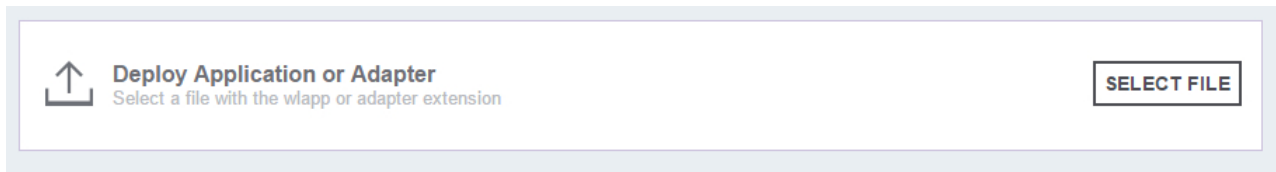

Figure 10-2. Deploying an adapter or an application from MobileFirst Operations Console

### Procedure

1. To deploy an **adapter**, click **SELECT FILE**. Then, navigate to the adapter file and select it. A message is displayed that indicates whether the deployment action succeeded or failed.
2. Click **ADAPTERS** to display the adapter list.
3. In the adapter list, expand the deployed adapter to display connectivity details.
4. Repeat steps 1 to 3 for each adapter that you want to deploy.
5. To deploy an **application**, either deploy the `app_name-all.wlap` file, or individual `app_name-environment_name-version.wlap` files. For each of these files, click **SELECT FILE**. Then, navigate to the WLAPP file and select it. A message is displayed that indicates whether the deployment action succeeded or failed.
6. In the application list, click the deployed application to display details of environments and versions.
7. Repeat steps 5 and 6 for each app that you want to deploy.

## Administering adapters and apps in MobileFirst Operations Console

You administer adapters and apps through MobileFirst Operations Console.

### About this task

Before performing any of the other tasks in this collection of topics, open MobileFirst Operations Console:

### Procedure

1. Open a browser and enter a URL of the following form: `https://hostname:secure-port/worklightconsole` where *secure-port* depends on your server configuration. The defaults are 9443 for WebSphere Application Server and 8443 for Apache Tomcat.

**Note: Security warning.** If you access MobileFirst Operations Console through `http` instead of `https`, your MobileFirst administration user password will be compromised.

This usage is different from the MobileFirst Development Server, where no security is used. In the development environment, you use the port for the Liberty profile server in the URL: `http://localhost:10080/worklightconsole`.

2. If your MobileFirst Server is configured to require login, and you are not currently logged in, log in when prompted to do so.

## Results

If only one project is deployed on the server, you see the Catalog page of MobileFirst Operations Console and you can start performing administration tasks.

If several projects are deployed on the server, you see a list of projects in MobileFirst Operations Console. Select the project to administer to navigate to the Catalog page of this project.

## Deploying apps

You can select WLAPP files to deploy.

### Procedure

To deploy an app, you deploy either the *app\_name-all.wlapp* file, or individual *app\_name-environment\_name-version.wlapp* files. For each of these files, perform the following steps:

1. From a runtime or the applications list, click **SELECT FILE** in the deployment section.
2. Navigate to your WLAPP file and select it.

### Results

A message is displayed that indicates whether the deployment action succeeded or failed.

## Deleting apps

You can delete an app or a version of an environment of an app.

### About this task

An application can be provided in different mobile device environments, such as a tablet version and a phone version. You can delete the whole app or an environment version only.

### Procedure

Delete an entire app or a version of an environment of an app.

- To delete an app, in the application list, click the delete icon represented by a cross at the end of the application row.
- To delete a version of an environment of an app:
  1. To open the details of the environment, click the name of the app.
  2. Select the icon of the version of the environment to delete; for example, iPad.
  3. Click **DELETE**.

## Exporting adapter configuration files

Export the configuration files for the adapter by copying them from the source folder.

### Procedure

To export a deployed adapter:

Obtain the adapter from the development environment.

1. Navigate to the /bin folder in your project
2. Copy the .adapter file or files.

### **Deploying adapters**

Deploy an adapter from the MobileFirst Operations Console.

#### **Procedure**

To deploy an adapter:

1. From a runtime or the adapters list, click **SELECT FILE** in the deployment section.
2. Navigate to your adapter file and select it. A message is displayed that indicates whether the deployment action succeeded or failed.
3. Expand the deployed adapters to view the connectivity details and the list of procedures that it shows.

### **Modifying adapters**

To modify an adapter, replace it with a new one.

#### **Procedure**

To modify an adapter:

Deploy the modified adapter file, as described in “Deploying adapters.”

#### **Results**

The new adapter replaces the original one.

### **Deleting adapters**

Delete an adapter from MobileFirst Operations Console by clicking **DELETE**.

#### **Procedure**

To delete an adapter:

In the adapter list, click **DELETE** in the adapter row.

## **MobileFirst security overview**

IBM MobileFirst Platform Foundation for iOS has comprehensive support for various authentication and authorization methods.

### **MobileFirst security basics**

The following image shows the authentication elements hierarchy:

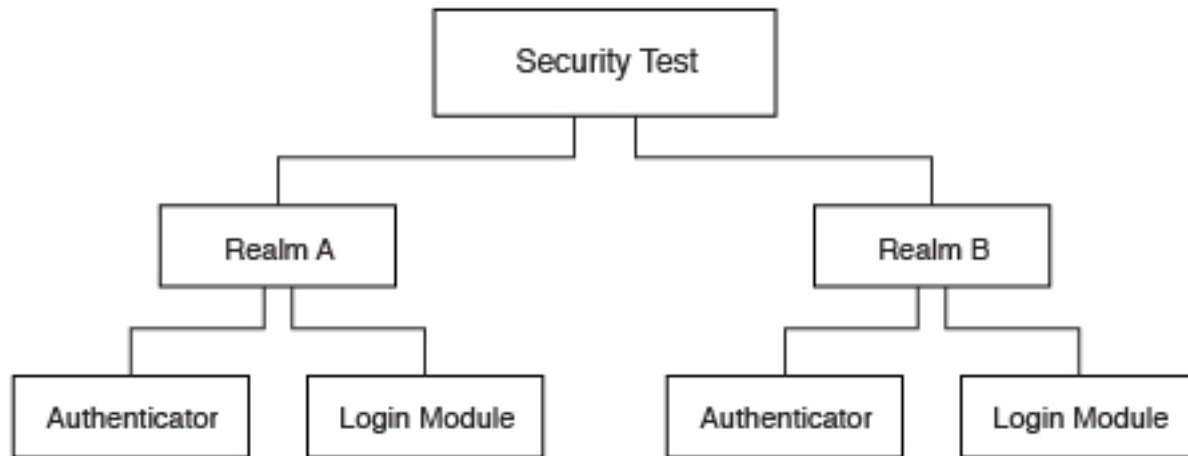

### Security test

A security test is a set of tests that are used to protect a resource, such as an adapter procedure or application environment. A test includes information about which realm is required to authenticate and other parameters, such as authentication order. A protected resource is accessible only after the client authenticates to all of the tests that are specified in the security test. If the client is unable to log in to all tests, the request to access the protected resource is denied. Individual adapter procedures or an entire application environment can be protected by a security test. For more information about security tests and the different types of security tests, see “Security tests” on page 8-249.

**Realm** A realm creates a relationship between a MobileFirst login module and a MobileFirst authenticator to provide a means of authentication. For more information about realms, see “Authentication realms” on page 8-252.

### Authenticator

An authenticator parses incoming requests from a MobileFirst client to search for required credentials when a protected resource is requested. If credentials are not available in the request, the authenticator is responsible for challenging the client to authenticate. The credentials, after received correctly from the client, are formatted to the login module's predefined requirements and sent to the login module. For more information about authenticators, see “Authenticators and login modules” on page 8-257.

### Login module

After an authenticator is able to parse credentials from a request, they are sent to a login module that is responsible for validating those credentials. After the credentials are considered valid and the user can be authorized, the login module creates a user identity for the realm. For more information about login modules, see “Authenticators and login modules” on page 8-257.

### User identity

After a login module successfully validates a set of user credentials, it creates a user identity. A user identity contains at least a user name and a display name. It can also contain attributes that provide more details the protected resource might need.

### Challenge handlers

A challenge handler is the client-side JavaScript that is included into a MobileFirst application that is created by the developer. A challenge

handler handles an authentication challenge from the server. A challenge handler can be defined for each realm, and is responsible for the following tasks:

- Determine whether a request is an authentication challenge that is specific to the realm.
- Perform necessary user interaction if it receives a challenge.
- Send the credentials to the server to complete the authentication.
- Validate that the authentication was successful.

## MobileFirst security configuration

For MobileFirst Server to protect a resource, such as an adapter procedure or an application environment, the administrator must first configure the MobileFirst Server instance.

### Defining a login module

A login module is the most basic security element in the MobileFirst authentication configuration. You can define a login module in the `<loginModules>` element in the `authenticationConfig.xml` file. The following example shows a login module definition:

```
<loginModules>
...
  <loginModule name="HeaderLogin"
    audit="true
    expirationInSeconds="-1">
    <className>com.worklight.core.auth.ext.HeaderLoginModule</className>
    <parameter name="user-name-header" value="userid" />
    <parameter name="display-name-header" value="username" />
  </loginModule>
...
</loginModules>
```

In this example, the login module is called `HeaderLogin` and is referred to from a realm element. The `<className>` element must contain the full Java namespace to a login module implementation. The `HeaderLoginModule` is a login module that is included by default. It checks that the user entered any, non-empty user name and password.

### Defining a realm

After a login module is defined, you must specify a realm. You can add a realm to the `<realms>` element in the `authenticationConfig.xml` file. The following example shows a realm definition:

```
<realms>
...
  <realm name="RequiresUserHeaders" loginModule="HeaderLogin">
    <className>com.worklight.core.auth.ext.HeaderAuthenticator</className>
  </realm>
...
</realms>
```

### Defining a security test

You can define a security test in the `<securityTests>` element in the `authenticationConfig.xml` file. The following example shows a security test definition:

```

<securityTests>
...
  <customSecurityTest name="BasicRequirements">
    <test realm="wl_antiXSRFRealm" />
    <test realm="wl_authenticityRealm" />
    <test realm="wl_remoteDisableRealm" />
    <test realm="RequiresUserHeaders" isInternalUserID="true" />
    <test realm="wl_deviceNoProvisioningRealm" isInternalDeviceID="true" />
  </customSecurityTest>
...
</securityTests>

```

This custom security test is called `BasicRequirements`, and contains a list of tests. The tests define which realms are required for authorization into the protected resource. The tests in this example are built-in realms. Built-in realms are prefixed with `wl_`.

**Note:** If one test fails, then the entire security test fails.

The `isInternalUserID` attributes can be set to `true` only on a single realm. This attribute is used as the default identity for a user in the security test. The `isInternalDeviceID` attribute is similar, but sets a default device identity.

This example uses the `RequiresUserHeaders` realm in the previous example.

### Creating a challenge handler

You must create a challenge handler for your MobileFirst app to handle any custom challenges.

For more information about challenge handlers, see the tutorials on the following Getting Started pages of the Developer Center: [Custom Authentication](#) and [Custom Authentication in native iOS applications](#).

### MobileFirst application environment protection

After a security test is configured with the appropriate realms, you can protect any resource. One option is to completely protect an application's environment with that security test.

To set up this protection, you must add the `securityTest` attribute to the environment's element in the `applicationDescriptor.xml` file. The following example shows the environment protection definition:

```

<iPhone version="1.0" securityTest="BasicRequirements">
...
</iPhone>

```

This definition requires every iPhone device that connects to the server through your application to log in to the `BasicRequirements` security test.

### MobileFirst adapter procedure protection

Another option is to protect a MobileFirst adapter procedure. Using the same security test, you can protect an adapter procedure. When the procedure is called and the user is not already authenticated into the security test, the client is required to authenticate. If you have an adapter procedure named `GetSecretData`, you can protect it in the adapter's XML configuration file by adding the `securityTest` attribute to the `<procedure>` element:

```
<procedure name="GetSecretData" securityTest="BasicRequirements" />
```

## MobileFirst Security and LTPA

Lightweight Third-Party Authentication (LTPA) is a security token type that is used by IBM WebSphere Application Server and other IBM products. LTPA can be used to send the credentials of an authenticated user to backend services. It can also be used as a single sign-on (SSO) token between the user and multiple servers.

The following image shows a simple client/server flow with LTPA:

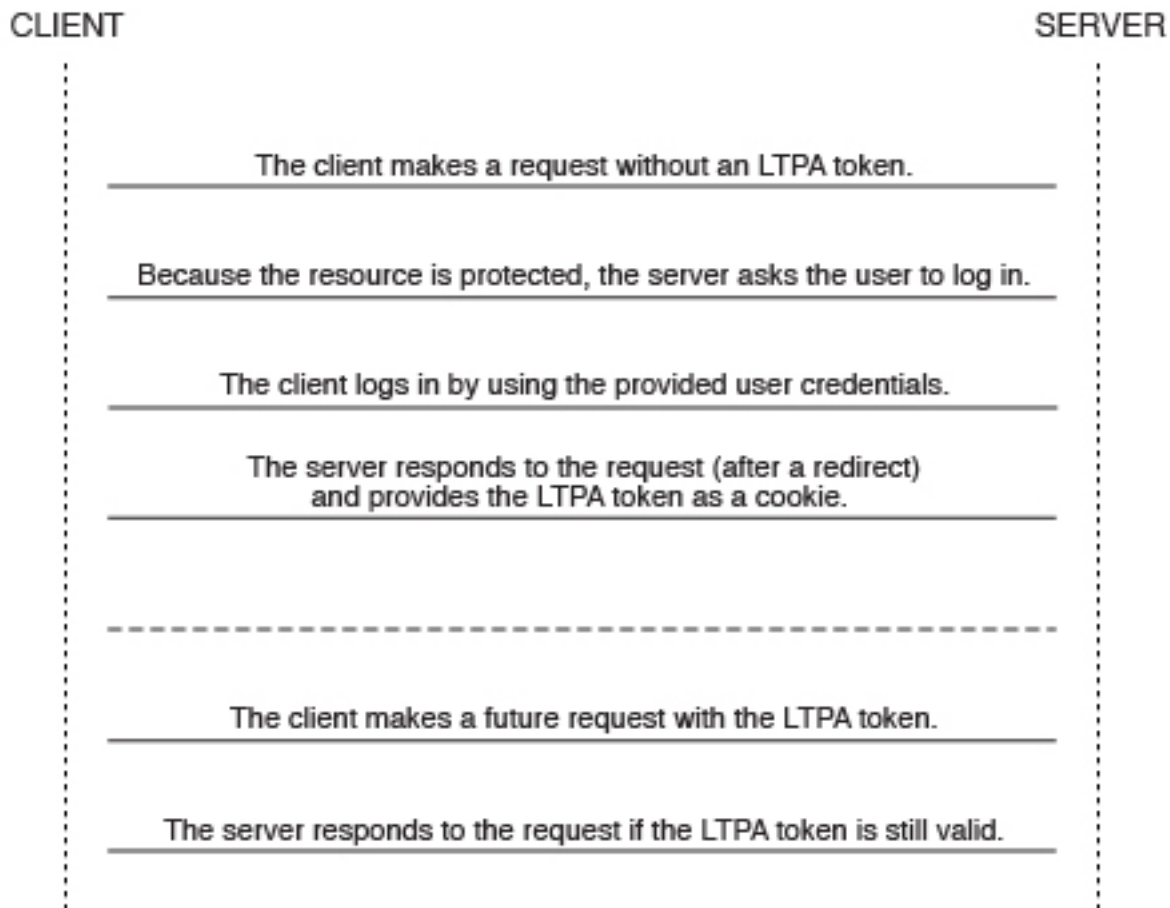

After a user logs in, the server generates an LTPA token, which is an encrypted hash that contains authenticated user information. The token is signed by a private key that is shared among all the servers that want to decode it. The token is usually in cookie form for HTTP services. By sending the token as a cookie, there is no need for subsequent user interaction.

LTPA tokens have a configurable expiration time to reduce the possibility for session hijacking.

The following image shows a client-server-backend flow with LTPA:

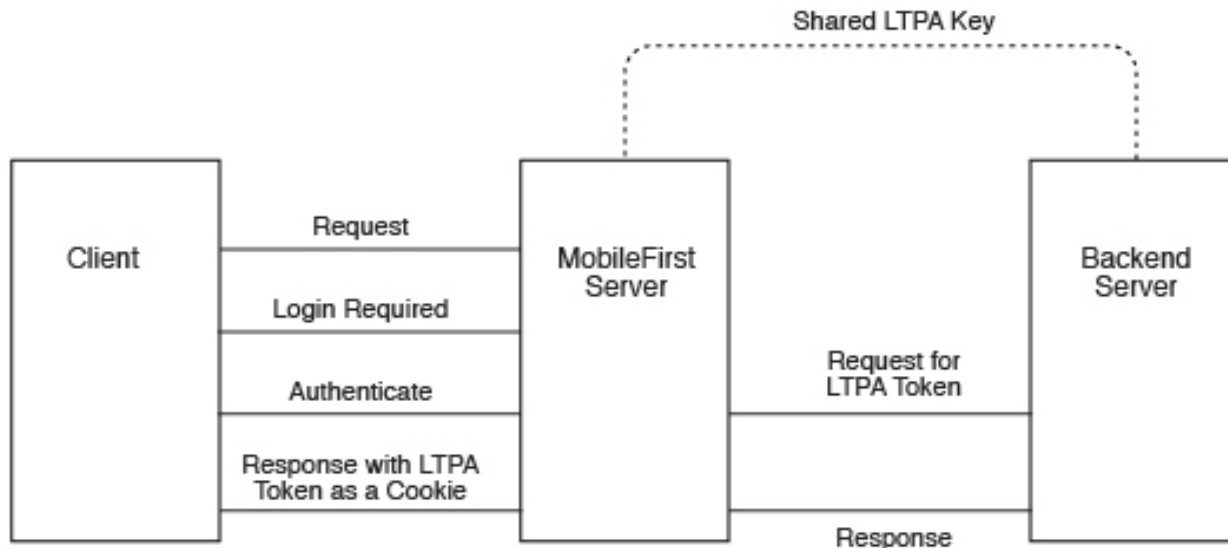

Your infrastructure can also use the LTPA token to communicate with a backend server to act on behalf of the user. The user cannot directly access the backend server. Enterprise environments should use a reverse proxy, such as DataPower or IBM Security Access Manager, in the DMZ, and place the MobileFirst Server in the intranet. This configuration ensures that access to the MobileFirst Server cannot be obtained until a user authenticates. For more information, see “Reverse proxy with LTPA” on page 10-94.

### Configuring the MobileFirst LTPA realm:

The IBM MobileFirst Platform Server contains the authenticator and login module that are designed to handle authentication by using LTPA through form-base authentication.

#### About this task

You must update the `authenticationConfig.xml` file to configure your server to use the MobileFirst LTPA realm.

#### Procedure

1. Add the login module definition to the `<loginModules>` element in your server’s `authenticationConfig.xml` file. The following example uses a login module that is called `WASLTPAModule`:

```

<loginModules>
...
  <loginModule name="WASLTPAModule">
    <className>com.worklight.core.auth.ext.WebSphereLoginModule</className>
  </loginModule>
...
</loginModules>
  
```

2. Add the realm definition to the `<realms>` element in your server’s `authenticationConfig.xml` file. The following example uses a realm that is called `WASLTPAR realm`:

```

<realms>
...
  <realm name="WASLTPAR realm" loginModule="WASLTPAModule">
    <className>com.worklight.core.auth.ext.WebSphereFormBasedAuthenticator</className>
  </realm>
...
</realms>
  
```



```

        <parameter name="login-page" value="/login.html" />
        <parameter name="error-page" value="/loginError.html" />
    </realm>
    ...
</realms>

```

3. Add a user test to an existing test in the authenticationConfig.xml file.

```

<customSecurityTest name="LTPASecurityTest">
    <test realm="wl_authenticityRealm" />
    <test realm="WASLTPARealm" isInternalUserID="true" />
    <test realm="wl_deviceNoProvisioningRealm" isInternalDeviceID="true" />
</customSecurityTest>

```

4. Create a login page and a login error page. The WASLTPARealm must know which HTML file to present to the client when the client must authenticate. This HTML file must be named login.html. When the client enters invalid credentials, the WASLTPARealm presents an error HTML file. This HTML file must be named loginError.html. These HTML files must be added to the root directory in the MobileFirst Server WAR file. The following example shows a sample login.html file:

```

<html>
  <head>
    <title>Login</title>
  </head>
  <body>
    <form method="post" action="j_security_check">
      <input type="text"
        id="j_username"
        name="j_username"
        placeholder="User name" />
      <input type="password"
        id="j_password"
        name="j_password"
        placeholder="Password" />
      <input type="submit" id="login" name="login" value="Log In" />
    </form>
  </body>
</html>

```

The following example shows a sample loginError.html file:

```

<html>
  <head>
    <title>Login Error</title>
  </head>
  <body>
    An error occurred while trying to log in.
  </body>
</html>

```

## Configuring the MobileFirst Server for Trusteer

Configure the IBM MobileFirst Platform Server to use Trusteer<sup>®</sup>-generated data to protect resources.

### About this task

You must update the authenticationConfig.xml file to configure your server to use the MobileFirst Trusteer realm.

**Note:** If code that uses the Trusteer realm accesses a resource that is protected by OAuth authentication, and the client has a valid token, the MobileFirst Server is not called. As a result, the server does not check whether the device passes all of the configured Trusteer parameters. The MobileFirst Server is called when the

token expires or when the Trusteer realm inside the token expires. When the realm expires, the Trusteer authenticator is invoked and the server checks whether the devices passes all of the configured Trusteer parameters.

### Procedure

1. Add the login module definition to the <loginModules> element in your server's authenticationConfig.xml file. The following example uses a login module that is called trusteeFraudDetectionLogin:

```
<loginModules>
...
<loginModule name="trusteerFraudDetectionLogin">
  <className>com.worklight.core.auth.ext.TrusteerLoginModule</className>
</loginModule>
...
</loginModules>
```

2. Add the realm definition to the <realms> element in your server's authenticationConfig.xml file. The following example uses a realm that is called wl\_basicTrusteerFraudDetectionRealm:

```
<realms>
...
<realm name="basicTrusteerFraudDetectionRealm" loginModule="trusteerFraudDetectionLogin">
  <className>com.worklight.core.auth.ext.TrusteerAuthenticator</className>
  <parameter name="rooted-device" value="block"/>
  <parameter name="device-with-malware" value="block"/>
  <parameter name="rooted-hiders" value="block"/>
  <parameter name="unsecured-wifi" value="alert"/>
  <parameter name="outdated-configuration" value="alert"/>
</realm>
...
</realms>
```

The possible values for Trusteer realm parameters are described in Table 10-16.

Table 10-16. Possible values for Trusteer realm parameters

Value	Description
block	Access fails.
alert	Access is permitted and it is recommended to issue a warning.
accept	Access is permitted.

The error codes that have been defined for Trusteer correspond to the parameters in the realm. See Table 10-17.

Table 10-17. Trusteer error codes

Code	Description	Corresponding parameter
TAS_ROOT		rooted-device
TAS_MALWARE	Indicates that the device contains malware. Currently financial malware is detected, but will be expanded to all malware.	device-with-malware

Table 10-17. Trusteer error codes (continued)

Code	Description	Corresponding parameter
TAS_ROOT_EVIDENCE	Indicate that the device contains root hider applications that hide the fact that the device is rooted/jailbroken.	rooted-hiders
TAS_WIFI	Indicates that the device is currently connected to an unsecured Wi-Fi.	unsecured-wifi
TAS_OUTDATED	Indicates that Trusteer SDK configuration has not updated for some time, meaning that it did not connect to the Trusteer server.	outdated-configuration
TAS_INVALID_HEADER	Indicates that the format of the Trusteer header is invalid.	-
TAS_NO_HEADER	Indicates that the Trusteer SDK is not installed, or has failed to initialize.	-

3. Define a security test in the <securityTest> element in the authenticationConfig.xml file. For Trusteer, it could be:

```
<customSecurityTest name="TrusteerTest">
  <test realm="wl_basicTrusteerFraudDetectionRealm" isInternalUserID="true" step="1"/>
  ...
</customSecurityTest>
```

4. Use the security test to protect a resource. For example, you can protect an application's environment completely with that security test by adding the securityTest attribute to the environment's element in the authenticationConfig.xml file:

```
<iPhone version="1.0" securityTest="TrusteerTest">
  ...
</iPhone>
```

This definition requires every iPhone device that connects to the server through your application to log in to the TrusteerTest security test.

5. Using the same security test, another option is to protect a MobileFirst adapter procedure. . If you have an adapter procedure named GetSecretData, you can protect it in the XML configuration file of the adapter by adding the <realms> attribute to the <procedure>:

```
<procedure name="GetSecretData" securityTest="TrusteerTest" />
```

6. Create a challenge handler for your MobileFirst app to handle Trusteer challenges. The following samples are samples of simple challenge handlers:

#### JavaScript

```
var trusteerChallengeHandler = WL.Client.createWLChallengeHandler("wl_basicTrusteerFraudDetectionRealm");

trusteerChallengeHandler.handleFailure = function(error) {
  //Note: error object includes array of alerts (same values as error.reason) from the
  //Trusteer authenticator and can be accessed via error.alerts
  WL.SimpleDialog.show("Error", "Operation failed. Please contact customer support (reason code: " + error.reason + ")",
    [{text:"OK"}]);
};
```

//In case authenticator succeeds, there may still be alerts that developer should notify the user about:

```
trusteerChallengeHandler.processSuccess = function(identity){
    var alerts = identity.attributes.alerts; //Array of alerts codes
    if(alerts.length > 0) {
        WL.SimpleDialog.show("Warning", "Please note that your device is : " + alerts, [{text:"OK"}]);
    }
}
```

### Java

```
public class TrusteerChallengeHandler extends WLChallengeHandler {

    private static Logger logger = Logger.getInstance(TrusteerChallengeHandler.class.getSimpleName());
    public TrusteerChallengeHandler(String realmName) { super(realmName); }

    @Override
    public void handleSuccess(JSONObject identity) {
        try {
            JSONArray alerts = identity.getJSONObject("attributes").getJSONArray("alerts");
            if(alerts.length() > 0) {
                logger.warn ("TrusteerChallengeHandler.handleSuccess with alerts: " + alerts);
                //todo: display message to the user
            }
        } catch (Exception e) {
            logger.error("Unexpected error: " + e);
        }
    }

    @Override
    public void handleFailure(JSONObject error) {
        try {
            String errorReason = error.getString("reason");
            logger.error("TrusteerChallengeHandler.handleFailure: " + errorReason + "(" + error + ")");
            String msg = "Trusteer fraud detection failed due to " + errorReason;
            JSONArray alerts = error.getJSONArray("alerts");
            if(alerts.length() > 0) {
                logger.warn ("TrusteerChallengeHandler.handleSuccess with alerts: " + alerts);
                //todo: We also have alerts...
            }
            //todo: display error message to user
        } catch (Exception e) {
            logger.warn ("Unexpected error: " + e);
        }
    }

    @Override
    public void handleChallenge(JSONObject challenge) {
        //Nothing to do...
    }
}

// Register your newly created challenge handler for your Trusteer realm:
WLClient.getInstance().registerChallengeHandler(
    new TrusteerChallengeHandler("wl_basicTrusteerFraudDetectionRealm")
);
```

### Objective-C

```
// Assuming you have added a Trusteer realm to the authentication configuration file of
// your server, you can register a challenge handler to receive the responses from
// the authenticator.
```

```
// Create a class that extends WLChallengeHandler:
#import "WLChallengeHandler.h"
```

```

@interface TrusteerChallengeHandler : WLChallengeHandler
@end

// Register your newly created challenge handler for your Trusteer realm:
[[WLClient sharedInstance] registerChallengeHandler:
[[TrusteerChallengeHandler alloc] initWithRealm:@"
wl_basicTrusteerFraudDetectionRealm"]];

// If you have set one of your realm options to block, a blocking event will trigger handleFailure.
@implementation TrusteerChallengeHandler
//...
-(void) handleFailure: (NSDictionary *)failure{
    NSLog(@"Your request could not be completed. Reason code: %@",
        failure[@"reason"]);
}
//...
@end

// If your have set one of your realm options to alert, you can catch the alert event
// by implementing the handleSuccess method.
@implementation TrusteerChallengeHandler
//...
-(void) handleSuccess:(NSDictionary *)success{
    NSArray* alerts = success[@"attributes"][@"alerts"];
    if(alerts && alerts.count){
        for(NSString* alert in alerts){
            NSLog(@"This device is %@", alert);
        }
    }
}
//...
@end

```

## Accessing Trusteer risk assessment

Access Trusteer risk assessment to add Trusteer protection on the client side.

For an application that is running on a rooted device, you might want to disable the "Transfer Funds" button entirely, in addition to the server-side security tests described in "Configuring the MobileFirst Server for Trusteer" on page 10-85.

The following code samples are for JavaScript, Java, and Objective-C:

### JavaScript

```
WL.Trusteer.getRiskAssessment(onSuccess);
```

Where `onSuccess` is a function that receives a JSON object that contains all the data processed by Trusteer. See Trusteer documentation for information on each risk item.

```

function onSuccess(result){
    //See the logs for full result
    WL.Logger.debug(JSON.stringify(result));
    //Check for a specific flag
    if(result["os.rooted"]["value"] != 0){
        alert("This device is rooted!");
    }
}

```

### Objective-C

```

#import "WLTrusteer.h"
NSDictionary* risks =[[WLTrusteer sharedInstance] riskAssessment];

```

This returns an `NSDictionary` of all the data that is processed by Trusteer. See Trusteer documentation for information on each risk item.

```

//See logs for full result
NSLog(@"%@",risks);
//Check for a specific flag
NSNumber* rooted = [[risks objectForKey:@"os.rooted"] objectForKey:@"value"];
if([rooted intValue] != 0){
    NSLog(@"Device is jailbroken!");
}

```

## Java

```

WLTrusteer trusteeer = WLTrusteer.getInstance();
JSONObject risks = trusteeer.getRiskAssessment();

```

This returns an JSONObject of all the data that is processed by Trusteer. See Trusteer documentation for information on each risk item.

```

JSONObject rooted = (JSONObject) risks.get("os.rooted");
if(rooted.getInt("value") > 0){
    //device is rooted
}

```

## Supported configurations for LTPA

IBM MobileFirst Platform Foundation for iOS supports different configuration options to take advantage of LTPA, based on the server configuration and administrative requirements.

### Protective application server (Option 1)

This configuration is formally known as Option 1 in tutorial *WebSphere LTPA-based authentication*, which you can find on the Getting Started page. The application server is configured to protect all resources in the MobileFirst Server application, which is given specified roles. The application server sends the login page if the user does not send a valid LTPA token with the request. After the user sends valid credentials, the original request is sent to the MobileFirst Server application with an LTPA token. The LTPA realm consumes the LTPA token and automatically logs in the user.

The following image shows a protective application server flow:

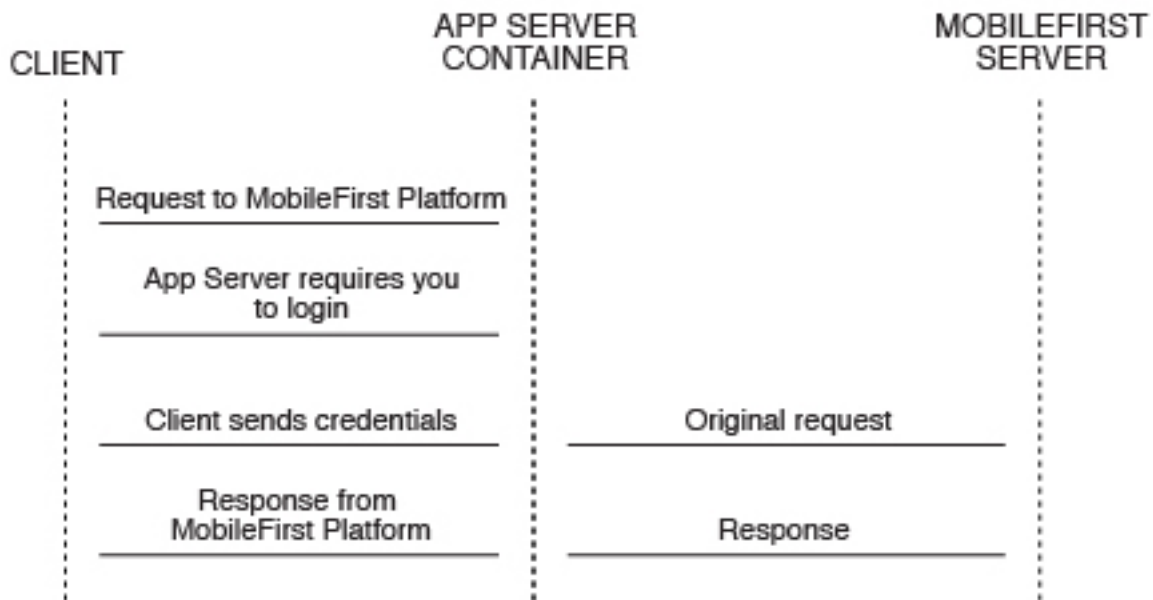

This option is not preferred for new configurations. The application server such as the WebSphere Application Server Liberty (Liberty) protects all resources and forces users to log in before any other authentication mechanism. The behavior occurs regardless of the expected authentication order for a security test.

To use this option with Liberty, you must edit the `web.xml` from the MobileFirst Server WAR file and Liberty's `server.xml` file. The following example shows the required modifications to the `web.xml` file:

```

<!-- Existing web.xml configuration here -->

<security-constraint id="worklightSecurityConstraint">
  <web-resource-collection id="worklightWebResourceCollection">
    <web-resource-name>Worklight Server</web-resource-name>
    <description>Protection area for Worklight Server.</description>
    <url-pattern>*/</url-pattern>
    <http-method>GET</http-method>
    <http-method>POST</http-method>
  </web-resource-collection>
  <auth-constraint id="worklightAuthConstraint">
    <description></description>
    <role-name>allAuthenticationUsers</role-name>
  </auth-constraint>
  <user-data-constraint id="worklightUserDataConstraint">
    <transport-guarantee>NONE</transport-guarantee>
  </user-data-constraint>
</security-constraint>

<security-role id="securityRoleAllAuthenticatedUsers">
  <description>All Authenticated Users Role.</description>
  <role-name>allAuthenticationUsers</role-name>
</security-role>

<login-config>
  <auth-method>FORM</auth-method>
  <form-login-config>

```

```

    <form-login-page>/login.html</form-login-page>
    <form-error-page>/loginError.html</form-error-page>
  </form-login-config>
</login-config>

```

The following example shows the required modifications to the server.xml file:

```

<featureManager>
  <feature>appSecurity-1.0</feature>
  <!-- Any additional features you need go here -->
</featureManager>

<!-- Use an existing user registry instead if you have one.
      This registry is just an example. -->
<basicRegistry>
  <user name="sampleuser" password="demo" />
</basicRegistry>

<!-- Any additional settings go here -->
<application context-root="/worklight"
              location="worklight.war"
              name="worklight"
              type="war">
  <classloader commonLibraryRef="worklight-6.1.0,apps-common" />

  <!-- This is our addition: application-bnd.
        The security-role defines who is authorized into a role from web.xml -->
  <application-bnd>
    <security-role name="allAuthenticatedUsers">
      <special-subject type="ALL_AUTHENTICATED_USERS" />
    </security-role>
  </application-bnd>
</classloader>
</application>

```

**Note:** Remember to add the login.html and loginError.html files to the root directory in the MobileFirst Server WAR file to provide a way for the user to log in. For more information, see step 4 of “Configuring the MobileFirst LTPA realm” on page 10-84.

## Protective MobileFirst security test (Option 2)

An alternative configuration allows the server to use all of the MobileFirst security test configuration features. This option is preferred for new configurations. For example, Option 1 always asks the user to log in on the first request. Option 2 asks for the user to authenticate only when the MobileFirst Server deems that it is necessary.

The following image shows a protective security test flow:



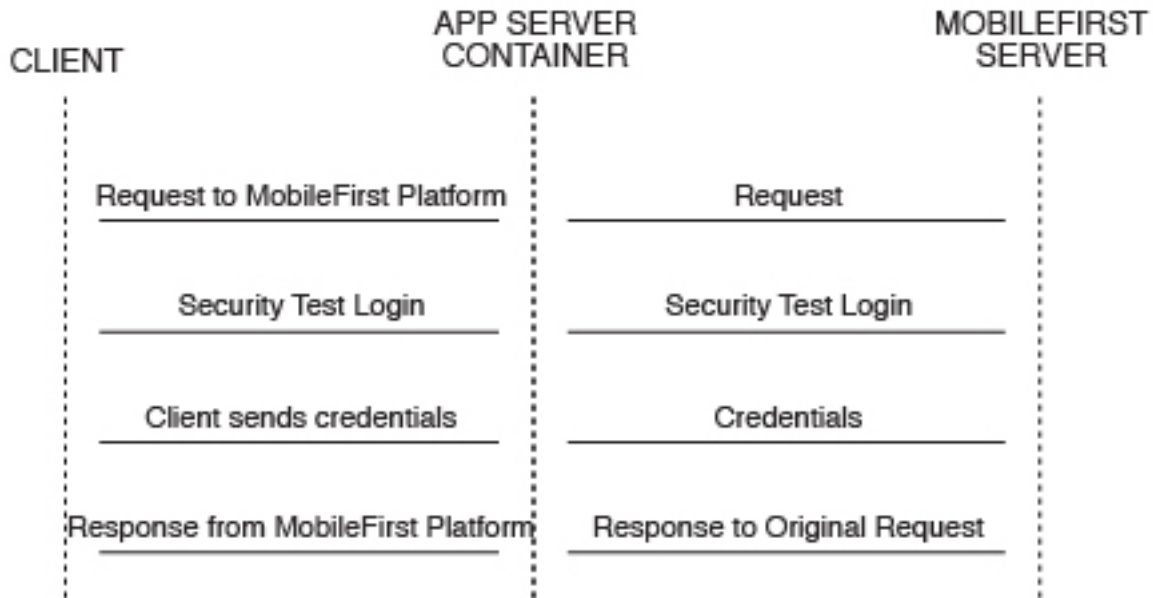

You need to modify only Liberty's `server.xml` file to configure this option. The `WASLTPARealm` handles the actual authentication against the user registry that is defined in the `server.xml` file. The example configuration allows the user with the user name `sample user` and the password `demo` to authorize correctly.

The following example shows the required modifications to the `server.xml` file:

```

<featureManager>
  <feature>appSecurity-1.0</feature>
  <!-- Any additional features you need go here -->
</featureManager>

<!-- Use an existing user registry instead if you have one.
      This registry is just an example. -->
<basicRegistry>
  <user name="sampleuser" password="demo"/>
</basicRegistry>

<!-- Any additional settings go here -->
<application context-root="/worklight"
  location="worklight.war"
  name="worklight"
  type="war">
  <classloader commonLibraryRef="worklight-6.1.0,apps-common"/>
  <!-- This is our addition: application-bnd.
      The security-role defines who is authorized into a role from web.xml -->
  <application-bnd>
    <security-role name="allAuthenticationUsers">
      <special-subject type="ALL_AUTHENTICATED_USERS" />
    </security-role>
  </application-bnd>
</classloader>
</application>
  
```

**Note:** Remember to add the `login.html` and `loginError.html` files to the root directory in the MobileFirst Server WAR file to provide a way for the user to log in. For more information, see step 4 of "Configuring the MobileFirst LTPA realm" on page 10-84.

## **Advanced security features**

IBM MobileFirst Platform Foundation for iOS supports more features that can use LTPA in advanced scenarios, such as user certificate authentication and role-based authentication.

### **Role-based authentication**

In IBM Worklight V6.1 and later, role-based authentication is supported. This feature allows the MobileFirst LTPA realm to be configured to restrict access to a specific Java Platform, Enterprise Edition role. The realm denies the user if the user is not authorized to the role that is specified. This feature is optional. By not defining a required role in the realm's configuration, all users get an LTPA token and are authorized if credentials are correct.

For more information, see “WASLTPAModule login module” on page 8-285.

### **User certificate authentication**

In IBM Worklight V6.1 and later, the User Certificate Authentication feature is supported. This form of authentication allows users to authenticate through an X.509 client certificate over SSL. The realm definition includes parameters to configure the authenticator, which includes the concept of a dependent realm. The dependent realm is a realm that is required to be authenticated before the user certificate can be generated. After the user logs in to the dependent realm, the user certificate authenticator uses the user identity to build the certificate signing request (CSR) and certificate.

### **Topologies and use cases**

IBM MobileFirst Platform Foundation for iOS supports various infrastructure topologies for a set of requirements that can take advantage of LTPA or MobileFirst security.

### **Reverse proxy with LTPA**

A reverse proxy can be used to authenticate, and then send the user's LTPA token after the user is authenticated. This configuration can be useful when you want to offload IBM MobileFirst Platform Foundation for iOS from handling vital user credentials or to use an existing authentication setup. The MobileFirst Server must be configured for LTPA authentication to get the user identity. Both supported LTPA configurations log the user in automatically if the LTPA token is valid and the user is authorized. For more information about integrating IBM MobileFirst Platform Foundation for iOS with a reverse proxy, see “Integration and authentication with a reverse proxy” on page 13-3.

The following image shows a reverse proxy flow:

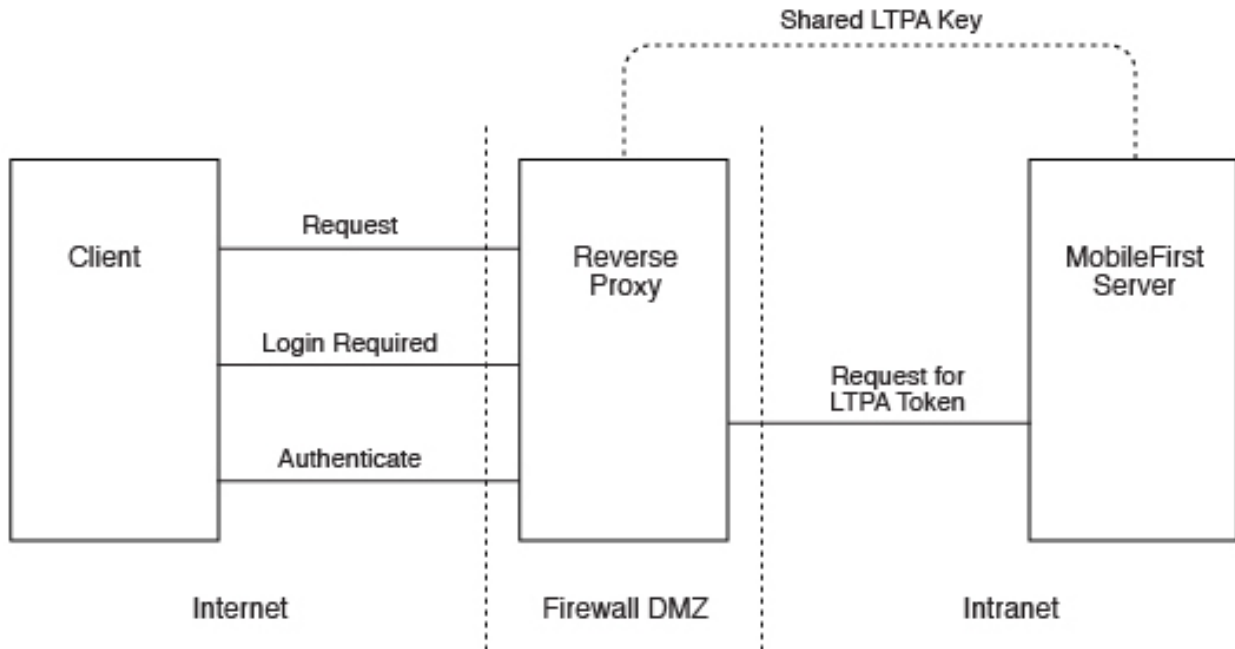

## High availability

High availability is provided through clustering, the ability to provide multiple MobileFirst Server instances acting together.

Multiple MobileFirst Server instances enable horizontal scaling of the software as well as the prevention of a single point of failure.

### Clustering

The MobileFirst Server creates a cluster by deploying multiple servers that share the database instance.

The basic setup consists of the load balancer, the cluster nodes, and a database that is shared by the cluster nodes.

All cluster nodes are identical; that is, the content of the installation folder is the same in all nodes. Cluster nodes do not synchronize with each other at run time. All management data is in the MobileFirst administration services, which verify that all cluster nodes have the same data. With WebSphere Application Server Network Deployment, you can use built in clustering support for distributing the MobileFirst project WAR (and the MobileFirst Shared library). For more information, see the IBM WebSphere Application Server V8 user documentation.

MobileFirst Server can run on a VMware virtual machine. In such cases, one machine image is created and then deployed again and again.

IBM MobileFirst Platform Foundation for iOS is *stateful*. It caches session state within the server memory. The result is that if one MobileFirst Server is taken offline, active user sessions are lost and the client is asked to log on again.

### Configuring the load balancer

You can use hardware-based or software-based load balancers.

If you do not want to use a hardware-based load balancer, you can use a simpler, software-based load balancer or reverse proxy such as the Apache Tomcat web server. Any load balancer that can support the following features is adequate:

- Mandatory: Sticky session
- Mandatory: Reverse proxy capabilities
- Optional: SSL Acceleration

Configuration of the load balancer depends on the vendor and is not covered in this document. It is common to define the range of the node addresses so that they can be added or deleted dynamically.

## **Adding a node to the cluster**

Follow the instructions for creating a IBM MobileFirst Platform Server to add a node to the cluster.

### **About this task**

You can add a node to the cluster, by following the instructions for creating a MobileFirst Server:

### **Procedure**

1. Add the IP address of the node to the load balancer or use an existing address from a range that was pre-allocated to instances of MobileFirst Server.
2. Install the MobileFirst Server.
3. Apply the project WAR.

### **Firewalls**

Firewalls can be configured at various layers of the IBM MobileFirst Platform Foundation for iOS architecture.

Firewalls in front of a MobileFirst Server use the typical configuration.

Special attention must be given to a firewall layer between the IBM MobileFirst Platform Foundation for iOS servers and the IBM MobileFirst Platform Foundation for iOS database.

- MobileFirst Server employs database connection pooling. Firewalls may detect idle database connections and terminate them resulting in unexpected behavior.
- Firewalls limit the number of connections allowed. This is done to prevent Denial of Service (DoS) attacks. However, with multiple clustered MobileFirst Server instances, the number of connections might be higher than usual.

### **Disaster Recovery Site**

IBM MobileFirst Platform Foundation for iOS supports the creation of a separate disaster recovery site that becomes operational if the original site goes down.

A disaster recovery site is a second, physically separate IT center on which a copy of the IT systems exists, and springs into operation if the original site is down. IBM MobileFirst Platform Foundation for iOS has such a site for some of its customers.

Within the site, IBM MobileFirst Platform Foundation for iOS provides redundancy at every level: compensating load balancers, multiple IBM MobileFirst Platform

Foundation for iOS servers that scale linearly, and database redundancy through Oracle RAC. Some customers prefer to provide another level of redundancy by using a disaster recovery site.

The key administrative factors for such a site are:

- Architecture
- Data mirroring from master to backup site
- Switching to back up site on disaster

#### Architecture

The architecture of the backup site is a copy of the original site. Special care must be taken to:

- Provide access to all corporate back-end systems.
- Create a switch that transfers incoming requests from master to backup site.

#### Data mirroring

For the backup site to work, data on the master site must be mirrored to the backup regularly:

Table 10-18. Data mirroring

Component	Description	Mirror frequency
IBM MobileFirst Platform Foundation for iOS Database	All tables must be mirrored. The exceptions to this rule are cache tables (SSO_LOGIN_CONTEXTS) and report tables (which are large in size).	Highly dependent on implementation and can range from a few minutes to 24 hours. For more information, contact software support.
IBM MobileFirst Platform Foundation for iOS Software, customization, and content	Any change in IBM MobileFirst Platform Foundation for iOS software, customization, or content must also be installed on the mirror servers.	As it occurs.

#### Switching to back up site

When you switch to the backup site, some information might be lost:

- All clients lose context and disconnect. In the case of an authenticated app, the user is prompted to log in again.
- Report information is lost (unless previously mirrored).
- Cache is lost. If Cache was implemented for various queries, an additional server fetch is required to fill cache.

#### Switching back to Master Site

Before you switch back to the master site, you must mirror the database back to the master site.

**Important:** The success of a recovery site is in the details. To ensure the successful functioning of such a site, you must develop and follow a strict written procedure, which you test regularly.

## Updating MobileFirst apps in production

There are general guidelines for upgrading your MobileFirst apps when they are already in production, on the Application Center or in app stores.

Deploying your MobileFirst apps for the first time to MobileFirst Server and the Application Center is covered in other sections of the information center, such as “Deploying an application from development to a test or production environment” on page 10-1. To recap, the general procedure is as follows:

- Build and test your app using IBM MobileFirst Platform Foundation for iOS, and use either the MobileFirst Operations Console or the supplied Ant tasks to deploy its .wlapp files to MobileFirst Server and the Application Center.
- Submit the generated device app files (such as .ipa for iOS) to their respective app stores (the Apple Store in this example).
- Wait for the completion of the review and approval process. Try to avoid updating your app before the review process is completed because doing so can trigger a Direct Update and can confuse the reviewers.

Procedures for upgrading your app when it is already in production are contained in this section. There are several ways to perform such upgrades, depending on their nature:

- Is the upgrade a new version of the app that contains new features or native code, or is it a bug fix or security upgrade?
- Is the upgrade mandatory or optional?
- If it is optional, do you want to leave the old version of the app in place and available to users, or not?
- How and when do you want to notify users of the upgrade?

These subjects are covered in the following topics.

### **Deploying a new app version and leaving the old version working**

The most common upgrade path, used when you introduce new features or modify native code, is to release a new version of your app. Consider following these steps:

1. Increment the app version number.
2. Build and test your project and generate new .wlapp, .apk, and .ipa files for it.
3. Deploy the new .wlapp files to MobileFirst Server.
4. Submit the new .apk or .ipa files to their respective app stores.
5. Wait for review and approval, and for the apps to become available.
6. Optional - send notification message to users of the old version, announcing the new version. See “Displaying a notification message on application startup” on page 11-5 and “Defining administrator messages from MobileFirst Operations Console in multiple languages” on page 11-5.

### **Deploying a new app version and blocking the old version**

This upgrade path is used when you want to force users to upgrade to the new version, and block their access to the old version. Consider following these steps:

1. Optional - send notification message to users of the old version, announcing a mandatory update in a few days. See “Displaying a notification message on application startup” on page 11-5 and “Defining administrator messages from MobileFirst Operations Console in multiple languages” on page 11-5.
2. Increment the app version number.
3. Build and test your project and generate new .wlapp, .apk, and .ipa files for it.
4. Deploy the new .wlapp files to MobileFirst Server.

5. Submit the new .apk or .ipa files to their respective app stores.
6. Wait for review and approval, and for the apps to become available.
7. Copy links to the new app version.
8. Block the old version of the app in MobileFirst Operations Console, supplying a message and link to the new version. See “Locking an application” on page 11-3 and “Remotely disabling application connectivity” on page 11-3.

**Note:** If you disable the old app, it is no longer able to communicate with MobileFirst Server. Users can still start the app and work with it offline unless you force a server connection on app startup.

## **Application authenticity**

This feature will not work properly for clients that were built with an older version of IBM MobileFirst Platform Foundation for iOS when the application deployed is of a new product version but has the same application version. Those client requests to access the authenticity-protected resources will be denied.

To keep support of old applications using app authenticity, or block them, follow these steps:

1. Upgrade the project using the newer version of IBM MobileFirst Platform Foundation for iOS, as described above.
2. Increment the versions of the upgraded applications.
3. Deploy the new WAR file that was built.
4. Deploy the new applications to the server alongside the applications that were built with the old IBM MobileFirst Platform Foundation for iOS.
5. Normally, both applications work as expected. If you want to use the new ones only, block the old ones and refer to the new ones for upgrade.

For more information about application authenticity, see “MobileFirst application authenticity overview” on page 8-247.





---

## Administering MobileFirst applications

Run and maintain MobileFirst applications in production.

IBM MobileFirst Platform Foundation for iOS provides several ways to administer MobileFirst applications in development or in production. MobileFirst Operations Console is the main tool with which you can monitor all deployed MobileFirst applications from a centralized web-based console.

The main operations that you can perform through MobileFirst Operations Console are:

- Deploy mobile applications and adapters to MobileFirst Server.
- Manage application versions to deploy new versions or remotely disable old versions.
- Manage mobile devices and users to manage access to a specific device or access for a specific user to an application.
- Display notification messages on application startup.
- Monitor push notification services.
- Collect client-side logs for specific applications installed on a specific device.

Not every kind of administration user can perform every administration operation. MobileFirst Operations Console, and all administration tools, have four different roles defined for administration of MobileFirst applications. The following MobileFirst administration roles are defined:

### **Monitor**

In this role, a user can monitor deployed MobileFirst projects and deployed artifacts. This role is read-only.

### **Operator**

An Operator can perform all mobile application management operations, but cannot add or remove application versions or adapters.

### **Deployer**

In this role, a user can perform the same operations as the Operator, but can also deploy applications and adapters.

### **Administrator**

In this role, a user can perform all application administration operations.

**Note:** In IBM MobileFirst Platform Foundation for iOS V7.0.0, the predefined MobileFirst Operations Console that is deployed to the embedded Liberty server has the following authentication configuration:

- Role "worklightadmin", user "admin", password "admin"
- Role "worklightdeployer", user "deployer", password: "demo"
- Role "worklightmonitor", user "monitor", password: "demo"
- Role "worklightoperator", user "operator", password: "demo"

You must map the different administrators to these roles when you configure MobileFirst Server during installation of MobileFirst Operations Console. See "Installing the MobileFirst Server administration" on page 6-43.

MobileFirst Operations Console can be used to administer several runtime environments, which are issued from several independent MobileFirst projects and are deployed to the same application server or cluster. For more information about deploying a MobileFirst project, see “Deploying an application from development to a test or production environment” on page 10-1.

MobileFirst Operations Console is not the only way to administer MobileFirst applications. IBM MobileFirst Platform Foundation for iOS also provides other tools to incorporate administration operations into your build and deployment process.

A set of REST services is available to perform administration operations. For API reference documentation of these services, see “REST Services API” on page 9-4.

With this set of REST services, you can perform the same operations that you can do in MobileFirst Operations Console. You can manage applications, adapters, and, for example, upload a new version of an application or disable an old version.

MobileFirst applications can also be administered by using Ant tasks or with the `wladmin` command line tool. See “Administering MobileFirst applications through Ant” on page 11-11 or “Administering MobileFirst applications through the command line” on page 11-36.

Similar to the web-based console, the REST services, Ant tasks, and command line tools are secured and require you to provide your administrator credentials, which enable you to perform operations within your specified role.

---

## Administering MobileFirst applications with MobileFirst Operations Console

You can administer MobileFirst applications through the MobileFirst Operations Console by deploying new versions of mobile and desktop apps, by locking apps or denying access, or by displaying notification messages.

In V6.1.0 and earlier versions of the product, MobileFirst Operations Console was deployed in the project WAR file. If two project WAR files were deployed, each one had its own administration console. Starting with V6.2.0, MobileFirst Operations Console is deployed separately and can administer all runtime environments in the same server.

You can start the console by entering one of the following URLs:

- Secure mode for production or test: `https://hostname:secure_port/worklightconsole`
- Development: `http://server_name:port/worklightconsole`

In either case, the list of all runtime environments is displayed. Select the runtime environment that you want to administer to access the functions of the MobileFirst Operations Console.

You can return to the list of runtime environments by clicking the **Home** link at the top of the page in MobileFirst Operations Console.

Use the MobileFirst Operations Console to manage your applications.

- To see all the applications that are installed and all the device platforms that are supported.

- To disable specific application versions on specific platforms and force users to upgrade before they continue to use the application. When you implement direct updates to mobile devices and desktop apps, software updates are pushed directly to application web resources or users' desktops
- To send out notifications to application users and to manage push notifications from defined event sources to applications.
- To install and manage adapters that are used by applications, and to inspect aggregated usage statistics from MobileFirst Server.
- To lock apps to prevent them from being mistakenly updated and to prevent the redeployment of web resources for a particular application.
- To display a notification message on app start to inform users without causing the application to exit.

For an easy way to upgrade an application, see “Upgrading a mobile application in MobileFirst Server and the Application Center” on page 11-86.

## Locking an application

You can prevent developers or administrators from mistakenly updating an application, by locking it in MobileFirst Operations Console.

### Procedure

To lock an application version for a specific environment, select **Lock this version** for the application version in the relevant environment.

## Remotely disabling application connectivity

You can use the Remote Disable procedure to deny a user's access to a certain application version due to phase-out policy or due to security issues encountered in the application.

### Before you begin

If you need to use the Remote Disable feature with servers and clusters that experience heavy loads, consider enabling the Remote Disable cache. Enabling the cache can improve performance by reducing how frequently the database is checked to see if an app has been remotely disabled. By default, the cache is disabled. To enable and configure the cache, add the following lines to the MobileFirst project `worklight.properties` file:

- `wl.remoteDisable.cache.enabled=true`
- `wl.remoteDisable.cache.refreshIntervalInSeconds=1`

The refresh interval determines how long (measured in seconds) values are kept in the cache before they are refreshed from the database. If you increase the interval, performance is improved as a result of fewer connections being made to the database, but you increase the duration before the remote disable state comes into effect. For example, if your infrastructure contains a cluster of four MobileFirst Server and you set `wl.remoteDisable.cache.refreshIntervalInSeconds=1`, the database is accessed 4 times per second to check the remote disable state.

**Note:** If code that uses the Remote Disable feature accesses a resource that is protected by OAuth authentication, and the client has a valid token, the MobileFirst Server is not called. As a result, the server does not check whether a specific application is disabled. The MobileFirst Server is called when the token expires or when the Remote Disable realm inside the token expires. When the

realm expires, the Remote Disable authenticator is invoked and the server checks whether the specific application version is disabled.

## About this task

Using the MobileFirst Operations Console, you can disable access to a specific version of a specific application on a specific mobile operating system and provide a custom message to the user.

## Procedure

1. To use this Remote Disable feature, change the status of the application version that must be disabled from **Active** to **Access Disabled**.
2. Add a custom message as shown in the following text:

This version is no longer supported. Please upgrade to the next version.

You can also specify a URL for the new version of the application (usually in the appropriate public or private app store). For some environments, the Application Center provides a URL to access the Details view of an application version directly. See “Application properties” on page 11-83.

When users run an application that is Remotely Disabled, they receive a text message about the access denial. They can either close the dialog and continue working offline (that is, without access to the MobileFirst Server), or they can upgrade to the latest version of the application. Closing the dialog keeps the application running, but any application interaction that requires server connectivity causes the dialog to be displayed again.

### Modifying the behavior of the Remote Disable operation

As noted above, the *default* dialog that is displayed to a user when an application is remotely disabled contains two buttons, **Get new version**, and **Close**. Clicking **Close** closes the dialog, but allows the user to continue working offline, with no connection to the MobileFirst Server.

**Note:** The actual text on the two buttons is customizable, and can be overridden in the `message.properties` file.

In older versions of IBM MobileFirst Platform Foundation for iOS, when you disabled an application using the MobileFirst Operations Console, the default behavior was to completely disable or end it, such that the application would not function, even in offline mode.

There is a way to modify the default behavior of the Remote Disable feature to completely disable an application if there is a need to do so (such as a severe security flaw).

- Add a new Boolean attribute to your `initOptions.js` file, named **showCloseOnRemoteDisableDenial**.
- If this attribute is missing or is set to **true**, the Remote Disable notification displays the default behavior described earlier.
- If this attribute is set to **false** (that is, "Do not show the **Close** button on the dialog"), the behavior is as follows:
  - If you disable the application on the MobileFirst Operations Console and specify a link to the new version, the dialog displays only a single button, the **Get new version** button. The **Close** button is not shown. The user has no choice but to update the application, and this preserves the older behavior of forcing the user to exit the application.
  - If you disable the application and do not specify a link to the new version, the dialog again displays only a single button, but in this case the **Close** button.

**Related tasks:**

“Defining administrator messages from MobileFirst Operations Console in multiple languages”

You can set the deny and notification messages from IBM MobileFirst Platform Operations Console in multiple languages.

## Displaying a notification message on application startup

You can set a notification message that is displayed for the user when the application starts, but does not cause the application to exit.

**About this task**

You can use this type of message to notify application users of temporary situations, such as planned service downtime.

**Procedure**

1. For the relevant application, change the status of the application version from **Active** to **Active, Notifying**.
2. Add a custom message, such as the following text:  
Server downtime is planned for Saturday 4am to 6am.

**Results**

The message is displayed the next time that the app is started or resumed. The message is displayed only once.

**Related tasks:**

“Defining administrator messages from MobileFirst Operations Console in multiple languages”

You can set the deny and notification messages from IBM MobileFirst Platform Operations Console in multiple languages.

## Defining administrator messages from MobileFirst Operations Console in multiple languages

You can set the deny and notification messages from IBM MobileFirst Platform Operations Console in multiple languages.

**About this task**

The messages are sent based on the locale of the device, and must comply with the ISO 639-1 and ISO 3166-2 standards.

**Procedure**

To add the deny and notification messages for multiple languages, follow these steps.

1. In MobileFirst Operations Console, select the status **Active, Notifying**, or **Access Disabled** in the list of application rules.
2. Click **SUPPORTED LOCALES**. The name “SUPPORTED LOCALES” is followed by the number of available locales; for example, **SUPPORTED LOCALES (7)** indicates that seven locales are available for the messages that you want to add.

In the Messages for multiple languages window, you can upload a CSV file.

Such a CSV file must define a series of lines. Each line contains a locale code, such as “fr-FR” for French (France) or “en” for English, a comma, and the corresponding message text. The specified locale codes must comply with the ISO 639-1 and ISO 3166-2 standards. The first line with an empty locale defines the default message. If you did not define an alternative, or if the locale from the client matches none of the uploaded locales, this default message is displayed.

**Note:** To create a CSV file, you must use an editor that supports UTF-8 encoding, such as Notepad.

The following figure shows an example of a CSV file:

```
,your application is disabled (default)
en,Your application is disabled
en-US,Your application in disabled in US
en-GB,Your application is disabled in GB
ru,аппликация была выключена
fr,votre application est désactivée
he,האפליקציה חסומה
ja,あなたのアプリケーションが無効になっていた
```

Figure 11-1. Sample CSV file

3. Click **UPLOAD CSV** to browse and select the CSV file that you want to upload. In “List of supported locales”, you can see the locales and translated messages that you uploaded.

## Notification text

### Default notification message

your app is disabled (default)

### List of supported locales

Locale	Message
en	Your app is disabled
en-US	Your app is disabled in US
en-GB	Your app is disabled in GB
fr	Appli desactivée
he	האפליקציה חסומה
ja	あなたのアプリケーションが無効になっていた

CLEAR

Upload a CSV file containing comma separated locale code and message on each line. Use empty locale code for a default message. Language codes must conform to ISO 639-1.

UPLOAD CSV

OK

CANCEL

Figure 11-2. Uploading a CSV file

4. Process the uploaded messages:
  - To clear “List of supported locales”, click **CLEAR**. This action does not clear the default message.
  - To validate the messages that you uploaded, click **OK**.
  - To discard the changes and return to the console, click **CANCEL**.

**Note:** If you modified the default message, then the new default message shows.

5. Click **SAVE** to save the default message and the multilingual messages. The following figure displays the mobile device of the user, which shows the localized message. The title and the button caption are in English. If the locale does not supply any messages, the default message is returned.

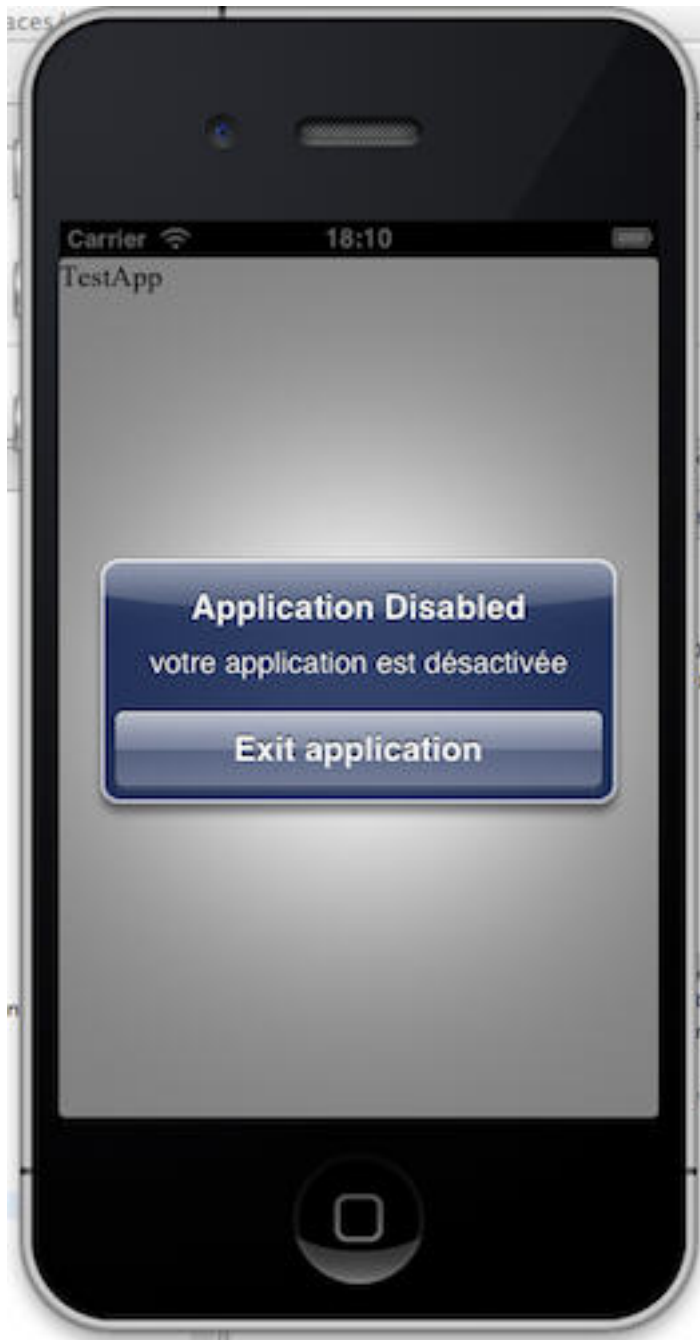

Figure 11-3. Application Disabled message

## Error log of operations on runtime environments

Use the error log to access failed management operations initiated from MobileFirst Operations Console or the command line on the selected runtime environment, and to see the effect of the failure on the servers.

The error log shows the most recent operation first.

You access the error log by clicking **Error log** of a runtime environment in MobileFirst Operations Console.



Expand the row that refers to the failed operation to access more information about the current state of each server. To access the complete log, download the log by clicking **Download log**.

**Error log**  
List of management operations that have failed in this environment runtime. For more details on errors, download the complete log. **DOWNLOAD LOG**

DATE	TYPE	NAME	DETAILS	VALUE									
Jan 27, 2015, 3:53 PM	Upload Adapter	myadapter	<p><b>ERROR DETAILS</b></p> <table border="1"> <thead> <tr> <th>Node</th> <th>Type</th> <th>Description</th> </tr> </thead> <tbody> <tr> <td>server:///9.128.97.30</td> <td>FAILURE</td> <td>Procedure 'getStories' in adapter 'myadapter' requires security test 'nonExsistence1' which is not defined in authenticationConfig.xml.</td> </tr> <tr> <td></td> <td>WARNING</td> <td>Adapter's connectivity configuration and behavior was changed in MobileFirst Platform 6.3. For more information, see the "Adapter timeout and concurrency" topic in the product Knowledge Center.</td> </tr> </tbody> </table>		Node	Type	Description	server:///9.128.97.30	FAILURE	Procedure 'getStories' in adapter 'myadapter' requires security test 'nonExsistence1' which is not defined in authenticationConfig.xml.		WARNING	Adapter's connectivity configuration and behavior was changed in MobileFirst Platform 6.3. For more information, see the "Adapter timeout and concurrency" topic in the product Knowledge Center.
Node	Type	Description											
server:///9.128.97.30	FAILURE	Procedure 'getStories' in adapter 'myadapter' requires security test 'nonExsistence1' which is not defined in authenticationConfig.xml.											
	WARNING	Adapter's connectivity configuration and behavior was changed in MobileFirst Platform 6.3. For more information, see the "Adapter timeout and concurrency" topic in the product Knowledge Center.											

Figure 11-4. Sample error log

## Audit log of administration operations

In the MobileFirst Operations Console, you can refer to an audit log of administration operations.

MobileFirst Operations Console provides access to an audit log for login, logout, and all administration operations, such as deploying apps or adapters or locking apps. The audit log can be disabled by setting the `ibm.worklight.admin.audit` Java Naming and Directory Interface (JNDI) property on the web application of the MobileFirst Administration service (`worklightadmin.war`) to false.

Each record in the audit log has the following fields, separated by a vertical bar (|); see Figure 11-5 on page 11-11.

Table 11-1. Fields in audit log records

Field name	Description
Timestamp	Date and time when the record was created.
Type	The type of operation. See list of operation types for the possible values.
User	The username of the user who is signed in.
Outcome	The outcome of the operation; possible values are SUCCESS, ERROR, PENDING.

Table 11-1. Fields in audit log records (continued)

Field name	Description
<b>ErrorCode</b>	If the outcome is ERROR, <b>ErrorCode</b> indicates what the error is.
<b>Runtime</b>	Name of the MobileFirst project associated with the operation.

The following list shows the possible values of **Type** of operation.

- Login
- Logout
- AdapterDeployment
- AdapterDeletion
- ApplicationDeployment
- ApplicationDeletion
- ApplicationLockChange
- ApplicationAuthenticityCheckRuleChange
- ApplicationAccessRuleChange
- ApplicationVersionDeletion
- add config profile
- DeviceStatusChange
- DeviceApplicationStatusChange
- DeviceDeletion
- unsubscribeSMS
- DeleteDevice
- DeleteSubscriptions
- SetPushEnabled
- SetGCMCredentials
- DeleteGCMCredentials
- sendMessage
- sendMessages
- setAPNSCredentials
- DeleteAPNSCredentials
- setMPNSCredentials
- deleteMPNSCredentials
- createTag
- updateTag
- deleteTag
- add runtime
- delete runtime

```

TimeStamp=Friday, August 29, 2014 2:52:13 PM CEST | Type=LogIn | User=demo | Outcome=SUCCESS
TimeStamp=Friday, August 29, 2014 7:10:54 PM CEST | Type=LogIn | User=demo | Outcome=SUCCESS
TimeStamp=Friday, August 29, 2014 7:14:47 PM CEST | Type=LogOut | User=demo | Outcome=SUCCESS
TimeStamp=Friday, August 29, 2014 7:14:50 PM CEST | Type=LogIn | User=demo | Outcome=SUCCESS
TimeStamp=Monday, September 1, 2014 9:17:42 AM CEST | Type=LogIn | User=demo | Outcome=SUCCESS
TimeStamp=Monday, September 1, 2014 11:18:34 AM CEST | Type=LogIn | User=demo | Outcome=SUCCESS
TimeStamp=Monday, September 1, 2014 11:19:39 AM CEST | Type=LogOut | User=demo | Outcome=SUCCESS
TimeStamp=Monday, September 1, 2014 11:25:52 AM CEST | Type=LogIn | User=demo | Outcome=SUCCESS
TimeStamp=Monday, September 1, 2014 11:32:17 AM CEST | Type=LogOut | User=demo | Outcome=SUCCESS
TimeStamp=Monday, September 1, 2014 11:32:21 AM CEST | Type=LogIn | User=demo | Outcome=SUCCESS
TimeStamp=Monday, September 1, 2014 11:52:14 AM CEST | Type=LogOut | User=demo | Outcome=SUCCESS
TimeStamp=Monday, September 1, 2014 11:52:16 AM CEST | Type=LogIn | User=demo | Outcome=SUCCESS
TimeStamp=Monday, September 1, 2014 4:08:23 PM CEST | Type=LogIn | User=demo | Outcome=SUCCESS
TimeStamp=Monday, September 1, 2014 4:10:01 PM CEST | Type=ApplicationDeployment | User=demo | Outcome=SUCCESS | Runtime=test | Appli
TimeStamp=Monday, September 1, 2014 4:10:34 PM CEST | Type=LogIn | User=demo | Outcome=SUCCESS
TimeStamp=Monday, September 1, 2014 4:44:57 PM CEST | Type=LogIn | User=demo | Outcome=SUCCESS
TimeStamp=Monday, September 1, 2014 5:06:59 PM CEST | Type=LogIn | User=demo | Outcome=SUCCESS
TimeStamp=Friday, September 5, 2014 1:02:48 PM CEST | Type=LogIn | User=demo | Outcome=SUCCESS
TimeStamp=Friday, September 5, 2014 1:09:26 PM CEST | Type=LogIn | User=demo | Outcome=SUCCESS
TimeStamp=Friday, September 5, 2014 1:18:05 PM CEST | Type=LogIn | User=demo | Outcome=SUCCESS
TimeStamp=Friday, September 5, 2014 1:46:35 PM CEST | Type=LogIn | User=demo | Outcome=SUCCESS
TimeStamp=Friday, September 5, 2014 1:47:07 PM CEST | Type=ApplicationDeployment | User=demo | Outcome=ERROR | ErrorCode=transaction
TimeStamp=Friday, September 5, 2014 1:47:46 PM CEST | Type=ApplicationDeployment | User=demo | Outcome=ERROR | ErrorCode=transaction
TimeStamp=Friday, September 5, 2014 1:49:25 PM CEST | Type=ApplicationDeployment | User=demo | Outcome=SUCCESS | Runtime=test | Appli
TimeStamp=Friday, September 5, 2014 2:00:01 PM CEST | Type=ApplicationDeployment | User=demo | Outcome=SUCCESS | Runtime=test | Appli
TimeStamp=Friday, September 5, 2014 2:16:11 PM CEST | Type=ApplicationDeployment | User=demo | Outcome=SUCCESS | Runtime=test | Appli
TimeStamp=Friday, September 5, 2014 2:17:32 PM CEST | Type=ApplicationDeployment | User=demo | Outcome=SUCCESS | Runtime=test | Appli
TimeStamp=Tuesday, September 9, 2014 3:35:23 PM CEST | Type=LogIn | User=demo | Outcome=SUCCESS
TimeStamp=Tuesday, September 9, 2014 3:39:52 PM CEST | Type=LogIn | User=demo | Outcome=SUCCESS
TimeStamp=Tuesday, September 9, 2014 3:39:52 PM CEST | Type=LogOut | User=demo | Outcome=SUCCESS
TimeStamp=Tuesday, September 9, 2014 3:45:38 PM CEST | Type=LogIn | User=demo | Outcome=SUCCESS
TimeStamp=Tuesday, September 9, 2014 3:46:01 PM CEST | Type=ApplicationDeployment | User=demo | Outcome=SUCCESS | Runtime=worklight_1
TimeStamp=Tuesday, September 9, 2014 3:46:20 PM CEST | Type=ApplicationDeployment | User=demo | Outcome=SUCCESS | Runtime=worklight_1
TimeStamp=Tuesday, September 9, 2014 3:51:08 PM CEST | Type=AdapterDeployment | User=demo | Outcome=SUCCESS | Runtime=worklight_1 | A
TimeStamp=Wednesday, September 10, 2014 2:08:26 PM CEST | Type=LogIn | User=demo | Outcome=SUCCESS
TimeStamp=Wednesday, September 10, 2014 2:12:26 PM CEST | Type=ApplicationDeployment | User=demo | Outcome=SUCCESS | Runtime=workligh
TimeStamp=Wednesday, September 10, 2014 2:12:34 PM CEST | Type=ApplicationDeployment | User=demo | Outcome=SUCCESS | Runtime=workligh
TimeStamp=Wednesday, September 10, 2014 2:24:21 PM CEST | Type=LogOut | User=demo | Outcome=SUCCESS

```

Figure 11-5. Sample audit log of MobileFirst administration operations

## Administering MobileFirst applications through Ant

You can administer MobileFirst applications through the **wladm** Ant task.

### Comparison with other facilities

You can execute administration operations with IBM MobileFirst Platform Foundation for iOS in the following ways:

- The MobileFirst Operations Console, which is interactive.
- The **wladm** Ant task.
- The **wladm** program.
- The MobileFirst administration REST services.

The **wladm** Ant task, **wladm** program, and REST services are useful for automated or unattended execution of operations, such as eliminating operator errors in repetitive operations or operating outside the operator's normal working hours.

The **wladm** Ant task and the **wladm** program are simpler to use and have better error reporting than the REST services. The advantage of the **wladm** Ant task over the **wladm** program is that it is platform independent and easier to integrate when integration with Ant is already available.

## Prerequisites

Apache Ant is required to run the **wladm** task. For information about the minimum supported version of Ant, see “System requirements” on page 2-7.

For convenience, Apache Ant 1.8.4 is included in MobileFirst Server. In the *product\_install\_dir/shortcuts/* directory, the following scripts are provided.

- ant for UNIX / Linux
- ant.bat for Windows

These scripts are ready to run, which means that they do not require specific environment variables. If the environment variable `JAVA_HOME` is set, the scripts accept it.

You can use the **wladm** Ant task on a different computer than the one on which you installed MobileFirst Server.

- Copy the file *product\_install\_dir/WorklightServer/worklight-ant-deployer.jar* to the computer.
- Make sure that a supported version of Apache Ant and a Java runtime environment are installed on the computer.

To use the **wladm** Ant task, add this initialization command to the Ant script:

```
<taskdef resource="com/worklight/ant/deployers/antlib.xml">
  <classpath>
    <pathelement location="product_install_dir/WorklightServer/worklight-ant-deployer.jar"/>
  </classpath>
</taskdef>
```

Other initialization commands that refer to the same *worklight-ant-deployer.jar* file are redundant because the initialization by *defaults.properties* is also implicitly done by *antlib.xml*. Here is one example of a redundant initialization command:

```
<taskdef resource="com/worklight/ant/defaults.properties">
  <classpath>
    <pathelement location="product_install_dir/WorklightServer/worklight-ant-deployer.jar"/>
  </classpath>
</taskdef>
```

## Calling the wladm Ant task

You can use the **wladm** Ant task and its associated commands to administer MobileFirst applications.

### Syntax

Call the **wladm** Ant task as follows:

```
<wladm url=... user=... password=...|passwordfile=... [secure=...]>
  some commands
</wladm>
```

## Attributes

The **wladm** Ant task has the following attributes:

Table 11-2. List of `<wladm>` attributes

Attribute	Description	Required	Default
<b>url</b>	The base URL of the MobileFirst web application for administration services	Yes	
<b>secure</b>	Whether to avoid operations with security risks	No	true
<b>user</b>	The user name for accessing the MobileFirst administration services	Yes	
<b>password</b>	The password for the user	Either one is required	
<b>passwordfile</b>	The file that contains the password for the user		
<b>timeout</b>	Timeout for the entire REST service access, in seconds	No	
<b>connectTimeout</b>	Timeout for establishing a network connection, in seconds	No	
<b>socketTimeout</b>	Timeout for detecting the loss of a network connection, in seconds	No	
<b>connectionRequestTimeout</b>	Timeout for obtaining an entry from a connection request pool, in seconds	No	

### **url**

The base URL preferably uses the HTTPS protocol. For example, if you use default ports and context roots, use the following URL.

- For WebSphere Application Server: `https://server:9443/worklightadmin`
- For Tomcat: `https://server:8443/worklightadmin`

**secure** The default value is true. Setting `secure="false"` might have the following effects:

- The user and password might be transmitted in an unsecured way, possibly even through unencrypted HTTP.
- The server's SSL certificates are accepted even if self-signed or if they were created for a different host name than the specified server's host name.

### **password**

Specify the password either in the Ant script, through the **password** attribute, or in a separate file that you pass through the **passwordfile** attribute. The password is sensitive information and therefore needs to be protected. You must prevent other users on the same computer from knowing this password. To secure the password, before you enter the password into a file, remove the read permissions of the file for users other than yourself. For example, you can use one of the following commands:

- On UNIX: `chmod 600 adminpassword.txt`
- On Windows: `cacls adminpassword.txt /P Administrators:F %USERDOMAIN%\%USERNAME%:F`

Additionally, you might want to obfuscate the password to hide it from an occasional glimpse. To do so, use the **wladm config password** command to

store the obfuscated password in a configuration file. Then, you can copy and paste the obfuscated password to the Ant script or to the password file.

The **wladm** call contains commands that are encoded in inner elements. These commands are executed in the order in which they are listed. If one of the commands fails, the remaining commands are not executed, and the **wladm** call fails.

## Elements

You can use the following elements in **wladm** calls:

*Table 11-3. Elements that can be used in <wladm>*

Element	Description	Count
show-info	Shows user and configuration information	0..∞
show-versions	Shows versions information	0..∞
list-runtimes	Lists the runtimes	0..∞
show-runtime	Shows information about a runtime	0..∞
delete-runtime	Deletes a runtime	0..∞
list-adapters	Lists the adapters	0..∞
deploy-adapter	Deploys an adapter	0..∞
show-adapter	Shows information about an adapter	0..∞
delete-adapter	Deletes an adapter	0..∞
adapter	Other operations on an adapter	0..∞
list-apps	Lists the apps	0..∞
deploy-app	Deploys an app	0..∞
show-app	Shows information about an app	0..∞
delete-app	Deletes an app	0..∞
delete-app-version	Delete a version of an app	0..∞
app-version	Other operations on an app	0..∞
list-beacons	Lists the beacons	0..∞
set-beacon	Specifies information about a beacon	0..∞
show-beacon	Shows information about a beacon	0..∞
remove-beacon	Removes information about a beacon	0..∞
list-beacon-triggers	Lists the beacon triggers	0..∞
set-beacon-trigger	Specifies a beacon trigger	0..∞
show-beacon-trigger	Shows a beacon trigger	0..∞
delete-beacon-trigger	Deletes a beacon trigger	0..∞
list-beacon-trigger-associations	Lists the associations between beacons and beacon triggers	0..∞
set-beacon-trigger-association	Specifies an association between a beacon and a beacon trigger	0..∞
show-beacon-trigger-association	Shows the association between a beacon and a beacon trigger	0..∞

Table 11-3. Elements that can be used in <wladm> (continued)

Element	Description	Count
delete-beacon-trigger-association	Deletes the association between a beacon and a beacon trigger	0..∞
list-devices	Lists the devices	0..∞
remove-device	Removes a device	0..∞
device	Other operations for a device	0..∞

## XML Format

The output of most commands is in XML, and the input to specific commands, such as <set-accessrule>, is in XML too. You can find the XML schemas of these XML formats in the *product\_install\_dir/WorklightServer/wladm-schemas/* directory. The commands that receive an XML response from the server verify that this response conforms to the specific schema. You can disable this check by specifying the attribute `xmlvalidation="none"`.

## Output character set

Normal output from the **wladm** Ant task is encoded in the encoding format of the current locale. On Windows, this encoding format is the so-called "ANSI code page". The effects are as follows:

- Characters outside of this character set are converted to question marks when they are output.
- When the output goes to a Windows command prompt window (`cmd.exe`), non-ASCII characters are incorrectly displayed because such windows assume characters to be encoded in the so-called "OEM code page".

To work around this limitation:

- On operating systems other than Windows, use a locale whose encoding is UTF-8. This locale is the default locale on Red Hat Linux and OS X. Many other operating systems have the `en_US.UTF-8` locale.
- Or use the attribute `output="some file name"` to redirect the output of a **wladm** command to a file.

## Commands for adapters

When you call the **wladm** Ant task, you can include various commands for adapters.

### The list-adapters command

The **list-adapters** command returns a list of the adapters deployed for a given runtime. It has the following attributes:

Table 11-4. list-adapters command attributes

Attribute	Description	Required	Default
<b>runtime</b>	Name of the runtime web application / MobileFirst project.	Yes	Not available
<b>output</b>	Name of output file.	No	

Table 11-4. `list-adapters` command attributes (continued)

Attribute	Description	Required	Default
<b>outputproperty</b>	Name of Ant property for the output.	No	

Example:

```
<list-adapters runtime="worklight"/>
```

This command is based on the “Adapters (GET)” on page 9-15 REST service.

## The `deploy-adapter` command

The **deploy-adapter** command deploys an adapter in a runtime. It has the following attributes:

Table 11-5. `deploy-adapter` command attributes

Attribute	Description	Required	Default
<b>runtime</b>	Name of the runtime web application / MobileFirst project.	Yes	Not available
<b>file</b>	Binary adapter file (.adapter).	Yes	Not available

Example:

```
<deploy-adapter runtime="worklight" file="MyAdapter.adapter"/>
```

This command is based on the “Adapter (POST)” on page 9-12 REST service.

## The `show-adapter` command

The **show-adapter** command shows details about an adapter. It has the following attributes:

Table 11-6. `show-adapter` command attributes

Attribute	Description	Required	Default
<b>runtime</b>	Name of the runtime web application / MobileFirst project.	Yes	Not available
<b>name</b>	Name of an adapter.	Yes	Not available
<b>output</b>	Name of output file.	No	
<b>outputproperty</b>	Name of Ant property for the output.	No	

Example:

```
<show-adapter runtime="worklight" name="MyAdapter"/>
```

This command is based on the “Adapter (GET)” on page 9-8 REST service.



## The delete-adapter command

The **delete-adapter** command removes (undeploys) an adapter from a runtime. It has the following attributes:

Table 11-7. **delete-adapter** command attributes

Attribute	Description	Required	Default
<b>runtime</b>	Name of the runtime web application / MobileFirst project.	Yes	Not available
<b>name</b>	Name of an adapter.	Yes	Not available

Example:

```
<delete-adapter runtime="worklight" name="MyAdapter"/>
```

This command is based on the “Adapter (DELETE)” on page 9-5 REST service.

## The adapter command group

The **adapter** command group has the following attributes:

Table 11-8. **adapter** command group attributes

Attribute	Description	Required	Default
<b>runtime</b>	Name of the runtime web application / MobileFirst project.	Yes	Not available
<b>name</b>	Name of an adapter.	Yes	Not available

It supports the following elements:

Table 11-9. **adapter** command group elements

Element	Description	Count
get-binary	Gets the binary data.	0..∞

## The get-binary command

The **get-binary** command inside an <adapter> element returns the binary adapter file. It has the following attributes:

Table 11-10. **get-binary** command attributes

Attribute	Description	Required	Default
<b>tofile</b>	Name of the output file.	Yes	Not available

Example:

```
<adapter runtime="worklight" name="MyAdapter">  
  <get-binary tofile="/tmp/MyAdapter.adapter"/>  
</adapter>
```

This command is based on the “Adapter Binary (GET, HEAD)” on page 9-4 REST service.

## Commands for apps

When you call the `wladm` Ant task, you can include various commands for apps.

### The `enable-extended-authenticity` command

The `enable-extended-authenticity` command creates a `.wlapp` file that is based on an original `.wlapp` file but has extended authenticity checking enabled. It has the following attributes:

Table 11-11. The `enable-extended-authenticity` command's attributes

Attribute	Description	Required	Default
<code>srcwlappfile</code>	Original binary app file (.wlapp, not .apk or .ipa)	Yes	Not available
<code>devicefile</code>	Binary mobile app file (.apk, .ipa, or .xap)	Yes	Not available
<code>destwlappfile</code>	Output binary app file (.wlapp, not .apk or .ipa)	Yes	Not available

### Example

```
<enable-extended-authenticity srcwlappfile="myapp-iphone-1.0.wlapp"  
  devicefile="MyApp.ipa"  
  destwlappfile="myapp-iphone-1.0.extauth.wlapp"/>
```

**Note:** This command operates locally, without connecting to the server.

For more information about enabling extended app authenticity checking, see “Configuring extended app authenticity checking” on page 10-51.

### The `list-apps` command

The `list-apps` command returns a list of the apps that are deployed in a runtime. It has the following attributes:

Table 11-12. The `list-apps` command's attributes

Attribute	Description	Required	Default
<code>runtime</code>	Name of the runtime web application / MobileFirst project.	Yes	Not available
<code>output</code>	Name of output file.	No	
<code>outputproperty</code>	Name of Ant property for the output.	No	

### Example

```
<list-apps runtime="worklight"/>
```

This command is based on the “Applications (GET)” on page 9-49 REST service.

### The `deploy-app` command

The `deploy-app` command deploys an app (possibly with multiple environments) in a run time. It has the following attributes:

Table 11-13. The `deploy-app` command's attributes

Attribute	Description	Required	Default
<b>runtime</b>	Name of the runtime web application / MobileFirst project.	Yes	Not available
<b>file</b>	Binary app file (.wlapp, not .apk, or .ipa).	Yes	Not available

## Example

```
<deploy-app runtime="worklight" file="MyApp-all.wlapp"/>
```

This command is based on the “Application (POST)” on page 9-45 REST service.

## The `show-app` command

The **show-app** command returns a list of the apps that are deployed in a runtime. It has the following attributes:

Table 11-14. The `show-app` command's attributes

Attribute	Description	Required	Default
<b>runtime</b>	Name of the run time web application / MobileFirst project.	Yes	Not available
<b>name</b>	Name of an app.	Yes	Not available
<b>output</b>	Name of output file.	No	
<b>outputproperty</b>	Name of Ant property for the output.	No	

## Example

```
<show-app runtime="worklight" name="MyApp"/>
```

This command is based on the “Application (GET)” on page 9-41 REST service.

## The `delete-app` command

The **delete-app** command removes (undeploys) an app, with all its app versions, for all environments for which it was deployed, from a runtime. It has the following attributes:

Table 11-15. The `delete-app` command's attributes

Attribute	Description	Required	Default
<b>runtime</b>	Name of the runtime web application / MobileFirst project.	Yes	Not available
<b>name</b>	Name of an app.	Yes	Not available

## Example

```
<delete-app runtime="worklight" name="MyApp"/>
```

This command is based on the “Application (DELETE)” on page 9-38 REST service.

## The delete-app-version command

The **delete-app-version** command removes (undeploys) an app version from a runtime. It has the following attributes:

Table 11-16. The delete-app-version command's attributes

Attribute	Description	Required	Default
<b>runtime</b>	Name of the runtime web application / MobileFirst project.	Yes	Not available
<b>name</b>	Name of an app.	Yes	Not available
<b>environment</b>	Mobile platform.	Yes	Not available
<b>version</b>	Version of the app.	Yes	Not available

## Example

```
<delete-app-version runtime="worklight" name="MyApp" environment="iphone" version="1.1"/>
```

This command is based on the “App Version (DELETE)” on page 9-31 REST service.

## The app-version command group

The **app-version** command group has the following attributes:

Table 11-17. The app-version command's group attributes

Attribute	Description	Required	Default
<b>runtime</b>	Name of the run time web application / MobileFirst project.	Yes	Not available
<b>name</b>	Name of an app.	Yes	Not available
<b>environment</b>	Mobile platform.	Yes	Not available
<b>version</b>	Version of the app.	Yes	Not available

It supports the following elements:

Table 11-18. The app-version command's group elements

Element	Description	Count
get-binary	Gets the binary data.	0..∞
get-accessrule	Gets the access rule.	0..∞
set-accessrule	Changes the access rule.	0..∞
get-authenticitycheckrule	Gets the authenticity check rule.	0..∞

Table 11-18. The `app-version` command's group elements (continued)

Element	Description	Count
<code>set-authenticitycheckrule</code>	Changes the authenticity check rule.	0..∞
<code>get-lock</code>	Gets the lock state.	0..∞
<code>set-lock</code>	Changes the lock state.	0..∞

## The `get-binary` command

The `get-binary` command, inside an `<app-version>` element, returns the binary file `wlapp` for a version of an app. It has the following attributes:

Table 11-19. The `get-binary` command's attributes

Attribute	Description	Required	Default
<code>tofile</code>	Name of the output file.	Yes	Not available

### Example

```
<app-version runtime="worklight" name="MyApp" environment="iphone" version="1.1">
  <get-binary tofile="/tmp/MyApp.wlapp"/>
</app-version>
```

This command is based on the “Application Binary (GET, HEAD)” on page 9-37 REST service.

## The `get-accessrule` command

The `get-accessrule` command returns the access rule for an app version. It has the following attributes:

Table 11-20. The `get-accessrule` command's attributes

Attribute	Description	Required	Default
<code>output</code>	Name of a file in which to store the output.	No	
<code>outputproperty</code>	Name of an Ant property in which to store the output.	No	

### Example

```
<app-version runtime="worklight" name="MyApp" environment="iphone" version="1.1">
  <get-accessrule output="/tmp/MyApp-accessrule.xml"/>
</app-version>
```

This command is based on the “Application (GET)” on page 9-41 REST service.

## The `set-accessrule` command

The `set-accessrule` command changes the access rule for an app version. It has the following attributes:

Table 11-21. The **set-accessrule** command's attributes

Attribute	Description	Required	Default
<b>file</b>	Name of the input file.	Yes	Not available

### Example

```
<app-version runtime="worklight" name="MyApp" environment="iphone" version="1.1">
  <set-accessrule file="/tmp/new-accessrule.xml"/>
</app-version>
```

This command is based on the “App Version Access Rule (PUT)” on page 9-27 REST service.

### The **get-authenticitycheckrule** command

The **get-authenticitycheckrule** command returns the authenticity check rule for an app version. This command is no longer supported with servers of IBM MobileFirst Platform Foundation for iOS V7.0.0 or later. This command is only available with V6.2.0 and V6.3.0. It has the following attributes:

Table 11-22. The **get-authenticitycheckrule** command's attributes

Attribute	Description	Required	Default
<b>output</b>	Name of a file in which to store the output.	No	
<b>outputproperty</b>	Name of an Ant property in which to store the output.	No	

### Example

```
<app-version runtime="worklight" name="MyApp" environment="iphone" version="1.1">
  <get-authenticitycheckrule output="/tmp/MyApp-authenticitycheckrule.txt"/>
</app-version>
```

This command is based on the “Application (GET)” on page 9-41 REST service.

### The **set-authenticitycheckrule** command

The **set-authenticitycheckrule** command changes the authenticity check rule for an app version. This command is no longer supported with servers of IBM MobileFirst Platform Foundation for iOS V7.0.0 or later. This command is only available with V6.2.0 and V6.3.0. It has the following attributes:

Table 11-23. The **set-authenticitycheckrule** command's attributes

Attribute	Description	Required	Default
<b>action</b>	Action to perform for authenticity checking.	Yes	Not available

The possible actions are:

- **DISABLED:** Authenticity is not checked.
- **IGNORED:** Authenticity is checked, but not enforced. If it fails, only a warning is given and the session is authorized.
- **ENABLED:** Authenticity is checked and enforced.

## Example

```
<app-version runtime="worklight" name="MyApp" environment="iphone" version="1.1">  
  <set-authenticitycheckrule action="enabled"/>  
</app-version>
```

## The get-lock command

The **get-lock** command returns information about whether an app version is locked or unlocked. It has the following attributes:

Table 11-24. The **get-lock** command's attributes

Attribute	Description	Required	Default
<b>output</b>	Name of a file in which to store the output.	No	
<b>outputproperty</b>	Name of an Ant property in which to store the output.	No	

## Example

```
<app-version runtime="worklight" name="MyApp" environment="iphone" version="1.1">  
  <get-lock output="/tmp/MyApp-lock.txt"/>  
</app-version>
```

This command is based on the “Application (GET)” on page 9-41 REST service.

## The set-lock command

The **set-lock** command sets an app version to locked or unlocked state. It has the following attributes:

Table 11-25. The **set-lock** command's attributes

Attribute	Description	Required	Default
<b>lock</b>	New lock state.	Yes	Not available

The possible lock values are true and false.

## Example

```
<app-version runtime="worklight" name="MyApp" environment="iphone" version="1.1">  
  <set-lock lock="true"/>  
</app-version>
```

This command is based on the “App Version Lock (PUT)” on page 9-35 REST service.

## Commands for beacons

When you call the **wladm** Ant task, you can include various commands for the beacons and beacon triggers. A beacon is a piece of information that is associated with an iBeacon. A beacon trigger is an action that a mobile device runs in relation to an iBeacon, when there is an association between the beacon and the beacon trigger.

## The list-beacons command

The **list-beacons** command returns a list of the beacons that match a given UUID and optionally, a given major and minor number. It has the following attributes.

Table 11-26. `list-beacons` command attributes

Attribute	Description	Required	Default
<b>uuid</b>	UUID (32 hex digits) of the beacons to search for.	Only if <b>major</b> or <b>minor</b> are specified	wild
<b>major</b>	Major number of the beacons to search for.	No	wild
<b>minor</b>	Minor number of the beacons to search for.	No	wild
<b>output</b>	Name of output file.	No	
<b>outputproperty</b>	Name of Ant property for the output.	No	

Example:

```
<list-beacons uuid="496E-974C-CEDE-8679-1CF9-A8EF-2E51-45B6"/>
```

This command is based on the “Beacons (GET)” on page 9-83 REST service.

## The `set-beacon` command

The `set-beacon` command specifies or updates information about a beacon. It has the following attributes:

Table 11-27. `set-beacon` command attributes

Attribute	Description	Required	Default
<b>file</b>	Name of the input file.	Yes	Not available

The input file can be in JSON or XML format. If it is in XML format, it must follow the schema that is given in the file `product_install_dir/WorklightServer/wladmin-schemas/input/beacon.xsd`.

Example:

```
<set-beacon file="entrance.xml"/>
```

This command is based on the “Beacons (PUT)” on page 9-86 REST service.

## The `show-beacon` command

The `show-beacon` command shows details about a beacon. It has the following attributes:

Table 11-28. `show-beacon` command attributes

Attribute	Description	Required	Default
<b>uuid</b>	UUID (32 hex digits) of the beacon.	Yes	Not available
<b>major</b>	Major number of the beacon.	Yes	Not available
<b>minor</b>	Minor number of the beacon.	Yes	Not available



Table 11-28. `show-beacon` command attributes (continued)

Attribute	Description	Required	Default
<b>output</b>	Name of output file.	No	
<b>outputproperty</b>	Name of Ant property for the output.	No	

Example:

```
<show-beacon uuid="496E-974C-CEDE-8679-1CF9-A8EF-2E51-45B6" major="1"
minor="23"/>
```

This command is based on the “Beacons (GET)” on page 9-83 REST service.

### The `remove-beacon` command

The `remove-beacon` command removes (clears) the information about a beacon. It has the following attributes:

Table 11-29. `remove-beacon` command attributes

Attribute	Description	Required	Default
<b>uuid</b>	UUID (32 hex digits) of the beacon.	Yes	Not available
<b>major</b>	Major number of the beacon.	Yes	Not available
<b>minor</b>	Minor number of the beacon.	Yes	Not available

Example:

```
<remove-beacon uuid="496E-974C-CEDE-8679-1CF9-A8EF-2E51-45B6" major="1"
minor="23"/>
```

This command is based on the “Beacons (DELETE)” on page 9-80 REST service.

### The `list-beacon-triggers` command

The `list-beacon-triggers` command returns the list of beacon triggers, belonging to a given runtime. It has the following attributes:

Table 11-30. `list-beacon-triggers` command attributes

Attribute	Description	Required	Default
<b>runtime</b>	Name of the runtime web application / MobileFirst project.	Yes	Not available
<b>output</b>	Name of output file.	No	
<b>outputproperty</b>	Name of Ant property for the output.	No	

Example:

```
<list-beacon-triggers runtime="worklight"/>
```

This command is based on the “Beacon Triggers (GET)” on page 9-69 REST service.

## The set-beacon-trigger command

The **set-beacon-trigger** command specifies or updates information about a beacon trigger, belonging to a given runtime. It has the following attributes:

Table 11-31. set-beacon-trigger command attributes

Attribute	Description	Required	Default
<b>runtime</b>	Name of the runtime web application / MobileFirst project.	Yes	Not available
<b>file</b>	Name of the input file.	Yes	Not available

The input file can be in JSON or XML format. If it is in XML format, it must follow the schema that is given in the file *product\_install\_dir/WorklightServer/wladmin-schemas/input/beacon-trigger.xsd*.

Example:

```
<set-beacon-trigger runtime="worklight" file="entrance-alert.xml"/>
```

This command is based on the “Beacon Triggers (PUT)” on page 9-76 REST service.

## The show-beacon-trigger command

The **show-beacon-trigger** command shows details about a beacon trigger, belonging to a given runtime. It has the following attributes:

Table 11-32. show-beacon-trigger command attributes

Attribute	Description	Required	Default
<b>runtime</b>	Name of the runtime web application / MobileFirst project.	Yes	Not available
<b>name</b>	Name of the beacon trigger.	Yes	Not available
<b>output</b>	Name of output file.	No	
<b>outputproperty</b>	Name of Ant property for the output.	No	

Example:

```
<show-beacon-trigger runtime="worklight" name="entrance-alert"/>
```

This command is based on the “Beacon Trigger (GET)” on page 9-67 REST service.

## The delete-beacon-trigger command

The **delete-beacon-trigger** command deletes a beacon trigger from a given runtime. It has the following attributes:

Table 11-33. delete-beacon-trigger command attributes

Attribute	Description	Required	Default
<b>runtime</b>	Name of the runtime web application / MobileFirst project.	Yes	Not available
<b>name</b>	Name of the beacon trigger.	Yes	Not available

Example:

```
<delete-beacon-trigger runtime="worklight" name="entrance-alert"/>
```

This command is based on the “Beacon Trigger (DELETE)” on page 9-64 REST service.

### The list-beacon-trigger-associations command

The **list-beacon-trigger-associations** command returns the list of associations between beacons and beacon triggers that match given criteria, belonging to an app in a given runtime. It has the following attributes:

Table 11-34. list-beacon-trigger-associations command attributes

Attribute	Description	Required	Default
<b>runtime</b>	Name of the runtime web application / MobileFirst project.	Yes	Not available
<b>app</b>	Name of an app.	Yes	Not available
<b>uuid</b>	UUID (32 hex digits) of the beacon.	Only if <b>major</b> or <b>minor</b> are specified	
<b>major</b>	Major number of the beacon.	No	
<b>minor</b>	Minor number of the beacon.	No	
<b>triggerName</b>	Name of the beacon trigger.	No	
<b>output</b>	Name of output file.	No	
<b>outputproperty</b>	Name of Ant property for the output.	No	

Examples:

```
<list-beacon-trigger-associations runtime="worklight" app="productguide"/>
```

```
<list-beacon-trigger-associations runtime="worklight" app="productguide"
uuid="496E-974C-CEDE-8679-1CF9-A8EF-2E51-45B6" major="1" minor="23"/>
```

```
<list-beacon-trigger-associations runtime="worklight" app="productguide"
triggerName="entrance-alert"/>
```

This command is based on the “Associate beacons and triggers (GET)” on page 9-57 REST service.

## The set-beacon-trigger-association command

The **set-beacon-trigger-association** command specifies an association between a beacon and a beacon trigger, belonging to an app in a given runtime. It has the following attributes:

Table 11-35. **set-beacon-trigger-association** command attributes

Attribute	Description	Required	Default
<b>runtime</b>	Name of the runtime web application / MobileFirst project.	Yes	Not available
<b>app</b>	Name of an app.	Yes	Not available
<b>uuid</b>	UUID (32 hex digits) of the beacon.	Yes	Not available
<b>major</b>	Major number of the beacon.	Yes	Not available
<b>minor</b>	Minor number of the beacon.	Yes	Not available
<b>triggerName</b>	Name of the beacon trigger.	Yes	Not available

Example:

```
<set-beacon-trigger-association runtime="worklight" app="productguide"
uuid="496E-974C-CEDE-8679-1CF9-A8EF-2E51-45B6" major="1" minor="23"
triggerName="entrance-alert"/>
```

This command is based on the “Associate beacons and triggers (PUT)” on page 9-59 REST service.

## The show-beacon-trigger-association command

The **show-beacon-trigger-association** command shows an association between a beacon and a beacon trigger, belonging to an app in a given runtime. It has the following attributes:

Table 11-36. **show-beacon-trigger-association** command attributes

Attribute	Description	Required	Default
<b>runtime</b>	Name of the runtime web application / MobileFirst project.	Yes	Not available
<b>app</b>	Name of an app.	Yes	Not available
<b>uuid</b>	UUID (32 hex digits) of the beacon.	Yes	Not available
<b>major</b>	Major number of the beacon.	Yes	Not available
<b>minor</b>	Minor number of the beacon.	Yes	Not available

Table 11-36. `show-beacon-trigger-association` command attributes (continued)

Attribute	Description	Required	Default
<b>triggerName</b>	Name of the beacon trigger.	Yes	Not available
<b>output</b>	Name of output file.	No	
<b>outputproperty</b>	Name of Ant property for the output.	No	

Example:

```
<show-beacon-trigger-association runtime="worklight" app="productguide"
uuid="496E-974C-CEDE-8679-1CF9-A8EF-2E51-45B6" major="1" minor="23"
triggerName="entrance-alert"/>
```

This command is based on the “Associate beacons and triggers (GET)” on page 9-57 REST service.

## The `delete-beacon-trigger-association` command

The `delete-beacon-trigger-association` command deletes an association between a beacon and a beacon trigger from an app in a given runtime. It has the following attributes:

Table 11-37. `delete-beacon-trigger-association` command attributes

Attribute	Description	Required	Default
<b>runtime</b>	Name of the runtime web application / MobileFirst project.	Yes	Not available
<b>app</b>	Name of an app.	Yes	Not available
<b>uuid</b>	UUID (32 hex digits) of the beacon.	Yes	Not available
<b>major</b>	Major number of the beacon.	Yes	Not available
<b>minor</b>	Minor number of the beacon.	Yes	Not available
<b>triggerName</b>	Name of the beacon trigger.	Yes	Not available

Example:

```
<delete-beacon-trigger-association runtime="worklight" app="productguide"
uuid="496E-974C-CEDE-8679-1CF9-A8EF-2E51-45B6" major="1" minor="23"
triggerName="entrance-alert"/>
```

This command is based on the “Associate beacons and triggers (DELETE)” on page 9-53 REST service.

## Commands for devices

When you call the `wladm` Ant task, you can include various commands for devices.

## The list-devices command

The **list-devices** command returns the list of devices that have contacted the apps of a runtime. It has the following attributes:

Table 11-38. list-devices command attributes

Attribute	Description	Required	Default
<b>runtime</b>	Name of the runtime web application / MobileFirst project.	Yes	Not available
<b>query</b>	A friendly name or user identifier to search for.	No	
<b>output</b>	Name of output file.	No	
<b>outputproperty</b>	Name of Ant property for the output.	No	

The **query** parameter specifies a string to search for. All devices that have a friendly name or user identifier that contains this string (with case-insensitive matching) are returned.

Examples:

```
<list-devices runtime="worklight"/>
```

```
<list-devices runtime="worklight" query="john"/>
```

This command is based on the “Devices (GET)” on page 9-100 REST service.

## The remove-device command

The **remove-device** command clears the record about a device that has contacted the apps of a runtime. It has the following attributes:

Table 11-39. remove-device command attributes

Attribute	Description	Required	Default
<b>runtime</b>	Name of the runtime web application / MobileFirst project.	Yes	Not available
<b>id</b>	Unique device identifier.	Yes	Not available

Example:

```
<remove-device runtime="worklight" id="496E974CCEDE86791CF9A8EF2E5145B6"/>
```

This command is based on the “Device (DELETE)” on page 9-94 REST service.

## The device command group

The **device** command group has the following attributes:

Table 11-40. **device** command group attributes

Attribute	Description	Required	Default
<b>runtime</b>	Name of the runtime web application / MobileFirst project.	Yes	Not available
<b>id</b>	Unique device identifier.	Yes	Not available

It supports the following elements:

Table 11-41. **device** command group elements

Element	Description	Count
set-status	Changes the status.	0..∞
set-appstatus	Changes the status for an app.	0..∞

## The set-status command

The **set-status** command changes the status of a device, in the scope of a runtime. It has the following attributes:

Table 11-42. **set-status** command attributes

Attribute	Description	Required	Default
<b>status</b>	New status.	Yes	Not available

The status can be one of:

- ACTIVE
- LOST
- STOLEN
- EXPIRED
- DISABLED

Example:

```
<device runtime="worklight" id="496E974CCEDE86791CF9A8EF2E5145B6">  
  <set-status status="EXPIRED"/>  
</device>
```

This command is based on the “Device Status (PUT)” on page 9-97 REST service.

## The set-appstatus command

The **set-appstatus** command changes the status of a device, regarding an app in a runtime. It has the following attributes:

Table 11-43. **set-appstatus** command attributes

Attribute	Description	Required	Default
<b>app</b>	Name of an app.	Yes	Not available

Table 11-43. `set-appstatus` command attributes (continued)

Attribute	Description	Required	Default
<code>status</code>	New status.	Yes	Not available

The status can be one of:

- ENABLED
- DISABLED

Example:

```
<device runtime="worklight" id="496E974CCEDE86791CF9A8EF2E5145B6">
  <set-appstatus app="MyApp" status="DISABLED"/>
</device>
```

This command is based on the “Device Application Status (PUT)” on page 9-90 REST service.

## Commands for troubleshooting

The following commands can help investigate problems with the MobileFirst Server web applications.

### The `show-info` command

The `show-info` command shows basic information about the MobileFirst administration services that can be returned without accessing any runtime nor database. This command can be used to test whether the MobileFirst administration services are running at all. It has the following attributes:

Table 11-44. `show-info` command attributes

Attribute	Description	Required	Default
<code>output</code>	Name of output file.	No	
<code>outputproperty</code>	Name of Ant property for the output.	No	

Example:

```
<show-info/>
```

### The `show-versions` command

The `show-versions` command displays the MobileFirst versions of various components:

- **wladmVersion:** the exact MobileFirst Server version number from which `worklight-ant-deployer.jar` is taken.
- **productVersion:** the exact MobileFirst Server version number from which `worklightadmin.war` is taken.

And for every project WAR file:

- **serverVersion:** the exact MobileFirst Server version number from which `worklight-jee-library.jar` is taken.
- **platformVersion:** the exact version number of the MobileFirst development tools that built the project WAR file.



It has the following attributes:

*Table 11-45. show-versions command attributes*

Attribute	Description	Required	Default
<b>output</b>	Name of output file.	No	
<b>outputproperty</b>	Name of Ant property for the output.	No	

Example:

```
<show-versions/>
```

## The list-runtimes command

The **list-runtimes** command returns a list of the deployed runtimes (MobileFirst projects). It has the following attributes:

*Table 11-46. list-runtimes command attributes*

Attribute	Description	Required	Default
<b>inDatabase</b>	Whether to look in the database instead of via MBeans.	No	false
<b>output</b>	Name of output file.	No	
<b>outputproperty</b>	Name of Ant property for the output.	No	

Examples:

```
<list-runtimes/>
```

```
<list-runtimes inDatabase="true"/>
```

This command is based on the “Runtimes (GET)” on page 9-158 REST service.

## The show-runtime command

The **show-runtime** command shows information about a given deployed runtime (MobileFirst project). It has the following attributes:

*Table 11-47. show-runtime command attributes*

Attribute	Description	Required	Default
<b>runtime</b>	Name of the runtime web application or MobileFirst project.	Yes	Not available
<b>output</b>	Name of output file.	No	
<b>outputproperty</b>	Name of Ant property for the output.	No	

Example:

```
<show-runtime runtime="worklight"/>
```

This command is based on the “Runtime (GET)” on page 9-147 REST service.

## The delete-runtime command

The **delete-runtime** command deletes the runtime, including its apps and adapters, from the database. It is only possible to delete a runtime when its web application is stopped. It has the following attributes:

Table 11-48. delete-runtime command attributes

Attribute	Description	Required	Default
<b>runtime</b>	Name of the runtime web application or MobileFirst project.	Yes	Not available
<b>condition</b>	Condition when to delete it: empty or always (dangerous!)	No	

Example:

```
<delete-runtime runtime="worklight" condition="empty"/>
```

This command is based on the “Runtime (DELETE)” on page 9-146 REST service.

## The list-farm-members command

The **list-farm-members** command returns a list of the farm member servers on which a given runtime is deployed. It has the following attributes:

Table 11-49. list-farm-members command attributes

Attribute	Description	Required	Default
<b>runtime</b>	Name of the runtime web application or MobileFirst project.	Yes	Not available
<b>output</b>	Name of output file.	No	
<b>outputproperty</b>	Name of Ant property for the output.	No	

Example:

```
<list-farm-members runtime="worklight"/>
```

This command is based on the “Farm topology members (GET)” on page 9-107 REST service.

## The remove-farm-member command

The **remove-farm-member** command removes a server from the list of farm members on which a given runtime is deployed. This command should be used when the server has become unavailable or disconnected. It has the following attributes:

Table 11-50. `remove-farm-member` command attributes

Attribute	Description	Required	Default
<code>runtime</code>	Name of the runtime web application or MobileFirst project.	Yes	Not available
<code>serverId</code>	Identifier of the server.	Yes	Not available
<code>force</code>	Force removal of a farm member, even if it is available and connected.	No	false

Example:

```
<remove-farm-member runtime="worklight" serverId="srvlx15"/>
```

This command is based on the “Farm topology members (DELETE)” on page 9-109 REST service.

## A complex example of a `wladm` Ant task

Here is an example of how to use several `wladm` invocations and XML processing to solve more complex tasks.

This example lists all access rules of all apps in all runtimes. The third-party XMLTask Ant task, from oopsconsultancy is used, which provides, in particular:

- Iteration over a list of XML elements that are specified through an XPath expression.
- Access to several attributes of an XML element, in each iteration.

Here is an example of the code:

```
<?xml version="1.0" encoding="UTF-8"?>
<project default="main">
  <!-- Prerequisite for using the <wladm> Ant task. -->
  <taskdef resource="com/worklight/ant/deployers/antlib.xml">
    <classpath>
      <pathelement location="/opt/IBM/Worklight/WorklightServer/worklight-ant-deployer.jar"/>
    </classpath>
  </taskdef>
  <!-- Prerequisite for using the <xmltask> Ant task. -->
  <taskdef name="xmltask" classname="com.oopsconsultancy.xmltask.ant.XmlTask">
    <classpath>
      <pathelement location="/opt/xmltask/xmltask.jar"/>
    </classpath>
  </taskdef>

  <!-- Parameters for every <wladm> invocation. -->
  <property name="url" value="https://localhost:8443/worklightadmin"/>
  <property name="user" value="demo"/>
  <property name="password" value="demo"/>
  <property name="secure" value="false"/>

  <target name="main">
    <wladm url="${url}" user="${user}" password="${password}" secure="${secure}">
      <list-runtimes output="/tmp/ListRuntimes.xml" inDatabase="true"/>
    </wladm>
    <xmltask source="/tmp/ListRuntimes.xml">
      <call path="/projectconfiguration/projects/project">
        <param name="runtime" path="@name"/>
      </call>
    </xmltask>
  </target>
</project>
```

```

<echo message="runtime=@{runtime}"/>
<sequential>
  <wladm url="{url}" user="{user}" password="{password}" secure="{secure}">
    <list-apps runtime="@{runtime}" output="/tmp/ListApps.xml"/>
  </wladm>
  <xmltask source="/tmp/ListApps.xml">
    <call path="/applications/items/item/appVersions/appVersion">
      <param name="name" path="@application"/>
      <param name="environment" path="@environment"/>
      <param name="version" path="@version"/>
      <actions>
        <sequential>
          <echo message="Access rules for app name=@{name}, environment=@{environment}, version=@{version}:"/>
          <wladm url="{url}" user="{user}" password="{password}" secure="{secure}">
            <app-version runtime="@{runtime}" name="@{name}" environment="@{environment}" version="@{version}">
              <get-accessrule/>
            </app-version>
          </wladm>
        </sequential>
      </actions>
    </call>
  </xmltask>
</sequential>
</actions>
</call>
</xmltask>
</target>
</project>

```

---

## Administering MobileFirst applications through the command line

You can administer MobileFirst applications through the `wladm` program.

### Comparison with other facilities

You can execute administration operations with IBM MobileFirst Platform Foundation for iOS in the following ways:

- The MobileFirst Operations Console, which is interactive.
- The `wladm` Ant task.
- The `wladm` program.
- The MobileFirst administration REST services.

The `wladm` Ant task, `wladm` program, and REST services are useful for automated or unattended execution of operations, such as eliminating operator errors in repetitive operations or operating outside the operator's normal working hours.

The `wladm` program and the `wladm` Ant task are simpler to use and have better error reporting than the REST services. The advantage of the `wladm` program over the `wladm` Ant task is that it is easier to integrate when integration with operating system commands is already available. Moreover, it is more suitable to interactive use.

### Prerequisites

The `wladm` command is provided in the `product_install_dir/shortcuts/` directory as a set of scripts:

- `wladm` for UNIX / Linux
- `wladm.bat` for Windows

These scripts are ready to run, which means that they do not require specific environment variables. If the environment variable `JAVA_HOME` is set, the scripts accept it.

To use the `wladm` program, either put the `product_install_dir/shortcuts/` directory into your `PATH` environment variable, or reference its absolute file name in each call.

## Calling the wladm program

You can use the `wladm` program to administer MobileFirst applications.

### Syntax

Call the `wladm` program as follows:

```
wladm --url= --user= ... [--passwordfile=...] [--secure=false] some command
```

The `wladm` program has the following options:

*Table 11-51. wladm program options*

Option	Type	Description	Required	Default
<code>--url</code>	URL	Base URL of the MobileFirst web application for administration services	Yes	
<code>--secure</code>	Boolean	Whether to avoid operations with security risks	No	true
<code>--user</code>	name	User name for accessing the MobileFirst admin services	Yes	
<code>--passwordfile</code>	file	File containing the password for the user	No	
<code>--timeout</code>	Number	Timeout for the entire REST service access, in seconds	No	
<code>--connect-timeout</code>	Number	Timeout for establishing a network connection, in seconds	No	
<code>--socket-timeout</code>	Number	Timeout for detecting the loss of a network connection, in seconds	No	
<code>--connection-request-timeout</code>	Number	Timeout for obtaining an entry from a connection request pool, in seconds	No	
<code>--verbose</code>		Detailed output	No	

#### url

The URL preferably uses the HTTPS protocol. For example, if you use default ports and context roots, use this URL:

- For WebSphere Application Server: `https://server:9443/wladmin`
- For Tomcat: `https://server:8443/wladmin`

#### secure

The `--secure` option is set to true by default. Setting it to `--secure=false` might have the following effects:

- The user and password might be transmitted in an unsecured way (possibly even through unencrypted HTTP).

- The server's SSL certificates are accepted even if self-signed or if they were created for a different host name from the server's host name.

### password

Specify the password in a separate file that you pass in the **--passwordfile** option. In interactive mode (see “Interactive mode” on page 11-39), you can alternatively specify the password interactively. The password is sensitive information and therefore needs to be protected. You must prevent other users on the same computer from knowing these passwords. To secure the password, before you enter the password into a file, you must remove the read permissions of the file for users other than yourself. For example, you can use one of the following commands:

- On UNIX: `chmod 600 adminpassword.txt`
- On Windows: `cacls adminpassword.txt /P Administrators:F %USERDOMAIN%\%USERNAME%:F`

For this reason, do not pass the password to a process through a command-line argument. On many operating systems, other users can inspect the command-line arguments of your processes.

The `wladm` calls contains a command. The following commands are supported.

Table 11-52. *wladm* invocation supported commands

Command	Description
<code>show info</code>	Shows user and configuration information
<code>show versions</code>	Shows version information
<code>list runtimes [--in-database]</code>	Lists the runtimes
<code>show runtime [runtime-name]</code>	Shows information about a runtime
<code>delete runtime [runtime-name] condition</code>	Deletes a runtime
<code>list adapters [runtime-name]</code>	Lists the adapters
<code>deploy adapter [runtime-name] file</code>	Deploys an adapter
<code>show adapter [runtime-name] adapter-name</code>	Shows information about an adapter
<code>delete adapter [runtime-name] adapter-name</code>	Deletes an adapter
<code>adapter [runtime-name] adapter-name get binary [&gt; tofile]</code>	Get the binary data of an adapter
<code>list apps [runtime-name]</code>	Lists the apps
<code>deploy app [runtime-name] file</code>	Deploys an app
<code>show app [runtime-name] app-name</code>	Shows information about an app
<code>delete app [runtime-name] app-name</code>	Deletes an app
<code>delete app version [runtime-name] app-name environment version</code>	Deletes a version of an app
<code>app version [runtime-name] app-name environment version get binary [&gt; tofile]</code>	Gets the binary data of an app version
<code>app version [runtime-name] app-name environment version get accessrule</code>	Gets the access rule of an app version
<code>app version [runtime-name] app-name environment version set accessrule file</code>	Changes the access rule of an app version

Table 11-52. wladm invocation supported commands (continued)

Command	Description
app version [ <i>runtime-name</i> ] <i>app-name</i> <i>environment version get</i> <i>authenticitycheckrule</i>	Gets the authenticity check rule of an app version
app version [ <i>runtime-name</i> ] <i>app-name</i> <i>environment version set</i> <i>authenticitycheckrule action</i>	Changes the authenticity check rule of an app version
app version [ <i>runtime-name</i> ] <i>app-name</i> <i>environment version get lock</i>	Gets the lock state of an app version
app version [ <i>runtime-name</i> ] <i>app-name</i> <i>environment version set lock lock</i>	Changes the lock state of an app version
list beacons [ <i>uuid [major minor]</i> ]	Lists the beacons
set beacon <i>file</i>	Specifies information about a beacon
show beacon <i>uuid major minor</i>	Shows information about a beacon
remove beacon <i>uuid major minor</i>	Removes information about a beacon
list beacon-triggers [ <i>runtime-name</i> ]	Lists the beacon triggers
set beacon-trigger [ <i>runtime-name</i> ] <i>file</i>	Specifies a beacon trigger
show beacon-trigger [ <i>runtime-name</i> ] <i>trigger-name</i>	Shows a beacon trigger
delete beacon-trigger [ <i>runtime-name</i> ] <i>trigger-name</i>	Deletes a beacon trigger
list beacon-trigger-associations [ <i>runtime-name</i> ] <i>app-name</i> [ <i>uuid major</i> <i>minor</i> ] [ <i>trigger-name</i> ]	Lists the associations between beacons and beacon triggers
set beacon-trigger-association [ <i>runtime-name</i> ] <i>app-name uuid major minor</i> <i>trigger-name</i>	Specifies an association between a beacon and a beacon trigger
show beacon-trigger-association [ <i>runtime-name</i> ] <i>app-name uuid major minor</i> <i>trigger-name</i>	Shows the association between a beacon and a beacon trigger
delete beacon-trigger-association [ <i>runtime-name</i> ] <i>app-name uuid major minor</i> <i>trigger-name</i>	Deletes the association between a beacon and a beacon trigger
list devices [ <i>runtime-name</i> ] [--query <i>query</i> ]	Lists the devices
remove device [ <i>runtime-name</i> ] <i>id</i>	Removes a device
device [ <i>runtime-name</i> ] <i>id</i> set status <i>new-status</i>	Changes the status of a device
device [ <i>runtime-name</i> ] <i>id</i> set appstatus <i>app-name new-status</i>	Changes the status of a device for an app

## Interactive mode

Alternatively, you can also call wladm without any command in the command line. You can then enter commands interactively, one per line.

The **exit** command, or end-of-file on standard input (**Ctrl-D** on UNIX terminals) terminates wladm.

Help commands are also available in this mode. For example:

- **help**
- **help show versions**
- **help device**
- **help device set status**

## Command history in interactive mode

On some operating systems, the interactive `wladm` command remembers the command history. With the command history, you can select a previous command, using the arrow-up and arrow-down keys, edit it, and execute it.

- On Linux, the command history is enabled in terminal emulator windows if the `rlwrap` package is installed and found in `PATH`. To install the `rlwrap` package:
  - On Red Hat Linux: **sudo yum install rlwrap**
  - On SUSE Linux: **sudo zypper install rlwrap**
  - On Ubuntu: **sudo apt-get install rlwrap**
- On OS X, the command history is enabled in the Terminal program if the `rlwrap` package is installed and found in `PATH`. To install the `rlwrap` package:
  1. Install MacPorts by using the installer from [www.macports.org](http://www.macports.org).
  2. Run the command:  
**sudo /opt/local/bin/port install rlwrap**  
Then, to make the `rlwrap` program available in `PATH`, use this command in a Bourne-compatible shell:  
**PATH=/opt/local/bin:\$PATH**
- On Windows, the command history is enabled in `cmd.exe` console windows.

In environments where `rlwrap` does not work or is not required, you can disable its use through the option `--no-readline`.

## The configuration file

You can also store the options in a configuration file, instead of passing them on the command line at every call. When a configuration file is present and the option `--configfile=file` is specified, you can omit the following options:

- `--url=URL`
- `--secure=boolean`
- `--user=name`
- `--passwordfile=file`
- `--timeout=seconds`
- `--connect-timeout=seconds`
- `--socket-timeout=seconds`
- `--connection-request-timeout=seconds`
- `runtime-name`

Use these commands to store these values in the configuration file.

Table 11-53. Commands to store values in the configuration file

Command	Comment
<code>wladm [--configfile=file] config url URL</code>	



Table 11-53. Commands to store values in the configuration file (continued)

Command	Comment
wladm [--configfile= <i>file</i> ] config secure <i>boolean</i>	
wladm [--configfile= <i>file</i> ] config user <i>name</i>	
wladm [--configfile= <i>file</i> ] config password	Prompts for the password.
wladm [--configfile= <i>file</i> ] config timeout <i>seconds</i>	
wladm [--configfile= <i>file</i> ] config connect-timeout <i>seconds</i>	
wladm [--configfile= <i>file</i> ] config socket-timeout <i>seconds</i>	
wladm [--configfile= <i>file</i> ] config connection-request-timeout <i>seconds</i>	
wladm [--configfile= <i>file</i> ] config runtime <i>runtime-name</i>	

Use this command to list the values that are stored in the configuration file: `wladm [--configfile=file] config`

The configuration file is a text file, in the encoding of the current locale, in Java .properties syntax. The default configuration file is on

- UNIX: \$HOME/.wladm.config
- Windows: My Documents\IBM MobileFirst Platform Server Data\wladm.config, or My Documents\IBM Worklight Server Data\wladm.config

**Note:** When you do not specify a **--configfile** option, the default configuration file is used only in interactive mode and in **config** commands. For noninteractive use of the other commands, you must explicitly designate the configuration file if you want to use one.

**Important:** The password is stored in an obfuscated format that hides the password from an occasional glimpse. However, this obfuscation provides no security.

## Generic options

There are also the usual generic options:

Table 11-54. Generic options

Option	Description
--help	Shows some usage help
--version	Shows the version

## XML format

The commands that receive an XML response from the server verify that this response complies with the specific schema. You can disable this check by specifying `--xmlvalidation=none`.

## Output character set

Normal output that is produced by the `wladm` program is encoded in the encoding format of the current locale. On Windows, this encoding format is "ANSI code page". The effects are as follows:

- Characters outside of this character set are converted to question marks when they are output.
- When the output goes to a Windows command prompt window (`cmd.exe`), non-ASCII characters are incorrectly displayed because such windows assume characters to be encoded in "OEM code page".

To work around this limitation:

- On operating systems other than Windows, use a locale whose encoding is UTF-8. This format is the default locale on Red Hat Linux and OS X. Many other operating systems have a `en_US.UTF-8` locale.
- Or use the `wladm` Ant task, with attribute `output="some file name"` to redirect the output of a command to a file.

## Commands for adapters

When you invoke the `wladm` program, you can include various commands for adapters.

### The `list adapters` command

The `list adapters` command returns a list of the adapters that are deployed for a runtime.

Syntax:

```
list adapters [runtime-name]
```

It takes the following arguments:

Table 11-55. *list adapters* command arguments

Argument	Description
<code>runtime-name</code>	Name of the runtime web application / MobileFirst project.

It takes the following options after the object:

Table 11-56. *list adapters* options

Option	Description
<code>--xml</code>	Produce XML output instead of tabular output.

Example:

```
list adapters worklight
```

This command is based on the "Adapters (GET)" on page 9-15 REST service.

## The deploy adapter command

The deploy adapter command deploys an adapter in a runtime.

Syntax:

```
deploy adapter [runtime-name] file
```

It takes the following arguments:

*Table 11-57. deploy adapter command arguments*

Argument	Description
runtime-name	Name of the runtime web application / MobileFirst project.
file	Binary adapter file (.adapter)

Example:

```
deploy adapter worklight MyAdapter.adapter
```

This command is based on the “Adapter (POST)” on page 9-12 REST service.

## The show adapter command

The show adapter command shows details about an adapter.

Syntax:

```
show adapter [runtime-name] adapter-name
```

It takes the following arguments:

*Table 11-58. show adapter command arguments*

Argument	Description
runtime-name	Name of the runtime web application / MobileFirst project.
adapter-name	Name of an adapter

It takes the following options after the object:

*Table 11-59. show adapter options*

Option	Description
--xml	Produce XML output instead of tabular output.

Example:

```
show adapter worklight MyAdapter
```

This command is based on the “Adapter (GET)” on page 9-8 REST service.

## The delete adapter command

The delete adapter command removes (undeploys) an adapter from a runtime.

Syntax:

```
delete adapter [runtime-name] adapter-name
```

It takes the following arguments:

*Table 11-60. delete adapter command arguments*

Argument	Description
runtime-name	Name of the runtime web application / MobileFirst project.
adapter-name	Name of an adapter

Example:

```
delete adapter worklight MyAdapter
```

This command is based on the “Adapter (DELETE)” on page 9-5 REST service.

## The adapter command prefix

The adapter command prefix takes the following arguments before the verb:

*Table 11-61. adapter command prefix arguments*

Argument	Description
runtime-name	Name of the runtime web application / MobileFirst project.
adapter-name	Name of an adapter

## The adapter get binary command

The adapter get binary command returns the binary adapter file.

Syntax:

```
adapter [runtime-name] adapter-name get binary [> tofile]
```

It takes the following options after the verb:

*Table 11-62. adapter get binary options*

Option	Description	Required	Default
> <i>tofile</i>	Name of the output file.	No	Standard output

Example:

```
adapter worklight MyAdapter get binary > /tmp/MyAdapter.adapter
```

This command is based on the “Adapter Binary (GET, HEAD)” on page 9-4 REST service.

## Commands for apps

When you invoke the `wl adm` program, you can include various commands for apps.

## The enable extended-authenticity command

The **enable extended-authenticity** command creates a `.wlapp` file that is based on an original `.wlapp` file. But, this new file's extended authenticity property is enabled.

Syntax:

```
enable extended-authenticity src-wlapp-file device-file > dest-wlapp-file
```

It takes the following arguments:

Table 11-63. The **enable extended-authenticity** command's arguments

Argument	Description
<code>src-wlapp-file</code>	Original binary app file ( <code>.wlapp</code> , not <code>.apk</code> , or <code>.ipa</code> )
<code>device-file</code>	Binary mobile app file ( <code>.apk</code> , <code>.ipa</code> , or <code>.xap</code> )
<code>dest-wlapp-file</code>	Output binary app file ( <code>.wlapp</code> , not <code>.apk</code> , or <code>.ipa</code> )

Example:

```
enable extended-authenticity myapp-iphone-1.0.wlapp MyApp.ipa > myapp-iphone-1.0.extauth.wlapp
```

If you are invoking this command from the operating system command line, you need to escape the ">" character so that the command interpreter (shell or `cmd.exe`) does not intercept it. For example:

```
wladm enable extended-authenticity myapp-iphone-1.0.wlapp MyApp.ipa ">" myapp-iphone-1.0.extauth.wlapp
```

This command operates locally, without connecting to the server. For more information about enabling extended app authenticity checking, see “Configuring extended app authenticity checking” on page 10-51.

## The list apps command

The **list apps** command returns a list of the apps that are deployed in a run time.

Syntax:

```
list apps [runtime-name]
```

It takes the following arguments:

Table 11-64. The **list apps** command's arguments

Argument	Description
<code>runtime-name</code>	Name of the runtime web application / MobileFirst project.

It takes the following options after the object:

Table 11-65. The **list apps** command's options

Option	Description
<code>--xml</code>	Produce XML output instead of tabular output.

Example:

```
list apps worklight
```

This command is based on the “Applications (GET)” on page 9-49 REST service.

## The deploy app command

The **deploy app** command deploys an app (possibly with multiple environments) in a run time.

Syntax:

```
deploy app [runtime-name] file
```

It takes the following arguments:

Table 11-66. The **deploy app** command's arguments

Argument	Description
runtime-name	Name of the runtime web application / MobileFirst project.
file	Binary app file (.wlapp, not .apk, or .ipa)

Example:

```
deploy app worklight MyApp-all.wlapp
```

This command is based on the “Application (POST)” on page 9-45 REST service.

## The show app command

The **show app** command shows details about an app in a run time, in particular its environments and versions.

Syntax:

```
show app [runtime-name] app-name
```

It takes the following arguments:

Table 11-67. The **show app** command's arguments

Argument	Description
runtime-name	Name of the runtime web application / MobileFirst project.
app-name	Name of an app

It takes the following options after the object:

Table 11-68. The **show app** command's options

Option	Description
--xml	Produce XML output instead of tabular output.

Example:

```
show app worklight MyApp
```

This command is based on the “Application (GET)” on page 9-41 REST service.

## The delete app command

The **delete app** command removes (undeploys) an app (from all environments, and all versions) from a run time.

Syntax:

```
delete app [runtime-name] app-name
```

It takes the following arguments:

*Table 11-69. The delete app command's arguments*

Argument	Description
runtime-name	Name of the runtime web application / MobileFirst project
app-name	Name of an app

Example:

```
delete app worklight MyApp
```

This command is based on the “Application (DELETE)” on page 9-38 REST service.

## The delete app version command

The **delete app version** command removes (undeploys) an app version from a run time.

Syntax:

```
delete app version [runtime-name] app-name environment version
```

It takes the following arguments:

*Table 11-70. The delete app version command's arguments*

Argument	Description
runtime-name	Name of the runtime web application / MobileFirst project.
app-name	Name of an app
environment	Mobile platform
version	Version of the app

Example:

```
delete app version worklight MyApp iPhone 1.1
```

This command is based on the “App Version (DELETE)” on page 9-31 REST service.

## The app version command prefix

The **app version** command prefix takes the following arguments before the verb:

Table 11-71. The **app version** command's prefix arguments

Argument	Description
runtime-name	Name of the runtime web application / MobileFirst project.
app-name	Name of an app
environment	Mobile platform
version	Version of the app

## The app version get binary command

The **app version get binary** command returns the binary wlap file for a version of an app.

Syntax:

```
app version [runtime-name] app-name environment version get binary [> tofile]
```

It takes the following arguments after the verb:

Table 11-72. The **app version get binary** command's arguments

Argument	Description	Required	Default
> tofile	Name of the output file.	No	Standard output

Example:

```
app version worklight MyApp iPhone 1.1 get binary > /tmp/MyApp.wlap
```

This command is based on the “Application Binary (GET, HEAD)” on page 9-37 REST service.

## The app version get accessrule command

The **app version get accessrule** command returns the access rule for an app version.

Syntax:

```
app version [runtime-name] app-name environment version get accessrule
```

Example:

```
app version worklight MyApp iPhone 1.1 get accessrule
```

This command is based on the “Application (GET)” on page 9-41 REST service.

## The app version set accessrule command

The **app version set accessrule** command changes the access rule for an app version.

Syntax:



app version [*runtime-name*] *app-name environment version* set accessrule *file*

It takes the following arguments after the verb:

Table 11-73. The **app version set accessrule** command's arguments

Argument	Description
file	Name of the input file.

Example:

```
app version worklight MyApp iPhone 1.1 set accessrule /tmp/new-accessrule.xml
```

This command is based on the “App Version Access Rule (PUT)” on page 9-27 REST service.

## The app version get authenticitycheckrule command

The **app version get authenticitycheckrule** command returns the authenticity check rule for an app version. This command is no longer supported with servers of IBM MobileFirst Platform Foundation for iOS V7.0.0 or later. This command is only available with V6.2.0 and V6.3.0.

Syntax:

```
app version [runtime-name] app-name environment version get authenticitycheckrule
```

Example:

```
app version worklight MyApp iPhone 1.1 get authenticitycheckrule
```

This command is based on the “Application (GET)” on page 9-41 REST service.

## The app version set authenticitycheckrule command

The **app version set authenticitycheckrule** command changes the authenticity check rule for an app version. This command is no longer supported with servers of IBM MobileFirst Platform Foundation for iOS V7.0.0 or later. This command is only available with V6.2.0 and V6.3.0.

Syntax:

```
app version [runtime-name] app-name environment version set authenticitycheckrule action
```

It takes the following arguments after the verb:

Table 11-74. The **app version set authenticitycheckrule** command's arguments

Argument	Description
action	Action to perform for authenticity checking

The following actions are possible:

- **DISABLED:** Authenticity is not checked
- **IGNORED:** Authenticity is checked, but not enforced. If it fails, only a warning is given and the session is authorized
- **ENABLED:** Authenticity is checked and enforced

Example:

```
app version worklight MyApp iPhone 1.1 set authenticitycheckrule enabled
```

## The app version get lock command

The **app version get lock** command returns information about whether an app version is locked or unlocked.

Syntax:

```
app version [runtime-name] app-name environment version get lock
```

Example:

```
app version worklight MyApp iPhone 1.1 get lock
```

This command is based on the “Application (GET)” on page 9-41 REST service.

## The app version set lock command

The **app version set lock** command sets an app version to locked or unlocked state.

Syntax:

```
app version [runtime-name] app-name environment version set lock lock
```

It takes the following arguments after the verb:

*Table 11-75. The app version set lock command's arguments*

Argument	Description
lock	New lock state.

The possible lock values are true and false.

Example:

```
app version worklight MyApp iPhone 1.1 set lock true
```

This command is based on the “App Version Lock (PUT)” on page 9-35 REST service.

## Commands for beacons

When you call the `wladm` program, you can include various commands for the beacons and beacon triggers. A beacon is a piece of information that is associated with an iBeacon. A beacon trigger is an action that a mobile device executes in relation to an iBeacon, when there is an association between the beacon and the beacon trigger.

### The list beacons command

The **list beacons** command returns the list of beacons that match a given UUID and optionally, a given major and minor number.

Syntax:

```
list beacons [uuid [major minor]]
```

It takes the following arguments:

Table 11-76. list beacons command arguments

Argument	Description
uuid	UUID (32 hex digits) of the beacons to search for.
major	Major number of the beacons to search for. Use '_' as a wildcard.
minor	Minor number of the beacons to search for. Use '_' as a wildcard.

It takes the following options after the object:

Table 11-77. list beacons options

Option	Description
--xml	Produce XML output instead of tabular output.

Example:

```
list beacons 496E-974C-CEDE-8679-1CF9-A8EF-2E51-45B6
```

This command is based on the “Beacons (GET)” on page 9-83 REST service.

## The set beacon command

The set beacon command specifies or updates information about a beacon.

Syntax:

```
set beacon file
```

It takes the following arguments:

Table 11-78. set beacon command arguments

Argument	Description
file	Name of the input file.

The input file can be in JSON or XML format. If it is in XML format, it must follow the schema that is given in the file `product_install_dir/WorklightServer/wladmin-schemas/input/beacon.xsd`.

Example:

```
set beacon entrance.xml
```

This command is based on the “Beacons (PUT)” on page 9-86 REST service.

## The show beacon command

The show beacon command shows details about a beacon.

Syntax:

```
show beacon uuid major minor
```

It takes the following arguments:

Table 11-79. show beacon command arguments

Argument	Description
uuid	UUID (32 hex digits) of the beacon.
major	Major number of the beacon.
minor	Minor number of the beacon.

It takes the following options after the object:

Table 11-80. show beacon options

Option	Description
--xml	Produce XML output instead of tabular output.

Example:

```
show beacon 496E-974C-CEDE-8679-1CF9-A8EF-2E51-45B6 1 23
```

This command is based on the “Beacons (GET)” on page 9-83 REST service.

## The remove beacon command

The remove beacon command removes (clears) the information about a beacon.

Syntax:

```
remove beacon uuid major minor
```

It takes the following arguments:

Table 11-81. remove beacon command arguments

Argument	Description
uuid	UUID (32 hex digits) of the beacon.
major	Major number of the beacon.
minor	Minor number of the beacon.

Example:

```
remove beacon 496E-974C-CEDE-8679-1CF9-A8EF-2E51-45B6 1 23
```

This command is based on the “Beacons (DELETE)” on page 9-80 REST service.

## The list beacon-triggers command

The list beacon-triggers command returns the list of beacon triggers, belonging to a given runtime.

Syntax:

```
list beacon-triggers [runtime-name]
```

It takes the following arguments:

Table 11-82. list beacon-triggers command arguments

Argument	Description
runtime-name	Name of the runtime web application / MobileFirst project.

It takes the following options after the object:

Table 11-83. list beacon-triggers options

Option	Description
--xml	Produce XML output instead of tabular output.

Example:

```
list beacon-triggers worklight
```

This command is based on the “Beacon Triggers (GET)” on page 9-69 REST service.

## The set beacon-trigger command

The set beacon-trigger command specifies or updates information about a beacon trigger, belonging to a given runtime.

Syntax:

```
set beacon-trigger [runtime-name] file
```

It takes the following arguments:

Table 11-84. set beacon-trigger command arguments

Argument	Description
runtime-name	Name of the runtime web application / MobileFirst project.
file	Name of the input file.

The input file can be in JSON or XML format. If it is in XML format, it must follow the schema that is given in the file *product\_install\_dir/WorklightServer/wladmin-schemas/input/beacon-trigger.xsd*.

Example:

```
set beacon-trigger worklight entrance-alert.xml
```

This command is based on the “Beacon Triggers (PUT)” on page 9-76 REST service.

## The show beacon-trigger command

The show beacon-trigger command shows details about a beacon trigger, belonging to a given runtime.

Syntax:

```
show beacon-trigger [runtime-name] trigger-name
```

It takes the following arguments:

Table 11-85. show beacon-trigger command arguments

Argument	Description
runtime-name	Name of the runtime web application / MobileFirst project.
trigger-name	Name of the beacon trigger.

It takes the following options after the object:

Table 11-86. show beacon-trigger options

Option	Description
--xml	Produce XML output instead of tabular output.

Example:

```
show beacon-trigger worklight entrance-alert
```

This command is based on the “Beacon Trigger (GET)” on page 9-67 REST service.

## The delete beacon-trigger command

The delete beacon-trigger command deletes a beacon trigger from a given runtime.

Syntax:

```
delete beacon-trigger [runtime-name] trigger-name
```

It takes the following arguments:

Table 11-87. delete beacon-trigger command arguments

Argument	Description
runtime-name	Name of the runtime web application / MobileFirst project.
trigger-name	Name of the beacon trigger.

Example:

```
delete beacon-trigger worklight entrance-alert
```

This command is based on the “Beacon Trigger (DELETE)” on page 9-64 REST service.

## The list beacon-trigger-associations command

The list beacon-trigger-associations command returns the list of associations between beacons and beacon triggers that match given criteria, belonging to an app in a given runtime.

Syntax:

```
list beacon-trigger-associations [runtime-name] app-name [uuid major minor] [trigger-name]
```

It takes the following arguments:

*Table 11-88. list beacon-trigger-associations command arguments*

Argument	Description
runtime-name	Name of the runtime web application / MobileFirst project.
app-name	Name of an app.
uuid	UUID (32 hex digits) of the beacon.
major	Major number of the beacon. Use '_' as a wildcard.
minor	Minor number of the beacon. Use '_' as a wildcard.
trigger-name	Name of the beacon trigger.

It takes the following options after the object:

*Table 11-89. list beacon-trigger-associations options*

Option	Description
--xml	Produce XML output instead of tabular output.

Examples:

```
list beacon-trigger-associations worklight productguide
```

```
list beacon-trigger-associations worklight productguide 496E-974C-CEDE-8679-1CF9-A8EF-2E51-45B6 1 23
```

```
list beacon-trigger-associations worklight productguide entrance-alert
```

This command is based on the “Associate beacons and triggers (GET)” on page 9-57 REST service.

## The set beacon-trigger-association command

The set beacon-trigger-association command specifies an association between a beacon and a beacon trigger, belonging to an app in a given runtime.

Syntax:

```
set beacon-trigger-association [runtime-name] app-name uuid major minor trigger-name
```

It takes the following arguments:

*Table 11-90. set beacon-trigger-association command arguments*

Argument	Description
runtime-name	Name of the runtime web application / MobileFirst project.
app-name	Name of an app.
uuid	UUID (32 hex digits) of the beacon.
major	Major number of the beacon.

Table 11-90. *set beacon-trigger-association* command arguments (continued)

Argument	Description
minor	Minor number of the beacon.
trigger-name	Name of the beacon trigger.

Example:

```
set beacon-trigger-association worklight productguide 496E-974C-CEDE-8679-1CF9-A8EF-2E51-45B6 1 23 entrance-alert
```

This command is based on the “Associate beacons and triggers (PUT)” on page 9-59 REST service.

## The show beacon-trigger-association command

The show beacon-trigger-association command shows an association between a beacon and a beacon trigger, belonging to an app in a given runtime.

Syntax:

```
show beacon-trigger-association [runtime-name] app-name uuid major minor trigger-name
```

It takes the following arguments:

Table 11-91. *show beacon-trigger-association* command arguments

Argument	Description
runtime-name	Name of the runtime web application / MobileFirst project.
app-name	Name of an app.
uuid	UUID (32 hex digits) of the beacon.
major	Major number of the beacon.
minor	Minor number of the beacon.
trigger-name	Name of the beacon trigger.

It takes the following options after the object:

Table 11-92. *show beacon-trigger-association* options

Option	Description
--xml	Produce XML output instead of tabular output.

Example:

```
show beacon-trigger-association worklight productguide 496E-974C-CEDE-8679-1CF9-A8EF-2E51-45B6 1 23 entrance-alert
```

This command is based on the “Associate beacons and triggers (GET)” on page 9-57 REST service.



## The delete beacon-trigger-association command

The delete beacon-trigger-association command deletes an association between a beacon and a beacon trigger from an app in a given runtime.

Syntax:

```
delete beacon-trigger-association [runtime-name] app-name uuid major minor trigger-name
```

It takes the following arguments:

Table 11-93. delete beacon-trigger-association command arguments

Argument	Description
runtime-name	Name of the runtime web application / MobileFirst project.
app-name	Name of an app.
uuid	UUID (32 hex digits) of the beacon.
major	Major number of the beacon.
minor	Minor number of the beacon.
trigger-name	Name of the beacon trigger.

Example:

```
delete beacon-trigger-association worklight productguide  
496E-974C-CEDE-8679-1CF9-A8EF-2E51-45B6 1 23 entrance-alert
```

This command is based on the “Associate beacons and triggers (DELETE)” on page 9-53 REST service.

## Commands for devices

When you invoke the wladm program, you can include various commands for devices.

### The list devices command

The list devices command returns the list of devices that have contacted the apps of a runtime.

Syntax:

```
list devices [runtime-name] [--query query]
```

It takes the following arguments:

Table 11-94. list devices command arguments

Argument	Description
runtime-name	Name of the runtime web application / MobileFirst project.
query	A friendly name or user identifier, to search for.

The query parameter specifies a string to search for. All devices that have a friendly name or user identifier that contains this string (with case-insensitive matching) are returned.

It takes the following options after the object:

*Table 11-95. list devices options*

Option	Description
--xml	Produce XML output instead of tabular output.

Examples:

```
list-devices worklight
list-devices worklight --query=john
```

This command is based on the “Devices (GET)” on page 9-100 REST service.

## The remove device command

The remove device command clears the record about a device that has contacted the apps of a runtime.

Syntax:

```
remove device [runtime-name] id
```

It takes the following arguments:

*Table 11-96. remove device command arguments*

Argument	Description
runtime-name	Name of the runtime web application / MobileFirst project.
id	Unique device identifier.

Example:

```
remove device worklight 496E974CCEDE86791CF9A8EF2E5145B6
```

This command is based on the “Device (DELETE)” on page 9-94 REST service.

## The device command prefix

The device command prefix takes the following arguments before the verb:

*Table 11-97. device command prefix arguments*

Argument	Description
runtime-name	Name of the runtime web application / MobileFirst project.
id	Unique device identifier.

## The device set status command

The device set status command changes the status of a device, in the scope of a runtime.

Syntax:

```
device [runtime-name] id set status new-status
```

It takes the following arguments:

Table 11-98. device set status command arguments

Argument	Description
new-status	New status.

The status can be:

- ACTIVE
- LOST
- STOLEN
- EXPIRED
- DISABLED

Example:

```
device worklight 496E974CCEDE86791CF9A8EF2E5145B6 set status EXPIRED
```

This command is based on the “Device Status (PUT)” on page 9-97 REST service.

## The device set appstatus command

The device set appstatus command changes the status of a device, regarding an app in a runtime.

Syntax:

```
device [runtime-name] id set appstatus app-name new-status
```

It takes the following arguments:

Table 11-99. device set appstatus command arguments

Argument	Description
app-name	Name of an app.
new-status	New status.

The status can be:

- ENABLED
- DISABLED

Example:

```
device worklight 496E974CCEDE86791CF9A8EF2E5145B6 set appstatus MyApp DISABLED
```

This command is based on the “Device Application Status (PUT)” on page 9-90 REST service.

## Commands for troubleshooting

When you invoke the `wl adm` program, you can include various commands for troubleshooting.

### The show info command

The `show info` command shows basic information about the MobileFirst administration services that can be returned without accessing any runtime nor database. This command can be used to test whether the MobileFirst administration services are running at all.

Syntax:

```
show info
```

It takes the following options after the object:

*Table 11-100. show info options*

Option	Description
--xml	Produce XML output instead of tabular output.

Example:

```
show info
```

## The show versions command

The show versions command displays the MobileFirst versions of various components:

- `wladmVersion`: the exact MobileFirst Server version number from which `worklight-ant-deployer.jar` is taken.
- `productVersion`: the exact MobileFirst Server version number from which `worklightadmin.war` is taken

and for every project WAR file:

- `serverVersion`: the exact MobileFirst Server version number from which `worklight-jee-library.jar` is taken
- `platformVersion`: the exact version number of the MobileFirst development tools that built the project WAR file

Syntax:

```
show versions
```

It takes the following options after the object:

*Table 11-101. show versions options*

Option	Description
--xml	Produce XML output instead of tabular output.

Example:

```
show versions
```

## The list runtimes command

The list runtimes command returns a list of the deployed runtimes (MobileFirst projects).

Syntax:

```
list runtimes [--in-database]
```

It takes the following options:

Table 11-102. list runtimes options

Option	Description
--in-database	Whether to look in the database instead of via MBeans
--xml	Produce XML output instead of tabular output.

Examples:

```
list runtimes
list runtimes --in-database
```

This command is based on the “Runtimes (GET)” on page 9-158 REST service.

## The show runtime command

The show runtime command shows information about a given deployed runtime (MobileFirst project).

Syntax:

```
show runtime [runtime-name]
```

It takes the following arguments:

Table 11-103. show runtime arguments

Argument	Description
runtime-name	Name of the runtime web application or MobileFirst project.

It takes the following options after the object:

Table 11-104. show runtime options

Option	Description
--xml	Produce XML output instead of tabular output.

Example:

```
show runtime worklight
```

This command is based on the “Runtime (GET)” on page 9-147 REST service.

## The delete runtime command

The delete runtime command deletes a runtime, including its apps and adapters, from the database. It is only possible to delete a runtime when its web application is stopped.

Syntax:

```
delete runtime [runtime-name] condition
```

It takes the following arguments:

Table 11-105. delete runtime arguments

Argument	Description
runtime-name	Name of the runtime web application or MobileFirst project.
condition	Condition when to delete it: 'empty' or 'always' (dangerous!)

Example:

```
delete runtime worklight empty
```

This command is based on the “Runtime (DELETE)” on page 9-146 REST service.

## The list farm-members command

The list farm-members command returns a list of the farm member servers on which a given runtime is deployed.

Syntax:

```
list farm-members [runtime-name]
```

It takes the following arguments:

Table 11-106. list farm-members arguments

Argument	Description
runtime-name	Name of the runtime web application or MobileFirst project.

It takes the following options after the object:

Table 11-107. list farm-members options

Option	Description
--xml	Produce XML output instead of tabular output.

Example:

```
list farm-members worklight
```

This command is based on the “Farm topology members (GET)” on page 9-107 REST service.

## The remove farm-member command

The remove farm-member command removes a server from the list of farm members on which a given runtime is deployed. This command should be used when the server has become unavailable or disconnected.

Syntax:

```
remove farm-member [runtime-name] server-id
```

It takes the following arguments:

Table 11-108. remove farm-member arguments

Argument	Description
runtime-name	Name of the runtime web application or MobileFirst project.
server-id	Identifier of the server.

It takes the following options after the object:

Table 11-109. remove farm-member option

Option	Description
--force	Force removal of a farm member, even if it is available and connected.

Example:

```
remove farm-member worklight srvlx15
```

This command is based on the “Farm topology members (DELETE)” on page 9-109 REST service.

---

## Administering push notifications with the MobileFirst Operations Console

The Push Notifications page in the MobileFirst Operations Console provides you with a quick view of the various entities in the push notification chain.

The **EVENT SOURCES** tab displays the list of data sources that are configured in your MobileFirst Server, including the number of users that are subscribed to notifications from each source.

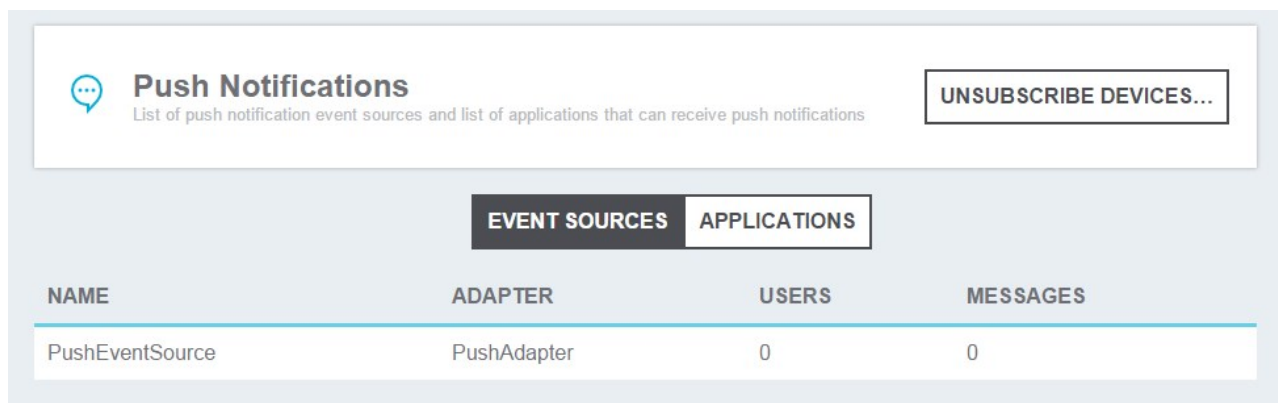

Figure 11-6. Data sources of push notifications in the MobileFirst Operations Console

Clicking **APPLICATIONS** displays the deployed applications that can receive push notifications. For each application, the push notification services available for this application are also displayed. The console displays the number of notifications that are retrieved by an event source and sent to each application since system startup. It also displays errors that are related to connectivity to the push notification services.

Home > WorklightStarter > Push notifications



### Push Notifications

List of push notification event sources and list of applications that can receive push notifications

UNSUBSCRIBE DEVICES...

EVENT SOURCES APPLICATIONS

	NAME	USERS	DEVICES	MEDIATORS	MESSAGES	TAGS
-	TagsTest	0	0		0	Tag1
<b>MEDIATORS</b>						
	Name	Users	Devices	Messages		
	Apple	0	0	0		
+	BroadcastTest	0	0		0	

Figure 11-7. Deployed applications that receive push notifications in the MobileFirst Operations Console

Administrators can forcibly unsubscribe existing SMS subscriptions by clicking **UNSUBSCRIBE DEVICES**. Administrators can enter the mobile phone numbers to be unsubscribed.

**Note:** You can have two subscriptions for the same phone number and user name; one created by using the device and one created by using the subscribe SMS servlet. If two subscriptions exist for the same phone number and user name, unsubscription by using the MobileFirst Operations Console unsubscribes both subscriptions.



## Unsubscribe from SMS push services ×

---

Unsubscribe the following numbers from all push applications. Numbers can be separated by a comma or a new line

9986417400

OKCANCEL

Figure 11-8. Unsubscribe existing SMS subscriptions

---

## Application Center

Learn about the Application Center: what it is for, the different components and features, and how to use the console and the client.

The sale of mobile devices now exceeds that of personal computers. Consequently, mobile applications become critical for businesses.

The Application Center is a tool to make sharing mobile applications within an organization easier.

You can use the Application Center as an enterprise application store. With the Application Center, you can target some mobile applications to particular groups of users within the company.

A development team can also use the Application Center during the development phase of an application to share applications with testers, designers, or executives in the company. In such a scenario, it makes collaboration easier between all the people who are involved in the development process.

### Concept of the Application Center

The Application Center can be used as an Enterprise application store and is a means of sharing information among different team members within a company.

The concept of the Application Center is similar to the concept of the Apple public App Store, except that it targets only private usage within a company.

By using the Application Center, users from the same company or organization download applications to mobile phones or tablets from a single place that serves as a repository of mobile applications.

The Application Center targets mobile applications that are installed on the device itself. Those applications can be native applications that are built by using the device SDK or hybrid applications that mix native and web content. The Application Center does not target mobile web applications; such applications are delivered to the mobile device web browser through a URL like a website.

The Application Center manages mobile applications; it supports any kind of iOS application, including applications that are built on top of the MobileFirst platform.

You can use the Application Center as part of the development process of an application. A typical scenario of the Application Center is a team building a mobile application; the development team creates a new version of an iOS application. The development team wants this new version to be reviewed and tested by the extended team. A developer goes to the Application Center console and uploads the new version of the application to the Application Center. As part of this process, the developer can enter a description of the application version. For example, the description could mention the elements that the development team added or fixed from the previous version. The new version of the application is then available to the other members of the team.

Another person, for example, a beta tester, can launch the Application Center installer application, the mobile client, to locate this new version of a mobile application in the list of available applications and install it on his mobile device. After testing the new version, the beta tester can rate the application and submit feedback. The feedback is visible to the developer from the Application Center console.

The Application Center is a convenient way to share mobile applications within a company or a group; it is a means of sharing information among team members.

## Specific platform requirements

The iOS operating system imposes specific requirements for deploying, installing, or using applications on mobile devices.

All iOS applications that are managed through the Application Center must be packaged for “Ad Hoc Distribution”. With an iOS developer account, you can share your application with up to 100 iOS devices. With an iOS enterprise account, you can share your in-house application with an unlimited number of iOS devices. See iOS Developer Program and iOS Enterprise Program for details.

For more information about “Ad Hoc Distribution”, see the Apple page about ad hoc provisioning profiles.

## General architecture

The Application Center is composed of these main elements: a server-side component, a repository, an administration console, and a mobile client application.

## **Server-side component**

The server-side component is a Java Enterprise application that must be deployed in a web application server such as IBM WebSphere or Apache Tomcat.

The server-side component consists of an administration console and a mobile application. This mobile application installs the mobile applications available to the client-side component.

The web console and the installer application communicate through REST services with the server component.

Several services compose the Application Center server-side component; for example, a service that lists available applications, a service that delivers the application binary files to the mobile device, or a service that registers feedback and ratings.

## **Repository**

A database that stores information such as which application is installed on which devices, the feedback about applications, and the mobile application binary files. The Application Center application is associated with the database when you configure the Application Center for a particular web application server and a supported database.

## **Administration console**

A web console through which administrators can manage applications, user access rights to install applications, user feedback about mobile applications, and details about applications installed on devices. See “The Application Center console” on page 11-76.

## **Mobile client application**

You use the mobile client to install applications on a mobile device and to send feedback about an application to the server. See “The mobile client” on page 11-105.

The following figure shows an overview of the architecture.

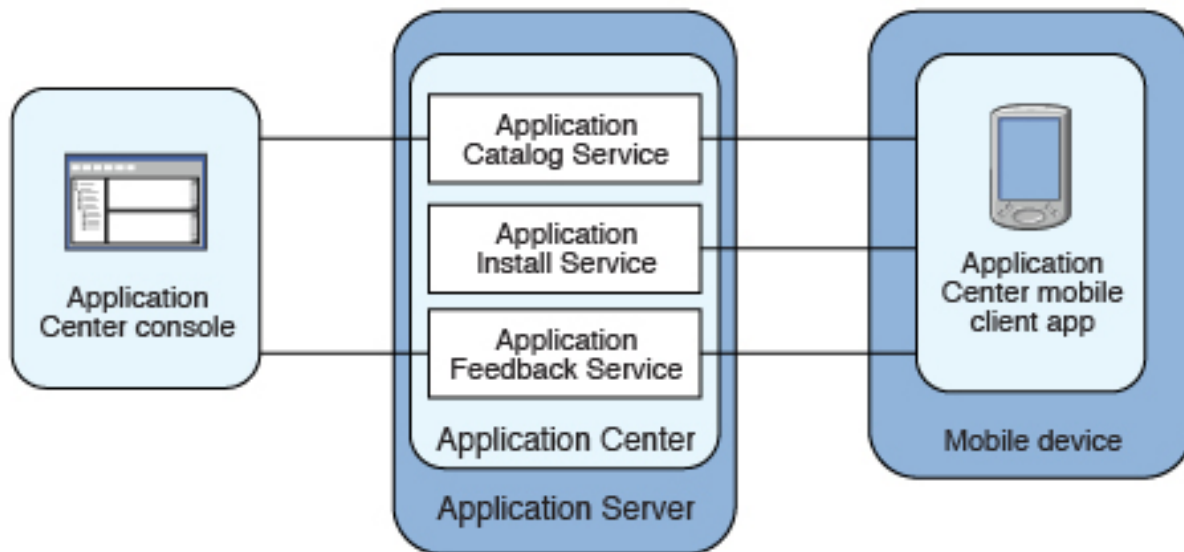

Figure 11-9. Architecture of the Application Center

From the Application Center console you can:

- Upload different versions of mobile applications.
- Remove unwanted applications.
- Control access to applications.

Access to the applications stored in the Application Center can be controlled from the Application Center console. Each application is associated with the list of people who can install the application.

- View feedback that mobile users have sent about an application.
- Obtain information about applications installed on a device.
- Make an application inactive so that it is not visible in the available applications for download.

From the mobile client you can:

- List available mobile applications.
- Install a new application on a device.
- Send feedback about an application.

You will find instructions in this document about how to configure the Application Center server-side component on various Java application servers after IBM MobileFirst Platform Foundation for iOS is installed, as well as how to build MobileFirst applications for the Application Center client.

## Preliminary information

To use the Application Center, you must configure security settings, start the web application server where IBM MobileFirst Platform Foundation for iOS is installed, start the Application Center console, and log in.

When you install IBM MobileFirst Platform Foundation for iOS, the Application Center is automatically installed in the specified application server.

If you install the Application Center in WebSphere Application Server Liberty profile, the server is created and located in *installation-directory/server*.

After the installation is complete, you must configure the security settings for the applications. See “Configuring the Application Center after installation” on page 6-188 or, if you are using LDAP authentication, “Managing users with LDAP” on page 6-194.

The following example shows how to start the server and then the Application Center console on Liberty profile.

You can start the Liberty server by using the server command located in the directory *installation-directory/server/wlp/bin*.

To start the server, use the command:

```
server start worklightServer
```

When the server is running, you can start the Application Center console by entering this address in your browser:

```
http://localhost:9080/appcenterconsole/
```

You are requested to log in. By default, the Application Center installed on Apache Tomcat or WebSphere Liberty Profile has two users defined for this installation:

- **demo** with password demo
- **appcenteradmin** with password admin

To start using the Application Center console, refer to “The Application Center console” on page 11-76.

To install and run the mobile client on iOS operating system, see “Installing the client on an iOS mobile device” on page 11-105.

## Preparations for using the mobile client

To use the mobile client to install apps on mobile devices, you must first import the **IBMApCenter** project into the Eclipse environment, build the project, and deploy the mobile client in the Application Center.

### Prerequisites for building the Application Center installer

The Application Center comes with an iOS version of the client application that runs on the mobile device. This mobile application that supports installation of applications on your mobile device is called the mobile client. The mobile client is a MobileFirst mobile application.

The MobileFirst project **IBMApCenter** contains the iOS version of the client.

The iOS version for iPad and iPhone is not delivered as a compiled application. The application must be created from the MobileFirst project named **IBMApCenter**. This project is also delivered as part of the distribution in the *ApplicationCenter/installer* directory.

To build the iOS version, you must have the appropriate MobileFirst and Apple software. The version of MobileFirst Platform Command Line Interface for iOS must be the same as the version of IBM MobileFirst Platform Server on which this

documentation is based. The Apple Xcode version is V6.1.

## Importing and building the project

You must import the **IBMApCenter** project into MobileFirst Studio and then build the project.

### About this task

Follow the normal procedure to import a project into MobileFirst Studio.

Application Center requires MobileFirst Studio for importing and building the **IBMApCenter** project. MobileFirst Studio is not part of IBM MobileFirst Platform Foundation for iOS, but if you purchased this product, you are entitled to the full cross-platform version of the product as well. For information about how to obtain MobileFirst Studio, see “Application Center requires MobileFirst Studio for importing and building the **IBMApCenter** project” on page 3-12.

### Procedure

1. Select **File > Import**.
2. Select **General > Existing Project into Workspace**.
3. On the next page, select **Select root directory** and locate the root of the **IBMApCenter** project.
4. Select “**IBMApCenter** project”.
5. Select “Copy projects into workspace”. This selection creates a copy of the project in your workspace. On UNIX systems, the **IBMApCenter** project is read only at the original location, so copying projects into workspace avoids problems with file permissions.
6. Click **Finish** to import the **IBMApCenter** project into MobileFirst Studio.

### What to do next

Build the **IBMApCenter** project. The MobileFirst project contains a single application named AppCenter. Right-click the application and select **Run as > Build All Environments**.

**iOS** MobileFirst Studio generates a native iOS project in `IBMApCenter/apps/AppCenter/iphone/native`. The `IBMApCenterAppCenterIphone.xcodeproj` file is in the `iphone/native` folder. This file is the Xcode project that you must compile and sign by using Xcode.

See The Apple developer site to learn more about how to sign the iOS mobile client application. To sign an iOS application, you must change the Bundle Identifier of the application to a bundle identifier that can be used with the provisioning profile that you use. The value is defined in the Xcode project settings as `com.your_internet_domain_name.appcenter`, where `your_internet_domain_name` is the name of your internet domain.

If you want to enable push notifications for application updates, you must first configure the Application Center client properties. See “Configuring push notifications for application updates” on page 11-73 for more information.

### Customizing features (for experts)

You can customize features by editing a central property file and manipulating some other resources.

## Purpose

To customize features: several features are controlled by a central property file called `config.json` in the directory `IBMApCenter/apps/AppCenter/common/js/appcenter/`. If you want to change the default application behavior, you can adapt this property file before you build the project.

## Properties

This file contains the properties shown in the following table.

Table 11-110. Properties in the `config.js` file

Property	Description
<code>url</code>	The hardcoded address of the Application Center server. If this property is set, the address fields of the Login view are not displayed.
<code>defaultPort</code>	If the <code>url</code> property is null, this property prefills the <b>port</b> field of the Login view on a phone. This is a default value; the field can be edited by the user.
<code>defaultContext</code>	If the <code>url</code> property is null, this property prefills the <b>context</b> field of the Login view on a phone. This is a default value; the field can be edited by the user.
<code>ssl</code>	The default value of the SSL switch of the Login view.
<code>allowDowngrade</code>	This property indicates whether installation of older versions is authorized or not; an older version can be installed only if the operating system and version permit downgrade,
<code>showPreviousVersions</code>	This property indicates whether the device user can show the details of all the versions of applications or only details of the latest version.
<code>showInternalVersion</code>	This property indicates whether the internal version is shown or not. If the value is false, the internal version is shown only if no commercial version is set.
<code>listItemRenderer</code>	This property can have one of these values: <ul style="list-style-type: none"><li>• full, the default value; the application lists show application name, rating, and latest version.</li><li>• simple: the application lists show the application name only.</li></ul>
<code>listAverageRating</code>	This property can have one of these values: <ul style="list-style-type: none"><li>• latestVersion: the application lists show the average rating of the latest version of the application.</li><li>• allVersions: the application lists show the average rating of all versions of the application.</li></ul>
<code>requestTimeout</code>	This property indicates the timeout in milliseconds for requests to the Application Center server.
<code>allowAppLinkReview</code>	This property indicates whether local reviews of applications from external application stores can be registered and browsed in the Application Center. These local reviews are not visible in the external application store. These reviews are stored in the Application Center server.

## Other resources

Other resources that are available are application icons, application name, splash screen images, icons, and translatable resources of the application.

### Application icons

iOS: Files named `iconsize.png` in the `IBMApCenter/apps/AppCenter/iphone/native/Resources` directory.

### Application name

iOS: Edit the `CFBundleDisplayName` key in the `IBMApCenter/apps/AppCenter/iphone/native/IBMApCenterAppCenterIphone-Info.plist` file.

### Splash screen images

iOS: Files named `Default-size.png` in the `IBMApCenter/apps/AppCenter/iphone/native/Resources` directory.

Hybrid splash screen during auto login: `/IBMApCenter/apps/AppCenter/common/js/idx/mobile/themes/common/idx/Launch.css`

### Icons (buttons, stars, and similar objects) of the application

`IBMApCenter/apps/AppCenter/common/css/images`.

### Translatable resources of the application

`IBMApCenter/apps/AppCenter/common/js/appcenter/nls/common.js`.

## Deploying the mobile client in Application Center

Deploy the different versions of the client application to Application Center.

The iOS version of the mobile client must be deployed to the Application Center. To do so, you must upload the iOS application (.ipa) files to the Application Center.

Follow the steps described in “Adding a mobile application” on page 11-79 to add the mobile client application for iOS. Make sure that you select the **Installer** application property to indicate that the application is an installer. Selecting this property enables mobile device users to install the mobile client application easily over the air. To install the mobile client, see the related task.

#### Related tasks:

“Installing the client on an iOS mobile device” on page 11-105

You can install the mobile client, or any signed application marked with the installer flag, on your iOS mobile device by entering the access URL in your browser, entering your credentials, and completing the required steps.

## Push notifications of application updates

You can configure the Application Center client so that push notifications are sent to users when an update is available for an application in the store.

The Application Center administrator uses push notifications to automatically send notification automatically, to any iOS device. Notifications are sent for updates to favorite applications and of new applications that are deployed on the Application Center server and that are marked as recommended.



## Push notification process

Push notifications are sent to a device if the following conditions are met:

- The device has Application Center installed and started it at least one time.
- The user has not disabled push notification for this device for the Application Center in the **Settings > Notifications** interface.
- The user is allowed to install the application. Such permissions are controlled through the Application Center access rights.
- The application is marked as recommended, or is marked as preferred for the user who is using Application Center on this device. Those flags are set automatically when the user installs an application through Application Center. You can see which applications are marked as preferred by looking at the Application Center **Favorites** tab on the device.
- The application is not installed on the device or a more recent version is available than the version that is installed on the device.

The first time that the Application Center client starts on a device, the user might be asked whether to accept incoming push notifications. This is the case for iOS mobile devices. The push notification feature does not work when the service is disabled on the mobile device.

Application Center cannot know precisely which app versions are installed because it does not detect what apps the user removed. Hence, if the user installs the latest version of an application but removes it later, no update is notified because the Application Center does not detect the removal. iOS operating system versions offer a way to switch this service on or off on a per application basis.

Refer to your device vendor to learn how to configure your mobile device for push notifications.

### Related concepts:

“Marking or unmarking a favorite app” on page 11-122

Mark your favorite apps or unmark an app to have it removed from the favorites list.

### Related reference:

“Application properties” on page 11-83

Applications have their own sets of properties that depend on the operating system on the mobile device and that cannot be edited. Applications also have a common property and editable properties.

## Configuring push notifications for application updates

Configure the Application Center services to communicate with Apple push notification servers.

### Purpose

You must configure the credentials or certificates of the Application Center services to be able to communicate with third-party push notification servers.

## Configuring the server scheduler of the Application Center

The server scheduler is a background service that automatically starts and stops with the server. This scheduler is used to empty at regular intervals a stack that is automatically filled by administrator actions with push update messages to be sent. The default interval between sending two batches of push update messages is

twelve hours. If this default value does not suit you, you can modify it by using the server environment variables *ibm.appcenter.push.schedule.period.amount* and *ibm.appcenter.push.schedule.period.unit*.

The value of *ibm.appcenter.push.schedule.period.amount* is an integer. The value of *ibm.appcenter.push.schedule.period.unit* can be seconds, minutes, or hours. If the unit is not specified, the amount is an interval that is expressed in hours. These variables are used to define the elapsed time between two batches of push messages.

Use JNDI properties to define these variables.

**Important:** In production, you should avoid setting the unit to seconds. The shorter the elapsed time, the higher the load on the server; the unit expressed in seconds is only implemented for testing and evaluation purposes. For example, when the elapsed time is set to 10 seconds, push messages are sent almost immediately.

See “List of JNDI properties for the Application Center” on page 6-223 for a complete list of properties that you can set.

### Example for Apache Tomcat server

Define these variables with JNDI properties in the `server.xml` file:

```
<Environment name="ibm.appcenter.push.schedule.period.unit" override="false" type="java.lang.String" value="hours"/>
<Environment name="ibm.appcenter.push.schedule.period.amount" override="false" type="java.lang.String" value="2"/>
```

For information about how to configure JNDI variables for WebSphere Application Server v8.5, see *Using resource environment providers in WebSphere Application Server*.

For information about how to configure JNDI variables for WebSphere Application Server Liberty profile, see *Using JNDI binding for constants from the server configuration files*.

The remaining actions for setting up the push notification service depend on the vendor of the device where the target application is installed. See the following topics.

### Configuring the Application Center server for connection to Apple Push Notification Services

Configure your iOS project for Apple Push Notification Services (APNs).

#### Before you begin

Ensure that the following servers are accessible from Application Center server.

##### Sandbox servers

- gateway.sandbox.push.apple.com:2195
- feedback.sandbox.push.apple.com:2196

##### Production servers

- gateway.push.apple.com:2195
- feedback.push.apple.com:2196

## About this task

You must be a registered Apple developer to successfully configure your iOS project with Apple Push Notification Services (APNs). In the company, the administrative role responsible for Apple development requests APNs enablement. The response to this request should provide you with an APNs-enabled provisioning profile for your iOS application bundle; that is, a stringed value that is defined in the configuration page of your Xcode project. This provisioning profile is used to generate a signature certificate file.

Two kinds of provisioning profile exist: development and production profiles, which address development and production environments respectively. Development profiles address Apple development APNs servers exclusively. Production profiles address Apple production APNs servers exclusively. These kinds of servers do not offer the same quality of service.

## Procedure

1. Obtain the APNs-enabled provisioning profile for the Application Center Xcode project. The result of your administrator's APNs enablement request is shown as a list accessible from <https://developer.apple.com/ios/my/bundles/index.action>. Each item in the list shows whether or not the profile has APNs capabilities. When you have the profile, you can download and install it in the Application Center client Xcode project directory by double-clicking the profile. The profile is then automatically installed in your keystore and Xcode project.
2. If you want to test or debug the Application Center on a device by launching it directly from XCode, in the "Xcode Organizer" window, go to the "Provisioning Profiles" section and install the profile on your mobile device.
3. Create a signature certificate used by the Application Center services to secure communication with the APNs server. This server will use the certificate for purposes of signing each and every push request to the APNs server. This signature certificate is produced from your provisioning profile.
  - a. Open the "Keychain Access" utility and click the **My Certificates** category in the left pane.
  - b. Find the certificate you want to install and disclose its contents. You see both a certificate and a private key; for the Application Center, the certificate line contains the Application Center application bundle `com.ibm.imf.AppCenter`.
  - c. Select **File > Export Items** to select both the certificate and the key and export them as a Personal Information Exchange (.p12) file. This .p12 file contains the private key required when the secure handshaking protocol is involved to communicate with the APNs server.
  - d. Copy the .p12 certificate to the computer responsible for running the Application Center services and install it in the appropriate place. Both the certificate file and its password are needed to create the secure tunneling with the APNs server. You also require some information that indicates whether a development certificate or a production certificate is in play. A development provisioning profile produces a development certificate and a production profile gives a production certificate. The Application Center services web application uses JNDI properties to reference this secure data. The examples in the table show how the JNDI properties are defined in the `server.xml` file of the Apache Tomcat server.

Table 11-111. JNDI properties

JNDI Property	Type and description	Example for Apache Tomcat server
<b>ibm.appcenter.apns.p12.certificate.location</b>	A string value that defines the full path to the .p12 certificate.	<code>&lt;Environment name="ibm.appcenter.apns.p12.certificate.location" override="false" type="java.lang.String" value="/Users/someUser/someDirectory/apache-tomcat/conf/AppCenter_apns_dev_cert.p12"/&gt;</code>
<b>ibm.appcenter.apns.p12.certificate.password</b>	A string value that defines the password needed to access the certificate.	<code>&lt;Environment name="ibm.appcenter.apns.p12.certificate.password" override="false" type="java.lang.String" value="this_is_a_secure_password"/&gt;</code>
<b>ibm.appcenter.apns.p12.certificate.isDevelopmentCertificate</b>	A boolean value (identified as true or false) that defines whether or not the provisioning profile used to generate the authentication certificate was a development certificate.	<code>&lt;Environment name="ibm.appcenter.apns.p12.certificate.isDevelopmentCertificate" override="false" type="java.lang.String" value="true"/&gt;</code>

See “List of JNDI properties for the Application Center” on page 6-223 for a complete list of JNDI properties that you can set.

## The Application Center console

With the Application Center console, you can manage the repository of the Application Center and your applications.

The Application Center console is a web application to manage the repository of the Application Center. The Application Center repository is the central location where you store the mobile applications that can be installed on mobile devices.

Use the Application Center console to:

- Upload applications written for iOS.
- Manage several different versions of mobile applications.
- Review the feedback of testers of mobile applications.
- Define the users who have the rights to list and install an application on the mobile devices.
- Track which applications are installed on which devices.

### Note:

Only users with the administrator role can log in to the Application Center console.

Multicultural support: the user interface of the Application Center console has not been translated.

## Starting the Application Center console

You can start the Application Center with your web browser and log in if you have the administrator role.

### Procedure

1. Start a web browser session on your desktop.

2. Contact your system administrator to obtain the address and port of the server where the Application Center is installed.
3. Enter the following URL: `http://server/appcenterconsole`  
Where *server* is the address and port of the server where the Application Center is installed.  
`http://localhost:9080/appcenterconsole`
4. Log in to the Application Center console  
Contact your system administrator to get your credentials so that you can log in to the Application Center console.



Figure 11-10. Login of the Application Center console

**Note:**

Only users with the administrator role can log in to the Application Center console.

**Troubleshooting a corrupt login page (Apache Tomcat)**

You can recover from a corrupt login page of the Application Center console when the Application Center is running in Apache Tomcat.

**Symptom**

When the Application Center is running in Apache Tomcat, the use of a wrong user name or password might corrupt the login page of the Application Center console.

When you try to log in to the console with an incorrect user name or an incorrect password, you receive an error message. When you correct the user name or password, instead of a successful login, you have one of the following errors; the message depends on your web browser.

- The same error message as before
- The message “The connection was reset”
- The message “The time allowed for login exceeded”

### **Cause**

The behavior is linked to the management by Apache Tomcat of the `j_security_check` servlet. This behavior is specific to Apache Tomcat and does not occur in any of the WebSphere Application Server profiles.

### **Solution**

The workaround is to click the refresh button of the browser to refresh the web page after a login failure. Then, enter the correct credentials.

### **Troubleshooting a corrupted login page in Safari browsers**

You can recover from a corrupted login page of the Application Center console when you use the Safari browser.

### **Symptom**

When the Application Center console is open in a Safari browser, you might navigate away from the console. When you come back to the console, you might see the login page. Even though you enter the correct login details, you see the following message instead of a successful login:

HTTP Status 404 - appcenterconsole/j\_security\_check.

### **Cause**

The behavior is linked to a caching problem in the Safari browser.

### **Solution**

The workaround is to trigger a forced reload when you see the login page without entered or autocompleted credentials. Here is how to trigger a forced reload:

- On a Mac computer, press Shift + the **Refresh** button.
- On an iPad or iPhone device: Double-click the refresh button or clean the cache by closing Safari: you double-click the home button and then swipe Safari away.

### **Application Management**

You can use Application Management to add new applications and versions and to manage those applications.

The Application Center enables you to add new applications and versions and to manage those applications.

Click **Applications** to access Application Management.

## Application Center installed on WebSphere Application Server Liberty profile or on Apache Tomcat

Installations of the Application Center on these application servers, during installation of IBM MobileFirst Platform Foundation for iOS with the IBM Installation Manager package, have two different users defined that you can use to get started.

- User with login demo and password demo
- User with login appcenteradmin and password admin

## WebSphere Application Server full profile

If you installed the Application Center on WebSphere Application Server full profile, one user named appcenteradmin is created by default with the password indicated by the installer.

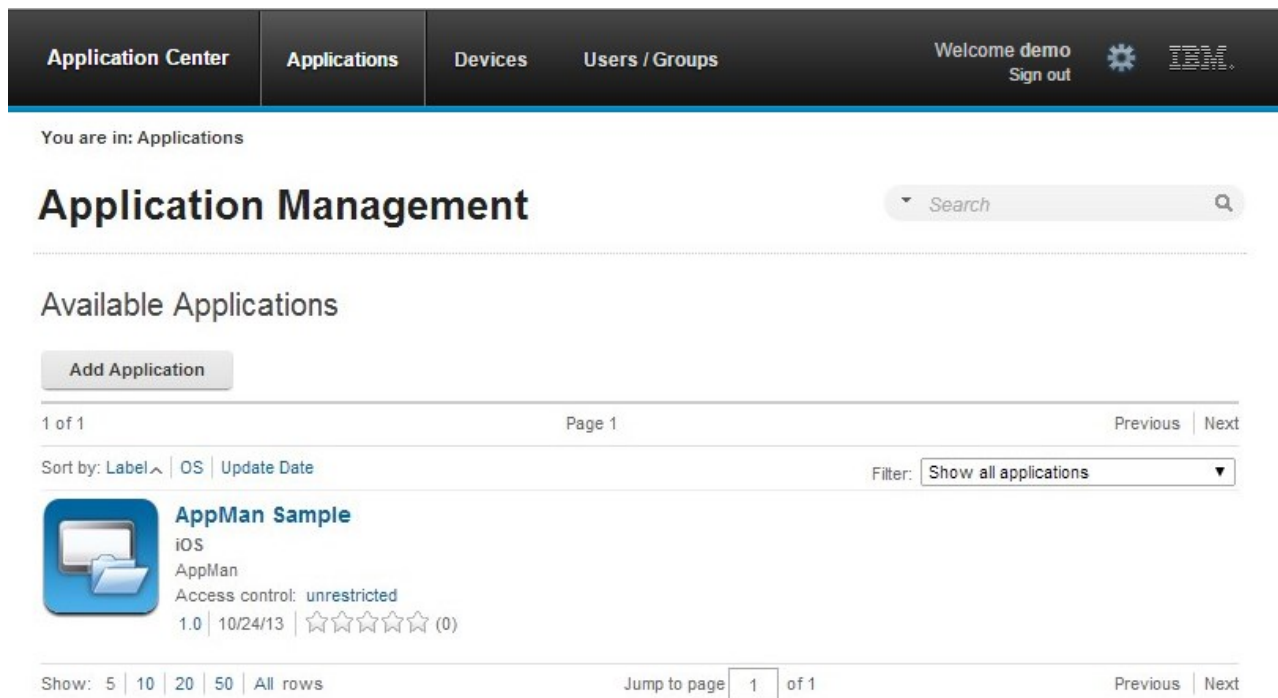

The screenshot shows the Application Center console interface. At the top, there is a navigation bar with tabs for 'Application Center', 'Applications', 'Devices', and 'Users / Groups'. The 'Applications' tab is selected. On the right side of the navigation bar, it says 'Welcome demo' and 'Sign out' with a gear icon and the IBM logo. Below the navigation bar, it says 'You are in: Applications'. The main heading is 'Application Management' with a search bar on the right. Below the heading, there is a section for 'Available Applications' with an 'Add Application' button. A table shows one application: 'AppMan Sample' for iOS. The application details include 'AppMan', 'Access control: unrestricted', version '1.0', and date '10/24/13'. There are five star icons and '(0)' next to them. At the bottom, there is a pagination bar showing '1 of 1', 'Page 1', 'Previous', and 'Next' buttons. The 'Show' dropdown is set to '5', and the 'Filter' dropdown is set to 'Show all applications'.

Figure 11-11. Available applications

### Adding a mobile application

Add applications to the repository on the server by using the Application Center console. These applications can then be installed on mobile devices by using the mobile client.

### About this task

In the Applications view, you can add applications to Application Center. Initially the list of applications is empty and you must upload an application file. Application files are described in this procedure.

## Procedure

To add an application to make it available to be installed on mobile devices:

1. Click **Add Application**.
2. Click **Upload**.
3. Select the application file to upload to the Application Center repository.

### iOS

The application file extension is `ipa` for normal iOS applications.

The application file extension is `zip` for instrumented iOS applications for use in IBM MobileFirst Platform Test Workbench.

4. Click **Next** to access the properties to complete the definition of the application.
5. Complete the properties to define the application. See [Application properties](#) for information about how to complete property values.
6. Click **Finish**.



Application Center
Applications
Devices
Users / Groups
Welcome demo  
Sign out

You are in: Applications > Add an application

## Application Management

### Add an application

---

#### Application Details

Package, Version and Label must be set in the uploaded application package and cannot be modified afterwards.

Package:	<b>AppMan</b> <small>Identifies the application</small>
Internal Version:	<b>1.0</b> <small>Internal version number used to compare versions</small>
Commercial Version:	<i>No value set</i> <small>Version displayed on the mobile device</small>
* Label:	<input type="text" value="AppMan Sample"/> <small>Label of the application as defined by the developer</small>
External URL:	<b>ibmappctr://show-app?id=AppMan</b> <small>URL to open the Application Center mobile client on this application.</small>
Author:	<b>demo</b> <small>User who has uploaded this application</small>
Description:	<input type="text"/> <small>(2048 characters maximum)</small>
Minimal OS Version:	<b>3.1</b> <small>The application runs on devices with OS at least this version</small>
Device Family:	<b>iphone</b> <small>The application runs on devices from this device family</small>
Recommended:	<input type="checkbox"/> <small>This application will be listed as a recommended application on the mobile device</small>
Installer:	<input type="checkbox"/> <small>Indicates whether this application is an installer</small>
Active:	<input checked="" type="checkbox"/> <small>An active application can be installed on a device</small>
Ready for production:	<input type="checkbox"/> <small>Indicates whether this application is ready for production</small>
Instrumented	<b>No</b> <small>Indicates whether this application is instrumented for IBM MobileFirst Platform Test Workbench</small>

Figure 11-12. Application properties, adding an application

## Adding an application from a public app store

Application Center supports adding to the catalog applications that are stored in third-party application stores, such as Google play or Apple iTunes.

### About this task

Applications from third-party app stores appear in the Application Center catalog like any other application, but users are directed to the corresponding public app store to install the application. You add an application from a public app store in the console, in the same place as you add an application created within your own enterprise. See “Adding a mobile application” on page 11-79.

Instead of providing the application executable, you must provide a URL to the third party application store where the application is stored. To make it easy to find the correct application link, the console provides direct links in the “Add an application” page to the supported third-party application store web sites.

The Apple iTunes store address is <https://linkmaker.itunes.apple.com/>; use the linkmaker site rather than the iTunes site, because you can search this site for all kinds of iTunes items, including songs, podcasts, and other items supported by Apple. Only selecting iOS applications provides you with compatible links to create application links.

### Procedure

1. Click the URL of the public app store that you want to browse.
2. Copy the URL of the application in the third-party app store to the Application URL text field in the “Add an application” page of the Application Center console.

- **Apple iTunes:**

- a. When the list of items is returned in the search result, select the item that you want.
- b. At the bottom of the selected application, click “Direct Link” to open the application details page.

**Note:** Do not copy the “Direct Link” to the Application Center. “Direct Link” is a URL with redirection, you will need to get the URL it redirects to.

- c. Copy the address bar URL.
3. When the application link is in the Application URL text field of the console, click **Next** to validate the creation of the application link. If the validation is successful, this action will display the application properties.

If the validation is unsuccessful, an error message will be displayed in the “Add an application” page. You can either try another link or cancel the attempt to create the current link.

If the validation of the application link is successful, you can modify the application description in the application properties before performing the next step.

4. Click **Done** to create the application link. This action makes the application available to the corresponding version of the Application Center mobile client. A small link icon appears on the application icon to show that this application is stored in a public app store and is different from a binary app.

### Related concepts:

Configuring WebSphere Application Server to support applications in public app stores

Configure WebSphere Application Server full profile and Liberty profile before access to public app stores through application links, because of the use of SSL connections.

### Related tasks:

Configuring WebSphere Application Server to support applications in Apple iTunes  
Configure WebSphere Application Server to enable links in the Application Center console to access applications in Apple iTunes.

“Installing applications through public app stores” on page 11-114

You can link from the mobile client to applications that are stored in supported public app stores and install these applications on your compatible device by

following the normal procedure of the public app store.

## Application properties

Applications have their own sets of properties that depend on the operating system on the mobile device and that cannot be edited. Applications also have a common property and editable properties.

The values of the following fields are taken from the application and you cannot edit them.

- **Package.**
- **Internal Version.**
- **Commercial Version.**
- **Label.**
- **External URL**

## Properties of iOS applications

- **Package** is the company identifier and the product name; **CFBundleIdentifier** key. See the iOS SDK documentation.
- **Internal Version** is the build number of the application; **CFBundleVersion** key of the application. See the iOS SDK documentation.
- **Commercial Version** is the published version of the application.
- **Label** is the label of the application; **CFBundleDisplayName** key of the application. See the iOS SDK documentation.
- **Instrumented** indicates whether the uploaded application is an instrumented application for use in IBM Mobile Test Workbench for IBM MobileFirst Platform Foundation for iOS or a normal iOS application.
- **External URL** is a URL that enables you to have the mobile client of the Application Center launched automatically in the Details view of the latest version of the current application.

## Common property

### Author

The **Author** field is read only. It displays the user name of the user who uploads the application.

## Editable properties

You can edit the following fields:

### Description

Use this field to describe the application to the mobile user.

### Recommended

Select **Recommended** to indicate that you recommend users to install this application. Recommended applications appear in a special list of recommended applications in the mobile client.

### Installer

For the Administrator only: This property indicates that the application is used to install other applications on the mobile device and send feedback on an application from the mobile device to the Application Center. Usually only one application is qualified as **Installer** and is called the mobile client. This application is documented in “The mobile client” on page 11-105.

### **Active**

Select **Active** to indicate that an application can be installed on a mobile device. If you do not select **Active**, the mobile user will not see the application in the list of available applications displayed on the device.

If you do not select **Active**, the application is inactive. In the list of available applications in Application Management, if **Show inactive** is selected, the application is disabled.

If **Show inactive** is not selected, the application does not appear in the list of available applications.

### **Ready for production**

Select **Ready for production** to indicate that an application can be managed by the application store of Tivoli® Endpoint Manager. Applications with this property selected are the only ones that are flagged to Tivoli Endpoint Manager. The property **Ready for production** indicates that an application is ready to be deployed in a production environment and is therefore suitable to be managed by Tivoli Endpoint Manager through its application store.

## **Editing application properties**

You can edit the properties of an application in the list of uploaded applications.

### **Procedure**

To edit the properties of an uploaded application:

1. Select **Applications** to see the list of uploaded applications: Available Applications.
2. Click the version of the application to edit the properties: Application Details.
3. Edit any of the editable properties that you want. See “Application properties” on page 11-83 for details about these properties. The name of the current application file is shown below the properties.

Important: If you want to update the file, it must belong to the same package and be the same version number. If either of these properties is not the same you must go back to the application list and add the new version first.

4. Click **OK** to save your changes and return to Available Applications or **Apply** to save and keep Application Details open.

You are in: Applications > Application properties



# AppMan Sample (iOS)

## Version 1.0

- Properties
- Reviews

### Edit application properties

#### Application Details

Package, Version and Label must be set in the uploaded application package and cannot be modified afterwards.

Package:	AppMan <small>Identifies the application</small>
Internal Version:	1.0 <small>Internal version number used to compare versions</small>
Commercial Version:	<i>No value set</i> <small>Version displayed on the mobile device</small>
* Label:	<input type="text" value="AppMan Sample"/> <small>Label of the application as defined by the developer</small>
External URL:	ibmappctr://show-app?id=AppMan <small>URL to open the Application Center mobile client on this application.</small>
Author:	demo <small>User who has uploaded this application</small>
Description:	<input type="text"/> <small>(2048 characters maximum)</small>
Minimal OS Version:	3.1 <small>The application runs on devices with OS at least this version</small>
Device Family:	iphone <small>The application runs on devices from this device family</small>
Recommended:	<input type="checkbox"/> <small>This application will be listed as a recommended application on the mobile device</small>
Installer:	<input type="checkbox"/> <small>Indicates whether this application is an installer</small>
Active:	<input checked="" type="checkbox"/> <small>An active application can be installed on a device</small>
Ready for production:	<input type="checkbox"/> <small>Indicates whether this application is ready for production</small>
Instrumented	No <small>Indicates whether this application is instrumented for IBM Mobile Test Workbench for Worklight</small>

#### Application File

Define an application file with an ipa extension for an iOS application to update the application.

Current:	appman.ipa
New file:	<input type="text"/> <input type="button" value="Upload..."/>

Figure 11-13. Application properties for editing

## Upgrading a mobile application in MobileFirst Server and the Application Center

You can easily upgrade deployed mobile applications by using a combination of MobileFirst Operations Console and the Application Center.

### Before you begin

The mobile client of the Application Center must be installed on the mobile device. The HelloWorld application must be installed on the mobile device and must connect to MobileFirst Server when the application is running.

### About this task

You can use this procedure to update iOS applications that have been deployed on MobileFirst Server and also in the Application Center. In this task, the application HelloWorld version 1.0 is already deployed on MobileFirst Server and in the Application Center.

### Procedure

HelloWorld version 2.0 is released and you would like users of version 1.0 to upgrade to the later version. To deploy the new version of the application:

1. Deploy HelloWorld 2.0 in the Application Center. See “Adding a mobile application” on page 11-79.
2. From the Application Details page, copy the setting of the external URL.

### Application Details

Package, Version and Label must be set in the uploaded application package and cannot be modified afterwards.

Package:	com.HelloWorld
	Identifies the application
Internal Version:	2
	Internal version number used to compare versions
Commercial Version:	2.0
	Version displayed on the mobile device
* Label:	<input type="text" value="HelloWorld"/>
	Label of the application as defined by the developer
External URL:	<input type="text" value="ibmappctr://show-app?id=com.HelloWorld"/>
	URL to open the Application Center mobile client on this application.

Figure 11-14. Copying the external URL from Application Details

3. When the external URL is copied to the clipboard, open the MobileFirst Operations Console.
4. Change the access rule of HelloWorld version 1.0 to “Access Disabled”.
5. Paste the external URL into the URL field.

Running the client: When a mobile device connects to MobileFirst Server to try to run HelloWorld version 1.0, the device user is requested to upgrade the version of

the application.

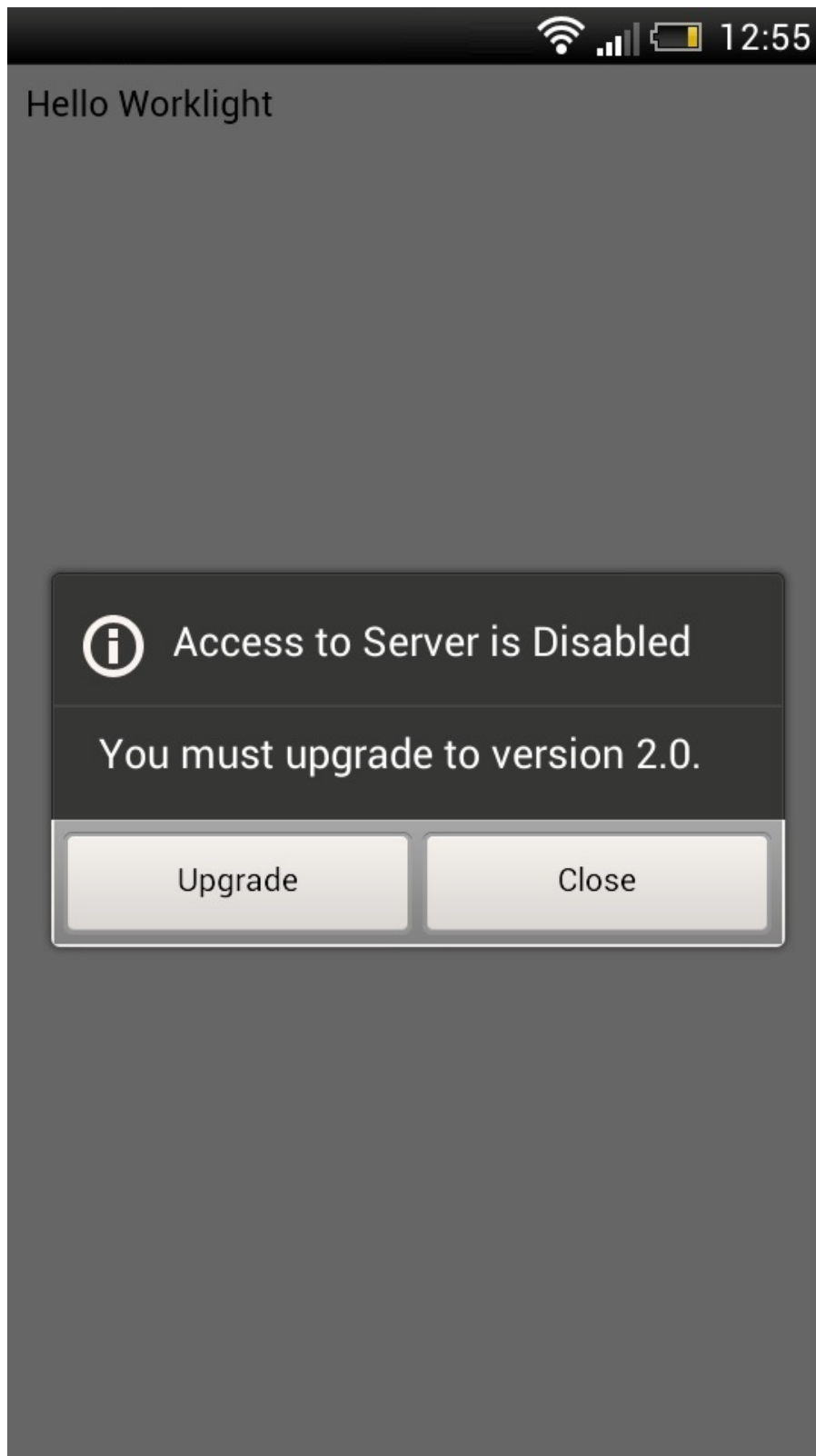

*Figure 11-15. Remotely disabling an old version of an application*

6. Click **Upgrade** to open the Application Center client. When the login details are correctly completed, you access the Details page of HelloWorld version 2.0 directly.



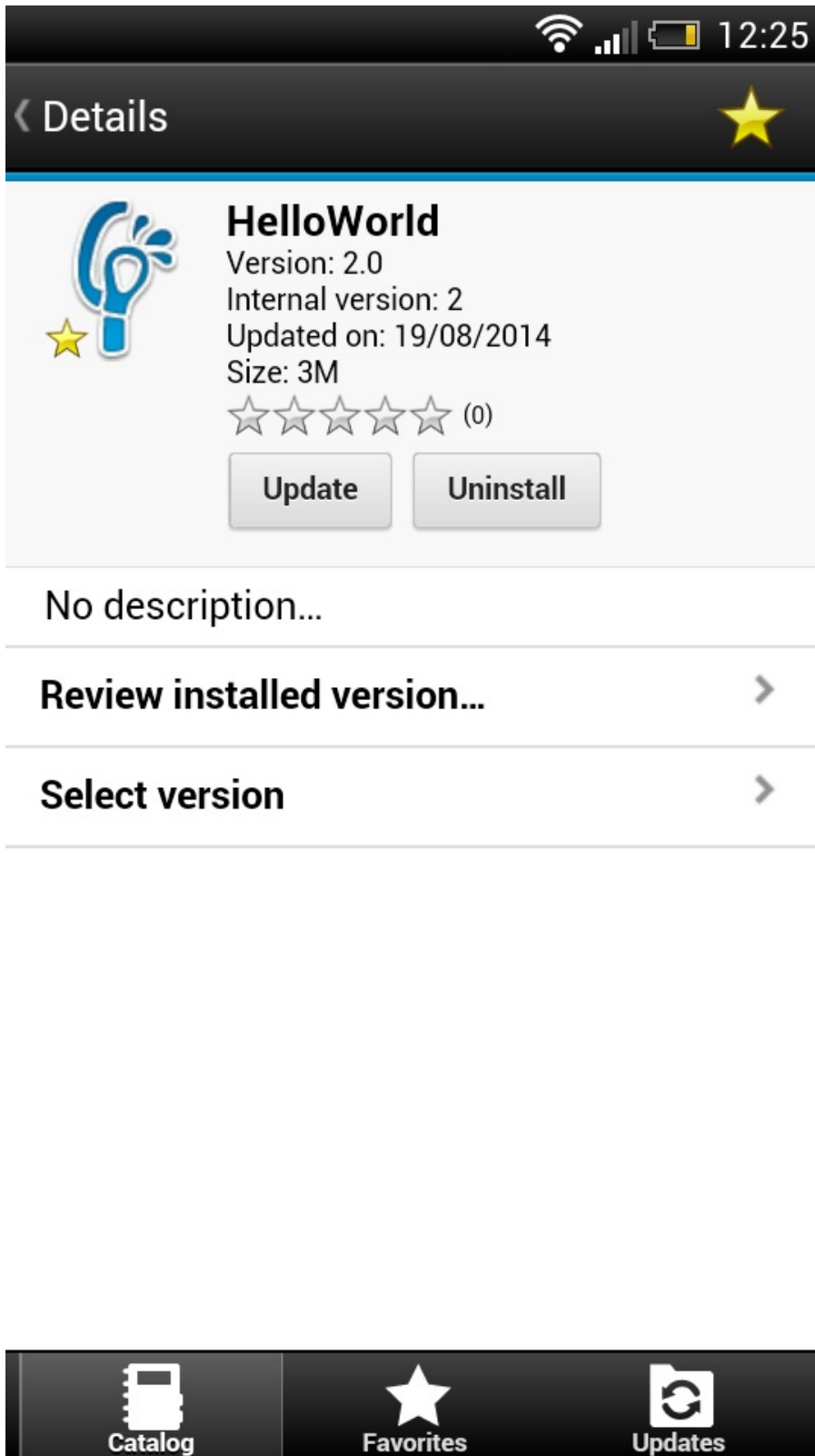

Figure 11-16. Details of HelloWorld 2.0 in the Application Center client

## Downloading an application file

You can download the file of an application registered in the Application Center.

### Procedure

1. Select **Applications** to see the list of uploaded applications: **Available Applications**.
2. Tap the version of the application under **Application Details**.
3. Tap the file name in the "Application File" section.

## Viewing application reviews

In the Application Center console, you can see reviews about mobile application versions sent by users.

### About this task

Users of mobile applications can write a review, which includes a rating and a comment, and submit the review through the Application Center client. Reviews are available in the Application Center console and the client. Individual reviews are always associated with a particular version of an application.

### Procedure

To view reviews from mobile users or testers about an application version:

1. Select **Applications** to see the list of uploaded applications: Available Applications.
2. Select the version of the application.
3. In the menu, select **Reviews**.

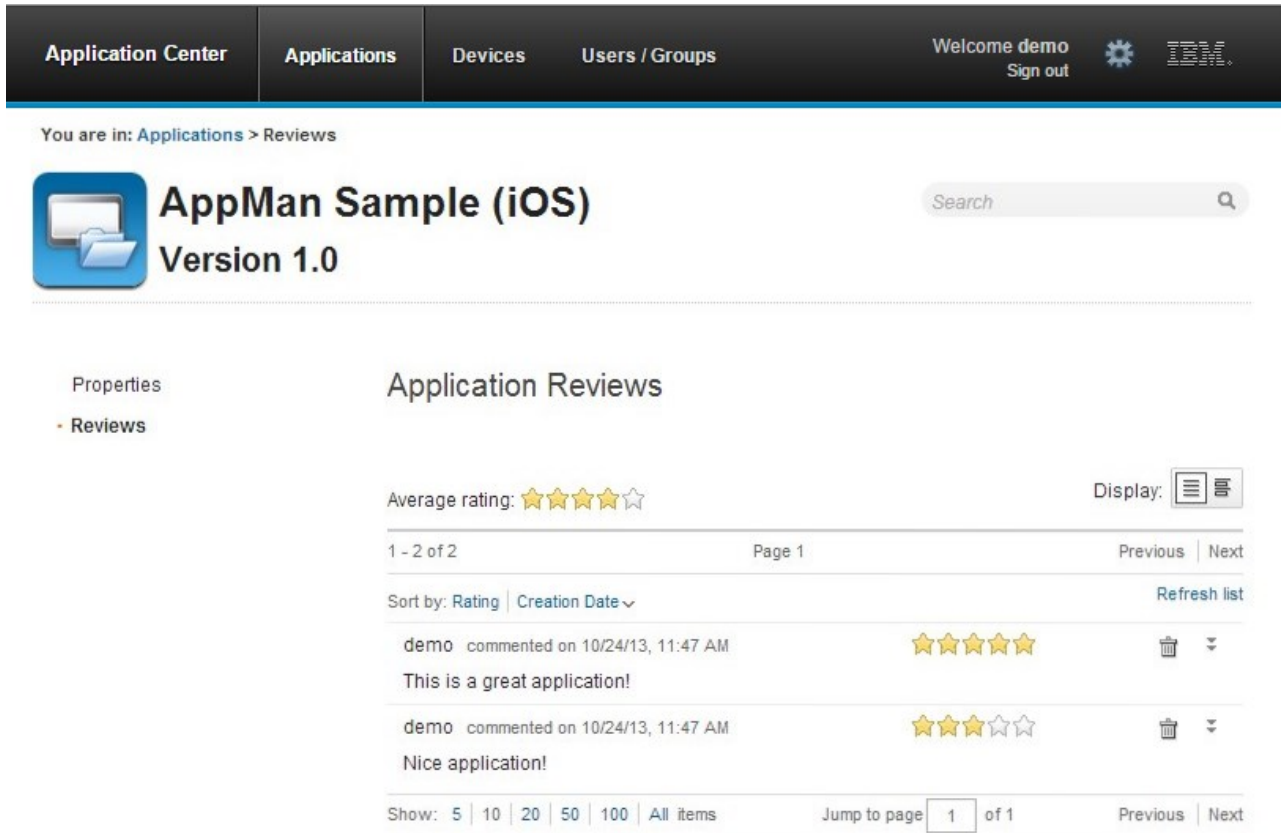



Figure 11-17. Reviews of application versions

The rating is an average of the ratings in all recorded reviews. It consists of one to five stars, where one star represents the lowest level of appreciation and five stars represent the highest level of appreciation. The client cannot send a zero star rating.

The average rating gives an indication of how the application satisfies the intended use of the application.

4. Click the two arrow heads  on the right to expand the comment that is part of the review and to view the details of the mobile device where the review is generated.

For example, the comment can give the reason for submitting the review, such as failure to install.

If you want to delete the review, click the trash can on the right.

## User and group management

You can use users and groups to define who has access to some features of the Application Center, such as installing applications on mobile devices.

### Purpose

Use users and groups in the definition of access control lists (ACL).

### Managing registered users

To manage registered users, click the **Users/Groups** tab and select **Registered users**. You obtain a list of registered users of the Application Center that includes:

- Mobile client users
- Console users
- Local group members
- Members of an access control list

The screenshot displays the 'User and Group Management' interface. At the top, there is a navigation bar with tabs for 'Application Center', 'Applications', 'Devices', and 'Users / Groups'. The 'Users / Groups' tab is active. To the right of the navigation bar, there is a welcome message 'Welcome demo' and a 'Sign out' button. Below the navigation bar, there is a breadcrumb 'You are in: Users/Groups > Users'. The main content area is titled 'User and Group Management' and contains a search bar. Below the search bar, there is a sidebar with 'User Groups' and 'Registered Users'. The 'Registered Users' section shows a list of users with a 'demo' user visible. There are buttons for 'Register user...', 'Previous', and 'Next', and a pagination control showing '1 of 1'.

Figure 11-18. List of registered users of the Application Center

If the Application Center is connected to an LDAP repository, you cannot edit the user display names. If the repository is not LDAP, you can change a user display name by selecting it and editing it.

To register new users, click **Register User**, enter the login name and the display name, and click **OK**.

To unregister a user, click the trash icon next to the user name.

Unregistering a user from the Application Center has the effect of:

- Removing feedback given by the user
- Removing the user from the access control lists
- Removing the user from local groups

**Note:**

When you unregister a user, the user is not removed from the application server or the LDAP repository.

**Managing local groups**

To manage local groups, click the **Users/Groups** tab and select **User group**.

To create a local group, click **Create group**. Enter the name of the new group and click **OK**.

If the Application Center is connected to an LDAP repository, the search includes local groups as well as the groups defined in the LDAP repository. If the repository is not LDAP, only local groups are available to the search.

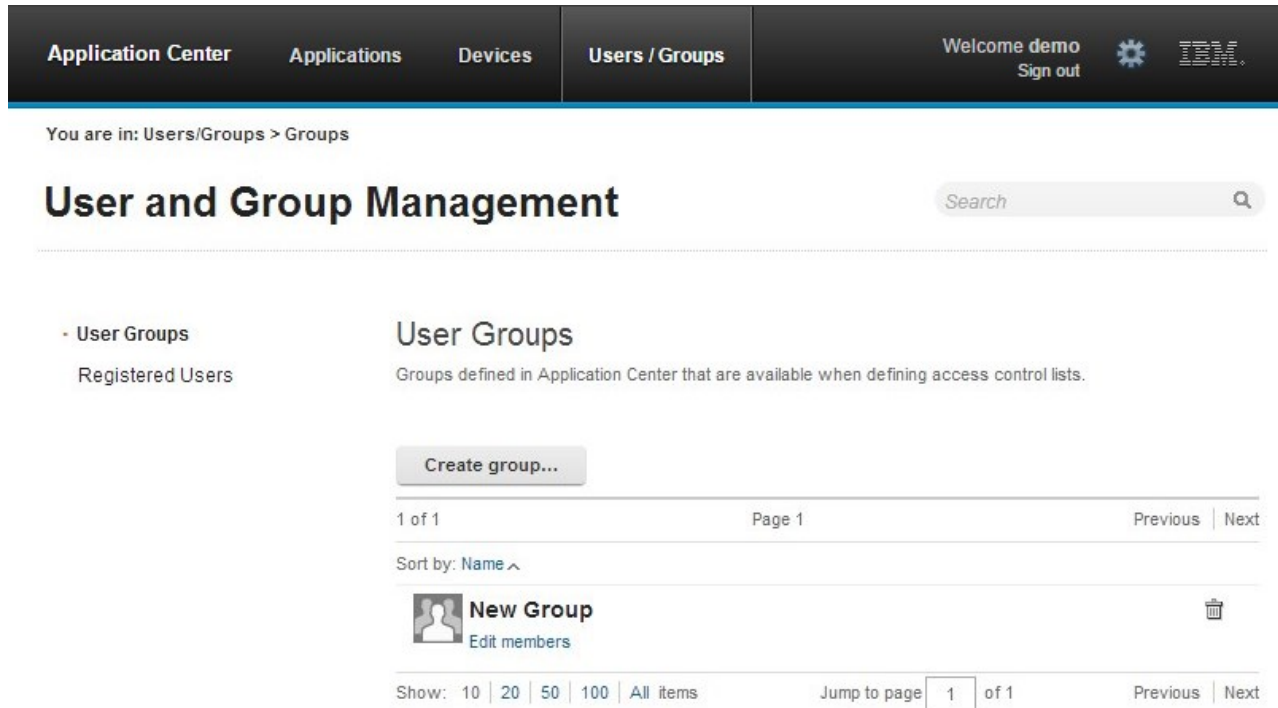

Figure 11-19. Local user groups

To delete a group, click the trash icon next to the group name. The group is also removed from the access control lists.

To add or remove members of a group, click the **Edit members** link of the group.

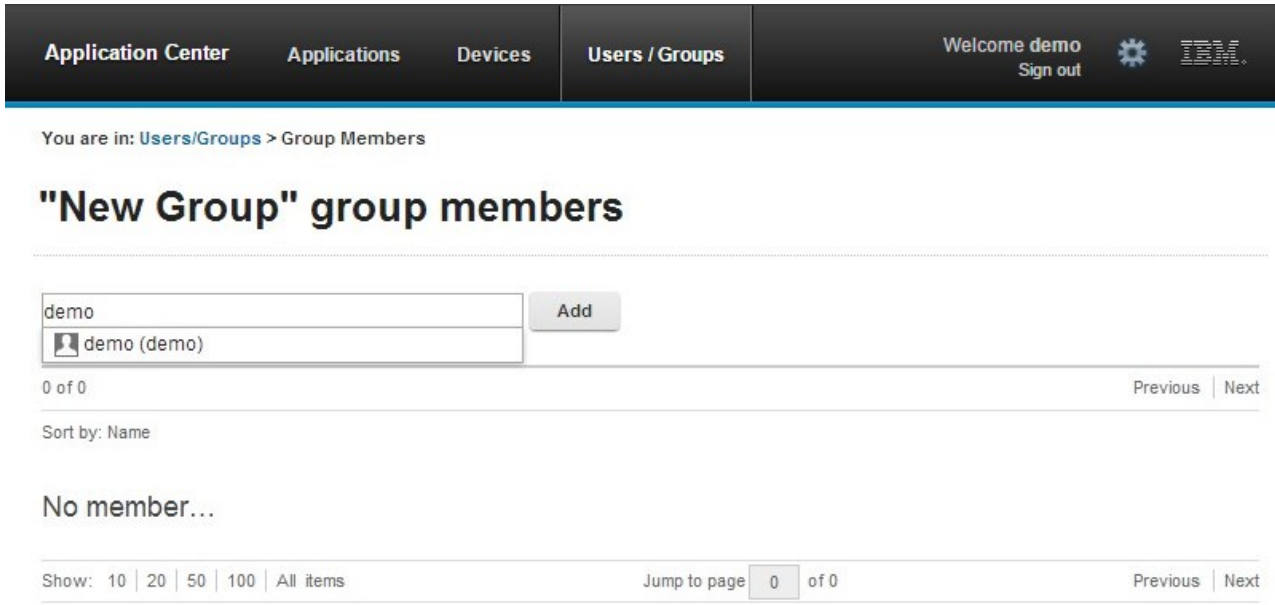

Figure 11-20. Managing group membership

To add a new member, search for the user by entering the user display name, select the user, and click **Add**.

If the Application Center is connected to an LDAP repository, the search for the user is performed in the LDAP repository. If the repository is not LDAP, the search is performed in the list of registered users.

To remove a member from a group, click the cross on the right of the user name.

### Access control

You can decide whether installation of an application on mobile devices is open to any users or whether you want to restrict the ability to install an application.

Installation of applications on a mobile device can be limited to specific users or available to any users.

Access control is defined at the application level and not at the version level.

By default, after an application is uploaded, any user has the right to install the application on a mobile device.

The current access control for an application is displayed in Available Applications for each application. The unrestricted or restricted access status for installation is shown as a link to the page for editing access control.

Installation rights are only about the installation of the application on the mobile device. If access control is not enabled, everybody has access to the application.

### Managing access control

You can add or remove access for users or groups to install an application on mobile devices.

## Procedure

You can edit access control:

1. In Application Management under Available Applications, click the **unrestricted** or **restricted** state of Installation of an application.



2. Select **Access control enabled** to enable access control.
3. Add users or groups to the access list.

To add a single user or group, enter a name, select the entry in the matching entries found, and click **Add**.

If the Application Center is connected to an LDAP repository, you can search for users and groups in the repository as well as locally defined groups. If the repository is not LDAP, you can search only local groups and registered users. Local groups are exclusively defined in the **Users/Groups** tab. When you use the Liberty profile federated registry, you can only search for users by using the login name; the result is limited to a maximum of 15 users and 15 groups (instead of 50 users and 50 groups).

To register a user at the same time as you add the user to the access list, enter the name and click **Add**. Then you must specify the login name and the display name of the user.

To add all the users of an application, click **Add users from application** and select the appropriate application.

You are in: Applications > Access control list



## AppMan Sample (iOS)

### Installation Access Control

The users with permission to install this application on their devices.

Access control enabled

Add

Import access control from application...

Select an existing user or register a new one.

1 of 1

Page 1

Previous | Next

Sort by: Name ^



demo

demo

Show: 10 | 20 | 50 | 100 | All items

Jump to page 1 of 1

Previous | Next

Figure 11-21. Adding users to the access list



To remove access from a user or group, click the cross on the right of the name.

### Device Management

You can see the devices that connected to the Application Center from the Application Center mobile client and their properties.

**Device Management** shows under the **Registered Devices** the list of devices that have connected to the Application Center at least once from the Application Center mobile client.



Application Center   Applications   **Devices**   Users / Groups   Welcome demo   Sign out    

You are in: Devices

## Device Management

Registered Devices

1 of 1   Page 1   Previous   Next

Sort by: User Name | Device Name ^ | OS | Manufacturer | Model | Update Date

	<b>Demo's phone</b>	demo	Apple iPhone 5S	7.0	Updated on 10/24/13
-----------------------------------------------------------------------------------	---------------------	------	-----------------	-----	---------------------

Show: 5 | 10 | 20 | 50 | All items   Jump to page  of 1   Previous   Next

Figure 11-22. The device list

### Device properties

Click a device in the list of devices to view the properties of the device or the applications installed on that device.

You are in: [Devices](#) > Properties



## Demo's phone

· Properties

Installed Applications

### Device Properties

* Name:	<input type="text" value="Demo's phone"/>
	<small>Name of the device</small>
Owner Name:	demo
Manufacturer:	Apple
Model:	iPhone 5S
Operating System:	iOS
Family:	iphone
Unique Identifier:	myDeviceId

Figure 11-23. Device properties

Select **Properties** to view the device properties.

#### Name

The name of the device. You can edit this property.

**Note:** on iOS, the user can define this name in the settings of the device in **Settings > General > Information > Name**. The same name is displayed on iTunes.

#### User Name

The name of the first user who logged into the device.

#### Manufacturer

The manufacturer of the device.

#### Model

The model identifier.

#### Operating System

The operating system of the mobile device.

### Unique identifier

The unique identifier of the mobile device.

If you edit the device name, click **OK** to save the name and return to Registered Devices or **Apply** to save and keep Edit Device Properties open.

### Applications installed on device

Select **Applications installed on device** to list all the applications installed on the device.

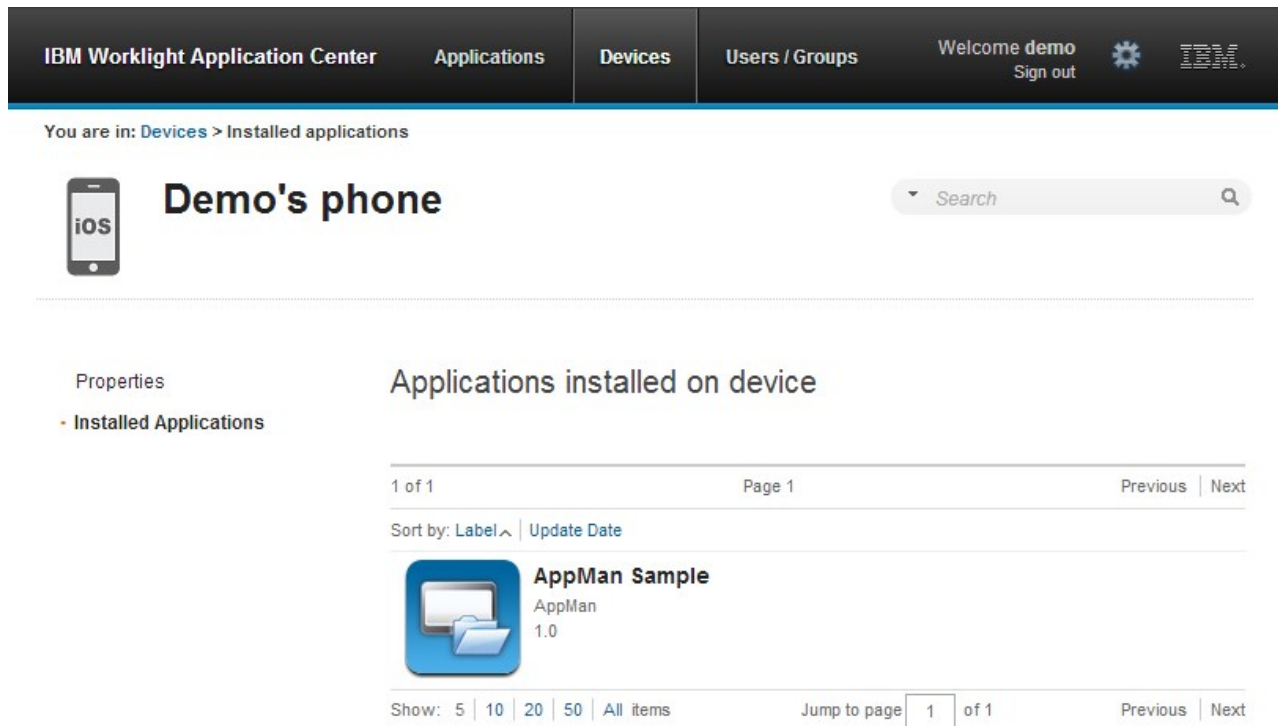

The screenshot shows the IBM Worklight Application Center interface. At the top, there is a navigation bar with tabs for 'Applications', 'Devices', and 'Users / Groups'. The 'Devices' tab is active. The user is logged in as 'demo' and can sign out. Below the navigation bar, the breadcrumb 'You are in: Devices > Installed applications' is visible. The main content area is titled 'Demo's phone' and shows a list of installed applications. The application 'AppMan Sample' is listed with a version of 1.0. The interface includes search, sorting, and pagination options.

Figure 11-24. Applications installed on a device

### Signing out of the Application Center console

For security purposes, you must sign out of the console when you have finished your administrative tasks.

#### Purpose

To log out of the secure sign-on to the Application Center console..

To sign out of the Application Center console, click **Sign out** next to the Welcome message that is displayed in the banner of every page.

### Command-line tool for uploading or deleting an application

To deploy applications to the Application Center through a build process, use the command-line tool.

You can upload an application to the Application Center by using the web interface of the Application Center console. You can also upload a new application by using a command-line tool.

This is particularly useful when you want to incorporate the deployment of an application to the Application Center into a build process. This tool is located at:

*installDir/ApplicationCenter/tools/applicationcenterdeploytool.jar*

The tool can be used for application files with extension IPA. It can be used stand alone or as an ant task.

The tools directory contains all the files required to support the use of the tool.

- *applicationcenterdeploytool.jar*: the upload tool.
- *json4j.jar*: the library for the JSON format required by the upload tool.
- *build.xml*: a sample ant script that you can use to upload a single file or a sequence of files to the Application Center.
- *acdeploytool.sh* and *acdeploytool.bat*: Simple scripts to call java with *applicationcenterdeploytool.jar*.

## Using the stand-alone tool to upload an application

To upload an application, call the stand-alone tool from the command line.

### Procedure

Use the stand-alone tool by following these steps.

1. Add *applicationcenterdeploytool.jar* and *json4j.jar* to the java classpath environment variable.
2. Call the upload tool from the command line:  

```
java com.ibm.appcenter.Upload [options] [files]
```

You can pass any of the available options in the command line.

Option	Content indicated by	Description
-s	<b>serverpath</b>	The path to the Application Center server.
-c	<b>context</b>	The context of the Application Center web application.
-u	<b>user</b>	The user credentials to access the Application Center.
-p	<b>password</b>	The password of the user.
-d	<b>description</b>	The description of the application to be uploaded.
-l	<b>label</b>	The fallback label. Normally the label is taken from the application descriptor stored in the file to be uploaded. If the application descriptor does not contain a label, the fallback label is used.
-isActive	true or false	The application is stored in the Application Center as an active or inactive application.

Option	Content indicated by	Description
-isInstaller	true or false	The application is stored in the Application Center with the "installer" flag set appropriately.
-isReadyForProduction	true or false	The application is stored in the Application Center with the "ready-for-production" flag set appropriately.
-isRecommended	true or false	The application is stored in the Application Center with the "recommended" flag set appropriately.
-e		Shows the full exception stack trace on failure.
-f		Force uploading of applications, even if they exist already.
-y		Disable SSL security checking, which allows publishing on secured hosts without verification of the SSL certificate. Use of this flag is a security risk, but may be suitable for testing localhost with temporary self-signed SSL certificates.

The **files** parameter can specify files of type iOS application (.ipa) files.

In this example user demo has the password demopassword. Use this command line.

```
java com.ibm.appcenter.Upload -s http://localhost:9080 -c applicationcenter -u demo -p demopassword -f app1.ipa app2.ipa
```

## Using the stand-alone tool to delete an application

To delete an application from the Application Center, call the stand-alone tool from the command line.

### Procedure

Use the stand-alone tool by following these steps.

1. Add applicationcenterdeploytool.jar and json4j.jar to the java *classpath* environment variable.
2. Call the upload tool from the command line:

```
java com.ibm.appcenter.Upload -delete [options] [files or applications]
```

You can pass any of the available options in the command line.

Option	Content indicated by	Description
-s	<b>serverpath</b>	The path to the Application Center server.
-c	<b>context</b>	The context of the Application Center web application.

Option	Content indicated by	Description
-u	<b>user</b>	The user credentials to access the Application Center.
-p	<b>password</b>	The password of the user.
-y		Disable SSL security checking, which allows publishing on secured hosts without verification of the SSL certificate. Use of this flag is a security risk, but may be suitable for testing localhost with temporary self-signed SSL certificates.

You can specify files or the application package, operating system, and version. If files are specified, the package, operating system and version are determined from the file and the corresponding application is deleted from the Application Center. If applications are specified, they must have one of the following formats:

package@os@version: This exact version is deleted from the Application Center. The version part must specify the “internal version”, not the “commercial version” of the application.

package@os: All versions of this application are deleted from the Application Center.

package: All versions of all operating systems of this application are deleted from the Application Center.

### Example

In this example, user **demo** has the password **demopassword**. Use this command line to delete the iOS application demo.HelloWorld with internal version 3.0.

```
java com.ibm.appcenter.Upload -delete -s http://localhost:9080 -c applicationcenter -u demo -p demopassword demo.HelloWorld@iOS@3.0
```

### Using the stand-alone tool to clear the LDAP cache

Use the stand-alone tool to clear the LDAP cache and make changes to LDAP users and groups visible immediately in the Application Center.

### About this task

When the Application Center is configured with LDAP, changes to users and groups on the LDAP server become visible to the Application Center after a delay. The Application Center maintains a cache of LDAP data and the changes only become visible after the cache expires. By default, the delay is 24 hours. If you do not want to wait for this delay to expire after changes to users or groups, you can call the stand-alone tool from the command line to clear the cache of LDAP data. By using the stand-alone tool to clear the cache, the changes become visible immediately.

### Procedure

Use the stand-alone tool by following these steps.

1. Add applicationcenterdeploytool.jar and json4j.jar to the java *classpath* environment variable.

2. Call the upload tool from the command line:

```
java com.ibm.appcenter.Upload -clearLdapCache [options]
```

You can pass any of the available options in the command line.

Option	Content indicated by	Description
-s	<b>serverpath</b>	The path to the Application Center server.
-c	<b>context</b>	The context of the Application Center web application.
-u	<b>user</b>	The user credentials to access the Application Center.
-p	<b>password</b>	The password of the user.
-y		Disable SSL security checking, which allows publishing on secured hosts without verification of the SSL certificate. Use of this flag is a security risk, but may be suitable for testing localhost with temporary self-signed SSL certificates.

### Example

In this example, user **demo** has the password **demopassword**.

```
java com.ibm.appcenter.Upload -clearLdapCache -s http://localhost:9080 -c applicationcenter -u demo -p demopassword
```

### Ant task for uploading or deleting an application

You can use the upload and delete tools as an Ant task and use the Ant task in your own Ant script.

Apache Ant is required to run these tasks. The minimum supported version of Apache Ant is listed in “System requirements” on page 2-7.

For convenience, Apache Ant 1.8.4 is included in IBM MobileFirst Platform Server. In the *product\_install\_dir/shortcuts/* directory, the following scripts are provided:

- ant for UNIX / Linux
- ant.bat for Windows

These scripts are ready to run, which means that they do not require specific environment variables. If the environment variable JAVA\_HOME is set, the scripts accept it.

When you use the upload tool as an Ant task, the **classname** value of the **upload** Ant task is `com.ibm.appcenter.ant.UploadApps`. The **classname** value of the **delete** Ant task is `com.ibm.appcenter.ant.DeleteApps`.

Parameters of Ant task	Description
<b>serverPath</b>	To connect to the Application Center. The default value is <code>http://localhost:9080</code> .

Parameters of Ant task	Description
<b>context</b>	The context of the Application Center. The default value is /applicationcenter.
<b>loginUser</b>	The user name with permissions to upload an application.
<b>loginPass</b>	The password of the user with permissions to upload an application.
<b>forceOverwrite</b>	If set to true, the Ant task attempts to overwrite applications in the Application Center when it uploads an application that is already present. This parameter is available only in the <b>upload</b> Ant task.
<b>file</b>	The .ipa file to be uploaded to the Application Center or to be deleted from the Application Center. This parameter has no default value.
<b>fileset</b>	To upload or delete multiple files.
<b>application</b>	The package name of the application; this parameter is available only in the <b>delete</b> Ant task.
<b>os</b>	The operating system of the application. This parameter is available only in the <b>delete</b> Ant task.
<b>version</b>	The internal version of the application; this parameter is available only in the <b>delete</b> Ant task. Do not use the commercial version here, because the commercial version is unsuitable to identify the version exactly.

## Example

You can find an extended example in the ApplicationCenter/tools/build.xml directory.

The following example shows how to use the Ant task in your own Ant script.

```
<?xml version="1.0" encoding="UTF-8"?>
<project name="PureMeapAntDeployTask" basedir="." default="upload.AllApps">

  <property name="install.dir" value="../../" />
  <property name="workspace.root" value="../../" />

  <!-- Server Properties -->
  <property name="server.path" value="http://localhost:9080/" />
  <property name="context.path" value="applicationcenter" />
  <property name="upload.file" value="" />
  <property name="force" value="true" />

  <!-- Authentication Properties -->
  <property name="login.user" value="appcenteradmin" />
  <property name="login.pass" value="admin" />
  <path id="classpath.run">
    <fileset dir="{install.dir}/ApplicationCenter/tools/">
      <include name="applicationcenterdeploytool.jar" />
      <include name="json4j.jar" />
    </fileset>
  </path>
  <target name="upload.init">
    <taskdef name="uploadapps" classname="com.ibm.appcenter.ant.UploadApps">
      <classpath refid="classpath.run" />
    </taskdef>
  </target>
  <target name="upload.App" description="Uploads a single application" depends="upload.init">
    <uploadapps serverPath="{server.path}"
      context="{context.path}"
      loginUser="{login.user}"
      loginPass="{login.pass}"
      forceOverwrite="{force}"
      file="{upload.file}" />
  </target>
  <target name="upload.AllApps" description="Uploads all found APK and IPA files" depends="upload.init">
    <uploadapps serverPath="{server.path}"
      loginUser="{login.user}"
      loginPass="{login.pass}"
      forceOverwrite="{force}"
      context="{context.path}" >
    <fileset dir="{workspace.root}">
      <include name="**/*.ipa" />
    </fileset>
  </target>
</project>
```



```

        </fileset>
      </uploadapps>
    </target>
  </project>

```

This sample Ant script is in the tools directory. You can use it to upload a single application to the Application Center.

```
ant upload.App -Dupload.file=sample.ipa
```

You can also use it to upload all applications that are found in a directory hierarchy.

```
ant upload.AllApps -Dworkspace.root=myDirectory
```

### Properties of the sample Ant script

Property	Comment
<b>install.dir</b>	Defaults to ../../
<b>server.path</b>	The default value is http://localhost:9080.
<b>context.path</b>	The default value is applicationcenter.
<b>upload.file</b>	This property has no default value. It must include the exact file path.
<b>workspace.root</b>	Defaults to ../../
<b>login.user</b>	The default value is appcenteradmin.
<b>login.pass</b>	The default value is admin.
<b>force</b>	The default value is true.

To specify these parameters by command line when you call Ant, add -D before the property name. For example:

```
-Dserver.path=http://localhost:8888/
```

## The mobile client

You can install applications on your mobile device with the Application Center mobile client.

The Application Center mobile client is the application that runs on your iOS device. You use the mobile client to list the catalog of available applications in the Application Center. You can install these applications on your device. The mobile client is sometimes referred to as the Application Center installer. This application must be present on your device if you want to install on your device applications from your private application repository.

### Prerequisites

Your system administrator must give you a user name and password before you can download and install the mobile client. The user name and password are required whenever you start the mobile client on your device. For security reasons, do not disseminate these credentials. These credentials are the same credentials used to log in to the Application Center console.

### Installing the client on an iOS mobile device

You can install the mobile client, or any signed application marked with the installer flag, on your iOS mobile device by entering the access URL in your browser, entering your credentials, and completing the required steps.

## Before you begin

**Important:** To install applications on iOS devices, you must first configure the Application Center server with SSL. See “Configuring Secure Sockets Layer (SSL)” on page 6-219.

### For experts

The `ibm.appcenter.ios.plist.onetimeurl` JNDI property of the IBM Application Center Services controls whether One-Time URLs are used when the mobile client is installed on an iOS mobile device. Set this property to `false` for maximal security. When you set this property to `false`, users must enter their credentials several times when they install the mobile client: once when they select the client and once when they install the client.

When you set the property to `true`, users enter their credentials only once. A temporary download URL with a cryptographic hash is generated when the user enters the credentials. This temporary download URL is valid for one hour and does not require additional authentication. This solution is a compromise between security and ergonomics.

The steps to specify the `ibm.appcenter.ios.plist.onetimeurl` JNDI property are similar to the steps for the `ibm.appcenter.proxy.host` property. See “Defining the endpoint of the application resources” on page 6-214.

## Procedure

Installing the mobile client on an iOS device is similar to installing it on Android, but with some differences. The installer is automatically launched directly after download. Your user name and password credentials are requested for almost all the installation steps.

1. Start the browser on your mobile device.
2. Enter the following access URL in the address text field: `http://hostname:portnumber/applicationcenter/installers.html`

Where *hostname* is the address of the server and *portnumber* is the number of the port where the Application Center is installed. Your system administrator can provide this information.

The Application Center also provides an alternative URL for installing the client on a mobile device: `http://hostname:portnumber/applicationcenter/inst.html`. The page of this URL works better with some older or some nonstandard mobile web browsers. If the page `installers.html` does not work on your mobile device, you can use `inst.html`. This page is provided in English only and is not translated into other languages.

3. Select an item in the list of available applications to display the application details.
4. Tap **Install Now** to download the mobile client.
5. Enter your credentials to authorize the downloader transaction.
6. To authorize the download, tap **Install**.



Figure 11-25. Confirm app to be installed

7. Enter your credentials to authorize the installation.

If you entered valid credentials, the browser will close and you can watch the download progress.

### Results

Installing an application on a device requires a provisioning profile that enables the application to be installed on the selected device. If you accidentally try to install an application that is not valid for your device, iOS version 6 or earlier gives an error message. Some versions of iOS 7 might try to install the application in an endless loop without ever succeeding or indicating any error. The application icon that shows the progress of the installation appears on the home screen, but, because of the endless loop, it is difficult to delete this application icon to stop the endless loop. A workaround is to put the device into Airplane mode. In this mode, the endless loop is stopped and you can delete the application icon by following the normal steps to delete apps on iOS devices.

### What to do next

After the mobile client is installed on the device, you can open it.

In general, iOS applications can be installed on the device only if they are signed with a provisioning profile. See “Importing and building the project” on page 11-70.

Since iOS 9, when a company application is opened, depending on the type of the provisioning profile, an Untrusted Enterprise Developer message might display. This message explains that the provisioning profile is not yet trusted on this device. In this case, the application does not open, unless trust is established for this provisioning profile. Establishing trust must be done only once per provisioning profile.

To establish trust for a provisioning profile after the application is installed:

#### Until iOS 9.1

1. Go to **Settings > General > Profiles**.

Under the **Enterprise apps** heading, you see the provisioning profile of the app.

2. Tap on the profile and confirm the trust.

#### Since iOS 9.2

1. Go to **Settings > General > Profiles > Device Management or Profiles & Device Management**.

Under the **Enterprise apps** heading, you see the provisioning profile of the app.

2. Tap on the profile and confirm the trust.

After the trust is confirmed, no application that uses that provisioning profile shows the Untrusted Enterprise Developer message. For more information, see the Apple web site at <https://support.apple.com/en-us/HT204460>.

### The Login view

In the Login view, you can access the fields that are required to connect to the server to view the list of applications available for your device.

Use the **Login** view to enter your credentials to connect to the Application Center server to view the list of applications available for your device.

The **Login** view presents all the mandatory fields for the information required to connect to the server.

When the application is started the Login page is displayed. The login credentials are required to connect to the server.

On iOS devices, the credentials are saved in the keychain. After you successfully log in to the Application Center server, when you start the application subsequently, the login page is not displayed and the previous credentials are used. If the login cannot be performed, the login view is displayed.

SSL is mandatory on iOS devices. Therefore, this option is not displayed in the login view.

#### User name and password

Enter your credentials for access to the server. These are the same user name and password granted by your system administrator for downloading and installing the mobile client.

### Application Center server address

The Application Center server address is composed of:

- Host name or IP address.
- Port, which is optional if the default port is used.
- Context, which is optional if the Application Center is installed at the root of the server.

On a phone, a field is available for each part of the address.

On a tablet, a single field that contains a preformatted example address is displayed. Use it as a model for entering the correct server address to avoid formatting errors. See “Preparations for using the mobile client” on page 11-69 for information on filling parts of the address in advance, or hardcode the address and hide the associated fields.

### Connecting to the server

To connect to the server:

1. Enter your user name and password.
2. Enter your Application Center server address.
3. Tap **Log in** to connect to the server.

If this login is successful, the user name and server address are saved to fill the fields when you subsequently start the client.

### Views in the Application Center client

The client provides views that are adapted to the various tasks that you want to perform.

After a successful login, you can choose among these views.



Figure 11-26. Views in the client application

These views enable you to communicate with a server to send or retrieve information about applications or to manage the applications located on your device.

Here are descriptions of the different views.

#### Catalog

This view shows the applications that can be installed on a device.

#### Favorites

This view shows the list of applications that you marked as favorites.

#### Updates

This view shows all applications that you marked as favorite apps and that have a later version available in Application Center than the version, if any, installed on the device.

When you first start the mobile client, it opens the **Login** view for you to enter your user name, password, and the address of the Application Center server. This information is mandatory.

### Displays on different device types

Different device types might have quite different page displays. On the phone, a list is displayed. On a tablet, a grid of applications is used.

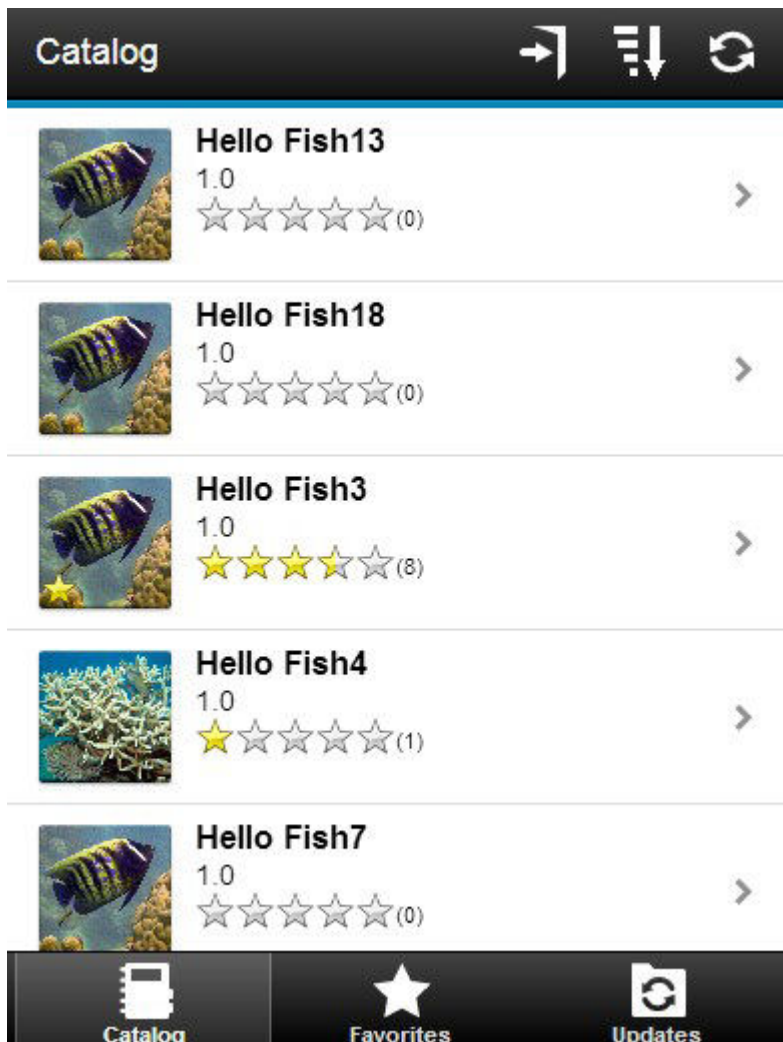

Figure 11-27. Catalog view on a phone

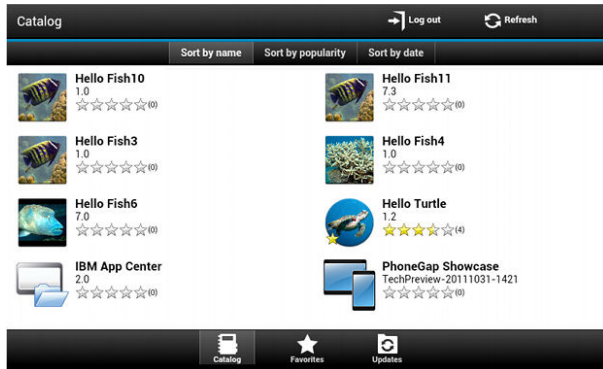

Figure 11-28. Catalog view on a tablet

## Features of the views

On a tablet, you can sort the lists by tapping one of the sort criteria.

Sort criteria are available through the sort button.

Applications that are marked as favorites are indicated by a star superposed on the application icon.

The average rating of the latest version of an application is shown by using a number of stars and the number of ratings received. See “Preparations for using the mobile client” on page 11-69 for how to show the rating of all versions of the application instead of the latest version only.

Tapping an application in the list navigates to the Details view of the latest installed version of this application.

To refresh the view, tap the refresh button: .

To return to the login page:

- Tap the logout button. 

## The Details view

Tapping an application in the Catalog, Favorites, or Updates view navigates to the Details view where you can see details of the application properties. Details of the application version are displayed in this view.

- The name of the application.
- Commercial version: the published version of the application.
- Internal version: on iOS, the build number of the application; See “Application properties” on page 11-83 for technical details concerning this property.
- Update date.
- Approximate size of the application file.
- Rating of the version and number of ratings received.
- Description of the application.

You can perform several actions in this view.

- Install, upgrade, downgrade, or uninstall an application version.
- Cancel the current operation in progress (if available).
- Rate the application version if it is installed on the device.
- List the reviews of the this version or of all versions of the application.
- Show details of a previous version.
- Mark or unmark the application as a favorite app.
- Refresh the view with the latest changes from the Application Center server.

## Installing an application on an iOS device

From the **Details** view, you can install an application version on your iOS mobile device.

### About this task



Figure 11-29. Details view of an app version shown on your iOS device

**Important:** To install applications on iOS devices, you must first configure the Application Center server with SSL. See “Configuring Secure Sockets Layer (SSL)” on page 6-219.

### Procedure

1. In the **Details** view, tap **Install**. You are requested to confirm the download and installation of the application version.



2. Tap **Install** to confirm download and installation of the application version or **Cancel** to cancel the installation.

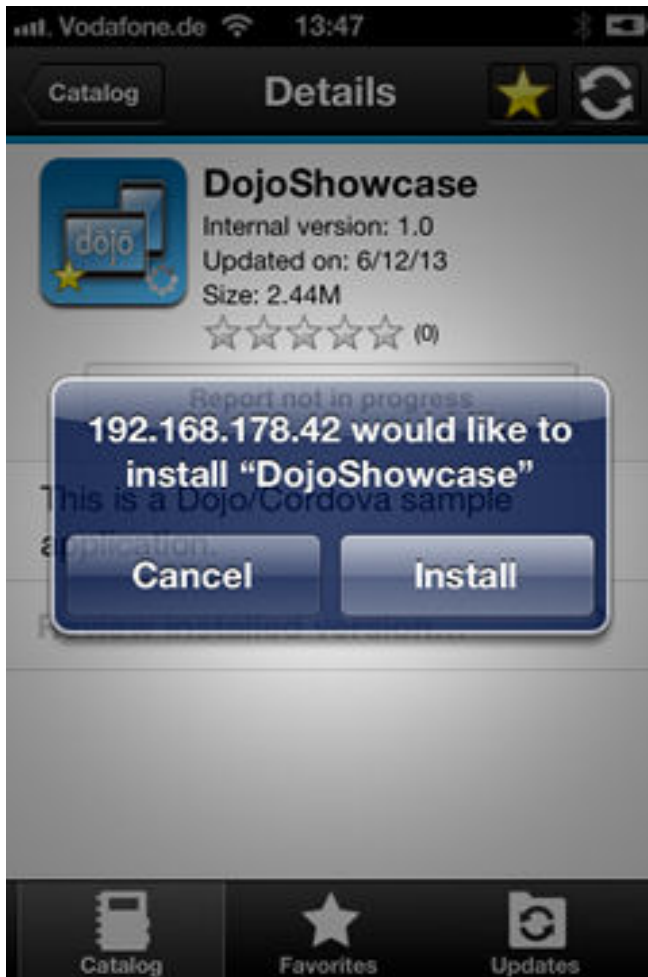

Figure 11-30. Canceling application installation on your iOS device

Depending on the action taken, the application is installed or not. When the application is successfully installed, it is also marked as a favorite app.

Installing an application on a device requires a provisioning profile that enables the application to be installed on the selected device. If you accidentally try to install an application that is not valid for your device, iOS version 6 or earlier gives an error message.

## Results

Unlike the Android client, after the installation is finished, the **Install** button in the Details view does not change its label to **Uninstall**. In iOS, there is no **Uninstall** button. It is only possible to uninstall applications through the home screen.

Some versions of iOS 7 might try to install the application in an endless loop without ever succeeding or indicating any error. The application icon that shows the progress of the installation appears on the home screen, but, because of the endless loop, it is difficult to delete this application icon to stop the endless loop. A workaround is to put the device into Airplane mode. In this mode, the endless

loop is stopped and you can delete the application icon by following the normal steps to delete apps on iOS devices.

### **What to do next**

After the application is installed on the device, you can open it.

In general, iOS applications can be installed on the device only if they are signed with a provisioning profile. See “Importing and building the project” on page 11-70.

Since iOS 9, when a company application is opened, depending on the type of the provisioning profile, an Untrusted Enterprise Developer message might display. This message explains that the provisioning profile is not yet trusted on this device. In this case, the application does not open, unless trust is established for this provisioning profile. Establishing trust must be done only once per provisioning profile.

To establish trust for a provisioning profile after the application is installed:

#### **Until iOS 9.1**

1. Go to **Settings > General > Profiles**.  
Under the **Enterprise apps** heading, you see the provisioning profile of the app.
2. Tap on the profile and confirm the trust.

#### **Since iOS 9.2**

1. Go to **Settings > General > Profiles > Device Management or Profiles & Device Management**.  
Under the **Enterprise apps** heading, you see the provisioning profile of the app.
2. Tap on the profile and confirm the trust.

After the trust is confirmed, no application that uses that provisioning profile shows the Untrusted Enterprise Developer message. For more information, see the Apple web site at <https://support.apple.com/en-us/HT204460>.

### **Installing applications through public app stores**

You can link from the mobile client to applications that are stored in supported public app stores and install these applications on your compatible device by following the normal procedure of the public app store.

### **About this task**

The Application Center administrator can create links to selected applications stored in supported public app stores and make them available to users of the Application Center mobile client on the operating systems that match these applications. See “Adding an application from a public app store” on page 11-81. You can install these applications through the mobile client on your compatible device.

Links to iOS applications stored in Apple iTunes are listed in the application list on the device along with the binary files of private applications created within your enterprise.

## Procedure

1. Select an application stored in a public app store from the application list to see the application details. Instead of **Install**, you see **Go to Store**.
2. Tap **Go to Store** to open Apple iTunes.

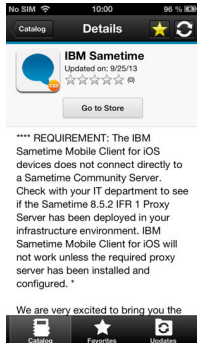

Figure 11-31. Accessing an application in Apple iTunes from the mobile client on the device

3. Follow the usual procedure of the public app store to install the application.

## Removing an installed application

You can remove an application that is installed on your mobile device.

### About this task

You can remove applications only from the iOS Home screen, and not through the Application Center client. Use the normal iOS procedure for removing an application.

## Showing details of a specific application version

Select a version of an application to show its details.

### Procedure

1. Show details of a specific application version on a mobile device by selecting the appropriate procedure to follow for your device.
  - A phone; see step 2.
  - A tablet; see step 3 on page 11-116.
2. Show details of a specific application version on an iOS phone.
  - a. Tap **Select a version** to navigate to the version list view.



Figure 11-32. Specific version of an application selected in the list of versions on an iOS phone

- b. Tap the required version of the application. The **Details** view is updated and shows the details of the selected application version.
3. **Tablet devices only:** Show details of a specific application version on a tablet.
  - a. Tap **Select version**.
  - b. In the pop-up menu, select the required version of the application. The **Details** view is updated and shows the details of the selected application version.

### Updating an application

You can update an application that is installed on your device if a new version is available in the Application Center.

#### About this task

Follow this procedure to make the latest versions of favorite and recommended apps available on your device. Applications that are marked as favorites and that have an updated version are listed in the **Updates** view. The applications that are marked as recommended by the Application Center server administrator are also listed in the **Updates** view, even if they are not favorites.

If a more up-to-date version of an installed application is available on the server, it is listed under **Update or Recommended**.

#### Procedure

1. In the **Updates** view, navigate to the **Details** view.
2. In the **Details** view, select a newer version of the application or take the latest available version.
3. On iOS devices, tap **Install latest**.
4. Follow the appropriate application installation procedure. “Installing an application on an iOS device” on page 11-112.

### Upgrading the Application Center client automatically

You can enable automatic detection of new versions of the client application. Then, you can choose whether to download and install the new version on your mobile device.

#### Before you begin

Start the Application Center client.

## About this task

New versions of the mobile client application that are available on the Application Center server can be detected automatically. When this feature is enabled, a more recent version of the application, if it exists, can be detected at start up or each time that the Available applications view is refreshed.

If a later version of the application is detected, you are requested to download and install the later version.

Automatic upgrade of the Application Center client application is enabled by default with the **appCenterAutoUpgrade** property set to true. This property is located in the MobileFirst project for the Application Center: `IBMApCenter/apps/AppCenter/common/js/appcenter/config.json`.

If you want to disable automatic upgrade, you must set this property to false and rebuild the project for the required platforms.

## Procedure

1. When a later version of the client is detected, tap **OK** to start the download and installation sequence.

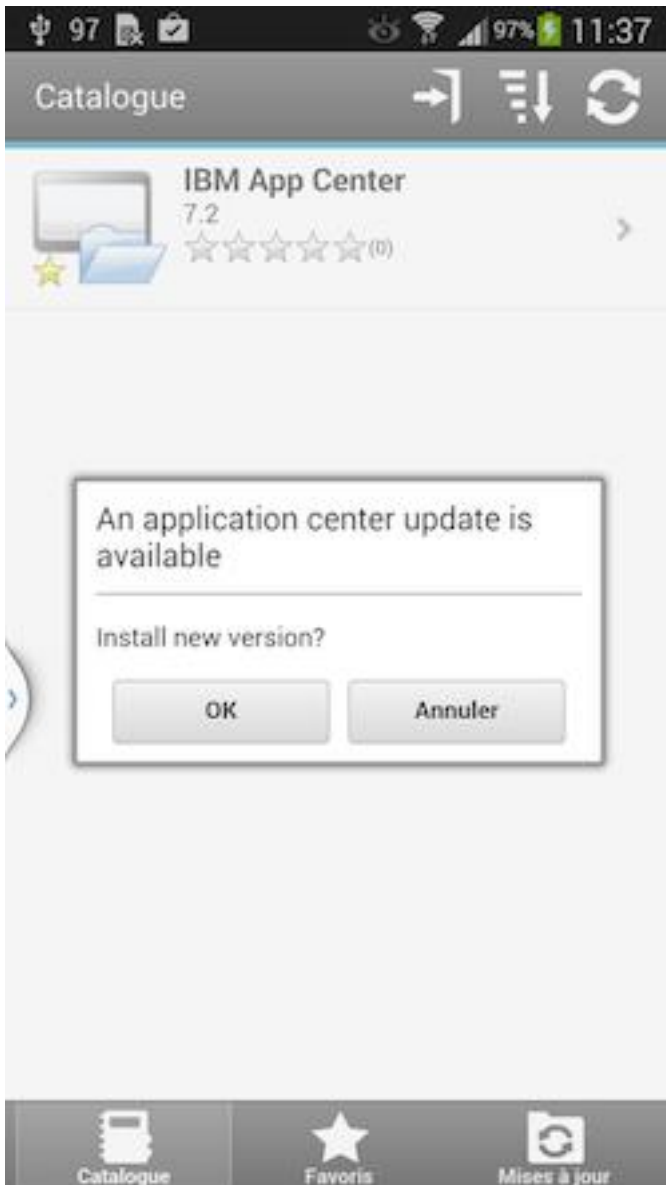

Figure 11-33. Detection of a later version of the client application available on the server

2. Tap **Install** to install the later version of the application.

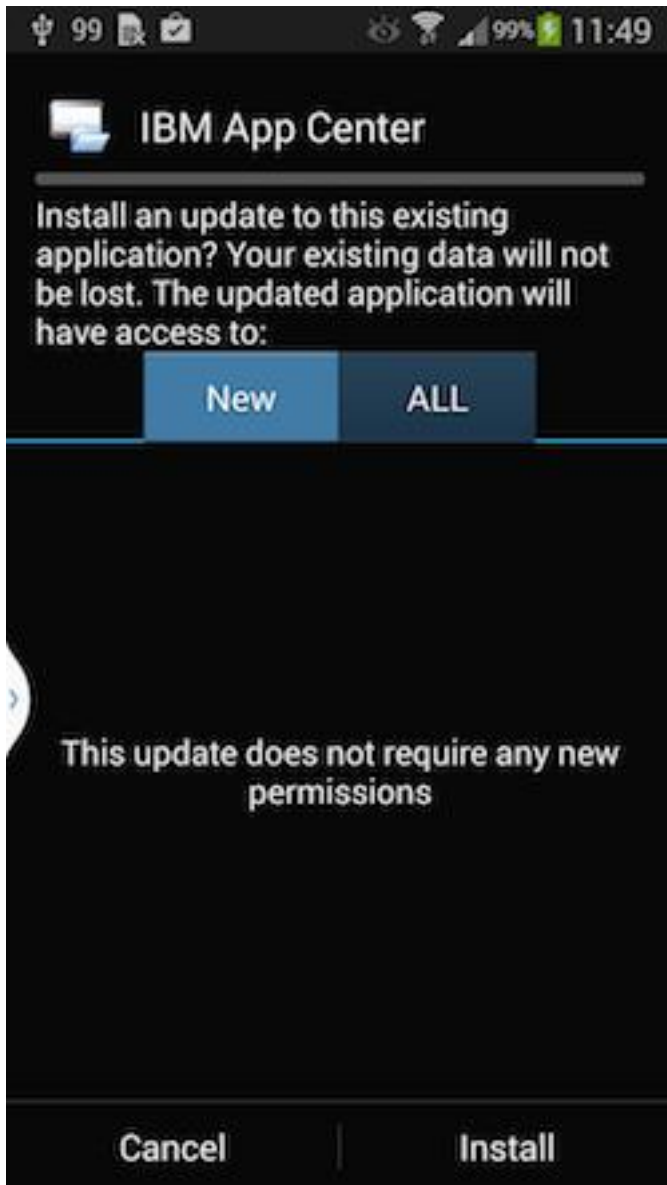

Figure 11-34. Confirm installation of the updated version of the application

3. Tap **Open** to start the updated application.

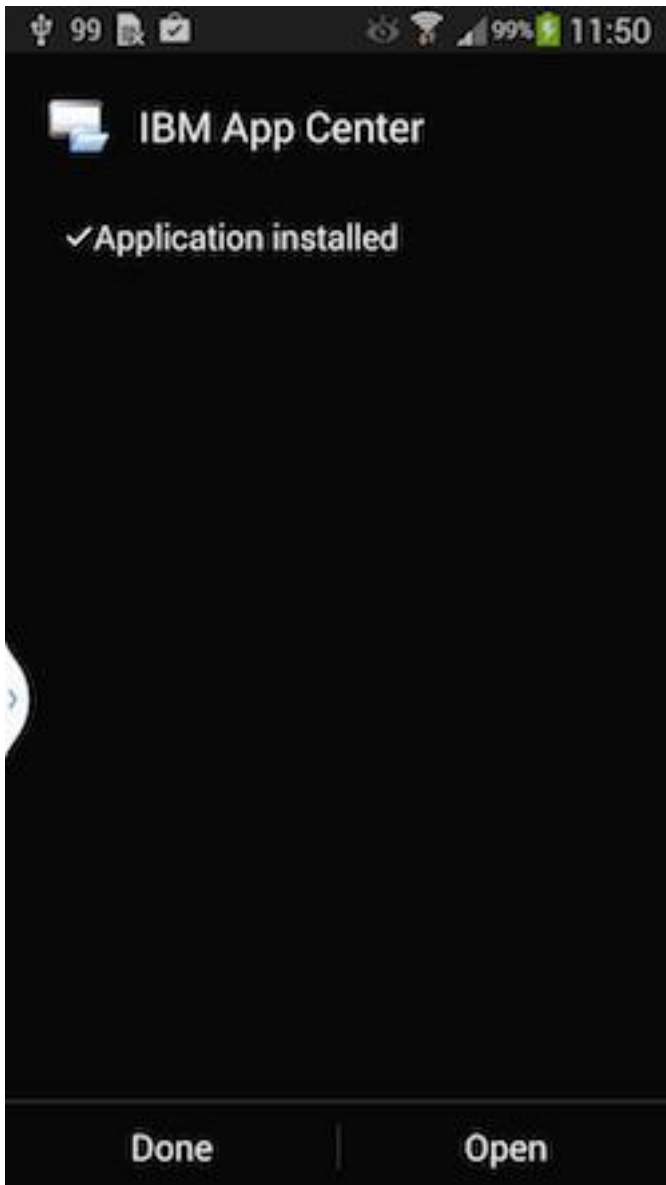

Figure 11-35. Starting the updated application

### Results

You must log in to the updated version of the application to run it.





Figure 11-36. Logging in to the new version of the client application

**Note:** To upgrade the Application Center client, the following conditions apply:

- The new Application Center client must use the same package name or bundle identifier as the old client.
- The new Application Center client must be signed with the same provisioning profile as the old client.

### Reverting an installed application

You can revert the version of an installed application if an earlier version exists on the server.

#### Purpose

To replace the currently installed version of an application with an earlier version, from the **Catalog**, **Updates**, or **Favorites** view, navigate to the **Details** view. In the **Details** view, select an earlier version. See “Showing details of a specific

application version” on page 11-115 for information about how to display details of a specific application version on a mobile device.

See “Preparations for using the mobile client” on page 11-69 for information about how to disable reverting to earlier versions of an application.

## On iOS

Use the normal procedure of the operating system to remove the application.

Tap **Install** to install the earlier version of the application. Follow the procedure documented in “Installing an application on an iOS device” on page 11-112.

## Marking or unmarking a favorite app

Mark your favorite apps or unmark an app to have it removed from the favorites list.

An application marked as a favorite on your device indicates that you are interested in this application. This application is then listed in the list of favorite apps to make locating it easier. This application is displayed on every device belonging to you that is compatible with the application. If a later version of the app is available in the Application Center, the application is listed in the **Updates** view.

To mark or unmark an application as a favorite app, tap the Favorites icon  in the header of the **Details** view.

An installed application is automatically marked as a favorite app.

## Submitting a review for an installed application

You can review an application version installed on your mobile device; the review must include a rating and a comment.

### About this task

You can only submit a review of a version of an application if that version is installed on your mobile device.

### Procedure

1. In the **Details** view, initiate your review:
  - On iOS phones and tablets, tap **Review version X**.
2. Enter a nonzero star rating:
  - On mobile devices with touch screens, tap a star, from 1 to 5, to represent your approval rating of the version of the application.

One star represents the lowest level of appreciation and five stars represent the highest level of appreciation.

3. Enter a comment about this version of the application.
4. Tap **Submit** to send your review to the Application Center.

### Viewing reviews

You can view reviews of a specific version of an application or of all versions of an application.

## Purpose

To view reviews of application versions; reviews are displayed in descending order from the most recent review. If the number of reviews fills more than one screen, tap **Load more** to show more reviews.

## Viewing reviews of a specific version

The **Details** view always shows the details of a specific version. On a phone, the reviews are for that version.

In the **Details** view of an application version:

### On a phone

Tap **View Reviews** to navigate to the **Reviews** view.

### On a tablet

Tap **Reviews xx**, where *xx* is the displayed version of the application.

## Viewing reviews of all versions of an application

In the **Details** view of an application version:

### On a phone

Tap **View Reviews** to navigate to the **Reviews** view. Then tap the settings

icon , tap **All versions**, and confirm the selection.

### On a tablet

Tap **All Reviews**.

---

## Federal standards support in IBM MobileFirst Platform Foundation for iOS

IBM MobileFirst Platform Foundation for iOS supports Federal Desktop Core Configuration (FDCC), and United States Government Configuration Baseline (USGCB) specifications. IBM MobileFirst Platform Foundation for iOS also supports the Federal Information Processing Standards (FIPS) 140-2, which is a security standard that is used to accredit cryptographic modules.

For more information about the Federal Desktop Core Configuration and United States Government Configuration Baseline, see FDCC and USGCB.

For more information about the Federal Information Processing Standards 140-2, see FIPS 140-2 support.

## FDCC and USGCB support

The United States federal government mandates that federal agency desktops that run on Microsoft Windows platforms adopt Federal Desktop Core Configuration (FDCC) or the newer United States Government Configuration Baseline (USGCB) security settings.

IBM Worklight V5.0.6 was tested by using the USGCB and FDCC security settings via a self-certification process. Testing includes a reasonable level of testing to ensure that installation and core features function on this configuration.

## References

For more information, see USGCB.

## FIPS 140-2 support

Federal Information Processing Standards (FIPS) are standards and guidelines that are issued by the United States National Institute of Standards and Technology (NIST) for federal government computer systems. FIPS Publication 140-2 is a security standard that is used to accredit cryptographic modules.

### **FIPS 140-2 on the MobileFirst Server, and SSL communications with the MobileFirst Server**

The IBM MobileFirst Platform Foundation for iOS server runs in an application server, such as the WebSphere Application Server. The WebSphere Application Server can be configured to enforce the use of FIPS 140-2 validated cryptographic modules for inbound and outbound Secure Socket Layer (SSL) connections. The cryptographic modules are also used for the cryptographic operations that are performed by the applications by using the Java™ Cryptography Extension (JCE). Since the MobileFirst Server is an application that runs on the application server, it uses the FIPS 140-2 validated cryptographic modules for the inbound and outbound SSL connections.

When an IBM MobileFirst Platform Foundation for iOS client transacts a Secure Socket Layer (SSL) connection to a MobileFirst Server, which is running on an application server that is using the FIPS 140-2 mode, the results are the successful use of the FIPS 140-2 approved cipher suite. If the client platform does not support one of the FIPS 140-2 approved cipher suites, the SSL transaction fails and the client is not able to establish an SSL connection to the server. If successful, the client uses a FIPS 140-2 approved cipher suite. Specifically, the client and server are using the same cipher suite (SSL\_RSA\_WITH\_AES\_128\_CBC\_SHA for example), but the client side cryptographic module perhaps did not go through the FIPS 140-2 validation process, whereas the server side is using FIPS 140-2 certified modules.

See “References” for links to documentation to enable FIPS 140-2 mode in WebSphere Application Server.

## References

For information about how to enable FIPS 140-2 mode in WebSphere Application Server, see Federal Information Processing Standard support.

For the WebSphere Application Server Liberty profile, no option is available in the administrative console to enable FIPS 140-2 mode. But you can enable FIPS 140-2 by configuring the Java runtime environment to use the FIPS 140-2 validated modules. For more information, see Java Secure Socket Extension (JSSE) IBMJSSE2 Provider Reference Guide.

---

## Monitoring and mobile operations

IBM MobileFirst Platform Foundation for iOS includes a range of operational analytics and reporting mechanisms for collecting, viewing, and analyzing data from your IBM MobileFirst Platform Foundation for iOS applications and servers, and for monitoring server health.

---

### Logging and monitoring mechanisms

IBM MobileFirst Platform Foundation for iOS reports errors, warnings, and informational messages into a log file. The underlying logging mechanism varies by application server.

#### IBM MobileFirst Platform Server

MobileFirst Server uses the standard `java.util.logging` package. By default, all MobileFirst logging goes into the application server log files. You can control MobileFirst Server logging by using the standard tools available in each application server. If, for example, you want to activate trace logging in Liberty, add a trace element to the `server.xml` file. To activate trace logging in WebSphere Application Server, use the logging screen in the console and enable trace for MobileFirst logs. MobileFirst logs all begin with "com.worklight".

Application Center logs begin with "com.ibm.puremeap".

For more information about the logging models of each server platform, including the location of the log files, see the documentation for the relevant platform, as shown in the following table.

*Table 12-1. Documentation for different server platforms*

Server platform	Location of documentation
Apache Tomcat	<a href="http://tomcat.apache.org/tomcat-7.0-doc/logging.html#Using_java.util.logging_(default)">http://tomcat.apache.org/tomcat-7.0-doc/logging.html#Using_java.util.logging_(default)</a>
WebSphere Application Server Version 7.0	<a href="http://ibm.biz/knowctr#SSEQTP_7.0.0/com.ibm.websphere.base.doc/info/aes/ae/ttrb_trcover.html">http://ibm.biz/knowctr#SSEQTP_7.0.0/com.ibm.websphere.base.doc/info/aes/ae/ttrb_trcover.html</a>
WebSphere Application Server Version 8.0	<a href="http://ibm.biz/knowctr#SSEQTP_8.0.0/com.ibm.websphere.base.doc/info/aes/ae/ttrb_trcover.html">http://ibm.biz/knowctr#SSEQTP_8.0.0/com.ibm.websphere.base.doc/info/aes/ae/ttrb_trcover.html</a>
WebSphere Application Server Version 8.5 full profile	<a href="http://ibm.biz/knowctr#SSEQTP_8.5.5/com.ibm.websphere.base.doc/ae/ttrb_trcover.html">http://ibm.biz/knowctr#SSEQTP_8.5.5/com.ibm.websphere.base.doc/ae/ttrb_trcover.html</a>
WebSphere Application Server Version 8.5 Liberty profile	<a href="http://ibm.biz/knowctr#SSEQTP_8.5.5/com.ibm.websphere.wlp.doc/ae/rwlp_logging.html?cp=SSEQTP_8.5.5%2F1-16-0-0">http://ibm.biz/knowctr#SSEQTP_8.5.5/com.ibm.websphere.wlp.doc/ae/rwlp_logging.html?cp=SSEQTP_8.5.5%2F1-16-0-0</a>

#### Log level mappings

MobileFirst Server uses `java util logging`. The logging levels map to the following levels:

- `WL.Logger.debug`: FINE
- `WL.Logger.info`: INFO
- `WL.Logger.warn`: WARNING

- WL.Logger.error: SEVERE

## Log monitoring tools

For Apache Tomcat, you can use IBM Operations Analytics - Log Analysis or other industry standard log file monitoring tools to monitor logs and highlight errors and warnings.

For WebSphere Application Server, use the log viewing facilities that are described in the IBM Knowledge Center at the URLs that are listed in the table in the MobileFirst Server section.

## Back-end connectivity

To enable trace to monitor back-end connectivity, see the documentation for your specific application server platform in the table in the MobileFirst Server section. The packages to be enabled for trace are `com.worklight.adapters` and `com.worklight.integration`. Set the log level to `FINEST` for each package.

## Audit log for administration operations

MobileFirst Operations Console stores an audit log for login, logout, and for all administration operations, such as deploying apps or adapters or locking apps. The audit log can be disabled by setting the JNDI property `ibm.worklight.admin.audit` on the web application of the MobileFirst Administration service (`worklightadmin.war`) to `false`.

When the audit log is enabled, you can download it from MobileFirst Operations Console by clicking the **Audit log** link in the footer of the page.

## Audit logs for adapters

To write log information for auditing adapter calls, activate the audit logs by setting `audit="true"` in your `adapter.xml` file in the procedure definition.

## Login and authentication issues

To diagnose login and authentication issues, enable the package `com.worklight.auth` for trace and set the log level to `FINEST`.

## Vitality queries for checking server health

Use MobileFirst vitality queries to run a health check of your server, and determine the vitality status of your server.

You generally use the MobileFirst vitality queries from a load balancer or from a monitoring app (for example, Patrol).

You can run vitality queries for the server as a whole, for a specific adapter, for a specific app, or for a combination of. The following table shows some examples of vitality queries.

Table 12-2. Examples of queries that help determine server vitality

Query	Purpose
http://<server>:<port>/<publicWorkLightContext>/ws/rest/vitality	Checks the server as a whole.
http://<server>:<port>/<publicWorkLightContext>/ws/rest/vitality?app=MyApp	Checks the server and the MyApp application.
http://<server>:<port>/<publicWorkLightContext>/ws/rest/vitality?app=MyApp&adapter=MyAdapter	Checks the server, the MyApp application, and the MyAdapter adapter.

**Note:** Do not include the /<publicWorkLightContext> part of the URL if you use IBM MobileFirst Platform Foundation Developer Edition. You must add this part of the URL only if MobileFirst Server is running on another application server, such as Apache Tomcat or WebSphere Application Server (full profile or Liberty profile).

Vitality queries return an XML content that contains a series of <ALERT> tags, one for each test.

### Example query and response

By running the http://<server>:<port>/ws/rest/vitality?app=MyApp query, you might have the following successful response, with an <ALERT> tag for each of the three tests:

```
<ROOT>
  <ALERT>
    <DATE> 2011-05-17T15:31:35.583+0300 </DATE>
    <EVENTID>0</EVENTID>
    <SUBJECT>SRV</SUBJECT>
    <TYPE>I</TYPE>
    <COMPUTER>worklight.acme.com</COMPUTER>
    <DESCRIPTION>Server is running</DESCRIPTION>
  </ALERT>
  <ALERT>
    <DATE> 2011-05-17T15:31:35.640+0300 </DATE>
    <EVENTID>0</EVENTID>
    <SUBJECT>APPL</SUBJECT>
    <TYPE>I</TYPE>
    <COMPUTER>worklight.acme.com</COMPUTER>
    <DESCRIPTION>Application 'MyApp' is deployed</DESCRIPTION>
  </ALERT>
  <ALERT>
    <DATE>2014-07-08T11:39:42.622+0300</DATE>
    <EVENTID>0</EVENTID>
    <SYSTEM>WRKL</SYSTEM>
    <SUBJECT>BUILD</SUBJECT>
    <COMPUTER>192.168.218.1</COMPUTER>
    <DESCRIPTION>6.2.0.00.20140707-1736</DESCRIPTION>
  </ALERT>
</ROOT>
```

### Return values

The following table lists the attributes that might be returned, and their possible values.

Table 12-3. Return values and values

Return attribute	Possible values
DATE	Date value in JavaScript™ format
EVENTID	0 for the running server, deployed adapter, or deployed application  1 for not deployed adapter  2 for not deployed application  3 for malfunctioning server
SUBJECT	SRV for MobileFirst Server  ADPT for adapter  APPL for application  BUILD for the version of the MobileFirst Server
TYPE	I – valid  E – error
COMPUTER	Reporting computer name
DESCRIPTION	Status description in plain text

The returning XML contains more attributes, which are undocumented constants that you must not use.

## Setting logging and tracing for Application Center on the application server

You can set logging and trace parameters for particular application servers and use JNDI properties to control output on all supported application servers.

You can set the logging levels and the output file for tracing operations for Application Center in ways that are specific to particular application servers. In addition, IBM MobileFirst Platform Foundation for iOS provides Java Naming and Directory Interface (JNDI) properties to control the formatting and redirection of trace output, and to print generated SQL statements.

### Enabling logging and tracing in WebSphere Application Server full profile

You can set the logging levels and the output file for tracing operations on the application server.

#### About this task

When you try to diagnose problems in the Application Center (or other components of IBM MobileFirst Platform Foundation for iOS), it is important to be able to see the log messages. To print readable log messages in log files, you must specify the applicable settings as Java virtual machine (JVM) properties.

#### Procedure

1. Open the administrative console of WebSphere Application Server.
2. Select **Troubleshooting > Logs and Trace**.



3. In "Logging and tracing", select the appropriate application server and then select "Change log detail levels".
4. Select the required packages and their corresponding detail level. For example, in this way you can select following packages and set the detail level. This example enables logging for IBM MobileFirst Platform Foundation for iOS, including Application Center, with level FINEST (equivalent to ALL)

```
com.ibm.puremeap.*=all  
com.ibm.worklight.*=all  
com.worklight.*=all
```

Where:

- com.ibm.puremeap.\* is for Application Center.
- com.ibm.worklight.\* and com.worklight.\* are for other MobileFirst components.

The traces are sent to a file called trace.log. Note that they are not sent to SystemOut.log or to SystemErr.log.

For more details, see Configuring Java logging using the administrative console.

## Enabling logging and tracing in WebSphere Application Server Liberty profile

You can set the logging levels and the output file for tracing operations for Application Center on the Liberty profile application server.

When you try to diagnose problems in the Application Center, it is important to be able to see the log messages. To print readable log messages in log files, you must specify the applicable settings.

To enable logging for IBM MobileFirst Platform Foundation for iOS, including Application Center, with level FINEST (equivalent to ALL), add a line to the server.xml file. For example:

```
<logging traceSpecification="com.ibm.puremeap.*=all:com.ibm.worklight.*=all:com.worklight.*=all"/>
```

Where multiple entries of a package and its logging level are separated by a colon (:).

The traces are sent to a file called trace.log. Note that they are not sent to messages.log or to console.log.

For more details, see Liberty profile: Logging and Trace.

## Enabling logging and tracing in Apache Tomcat

You can set the logging levels and the output file for tracing operations undertaken on the Apache Tomcat application server.

When you try to diagnose problems in the Application Center, it is important to be able to see the log messages. To print readable log messages in log files, you must specify the applicable settings.

To enable logging for IBM MobileFirst Platform Foundation for iOS, including Application Center, with level FINEST (equivalent to ALL), edit the conf/logging.properties file. For example, add lines similar to these lines:

```
com.ibm.puremeap.level = ALL  
com.ibm.worklight.level = ALL  
com.worklight.level = ALL
```

For more details, see Logging in Tomcat.

## JNDI properties for controlling trace output

On all supported platforms, you can use Java Naming and Directory Interface (JNDI) properties to format and redirect trace output for Application Center, and to print generated SQL statements.

The following table shows the applicable properties and settings.

Table 12-4. JNDI property settings for controlling trace output

Property settings	Description
ibm.appcenter.logging.formatjson=true	This setting uses white space to format the JSON output for easier reading in log files.
ibm.appcenter.logging.tosystemerror=true	This setting prints all log messages to system error in log files. It enables you to turn on logging globally.
ibm.appcenter.openjpa.Log=DefaultLevel=WARN, Runtime=INFO, Tool=INFO, SQL=TRACE	This setting prints all the generated SQL statements in the log files.

---

## Analytics

The operational analytics feature enables searching across apps, services, devices, and other sources to collect data about usage or detect problems.

IBM MobileFirst Platform Foundation for iOS includes a scalable operational analytics feature that is accessible from the MobileFirst Operations Console. The analytics feature enables enterprises to search across logs and events that are collected from devices, apps, and servers for patterns, problems, and platform usage statistics.

The data for operational analytics includes the following sources:

- Interactions of any app-to-server activity (anything that is supported by the MobileFirst client/server protocol, including push notification).
- Client-side logs and crashes.
- Server-side logs that are captured in traditional MobileFirst log files.

The operational analytics feature is accessible from the MobileFirst Operations Console and includes these capabilities:

### Interactive web-based usage.

#### Dashboard view

These features include interaction support to see the full device usage across the platform for the last 30, 60 or 90 days. You can drill down to specific apps and app versions.

#### Devices view

View device information, including session activity, network activity, and JSONStore analytics. Search is provided to view information about a particular device.

**Adapters view**

View information about adapters such as invocation frequency and network latency. You can drill down to a specific adapter or procedure.

**Servers view**

View analytics information about individual servers in a cluster. Download server logs.

**Activities view**

View analytics data on custom activities that are created with the client-side logging features.

**Search view**

Provides a text search for client and server-side logs. Allows filtering by application, version, environment, severity, and so on.

## Comparison of operational analytics and reports features

Compare the reports and operational analytics features to know why and how to best use each.

**Note:** The Reports database and the sample BIRT Reports are deprecated in IBM MobileFirst Platform Foundation for iOS V7.0.0. You should use “Operational analytics” on page 12-8 instead.

With the introduction of the IBM MobileFirst Platform Operational Analytics, enabling the BIRT feature is redundant. A comparison of the capabilities of these two features can help clarify the strengths of each, and help determine how you can best use them.

The data that is collected by the “Reports database” on page 12-74 feature is a subset of the total data that is collected as part of the Operational “Analytics” on page 12-6 feature. You can use the reports database and the operational analytics feature simultaneously, but usage of both in a production environment is redundant. Use the reports feature in cases where you want direct access to the Reports database to run custom queries. An example of a scenario where direct database access is needed is the use of BIRT or a customized online analytics processing (OLAP) system that runs database queries directly against the Reports database.

*Table 12-5. Comparison of analytics and reports features.* This table lists a comparison of analytics and reports features.

	<b>Operational analytics feature</b>	<b>Reports feature</b>
<b>Primary usage</b>	Problem determination, device usage summary, geographic view of mobile activity	Device usage summary
<b>Typical user</b>	Administrator, operational support personnel, developer, analyst	Administrator, analyst
<b>Data used in analytics</b>	App crash from clients, MobileFirst Server log, MobileFirst app to server interaction activities	MobileFirst app to server interaction activities

Table 12-5. Comparison of analytics and reports features (continued). This table lists a comparison of analytics and reports features.

	<b>Operational analytics feature</b>	<b>Reports feature</b>
<b>Data storage mechanism</b>	Files on the IBM MobileFirst Platform Operational Analytics	Relational database
<b>Analytics mechanism</b>	Each log event is treated as a JSON document. The data in the document is indexed so that it can be searched by keyword in the document and presented in a canonical form that shows the app, version, some device data, location (if enabled), time stamp, adapter (if present in the document) and other data.	Each log event is treated as a row in the raw Reports database table and then aggregated for statistics into the app_activities database table, summarized to app, device operating system, and time stamp relationships.
<b>Access mechanism</b>	MobileFirst Operations Console	BIRT or other reporting tools that can understand data cubes
<b>Extendable</b>	Extending the published reports is not supported.	Data can be extracted from the database tables by using any means that you desire, including but not limited to, BIRT.
<b>Search across logs</b>	Yes	No
<b>Optional</b>	Yes	Yes

In addition to an at-a-glance view of your mobile and web application analytics, the operational analytics includes the capability to perform raw search against server logs, client activities, captured client crash data. The operational analytics feature can also search any additional data that you explicitly provide through client and server-side API function calls that feed into the IBM MobileFirst Platform Operational Analytics.

## Operational analytics

The operational analytics platform collects data about applications, adapters, devices, and logs to give a high-level view of the client interaction with the MobileFirst Server and to enable problem detection.

The data for operational analytics includes the following sources:

- Crash events of an application on iOS devices (crash events for native code errors).
- Interactions of any application-to-server activity (anything that is supported by the MobileFirst client/server protocol, including push notification).
- Server-side logs that are captured in traditional MobileFirst log files.

The operational analytics feature is accessible from the MobileFirst Operations Console and includes the following capabilities:

- Near real-time analytics for client activity with the MobileFirst Server.
- Analytics for adapter hits.

- Network latency analytics.
- Client log search and download.
- Server log search and download.
- Crash and stack trace search.

All data collected by the analytics platform can be visualized through the Operational Analytics console. The console also provides the ability to create custom charts based on data collected by the analytics platform. In addition to an at-a-glance view of your mobile and web application analytics, the analytics feature includes the capability to perform a raw search against server and client logs, captured client crash data, and any extra data you explicitly provide through client and server API function calls that feed into the IBM MobileFirst Platform Operational Analytics.

### Data capture

When the IBM MobileFirst Platform Operational Analytics is deployed and the MobileFirst Server is properly configured, data begins to flow from the MobileFirst Server to the IBM MobileFirst Platform Operational Analytics. Some types of data are captured automatically without extra client or server configurations. Some types of data require changes to be made in the client application to capture or forward the data to the MobileFirst Server.

### Analytics event types

The following image shows the analytics data flow:

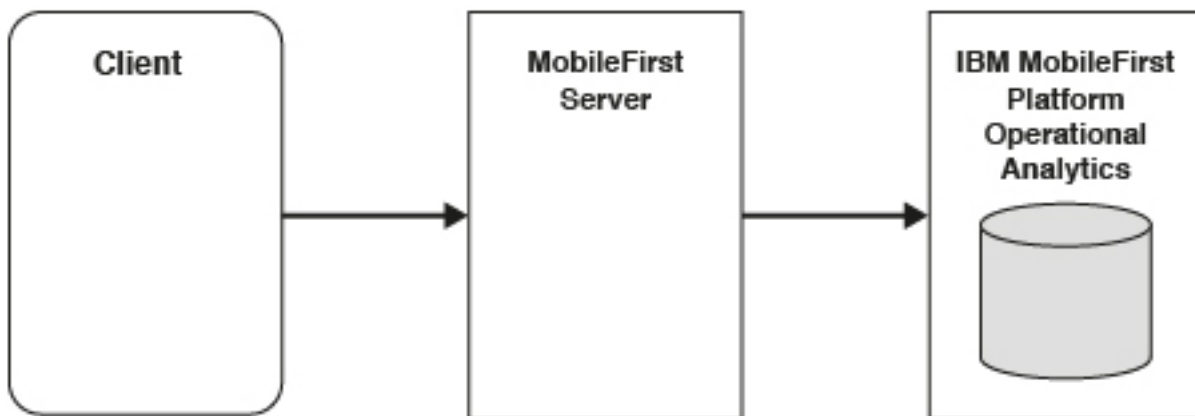

All data that is sent from the MobileFirst Server to the IBM MobileFirst Platform Operational Analytics is categorized by its type. This section briefly describes the different types of analytics data that is captured and analyzed.

### App Activities

All IBM MobileFirst Platform Foundation for iOS client/server network communication is considered to be an app activity. An app activity is sent to the IBM MobileFirst Platform Operational Analytics when:

- A client device begins a new session with the MobileFirst Server.
- A client device makes an adapter request.

When the client communicates with the MobileFirst Server through one of the previously mentioned events, it also sends metadata about the device, including:

- Device environment (iOS, and so on).
- Device model (iPhone3,3, iPad4,4, and so on).

**Note:** MobileFirst Operational Analytics logs the iPhone model number. On iOS, two different values are reported for the device model: the generation and the hardware identifier string. The hardware identifier string comes from Cordova, while the generation comes from the app instance registration. Due to this difference, you might see some iOS device models in the Analytics Console being referred to by either string.

- Device OS version (6.2, 4.2.2, and so on).

Extra information that is captured during a client/network communication includes:

- Response times for adapter calls.
- Response payload sizes for adapter calls.

### Server Logs

Normal MobileFirst Server activity produces log messages that are saved to the disk. These messages are also forwarded to the IBM MobileFirst Platform Operational Analytics and can be searched.

### Client Logs

Client devices can be configured to capture log data and crash events to be forwarded to the MobileFirst Server. For more information, see “Manually captured data.”

### Notification Activities

Upon a successful push notification, a notification activity is automatically sent to the IBM MobileFirst Platform Operational Analytics.

**Note:** No data is sent to the MobileFirst Server until the application is connected to the server. A connection to the server can be achieved by calling `WL.Client.connect()`. A connection to the server is also done automatically on the first successful call to an adapter in the MobileFirst Server.

## Manually captured data

The following data must be captured manually by changing the client application.

### Client Logs

The following example shows how to create client logs to be sent to the IBM MobileFirst Platform Operational Analytics.

Native iOS applications:

```
#import "OCLogger.h"

// Set logging level (default level is FATAL).
[OCLogger setLevel:OCLogger_DEBUG];

// Create a new instance of the logger and log the message.
OCLogger *logger = [OCLogger getInstanceWithPackage:@"MyPackage"];
[logger debug:@"This message is persisted locally until it is sent to the server"];

// Call the 'send' method explicitly to send the logs to the MobileFirst Server
[OCLogger send];
```

For more information about capturing client-side logs, see “Client-side log capture configuration from MobileFirst Operations Console” on page 8-305.

All persisted client-side logs are sent automatically upon a successful initialization (successful session start) with the MobileFirst Server. An explicit API is provided if you want to send the logs more frequently.

#### Client Network Activities

Network activities for client devices are captured and persisted on the device automatically. However, they are only sent when the client successfully initializes with the MobileFirst Server (successful session start).

#### Collecting Analytics for Network Connections to other servers

All network communications to the MobileFirst Server are logged and collected for analytics as part of MobileFirst Operational Analytics. To enable collection of network analytics to servers other than the MobileFirst Server, use `WLResourceRequest` provided in IBM MobileFirst Platform Foundation for iOS. This API exists for native iOS, native Android, and hybrid applications. For example:

```
//Android
WLResourceRequest resourceRequest = null;

try{
    /**
     * No java.util.logging.Logger method calls are captured until the
     * com.worklight.common.Logger.setContext(Context) method is called
     */
    //Logger.setContext(activity);

    resourceRequest = new WLResourceRequest(new URI("http://myserverurl.com/"), "GET");

    resourceRequest.send(new WLHttpResponseListener() {
        @Override
        public void onSuccess(HttpResponse httpResponse) {

            String responseBody = null;

            try {

                responseBody = EntityUtils.toString(httpResponse.getEntity());

            } catch (IOException e) {}

        }

        @Override
        public void onFailure(HttpResponse httpResponse, Exception e) {
            // request completed with an error
        });
    } catch (URISyntaxException e) {}
```

#### Analytics Logging

The client-logging feature enables developers to create logs to help debug problems and capture errors. A separate API exists for creating logs that are not meant for problem detection and capture:

```
WL.Analytics.log( object, message );
```

For example:

```
WL.Analytics.log( { "hello": "world" } , "This is an analytics log" );
```

Logs that are created by the client-side logger are only captured based on the logging level that is set. For example, `DEBUG` logs are not captured

when the logging level is set to FATAL. However, logs that are produced by `WL.Analytics.log` are always captured, despite the current logging level.

The metadata object that is passed into this method is searchable. However the Analytics console does not make further use of the object beyond the custom activities that are shown next. The primary purpose of the metadata object is to allow you to log custom JSON objects if you want to export analytics data into their own custom tool.

### Crash reports

If you want uncaught exceptions recorded and sent to IBM MobileFirst Platform Operational Analytics in your native iOS application, you can do so by registering an uncaught exception handler.

```
NSSetUncaughtExceptionHandler(&unCaughtExceptionHandler);
```

Then you can implement your uncaught exception handler, utilizing `OCLogger` to record information about the exception.

```
static void unCaughtExceptionHandler(NSException *e) {  
    [[OCLogger getInstanceWithPackage:@"example.package"] fatal:@"Uncaught Exception: %@. Reason: %@", e.name, e.reason];  
}
```

Note that the logs will not get sent to the server until the application is restarted and connects to the MobileFirst Server.

### Custom Activities

The operational analytics console provides a page to view analytics for custom activities. These activities can be created on the client-side by the `WL.Analytics` API. Using the `_activity` key in the object for the `WL.Analytics` call creates a new activity on the server. For example:

```
WL.Analytics.log( { "_activity" : "myCustomActivity" } );
```

creates a new activity in the IBM MobileFirst Platform Operational Analytics that can be searched on the Activities page of the analytics console.

### Client configurations

No additional client configurations are needed for client devices to forward analytics data to the MobileFirst Server.

The Analytics Optional Feature is not required to be enabled on the client for analytics in IBM MobileFirst Platform Foundation for iOS V7.0.0.

The `analyticsEnabled` flag in the `initOptions.js` file is not required to be enabled on the client for analytics in IBM MobileFirst Platform Foundation for iOS V7.0.0.

These configurations are only necessary if you are using the previous analytics platform (IBM SmartCloud Analytics Embedded). If you are using the new IBM MobileFirst Platform Operational Analytics in IBM MobileFirst Platform Foundation for iOS V7.0.0, then these properties can be ignored.

### Event types

Data that is sent to the MobileFirst Operational Analytics is categorized into an event type.

Operational Analytics contains the following event types:



- Application Activities
- Custom Activities
- Client Logs
- Network Activities
- Notification Activities
- Security Activities
- Server Logs

## Application Activities

Table 12-6. Application Activity Properties

Property Name	Description
activity	Name of the activity being logged. Only populated when the logActivity method is called
adapter	Name of the adapter
deviceId	Unique device identifier
deviceModel	Device model name. For example: iPhone3,3
deviceOs	Device operating system version. For example: 7.0
environment	Device environment. For example: iPhone
gadgetName	Name of the MobileFirst application
gadgetVersion	Version of the MobileFirst application
ipAddress	IP address of the client
procedure	Name of the adapter procedure called
sessionId	Unique identifier for the HTTP session made with the server
serverContext.context	Context root of the MobileFirst Server
serverContext.ip	Host name and address of the MobileFirst Server
timestamp	Time that the event was reported in milliseconds
useragent	User agent header

## Custom Activities

Table 12-7. Custom Activity Properties

Property Name	Description
deviceId	Unique device identifier
deviceModel	Device model name. For example: iPhone3,3
deviceOs	Device operating system version. For example: 7.0
environment	Device environment. For example: iPhone
gadgetName	Name of the MobileFirst application
gadgetVersion	Version of the MobileFirst application
sessionId	Unique identifier for the HTTP session made with the server

Table 12-7. Custom Activity Properties (continued)

Property Name	Description
serverContext.context	Context root of the MobileFirst Server
serverContext.ip	Host name and address of the MobileFirst Server
timestamp	Time that the event was reported in milliseconds

In addition to the default properties logged, any custom events sent to the MobileFirst Operational Analytics by the `WL.Analytics.log` method will also become a property of the custom activities event.

## Client Logs

Table 12-8. Client Log Properties

Property Name	Description
deviceId	Unique device identifier
deviceModel	Device model name. For example: iPhone3,3
deviceOs	Device operating system version. For example: 7.0
environment	Device environment. For example: iPhone
gadgetName	Name of the MobileFirst application
gadgetVersion	Version of the MobileFirst application
level	Level at which the log was recorded. For example: WARN, DEBUG
message	Message content of the log event
package	Package the log was recorded from
sessionId	Unique identifier for the HTTP session made with the server
serverContext.context	Context root of the MobileFirst Server
serverContext.ip	Host name and address of the MobileFirst Server
timestamp	Time that the event was reported in milliseconds

## Network Activities

Table 12-9. Network Activity Properties

Property Name	Description
adapter	Name of the adapter. null if the activity was not a result of an adapter request
bytesReceived	The number of bytes that were returned from the server to the client
deviceId	Unique device identifier
deviceModel	Device model name. For example: iPhone3,3
deviceOs	Device operating system version. For example: 7.0

Table 12-9. Network Activity Properties (continued)

Property Name	Description
endTime	The time stamp of the return of the network request to the client
environment	Device environment. For example: iPhone
gadgetName	Name of the MobileFirstapplication
gadgetVersion	Version of the MobileFirst application
path	Context path of network request. This can contain the full URL.
procedure	Name of the adapter procedure called. null if the activity was not a result of an adapter request
responseTime	Time taken for an adapter call to complete
sessionId	Unique identifier for the HTTP session made with the server
serverContext.context	Context root of the MobileFirst Server
serverContext.ip	Host name and address of the MobileFirst Server
startTime	The time stamp of the start of the network request to the client
timestamp	Time that the event was reported in milliseconds
trackingid	Global tracking identifier used to correlate the client request to the backend request

## Notification Activities

Table 12-10. Notification Activity Properties

Property Name	Description
gadgetName	Name of the MobileFirstapplication
gadgetVersion	Version of the MobileFirst application
mediator	Name of the push service (APNS, GCM, MPNS)
serverContext.context	Context root of the MobileFirst Server
serverContext.ip	Host name and address of the MobileFirst Server
timestamp	Time that the event was reported in milliseconds
eventSource	The eventsource of the notification as configured by the client

## Security Validations

Table 12-11. Security Validation Properties

Property Name	Description
deviceId	Unique device identifier
deviceModel	Device model name. For example: iPhone3,3

Table 12-11. Security Validation Properties (continued)

Property Name	Description
deviceOs	Device operating system version. For example: 7.0
endTime	The time stamp of the return of the network request to the client
environment	Device environment. For example: iPhone
gadgetName	Name of the MobileFirstapplication
gadgetVersion	Version of the MobileFirst application
authenticator	Package and class name of the authenticator
clientId	Unique client identifier
globalTrackingId	Unique network tracking identifier
loginModule	Package and class name of login module
loginModuleName	Name of the login module
origin	Origin of the reported event
realmName	Name of the realm that is protecting the event
resourceUrl	The URL used to access the protected resource
securityTestName	Name of the security test
sessionId	Unique identifier for the HTTP session made with the server
serverContext.ip	Host name and address of the MobileFirst Server
success	Boolean indicating if the authentication to the protected resource was successful
timestamp	Time that the event was reported in milliseconds
validationCode	A detailed code representing the success or failure of validation, often providing a reason for the failure

## Server Logs

Table 12-12.

Property Name	Description
log.sourceClass	Name of the class that recorded the log
log.sourceMethodName	Name of the method that recorded the log
log.level	Level at which the log was recorded. For example: WARN, DEBUG
log.loggerName	Name of the logger used to record the log
log.message	Message content of the log event
log.throwable.stacktrace	Stack trace associated with the log event
log.throwable.message	Message content associated with the throwable log event
serverContext.context	Context root of the MobileFirst Server

Table 12-12. (continued)

Property Name	Description
serverContext.ip	Host name and address of the MobileFirst Server
timestamp	Time that the event was reported in milliseconds

## Navigating the Analytics console

Learn how to use features provided by the MobileFirst Operational Analytics console.

### Administration:

Learn about the administrative aspects of the IBM MobileFirst Platform Operational Analytics.

### Cluster information:

The **Cluster information** section provides a list of properties about the state of the cluster.

Table 12-13. Cluster information properties

Property Name	Description
Cluster Name	The unique name of the cluster that this node is a member of. Any node that joins the cluster must have the same cluster name set.
Cluster Status	Indicates the status of the cluster as GREEN, YELLOW, or RED. Green means all shards and replicas have been assigned and allocated. Yellow indicates that all primary shards have been allocated but some replicas have not. Red indicates that a shard has not been allocated in the cluster.
Number of Nodes	Total number of nodes in the cluster.
Number of Master Nodes	Total number of master eligible nodes in the cluster.
Number of Data Nodes	Total number of non-master eligible nodes in the cluster (only holds data and processes queries, cannot be elected as a master node).
Number of Active Shards	Number of primary and replica shards that have been assigned.
Number of Primary Shards	Number of primary shards (not including replicas).
Number of Unassigned Shards	Number of shards that have not yet been allocated. This number will be greater than zero if there are too many replica shards.

### *Update Settings:*

The **Update Settings** page allows you to change settings dynamically. Typically these settings would need to be set via JNDI properties and require a server restart.

You can change these settings dynamically:

- Replicas Per Shard
- Document Time To Live settings

For more information about the **Replicas Per Shard** setting, see “Properties and configurations” on page 12-71.

For more information about **Time To Live** settings, see “Data purging.”

### *Multi-tenancy:*

Learn about multi-tenancy in the IBM MobileFirst Platform Operational Analytics.

Several MobileFirst Server instances can be configured to send analytics data to the same analytics cluster. All of the data is indexed together, which means that all charts and queries that are performed on the analytics server reflect data that was sent from every MobileFirst Server. If you want to use the same analytics cluster for multiple MobileFirst Server instances, but also want the data to be indexed separately so that it can be searched and viewed separately, you can add a tenant.

Servers can be configured to send their data to a new tenant on the analytics cluster so that the data can be viewed separately, even though all of the data lives on the same cluster.

To forward data to a different tenant, append the following format to the `wl.analytics.url` property on the MobileFirst Server:

```
?tenant=<tenant-name>
```

For example, if you want to send data to the default tenant, set the `wl.analytics.url` property as follows:

```
wl.analytics.url=http://host.ibm.com/analytics-service/data
```

If you want to send data to a new tenant that is named `test`, set the `wl.analytics.url` property as follows:

```
wl.analytics.url=http://host.ibm.com/analytics-service/data?tenant=test
```

To view the analytics data for a specific tenant, append the same format to the URL for the analytics console:

```
http://host.ibm.com/analytics/console?tenant=test
```

### *Data purging:*

Learn about data purging in the IBM MobileFirst Platform Operational Analytics.

By default, data that is stored in the Analytics Platform is not automatically deleted. To enable automatic purging of data, the time to live (TTL) property must be set for each data type.

The TTL for analytics data types that are stored in the Analytics Platform can be set by using JNDI properties. For more information about analytics data types, see “Operational analytics” on page 12-8.

The following table shows the TTL properties:

*Table 12-14. TTL properties for purging data that is stored in the Analytics Platform.* This table lists TTL property names and description for purging data that is stored in the Analytics Platform.

Property Name	Description
app_activities_ttl	Time to live for app activities, such as session starts, adapter hits, and network hits.
notification_activities_ttl	Time to live for notification activities, such as push notifications.
client_logs_ttl	Time to live for client logs, such as client-side captured logs, and stack traces.
server_logs_ttl	Time to live for server logs.

**Note:** All JNDI properties must be preceded with the analytics/ string. For more information about JNDI properties, see “JNDI properties” on page 12-71.

By default, the format for the TTL is in milliseconds. TTL can also be set by using a number followed by a character that represents the time interval:

- d (days)
- m (minutes)
- h (hours)
- ms (milliseconds)
- w (weeks)

The following example shows how to set the app activities data TTL to one day in milliseconds:

```
<jndiEntry jndiName="analytics/app_activities_ttl" value="86400000" />
```

The following example shows how to set the client logs data TTL to five days:

```
<jndiEntry jndiName="analytics/client_logs_ttl" value="5d" />
```

The following example shows how to set the server logs TTL to one week:

```
<jndiEntry jndiName="analytics/server_logs_ttl" value="1w" />
```

**Note:** The TTL properties are not applied to data that already exists in the Analytics Platform. You must set the TTL properties before you add data.

*Exporting raw reports:*

Learn about exporting raw reports in the IBM MobileFirst Platform Operational Analytics.

### Exporting from the Administration page

You can export all of the data that is stored in the analytics platform from the **Administration** page in one of the following formats:

- JSON

- CSV
- XML

This page is a user interface that displays the export feature and allows for the following options:

*Table 12-15.*

Option name	Description
Event Type	Name of the event that data is exported from. For specific information about each of the events, see “Event types” on page 12-12.
Date Range	Start and end date for exporting data.
Limit	Number of analytics documents returned.
Offset	Number of documents to skip before you export.
Data Format	Format data is exported in (JSON, CSV, or XML).

When an event type is selected from the user interface, you can select **Advanced Settings**. You can apply extra filters to the data you are exporting.

### Exporting from a URL

Raw analytics data can be exported from the IBM MobileFirst Platform Operational Analytics for the following types of data:

- Application session data
- Adapter invocation data
- JSONStore operation data

This data can be exported through a REST API that is exposed by the IBM MobileFirst Platform Operational Analytics. Currently, the supported export formats include JSON and CSV.

### Exporting application sessions

The following example shows the format for exporting analytics data for application sessions:

```
/export/{tenant}/sessions/{days}/{gadgetName}/{gadgetVersion}/{env}/{model}/{os}/{limit}/{offset}/{accept}
```

You can place a \* character for {gadgetName}, {gadgetVersion}, {env}, {model}, and {os} only. Explicit values for {tenant}, {days}, {limit}, {offset}, and {accept} must be provided.

If the analytics console is hosted here:

```
http://hostname.ibm.com:9080/analytics
```

Then, session data can be exported by invoking the following link:

```
http://hostname.ibm.com:9080/analytics/data/export/{tenant}/sessions/{days}/{gadgetName}/{gadgetVersion}/{env}/{model}/{os}/{limit}/{offset}/{accept}
```

For example, by using the curl command-line tool:

```
curl "http://hostname.ibm.com:9080/analytics/data/export/worklight/sessions/30/TestApp*/iphone*/7.0/100/0/csv"
```

This previous curl command exports data from the tenant that is named worklight for all versions of the application that is called TestApp for the last 30 days. It



returns only data for the iPhone environment, for all models of the iPhone, and only for iOS 7.0. It returns the first 100 results that are found and start with the first result (limit = 100, offset = 0).

**Note:**

- The default tenant is `worklight`. If you did not configure a specific tenant for the IBM MobileFirst Platform Operational Analytics, then use `worklight`.

**Exporting adapter invocations**

The following example shows the format for exporting analytics data for adapter invocations:

```
/export/{tenant}/adapters/{days}/{adapter}/{procedure}/{gadgetName}/{gadgetVersion}/{env}/{model}/{os}/{limit}/{offset}/{accept}
```

You can place a `*` character for `{adapter}`, `{procedure}`, `{gadgetName}`, `{gadgetVersion}`, `{env}`, `{model}`, and `{os}` only. Explicit values for `{tenant}`, `{days}`, `{limit}`, `{offset}`, and `{accept}` must be provided.

For example, by using the curl command-line tool:

```
curl "http://hostname.ibm.com:9080/analytics/data/export/worklight/adapters/10/UploadAdapter/uploadProcedure/TestApp/1.0/iphone/iphone 5/4.4/10/0/csv"
```

**Exporting JSONStore operation data**

The following example shows the format for exporting analytics data for JSONStore operation data:

```
/export/{tenant}/jsonstore/{days}/{gadgetName}/{gadgetVersion}/{env}/{model}/{os}/{collection}/{operation}/{limit}/{offset}/{accept}
```

You can place a `*` character for `{gadgetName}`, `{gadgetVersion}`, `{env}`, `{model}`, `{os}`, `{collection}`, and `{operation}` only. Explicit values for `{tenant}`, `{days}`, `{limit}`, `{offset}`, and `{accept}` must be provided.

For example, by using the curl command-line tool:

```
curl "http://hostname.ibm.com:9080/analytics/data/export/worklight/jsonstore/100/*/*/iphone/*/*/people/add/100/50/csv"
```

**Custom Analytics:**

Starting with V7.0.0, you can visualize the collected analytics data in your analytics repository. This is a powerful way to inspect data for specific use cases. You can create charts with data already collected by Operational Analytics in addition to custom data you report.

The ability to report custom data (custom key-value pairs) from the IBM MobileFirst Platform Foundation for iOS has been present since V6.1.0, and now you can extract that data in raw form, as well as render custom charts from that raw data.

*Creating a custom chart:*

MobileFirst Operational Analytics has several pre-made charts with useful visualizations. Starting with V7.0.0, you can create a different chart type or run a specific query to render into a table.

### About this task

In this scenario, you create a bar chart for all active Android Galaxy devices.

### Procedure

1. Click on the **Custom Charts** tab from the Dashboard section of the console.

*Figure 12-1. Analytics Dashboard*

2. Click the **Add New Chart** button. This opens a **Chart Definition** tab where you specify your visualization parameters.

*Figure 12-2. Chart Definition*

- a. Enter a chart title.
  - b. Choose the event type. For this scenario, choose Network Activities.
  - c. Choose a chart type. For this scenario, choose **Bar Graph**.
  - d. Select **Axis as Timeline** for the x-axis.
  - e. Select **Unique Count** for the y-axis.
  - f. Select **Device Id** for the property.
3. Click on the **Filters** tab to specify filters for the data.

*Figure 12-3. Filters*

- a. Select the data type to filter. For this scenario, choose **Device Model**.
- b. Select the value to filter on. For this scenario, choose **galaxy**.
- c. Click the **Add Filter** button.

Repeat steps 1-3 for all filters you want to apply. For this scenario, we do not need any more filters.

### What to do next

For more advanced usage, see “Patterns for visualizing custom data” on page 12-37.

*Custom chart types:*

The IBM MobileFirst Platform Operations Console offers the following chart types for data visualization.

- Bar Graph
- Flow Chart
- Line Graph
- Metric Group
- Pie Chart
- Table

**Note:** The following sections only contain information about custom chart types that may not be familiar.

### Flow Chart:

The flow chart can be used to show relationships between two different properties.

Three selections must be made to use the flow chart:

- A source key
- A destination key
- A value from either the source or destination keys

If you want to see the relationship between an adapter and its procedures, you select **Adapter Name** as the source and **Procedure Name** as the destination. You then select one of the adapters as the value.

Chart Definition   Filters   Chart Properties

**Chart Title**  
Enter Chart Title

**Select Event Type**  
Application Activities

**Select Chart Type**  
Flow Chart

**Select Source Key**      **Select Destination Key**      **Select Property**

Adapter Name      Procedure Name      CheckoutAdapter

Figure 12-4. Adapter-Procedure chart definition

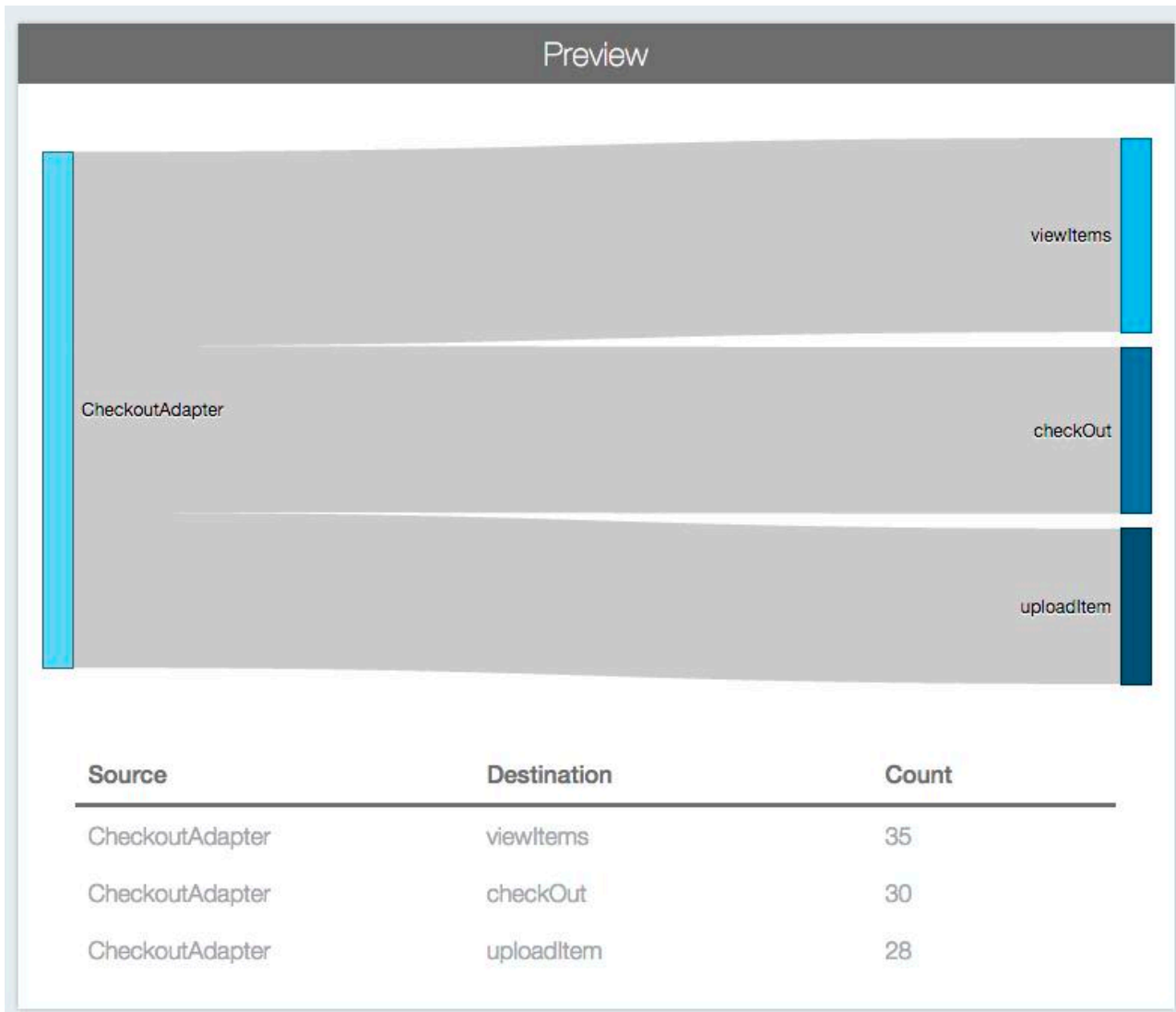

Figure 12-5. Adapter-Procedure Flow Chart

The CheckoutAdapter adapter is the source on the left and its three procedures are on the right. The line next to each procedure represents a relationship between the source and each of its destinations. The length of this line is relative to the frequency at which that procedure was invoked. In this case, all three of the CheckoutAdapter procedures were called about the same number of times. A table is displayed below with the exact values of each relationship.

The flow chart is best used with custom data. In this example, you have several pages in your application and would like to know about how your users are navigating between each page. You can add the following calls to your application:

```
function pageTransition1(){
    var event = {
        src: 'page1'
        dst: 'page2'
    };

    WL.Analytics.log(event, 'Custom event for page transition');
}

function pageTransition2(){
```

```

var event = {
  src: 'page2'
  dst: 'page3'
};

WL.Analytics.log(event, 'Custom event for page transition');
}

```

You can use this information to create a flow chart representing how users navigated through your application. The keys used for your source and destination fields will automatically show up as an option after selecting the Custom Activities event type.

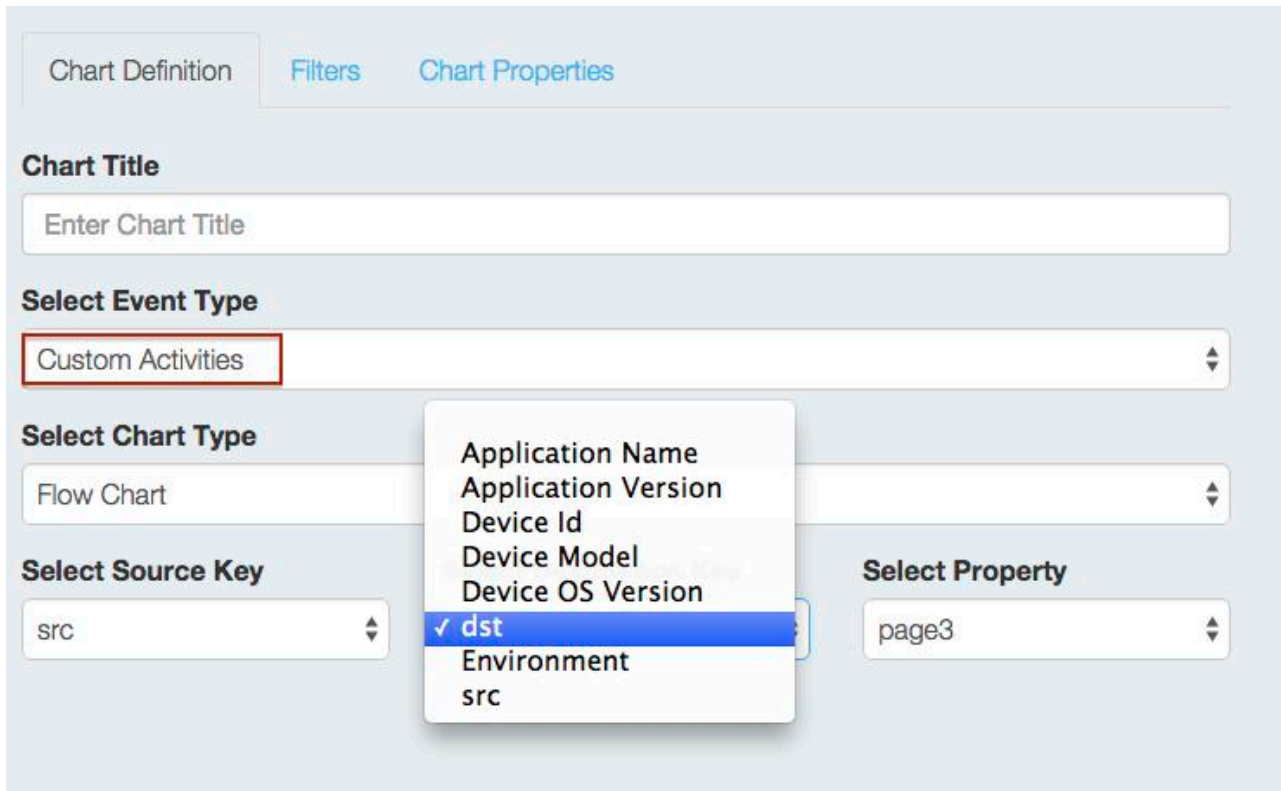

Figure 12-6. Page Transition Chart Definition

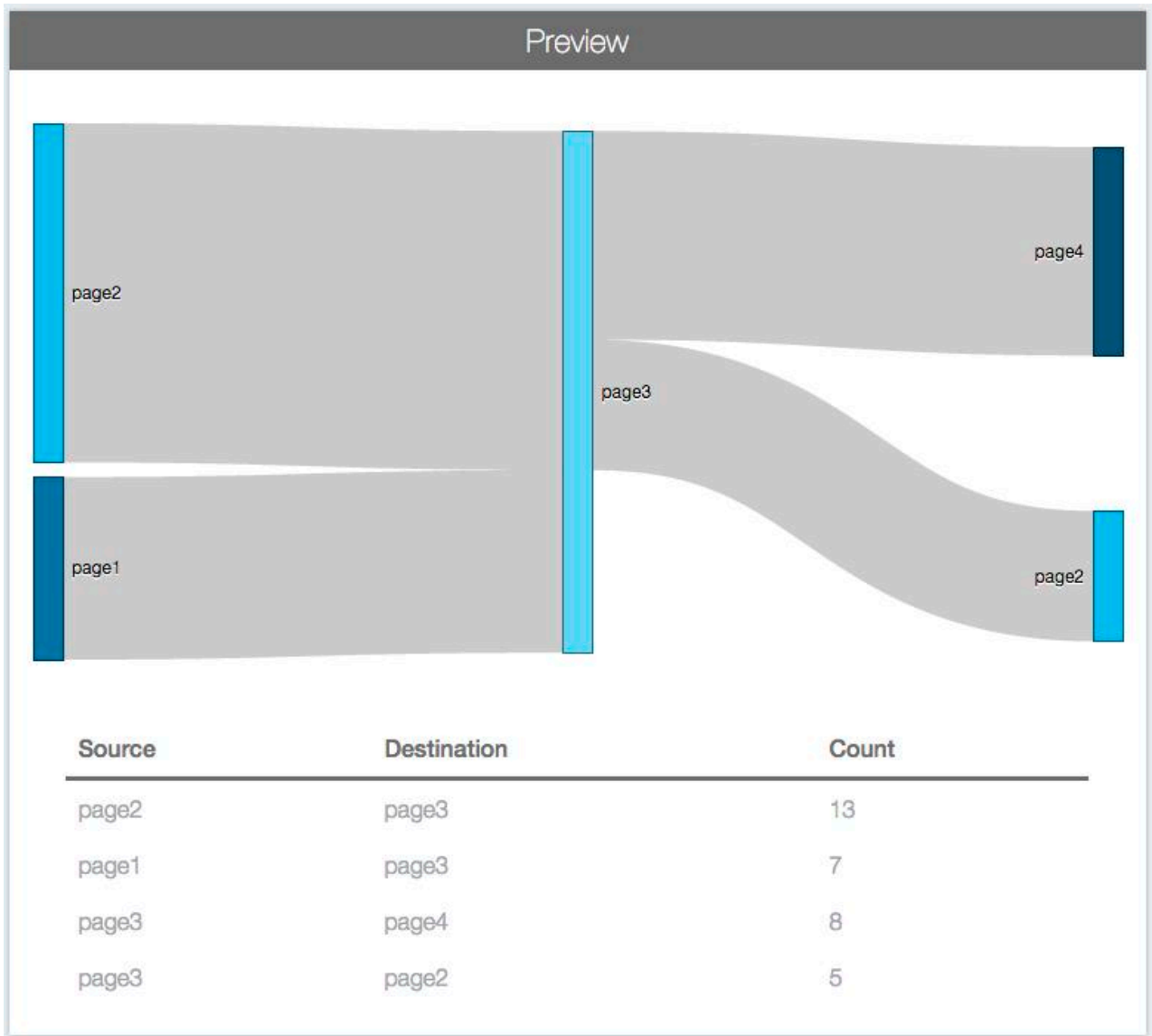

Figure 12-7. Page Transition Flow Chart

The chart displays the relationships between page transitions with 'page3' as the main value. Notice that 'page3' is both a source and a destination. This means you can see how users got to page 3 in addition to what pages users went to after leaving page 3. You can see in this example that most users came to 'page3' from 'page2.' After that, some users moved to 'page4' but others went back to 'page2.'

*Metric Group:*

The Metric Group chart is used to display a single numerical value.

This value can be:

- A total or sum of events
- An average of a specified property
- A unique count

If you want to see an at-a-glance view of how many unique devices have contacted your server, you can make the following selections.

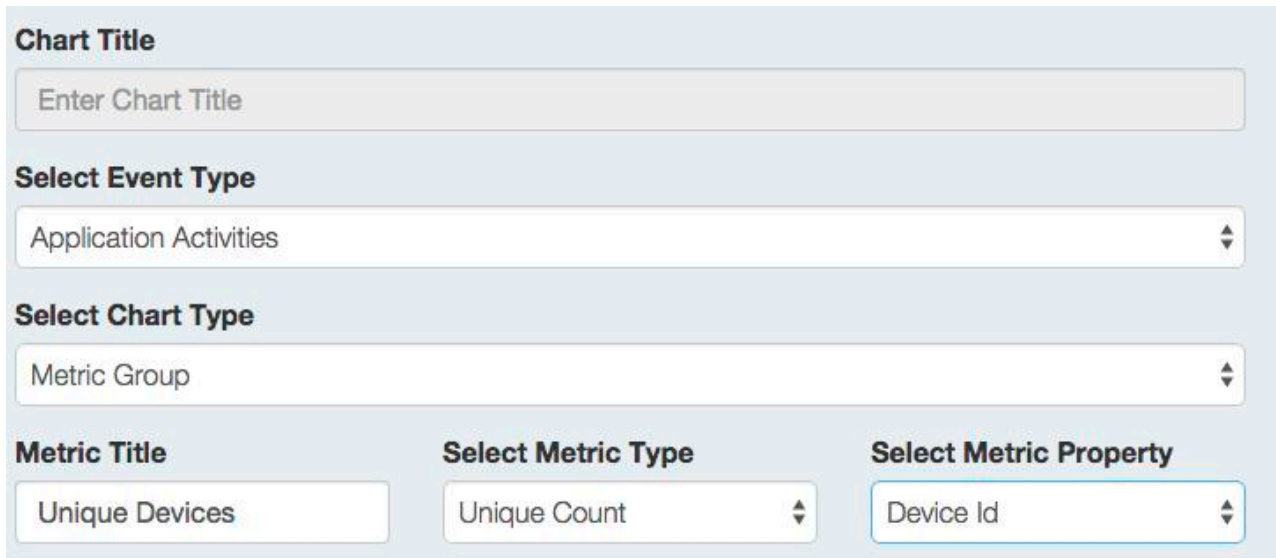

The screenshot shows a configuration form for a chart. It includes a text input for the chart title, a dropdown for event type (Application Activities), a dropdown for chart type (Metric Group), and three dropdowns for metric configuration: Metric Title (Unique Devices), Select Metric Type (Unique Count), and Select Metric Property (Device Id).

Figure 12-8. Unique Devices chart definition

The following chart is created:



Figure 12-9. Unique Devices Metric Group Chart

In this example, you would like to know the average amount of time a user spends on a particular page of your application. When the user enters a page, you begin recording the start time. When the user exits, you make the following method call:

```
function logPageTime(pageTime){  
  var event = {  
    pageTimeInSeconds: pageTime  
  }  
}
```

```

};
WL.Analytics.log(event, 'Custom event time spent on page');
}

```

MobileFirst Operational Analytics contains several of these events with varying numbers that depend on the amount of time each user has spent on a particular page. You can use the metric group chart to calculate the average for all of the events stored:

The screenshot shows a configuration interface for a chart. It includes the following elements:

- Chart Title:** A text input field containing "Enter Chart Title".
- Select Event Type:** A dropdown menu with "Custom Activities" selected.
- Select Chart Type:** A dropdown menu with "Metric Group" selected.
- Metric Title:** A text input field containing "Average Page Time".
- Select Metric Type:** A dropdown menu with "Average" selected.
- Select Metric Property:** A dropdown menu with "pageTimeInSeconds" selected.

Figure 12-10. Page Time chart definition

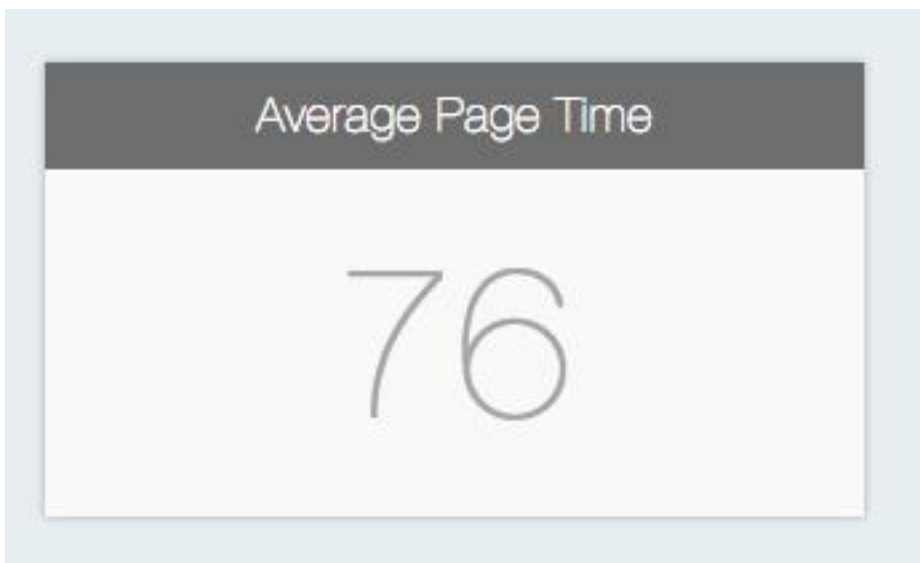

Figure 12-11. Page Time Metric Group Chart

*Filters:*

When creating a custom chart, you can apply filters to the results from the **Filters** tab.



As discussed in “Event types” on page 12-12, each event type has a set of properties. You can apply the following filters for any of these properties:

- Equals/Not Equals
- Exists/Not Exists
- Greater Than/Greater Than or Equal
- Less Than/Less Than or Equal

You create a bar chart displaying the number of application activities for each day. You want to see the number of activities that were made by iPhone devices. You can apply the 'Equals' filter to your chart:

Figure 12-12. Environment Filter

### Custom Filters

Several filters can be applied to the same chart, but all of these filters are applied. For example, if you wanted to see application activities for iPhone and Android devices, and you added an Equals filter for both environments, the resulting query would search for activities where the environment is iPhone and the environment is Android. This query returns zero results since each activity can only have one environment property. To create more complex predicates for queries, you must use the custom filters feature.



Figure 12-13. Custom Filters

The following filter only selects documents where the environment is iPhone:

```
doc['environment'].value=='iphone'
```

Conversely, this filter will do the opposite and only select documents where the environment is not iPhone:

```
doc['environment'].value!='iphone'
```

You can do other logical comparisons, like greater than and less than:

```
doc['timestamp'].value<1418277600000
```

In addition to logical expressions, you can combine filters using Boolean expressions. You can filter on documents where the environment is Android or iPhone:

```
doc['environment'].value=='android' || doc['environment'].value=='iphone'
```

You can further group these filters using parenthesis. You can combine the last filter with a limitation to retrieve all documents before a certain date:

```
doc['timestamp'].value<1418277600000 && (doc['environment'].value=='android' || doc['environment'].value=='iphone')
```

You can extract other data from a document field besides its value. For example, `doc['field_name'].values` is the native array values of the field, and `doc['field_name'].empty` is a Boolean indicating if the field has no values within the document. For a detailed description of all the documents and their fields, refer to. For a list of all available expressions, see Elastic Search scripting documentation

*Patterns for creating custom charts:*

Each of the following sections contains a subsection explaining how to populate data, which typically involves calling some APIs on the client.

For more information about the different types of data that are collected, see “Event types” on page 12-12.

**Note:** Some APIs, such as `connect` and `invokeProcedure` will send analytics information automatically without having to use the analytics send API. However, this is only true if you call `connect` and `invokeProcedure` 60 seconds apart. This is done to limit the number of requests to the server. For example, when calling multiple adapters in the span of a single minute, it is better to "batch send" the analytics information. For testing purposes, it is recommended to always call the analytics send API explicitly.

*Client Logs:*

Client logs contain log information sent with the platform's Logger API. This also includes contextual information about the device, including environment, application name, and application version.

### **Before you begin**

If you are using the `WL.Client.logActivity` API, replace those calls with `WL.Analytics.log`, otherwise you will not be able to create custom charts from the information you are logging.

**Note:** The steps that follow use JavaScript APIs. If you are using a native application, you must use the native versions of these APIs.

### **About this task**

In this example, you will use client log data to create a flow chart. The final graph will show the distribution of log levels in a specific application. You will also have the following data available to show in a chart:

- Specific data
  - Log level
  - Message
  - Package
- Message data
  - Timestamp
- Environment Contextual data
  - Application name
  - Application version
  - Environment
- Device Contextual data

- Device Id
- Device model
- Device OS version

### Procedure

1. Create a new hybrid application.
2. Populate data by calling `WL.Logger.log('Hello world!')` or any of the other Logger APIs. Then call `WL.Logger.send()`.
3. Go to the Analytics console and select the **Custom Charts** tab. This allows you to create a chart based on the analytics messages you sent to the server.
4. Select **+ Add New Chart** to create a custom chart.
5. Provide the following values when adding the new chart:
  - **Chart Title:** Application and Log Levels
  - **Event Type:** Client Logs
  - **Chart Type:** Flow Chart
  - **Source:** Application Name
  - **Destination:** Level
  - **Property:** your application name
6. Click **Save New Chart**.

### Results

*Figure 12-14. Application and Log Levels*

#### *Network Activities:*

Network activities contain information about network requests such as network request time and bytes received by the client. This also includes contextual information about the device, such as environment, application name, and application version.

#### **About this task**

In this example, you will use network activity data to create a line chart. The graph will show how the number of bytes received from the client on the server changes over time. All the values in a single day are averaged. You will also have the following data available to show in a chart:

- Specific data
  - Adapter name
  - Procedure name
  - Adapter response time (in milliseconds)
  - Bytes received
  - Server (for example: `dallas.ibm.com/9.64.77.98`)
  - URL path (for example: `/wlproj/apps/services/api/wlapp/iphone/query`)
- Message data
  - Timestamp
- Environment Contextual data
  - Application name

- Application version
- Environment
- Device Contextual data
  - Device Id
  - Device model
  - Device OS version

### Procedure

1. Create a new hybrid application.
2. Populate data
  - a. Call `WL.Client.connect()`.
  - b. Create an adapter with a procedure.
    - `helloWorldAdapter-impl.js`

```
function sayHello() {
    return {hello: 'world'};
}
```
    - `helloWorldAdapter.xml`

```
<procedure name="sayHello"/>
```
  - c. Call `WL.Client.invokeProcedure()` to invoke a procedure on the newly created adapter. The parameters include anything required to contact your adapter. The example below uses an adapter that returns a simple `{hello: 'world'}` object when invoked from the client.
    - `main.js`

```
WL.Client.invokeProcedure({
    adapter : 'helloWorldAdapter',
    procedure : 'sayHello',
    parameters : []
})
.then(function (res) {
    console.log(JSON.stringify(res, null, ' '));
})
```
  - d. Call `WL.Analytics.send()`.
3. Go to the Analytics console and select the **Custom Charts** tab. This allows you to create a chart based on the analytics messages you sent to the server.
4. Select **+ Add New Chart** to create a custom chart.
5. Provide the following values when adding the new chart:
  - **Chart Title:** Average Bytes Received
  - **Event Type:** Network Activities
  - **Chart Type:** Line Graph
  - **X-Axis:** Timeline
  - **Y-Axis:** Average
  - **Property:** Bytes Received
6. Click **Save New Chart**.

### Results

*Figure 12-15. Average Bytes Received*

### *Notification Activities:*

Notification activities contain information about push notifications.

#### **About this task**

In this example, you will use the notification activities information to create a table. The table will show a timestamp and the mediator (for example, APNS is Apple Push Notification Service). You will also have the following data available to show in a chart:

- Specific data
  - Mediator (APNS, MPNS, GCM)
  - Event source
- Message data
  - Timestamp

#### **Procedure**

1. Create a new hybrid application.
2. Set up push notifications. For more information, see “Setting up push notifications” on page 8-206.
3. Go to the Analytics console and select the **Custom Charts** tab. This allows you to create a chart based on the analytics messages you sent to the server.
4. Select **+ Add New Chart** to create a custom chart.
5. Provide the following values when adding the new chart:
  - **Chart Title:** Table of Push Notifications
  - **Event Type:** Notification Activities
  - **Chart Type:** Table
6. Add the following columns: Timestamp and Mediator
7. Click **Save New Chart**.

#### **Results**

*Figure 12-16. Table of Push Notifications*

### *Security Validations:*

Security activities contain information about network requests such as network request time and bytes received by the client.

#### **About this task**

In this example, you will use the security activity information to create a pie chart. The graph will show the realms being hit by a specific application. You will also have the following data available to show in a chart:

- Specific data
  - Authenticator name
  - Client ID
  - Login Module class
  - Login Module name
  - Origin

- Realm name
- Security Test name
- Success (true/false)
- Tracking ID
- Validation code
- Server (for example: dallas.ibm.com/9.64.77.98)
- Resource URL (for example: http://dallas.ibm.com:10080/wlproj/apps/services/api/wlapp/iphone/heartbeat)
- Message data
  - Timestamp
- Environment Contextual data
  - Application name
  - Application version
  - Environment
- Device Contextual data
  - Device Id
  - Device model
  - Device OS version

### Procedure

1. Create a new hybrid application.
2. Populate data
  - a. Call `WL.Client.connect()`.
  - b. Create an adapter with a procedure.
  - c. Call `WL.Client.invokeProcedure()` to invoke a procedure on the newly created adapter. The parameters include anything required to contact your adapter. The example below uses an adapter that returns a simple `{hello: 'world'}` object when invoked from the client.
    - `helloWorldAdapter-impl.js`

```
function sayHello() {
    return {hello: 'world'};
}
```
    - `helloWorldAdapter.xml`

```
<procedure name="sayHello"/>
```
    - `main.js`

```
WL.Client.invokeProcedure({
    adapter : 'helloWorldAdapter',
    procedure : 'sayHello',
    parameters : []
})
.then(function (res) {
    console.log(JSON.stringify(res, null, ' '));
})
```
  - d. Call `WL.Analytics.send()`.
3. Go to the Analytics console and select the **Custom Charts** tab. This allows you to create a chart based on the analytics messages you sent to the server.
4. Select **+ Add New Chart** to create a custom chart.
5. Provide the following values when adding the new chart:
  - **Chart Title:** Realms called for [your application name]

- **Event Type:** Security Activities
  - **Chart Type:** Pie Chart
  - **Property:** Realm name
6. Click the **Filters** tab and select the following:
    - **Filter** Application name
    - **Operator:** Equals
    - **Value:** [your application name]
  7. Click **Add Filter**.

**Note:** You can use the filter section to exclude the default realms (the realms that start with wl\_). For example, to exclude wl\_anonymousUserRealm, add a filter for **Realm Name** with an operator of **Equals** and a value of wl\_anonymousUserRealm.

8. Click **Save New Chart**.

## Results

Figure 12-17. Realms Called for WlApp

*Server Logs:*

Server logs contain internal server logs.

### About this task

In this example, you will use the server log information to create a metric group. The metric will show the number of log messages on the server that are categorized as severe by their corresponding log level property. You will also have the following data available to show in a chart:

- Specific data
  - Log level
  - Message
  - Logger name
  - Source class
  - Server (for example: dallas.ibm.com/9.64.77.98)
  - Source
  - Source method
  - Thread Id
  - URL path (for example: /wlproj/apps/services/api/wlapp/iphone/query)
- Message data
  - Timestamp

### Procedure

1. Create a new hybrid application.
2. Populate data
  - a. Call `WL.Client.connect()`.
  - b. Create an adapter with a procedure.
    - helloWorldAdapter-impl.js

- ```
function sayHello() {
    return {hello: 'world'};
}
```
- helloWorldAdapter.xml
 

```
<procedure name="sayHello"/>
```
- c. Call `WL.Client.invokeProcedure()` to invoke a procedure on the newly created adapter. The parameters include anything required to contact your adapter. The example below uses an adapter that returns a simple `{hello: 'world'}` object when invoked from the client.
    - main.js
 

```
WL.Client.invokeProcedure({
    adapter : 'helloWorldAdapter',
    procedure : 'sayHello',
    parameters : []
})
.then(function (res) {
    console.log(JSON.stringify(res, null, ' '));
})
```
  - d. Call `WL.Analytics.send()`.
3. Go to the Analytics console and select the **Custom Charts** tab. This allows you to create a chart based on the analytics messages you sent to the server.
  4. Select **+ Add New Chart** to create a custom chart.
  5. Provide the following values when adding the new chart:
    - **Event Type:** Metric Group
    - **Metric Title:** Total Severe Log Count
  6. Click **Add Metric**.
  7. Click the **Filters** tab and select the following:
    - **Filter:** Level
    - **Operator:** Equals
    - **Value:** SEVERE
  8. Click **Add Filter**.
  9. Click **Save New Chart**.

## Results

Figure 12-18. Total Severe Log Count

*Creating a custom chart with custom data:*

To collect custom data, configure your application codebase with the Analytics API.

### About this task

In this scenario, you will create a pie chart representing the relative frequency of user button clicks.

### Procedure

1. Create a MobileFirst application. For this scenario, attach functions to the JavaScript `onClick` event listeners for buttons in your user interface. These functions will be instrumented to report analytics. The `WL.Analytics.log` method takes an object and a message as parameters. The message is used for



searching for this custom event in the **Search** page of the Analytics console. The object is used to collect data for custom analytics charting.

```
function buttonA(){
  var event = {buttonPress: 'buttonA'};
  WL.Analytics.log(event, 'Custom event for button A press');
}

function buttonB(){
  var event = {buttonPress: 'buttonB'};
  WL.Analytics.log(event, 'Custom event for button B press');
}

function buttonC(){
  var event = {buttonPress: 'buttonC'};
  WL.Analytics.log(event, 'Custom event for button C press');
}

function buttonD(){
  var event = {buttonPress: 'buttonD'};
  WL.Analytics.log(event, 'Custom event for button D press');
}

function sendAnalytics(){
  WL.Analytics.send();
}
```

The `sendAnalytics` function is a convenience for demonstration purposes only. The values for keys passed to the `WL.Analytics.log` method can only be strings and numbers. Objects and arrays can be passed as values, but will not be used when creating custom charts. The event object in each method is used to create custom charts. `buttonPress` is the key used to generate data for each chart. The values for this key are `buttonA`, `buttonB`, `buttonC`, and `buttonD`.

2. Create a custom chart. For more information on custom charts, see “Creating a custom chart” on page 12-21

When a device sends the analytics to the server, the key becomes available in

Figure 12-19. Chart Definition

the **Select Property** field for chart creation and filters.

*Patterns for visualizing custom data:*

You can instrument your IBM MobileFirst Platform Foundation for iOS V7.0.0 applications to collect and visualize analytics data, allowing you to continuously understand application usage and target improvements.

### Prerequisites

Ensure that you are familiar with the `WL.Analytics` API and “Operational analytics” on page 12-8.

### Patterns

When developing mobile applications, you can track key actions over time that can provide useful insight. The patterns below will explain how to track various interesting data points and chart them in different ways.

Many visualizations can be created following two patterns. The first pattern involves recording and sending information as it gets created. For example, a user

completes a registration form. The second pattern involves accumulating and calculating information on the client-side before calling the analytics API to record and send that information to the server. For example, the amount of time elapsed between two actions.

#### *Single events:*

The single event pattern involves sending a single piece of information as it becomes available.

One example of a single event pattern is tracking new user registrations. After the user has successfully completed the application's registration form, tracking this gives insight about how many people are registering for your application over time.

#### *New User Registrations Over Time:*

##### **Procedure**

1. Create a new MobileFirst hybrid application. These instructions use the JavaScript versions of the `log` and `send` APIs. If you want to work with a native application instead, use the native versions of `log` and `send`.
2. Write the following code to generate four `newSignup` events:

```
WL.Analytics.log({ newSignup: 'username' + Math.random() }, 'newSignup');
WL.Analytics.log({ newSignup: 'username' + Math.random() }, 'newSignup');
WL.Analytics.log({ newSignup: 'username' + Math.random() }, 'newSignup');
WL.Analytics.log({ newSignup: 'username' + Math.random() }, 'newSignup');
```

This locally stores a JSON object with information about the new registrations, which is a few random user names in this case. The second parameter in the `log` function is a useful string to search for log messages. However, for the creation of custom charts, this parameter is irrelevant. The example uses the same key as the object being recorded.

3. Send analytics data to the server with the following function:

```
WL.Analytics.send();
```

This function detects all analytics messages that are locally stored, sends them to the server, and removes the local copy after successfully sending them.

4. In the MobileFirst Operational Analytics console, click the **Custom Charts** tab. This allows you to create a chart based on the analytics messages that were sent to the server.
5. Click **+ Add New Chart** to create a new custom chart.
6. Provide the following values:
  - **Chart Title:** New Registrations
  - **Event Type:** Custom Activities
  - **Chart Type:** Line Graph
  - **X-Axis:** Timeline
  - **Y-Axis:** Unique
  - **Property:** newSignup
7. Click **Save New Chart**.

## Results

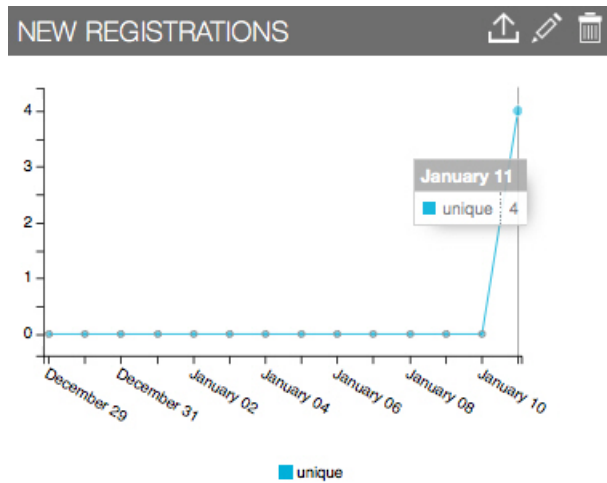

Figure 12-20. New User Registrations Over Time

### *New Registrations and Environment Table:* **Before you begin**

Complete steps 1-5 in “New User Registrations Over Time” on page 12-38.

### **About this task**

In this example, you will create a table of new registered users and what environment they are using.

### **Procedure**

1. Provide the following values when adding the new chart:
  - **Chart Title:** New Registrations and Environment Table
  - **Event Type:** Custom Activities
  - **Chart Type:** Table
2. Add the following columns to the table: newSignup and Environment
3. Click **Save New Chart**.

## Results



The screenshot shows a table with the title "NEW REGISTRATIONS AND ENVIRONMENT TABLE". The table has two columns: "newSignup" and "Environment". There are three rows of data. Below the table, there are navigation buttons: "Prev", "1", and "Next".

newSignup	Environment
username0.926847874885425	common
username0.5535091191995889	common
username0.20171857974492013	common

Figure 12-21. New Registrations and Environment Table

### What to do next

At this point, you can export the data shown in the table to use with other applications. For more information on exporting data, see “Exporting custom data” on page 12-47.

*New Registrations Metric:*

Another way to represent new user registration data is with a metric group chart.

### Before you begin

Complete steps 1-5 in “New User Registrations Over Time” on page 12-38.

### Procedure

1. Provide the following values when adding the new chart:
  - **Event Type:** Custom Activities
  - **Chart Type:** Metric Group
2. Add the following Metric information:
  - **Metric Title:** Registrations
  - **Metric Type:** Unique
  - **Metric Property:** newSignup
3. Click **Add Metric**.
4. Click **Save New Chart**.
5. Use the **Data Filters** drop-down menu on the **Custom Charts** page to see the number of registrations for a specific time interval. For example, the last 14 days.

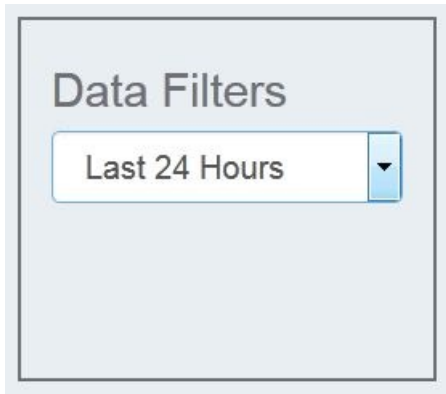

Figure 12-22. Data Filters menu

The filter applies to all the data being presented in the Analytics Console, not just the Metric in this particular example.

### Results

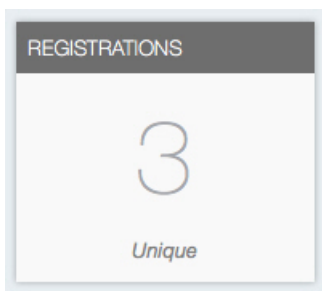

Figure 12-23. New Registrations Metric Group

*Check-out Results:*

#### About this task

You can also visualize data as a pie chart. This example shows the percentage of successful check-outs and failure check-outs.

#### Procedure

1. Create a new MobileFirst hybrid application.
2. Write the following code to generate four successful check-out events and two failures:

```
WL.Analytics.log({checkout: 'success'}, 'checkout');
WL.Analytics.log({checkout: 'success'}, 'checkout');
WL.Analytics.log({checkout: 'success'}, 'checkout');
WL.Analytics.log({checkout: 'success'}, 'checkout');
WL.Analytics.log({checkout: 'failure'}, 'checkout');
WL.Analytics.log({checkout: 'failure'}, 'checkout');
```
3. Provide the following values when adding the new chart:
  - **Chart Title:** Check-out Result
  - **Event Type:** Custom Activities
  - **Chart Type:** Pie Chart
  - **Property:** checkout
4. Click **Save New Chart**.

## Results

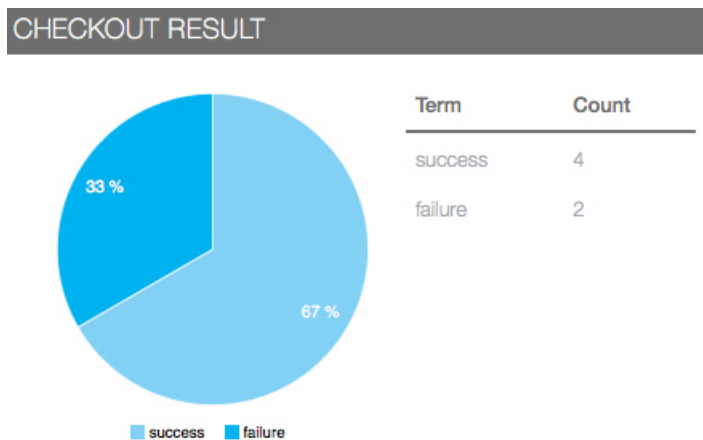

Figure 12-24. Check-out Results

### *Composed events:*

Some pieces of information are only meaningful after doing certain calculations on them.

Examples of composed events are tracking the length of a user session and how long it took a user to complete a specific task. The client portion of the application must record an initial value, such as the current date, wait for the user to complete the task of interest, and then record the amount of time that has passed between the initial value and the final value. The client then sends the result of that computation to the server.

The key difference between composed events and single events is that you cannot log `sessionStartTime` and `sessionEndTime` as they occur and have the server calculate the time spent between the two intervals to generate a meaningful chart.

In addition to time-based information, another use case for composed events is recording the source and destination page of a user's navigation through the application.

You can also record information about the user and augment analytics events that are sent to the server. For example, recording the users that used the application more than a certain number of times are considered active users. You can send information about the session, such as what country the user is in, and then filter by active users.

### *Session Length:*

#### **About this task**

In this example, you will take all the values recorded in single day, calculate the average, and plot them on a graph.

#### **Procedure**

1. Define what you consider a session. A session can be defined as the time interval that starts when the user logs in until the user logs out. Another way to define a session is to start the session when the user begins a process and

end the session when the process is complete. For this example, a session starts when the application enters the foreground and ends when the application goes into the background.

2. The application lifecycle callback methods depend on which environments you want to support. You can use the native versions of Analytics API for those environments. For simplicity, this example will log the amount of time spent on the session using the JavaScript API.

3. Add this code to your application:

```
function getSessionTotalTime(currentTime, startTime) {  
    return currentTime - startTime;  
}
```

```
WL.Analytics.log({'totalSessionTime' : getSessionTotalTime()}, 'totalSessionTime');
```

4. Send the analytics data to the server:

```
WL.Analytics.send();
```

5. From the **Custom Charts** tab of the Analytics console, click **+ Add New Chart**.

6. Provide the following values:

- **Chart Title:** Average Session Times
- **Event Type:** Custom Activities
- **Chart Type:** Bar Graph
- **X-Axis:** Axis as Timeline
- **Y-Axis:** Average
- **Property:** totalSessionTime

7. Click the **Chart Properties** tab and add a new threshold line with the following values:

- **Threshold Label:** SessionTimeGoal
- **Threshold Value:** 300

This will create a line at the value specified with the label. The goal is to show the daily average session time that is greater than 300 units of time.

## Results

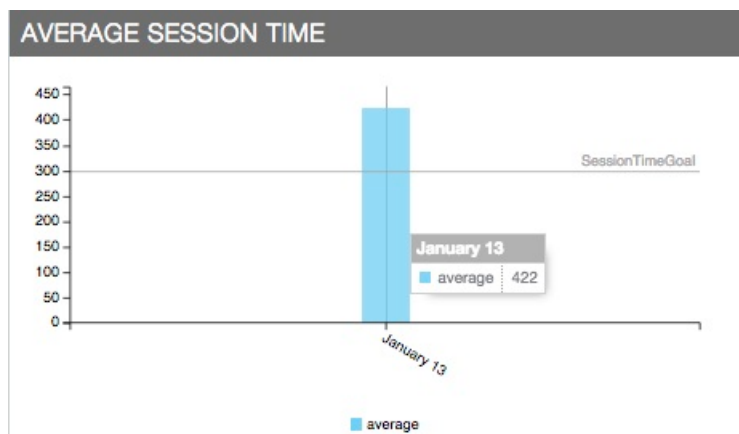

Figure 12-25. Session Length

### Page Flow:

You can gain insight about how users of your application reach and leave certain pages by tracking the source page and the destination page.

## About this task

In this example, you are recording how the user reaches the cart page of an application, and what pages the user moves to after leaving that page.

### Procedure

1. Create a new hybrid application.
2. Make the following calls to the log function.

```
WL.Analytics.log({sourcePage : 'home', destinationPage: 'cart'}, 'pageFlow');
WL.Analytics.log({sourcePage : 'home', destinationPage: 'cart'}, 'pageFlow');
WL.Analytics.log({sourcePage : 'product', destinationPage: 'cart'}, 'pageFlow');
WL.Analytics.log({sourcePage : 'product', destinationPage: 'cart'}, 'pageFlow');
WL.Analytics.log({sourcePage : 'cart', destinationPage: 'home'}, 'pageFlow');
WL.Analytics.log({sourcePage : 'cart', destinationPage: 'checkout'}, 'pageFlow');
```
3. Add a new chart and provide the following values:
  - **Chart Title:** Cart Page Flow
  - **Event Type:** Custom Activities
  - **Chart Type:** Flow Chart
  - **Source:** sourcePage
  - **Destination:** destinationPage
  - **Property:** cart
4. Click **Save New Chart**.

### Results

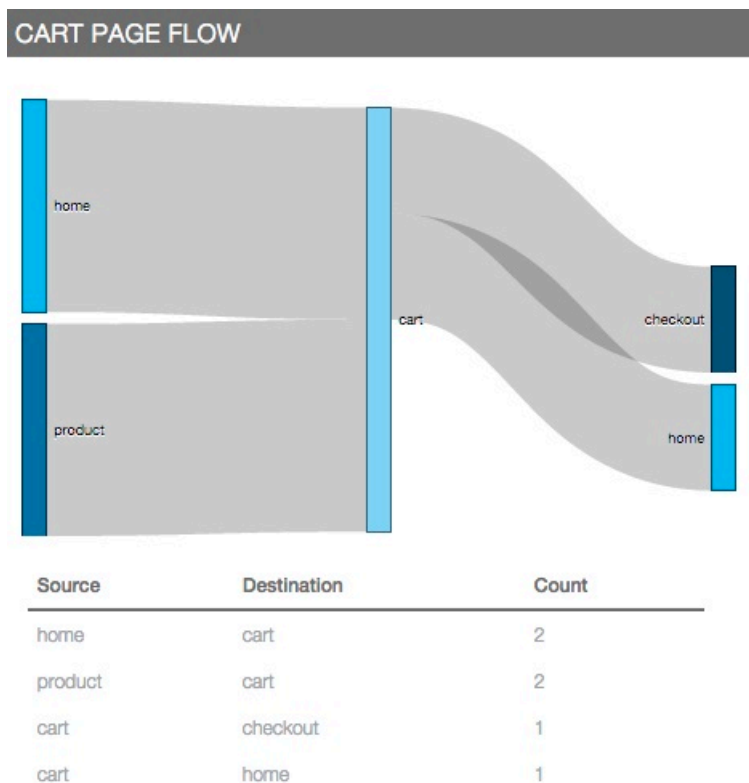

Figure 12-26. Cart Page Flow

*Regular Users and Geolocation:*



## About this task

In this example, you show the geographical locations of an application's regular users.

### Procedure

1. Define different types of users that are relevant to your application. For this example, use the following types of users:
  - **New:** The user has used the application less than 5 times.
  - **Regular:** The user has used the application 5 or more times.
2. When the application is started, you need to persist a counter with how many times the user has opened the application. This example uses HTML5 local storage, but you can use something more powerful, such as JSONStore. Use the following code to obtain the type of user:

```
var userVisit = localStorage.getItem('userVisit');
localStorage.setItem('userVisit', userVisit + 1);
var typeOfUser = (userVisit > 5) ? 'Regular' : 'New';
```

3. Send the following log messages:

```
WL.Analytics.log({type : 'New', geographicLocation: 'USA'}, 'visit');
WL.Analytics.log({type : 'New', geographicLocation: 'Mexico'}, 'visit');
WL.Analytics.log({type : 'New', geographicLocation: 'USA'}, 'visit');
WL.Analytics.log({type : 'Regular', geographicLocation: 'Mexico'}, 'visit');
WL.Analytics.log({type : 'Regular', geographicLocation: 'Canada'}, 'visit');
WL.Analytics.log({type : 'Regular', geographicLocation: 'USA'}, 'visit');
WL.Analytics.log({type : 'Regular', geographicLocation: 'USA'}, 'visit');
```

In a real application, do not hardcode values for type and geographicLocation. When getting the location, use strings instead of latitude longitude values.

4. Add a new chart with the following values:
  - **Chart Title:** Regular Users and Location
  - **Event Type:** Custom Activities
  - **Chart Type:** Flow Chart
  - **Source:** type
  - **Destination:** geographicLocation
  - **Property:** Regular
5. Save the chart.

## Results

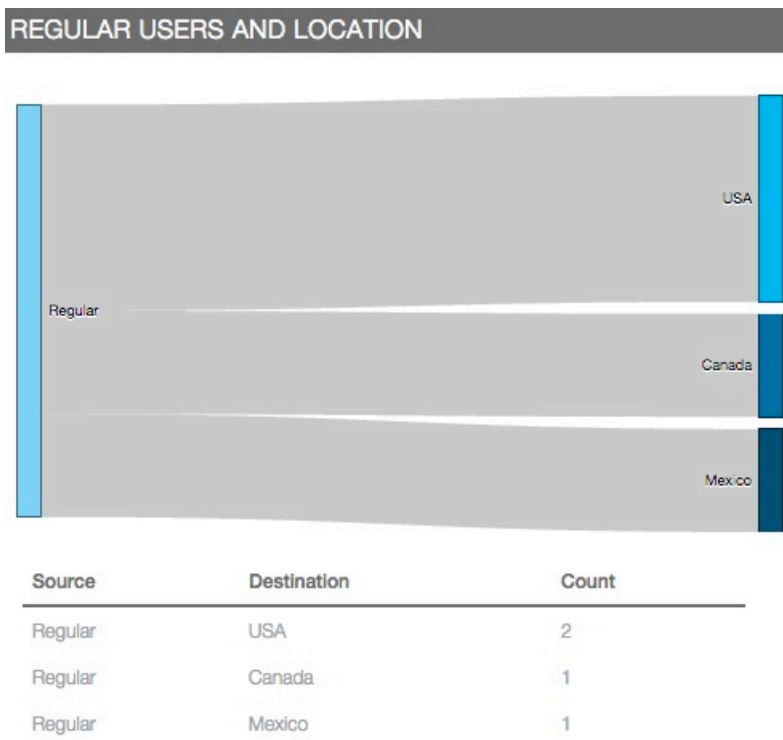

Figure 12-27. Regular Users and Location

*New Users and Location:*

### About this task

In this example, the chart will use the same information presented in “Regular Users and Geolocation” on page 12-44, but will show new users instead of regular users. Unlike that task, this example uses filters to limit the amount of information shown and uses a pie chart instead of a flow chart.

### Procedure

1. Follow steps 1-3 from “Regular Users and Geolocation” on page 12-44.
2. Add a new chart with the following values:
  - **Chart Title:** New Users and Location
  - **Event Type:** Custom Activities
  - **Chart Type:** Pie Chart
  - **Property:** geographicLocation
3. Go to the **Filters** tab and select the following:
  - **Filter:** type
  - **Operator:** Equals
  - **Value:** New
4. Save the chart.

## Results

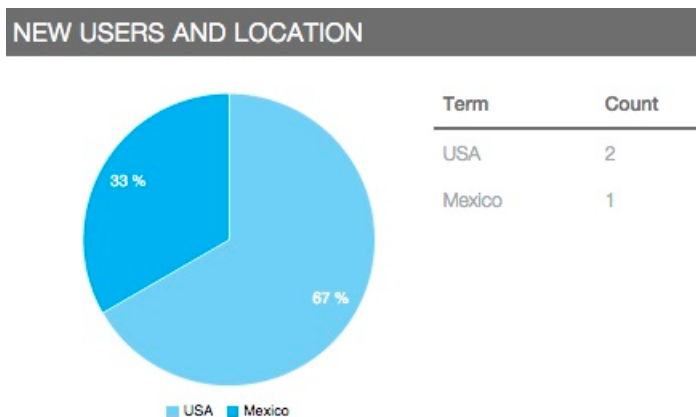

Figure 12-28. New Users and Location

### Exporting custom data:

The data from each custom chart can be exported into JSON, XML, or CSV format.

The structure of the exported data depends on the chart that is being exported. To export data, click the export icon at the upper right of the custom chart.

Figure 12-29. Exporting chart data

### Exporting and importing custom chart definitions:

If you are using the latest interim fix of MobileFirst, you can import and export custom chart definitions programmatically or manually in the IBM MobileFirst Platform Operational Analytics Console.

### Before you begin

Ensure that you have at least one custom chart in the IBM MobileFirst Platform Operational Analytics Console.

### About this task

In this example, you manually export and import custom chart definitions.

### Procedure

1. In the MobileFirst Analytics Console, click the **Custom Charts** tab in the Dashboard page.
2. To export the custom chart definitions, click **Export Charts**. This action displays a dialog to save a `customChartsDefinition.json` file.
3. Choose a location to save the file.
4. Click the **Delete Chart** icon next to each custom chart to delete all custom charts.
5. To import a custom chart definition, click **Import Charts**. This action displays a dialog to choose a file.

6. Choose the customChartsDefinition.json file that you previously exported to open.

## Results

You exported and imported a custom chart definition manually in the MobileFirst Analytics Console.

## What to do next

You can also export and import custom chart definitions programmatically by using your HTTP client of choice (for example, CURL or postman). The GET endpoint for export is `http://<hostname>:<port>/<context-root>/data/customCharts/apps/{appId}/exportChartDefinitions`. The POST endpoint for import is `http://<hostname>:<port>/<context-root>/data/customCharts/apps/{appid}/importChartDefinitions`. For example, if the context root was not changed from the default of analytics-service, the export endpoint is `http://myHost.com:9080/analytics-service/data/customCharts/apps/{appid}/exportChartDefinitions` and the import endpoint is `http://myHost.com:9080/analytics-service/data/customCharts/apps/{appid}/importChartDefinitions`. If the application is protected by basic authorization, all security requirements apply.

**Note:** If you import a custom chart definition that exists, you end up with duplicate definitions, which also means that the MobileFirst Analytics Console shows duplicate custom charts.

## Security Analytics:

Starting with V7.0.0, the MobileFirst Operational Analytics includes a **Security** tab.

## Overview of IBM MobileFirst Platform Foundation for iOS security

Applications and adapter procedures can be protected by a security test. The test includes one or more realms. Each Realm represents a specific security check. Some realms are already provided. For example, `wl_antiXSRFRealm` is used to avoid cross-site request forgery attacks. Other realms are defined by the developer based on their security needs.

The realms contain two key pieces of functionality: an Authenticator and a Login Module. The Authenticator gets some information from the user or device, such as a user name and password. The Login Module gets information from the Authenticator and validates it. An example of validation is checking the user name and password against a user registry.

For more information about security, see “MobileFirst security overview” on page 10-79.

## Example use case

1. A developer creates an adapter procedure. The procedure returns account information for a specific user.
2. Only valid users can access account information, so the developer protects the procedure with a security test. That adapter procedure is now a protected resource.

3. You can determine if a user is valid by contacting a user registry. The developer creates a realm and makes the authenticator the `FormBasedAuthenticator`. That authenticator will send a login form to the client and expect a response with the user name and password.
4. The Login Module is a Java class implemented by the developer. It contains code to contact a user registry on the backend using the credentials gathered by the `FormBasedAuthenticator`. There are two possible outcomes now:
  - a. If the user is valid, the security test passes and access to the protected resource (account information for the user) is granted.
  - b. If the security test fails, then the user is unable to access the protected resource. The cause of the failure might be incorrect credentials, failure to access the user registry due to a network error, exception on the server, or other causes.
5. If the user is valid, the security test passes and access to the protected resource (i.e. account information for the user) is granted. b) If the security test fails then the user is unable to access the protected resource. The cause of the failure might be one of the following: wrong credentials, failure to access the user registry due to a network error, exception on the server, among others.

### Potential use cases

The platform can be used to develop a banking application. The application allows users to log in using their bank's credentials. Successfully authenticated users can access their account information and perform various actions (such as transferring money between accounts). This authentication flow is similar to the flow described in the previous section.

### Network issues

If an application gets popular, more people are trying to access a protected resource (such as their account information). Using the **Security** tab of the Operational Analytics console, you notice a high failure rate on one of the realms. That realm is part of the security test used to allow users to log in and view their account information. The most common error under **Authenticator Failures** is an internal server error. One reason for this error is that the backend infrastructure (the number of servers) needs improvement to meet the increase in demand.

### Security threats

You notice that there is a high failure rate on one of the protected resources (such as account information). Looking at the **Authenticator Failures**, you notice the most common error is invalid credentials. That error gets returned when the client supplies an invalid user name or password. This might mean a hacker is attempting to access a protected resource by trying different credentials within short time intervals. Based on this information, you conclude that you should not allow users to try different credentials indefinitely. With the data provided by the analytics console, you decide to let users attempt 5 wrong credentials before asking users to wait a specific amount of time before allowing them to try again. The goal is to limit the effectiveness of a brute force attack.

### Application usability issues

In addition to using their user name and password to access the application and view their account balances, users also need to supply their bank's pin number to transfer money between accounts. You notice a high failure rate in the realm that

asks for the pin number. Looking at the **Authenticator Failures**, you notice the most common error is client interaction required. This means the server is expecting credentials (the pin number) but is not receiving them. This can be caused by a high percentage of users inability to understand the user interface. The users are not noticing that they need to send their pin number. Based on these findings, the page should be redesigned to solve that issue.

### Development defects

You are viewing security information from the last 24 hours and notice the failure rate for one of the realms is 100%, meaning that it always fails. This might result from a recent change introducing a regression that broke one of the realms. Another possibility, based on the realms provided by the platform, is that `wl_directUpdateRealm` is failing. This happens because of an issue with direct update. A third possibility is evident when an entry with [Unknown Realm] is displayed in the list of realms. This happens when there is a failure before one of the realms is reached. Having this information is especially useful when running an application in production.

## Securing the Operational Analytics server

Learn about security with the IBM MobileFirst Platform Operational Analytics.

### Protecting the analytics data entry point with basic authentication:

IBM MobileFirst Platform Operational Analytics is configured to protect the data entry point by using basic authentication.

### Default path protection

Data is sent from the MobileFirst Server to the IBM MobileFirst Platform Operational Analytics when the following IBM MobileFirst Platform Foundation for iOS property is set:

```
wl.analytics.url=http://<hostname>:<port>/analytics-service/data
```

The IBM MobileFirst Platform Operational Analytics exposes this path and it is protected by default using basic authentication (user name and password).

### Configuration of basic authentication

In the `analytics-service` WAR file, basic authentication is configured in the `WEB-INF/web.xml` file. The default configuration has the following structure:

```
<!-- SECURITY ROLES -->
<security-role>
  <role-name>worklightadmin</role-name>
</security-role>
<security-role>
  <role-name>worklightdeployer</role-name>
</security-role>
<security-role>
  <role-name>worklightmonitor</role-name>
</security-role>
<security-role>
  <role-name>worklightoperator</role-name>
</security-role>

<!-- SECURITY CONSTRAINTS -->
<security-constraint>
  <web-resource-collection>
    <web-resource-name>allAccess</web-resource-name>
```

```

        <url-pattern>/data/*</url-pattern>
    </web-resource-collection>
    <auth-constraint>
        <role-name>worklightadmin</role-name>
        <role-name>worklightdeployer</role-name>
        <role-name>worklightmonitor</role-name>
        <role-name>worklightoperator</role-name>
    </auth-constraint>
    <user-data-constraint>
        <transport-guarantee>NONE</transport-guarantee>
    </user-data-constraint>
</security-constraint>

<!-- AUTHENTICATION METHOD: basic auth -->
<login-config>
    <auth-method>BASIC</auth-method>
    <realm-name>worklightRealm</realm-name>
</login-config>

```

Four roles are created (worklightadmin, worklightdeployer, worklightmonitor, worklightoperator) and the data endpoint is protected from all requests made by authenticated users not belonging to one of these roles.

**Note:** These role names also exist in the analytics-ui WAR file, which must also be edited if roles are added or changed.

### Basic authentication credentials

In the worklight.properties file, set the wl.analytics.username and wl.analytics.password values for basic authentication. For more information about encrypting sensitive information in the worklight.properties file, see “Storing properties in encrypted format” on page 10-56. After this configuration, the IBM MobileFirst Platform Operational Analytics will not accept any incoming data unless the request also contains the correct credentials. When the wl.analytics.username and wl.analytics.password values are set, the MobileFirst Server uses these credentials when it forwards data to the IBM MobileFirst Platform Operational Analytics. For more information about IBM MobileFirst Platform Foundation for iOS properties, see “MobileFirst properties” on page 12-71.

**Note:** This configuration protects only the /data path that accepts incoming data. It does not protect the console.

### Ports that are used by the IBM MobileFirst Platform Operational Analytics:

When the IBM MobileFirst Platform Operational Analytics is started, it listens on port 9600.

#### Port 9500 - HTTP Port

This port can be used for HTTP requests that are made directly to the IBM MobileFirst Platform Operational Analytics. It is not required to be open and should not be accessible from outside the cluster. It is important to protect this port because foreign commands can be sent directly to the IBM MobileFirst Platform Operational Analytics through this port. This port is closed by default. You can open this port by setting the http.enabled JNDI property to true. For more information, see “Properties and configurations” on page 12-71.

#### Port 9600 - Transport Port

This port is used for communication between nodes in a cluster. This port

should be open to other nodes in the cluster for node communication to work properly. This port should also not be accessible from outside the cluster. This port is open by default.

These ports can be changed by using the following JNDI properties:

- httpport
- transportport

The following example shows how you can modify the ports.

```
<jndiEntry jndiName="analytics/httpport" value="9700" />  
<jndiEntry jndiName="analytics/transportport" value="9800" />
```

## Production deployment and clustering

Most of the clustering functionality and logic is handled by the IBM MobileFirst Platform Operational Analytics. It is not necessary to do any additional work to cluster the application server that the IBM MobileFirst Platform Operational Analytics is running on. The application servers are only necessary to host the IBM MobileFirst Platform Operational Analytics and do not require special configuration for clustering.

Creating an IBM MobileFirst Platform Operational Analytics cluster can be scoped down to the following steps:

1. Configure the master node or nodes.
2. Set the number of shards.
3. Set the number of replicas.
4. Add a node to the cluster.
5. Point the new node to the master node or nodes.

It is important to fully understand how the clustering works for the IBM MobileFirst Platform Operational Analytics before you create the cluster.

### Clustering terminology:

Learn about clustering terminology for the IBM MobileFirst Platform Operational Analytics.

#### Cluster

A collection of one or more master and data nodes.

#### Master Node

Coordinator of the cluster. Manages the distribution of shards and keeps track of all nodes in the cluster. There can be more than one master node. If a master node fails, then a new node that is marked as a master node is automatically elected as a new master node. The cluster cannot operate without at least one master node.

#### Data Node

Workhorse of the cluster. Stores data and processes incoming search and index requests. A node can act as both a data node and a master node.

**Shard** Each data node stores data in a shard. For more information about shards, see “Understanding shards” on page 12-53.

#### Replica shard

Each shard can have any number of replicas. Replicas are used to ensure high availability in the case that a node is no longer available. For more information about replicas, see “Understanding replicas” on page 12-59.



The following image shows a basic clustering topology:

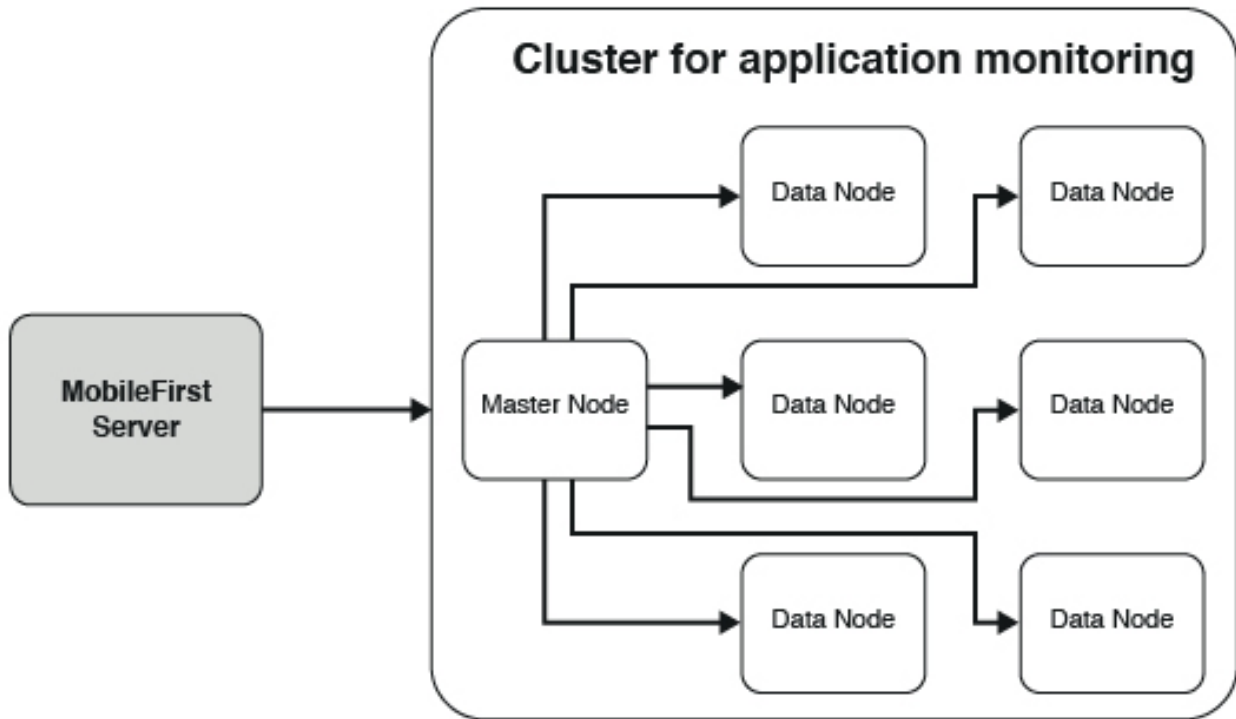

**Note:** Data can be forwarded from the MobileFirst Server to any node in the server. The MobileFirst Server does not have to point to a master node.

In development, a cluster that contains one node and one shard is sufficient. The single node acts as the master and data nodes.

In production, it is ideal to have multiple nodes that perform specific functions to ensure high availability and performance.

*Understanding shards:*

Learn about shards in the IBM MobileFirst Platform Operational Analytics.

It is important to carefully consider setting the number of shards when you set up a cluster. The number of shards can be set only once, by the first node in the cluster. If the number of shards must be changed later, you must completely reindex all of the data that is stores in the IBM MobileFirst Platform Operational Analytics.

Ideally, the number of shards is equal to the maximum number of nodes that the cluster eventually expands to. Because the maximum number of nodes that are needed is often unknown at installation time, it is a common practice to create more shards than needed.

The following images show how sharding works.

Here is a cluster with one node and six shards. Because there is only one node, all six shards live on the same node. The single node handles all requests and data

processing.

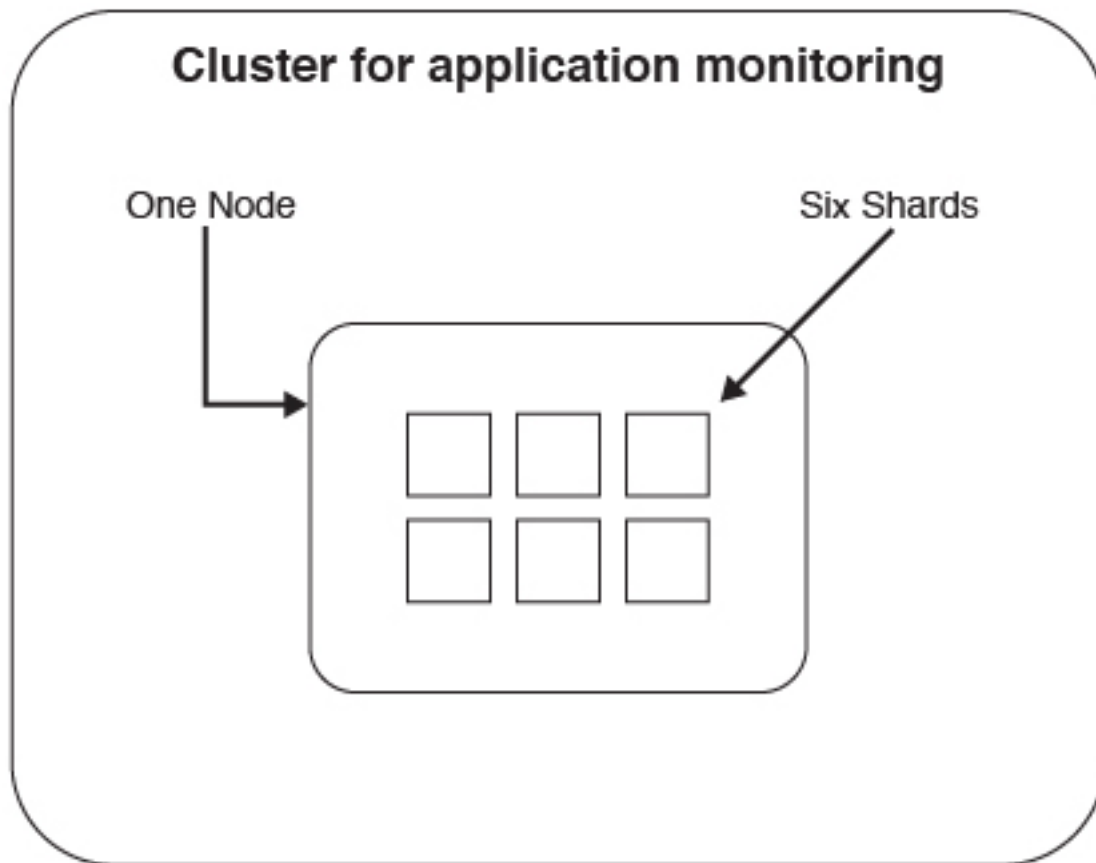

After several months of use, requests that are made to the cluster begin to perform poorly. It is determined that a single node is no longer adequate to handle processing for all of the incoming data. A new node is added to the cluster.

After a new node is added, the shards are automatically evenly distributed across all of the nodes.

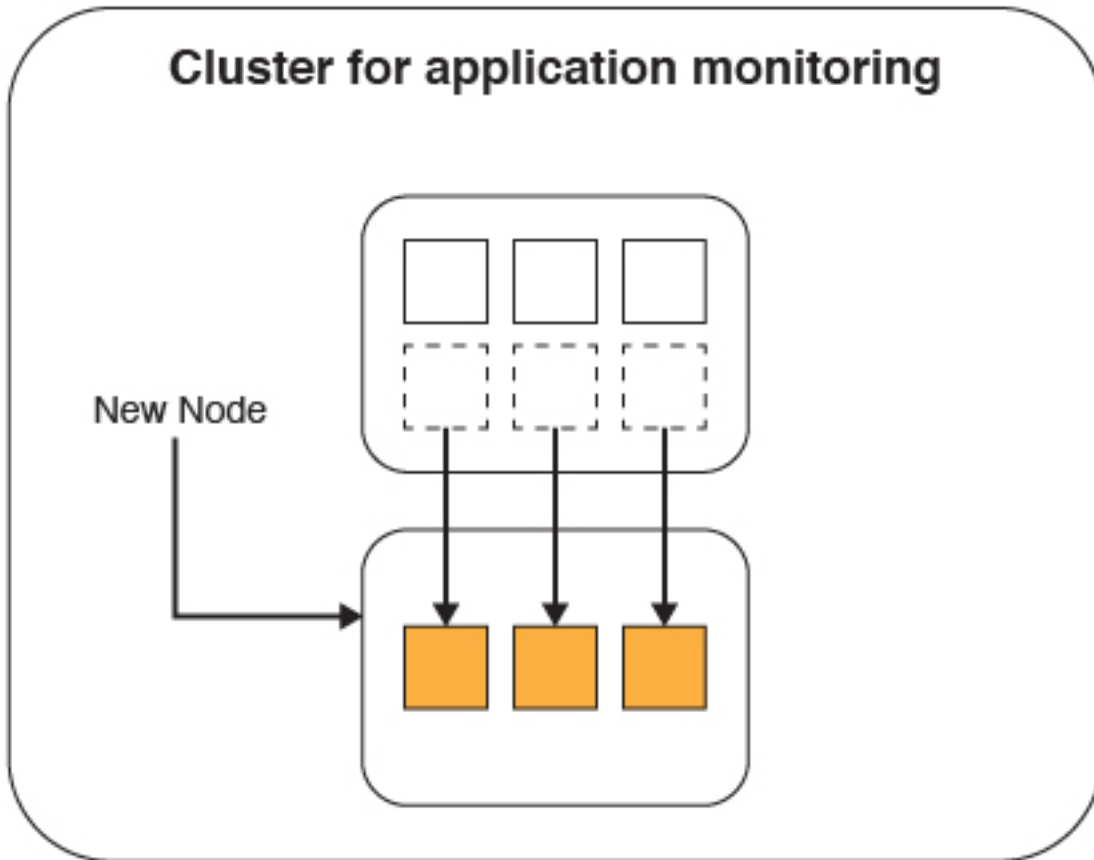

Now when a request comes in to either node, the request is forwarded to the node that has the shard that contains the data. The data indexing and processing is now split between the two nodes. Because the requests and data processing is now split between the nodes, the performance and response times improve.

## Cluster for application monitoring

Requests split between the two nodes

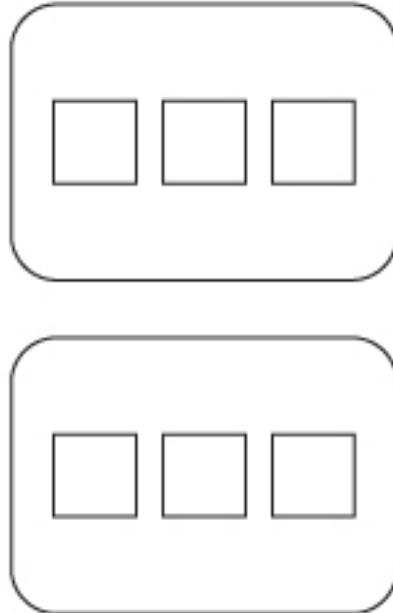

After several months, requests begin to slow down again, and it is determined that a third node is required.

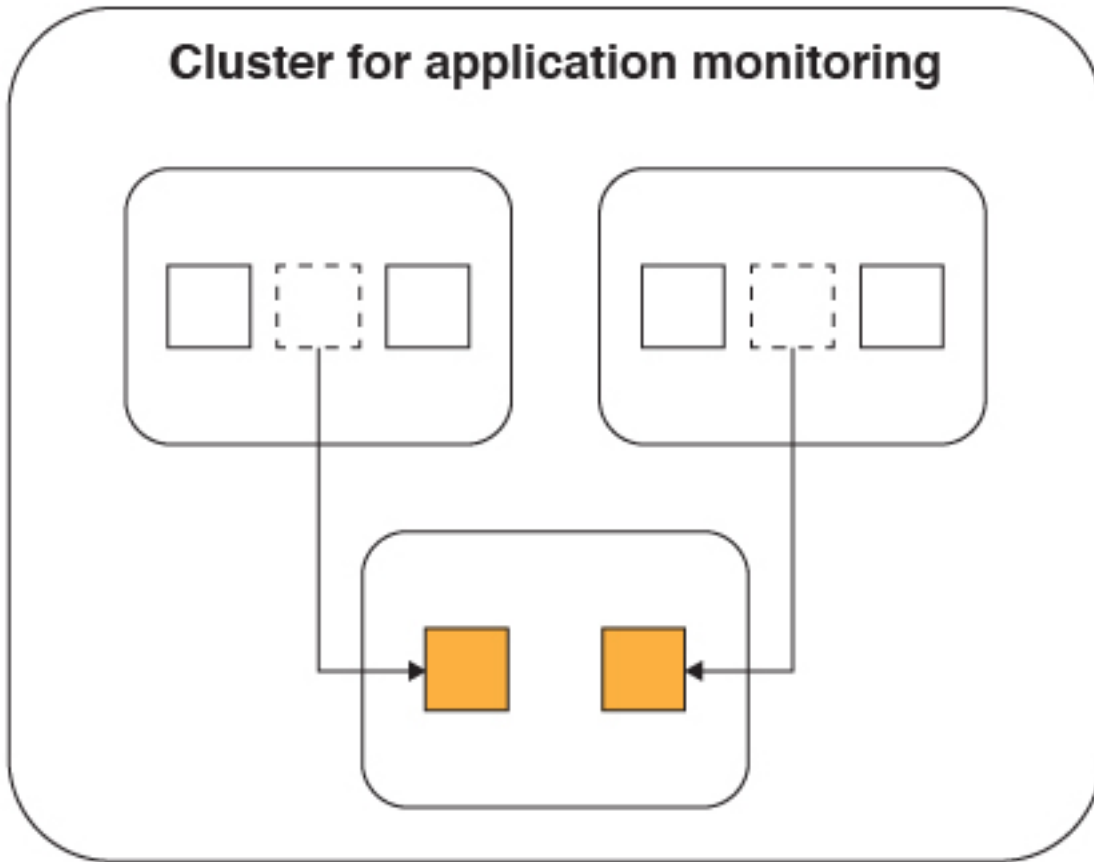

The shards are split between the three nodes.

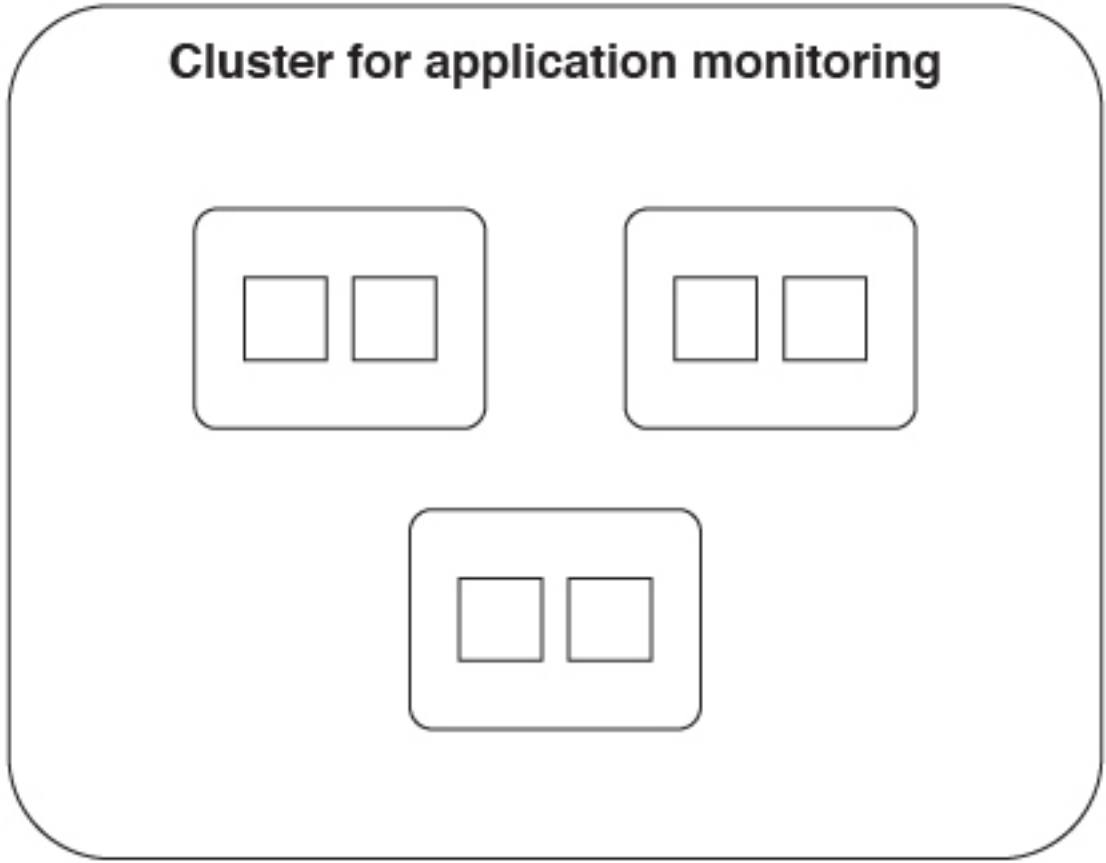

This process repeats itself until there are six nodes, which each contains one shard. It is now no longer possible to add more nodes because each shard contains only one node.

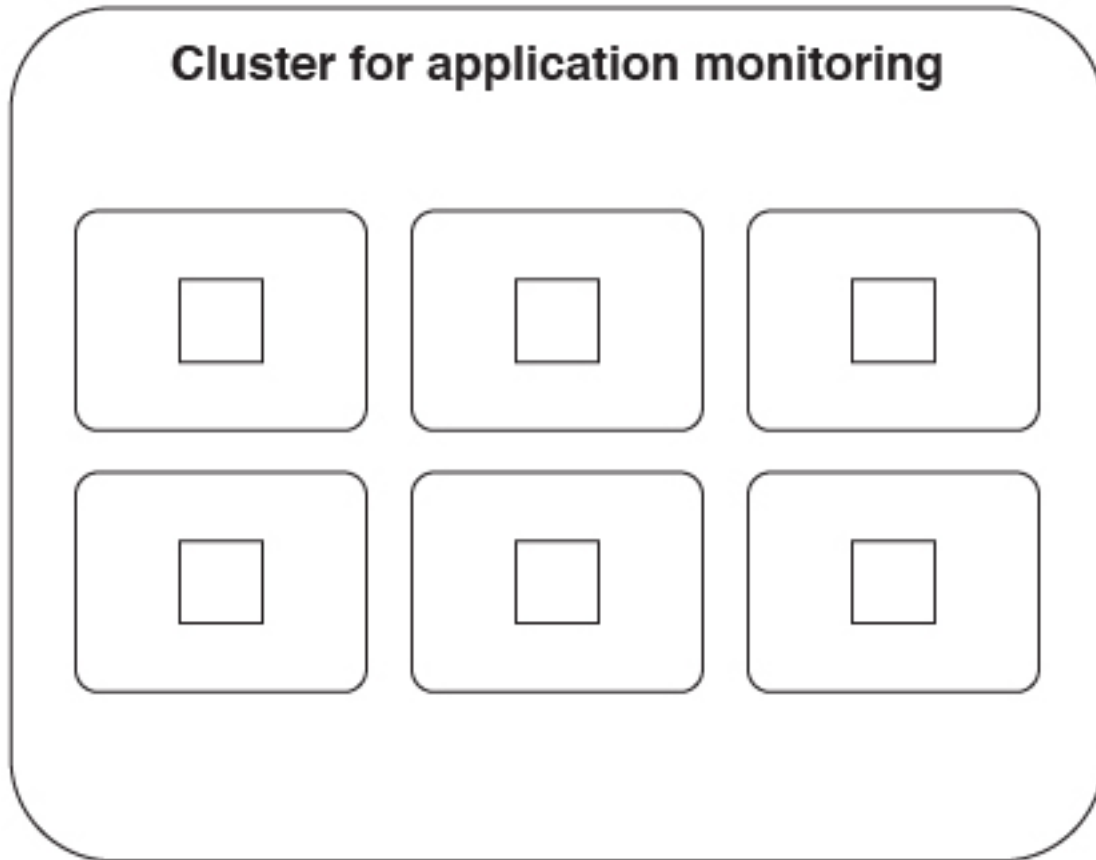

If it is determined that six nodes are no longer sufficient to handle the incoming data load, a new cluster must be set up. The data must then be reindexed with a larger shard limit.

It is important to understand that the distribution of the shards happens automatically. The only configuration that must be made for shards is specifying the number of shards at installation time.

A small performance hit comes with having more than one shard per node. Although this performance hit is often negligible, the cluster should not be configured with an arbitrarily large number of shards.

#### *Understanding replicas:*

Learn about replicas in the IBM MobileFirst Platform Operational Analytics.

Shards contain the actual data that is sent from the MobileFirst Server. The master node keeps track of which shards are on which nodes so that it can evenly distribute incoming requests. Because of the way shards are distributed among nodes, performance can be increased by adding another node and allowing the shards to be distributed.

But what happens if a node fails? The data that was stored in the lost shards is no longer available. Incoming analytics data might no longer be indexable. Search requests for data on a particular shard fail. To increase shard availability to avoid these problems, you can create a replica of each shard. By using JNDI properties,

you can tell the IBM MobileFirst Platform Operational Analytics to create a specified number of replicas for each shard.

The following images show how replicas work.

Here is a cluster with one node, three shards, and one replica for each shard.

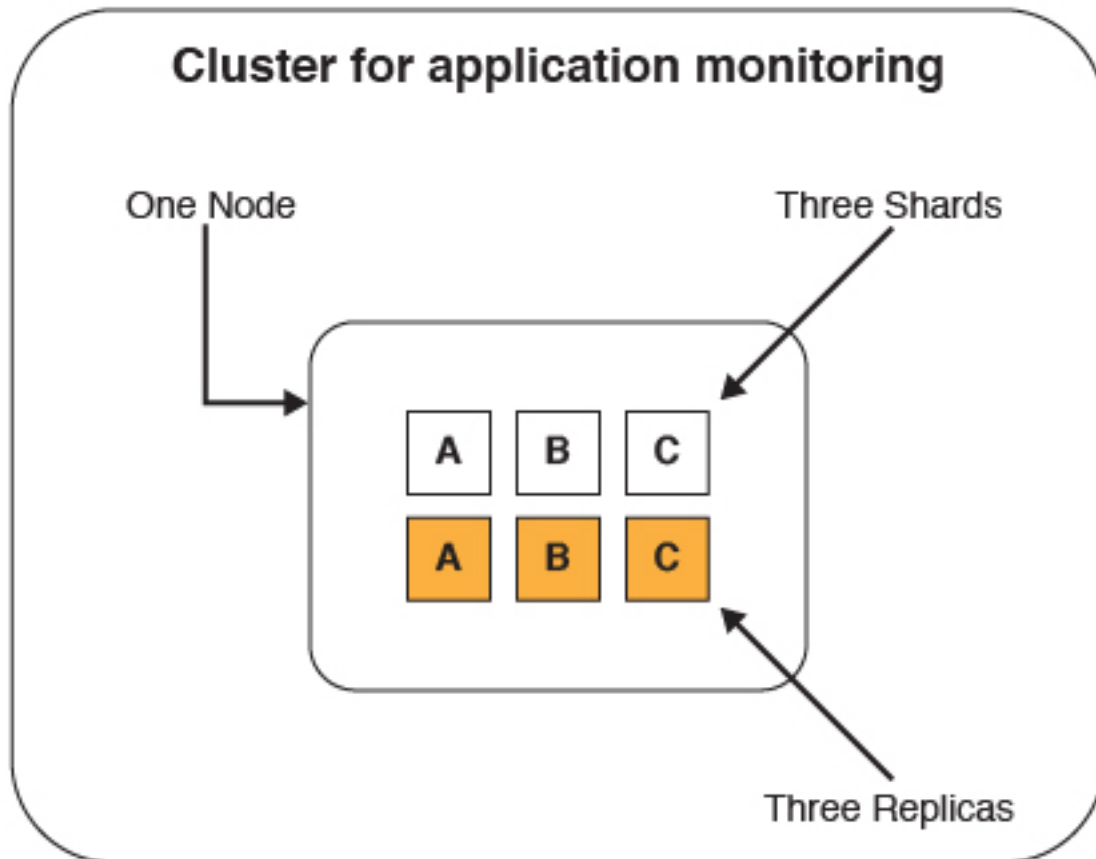

In this case, the replicas are redundant. Because there is only one node, having a replica exist on the same node does not accomplish anything. If the single node fails, the shards and replicas are all lost.

Now two more nodes are added to the cluster to improve performance:



## Cluster for application monitoring

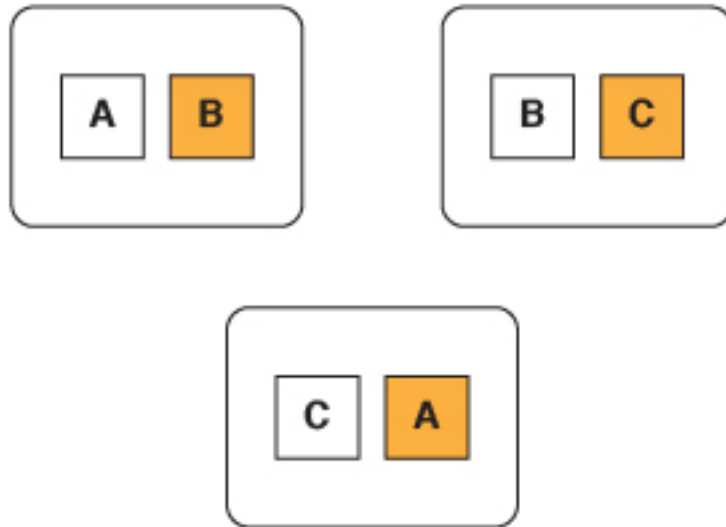

Notice that the shards and replicas are both automatically distributed evenly among the nodes. Now consider the scenario where a node fails due to a network or hardware issue.

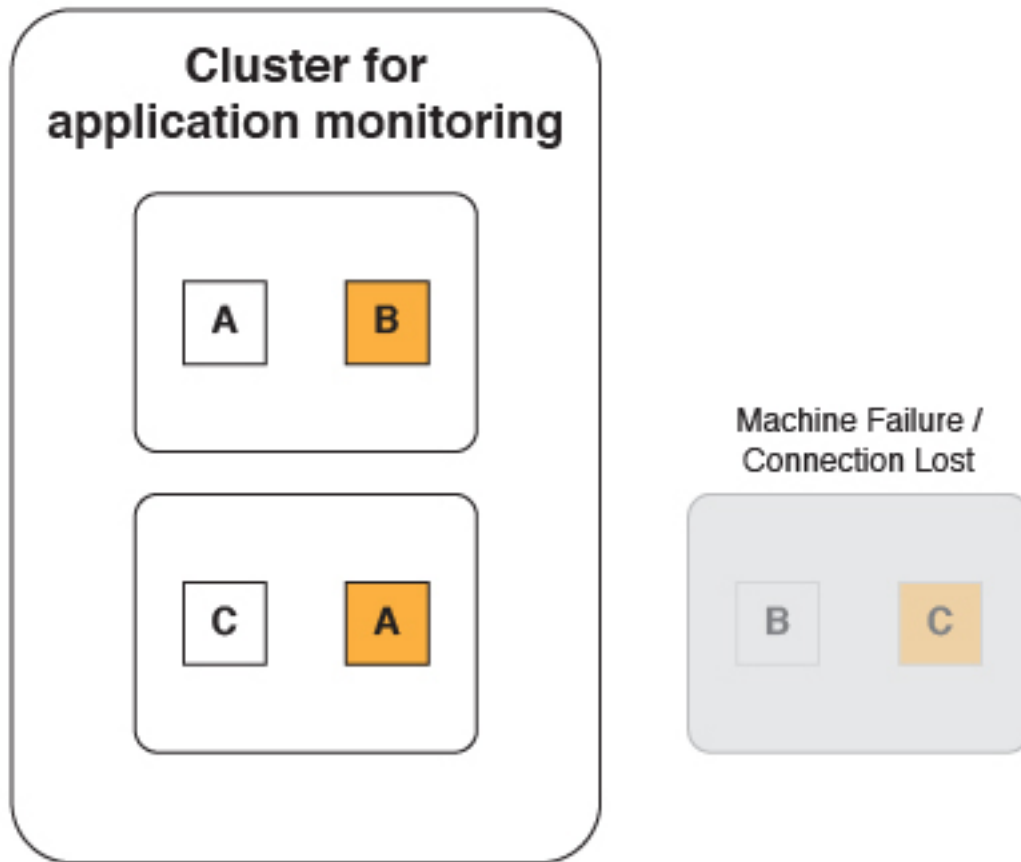

The analytics cluster can still operate normally because a replica of the lost shards still exists on one of the remaining nodes.

## Cluster for application monitoring

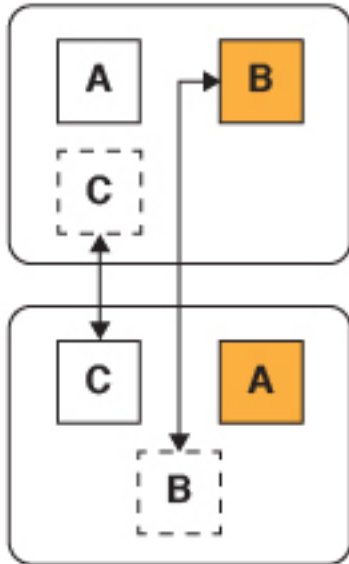

Machine Failure /  
Connection Lost

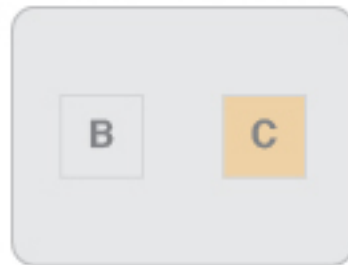

## Cluster for application monitoring

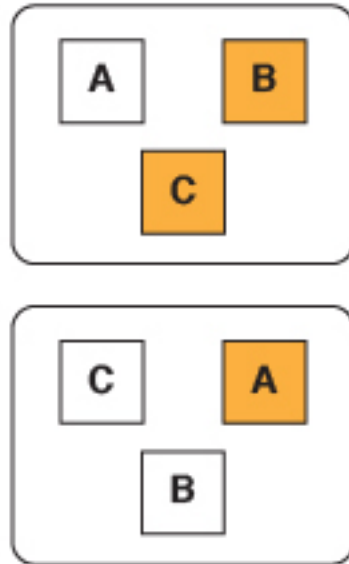

When the failed node comes back online and rejoins the cluster, the shards and replicas are again evenly distributed. The cluster returns to the state it was in before one of the nodes failed.

But what happens when two of the nodes fail simultaneously?

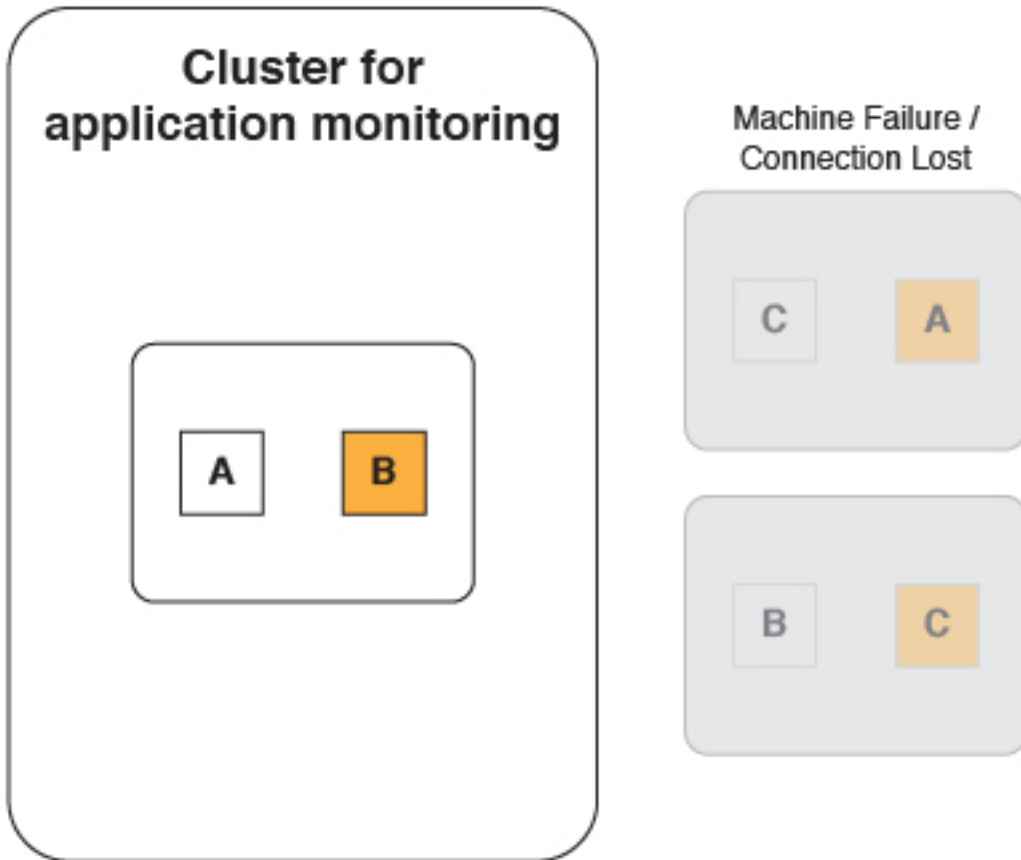

The cluster cannot operate normally. Even with one replica per shard, if two nodes were to fail, you would still lose information that was stored in the lost shards.

The answer to this problem is to use two replicas per shard.

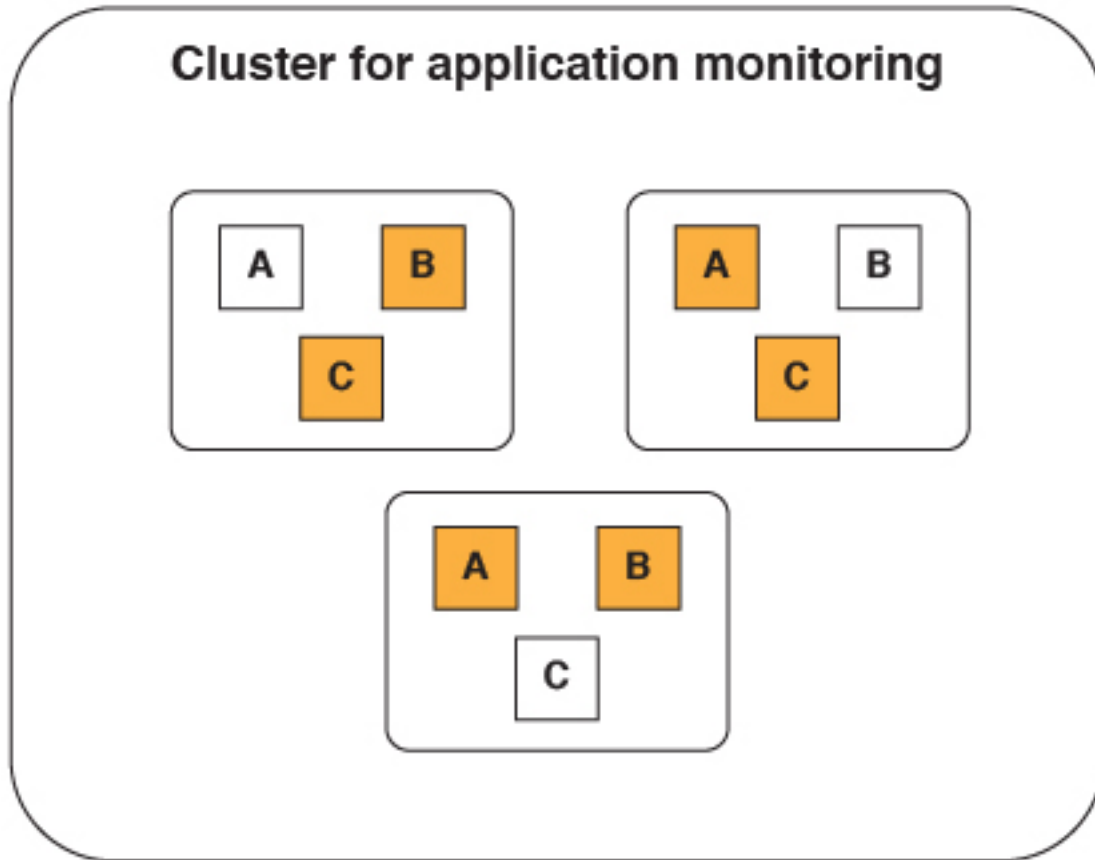

Now even when two nodes fail, all of the data is available and the cluster can still operate normally.

Having replica shards can also increase performance because an incoming request can be handled by either a primary or replica shard.

The ideal number of replicas for each shard varies based on several factors such as:

- Hardware limitations.
- Availability requirements.
- Clustering topology.

#### **Setting up a production cluster:**

You can set up a production cluster for operational analytics.

#### **Before you begin**

For a production cluster, do not run the IBM MobileFirst Platform Operational Analytics on the same server as the MobileFirst Server. The IBM MobileFirst Platform Operational Analytics uses a large amount of the computer's processor and memory resources. Each node should run on a separate server.

If you are deploying to a WebSphere Application Server cluster, also see “Deploying in a clustered WebSphere Application Server environment” on page 12-68.

## About this task

To set up your production cluster, follow these steps.

### Procedure

1. Set the heap size for the application server. The heap size has a very significant impact on the performance of the IBM MobileFirst Platform Operational Analytics. The heap size must be set on each application server that is hosting a node. The `-Xms` Java option sets the minimum heap size value. The `-Xmx` Java option sets the maximum heap size value. For example, to reserve 8 GB of memory for the IBM MobileFirst Platform Operational Analytics, set the following Java options:

```
-Xms8G -Xmx8G
```

#### Note:

- The minimum heap size for a production server is 8 GB.
- Do not allocate more than half of the system memory to the application server that is running the IBM MobileFirst Platform Operational Analytics.
- Set the minimum and maximum heap size to the same value for an application server that is hosting the IBM MobileFirst Platform Operational Analytics.

For an IBM MobileFirst Platform Operational Analytics that runs on a server with 32 GB of RAM, the optimal heap size is:

```
-Xms16G -Xmx16G
```

2. Configure the first node in the cluster. The first node in the cluster is important because some properties can be set only by this node. It is important to ensure that the settings for the node are present before you start the application servers. The first node in a cluster must be a master node. A master node can also act as a data node.

- a. Configure the node to be a master node. Set the `nodetype` JNDI property to `master`.

```
<jndiEntry jndiName="analytics/nodetype" value="master" />
```

**Note:** By default, a node acts as a master and data node. If you want to create a node that acts as both a master and a data node, the node type does not need to be set.

- b. Set the number of shards. Set the `shards` JNDI property to the number of shards you want.

```
<jndiEntry jndiName="analytics/shards" value="10" />
```

- c. Set the number of replicas. Set the `replicas_per_shard` JNDI property to the number of replicas you want.

```
<jndiEntry jndiName="analytics/replicas_per_shard" value="2" />
```

After all of the JNDI properties are set, the application server can be started.

3. Add a node to an existing cluster.

- a. Set the node type. Set the `nodetype` JNDI property to either `master` or `data`.

```
<jndiEntry jndiName="analytics/nodetype" value="master" />  
<jndiEntry jndiName="analytics/nodetype" value="data" />
```

**Note:** By default, a node acts as a master and data node. If you want to create a node that acts as both a master and a data node, the node type does not need to be set.

**Note:** If you are deploying to a WebSphere Application Server cluster, do not set the nodetype JNDI property. All nodes in the WebSphere Application Server cluster must act as master and data nodes.

- b. Provide a list of the master nodes. Set the masternodes JNDI property to a comma delimited list of host names for the master node.

```
<host>:<transport-port>,<host>:<transport-port>
```

The default transport port is 9600. You can change this value by using a JNDI property. For more information about the transport port, see “Ports that are used by the IBM MobileFirst Platform Operational Analytics” on page 12-51.

For example:

```
<jndiEntry jndiName="analytics/masternodes"  
          value="master1.ibm.com:9600,master2.ibm.com:9600" />
```

4. Configure the `worklight.properties` file. Set the `wl.analytics.url` property to point to any of the nodes (can point to a master or data node).

```
wl.analytics.url=http://<hostname>:<port>/analytics-service/data
```

## Results

You have set up a production cluster.

### Note:

A node that is set as a pure data node cannot run on its own without a master node. The masternodes JNDI property must be set and must point to an active master node.

A node that is set as a pure master node cannot store data. Any attempts to store or view data from a master node fails until a data node connects to it.

Data nodes are active, which makes them more prone to network and hardware failures. If a data node fails, the cluster can still operate normally if the other data nodes are alive. If the master node or nodes fail, then the cluster cannot operate. Data nodes can communicate with only each other through master nodes. This behavior is why it is important to consider having separate master nodes that can run on servers with fewer chances for failure.

The same version of Java must be installed on all nodes in the cluster. Using different versions of Java for different nodes causes the cluster to fail.

*Deploying in a clustered WebSphere Application Server environment:*

You can deploy the Analytics Platform in a clustered WebSphere Application Server environment.

### Before you begin

**Note:** In previous topics, the term *node* is used as a general term to define a separate machine that runs an instance of the Analytics Platform. The term *node* is used here to identify a node in a WebSphere Application Server cluster.

### About this task

All clustering is handled by the Analytics Platform regardless of the topology that is configured in WebSphere Application Server. You must determine which



machines in the cluster you want to be the *master nodes* and define them through a JNDI property. The list of master nodes are passed down to the WAR file, where the distribution of analytics data within the cluster is handled.

To use the Analytics Platform in a clustered environment on WebSphere Application Server, follow these steps.

### Procedure

1. Identify the machines in the cluster that you want to be the master nodes and record their IP addresses or host names.
2. Deploy the analytics WAR file to the WebSphere Application Server cluster. Do not start the web application yet.
3. Set the JNDI property for masternodes to a comma-separated list of the nodes in the cluster that you want to be the host name. The following example shows possible values for the JNDI property:

```
<hostname>:<port>,<hostname>:<port>,<hostname>:<port>
```

```
192.168.1.32:9600,192.168.1.8:9600
```

```
clusterhost1:9600,clusterhost2:9600,clusterhost3:9600
```

**Note:** The *port* value is the transport port, which by default is 9600. You can change this port through the JNDI property. For more information, see “Ports that are used by the IBM MobileFirst Platform Operational Analytics” on page 12-51.

The following image shows the environment entries for web modules:

Enterprise Applications > IMF Operational Analytics > Environment entries for Web modules

Environment entries for Web modules

Configure values for environment entries in web modules.

Web module	URI	Name	Type	Description	Value
analytics	worklight-analytics-war,WEB-INF/web.xml	analytics/serviceProxyURL	String	[OPTIONAL] Proxy URL for analytics REST services.	<input type="text"/>
analytics	worklight-analytics-service-war,WEB-INF/web.xml	analytics/nodetype	String	[OPTIONAL] Defines the node type. Valid values are "master" and "data". If this JNDI property is not set, then by default, the node will act as a master node and a data node.	<input type="text"/>
analytics	worklight-analytics-service-war,WEB-INF/web.xml	analytics/shards	String	[OPTIONAL] The number of shards that the cluster will create. This value can only be set by the first node in a cluster. Default: 5	<input type="text"/>
analytics	worklight-analytics-service-war,WEB-INF/web.xml	analytics/replicas_per_shard	String	[OPTIONAL] The number of replicas for each shard in the cluster. This value can only be set on the first node in a cluster. Default: 1	<input type="text"/>
analytics	worklight-analytics-service-war,WEB-INF/web.xml	analytics/masternodes	String	[OPTIONAL] A comma delimited string containing the hostname and ports of the master nodes (hostname:transport-port,hostname:transport-port)	9.122.123.134:9600
analytics	worklight-analytics-service-war,WEB-INF/web.xml	analytics/clustername	String	[OPTIONAL] Name of the cluster. It is only necessary to set this value if you plan to have multiple clusters and wish to uniquely identify them. Default: "worklight"	<input type="text"/>
analytics	worklight-analytics-service-war,WEB-INF/web.xml	analytics/nodename	String	[OPTIONAL] Name of a node in a cluster. A node joining a cluster will randomly generate a name to uniquely identify it. You can specify your own name using this property. Default: (randomly generated)	<input type="text"/>
analytics	worklight-analytics-service-war,WEB-INF/web.xml	analytics/datapath	String	[OPTIONAL] The path that analytics data is saved to on the file system.	<input type="text"/>

4. Set the remaining JNDI properties. For more information about the JNDI properties, see “Properties and configurations” on page 12-71.

5. Open the analytics console page on each cluster. When the console is accessed, each node in the cluster establishes a connection with each node listed in the masternodes list.

## Results

You deployed the Analytics Platform in a clustered WebSphere Application Server environment.

**Note:** When you install analytics on WebSphere Application Server, a profile can contain multiple servers. Each server can have multiple analytics WAR files. By default, each of these WAR files points to the same directory to store analytics data. Normally, a JNDI property is used to change the location of the directory that is used to store analytics data. However, in this case, each server shares the same JNDI property. Because of this scenario, you must use WebSphere Application Server variables to define the location of the data directory when you set the JNDI property for the analytics data folder. The following example shows how you can set the JNDI property with the variables:

```
 ${USER_INSTALL_ROOT}/MFPAnalyticsDir/${WAS_SERVER_NAME}/AnalyticsData
```

## Performance tuning:

Learn about performance tuning for the IBM MobileFirst Platform Operational Analytics.

## Java virtual machine (JVM) swapping

The underlying technology that is used by the IBM MobileFirst Platform Operational Analytics is called Elasticsearch. Elasticsearch performs poorly when the JVM starts swapping. To ensure that the JVM never swaps, the following JNDI property can be set to true:

```
<jndiEntry jndiName="analytics/bootstrap.mlockall" value="true" />
```

## Setting the Field Cache Size

The underlying technology used by the analytics platform loads several field values into memory to provide fast access to those documents. This is known as the field cache. By default, the amount of data loaded into memory by the field cache is unbounded. If the field cache becomes too large, it can cause an out of memory exception and crash the analytics platform. You can put an upper limit on the field cache to prevent this from happening. The field cache can be set using the following JNDI property:

```
<jndiEntry jndiName="analytics/indices fielddata.cache.size" value="80%"/>
<jndiEntry jndiName="analytics/indices fielddata.cache.size" value="10GB"/>
```

**Note:** The field cache can be set using a hardcoded value (such as 10GB) or it can be set to a percentage of the heap (such as 80%).

Placing an upper limit on the cache will prevent the field cache from causing an out of memory exception. However, when the limit is reached, the analytics platform will begin to take longer to perform search queries. At this point, you can either add additional memory to your machine or add an additional node to your cluster.

## Properties and configurations

Learn about the properties and configurations that are used for configuring the MobileFirst Server and IBM MobileFirst Platform Operational Analytics.

### MobileFirst properties

These properties can be set on the MobileFirst Server in the `worklight.properties` file. The server must be restarted for these properties to take effect.

**Note:** All properties in the `worklight.properties` file can also be set by using JNDI properties. For more information about JNDI properties, see “Configuring a MobileFirst project in production by using JNDI environment entries” on page 10-60.

For more information about the IBM MobileFirst Platform Operational Analytics properties, see “Analytics” on page 10-53.

### JNDI properties

JNDI environment properties can be set on the application server. For a clustered environment, some properties can be set only on the first node in the cluster. For more information, see “Setting up a production cluster” on page 12-66. The Analytics runtime web application must be restarted for any changes in these properties to take effect. It is not necessary to restart the entire application server.

All JNDI properties are namespaced with `analytics/`.

The following example shows how to set the `datapath` JNDI property in Liberty:

```
<jndiEntry jndiName="analytics/datapath" value="/opt/IBM/analytics/data" />
```

The following example shows how to set the `datapath` JNDI property in Tomcat:

```
<Environment name="analytics/datapath"
  value="/opt/IBM/analytics/data"
  type="java.lang.String"
  override="false" />
```

**Note:** For Tomcat, the JNDI property must include the `override="false"` attribute to work properly.

The following table shows the JNDI properties:

*Table 12-16. JNDI properties for the IBM MobileFirst Platform Operational Analytics.* This table lists the JNDI property names, default values, and descriptions for the IBM MobileFirst Platform Operational Analytics.

Property Name	Default Value	Description
<code>nodetype</code>	None.	Defines the node type. Valid values are master and data. If this JNDI property is not set, then the node acts as a master node and a data node by default.

Table 12-16. JNDI properties for the IBM MobileFirst Platform Operational Analytics (continued). This table lists the JNDI property names, default values, and descriptions for the IBM MobileFirst Platform Operational Analytics.

Property Name	Default Value	Description
shards	5	The number of shards per index that the cluster creates. This value can be set only by the first node in a cluster. This value can never be changed after the first node in the cluster starts.
replicas_per_shard	1	The number of replicas for each shard in the cluster. This value can be set only by the first node in a cluster.
masternodes	None.	A comma-delimited string that contains the host name and ports of the master nodes. For more information about this property, see “Setting up a production cluster” on page 12-66.
clustername	worklight	Name of the cluster. Set this value if you plan to have multiple clusters and want to uniquely identify them.
nodename	Randomly generated.	Name of a node in a cluster. A node that joins a cluster randomly generates a name to uniquely identify itself. You can specify your own name by using this property.
datapath	./analyticsData	The path that analytics data is saved to on the file system. By default, a folder that is named analyticsData is created.
settingspath	None.	Specifies the path to an extra settings file. For more information, see “Elasticsearch properties” on page 12-73.
transportport	9600	Port that is used for node-to-node communication. For more information, see “Ports that are used by the IBM MobileFirst Platform Operational Analytics” on page 12-51.

Table 12-16. JNDI properties for the IBM MobileFirst Platform Operational Analytics (continued). This table lists the JNDI property names, default values, and descriptions for the IBM MobileFirst Platform Operational Analytics.

Property Name	Default Value	Description
httpport	9500	Port that is used for HTTP communication to the IBM MobileFirst Platform Operational Analytics. For more information, see "Ports that are used by the IBM MobileFirst Platform Operational Analytics" on page 12-51.
http.enabled	false	Controls whether Elasticsearch can be queried directly by using the HTTP Port. If false, the port that is specified by the JNDI value httpport is not opened, and Elasticsearch is not accessible by using HTTP.
app_activities_ttl	None.	The TTL for automatic deletion of app activities data.
notification_activities_ttl	None.	The TTL for automatic deletion of notification activities data.
client_logs_ttl	None.	The TTL for automatic deletion of client logs data.
server_logs_ttl	None.	The TTL for automatic deletion of server logs data.
serviceProxyURL	None	This property enables the IBM MobileFirst Platform Operational Analytics console to locate the Analytics REST services. The value of this property must be specified as the external address and context root of the worklight-analytics-service.war web application.

## Elasticsearch properties

Elasticsearch is the underlying technology that is used by IBM MobileFirst Platform Operational Analytics. Elasticsearch provides several extra properties for performance tuning. The JNDI properties that are exposed and documented here are abstractions around the properties that are provided by Elasticsearch. Normally, these properties are set in a custom settings file.

If you are familiar with Elasticsearch and the format of its properties files, you can specify the path to the settings file by using the settingspath JNDI property:

```
<jndiEntry jndiName="analytics/settingspath"
value="/home/system/elasticsearch.yml" />
```

All properties that are provided by Elasticsearch can also be set by using a JNDI property with the `analytics/` string added before the property name. For example, `threadpool.search.queue_size` is a property that is provided by Elasticsearch that is used for performance tuning. This property can be set by using a JNDI property as follows:

```
<jndiEntry jndiName="analytics/threadpool.search.queue_size" value="100" />
```

## Backing up Operational Analytics data

Learn about how to back up your MobileFirst Operational Analytics data.

The data for MobileFirst Operational Analytics is stored as a set of files on the MobileFirst Operational Analytics Server file system. The location of this folder is specified by the `datapath` JNDI property in the MobileFirst Operational Analytics Server configuration. For more information about the JNDI properties, see “Properties and configurations” on page 12-71.

The MobileFirst Operational Analytics Server configuration is also stored on the file system, and is called `server.xml`.

You can back up these files by using any existing server backup procedures that you might already have in place. No special procedure must be used when you back up these files, other than ensuring that the MobileFirst Operational Analytics Server is stopped. Otherwise, the data might change while the backup is occurring, and the data that is stored in memory might not yet be written to the file system. To avoid inconsistent data, stop the MobileFirst Operational Analytics Server before you start your backup.

## Reports database

IBM MobileFirst Platform Foundation for iOS provides an extensible mechanism for enterprises to use to integrate reporting tools with IBM MobileFirst Platform Foundation for iOS.

**Note:** The Reports database and the sample BIRT Reports are deprecated in IBM MobileFirst Platform Foundation for iOS V7.0.0. You should use “Operational analytics” on page 12-8 instead.

IBM MobileFirst Platform Foundation for iOS provides raw data reports and a number of device reports that are aggregated from the raw data report table. IBM MobileFirst Platform Foundation for iOS also comes bundled with a third-party Business Intelligence Report Tools (BIRT) feature, which provides a range of predefined report templates. To understand the similarities and differences between the existing reports feature and the new operational analytics feature, see “Comparison of operational analytics and reports features” on page 12-7.

**Note:** Enabling the BIRT feature is redundant if you already use the IBM MobileFirst Platform Operational Analytics.

IBM MobileFirst Platform Foundation for iOS provides three reporting mechanisms:

### Raw data feeds

IBM MobileFirst Platform Foundation for iOS emits raw data, which enables an OLAP system to extract the required information and present it through corporate reporting mechanisms. For more information, see “Using raw data reports” on page 12-76.

**Device usage reports**

IBM MobileFirst Platform Foundation for iOS provides reports about device usage. Device usage reports are default aggregations that are based on raw data, and are provided for the benefit of organizations that do not have OLAP systems or choose not to integrate IBM MobileFirst Platform Foundation for iOS with an OLAP system. For more information, see “Device usage reports” on page 12-80.

**Note:** Device usage reports are functional only in IBM MobileFirst Platform Foundation for iOS Customer Edition and IBM MobileFirst Platform Foundation for iOS Enterprise Edition.

**BIRT reports**

IBM MobileFirst Platform Foundation for iOS comes bundled with predefined BIRT report to use either as they are or as templates to modify. For more information, see “Predefined BIRT Reports” on page 12-82.

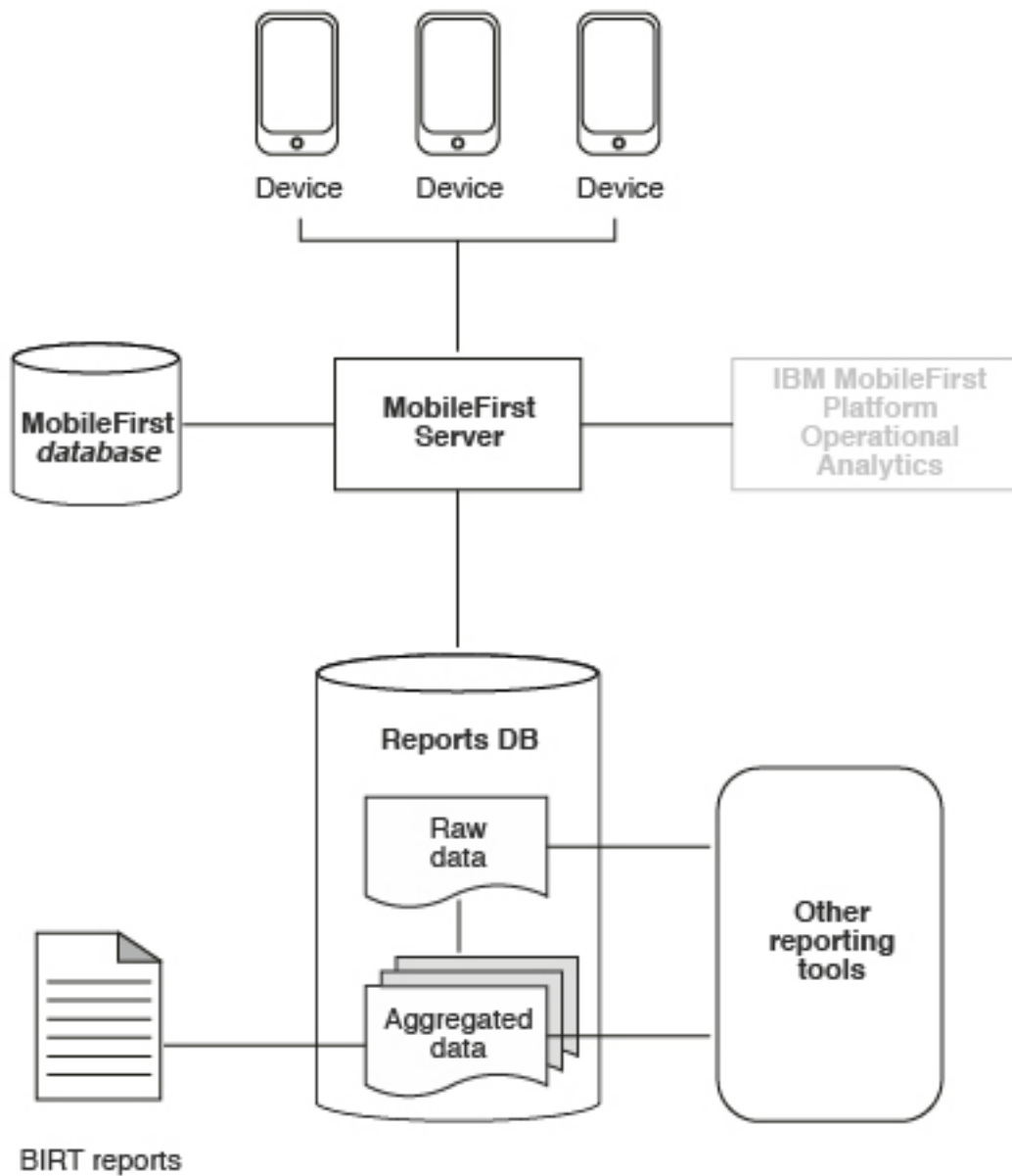

Figure 12-30. High-level overview of the reports architecture

The reports architecture diagram shows how the raw data feed comes from three devices into the MobileFirst Server and then into the IBM MobileFirst Platform Foundation for iOS database, the Reports database, or both. From the Reports database, data then becomes aggregated data and is filtered out into the BIRT reports or to other reporting tools.

**Important:** When you work with report generation, you must update the `.rptdesign` file with your reports database user name and password, which are considered sensitive information. You are responsible for protecting it against unauthorized access.

### Using raw data reports

You can use the raw data reports feature to extract raw data to different databases and view it in the form of reporting tables.



## About this task

**Note:** The Reports database and the sample BIRT Reports are deprecated in IBM MobileFirst Platform Foundation for iOS V7.0.0. You should use “Operational analytics” on page 12-8 instead.

Raw data reports provide you with analytics information about your applications and adapter usage, such as activity type, device information, and application version. Use the following steps to enable the raw data reports feature:

### Procedure

1. Ensure that the IBM MobileFirst Platform Server application server is not running.
2. Create a separate database or a new schema for reports. This action is not mandatory but is useful because the raw data table is rapidly populated. For information about creating databases in a development environment, see “Runtime database setup for development mode” on page 10-50. For information about creating databases and schemas in a production environment, see “Creating and configuring the databases manually” on page 10-17.
3. When you work in a development environment, complete the following steps.
  - a. Edit the `worklight.properties` file. Uncomment the `reports.exportRawData` property and set its value to `true`.
  - b. Modify the `wl.reports.db` properties to contain your database settings as shown in the following example.

```
#####  
# Raw reports  
#####  
reports.exportRawData=true  
# jndi name; empty value means Apache DBCP data source  
#wl.reports.db.jndi.name=${wl.db.jndi.name}  
# Default values for DBCP connection pool  
#wl.reports.db.initialSize=${wl.db.initialSize}  
#wl.reports.db.maxActive=${wl.db.maxActive}  
#wl.reports.db.maxIdle=${wl.db.maxIdle}  
#wl.reports.db.testOnBorrow=${wl.db.testOnBorrow}  
wl.reports.db.url=jdbc:mysql://localhost:3306/wlreport  
wl.reports.db.username=worklight  
wl.reports.db.password=worklight
```

- c. Ensure that the `wl.reports.db.url` property contains the URL of the database you are planning to use for raw data.
4. When you work in a production environment, connect to the reports database by using JNDI environment entries in addition to editing the `worklight.properties` file, as described in the previous step. See “Configuring a MobileFirst project in production by using JNDI environment entries” on page 10-60.

5. Restart your application server.

The `app_activity_report` table of the raw data database is populated with data as you use your applications and adapters.

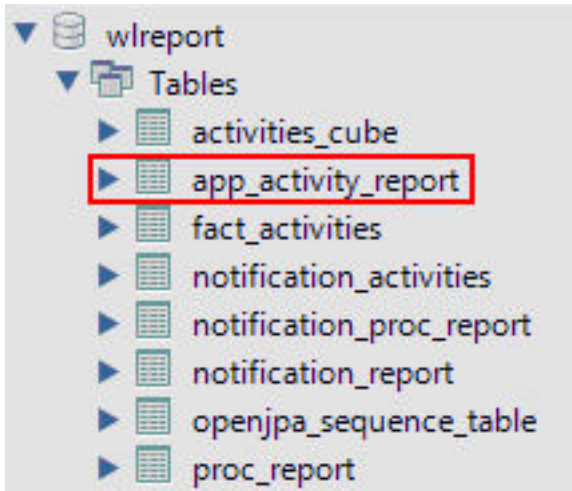

The raw data app\_activity\_report table contains the following information:

Column	Description
ACTIVITY_TIMESTAMP	UTC time of entry
GADGET_NAME	MobileFirst Application name
GADGET_VERSION	Application version
ACTIVITY	Activity type
ENVIRONMENT	Application environment name (iPhone, and so on)
SOURCE	User identifier
ADAPTER	MobileFirst adapter name
PROC	MobileFirst adapter procedure name
USERAGENT	User agent from HTTP header of client device
SESSION_ID	A unique identifier for the user's session on the server
IP_ADDRESS	IP address of the client
DEVICE_ID	A unique device ID
DEVICE_MODEL	Manufacturer model, for example iPhone 5
DEVICE_OS	Device operating system version
LONGITUDE	The longitude of the device. Requires that ongoing acquisition is enabled for Geo.
LATITUDE	The latitude of the device. Requires that ongoing acquisition is enabled for Geo.
POS_USER_TIME	The local time on the device when the latest position information (longitude and latitude) were updated. Requires that ongoing acquisition is enabled for Geo.
WIFI_APS	The access points visible on the device. Requires that ongoing acquisition is enabled for WiFi.

Column	Description
<b>WIFI_CONNECTED_SSID</b>	The SSID (network identification) of the connected WiFi access point. Requires that ongoing acquisition is enabled for WiFi.
<b>WIFI_CONNECTED_MAC</b>	The MAC address of the connected WiFi access point. Requires that ongoing acquisition is enabled for WiFi.
<b>WIFI_USER_TIME</b>	The local time on the device when the latest WiFi information was updated. Requires that ongoing acquisition is enabled for WiFi.
<b>APP_CONTEXT</b>	The application context, as set by <code>WL.Server.setApplicationContext</code> .

The following activities can be included in reports:

Activity	Description
Init	Application initialization
Login	Successful authentication in using the application
Adoption New	Not supported in IBM Worklight V5.0
Adoption	Not supported in IBM Worklight V5.0
Query	Procedure call to an adapter
Logout	User logout
Event	An event handler was called

In addition to predefined activity types, custom activities can be logged by using `WL.Client.logActivity("custom-string")` APIs.

When the activity is Event, the reporting information comes from the event device context instead of `WL.Server.getClientDeviceContext`. Also, when the activity is Event the **PROC** column gives the name of the event handler function that was called.

**Important:** MobileFirst raw data feed can increase rapidly. The data is typically used by a BI system such as Cognos® or Business Objects. It is the administrator's responsibility to purge built-in tables periodically. For example, the following commands delete Oracle database rows that are more than 30 days old from the `activities_cube` and `app_activity_report` tables. For other databases such as MySQL, modify the syntax appropriately.

**To delete rows from `activities_cube` that are more than 30 days old (assuming `ACTIVITY_DATE` is a `DATE` type field):**

```
DELETE FROM ACTIVITIES_CUBE WHERE ACTIVITY_DATE <= TRUNC(SYSDATE) - 30
```

**To delete rows from `app_activity_report` that are more than 30 days old (assuming `ACTIVITY_TIMESTAMP` is a `TIMESTAMP` type field):**

```
DELETE FROM APP_ACTIVITY_REPORT WHERE ACTIVITY_TIMESTAMP <= TO_TIMESTAMP(TRUNC(SYSDATE) - 30)
```

Purging data by deleting rows might fail on heavily loaded systems. An alternative approach is to use database table partitions to facilitate the purging of accumulated data. For more information, see "Optimization of MobileFirst Server project databases" on page 6-108.

In addition to the `app_activity_report` table, the raw data engine also populates the `notification_report` table. This raw data table contains

information about notifications that are sent from SMS event sources.

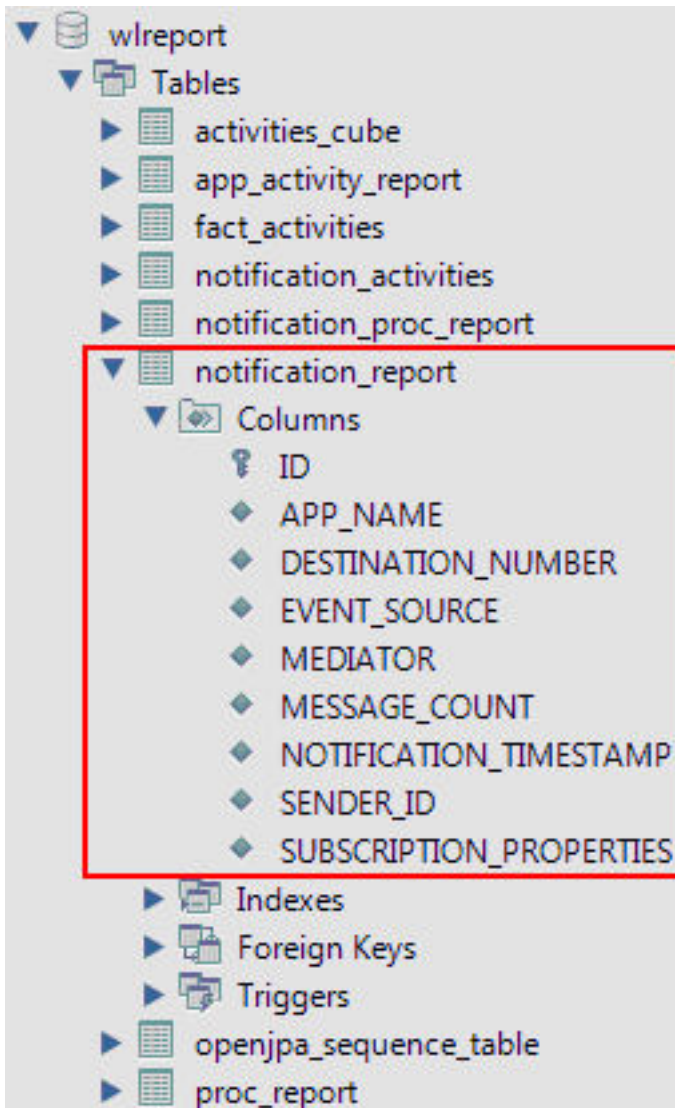

### Device usage reports

For simpler and faster access to the reports data, IBM MobileFirst Platform Server runs an analytics data processor task at a default time interval of every 24 hours.

**Note:** The Reports database and the associated APP\_ACTIVITY\_REPORT table described below are deprecated in IBM MobileFirst Platform Foundation for iOS V7.0.0. Use “Operational analytics” on page 12-8 instead. Note that setting up the Reports database is optional in this release and prior releases.

The analytics data processor task retrieves raw entries for the specified time interval from the app\_activity\_report table and processes them to populate the fact\_activities table.

**Note:** The fact\_activities table is only populated with usage data from hybrid and native applications from actual devices. Usage data from MobileFirst mobile web applications that are running on actual devices or from a browser, such as when you are using preview, is not populated into this table.



The fact\_activities table contains a total activity count (number of logged actions) per application, application version, device, and environment. The fact\_activities data is also processed and put into the activities\_cube table. This table has the same structure as the fact\_activities table and only contains records for the last 30 days.

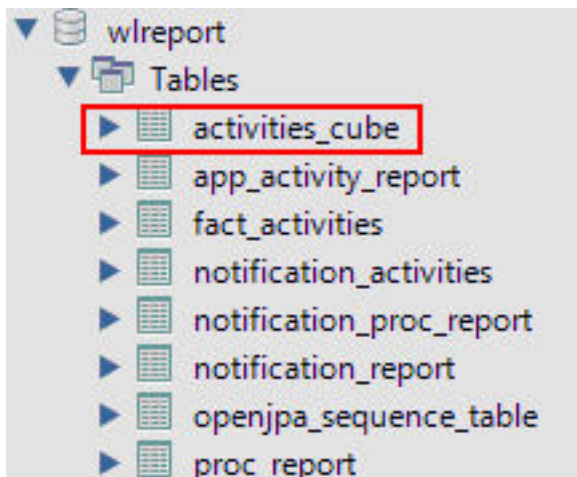

Each time the data processing is done, a time stamp is added to a `proc_report` table with the processing result (time stamp and number of processed entries).

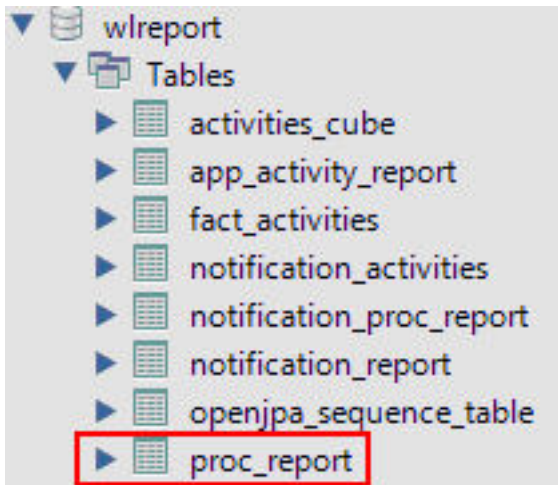

In addition, `notification_report` table data is also processed to populate the `notification_activities` table with consolidated data. The table is populated in the same way as the `fact_activities` table. Every time the `notification_report` table data is processed, an entry is added to the `notification_proc_report` table, which is similar to the `proc_report` table.

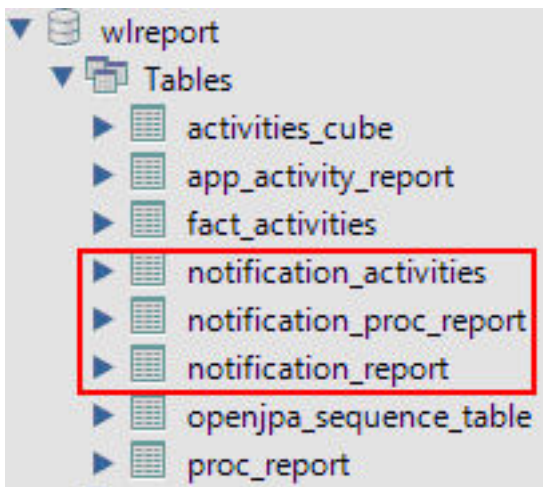

The processing interval can be modified by adding the following property to your `worklight.properties` file and setting the required interval in seconds.

```
# Default interval value for analytics processing task  
wl.db.factProcessingInterval=86400
```

The processing interval can also be disabled by setting this property to a negative value.

```
# Set to a negative value to disable the analytics processing task  
wl.db.factProcessingInterval=-1
```

### Predefined BIRT Reports

You can use predefined BIRT reports to generate and display information about mobile devices and usage.

**Note:** The predefined BIRT reports and the Reports database and associated tables such as APP\_ACTIVITY\_REPORT are deprecated in IBM MobileFirst Platform Foundation for iOS V7.0.0. Use “Operational analytics” on page 12-8 instead. Note that setting up the Reports database is optional in this release and prior releases.

IBM MobileFirst Platform Foundation for iOS generates raw reports, which are stored in an app\_activity\_report table. IBM MobileFirst Platform Foundation for iOS also includes device usage reports, which are aggregations of data from the app\_activity\_report, and are described in “Device usage reports” on page 12-80 and “Using raw data reports” on page 12-76. Users can view or extract data from the app\_activity\_report table or from the device usage reports, and process it using their own business intelligence systems.

For users with no existing business intelligence analysis system, IBM MobileFirst Platform Foundation for iOS provides a selection of predefined Business Intelligence Reporting Tool (BIRT) reports. BIRT is a third-party tool, and is not created or supported by IBM. IBM MobileFirst Platform Foundation for iOS provides several \*.rptdesign files that contain logic to connect to the reports database, pull data from device usage tables, process, and display the data.

IBM MobileFirst Platform Foundation Consumer Edition and MobileFirst Enterprise Edition include the following predefined BIRT reports:

*Table 12-17. Predefined BIRT reports*

Report Name	Description	Report file name
Active Users	Active users in last 30 days.	report_active_users.rptdesign
Daily Hits	The daily aggregated hits for last 30 days. Any action from the user/device that caused a request to the server is counted as a hit. This number, aggregated over a day, equals the daily hits.	report_daily_hits.rptdesign
Daily Visits	The number of discreet visits by separate user/device in last 30 days. All actions by a user/device that caused one or more requests to the server within a day is counted as a visit.	report_daily_visits.rptdesign
Environment Usage	Application version and application environment used: number of visits that were recorded in the last 30 days.	report_environment_usage.rptdesign
New Devices	A record of unique devices that were connected in the last 30 days.	report_new_devices.rptdesign
Notification Messages Per Day	Number of messages sent each day in the past 90 days per data source.	report_notification_messages_per_day.rptdesign
Notification Messages Per Source	Total number of messages that were sent in the last 90 days per data source.	report_notification_messages_per_source.rptdesign

Table 12-17. Predefined BIRT reports (continued)

Report Name	Description	Report file name
License Total New Device Count	A record of unique devices that were connected over a specified period (90 days as default), for licensing purposes.	report_license_total_device_count.rptdesign

### Total number of new devices detected in the last 90 days

New Device Count: 23

#### Device Details

#	DEVICE ID	RECORDED DATE	APPLICATION NAME
1	c874b143-67de-415a-9e83-4c50913fe01b	Mar 1, 2012 12:00 AM	WL-App-3
2	a22b0614-0d41-49c0-9ec6-370c904b99f8	Mar 11, 2012 12:00 AM	WL-App-7
3	69b147bf-e321-4b4b-9cb5-49edc07b3767	Mar 31, 2012 12:00 AM	WL-App-7
4	a187acdb-bf79-4d69-87e9-40f3ba120acc	Apr 3, 2012 12:00 AM	WL-App-4
5	bf171a96-bdf8-4b62-b225-dabdaa891050	Apr 6, 2012 12:00 AM	WL-App-6
6	9c806153-536a-42ab-a1b8-db8a5f774abd	Apr 9, 2012 12:00 AM	WL-App-7
7	4fb73b71-ef9c-4862-a20e-c00a8702d175	Apr 12, 2012 12:00 AM	WL-App-6
8	46a9bc8f-2726-4fab-965e-1f0bd0a20d4	Apr 15, 2012 12:00 AM	WL-App-6
9	c7c582dc-fad1-411c-9f8c-58654b419df2	Apr 15, 2012 12:00 AM	WL-App-6
10	b9d754bd-589d-45fe-b120-73134d2c9d7e	Apr 18, 2012 12:00 AM	WL-App-4
11	3dc16b49-5690-4b99-9cfd-1724b058d006	Apr 20, 2012 12:00 AM	WL-App-7
12	106e9afd-7745-41f5-9c67-9e9cf003004f	Apr 24, 2012 12:00 AM	WL-App-4
13	77d96ebe-b22b-475b-8843-429a27b8799c	Apr 24, 2012 12:00 AM	WL-App-3
14	2f218876-5f81-4ee5-90d3-6e28917d0f66	Apr 25, 2012 12:00 AM	WL-App-7
15	c4386eb5-3fa2-40ec-9836-5dcfeaaade84c	Apr 26, 2012 12:00 AM	WL-App-1
16	47081136-995a-409a-b15a-b88bf2e858b0	Apr 29, 2012 12:00 AM	WL-App-1
17	138c3bfd-c2f9-4c32-b3d0-477f8af65bf7	May 1, 2012 12:00 AM	WL-App-2
18	2c89ccb9-68c7-48df-b236-87ec8d94f655	May 2, 2012 12:00 AM	WL-App-5
19	d9e0dc66-d3ee-4f8a-9e31-37d2b76c78fb	May 2, 2012 12:00 AM	WL-App-5
20	6dfffadab-48f5-4a24-9954-e78c441f917b	May 4, 2012 12:00 AM	WL-App-6
21	cdd92489-0fca-4449-b190-1530c5cdd76f	May 7, 2012 12:00 AM	WL-App-7
22	f8e15a91-a5db-429d-92ab-67df5e405d70	May 14, 2012 12:00 AM	WL-App-9
23	f338f574-1e18-4422-b25c-728ff6d6645c	May 21, 2012 12:00 AM	WL-App-0

Figure 12-31. An example of a report generated by BIRT, in this case report\_license\_total\_device\_count.rptdesign

There are several ways of viewing predefined reports, by using one of the following options.

- The Eclipse report designer plug-in. For instructions, see “BIRT in Eclipse” on page 12-91
- The BIRT Viewer application that is installed on your Tomcat, WebSphere Full Profile or WebSphere Liberty Profile application server.

### Installing BIRT on Apache Tomcat

You can use the Business Intelligence Reporting Tool (BIRT) to generate and render report content. You can view this content either by using an Eclipse plug-in, or an application server and browser.

### About this task

**Note:** The predefined BIRT reports and the Reports database and associated tables such as APP\_ACTIVITY\_REPORT are deprecated in IBM MobileFirst Platform Foundation for iOS V7.0.0. Use “Operational analytics” on page 12-8 instead. Note that setting up the Reports database is optional in this release and prior releases.



The MobileFirst installation contains a number of predefined BIRT reports. These reports are configurable XML files that are designed to retrieve and present data from the MobileFirst reports database tables. These files have an `.rptdesign` extension.

Complete the following steps to set up the BIRT Reports for viewing in an Apache Tomcat application server. For information about how to set up the BIRT Reports on other application servers, refer to the BIRT Reports website at Birt Tools.

### Procedure

1. Ensure that your Tomcat instance is not running.
2. Download the BIRT Reports runtime archive from Birt Report Downloads.
3. Extract the BIRT Reports runtime archive.
4. Copy the `WebViewerExample` folder to the `webapps` folder of your Tomcat server.
5. Rename the `WebViewerExample` folder to `birt` (this step is an option, and is just to simplify later execution).
6. Copy your database jdbc connector JAR file package to the Tomcat `\lib` folder (if you are using the same Tomcat instance that is running IBM MobileFirst Platform Server the jdbc connector package is already in the `\lib` folder).
7. In some cases, Tomcat might not have enough memory allocated to run BIRT Reports. To resolve this problem, edit the `catalina.bat` file under your Tomcat `\bin` folder and add the following line at the start of it. You might want to consult with your IT manager about exact settings.

```
set CATALINA_OPTS=-Xms512m -Xmx512m -XX:MaxPermSize=256m
```

8. Restart your Tomcat.
9. Go to the Tomcat manager application at `http://your-server/manager/` to verify that the BIRT Reports application started.

Applications					
Path	Version	Display Name	Running	Sessions	Commands
/birt	None specified	Eclipse BIRT Report Viewer	true	0	Start <input type="button" value="Stop"/> <input type="button" value="Reload"/> <input type="button" value="Undeploy"/> <input type="button" value="Expire sessions"/> with idle ≥ <input type="text" value="30"/> minutes

10. Your BIRT Reports viewer application is accessible at `http://your-server/birt/`.
11. You can test the BIRT Reports installation by going to `http://your-server/birt/frameset?__report=test.rptdesign&sample=my+parameter`.

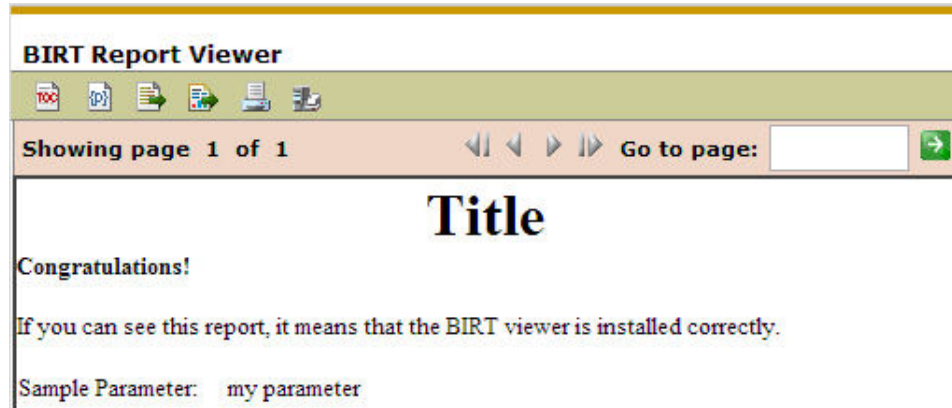

## Installing BIRT on WebSphere Application Server Liberty profile

Complete these steps to install Business Intelligence Reporting Tools on the WebSphere Application Server Liberty profile.

### About this task

**Note:** The predefined BIRT reports and the Reports database and associated tables such as APP\_ACTIVITY\_REPORT are deprecated in IBM MobileFirst Platform Foundation for iOS V7.0.0. Use “Operational analytics” on page 12-8 instead. Note that setting up the Reports database is optional in this release and prior releases.

### Procedure

1. Verify that your WebSphere Application Server Liberty profile instance is not running.
2. Go to your WebSphere Application Server Liberty profile folder and create two folders as follows:
  - apps
  - libs
3. Locate the jdbc connector driver that you are using and copy it to the libs folder.
4. Download the latest release of BIRT run time from <http://download.eclipse.org/birt/downloads/>
5. Extract the downloaded file and go to the extracted folder.
6. Rename WebViewerExample folder to birt.
7. Go to the folder birt\WEB-INF\lib and delete the following files.
  - org.apache.xerces\*.jar
  - org.apache.xml.resolver\*.jar
  - org.apache.xml.serializer\*.jar

Set up the BIRT Viewer application on a Liberty instance by following these steps.

8. Copy the birt folder to {your-liberty-instance}\usr\servers\{your-server-name}\apps\
9. Update the server.xml file of your Liberty server profile.
10. Make sure that the JSP feature is enabled.
11. Add an application definition.

12. Add classloader definition with a privateLibrary definition that is configured to point to your JDBC connector driver.

```
<server description="new server">
  <featureManager>
    <feature>jsp-2.2</feature>
  </featureManager>

  <httpEndpoint id="defaultHttpEndpoint"
    host="*"
    httpPort="9080"
    httpsPort="9443" />

  <application id="birt"
    name="birt"
    type="war"
    location="${server.config.dir}/apps/birt"
    context-root="/birt">
    <classloader delegation="parentLast">
      <privateLibrary>
        <fileset dir="${server.config.dir}/libs"
          includes="mysql-connector*.jar" />
      </privateLibrary>
    </classloader>
  </application>
</server>
```

13. Start your Liberty instance.
14. Browse to `http://server:port/birt`. The BIRT Viewer landing page opens.

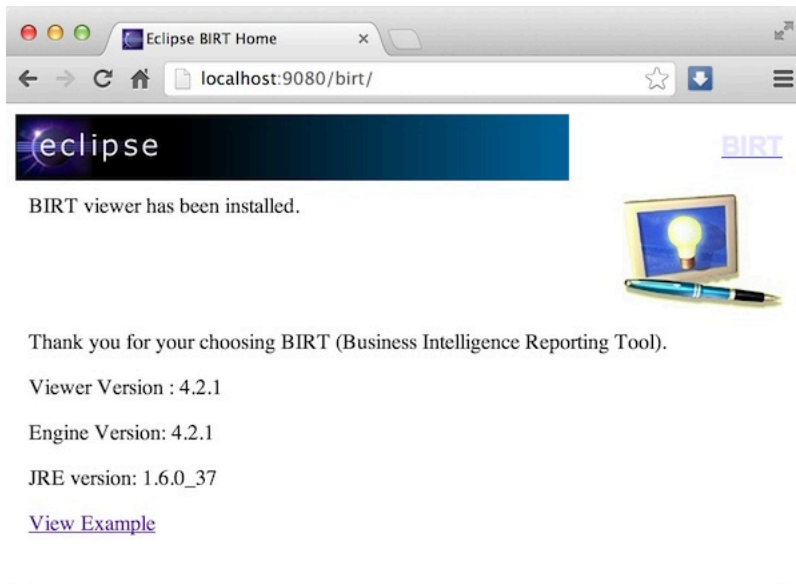

15. Click **View Example** link.
16. If you see the following error message, refresh your page.



17. The BIRT Viewer sample report appears.

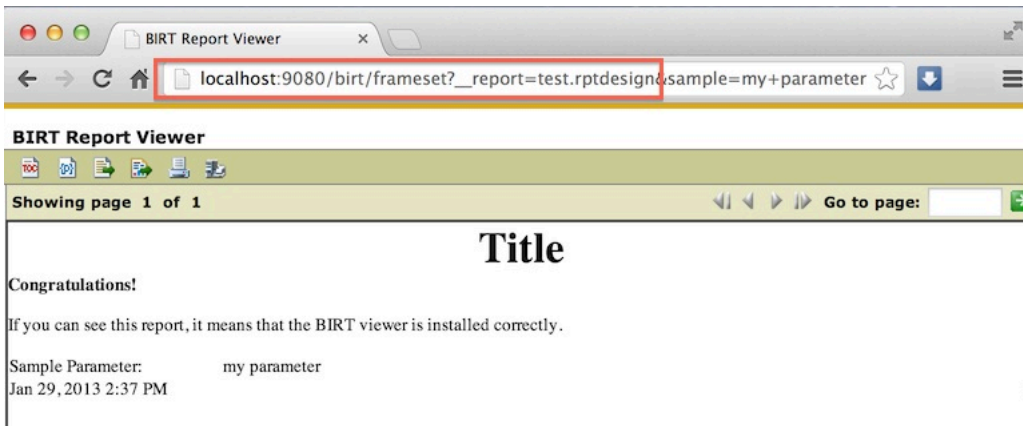

Note test.rptdesign in the page URL. You can replace this text with the name of other **rptdesign** files, as shown here for example:

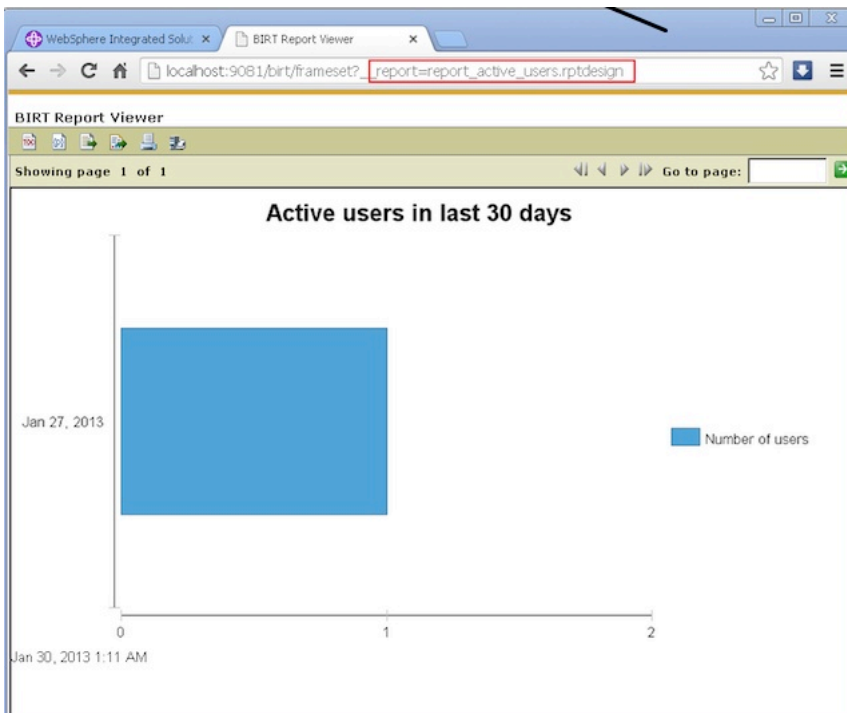

### Installing BIRT on WebSphere Application Server full profile

Complete these steps to install Business Intelligence Reporting Tools (BIRT) on WebSphere Application Server full profile.

## About this task

**Note:** The predefined BIRT reports and the Reports database and associated tables such as APP\_ACTIVITY\_REPORT are deprecated in IBM MobileFirst Platform Foundation for iOS V7.0.0. Use “Operational analytics” on page 12-8 instead. Note that setting up the Reports database is optional in this release and prior releases.

## Procedure

1. Download the BIRT package and extract the contents.
2. From the folder `birt-runtime-version\WebViewerExample\WEB-INF\lib`, delete (or remove) the following packages:
  - `org.apache.xerces.jar`
  - `org.apache.resolver.jar`
  - `org.apache.serializer.jar`

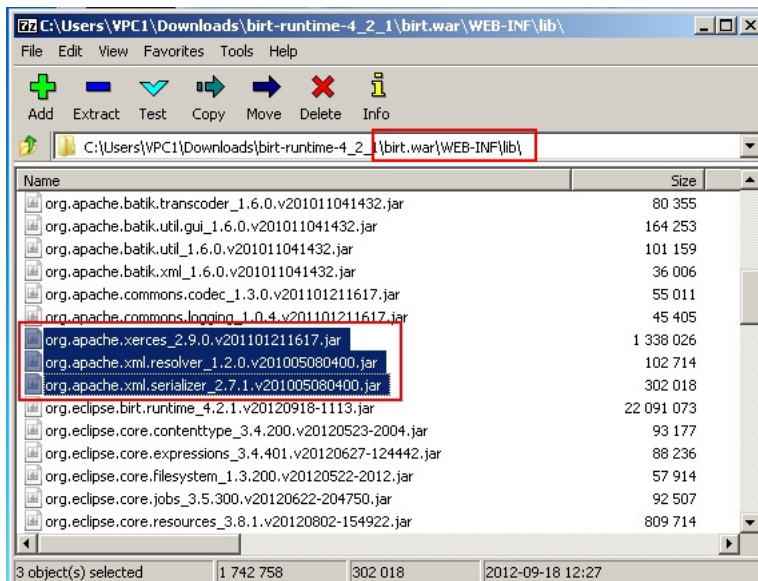

Figure 12-32. Deleting three files

3. Use a `.war` command to package the directory `WebViewerExample` into a WAR file named `birt.war`
4. Start the WebSphere Server.
5. Open the console web page.
6. Log in.
7. From the console, install BIRT package by installing `birt.war` from the runtime download.
8. Click **Enterprise Applications** in left menu.
9. Click the name of the deployed application, `birt_war`, to enter the configuration page.
10. Under the heading **Modules**, click **Manage Modules**.
11. In the Module list, click **Eclipse BIRT Report Viewer**.
12. In the **General Properties** page, under **Class loader order**, select the **Classes loaded with parent class loader first** option.
13. Click **OK**.

14. Save the Master Configuration.

## Configuring BIRT reports for your application server by using Ant

You can update your BIRT reports with your web application server settings by using Ant.

### About this task

**Note:** The predefined BIRT reports and the Reports database and associated tables such as APP\_ACTIVITY\_REPORT are deprecated in IBM MobileFirst Platform Foundation for iOS V7.0.0. Use “Operational analytics” on page 12-8 instead. Note that setting up the Reports database is optional in this release and prior releases.

To use BIRT reports, you must update them with your web application server settings and install them in your server web applications folder. The easiest way to do this is to specify a <reports> element in the Ant script that invokes the <configureapplicationserver> Ant task.

### Procedure

1. Ensure that the <configureapplicationserver> invocation has the inner element <reports todir=*web applications directory*/>. See “Ant tasks for installation of MobileFirst runtime environments” on page 14-16 for more details.
2. Invoke the Ant script, which copies the report templates from the WorklightServer/report-templates/ directory to the web applications directory, adjusting the <data-sources> element as needed.
3. Verify that the BIRT Viewer application is installed and running on your application server.
4. To view or edit a BIRT Report, go to the path `http://your-server/birt/frameset?__report=[report name].rptdesign.`, in which [report name].rptdesign represents one of the following files:

```
report_active_users.rptdesign
report_daily_hits.rptdesign
report_daily_visits.rptdesign
report_environment_usage.rptdesign
report_license_total_device_count.rptdesign
report_new_devices.rptdesign
report_notification_messages_per_day.rptdesign
report_notification_messages_per_source.rptdesign
```

## Manually configuring BIRT Reports for your application server

To use BIRT reports, you must update them with your web application server settings.

### About this task

**Note:** The predefined BIRT reports and the Reports database and associated tables such as APP\_ACTIVITY\_REPORT are deprecated in IBM MobileFirst Platform Foundation for iOS V7.0.0. Use “Operational analytics” on page 12-8 instead. Note that setting up the Reports database is optional in this release and prior releases.

Before using the BIRT Viewer application to see predefined reports, you must edit them to adjust the reports database settings, and then copy the reports to a specific folder on the application server.

## Procedure

1. Go to your IBM MobileFirst Platform Server installation folder created by the IBM Installation Manager.
2. Locate the \report-templates\ folder, which contains a set of .rptdesign files.
3. Copy all of the files with the .rptdesign extension from the \report-templates\ folder to your server web applications folder.
4. Edit each .rptdesign file as needed and adjust the **<data-sources>** element with the properties of your reports database.

```
<data-sources>
  <oda-data-source extensionID="org.eclipse.birt.report.data.oda.jdbc" ...>
    <list-property name="privateDriverProperties">
      <ex-property>
        <name>metadataBidiFormatStr</name>
        <value>ILYNN</value>
      </ex-property>
      <ex-property>
        <name>disabledMetadataBidiFormatStr</name>
      </ex-property>
      <ex-property>
        <name>contentBidiFormatStr</name>
        <value>ILYN</value>
      </ex-property>
      <ex-prperty>
        <name>disabledContentBidiFormatStr</name>
      </ex-property>
    </list-property>
    <property name="odaDriverClass">WLREPORT_DRIVER_CLASS</property>
    <property name="odaURL">WLREPORT_JDBC_URI</property>
    <property name="odaUser">WLREPORT_DBUSERNAME</property>
    <encrypted-property name="odaPassword" encryptionID="base64">
      WLREPORT_DBPASSWORD_BASE64
    </encrypted-property>
  </oda-data-source>
</data-sources>
```

5. Make sure that BIRT Viewer application is installed and running on your application server
6. To view or edit a BIRT Report, go to the path `http://your-server/birt/frameset?__report=[report name].rptdesign.`, where [report name].rtpdesign represents one of the following files:
  - report\_active\_users.rptdesign
  - report\_daily\_hits.rptdesign
  - report\_daily\_visits.rptdesign
  - report\_environment\_usage.rptdesign
  - report\_license\_total\_device\_count.rptdesign
  - report\_new\_devices.rptdesign
  - report\_notification\_messages\_per\_day.rptdesign
  - report\_notification\_messages\_per\_source.rptdesign

## BIRT in Eclipse

When BIRT is installed in Eclipse, it displays reports through the Eclipse interface.

**Note:** The predefined BIRT reports and the Reports database and associated tables such as APP\_ACTIVITY\_REPORT are deprecated in IBM MobileFirst Platform Foundation for iOS V7.0.0. Use “Operational analytics” on page 12-8 instead. Note that setting up the Reports database is optional in this release and prior releases.

You can install Business Intelligence Reporting Tools (BIRT) as either a stand-alone instance of Eclipse, or as a plug-in added to your existing IBM MobileFirst Platform Foundation for iOS Eclipse instance, or any other instance of Eclipse. Each of these choices has potential advantages, depending on your needs.

Installing a stand-alone Eclipse instance means having a dedicated tool for creating reports. This option involves downloading an Eclipse installer that comes with BIRT included.

Installing BIRT as a plug-in to your existing Eclipse instance that is running IBM MobileFirst Platform Foundation for iOS can provide you with a more integrated interface, for both IBM MobileFirst Platform Foundation for iOS and reports. Use the following links to select the option you want to install.

### **Installing BIRT in stand-alone Eclipse:**

You can install BIRT including the BIRT Report Designer in a stand-alone instance of Eclipse as a dedicated reporting tool.

#### **About this task**

To use the BIRT Report Designer in a stand-alone, dedicated instance of Eclipse, follow these steps:

#### **Procedure**

1. In your web browser, go to <http://www.eclipse.org/downloads/>
2. Download the **Eclipse IDE for Java and Report Developers**
3. Follow the Eclipse installation instructions in the installation package. Eclipse and the BIRT components, including the Report Designer, are installed along with Eclipse.

### **Installing BIRT in MobileFirst Eclipse:**

You can install BIRT in the instance of Eclipse on which IBM MobileFirst Platform Foundation for iOS is running, and use the Report Designer as an integrated tool.

#### **About this task**

To install BIRT in the existing instance of Eclipse that is running IBM MobileFirst Platform Foundation for iOS, follow these steps:

#### **Procedure**

1. Click **Help > Install new software**
2. In **Work with...**, select <http://download.eclipse.com/release/juno>
3. Select Business Intelligence Reporting and Charting
4. Click **Next** and follow the installation instructions. When the installation is completed, you must install the reports.
5. Click **Window > Open perspective > Other...**
6. Select the **Report Design** perspective
7. Click **File > New > Project**
8. Select **Report project** and click **Next**
9. Enter a project name and click **Finish**



- Using the import command, go to your MobileFirst Server installation folder created by IBM Installation Manager.
- Locate the \report-templates\ folder, which contains a set of .rptdesign files.
- Import all files with the suffix **.rptdesign** from the \report-templates\ folder into the Eclipse project. Eclipse comes with a bundled driver for Apache Derby database. If you use another database type, you must add a JDBC connector driver manually.
- Click **Manage Drivers...**
- Click **Add...** and add the JDBC connector driver package to communicate with your MobileFirst reports database
- Select **Driver Class** and adjust the rest of your database settings
- Click **Test Connection...** to validate that database settings are correct.

### Viewing BIRT reports in Eclipse:

With BIRT installed in Eclipse, you can view reports through the Eclipse interface.

### About this task

To view BIRT reports in Eclipse, follow these steps:

### Procedure

- Click the black arrow next to **View Report**.

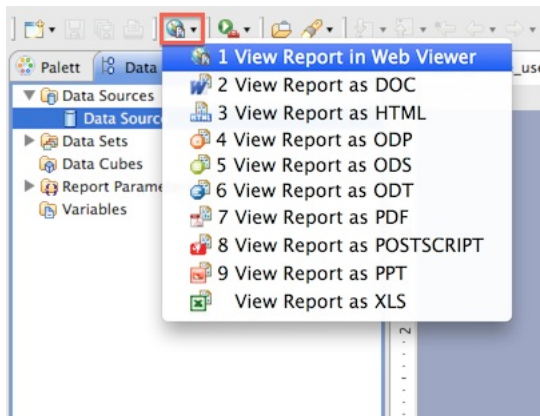

- Select the output format for your report
- View the report.

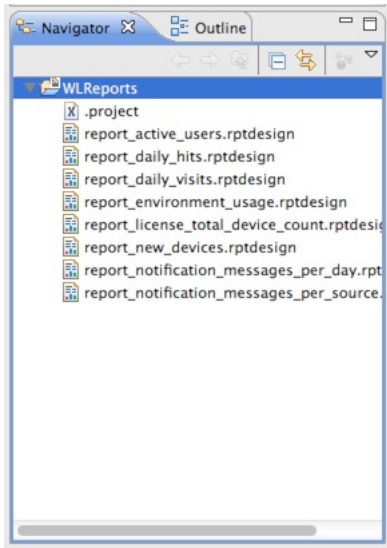

### Notification reports database schema

IBM MobileFirst Platform Foundation for iOS uses a database schema to store the notification reports data derived from the raw data.

**Note:** The predefined BIRT reports and the Reports database and associated tables such as NOTIFICATION\_ACTIVITIES are deprecated in IBM MobileFirst Platform Foundation for iOS V7.0.0. Use “Operational analytics” on page 12-8 instead. Note that setting up the Reports database is optional in this release and prior releases.

NOTIFICATION_ACTIVITIES	
SID varchar(255)	
NOTIFICATION_DATE date	
EVENT_SOURCE varchar(255)	
MEDIATOR varchar(255)	
TOTAL_NOTIFICATIONS int(11)	

Figure 12-33. NOTIFICATION\_ACTIVITIES schema

A notification activities table is populated to simplify the use of report construction. This notification activities table, **NOTIFICATION\_ACTIVITIES**, is populated as part of the analytics setup.

---

## Mobile application management

The Mobile Application Management feature enables mobile operators and administrators to securely track, search, and control access to users through the mobile applications that are used on their devices, all from the MobileFirst Operations Console.

The MobileFirst Server runtime tracks devices that access your mobile infrastructure by the MobileFirst apps that are used by your users. Each user, whether employee, customers, suppliers, or business partners, can use several devices to access your mobile environment through one or more apps that you deployed. IBM MobileFirst Operations Console now provides a view into this mapping of user to devices through the apps that are used to access your MobileFirst Server. Mobile operators and administrators can use the console to not only search for registered users by name, but also block access to a specific app from a specific user's device. They can also block any MobileFirst App that is installed on the device from connecting to the MobileFirst Server.

When multiple applications from the same enterprise are installed to the same device, it is desirable to disable access for all of the applications at once when the device is lost, stolen, or its security compromised. When these applications on the same device are authenticated to and routing traffic through a MobileFirst Server, administrators can disable access for all MobileFirst applications on that device.

In some cases, it might not be desirable to block access for every MobileFirst application that is installed on the device. MobileFirst application management features allow the administrator to view each individual application that is installed on a user's device and select which applications to block access.

When a MobileFirst application requires a certificate from the user to authenticate, the serial number of the certificate is recorded on the MobileFirst Server. In addition to viewing each application installed on a device, the certificate serial number can also be viewed in the MobileFirst Operations Console. This feature allows administrators to revoke access to an application installed on the device by using the serial number to locate and revoke the certificate.

IBM MobileFirst Platform Foundation for iOS maintains a database table of device IDs, among other device-related metadata, to enable this feature. In addition to the device ID column in the database, a status column is also kept. The possible status values are:

- active
- lost
- stolen
- expired (the device has not connected to this MobileFirst Server in 90 days) - configurable
- disabled

When a MobileFirst application from a device attempts to connect through the MobileFirst Server, the device ID is stored in the in-memory session data on the server. This device ID is checked against the database before any further processing of the inbound message. If the status column for this device ID is any value other than active, a 401 forbidden is returned. If the status is lost, stolen, or disabled, only an administrator with access to the MobileFirst Operations Console or direct database access can restore the status to the active state.

## User to device mapping and control

Starting in IBM Worklight V6.1.0, the MobileFirst Server tracks the devices that access the system as part of the core runtime database. You can now enable the user to device mapping feature, which provides the ability for mobile operators or administrators to query their mobile systems by user. A device friendly name can also be established to see the devices that are mapped to a user. Further, specific controls can be applied to a user-app-device mapping to either disable that link or reactivate that link to address common situations. For example, a user loses a device and must block all access from that device. Another example is the requirement to block access to an app across all devices, or block access to an app on a device, when a user changes departments. Reactivation is available for all of these disablement control actions.

For the user to device mapping feature to work, a security realm must exist that establishes the user identity. The user identity is then used to associate the MobileFirst Device ID with the user. Developers can create custom challenge handlers or specific API calls to set a device friendly name as preferred by the user, programmatically. This feature helps in querying the device by its friendly name.

The following list shows what a mobile operator or admin can do with this set of features:

- Search for a device by friendly name or search by user name.
- A matching search yields all devices that belong to that user or the single device and the associated user, along with device model and information.
- The apps that are used on the device to access this system are also displayed.

The following list shows the available actions that can be taken for a queried device:

- Disable the specific device, marking the state as lost or stolen so that access from any of the apps on that device is blocked.
- Re-enable a disabled device so that access from the device to the MobileFirst Server is allowed.
- Disable a specific app, marking the state as disabled so that access from the specific app on that device is blocked.
- Re-enable that specific app on the device so that access from the specific app on the device to the MobileFirst Server is allowed.

## Device access management in the MobileFirst Operations Console

In the MobileFirst Operations Console, administrators can search for devices that access the MobileFirst Server and can manage access rights.

In the search field, devices can be searched for by either the user ID (the ID that was used to log in to the Authentication Realm), or the friendly name (a name that is associated with the device to distinguish it from other devices that share the user ID)..

When a valid device is found, all devices that match the user ID or friendly name are listed.

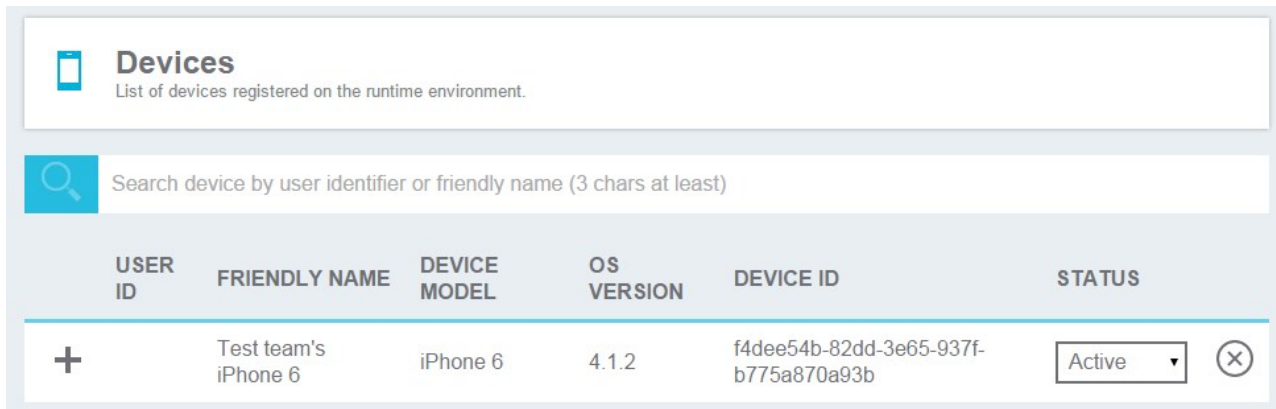

Figure 12-34. User or friendly name search

The Status column contains the current access rights of the device. Any device with the column marked as “Stolen”, “Lost”, or “Disabled” is not allowed to access MobileFirst Server. The “Expired” status is used only for licensing purposes. After successful connection to the server, any device with the status marked as “Expired” is allowed to access MobileFirst Server and its status is changed to “Active”. For more information about licensing, see “License Tracking report” on page 12-116.

Clicking the + icon in the column shows a list of all applications that this device accessed.

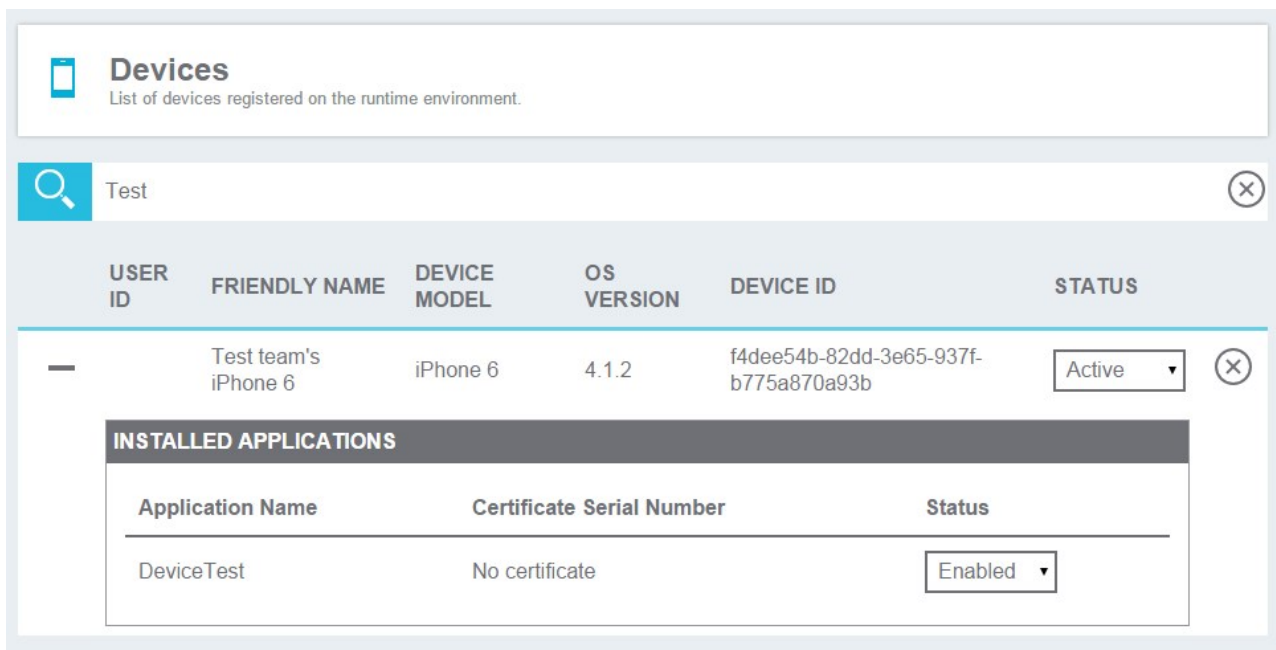

Figure 12-35. List of applications that are accessed by a device

Each row in the table contains the name of the application, the certificate serial number for this device-application pair (if enabled), and a status menu that is used to disable an application's access to the MobileFirst Server for this device.

## Enabling the device access management features

All devices that access the MobileFirst Server are recorded in the runtime database without any additional configurations. However, IBM MobileFirst Platform Foundation for iOS does not enforce the device access settings that are set from the MobileFirst Operations Console unless you enable a property on the MobileFirst Server.

### About this task

More processing is required on the MobileFirst Server when this property is enabled to enforce access management on devices. Appropriate performance testing must be done before production to measure how enabling this feature impacts the server's performance.

### Procedure

1. Set the `wl.device.enableAccessManagement=true` property on the MobileFirst Server (this value is false by default). The `wl.device.tracking.enabled=true` property must also be set (this value is true by default).
2. Capture the UserID. The user ID is recorded for the device automatically when the user logs in to an authentication realm that is marked as `isInternalUserID`. The following example shows a sample authentication configuration file:

```
<?xml version="1.0" encoding="UTF-8" standalone="no"?>
<tns:loginConfiguration xmlns:tns="http://www.worklight.com/auth/config"
    xmlns:xsi="http://www.w3.org/2001/XMLSchema-instance">
  <!-- Licensed Materials - Property of IBM
    5725-G92 (C) Copyright IBM Corp. 2006, 2013. All Rights Reserved.
    US Government Users Restricted Rights - Use, duplication or
    disclosure restricted by GSA ADP Schedule Contract with IBM Corp. -->

  <securityTests>
    <customSecurityTest name="DummyAdapter-securityTest">
      <test isInternalUserID="true" realm="SampleAppRealm" />
    </customSecurityTest>
  </securityTests>

  <realms>
    <realm loginModule="StrongDummy" name="SampleAppRealm">
      <className>com.worklight.core.auth.ext.FormBasedAuthenticator</className>
    </realm>
  </realms>

  <loginModules>
    <loginModule name="StrongDummy">
      <className>com.worklight.core.auth.ext.NonValidatingLoginModule</className>
    </loginModule>
  </loginModules>

</tns:loginConfiguration>
```

Since a security test can include several realms that require a user ID, only the realm that has the `isInternalUserID` property is recorded for the device in the runtime database. For a `mobileSecurityTest`, the realm that is set by the `testUser` element is used. For more information about security tests, see “Security tests” on page 8-249.

If the user is authenticated through the `UserCertificateAuthenticator`, the serial number that is generated for the certificate that is sent to the device is automatically saved in the runtime database.

## Performance implications for the server

You must consider two questions when you measure the Mobile Application Management feature and its impact on performance.

1. Does IBM MobileFirst Platform Foundation for iOS save information about a device when it accesses the server?
2. Does IBM MobileFirst Platform Foundation for iOS enforce access rights when a device tries to access the server?

### Saving device information

The MobileFirst administrator can control whether the server saves device information to the internal database when a device connects to the MobileFirst Server. This behavior is controlled by the following flag in the `worklight.properties` file:

```
wl.device.tracking.enabled=true
```

When this flag is enabled, the MobileFirst Server attempts to store information about the device each time a device begins a new session with the server. In terms of performance, this behavior results in a potential database write each time that a device starts a new session.

**Note:** This flag is enabled by default in production, and is used for license tracking. Do not disable this flag unless you fully understand the implications. For more information about licensing, see “License tracking” on page 12-115.

### Enforcing access rights

The MobileFirst Server tries to save the device information only on the first request of a session from the device. However, IBM MobileFirst Platform Foundation for iOS must enforce access rights on every request that is made to the server from the device. This behavior ensures that the rights that are set by the MobileFirst administrator take effect immediately. This feature can be controlled by the following flag in the `worklight.properties` file:

```
wl.device.enableAccessManagement=true
```

From a performance perspective, this behavior results in an extra database read that occurs each time that the device tries to access a resource on the server. The performance hit for the read is smaller than the write for saving device information. Administrators must consider the fact that this read occurs every time that a device tries to connect to the server. When this flag is disabled, the administrator can still view the devices in the database from the MobileFirst Operations Console. However, they cannot block access from the device to the MobileFirst Server.

### Space limitations for the database

Database administrators must consider how enabling the Mobile Application Management feature can affect the `Worklight` runtime database size. The Mobile Application Management feature does not affect the `Worklight` raw reports database. The following example shows a typical database row entry for a single device:

```
('db7abddf-3d5f-4b03-b3b8-f706e56e8306', 'Lucas', 'Tillman', '6.2', 'iPad2,5', '2013-10-08 15:12:32', 3)
```

For each application that the device uses, another entry is created as follows:

(db7abddf-3d5f-4b03-b3b8-f706e56e8306, 12, 0)

The size impact for each device is small. However, administrators must consider the potential size increases if their MobileFirst Server serves thousands of devices that use multiple applications that are hosted by the server. Devices can be deleted from the runtime database in the MobileFirst Operations Console, but each device entry has a Last Accessed time stamp column. That time stamp gives administrators the ability to clear out old rows that are no longer being used, by creating custom queries.

**Note:** Database rows that contain device information are used for licensing purposes. Database administrators must not delete data from these rows if the action of deleting the data affects licensing.

---

## User certificate authentication

Enterprises can now use X.509 client-side certificates to authenticate users, by applying a new user authentication realm to their existing security tests. This new realm is called UserCertificateAuthRealm. This feature allows enterprises to enroll users to their enterprise certificate authority (CA) directly from their mobile devices. The traffic between the MobileFirst application on the device and the MobileFirst Server in the enterprise can be secured over HTTPS with client-side certificates that are issued to the users as part of the initial enrollment process.

This feature is not supported with the FIPS 140-2 feature.

### User certificate authentication overview

The User Certificate Authentication feature is a newly introduced user authentication realm in IBM Worklight V6.1 that establishes user identity with an X.509 client certificate.

With the User Certificate Authentication feature, IBM MobileFirst Platform Foundation for iOS provides a mechanism for enterprises to easily integrate their mobile infrastructure and existing public key infrastructure (PKI). With this new added function, enterprises can now authenticate users that are trying to access sensitive backend systems through mobile devices with X.509 client side certificates. Mobile clients can now present an X.509 certificate to establish a secure client identity over the transport layer security (TLS) protocol.

This feature allows enterprises to use their existing PKI to obtain full control of the user authentication and user enrollment process. An embedded PKI implementation is provided, which allows enterprises without their own PKI to quickly set it up. With the embedded PKI option, IBM MobileFirst Platform Foundation for iOS internally signs certificates and manages the validation and enrollment process.

More specifically, mobile clients are now able to present an X.509 client certificate to establish a secure connection over the transport layer security (TLS) protocol. Users are enrolled to the enterprise certificate authority (CA) directly from their device. The client certificate is then used to authenticate and establish a user identity on subsequent requests.



## How it works

The MobileFirst Server can be configured to protect an application or adapter with the user certificate authentication user realm (UserCertificateAuthRealm). This realm requires the use of a PKI for managing X.509 client certificates. An existing PKI can be used by implementing the PKI bridge interface that is provided for you. The PKI bridge interface serves as the bridge between IBM MobileFirst Platform Foundation for iOS and your PKI. Another option is to use the embedded PKI that is provided with this feature for testing and development purposes.

The first time a user accesses a protected application or adapter procedure from a device, the server initiates the applicable challenges and starts the user enrollment process. The user enrollment process consists of having the user enroll into the configured PKI and then provisioning the device with an X.509 certificate for future use. Users enroll into existing PKIs through the help of a dependent user authentication realm. After the user is authenticated through the dependent realm, IBM MobileFirst Platform Foundation for iOS, through the PKI, generates the client certificate and provisions the device with the certificate that is issued to the user. The server enrolls the user after successfully establishing the user identity by using one of the pre-existing login modules. This process results in an X.509 certificate that is issued to the user and installed securely on the device.

The following figure shows the user enrollment flow:

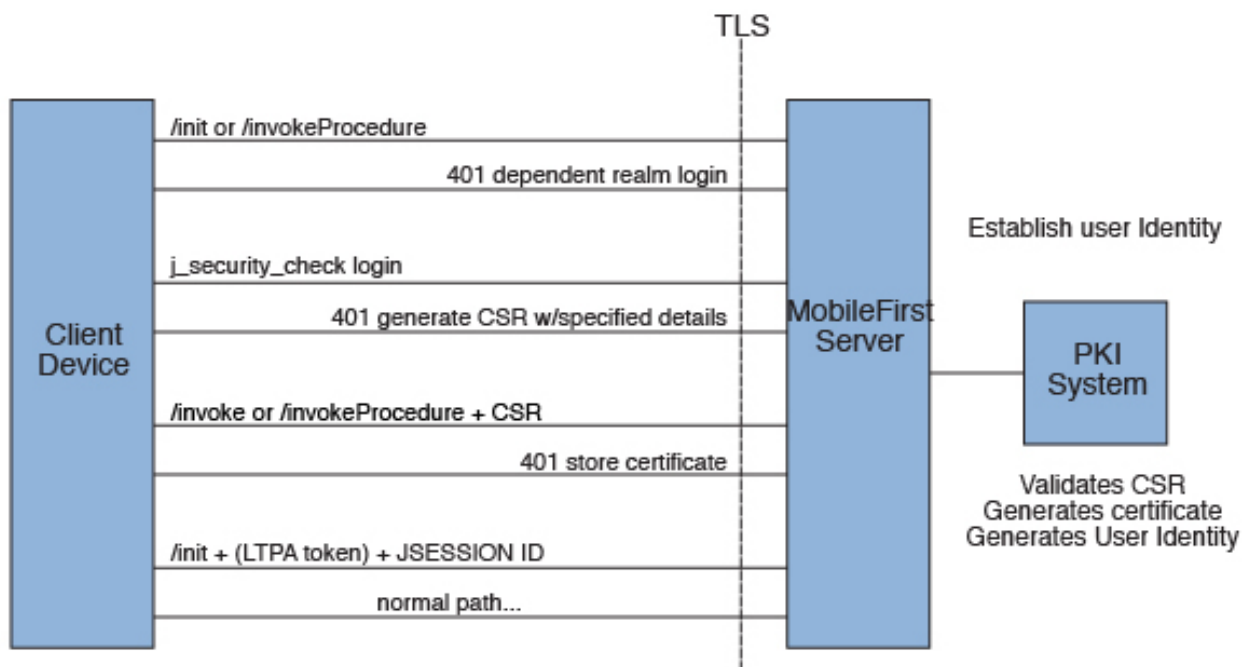

Subsequent calls from that MobileFirst application use this X.509 certificate to establish a secure connection over HTTPS, authenticate the user, and establish the user identity on the server. Users need to log in only once for the life of the certificate. When the certificate expires or is revoked by the PKI, the enrollment process is initiated again. You can allow user enrollment to continue, ban the user, or allow the user to log in only through the dependent realm.

Both the client and the server runtimes enforce certificate verification, ensuring that the client certificate is valid and is issued to a known user. The client certificate is

valid if it is issued by a trusted CA, is not expired and is not revoked, and its validity period is current. The server also verifies the client certificate's subject against a user registry to ensure that the client certificate was issued to a known user. Support for certificate revocation lists (CRL) is provided by the underlying Java Platform, Enterprise Edition server, and JVM. For more information about how to enable CRL support in WebSphere Application Server, see SSL configurations.

**Note:** Not all JVMs provide CRL support.

The following figure shows the client certificate authentication flow:

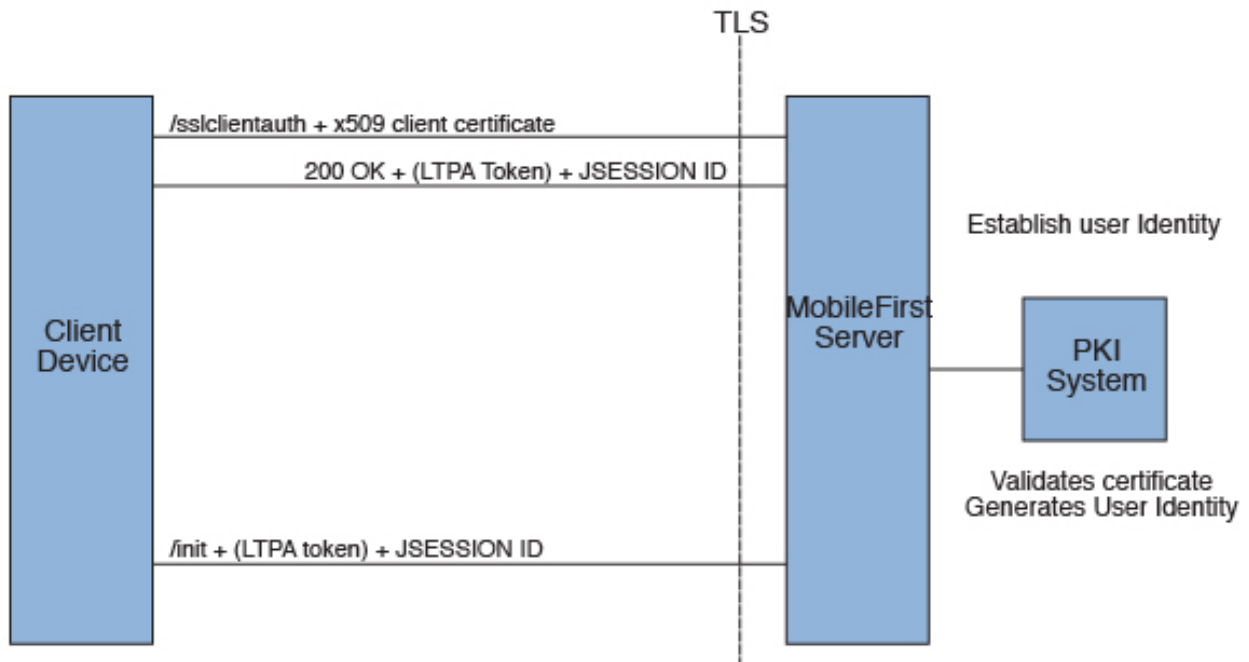

## User certificate authentication on the server

Both the MobileFirst Server and its hosting application server must be configured to use the User Certificate Authentication feature. The application server must be configured for client-side SSL. The MobileFirst Server must be configured with a PKI bridge and an appropriate security test to use the feature.

### SSL configuration

The User Certificate Authentication feature depends on the use of the Secure Sockets Layer (SSL) for authentication purposes. You can host your application only on HTTPS, unless a reverse proxy is being used.

For more information about how to configure SSL, see “WebSphere Application Server and Liberty profile requirements” on page 12-109.

The User Certificate Authentication feature requires integration with a public key infrastructure (PKI). For the embedded PKI option, you must provide a certificate authority (CA) that can be used to generate the client X.509 certificates.

## Certificates and CAs

Client certificates that are issued to the user by the User Certificate Authentication feature can be signed by a custom CA or a well-trusted CA through your PKI. Server-side certificates can be signed by either type of CA.

If you encounter errors with certificates that are not signed by well-trusted CAs, see “Configuring SSL by using untrusted certificates” on page 6-136.

**Restriction:** Self-signed certificates are not supported.

For more information about how to use and create an intermediate CA to sign both the server and client certificates, see the tutorials on the Getting Started page.

## Certificate chains, keystore, and truststore

You must set the server certificate as the MobileFirst Server keystore. Also, set the client’s certificate-signing CA as part of the truststore so that the server can trust the client certificates. For more information about setting up the server with these certificates, see “WebSphere Application Server and Liberty profile requirements” on page 12-109.

**Note:** If you use intermediate custom CAs, ensure that you concatenate the server certificate with the certificate chain. When you create the server certificate, use the following order:

Server certificate -> intermediate(s) in order -> trust anchor

The following example works in Mac OS X, and concatenates the server certificate with one intermediate CA and the trust anchor (root CA):

```
cat server/server.crt signingca/signing_ca.crt rootca/root_ca.crt > server_chain.crt
```

## PKI bridge configuration

The PKI bridge is an interface between the MobileFirst Server and a business' public key infrastructure (PKI). Each realm definition that uses the `WorklightCertificateAuthenticator` must have a PKI bridge that is defined in its configuration.

## User certificate identity versus standard MobileFirst user identity

The standard MobileFirst user identity contains basic user details and is built after a user realm is authenticated. The identity contains user name, display name, and extra attributes. The identity can be requested for each realm in a security test by authenticated resources, such as an adapter. For user certificate authentication, more details might be required, such as device ID and application name. These details are provided in the user certificate identity object that is sent to the PKI bridge.

A user certificate identity instance contains the following elements:

- Standard MobileFirst user identity
  - User name
  - Display name
  - Attributes
- Device ID
- Application name

## Embedded PKI bridge:

The embedded PKI bridge is an included PKI bridge that can be used with user certificate authentication. The embedded PKI bridge is available with the `com.worklight.core.auth.ext.UserCertificateEmbeddedPKI` class name and is configured by adding parameters to the realm definition.

The embedded PKI bridge is useful for developers without direct access to the business' PKI during testing. Administrators that are interested in testing the user certificate authentication feature without implementing their own PKI bridge can also use the embedded PKI bridge. The embedded PKI bridge is not recommended or supported for production environments.

## Requirements for use

For the embedded PKI bridge, a certificate authority (CA) certificate and private key must be available. The certificate and private key must be added to a keystore manually. The keystore must be in the PKCS #12 file format, such as a .p12 file. A password to access the keystore can be supplied optionally in plaintext form. If the .p12 file does not exist, cannot be read, or is supplied an invalid password, an error is thrown in the server trace. The following example shows a realm definition for `wl_userCertificateAuthRealm` with the embedded PKI:

```
<realm name="wl_userCertificateAuthRealm"
  loginModule="UserCertificateLoginModule">
  <className>com.worklight.core.auth.ext.UserCertificateAuthenticator</className>
  <parameter name="dependent-user-auth-realm"
    value="WASLTPARealm" />
  <parameter name="pki-bridge-class"
    value="com.worklight.core.auth.ext.UserCertificateEmbeddedPKI" />
  <parameter name="embedded-pki-bridge-ca-p12-password"
    value="capassword" />
  <parameter name="embedded-pki-bridge-ca-p12-file-path"
    value="/opt/ssl_ca/ca.p12" />
  <parameter name="embedded-pki-bridge-organization"
    value="IBM Worklight" />
  <parameter name="embedded-pki-bridge-add-cert-extensions"
    value="true" />
</realm>
```

## Configuration parameters

The following embedded PKI bridge parameters are available.

### **embedded-pki-bridge-ca-p12-file-path**

Required

Full file path of the .p12 file for the CA that signs user certificate requests.

### **embedded-pki-bridge-ca-p12-password**

Optional

Password in plaintext that is used to decode the CA .p12 file that is specified. No password is used if not specified.

### **embedded-pki-bridge-organization**

Optional

Organization name that is added to the distinguished name (DN) inside a signed certificate (O=<organization name specified>). If not specified, no organization is added to the DN.

### **embedded-pki-bridge-add-cert-extensions**

Optional

Add non-critical MobileFirst custom certificate extensions to the user certificate before it is signed. This parameter provides more details to user identity attributes on subsequent runs. These details include device ID, group ID, and application name that is stored in the certificate. By default, this parameter is false. You can enable the parameter by using the true value. This parameter is not always supported and may not work for your configured server configuration. You must test this option first on your infrastructure to ensure that a certificate is not marked invalid if extensions are enabled. When this parameter is enabled, the device ID is added with the OID 1.3.6.1.4.1.2.6.256.1 and the app name is added with the OID 1.3.6.1.4.1.2.6.256.2. These OIDs are not formally registered and may change.

#### **embedded-pki-bridge-days-before-expire**

Optional

Configure the length of time the generated certificate is valid. This setting defaults to one year (365 days).

#### **embedded-pki-bridge-crl-uri**

Optional

Configure an optional CRL for your certificate authority. If the certificate that is generated exists on a client's device and is revoked in the CRL, the client is required to generate a certificate.

#### **External/adapter-based PKI bridge:**

The adapter-based PKI bridge is an included PKI bridge that can be used with user certificate authentication. The adapter-based PKI bridge is available with the `com.worklight.core.auth.ext.UserCertificateAdapterBasedPKI` class name, and is configured by adding parameters to the realm definition. An adapter is required for this PKI bridge to work, and must be uploaded before any user connects with this configuration. The adapter-based PKI bridge is useful if your PKI can be accessed with an adapter (such as a REST API).

#### **Requirements for use**

For the adapter-based PKI bridge, an adapter must be added in the console and the parameters for the bridge must be configured in the realm definition. The following example shows a realm definition for `wl_userCertificateAuthRealm` with the adapter-based PKI that uses an adapter that is called `PKIAdapter`:

```
<realm name="wl_userCertificateAuthRealm"
  loginModule="UserCertificateLoginModule">
  <className>com.worklight.core.auth.ext.UserCertificateAuthenticator</className>
  <parameter name="dependent-user-auth-realm"
    value="WASLTPARealm" />
  <parameter name="pki-bridge-class"
    value="com.worklight.core.auth.ext.UserCertificateAdapterBasedPKI" />
  <parameter name="adapter-pki-bridge-init-procedure"
    value="PKIAdapter.init" />
  <parameter name="adapter-pki-bridge-identity-validation-procedure"
    value="PKIAdapter.validateIdentity" />
  <parameter name="adapter-pki-bridge-csr-requirements-procedure"
    value="PKIAdapter.getCSRRequirements" />
  <parameter name="adapter-pki-bridge-csr-validation-procedure"
    value="PKIAdapter.validateCSR" />
  <parameter name="adapter-pki-bridge-certificate-generation-procedure"
    value="PKIAdapter.generateCertificate" />
  <parameter name="adapter-pki-bridge-identity-from-certificate-procedure"
```

```

    value="PKIAdapter.getIdentityFromCertificate" />
<parameter name="adapter-pki-bridge-certificate-validation-procedure"
    value="PKIAdapter.validateCertificate" />
</realm>

```

## Configuration parameters

The following adapter-based PKI bridge parameters are available.

### adapter-pki-bridge-init-procedure

Required

An adapter procedure that is called to initialize the PKI bridge on each call. Requires a single parameter for the configuration that is available in the realm definition. The following example shows a sample value of this parameter:

```

{"adapter-pki-bridge-csr-validationprocedure": "
PKIBridgeAdapter.validateCSR", "adapter-pki-bridge-identity-fromcertificate-
procedure": "PKIBridgeAdapter.identityFromCertificate", "pkibridgetclass": "
com.worklight.core.auth.ext.UserCertificateAdapterBasedPKI", "adapterpki-
bridge-identity-validationprocedure": "
PKIBridgeAdapter.identityVerify", "adapter-pki-bridge-csrrequirements-
procedure": "PKIBridgeAdapter.csrRequirements", "adapter-pkibridget-
certificate-generationprocedure": "
PKIBridgeAdapter.generateCertificate", "adapter-pki-bridgertificate-
validationprocedure": "
PKIBridgeAdapter.certificateVerify", "adapter-pki-bridge-initprocedure": "
PKIBridgeAdapter.init", "dependent-user-authrealm": "
WASLTPARealm"}

```

### adapter-pki-bridge-identity-validation-procedure

Optional

An adapter procedure that is called that allows the adapter to determine whether the user identity from the dependent realm is allowed to generate a certificate. This procedure is optional. By default, the PKI bridge always returns YES. Requires a single userIdentity parameter. The following example shows a sample value of this parameter:

```

{"deviceId": "C146B473-DA25-46A7-8A79-E8CE5E9270EE", "userIdentity":
{"userName": "user@ibm.com", "attributes":
{"LtpaToken": "dHwRqHp61ukJCKEFBMRd6g63uV1bDg0rmGBU2cuBrinFp+7L7BVb
+40ebyIRMOoKLhH1dLxj9JIPiWH4s16tHtNjddBxxbd9rdjZUgnicVY8+6GM8uTEw1eRW
+1VzzwJX0Htvfa2iQQD9KAWLXkNHgneiELIANjAUxGsMzJGGg2K8LYYWeBhE0JGqJcb8WFFLYH4T5
Cgb9C+qXpre/KF/MNTrv2WQF9kWjPmM1PuT1Lh1tY9oSSqN20DNNZ8VcQ8p26po5yBMvtDMtn4/
EzfdhKYeTNFzQEmQpR66caQJ1RV++m/
Oq4EiZBBzk0Y6zpBVtmUzcH3D2xh5PYVvcF08g=="}, "displayName": ""}, "appId": "UserCert"}

```

The procedure must return an object with the following format:

```
{valid: "YES"}
```

Options for valid:

- YES - The user is allowed to generate a certificate.
- NO\_USE\_DEPENDENT\_REALM\_ONLY - The user is allowed to log in to the dependent realm, but is not allowed to generate a certificate.
- NO - The user is not allowed to log in at all, and is not allowed to generate a certificate.

### adapter-pki-bridge-csr-requirements-procedure

Optional

Build a set of requirements that must be in a CSR that the client generates. This procedure is optional. By default, the CSR requirements include the

commonName that is equal to the user name from the dependent realm user identity. The procedure has a single parameter that is called userIdentity with the following format:

```
{"deviceId": "C146B473-DA25-46A7-8A79-E8CE5E9270EE", "userIdentity":
{"userName": "user@ibm.com", "attributes":
{"LtpaToken": "dHwRqHp61ukJCKEFBMRd6g63uV1bDg0rmGBU2cuBrinFp+7L7BVb
+40ebyIRM0oKLhH1dLxj9JIPiWH4s16tHtNjddBxxbd9rdjZUgnicVY8+6GM8uTEw1eRW
+1VzzwJX0Htvfa2i0QD9KAWLXkNHgneiELIANjAUxGsMzJGGg2K8LYYWeBhE0JGqJcb8WFFLYH4T5
Cgb9C+qXpre/KF/MNTrv2WQF9kWjPmM1PuT1Lh1tY9oSsqN20DNNZ8VcQ8p26po5yBMvtDMtn4/
EzfdhKYeTNFzQEmQpR66caQJ1RV++m/
0q4EiZBBzk0Y6zpBVtmUzcH3D2xh5PYVcF08g="}, "displayName": ""}, "appId": "UserCert"}
```

This procedure must return a JSON object in the following format:

```
{ commonName: "user@ibm.com", additionalSubject: { "0": "IBM" }, additionalAttributes: {} }
```

- commonName - This attribute is a required entry that is used as the CN attribute in the CSR. This value must match a user in the user registry of the application server.
- additionalSubject - This attribute is a required JSON object that contains key/value pairs for each additional attribute that must be in the subject of the CSR, such as 0 for organization. If no additional attributes are required, use an empty JSON object.
- additionalAttributes - This attribute is a required JSON object that contains key/value pairs for each additional attribute that must be included in the CSR. If no additional attributes are required, use an empty JSON object.

#### adapter-pki-bridge-csr-validation-procedure

Optional

This procedure is called after a client sends a CSR that follows a request. It is responsible for ensuring that all of the CSR attributes that were requested in the requirements exist in the CSR. This procedure is optional. By default, the PKI bridge always returns YES. The procedure has a single parameter csr that contains a JSON object with the following format:

```
{"csr": "MIICXZCCAUCADAbMRkwFwYDVQDFBBSaXpldEB1cy5pYm0uY29tMIIIBIjANBgkqhkiG9w0
BAQEFAAOCAQ8AMIIBCgKCAQEAt9A8WLa0NqAji zn9ccZFUPBLCCGEBUCUQAgnPZKcf3wW2LhQ75
MEMfLyahZvqSBF7IMMstRrpKiobx6PTGiMCKNB710zNa88tCHv81+wHaTIu2QggqpBMFPhvBdTbS
93pafEQ7kXEGBK+uU7vwalUIHQyQT1+9ZaiH4ssf8Ybi
+qYmGr0H4Cjv07h9310sAy00WqcGBn0Ccb1+YJP9F/
EyHLNfdr1FTDAAp0ERtUqVMDeJIRxscFnqZ1GG0rXCEJqA13IHvrn6BiLrmQ0xA5oE
+Lk4ry6ci zw1yxYY1mWZq9eTCQqBmGBS/Aa+4KB0G3NCCL
+e4YKN2RJ0m2bcHRswIDAQABoAAADQYJKoZIhvcNAQEFBQADggEBAHh0JbrGBCZCiDi3hXzVzji7
1euKMf8IUjGe+sfr+Sy5sfx9k
+icvKixImHCxSy0PeKp4QICSGfZxk2xQzHhYVgdeB0Uuv2WT7FjPngRjAgLL1jxu7LIkEMKwgiGiJMPg
54g0x8kWuj5uE9vqpWGRK0dGuPN1nQxh50pSgzi4PhRGz2nCBF6WdQFNmHDqssi jk//
CUHWbNvMTIWyuhHxEhtwkp1c0dAp1b3hHBYwYM9Vae9fUmfpbHDb0yvjBjCHvceRjwkoQG6ABfh9
9ucE1NW051Rc03XqGnHksnk16B1qSH0YpM/sVWYrmio/F9h75aNx+Sz5EhkB7t/n4301aP0o="}
```

**Note:** csr is the CSR in DER format and is represented in base64.

The procedure must return a JSON object with the following format:

```
{valid: "YES"}
```

or

```
{valid: "NO"}
```

Options for valid:

- YES - The CSR meets the requirements from the PKI.
- NO - The CSR does not meet the requirements from the PKI. Authentication fails.

## adapter-pki-bridge-certificate-generation-procedure

Required

This procedure is responsible for requesting a certificate from the PKI and returning a certificate. This procedure is required and has one required parameter `csr`, which has the following format:

```
{ "deviceId": "C146B473-DA25-46A7-8A79-
E8CE5E9270EE", "csr": "MIICXzCCAUCADAbMRkwFwYDVQQDFBBsaXpldEB1cy5pYm0uY29tMIIBIjA
NBgkqhkiG9w0BAQEFAAOCAQ8AMIIBCgKCAQEAt9A8WLa0NqAjjzn9ccZFUPBLCCGEBUCUQAgnPZK
cf3ww2LhQ75MEMfLyahZvqSBF7IMMstRrpKioBx6PTGiMCKNB710zNa88tChv81+wHaTIu2Qggq
pBMFPbvBdTbS93paFEQ7kXEGbK+uU7vwa1UIHQyQT1+9ZaiH4ssf8Ybi
+qYmGr0H4Cjv07h9310sAy00WqcGBn0Ccb1+YJP9F/
EyHLNfdr1FTDAAp0ERTUqVMDDeJIRxscFngZ1GG0rXCEJqA13IHvrn6BiLrmQ0xA5oE
+Lk4ry6ciZw1yxYY1mWzq9eTCQqBMGBS/Aa+4KB0G3NCCL
+e4YKN2RJ0m2bcHRswIDAQABoAAwDQYJKoZIhvcNAQEFBQADggEBAHh0JbrGBCZCiDi3hXzVzji7
1euKMf8IUjGe+fr+Sy5sfx9k
+icvKixImHCxSy0PeKp4QICSgfZxk2xQzHhYVgdeB0Uv2WT7FjPngRjAgLL1jxu7LIkEMKwgiGiJMPg
54g0x8kWuj5uE9vqpWGRK0dGuPN1nQxh50pSgZi4PhRGz2nCBF6WdQFNmHDqssijk//
CUHwbnvMTIWyuHhXEhtwkp1c0dAp1b3hHByYM9Vae9fUmfpbHDb0yvjBjChvceRjwkoQG6ABfh9
9ucE1NW051Rc03XqGnHksnk16B1qSH0YpM/sVWYrmio/F9h75aNX+Sz5EhkB7t/
n4301aP0o=", "userIdentity": {"userName": "lizet@us.ibm.com", "attributes":
{"LtpaToken": "dHwRqHp61ukJCKeFBMRd6g63uV1bDg0rmGBU2cuBrinFp+7L7BVb
+40ebyIRM0oKLhH1dLxj9JIPiWH4s16tHtNjddBxxbd9rdjZUgnicVY8+6GM8uTEw1eRW
+1VzzwJX0Htvfa2iQQD9KAWLXkNHgneiELIANjAUxGsMzJGGg2K8LYYWehE0JGqJcb8WFFLYH4T5
Cgb9C+qXpre/KF/MNTrv2WQF9kwjPmM1PuT1Lh1tY9oSSqN20DNNZ8VcQ8p26po5yBMvtDMtn4/
EzfdhKYeTNFzQEmQpR66caQJ1RV++m/
Oq4EiZBBzk0Y6zpbVtmUzch3D2xh5PYYVcF08g="}, "displayName": ""}, "appId": "UserCert"}
```

**Note:** `csr` is the CSR in DER format and is represented in base64.

The procedure must return a base64 string of the X.509 certificate in DER format in a JSON object with the following format:

```
{ certificateBase64: "<BASE64 STRING OF THE X.509 CERTIFICATE>" }
```

## adapter-pki-bridge-certificate-validation-procedure

Optional

This procedure is responsible for validating a user's certificate when it is first received. This procedure is optional. If it is not used, the PKI bridge always returns YES. The procedure has one parameter `certificate` that is in the same format as the procedure in the `adapter-pki-bridge-identity-from-certificate-procedure` parameter.

The procedure is required to return a JSON object that states the validity of the certificate:

```
{valid: "YES"}
```

or

```
{valid: "NO"}
```

Options for `valid`:

- YES - The certificate is considered valid by the PKI.
- NO - The certificate is not considered valid by the PKI, and the client is required to start the enrollment process over.

## adapter-pki-bridge-identity-from-certificate-procedure

Required

This procedure is responsible for creating a user certificate identity from a certificate that is passed by the user. The procedure must have one parameter `certificate` with the following format:



```

{"publicKey":
{"base64": "MIIBIjANBgkqhkiG9w0BAQEFAAOCAQ8AMIIBCgKCAQEAt9A8WLa0NqAjzn9ccZFUPBLC
CGEBCUQAgNPZKcf3wW2LhQ75MEMfLyahZvqSBFd7IMMstRrpKioBx6PTGiMCKNB710zNa88tChv8
1+wHaTIu2QggqBMFPhvBdTbS93paFEQ7kXEGBk+uU7vwa1UIHQyQT1+9ZaiH4ssf8Ybi
+qYmGrOH4Cjv07h9310sAy00WqcGBnOCcb1+YJP9F/
EyHLNfdr1FTDAAp0ERTUqVMDeJIRxscFnqZ1GG0rXCEJqA13IHvrn6BiLrmQ0xA5oE
+Lk4ry6ciw1yxYY1mWzq9eTCQqBMGBS/Aa+4KB0G3NCCl
+e4YKN2RJ0m2bcHRswIDAQAB", "algorithm": "RSA"}, "signature":
{"base64": "cONA8EKQBiIKtdhAzG68pm0FMRkNfbVAIyZ1tpp+J9nXYmj0/
aG0Ejk37oGzEPT05uA/
eDArvQ9WF3Btz0dF9hw4j3ACJjo5oEnD7UTXbPzK2k1w3INX4cu0InLi7EJEKb
+Cu05uMy1mU0jx1aj/WaK
+E2KroFKNPyXdHAL7mwpkZ00aSYxUYyWcu8IAureMMWZGps196Swk1YptboIEUSd5r3j07rBZX81B
AX5awqEx3tpbP3qpIJK+6xoiu2tL67mKqJj911/Yb/
qMUG6ouJtt9fWYU07p1wJgUm9N0eixXftKttJ32Fp/
s0B7R72nt09pGPrkYt8IUkzSq22Q=="}, "algorithm": "SHA1withRSA"}, "subjectUniqueId": "", "version":
:1, "issuer": {"dn": "CN=Worklight Test Beta Signing CA,OU=Security Division,O=IBM
Worklight,L=Austin,ST=TX,C=US", "cn": "Worklight Test Beta Signing
CA", "uniqueId": ""}, "dn": "CN=user@us.ibm.com", "cn": "user@us.ibm.com", "valid": {"notBefore":
1381193593, "notAfter":
1382403193}, "serialNumber": "efa7b0e3f0d9cef0", "base64": "MIIDIZCCAgSCCQDvp7Dj8Nn08DA
NBgkqhkiG9w0BAQUFADCBizELMAkGA1UEBhMCMVVMxCzAJBgNVBAGTA1RYMQ8wDQYDVQQHEWZ
BdXN0aW4xZjAUBGNVBA0TDU1CTSBXb3JrbGlnaHQxGjAYBgNVBASTEVN1Y3VyaXR5IERpdmlzaW9u
MSowKAYDVQQDEyFxB3JrbGlnaHQgR2FycmljayBCZXRhIFNpZ25pbmcgQ0EwHhcNMTMxMDA4M
DA1MzEzWhcNMTMxMDA1MzEzWjAbMRkwFwYDVQQDFBBSaXpldEB1cy5pYm0uY29tMIIBIjA
NBgkqhkiG9w0BAQEFAAOCAQ8AMIIBCgKCAQEAt9A8WLa0NqAjzn9ccZFUPBLCGEBUQAgNPZK
cf3wW2LhQ75MEMfLyahZvqSBFd7IMMstRrpKioBx6PTGiMCKNB710zNa88tChv81+wHaTIu2Qggq
pBMFPhvBdTbS93paFEQ7kXEGBk+uU7vwa1UIHQyQT1+9ZaiH4ssf8Ybi
+qYmGrOH4Cjv07h9310sAy00WqcGBnOCcb1+YJP9F/
EyHLNfdr1FTDAAp0ERTUqVMDeJIRxscFnqZ1GG0rXCEJqA13IHvrn6BiLrmQ0xA5oE
+Lk4ry6ciw1yxYY1mWzq9eTCQqBMGBS/Aa+4KB0G3NCCl
+e4YKN2RJ0m2bcHRswIDAQABMA0GCSqGSIb3DQEBBQUAA4IBAQBw40DwQo5AGIqq12EDMbry
mbQUxGQ19tUAjJmW22n4n2ddaM79oY4QmTfugbMQ9M7m4D94MCu9D1YXcG3M50X2HdiPcA
Im0jmgScPtRNdS/MraTXDcg1fhy44icuLsQkQpv4K47m4zLWZQ6PHVqP9Zor4TYqugUo0/
Jd0cAvubCmRk7RpJjFRhjBy7wgC6t4xZkamzX3pLCTVimluggRRJ3mvePTusF1fzUEBf1rCoThe21s/
eqkggr7rGiK7a0vrUyqomP2XX9hv+pCZSDqi4m2319ZhQ7unXAmBSb03R6LFd+0q20nfYwn
+zQHTHvae072kY+uRi3whSTNKRbZ"}

```

**Note:** base64 is the DER formatted certificate. publicKey is also encoded in base64.

The procedure must return a JSON object in the following format:

```
{ userName:"user@us.ibm.com",displayName:"",attributes:{},appID:"UserCert",deviceId:"C146B473-DA25-46A7-8A79-E8CE5E9270EE" }
```

The goal of the JSON object that is returned is to form the original user identity of the user that is provided by the dependent realm during generation.

**Note:** appId and deviceId are optional in this step. If not used, use an empty string as the value.

### Custom PKI bridge:

A custom PKI bridge can be implemented by extending the `com.org.auth.ext.UserCertificatePKIBridge` abstract class.

The API for the PKI bridge abstract class can be found at `UserCertificatePKIBridge`.

### WebSphere Application Server and Liberty profile requirements

User certificate authentication uses standard SSL X.509 User Certificates, which requires the use of an SSL channel.

There are a few requirements around SSL that must be configured in order for user certificate authentication to work.

- The SSL channel for WebSphere Application Server or the Liberty profile must be configured to include the certificate authority (CA) in the trust store that is used to sign user certificates.
- The application server must be configured to allow a user certificate, but not require it. This configuration is important so that IBM MobileFirst Platform Foundation for iOS can send unauthenticated challenges to the device when the device does not provide a user certificate.
- The user registry for the application server must be defined. The name that is used to authenticate a user against that user registry must match the common name (CN) in a generated user certificate.
- The User Certificate Authentication feature requires the server to be configured to require a valid X.509 client certificate. The feature also requires an alternate fallback authentication mechanism when a certificate does not yet exist on the client. WebSphere Application Server Liberty Profile Versions 8.5.5.0 and 8.5.5.1 allow a basic authentication, or a HTTP 401 status code, as a fallback to authenticate a user. However, a MobileFirst client cannot handle this configuration. If you want to protect the MobileFirst Server with the WebSphere Application Server Liberty Profile security mechanisms, you must install a fix for APAR PI10103 for Liberty Versions 8.5.5.0 and 8.5.5.1. For more information, see PI10103: Support certificate authentication to fail over to a form-based login.

### Configuring the Liberty profile:

You must enable an HTTPS endpoint in WebSphere Application Server Liberty profile that uses the server's certificate, and trusts the client certificates.

#### Before you begin

Ensure that you understand the documentation at Enabling SSL communication for the Liberty profile. To set up the MobileFirst Server, see the WebSphere Application Server Liberty profile documentation about setting up SSL for the server at Liberty profile: SSL configuration attributes.

#### About this task

The application server requirements can be configured on the WebSphere Application Server Liberty profile in the `server.xml` file.

#### Procedure

1. Install a server certificate for use by the SSL channel, and configure the SSL channel.
2. Add a truststore to the configuration that contains a keystore with the CA certificate that is used to sign user certificates. Add the following element to the `server.xml` file:

```
<keyStore id="defaultTrustStore" location="trust.jks" type="JKS" password="defaultPWD" />
```
3. Enable the client authentication support by adding the `clientAuthenticationSupported="true"` attribute to the SSL element in the `server.xml` file.
4. Access the MobileFirst Operations Console over SSL. You are presented with a trusted website that asks for an optional user certificate.

### Updating the server authentication configuration

A requirement to enable the User Certificate Authentication feature is to configure the authentication configuration on the MobileFirst Server.

## About this task

You must update the `authenticationConfig.xml` file to configure your server to use the User Certificate Authentication feature. User certificate authentication uses standard MobileFirst authentication mechanisms: authenticator and login modules. The `com.worklight.core.auth.ext.UserCertificateAuthenticator` and the `com.worklight.core.auth.ext.UserCertificateLoginModule` modules are bundled with the core MobileFirst Server library.

## Procedure

1. From within your server configuration, open the `authenticationConfig.xml` file for editing.
2. Add a realm definition inside the `<realms>` attribute in your `authenticationConfig.xml` file.

```
<realm name="wl_userCertificateAuthRealm"
  loginModule="UserCertificateLoginModule">
  <className>com.worklight.core.auth.ext.UserCertificateAuthenticator</className>
  <parameter name="dependent-user-auth-realm"
    value="<DEPENDENT REALM NAME HERE>" />
  <parameter name="pki-bridge-class"
    value="<PKI BRIDGE CLASS>" />
</realm>
```

3. Modify this realm definition by supplying your own dependent realm by specifying its name for the `dependent-user-auth-realm` parameter and a PKI bridge implementation (full Java class path) for the `pki-bridge-class` parameter. You can use the included PKI bridge classes such as embedded (“Embedded PKI bridge” on page 12-104) or adapter-based (“External/adapter-based PKI bridge” on page 12-105) or supply your own custom PKI bridge implementation (“Custom PKI bridge” on page 12-109).
4. Add your custom parameters to this realm definition based on your PKI bridge implementation. Bundled PKI bridge implementations such as Embedded (“Embedded PKI bridge” on page 12-104) or Adapter-Based (“External/adapter-based PKI bridge” on page 12-105) have extra required parameters that must be added.
5. Add the following login module definition, as-is, to your `<loginModules>` element in the `authenticationConfig.xml` file.

```
<loginModule name="UserCertificateLoginModule">
  <className>com.worklight.core.auth.ext.UserCertificateLoginModule</className>
</loginModule>
```

6. Add the `wl_userCertificateAuthRealm` realm as a test in the security test that you want to use for your application or environment.
7. Add the security test to the resource you want to protect. To protect an adapter procedure, add the `securityTest` attribute for the procedure. For more information, see “Structure of the adapter XML file” on page 8-96 and “Security tests” on page 8-249. To protect an application environment, define a security test for each environment in the `application-descriptor.xml` file, by using the `securityTest="your_test_name"` property. If no security test is defined for a specific environment, only a minimal set of default platform tests are run.

```
<securityTest name="your_test_name">
  <testUser realm="wl_userCertificateAuthRealm" />
  <testDeviceId provisioningType="none" />
</securityTest>
```

**Note:** To protect your application or adapter procedure, reference your security test in your application descriptor file.

```
<iphone bundleId="com.UserCertApp" version="1.0" securityTest="your_test_name">
```

## User certificate authentication on the client

The User Certificate Authentication feature requires little configuration on the client side. The MobileFirst client run time takes care of most of the heavy lifting on your behalf. There are however, a few things you need to be aware of to ensure successful and secure communication with your server.

### Establishing trust

Because the User Certificate Authentication feature requires communication over HTTPS, the first thing you must ensure is that your client device trusts the server's credentials that are sent on the SSL handshake.

Each mobile platform comes with a predefined set of trusted certificate authorities (CAs) that are deemed trustworthy by the platform. Trust is easily established if your server uses a server certificate that is signed by one of these trusted CAs.

However, if your server uses a CA that is unknown to your device, you must do some extra work on the client side to establish appropriate trust. To establish trust, you must install the trust anchor certificate on the client device. The trust anchor is either the root CA, or the root certificate if you are using a self-signed certificate. For more information, see “Configuring SSL by using untrusted certificates” on page 6-136.

### Dependent user realm

The first time a user attempts to connect to the server, IBM MobileFirst Platform Foundation for iOS tries to enroll the user into the PKI and provision the device with the user certificate. To enroll the user, IBM MobileFirst Platform Foundation for iOS requires the help of a dependent user authentication realm. This behavior is all configured on the server. But you must ensure that your application has the appropriate challenge handlers that are required to handle the challenges that come from the server. The dependent realm challenge handlers do not require any additional configuration. For more information, see the appropriate section of this user documentation or getting started modules for instructions on how to write the respective challenge handlers for your dependent user realm.

### Group support

User certificates are issued by default to a user on a specific application and device. Group support allows a certificate to be issued to the user on a specific device and to a group of applications. The same user certificate can be shared among a group of applications that are installed on the device, allowing the user to only authenticate through a dependent realm once, and not for every application.

In this case, the user enrollment process that requires the user to log in to a dependent realm happens the first time that the user attempts to log in to the server on a particular device. After the device is provisioned with the necessary certificate, all subsequent authentications to the server from any of the MobileFirst applications that are designated by you use the same certificate to authenticate to the server.

To configure the sharing of user certificates among a group of applications, see “Configuring user certificate authentication for a group of applications” on page 12-113.

## Clearing certificates on the chain

Certificates on the client are managed by the MobileFirst client run time. They are installed and removed from the device as needed. However, there might be situations when you want the ability to clear the certificates that are installed on the device. The API allows the application to remove the certificates at more convenient times, like during test and development, or when the device is transferred to a new user.

On iOS only, if you would like to delete the certificate that is associated with a specific group of applications, use the following API:

```
WL.UserAuth.deleteCertificate("yourGroupNameHere");
```

## Security considerations

This new feature introduces a powerful and ITU-T X.509 standards-based way to authenticate users. It also introduces a password-less login mechanism. The identity is established by the MobileFirst client run time as part of the application that presents the certificate as part of the server-side connection. Although this behavior greatly simplifies the user experience, the following precautions must be taken by the enterprise. These precautions ensure that there is adequate protection on the device to ensure cases where the user loses the device or when the device is stolen.

1. Single user is required. The device is owned and used only by a single user and not accessible to others.
2. Device must be maintained under a device passcode lock or PIN to ensure that only the designated user can access the device and applications.

## Configuring user certificate authentication for a group of applications

You can configure the User Certificate Authentication feature to issue a certificate to a user on a device for a group or family of applications that are protected by the user certificate authentication realm. This configuration allows a user to authenticate once and be automatically authenticated to a set of applications on the device (single sign-on). This single sign-on option among a family of applications can be achieved with the Simple Data Sharing feature. The Simple Data Sharing feature allows the User Certificate Authentication feature to provision a device with a user certificate that applies to, and is used by, all applications in the same specified MobileFirst family.

### About this task

You can configure the User Certificate Authentication feature to provision the device with a user certificate that is shared among a group of applications. This configuration allows a group of applications to authenticate with the same X.509 client certificate.

**Note:** The iOS `x509AccessGroup` property is deprecated since IBM MobileFirst Platform Foundation for iOS V7.0.0. Use the Simple Data Sharing feature instead.

### Procedure

1. Enable the Simple Data Sharing feature.
  - a. For iOS applications, follow the steps in “Enabling the Simple Data Sharing feature for iOS native applications” on page 8-254.

2. Ensure that you select the user certificate authentication group support option in the application descriptor file.

 **Enable User Client Certificate Authentication Group Support**

When you use the User Certificate Authentication feature, enable this option to provision the device with a user certificate that is shared by all applications in the same family.

## Troubleshooting the User Certificate Authentication feature

Find solutions to problems with the User Certificate Authentication feature.

*Table 12-18. User Certificate Authentication troubleshooting guidelines.* This table lists possible problems and actions to take to troubleshoot the User Certificate Authentication feature.

Problem	Actions to take
The server is not responding even though it is accessible through the browser when it uses a certificate that is signed by a private CA.	Make sure that you can reach the MobileFirst Server on your device. For example, go to the MobileFirst Operations Console on the device's internet browser. If you can reach it, then the most likely error is that the client is not trusting the server's certificate. The server's certificate is most likely a certificate that is signed by a private CA. To fix this problem, you must install the root CA on the device so that it is trusted. For more information, see "Establishing trust" on page 12-112.
WLSecureRequest:sendRequestToServerWithURL A connection failure occurred: SSL Problem (Possible causes may include a bad/expired/self-signed certificate, clock set to the wrong date) on iOS.	One of the certificates was not trusted. Usually it is because the server did not send the server certificate with the whole certificate chain in the right order, when it uses an intermediate CA. For more information, see "SSL configuration" on page 12-102. Another explanation can be that the certificate was revoked by the certificate revocation list (CRL), and the PKI did not allow the device to renew the certificate.
Authentication fails with an exception in the PKI.	There was an exception somewhere in the PKI bridge. To see more information about the exception, make sure that the MobileFirst Server has trace that is enabled for <code>com.worklight.*=all</code> , and search for <code>UserCertificate*</code> in the trace file. Possible reasons include a syntax or runtime error in the adapter when you use the adapter-based PKI bridge, or a configuration error in the embedded PKI.
The client certificate is expired or not yet valid.	If the certificate is expired or not yet valid, the client logs this information in the client's logs. The client then proceeds with the authentication as if it did not have a certificate. The PKI then decides whether it allows the user to renew the certificate or not. In the 'certificate not yet valid' scenario, verify that the device and the server clocks are set correctly.

---

## License tracking

IBM MobileFirst Platform Foundation for iOS is available in Enterprise (B2E) and Consumer (B2C) editions, and the license terms vary depending on which edition was sold.

License tracking is enabled by default in IBM MobileFirst Platform Foundation for iOS, which tracks metrics relevant to the licensing policy such as active client devices and installed apps.

This information helps determine if the current usage of IBM MobileFirst Platform Foundation for iOS is within the license entitlement levels and can prevent potential license violations.

Also, by tracking the usage of client devices, and determining whether the devices are active, MobileFirst administrators can decommission devices that are no longer accessing the IBM MobileFirst Platform. This situation might arise if an employee has left the company, for example.

License tracking details are gathered by specifying configuration properties in JNDI, and the data that is gathered is displayed in a License Tracking report that is accessed from the IBM MobileFirst Platform Operations Console.

## Configuring your license tracking details

Administrators can set Java Naming and Directory Interface (JNDI) configuration properties to gather data that relates to license terms for devices that are accessing the MobileFirst platform. This data can be displayed in the License Tracking report, which is accessed from the IBM MobileFirst Platform Operations Console.

### About this task

Administrators can specify the following JNDI configuration properties, which enable the administrators to gather the required data:

#### **wl.device.decommission.when**

The number of days of inactivity after which a client device is decommissioned by the device decommissioning task. The default value is 90 days.

#### **wl.device.archiveDecommissioned.when**

A value, in days, that defines when client devices that were decommissioned will be placed in an archive file when the decommissioning task is run. The archived client devices are written to a file in the IBM MobileFirst Platform Server `home\devices_archive` directory. The name of the file contains the time stamp when the archive file is created. The default value is 90 days.

#### **wl.device.tracking.enabled**

A value that is used to enable or disable device tracking in IBM MobileFirst Platform Foundation for iOS. For performance reasons, you can disable this flag when IBM MobileFirst Platform Foundation for iOS is running only Business-to-Consumer (B2C) apps. When device tracking is disabled, the license reports are also disabled and no license metrics are generated.

For more information about specifying JNDI properties, see [Configuring an IBM MobileFirst project in production by using JNDI environment entries](#).

The decommissioning task is run daily, as a MobileFirst Server task in the background. This task performs the following actions:

- Decommissions inactive devices, based on the **wl.device.decommission.when** setting.
- Optionally, archives older decommissioned devices, based on the **wl.device.archiveDecommissioned.when** setting.
- Generates the License Tracking report.

Active client devices are those devices whose status is not decommissioned; inactive client devices have a decommissioned status.

### Procedure

1. Specify the required properties as JNDI properties.
2. View the data in the License Tracking report in the MobileFirst Operations Console. For more information, see “License Tracking report.”

## License Tracking report

IBM MobileFirst Platform Foundation for iOS provides a report that shows how many client devices accessed the platform, and whether they are active or decommissioned. The report also provides historical data.

The License Tracking report shows the following data:

- The number of applications deployed in the IBM MobileFirst Platform Server
- The number of client devices, both active and decommissioned
- The highest number of client devices reported over the last  $n$  days, where  $n$  is the number of days of inactivity after which a client device is decommissioned.

Administrators might want to analyze data further. For this purpose, the number of active client devices per application, the generated report details, and an historical listing of license metrics are captured in a CSV file that can be downloaded for further analysis.

The data is gathered by using the following JNDI configuration properties:

- **wl.device.decommission.when**
- **wl.device.archiveDecommissioned.when**
- **wl.device.tracking.enabled**

For more information, see [Configuring your license tracking details](#).

To access the License Tracking report, click the **License tracking** link in a runtime environment in the IBM MobileFirst Platform Operations Console.



LICENSE TRACKING	
Number of servers in cluster	Please check your Application Server's administrative console
Number of applications	5
Number of decommissioned devices	1
* Detailed listing of number of active client devices per application are captured in the license report.	
Highest number of active client devices in the last 90 days	1; on Nov 7, 2014, 4:29 PM
Decommissioning task last run	Feb 4, 2015, 4:22 PM
Number of days set for decommissioning a client device	90 days
Time interval set for running the decommissioning task	86,400 seconds
Number of days set for archiving decommissioned client device records	90 days

Figure 12-36. License tracking information for applications, devices, and decommissioning

To obtain a CSV file from the License Tracking report, click **DOWNLOAD REPORT**.

## Integration with IBM License Metric Tool

IBM MobileFirst Platform Foundation for iOS generates IBM Software License Metric Tag (SLMT) files. Versions of IBM License Metric Tool that support IBM Software License Metric Tag can generate License Consumption Reports. Read this section to interpret these reports for MobileFirst Server, and to configure the generation of the IBM Software License Metric Tag files.

If you have not installed a version of IBM License Metric Tool that supports IBM Software License Metric Tag, you can review the license usage with the License Tracking reports of MobileFirst Operations Console. For more information, see “License Tracking report” on page 12-116.

Each instance of a running MobileFirst runtime environment generates an IBM Software License Metric Tag file. The metrics monitored are CLIENT\_DEVICE and APPLICATION. Their values are refreshed every 24 hours.

### About the CLIENT\_DEVICE metric

The CLIENT\_DEVICE metric can have the following subtypes:

#### Active Devices

The number of client devices that used the MobileFirst runtime environment, or another MobileFirst runtime instance belonging to the

same cluster or server farm, and that were not decommissioned. For more information about decommissioned devices, see “Configuring your license tracking details” on page 12-115.

### **Inactive Devices**

The number of client devices that used the MobileFirst runtime environment, or another MobileFirst runtime instance belonging to the same cluster or server farm, and that were decommissioned. For more information about decommissioned devices, see “Configuring your license tracking details” on page 12-115.

The following cases are specific:

- If the decommissioning period of the device is set to a small period, the subtype "Inactive Devices" is replaced by the subtype "Active or Inactive Devices".
- If device tracking was disabled, only one entry is generated for CLIENT\_DEVICE, with the value 0, and the metric subtype "Device Tracking Disabled".
- If the MobileFirst runtime environment is running in a development server, and device tracking is not disabled, only one entry is generated for CLIENT\_DEVICE. This entry has the sum of active and decommissioned devices as its value, and "Development Server" as its metric subtype.

### **About the APPLICATION metric**

The APPLICATION metric has no subtype unless the MobileFirst runtime environment is running in a development server.

The value reported for this metric is the number of applications that are deployed in the MobileFirst runtime environment. Each application is counted as one unit, whether it is a new application, an additional brand deployment, or an additional type of an existing application (for example native, hybrid, or web).

This number of applications is monitored even if `wl.device.tracking.enabled` is set to false.

The following cases are specific:

- If the MobileFirst runtime environment is running in a development server, the metric Application is reported with the subtype "Development Server".

### **Configuring IBM License Metric Tool log files**

By default, the IBM Software License Metric Tag files are in the following directories:

- On Windows: %ProgramFiles%\ibm\common\slm
- On UNIX and UNIX-like operating systems: /var/ibm/common/slm

If the directories are not writable, the files are created in the log directory of the application server that runs the MobileFirst runtime environment.

You can configure the location and management of those files with the following properties:

- `license.metric.logger.output.dir`: Location of the IBM Software License Metric Tag files
- `license.metric.logger.file.size`: Maximum size of an SLMT file before a rotation is performed. The default size is 1 MB.

- `license.metric.logger.file.number`: Maximum number of SLMT archive files to keep in rotations. The default number is 10.

To change the default values, you must create a Java property file, with the format `key=value`, and provide the path to the properties file through the `license_metric_logger_configuration` JVM property.

**Related tasks:**

“Configuring your license tracking details” on page 12-115

Administrators can set Java Naming and Directory Interface (JNDI) configuration properties to gather data that relates to license terms for devices that are accessing the MobileFirst platform. This data can be displayed in the License Tracking report, which is accessed from the IBM MobileFirst Platform Operations Console.



---

## Integrating with other IBM products

IBM MobileFirst Platform Foundation for iOS integrates with other IBM products.

You can find samples and more documentation about such integration for developers and administrators on the Integration page of the Developer Center website for IBM MobileFirst Platform.

---

### Introduction to MobileFirst integration capabilities

As a developer or administrator, you can use IBM MobileFirst Platform Foundation for iOS integration capabilities to connect specific IBM products to existing back-end systems and other Internet or intranet sources.

IBM MobileFirst Platform Foundation Enterprise Edition and IBM MobileFirst Platform Foundation Consumer Edition provide capabilities to integrate with IBM Endpoint Manager for Mobile Devices and IBM WebSphere® Cast Iron® for enterprise and application security.

IBM MobileFirst Platform Foundation for iOS also provides a flexible authentication framework to support existing security requirements through authenticator or login modules. For more information, see “MobileFirst security framework” on page 8-221.

Figure 1 gives a high-level view of the topology context for an app on a device that connects to IBM MobileFirst Platform Foundation for iOS.

Figure 2 shows where other IBM products fit within the typical MobileFirst topology diagram in Figure 1.

Item	Description
A	App
D	Device
N	Network
I/i	Internet or intranet
MFP	IBM MobileFirst Platform Foundation for iOS
EBE	Existing back ends
I	Other Internet sources

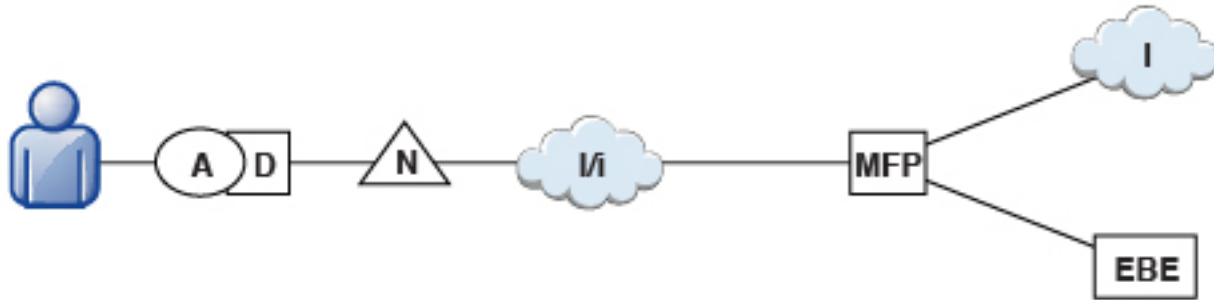

Figure 13-1. Overall Topology

Figure 13-2 shows where these products fit within the typical MobileFirst topology diagram in Figure 13-1.

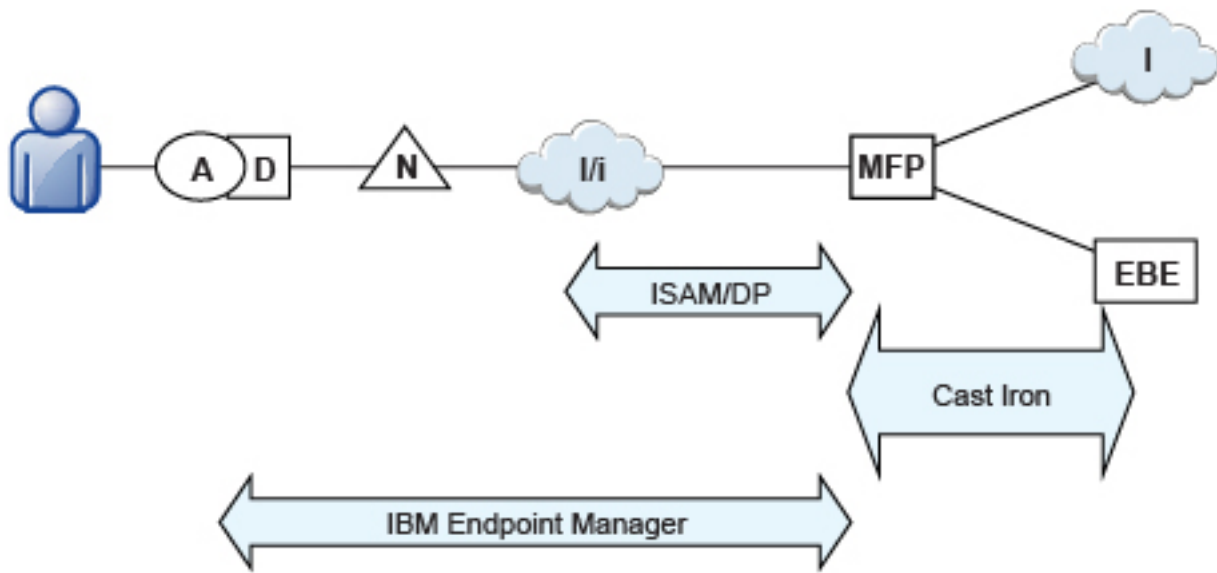

Figure 13-2. Integration Points

## Integration with Cast Iron

You can use IBM WebSphere Cast Iron to enable enterprise connectivity within a MobileFirst environment.

IBM MobileFirst Platform Foundation for iOS supports the following adapters:

- SQL
- HTTP
- Cast Iron
- Java Message Service (JMS)

The Cast Iron adapter provides first-class integration with all of the cloud-based, hardware appliance, or software-based hypervisor editions of IBM WebSphere Cast Iron.

By using IBM WebSphere Cast Iron, companies can integrate applications, regardless of whether the applications are located on-premises or in public or private clouds. With WebSphere Cast Iron, you do not need any programming knowledge to integrate applications. You can build integration flows in WebSphere Cast Iron Studio, which is a graphical development environment that is installed on a personal computer. With Cast Iron Studio, you can create an integration project that contains one or more orchestrations. Each orchestration is built with a number of activities that define the flow of data. You can define the details of an activity from the configuration panes within Cast Iron Studio.

Figure 1 shows how the topology changes to reflect the use of Cast Iron.

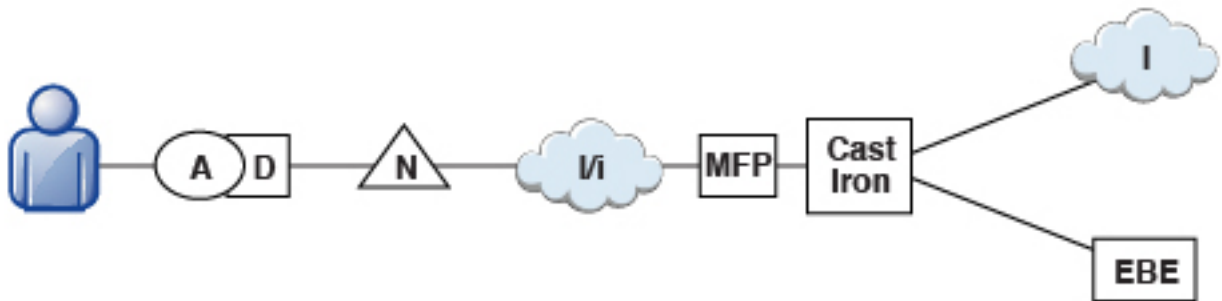

Figure 13-3. Integration with Cast Iron

For more information about Cast Iron adapters, see the tutorial on the Getting Started page and “Typical topologies of a MobileFirst instance in an extranet infrastructure” on page 6-239.

## Integration and authentication with a reverse proxy

You can use a reverse proxy to enable enterprise connectivity within a MobileFirst environment and to provide authentication to IBM MobileFirst Platform Foundation for iOS.

### General architecture

Reverse proxies typically front MobileFirst runtimes as part of the deployment, as shown in Figure 1, and follow the gateway pattern.

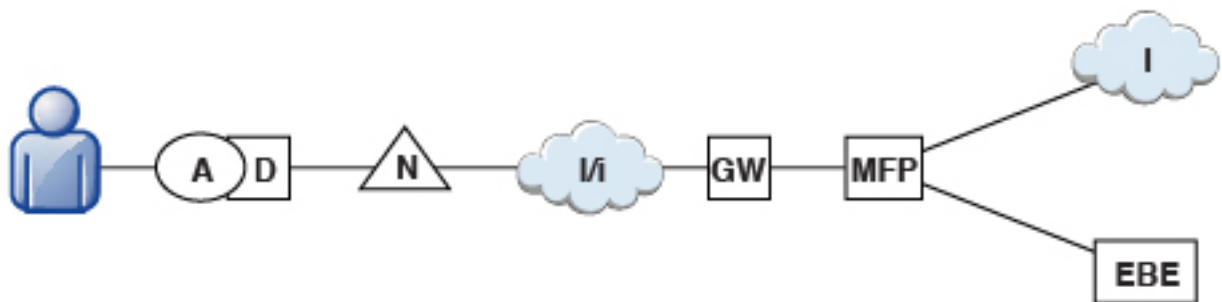

Figure 13-4. Integration with reverse proxy

The gateway icon (GW) represents a reverse proxy such as WebSphere DataPower or IBM Security Access Manager. In addition to protecting MobileFirst resources

from the Internet, the reverse proxy provides termination of SSL connections and authentication. The reverse proxy can also act as a policy enforcement point (PEP).

When a gateway is used, app (A) on device (D) uses the public URI that is advertised by the gateway instead of the internal MobileFirst URI. The public URI can be exposed as a setting within the app or can be built in during promotion of the app to production before the app is published to public or private app stores.

### Authentication at the gateway

If authentication ends at the gateway, IBM MobileFirst Platform Foundation for iOS can be informed of the authenticated user by a shared context, such as a custom HTTP header or a cookie. By using the extensible authentication framework, you can configure IBM MobileFirst Platform Foundation for iOS to use the user identity from one of these mechanisms and establish a successful login. Figure 13-5 shows a typical authentication flow.

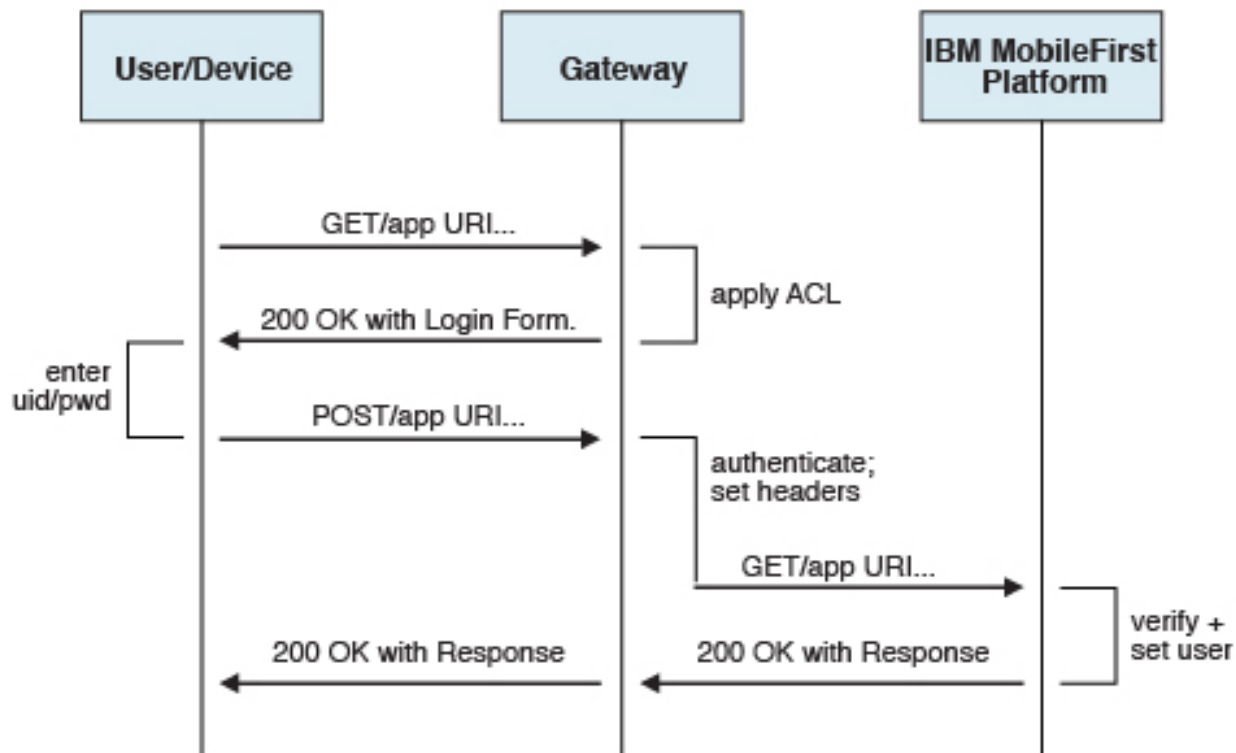

Figure 13-5. Authentication flow

This configuration was tested with DataPower and IBM Security Access Manager for header-based authentication and LTPA-based authentication.

#### Header-based authentication

- On successful authentication, the gateway forwards a custom HTTP header with the user name or ID to IBM MobileFirst Platform Foundation for iOS.
- IBM MobileFirst Platform Foundation for iOS is configured to use HeaderAuthenticator and HeaderLoginModule on either Tomcat or WebSphere Application Server.

#### LTPA-based authentication



- On successful authentication, the gateway forwards an LTPA token (in the form of an HTTP cookie) to IBM MobileFirst Platform Foundation for iOS
- IBM MobileFirst Platform Foundation for iOS on WebSphere Application Server is configured to use WebSphereFormBasedAuthenticator and WebSphereLoginModule.

---

## Integration with IBM Endpoint Manager

In a MobileFirst environment, you can implement an IBM Endpoint Manager architecture to make your enterprise devices and applications benefit from endpoint management features such as data security, compliance, and unified infrastructure.

### IBM Endpoint Manager for Mobile Devices

The features and architecture of IBM Endpoint Manager for Mobile Devices are described here.

#### Features

With IBM MobileFirst Platform Foundation for iOS, you can integrate the security features that IBM Endpoint Manager provides. The purpose of IBM Endpoint Manager is to deliver a unified solution for the management of systems and security, for all enterprise devices.

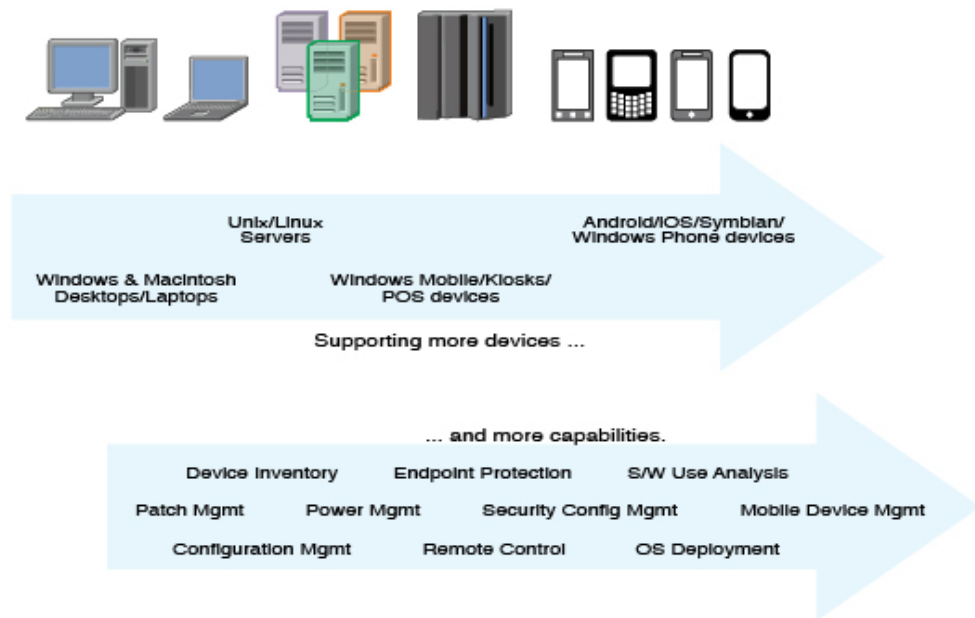

IBM Endpoint Manager for Mobile Devices provides security capabilities in the following areas:

- Enterprise Access Management: Configuration of email, VPN, and Wi-Fi.
- Policy and security management: Password policies, device encryption, jailbreak, and root detection.
- Management actions: Selective wipe, full wipe, deny email access, remote lock, user notification, clear passcode.

- Application management: Application inventory, enterprise app store, whitelisting, blacklisting, Apple Volume Purchase Program (VPP).
- Container solution: Enterproid Divide provides a secure and manageable container for BYOD (Bring Your Own Device) devices. The Divide app provides a workspace that mimics device capabilities. Because this workspace is isolated from the rest of the device, Divide can manage information separately and safely.

## Architecture

IBM Endpoint Manager for Mobile Devices uses two approaches to manage those devices:

- An agent-based, Mobile Device Management (MDM) API-based approach that is supported on iOS devices through the IBM Mobile Client. This approach provides the full set of capabilities through the usage of Apple’s MDM APIs and the Push Notification Server infrastructure (APNS).
- An email-based management through Exchange (Active Sync) and Lotus® Traveler (IBM Sync). In this approach, iOS is supported, but the functionality is limited and includes the ability to wipe a device, deny email access, and set password policies. You cannot see individual device details, perform application management, configure Wi-Fi or VPN connections, or provide advance restrictions as in the agent-based, MDM API-based approach.
- Container management is available through Enterproid Divide, as indicated in “Features” on page 13-5.
- PIM is available through NitroDesk TouchDown.

The following diagram shows an architectural overview of a production-level, agent-based, MDM API-based implementation with IBM Endpoint Manager for Mobile Devices.

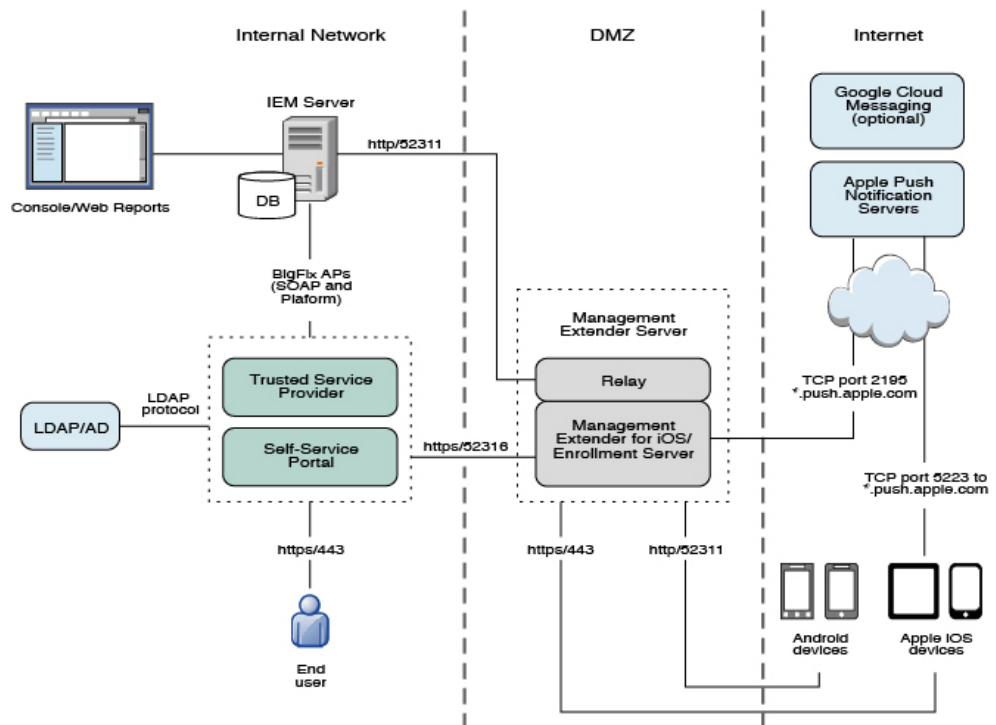

## End-point management with IBM Endpoint Manager

IBM Endpoint Manager for Mobile Devices provides features to manage devices in a MobileFirst environment.

IBM MobileFirst Platform Foundation for iOS provides app management capabilities as part of the platform. IBM Endpoint Manager provides specific device management capabilities. The app can also use certain device functions, which leads to an overlap in some of the management aspects between IBM MobileFirst Platform Foundation for iOS and IBM Endpoint Manager for Mobile Devices, as shown in Figure 13-6.

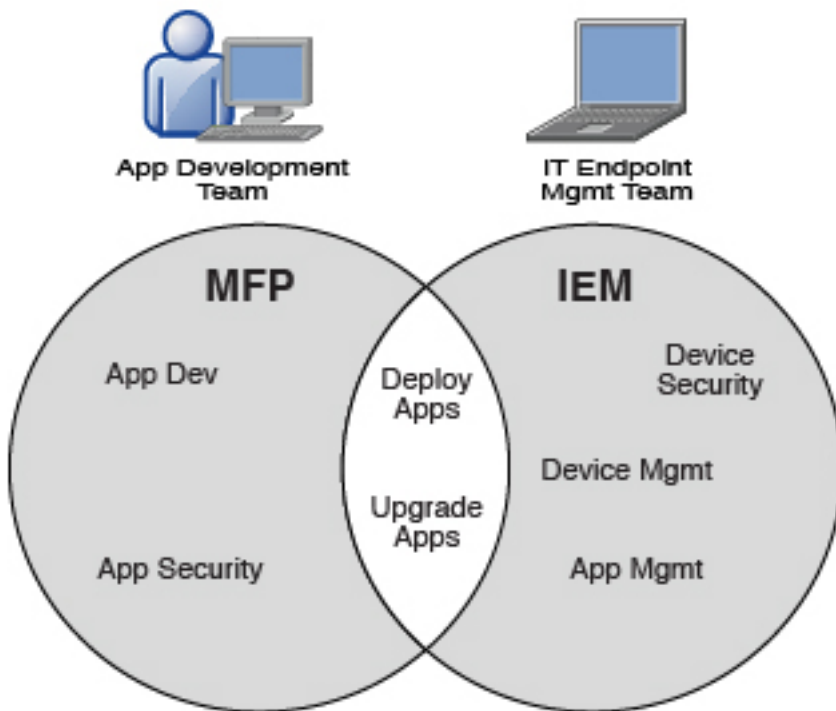

Figure 13-6. IBM MobileFirst Platform Foundation for iOS and IBM Endpoint Manager management capabilities

For devices that must be managed as enterprise assets and devices that must be controlled across applications, IBM Endpoint Manager provides the following mobile device management capabilities:

- Safeguard of enterprise data
- Flexible management
- Maintained compliance
- Unified infrastructure

### Safeguard of enterprise data

- Selectively wipes enterprise data when devices are lost or stolen.
- Configures and enforces passcode policies, encryption, VPN, and more.

### Flexible management

- Secures and manages employee-owned and corporate-owned mobile devices by a combination of email-based and agent-based management, while preserving the native device experience.

### **Maintained compliance**

- Automatically identifies non-compliant devices.
- Denies email access or issues user notifications until corrective actions are implemented.

### **Unified infrastructure**

- Uses a single infrastructure to manage and secure all your enterprise devices; that is, smartphones, tablets, desktops, notebooks, and servers.

---

## **Integration with IBM Tealeaf**

The use of IBM Tealeaf® is described here.

IBM Tealeaf CX Mobile helps customers apply the power of Tealeaf powerful solutions for customer experience management to their mobile websites, and native applications, including support for HTML5. IBM Tealeaf gives customers visibility where they do not have it today, helping to deliver winning mobile services. IBM Tealeaf CX Mobile is an add-on to the Tealeaf CX platform. IBM Tealeaf is provided as a set of libraries. To use it, you must take steps on both your client and your server.

For more information, see the Integration pages.

### **IBM Tealeaf client-side integration**

To make the IBM Tealeaf client SDK available for development, follow the iOS specific instructions for IBM Tealeaf to place the libraries and configuration files in the appropriate location of your MobileFirst project file system for each supported environment.

#### **Procedure**

Manually edit the `application-descriptor.xml` file to manage this optional feature.

#### **Results**

After the libraries and configuration files are in the correct directory, the IBM Tealeaf client-side API is on your Java class path and available in XCode (Objective-C), and the TLT global variable is available in your JavaScript code.

#### **Important:**

Be aware of the following effects:

- Removing the IBM Tealeaf SDK from inclusion in your application by removing the optional feature item removes existing IBM Tealeaf artifacts from your project, including any you placed manually.

Therefore, you can place specific versions of the IBM Tealeaf SDK artifacts manually and avoid managing the placement of IBM Tealeaf artifacts in your project in the application descriptor editor.

For more information about how to edit the `pList` file and how to use the IBM Tealeaf CX Mobile API, see the Tealeaf documentation indicated in the Tealeaf CX Mobile page of the Developer Center website for IBM MobileFirst Platform.

## IBM Tealeaf server-side integration

To aggregate the data that is collected in client applications by the IBM Tealeaf client SDK, you must install the IBM Tealeaf Mobile CX server.

For more information about installation, configuration, and usage, see Tealeaf CX Mobile.

---

## Integration with IBM Trusteer

You can use IBM Trusteer to collect mobile device risk factors. By providing these to your mobile app, you can restrict mobile app functionality by risk levels.

IBM MobileFirst Platform Foundation for iOS supports the following versions of IBM Trusteer Mobile SDK:

- IBM Trusteer Mobile SDK Version 3.6 and later fix packs
- IBM Trusteer Mobile SDK Version 4.0 and later fix packs

IBM MobileFirst Platform Foundation for iOS supports full integration with the IBM Trusteer Mobile SDK for iOS applications.

After the Trusteer Mobile SDK is installed, you must configure MobileFirst Server to support it:

- “MobileFirst security overview” on page 10-79 and “MobileFirst security configuration” on page 10-81 provide an overview of general MobileFirst security configuration.
- “Configuring the MobileFirst Server for Trusteer” on page 10-85 provides steps for configuring MobileFirst Server to support Trusteer.

For more information, see the Integration pages.

## Integrating IBM Trusteer for iOS

You might want to integrate Trusteer with IBM MobileFirst Platform Foundation for iOS.

### Before you begin

- If you are using a Trusteer compressed archive:
  1. Make sure that you have the following files:
    - Trusteer Mobile iOS library: `libtas_full.a`.
    - A MobileFirst-compatible Trusteer license file: `tas.license`
    - A Trusteer configuration package: `default_conf.rpkg`
    - A Trusteer Application Security Manifest: `manifest.rpkg`

**Note:** You might need to generate the manifest manually. For more information, see the Trusteer documentation.

If any of these items is missing, consult your local IBM representative.

2. In your file system, create a `tas` folder and place in it the files that are listed previously.
3. Continue from step 1.

**Note:** Starting with its version 4.0, Trusteer supports the arm64 architecture. Earlier versions of Trusteer do not.

## Procedure

1. In your Xcode project, drag the folder onto your project navigator.
2. Select the check box **Copy items into destination group's folder (if needed)**.
3. Select the option **Create folder references for any added folders**.
4. Make sure that your target is selected, then click **Finish**.
5. Click the project name at the top of the tree in the **Project Navigator**, then click **Build Phases**.
6. To link your project with the Trusteer library, drag the `libtas_full.a` file from the **Project Navigator** to the **Link Binary With Libraries** list.

**Note:** To avoid possible link issues, arrange the items in the list so that `libWorklightStaticLibProject.a` appears at the top and `libtas_full.a` appears next.

7. In **Build Settings > Linking > Other Linker Flags**, add: `-force_load "$(SRCROOT)/tas/libtas_full.a"`.
8. In **Build Settings > Linking > Dead Code Stripping**, select **NO**.
9. In **Build Settings > Deployment**, set **Strip Linked Product** to **NO**.
10. In the Xcode **Project Navigator**, drag `tas.license` into the **Resources** group.
11. In the dialog box that opens, click **Finish**.
12. Open the `tas.license` file and check that the values for `vendorId`, `clientId`, and `clientKey` match the licensing information that was provided by Trusteer.

---

## Using WebSphere DataPower as a push notification proxy

You can use IBM WebSphere DataPower as a gateway for outbound connections to facilitate monitoring and routing.

### About this task

IBM MobileFirst Platform Foundation for iOS makes outbound connections to notification mediators in order to push notifications for mobile applications. You can set up DataPower to act as a push notification proxy for MobileFirst mobile applications.

IBM WebSphere DataPower SOA Appliances are built for simplified deployment and hardened security, bridging multiple protocols, and performing conversions at wire speed. These capabilities help an organization to achieve and maintain its security and operational policies.

DataPower can act as a reverse proxy and security gateway for handling inbound traffic into an enterprise. In addition, in a situation where corporate policy mandates that all outbound connections must be made through a gateway to facilitate monitoring and routing, DataPower can also be used as a gateway for such a requirement.

IBM MobileFirst Platform Foundation for iOS makes outbound connections to a notification mediator, APNS (Apple Push Notification Service), in order to push notifications for mobile applications. DataPower can act as a proxy between MobileFirst Server and APNS.

### Procedure

- For both APNS and GCM, you must configure both DataPower and the MobileFirst Server.

- For GCM, there are two possible DataPower configurations that would enable it to act as a GCM proxy for IBM MobileFirst Platform Foundation for iOS: a TCP proxy configuration and a web application firewall configuration.
- For more information, and detailed step-by-step instructions, see the developerWorks article [Using WebSphere DataPower as a push notification proxy for MobileFirst mobile applications](#).

---

## More about integration

More resources on integration with IBM WebSphere Cast Iron, IBM Endpoint Manager, IBM WebSphere DataPower, and IBM Security Access Manager are available from the product websites and IBM Redbooks® website.

For more information, use the following links:

### **IBM WebSphere Cast Iron**

<http://www.redbooks.ibm.com/redpapers/pdfs/redp4840.pdf>

<http://www.redbooks.ibm.com/abstracts/sg248004.html?Open>

### **IBM Endpoint Manager**

<http://www.ibm.com/software/tivoli/solutions/endpoint/mdm/>

### **IBM WebSphere DataPower**

<http://www.redbooks.ibm.com/abstracts/redp4790.html?Open>

<http://www.redbooks.ibm.com/abstracts/sg247620.html?Open>

### **IBM Security Access Manager**

<http://www.redbooks.ibm.com/abstracts/redp4621.html?Open>

<http://www.ibm.com/support/docview.wss?uid=swg24034222>





---

## Reference

Reference information about Ant tasks, configuration sample files

---

### Ant configuredatabase task reference

Reference information for the **configuredatabase** Ant task.

#### Overview

**Note:** The Reports database (WLREPORT below) is deprecated in IBM MobileFirst Platform Foundation for iOS V7.0.0. Use “Operational analytics” on page 12-8 instead. Note that setting up the Reports database is optional in this release and prior releases.

The **configuredatabase** Ant task creates the databases that are used by MobileFirst Administration Services and by the MobileFirst runtime. This Ant task configures a database for a MobileFirst project through the following actions:

- Checks whether the MobileFirst tables exist and creates them if necessary.
- If the tables exist for an older version of IBM MobileFirst Platform Foundation for iOS, migrates them to the current version.
- If the tables exist for the current version of IBM MobileFirst Platform Foundation for iOS, does nothing.

In addition, if one of the following conditions is met:

- The DBMS type is Derby.
- An inner element <dba> is present.
- The DBMS type is DB2, and the specified user has the permissions to create databases.

Then, the task can have the following effects:

- Create the database if necessary (except for Oracle 12c).
- Create a user, if necessary, and grants that user access rights to the database.

In IBM Worklight Foundation V6.2.0, a new database was introduced, which is referenced with kind **WorklightAdmin** for Administration Services. This database can support one MobileFirst runtime or more, and can handle the artifacts of those MobileFirst runtimes.

**Important:** If you upgrade from an IBM Worklight version earlier than V6.2.0, you must also migrate the data from the IBM Worklight runtime to the new database for MobileFirst Administration Services. IBM Worklight Foundation V6.2.0 introduced a new element, `adminDatabase`, for this purpose, as shown in Table 2.

## Attributes and elements for configuredatabase

The **configuredatabase** task has the following attributes:

Table 14-1. Attributes for the **configuredatabase** Ant task

Attribute	Description	Required	Default
<b>kind</b>	Type of database: <b>Worklight</b> , <b>WorklightReports</b> , or <b>WorklightAdmin</b>	Yes	None

IBM MobileFirst Platform Foundation for iOS V7.0.0 supports three kinds of database: MobileFirst runtimes use **Worklight** and **WorklightReports** databases. MobileFirst Administration Services use the **WorklightAdmin** database.

The **configuredatabase** task supports the following elements:

Table 14-2. Inner elements for the `<configuredatabase>` Ant task

Element	Description	Count
<b>derby</b>	Parameters for Derby	0..1
<b>db2</b>	Parameters for DB2	0..1
<b>mysql</b>	Parameters for MySQL	0..1
<b>oracle</b>	Parameters for Oracle	0..1
<b>driverclasspath</b>	JDBC driver class path	0..1
<b>admindatabase</b>	Parameters for migrating data from IBM Worklight V6.1.x runtime to IBM MobileFirst Platform Foundation for iOS V7.0.0 Administration Services database	0..1

For each database type, you can use a `<property>` element to specify a JDBC connection property for access to the database. The `<property>` element has the following attributes:

Table 14-3. Attributes for the `<property>` element

Attribute	Description	Required	Default
<b>name</b>	Name of the property	Yes	None
<b>value</b>	Value for the property	Yes	None

## Attributes and elements for admindatabase

Use the `<admindatabase>` element for migrating data from a MobileFirst runtime database to the MobileFirst Administration Services database. This element is mandatory when you migrate your IBM Worklight runtime projects from V6.1.x and the **kind** attribute of **configuredatabase** is **Worklight**.

The **admindatabase** element has the following attribute.

Table 14-4. Attribute for the `<admindatabase>` element

Attribute	Description	Required	Default
<b>runtimeContextRoot</b>	Context root of the MobileFirst runtime	Yes	None

Because the MobileFirst Administration Services can handle one or more MobileFirst runtimes, you must reference a specific context root for each runtime. Use the `runtimeContextRoot` attribute to specify this context root. After MobileFirst data is migrated, you cannot change the context root of the MobileFirst runtime, unless the MobileFirst Administration Services database is removed and a new database is created.

The `<admindatabase>` element supports the following elements.

*Table 14-5. Inner elements for the <admindatabase> element*

Element	Description	Count
<b>derby</b>	Parameters for Derby	0..1
<b>db2</b>	Parameters for DB2	0..1
<b>driverclasspath</b>	JDBC driver class path	0..1
<b>mysql</b>	Parameters for MySQL	0..1
<b>oracle</b>	Parameters for Oracle	0..1

## Apache Derby

The `<derby>` element has the following attributes:

*Table 14-6. Attributes for the <derby> element*

Attribute	Description	Required	Default
<b>database</b>	Database name	No	<i>WRKLIGHT</i> , <i>WLREPORT</i> , or <i>WLADMIN</i> , depending on kind.
<b>datadir</b>	Directory that contains the databases	Yes	None
<b>schema</b>	Schema name	No	<i>WORKLIGHT</i> , <i>WORKLIGHT</i> , or <i>WLADMINISTRATOR</i> , depending on kind

The `<derby>` element supports the following elements:

*Table 14-7. Inner elements for the <derby> element*

Element	Description	Count
<b>property</b>	JDBC connection property	0..∞

For the available properties, see Setting attributes for the database connection URL.

## DB2

The `<db2>` element has the following attributes:

*Table 14-8. Attributes for the <db2> element*

Attribute	Description	Required	Default
<b>database</b>	Database name	No	<i>WRKLIGHT</i> , <i>WLREPORT</i> , or <i>WLADMIN</i> , depending on kind
<b>server</b>	Host name of the database server	Yes	None

Table 14-8. Attributes for the <db2> element (continued)

Attribute	Description	Required	Default
<b>port</b>	Port on the database server	No	50000
<b>user</b>	User name for accessing databases	Yes	None
<b>password</b>	Password for accessing databases	No	Queried interactively
<b>instance</b>	Name of the DB2 instance	No	Depends on the server
<b>schema</b>	Schema name	No	Depends on the user

For more information about DB2 user accounts, see DB2 security model overview.

The <db2> element supports the following elements:

Table 14-9. Inner elements for the <db2> element

Element	Description	Count
<b>property</b>	JDBC connection property	0..∞
<b>dba</b>	Database administrator credentials	0..1

For the available properties, see Properties for the IBM Data Server Driver for JDBC and SQLJ.

The inner element <dba> specifies credentials for database administrators. This element has the following attributes:

Table 14-10. Attributes for the <dba> element for DB2 databases

Attribute	Description	Required	Default
<b>user</b>	User name for accessing database	Yes	None
<b>password</b>	Password or accessing database	No	Queried interactively

The user that is specified in a <dba> element must have the SYSADM or SYSCTRL DB2 privilege. For more information, see Authorities overview.

The <driverclasspath> element must contain JAR files for the DB2 JDBC driver and for the associated license. You can retrieve those files in one of the following ways:

- Download DB2 JDBC drivers from the DB2 JDBC Driver Versions page
- Or fetch the db2jcc4.jar file and its associated db2jcc\_license\_\*.jar files from the DB2\_INSTALL\_DIR/java directory on the DB2 server.

You cannot specify details of table allocations, such as the table space, by using the Ant task. To control the table space, you must use the manual instructions in section “Configuring the DB2 databases manually” on page 10-17.

## MySQL

The element `<mysql>` has the following attributes:

Table 14-11. Attributes for the `<mysql>` element

Attribute	Description	Required	Default
<b>database</b>	Database name	No	<i>WRKLGHT, WLREPORT,</i> or <i>WLADMIN,</i> depending on kind
<b>server</b>	Host name of the database server	Yes	None
<b>port</b>	Port on the database server	No	3306
<b>user</b>	User name for accessing databases	Yes	None
<b>password</b>	Password for accessing databases	No	Queried interactively

For more information about MySQL user accounts, see MySQL User Account Management.

The `<mysql>` element supports the following elements:

Table 14-12. Inner elements for the `<mysql>` element

Element	Description	Count
<b>property</b>	JDBC connection property	0..∞
<b>dba</b>	Database administrator credentials	0..1
<b>client</b>	The host that is allowed to access the database	0..∞

For the available properties, see Driver/Datasource Class Names, URL Syntax and Configuration Properties for Connector/J.

The inner element `<dba>` specifies database administrator credentials. This element has the following attributes:

Table 14-13. Attributes for the `<dba>` element for MySQL databases

Attribute	Description	Required	Default
<b>user</b>	User name for accessing databases	Yes	None
<b>password</b>	Password for accessing databases	No	Queried interactively

The user that is specified in a `<dba>` element must be a MySQL superuser account. For more information, see Securing the Initial MySQL Accounts.

Each `<client>` inner element specifies a client computer or a wildcard for client computers. These computers are allowed to connect to the database. This element has the following attributes:

Table 14-14. Attributes for the <client> element for MySQL databases

Attribute	Description	Required	Default
hostname	Symbolic host name, IP address, or template with % as a placeholder	Yes	None

For more information about the hostname syntax, see Specifying Account Names.

The <driverclasspath> element must contain a MySQL Connector/J JAR file. You can download that file from the Download Connector/J page.

Alternatively, you can use the <mysql> element with the following attributes:

Table 14-15. Alternative attributes for the <mysql> element

Attribute	Description	Required	Default
url	Database connection URL	Yes	None
user	User name for accessing databases	Yes	None
password	Password for accessing databases	No	Queried interactively

**Note:** If you specify the database with the alternative attributes, this database must exist, the user account must exist, and the database must already be accessible to the user. In this case, the **configuredatabase** task does not attempt to create the database or the user, nor does it attempt to grant access to the user. The **configuredatabase** task ensures only that the database has the required tables for the current MobileFirst Server version. You do not have to specify the inner elements <dba> or <client>.

## Oracle

The element <oracle> has the following attributes:

Table 14-16. Attributes for the <oracle> element

Attribute	Description	Required	Default
database	Database name, or Oracle service name <b>Note:</b> You must always use a service name to connect to a PDB database.	No	ORCL
server	Host name of the database server	Yes	None
port	Port on the database server	No	1521
user	User name for accessing databases. See the note under this table.	Yes	None
password	Password for accessing databases	No	Queried interactively
sysPassword	Password for the user SYS	No	Queried interactively if the database does not yet exist

<b>systemPassword</b>	Password for the user SYSTEM	No	Queried interactively if the database or the user does not exist yet
-----------------------	------------------------------	----	----------------------------------------------------------------------

**Note:** For the **user** attribute, use preferably a user name in uppercase letters. Oracle user names are generally in uppercase letters. Unlike other database tools, the **configuredatabase** Ant task does not convert lowercase letters to uppercase letters in the user name. If the **configuredatabase** Ant task fails to connect to your database, try to enter the value for the **user** attribute in uppercase letters.

For more information about Oracle user accounts, see Overview of Authentication Methods.

The <oracle> element supports the following elements:

*Table 14-17. Inner elements for the <oracle> element*

Element	Description	Count
<b>property</b>	JDBC connection property	0..∞
<b>dba</b>	Database administrator credentials	0..1

For information about the available connection properties, see Class OracleDriver.

The inner element <dba> specifies database administrator credentials. This element has the following attributes:

*Table 14-18. Attributes for the <dba> element for Oracle databases*

Attribute	Description	Required	Default
<b>user</b>	User name for accessing databases	Yes	None
<b>password</b>	Password for accessing databases	No	Queried interactively

The <driverclasspath> element must contain an Oracle JDBC driver JAR file. You can download Oracle JDBC drivers from JDBC, SQLJ, Oracle JPublisher and Universal Connection Pool (UCP).

You cannot specify details of table allocation, such as the table space, by using the Ant task. To control the table space, you can create the user account manually and assign it a default table space before running the Ant task. To control other details, you must use the manual instructions in section “Configuring the Oracle databases manually” on page 10-33.

Alternatively, you can use the <oracle> element with the following attributes:

*Table 14-19. Alternative attributes for the <oracle> element*

Attribute	Description	Required	Default
<b>url</b>	Database connection URL	Yes	None
<b>user</b>	User name for accessing databases	Yes	None
<b>password</b>	Password for accessing databases	No	Queried interactively

**Note:** If you specify the database with the alternative attributes, this database must exist, the user account must exist, and the database must already be accessible to the user. In this case, the task does not attempt to create the database or the user, nor does it attempt to grant access to the user. The **configuredatabase** task ensures only that the database has the required tables for the current MobileFirst Server version. You do not have to specify the inner element <dba>.

---

## Customizing the database connection with JDBC properties

You can customize the database connection with JDBC properties. This can be used to define the security (SSL) of the connection to the database server, timeouts, or JDBC traces.

### About this task

To customize the database connection, you must add <property> elements to the database elements for the tasks **configuredatabase**, **configureapplicationserver**, and **installworklightadmin**. The JDBC properties are used by the Ant tasks when connecting to the database, and by the application server data source installed by **configureapplicationserver** and **installworklightadmin**.

You can find in the following procedure an example that defines the properties to set the command timeout for DB2 for the connection to the administration database.

### Procedure

1. From the “Sample configuration files” on page 14-35, select the file `configure-liberty-db2.xml`, and copy it to your working directory.
2. Review the Properties for the IBM Data Server Driver for JDBC and SQLJ in the DB2 for Linux UNIX and Windows user documentation.
3. Edit the Ant file to add the relevant JDBC properties in **configuredatabase**, **configureapplicationserver**, and **installworklightadmin**.

```
<target name="admdatabases">
  <configuredatabase kind="WorklightAdmin">
    <db2 database="${database.db2.wladmin.dbname}"
        server="${database.db2.host}"
        instance="${database.db2.instance}"
        user="${database.db2.wladmin.username}"
        port= "${database.db2.port}"
        schema = "${database.db2.wladmin.schema}"
        password="${database.db2.wladmin.password}">

      <property name="commandTimeout" value="10"/>
    </db2>
  </target>

  (...)

<target name="adminstall">
  <installworklightadmin>
    <console install="${wladmin.console.install}"/>
    <jmx/>
    <applicationserver>
      <websphereapplicationserver installdir="${appserver.was.installdir}"
        profile="${appserver.was.profile}">
        <server name="${appserver.was851liberty.serverInstance}"/>
      </websphereapplicationserver>
    </applicationserver>
    <user name="${wladmin.default.user}">
  </installworklightadmin>
</target>
```



```

        role="worklightadmin"
        password="{wladmin.default.user.initialpassword}"/>
<database kind="WorklightAdmin">
  <db2 database="{database.db2.wladmin.dbname}"
        server="{database.db2.host}"
        user="{database.db2.wladmin.username}"
        port= "{database.db2.port}"
        schema = "{database.db2.wladmin.schema}"
        password="{database.db2.wladmin.password}"/>

  <property name="commandTimeout" value="10"/>
</db2>
(...)

```

---

## Encrypting database password with Ant tasks for Liberty

You can use Ant tasks to encrypt database passwords for the WebSphere Application Server Liberty server with the aes algorithm.

### About this task

By default, Ant tasks encrypt passwords for the WebSphere Application Server Liberty server with the xor algorithm. You can encrypt them with the aes algorithm, and specify an aes key if your server does not use the default aes key.

If you want to use passwords that are already encrypted as input for the Ant tasks, for example if the Ant tasks are used by persons that should not have access to database production passwords, you can perform the following actions.

### Procedure

1. From the “Sample configuration files” on page 14-35 select the file `configure-liberty-<database>.xml`, and copy it to your working directory.
2. Add a **libertyEncoding** attribute with the value `none` in the `websphereapplicationserver` element of the **configureApplicationServer** and **installWorklightAdmin** Ant tasks. For more information, see table 6 of “Ant tasks for installation of MobileFirst runtime environments” on page 14-16.
3. For each database element of **configureApplicationServer** and **installWorklightAdmin**, add an attribute **validate** with the value `false`.
4. Put the encrypted values in the properties for the database passwords. For more information about the parameters of Ant tasks, see “Ant tasks for installation of MobileFirst runtime environments” on page 14-16 and “Ant tasks for installation of MobileFirst Operations Console and Administration Services” on page 14-10.

### What to do next

See also:

- “Deploying the MobileFirst Operations Console and Administration Services with Ant tasks” on page 6-55
- “Deploying a project WAR file and configuring the application server with Ant tasks” on page 10-14

---

## Ant tasks for installation of MobileFirst Operations Console and Administration Services

The `<installworklightadmin>`, `<updateworklightadmin>`, and `<uninstallworklightadmin>` Ant tasks are provided for the installation of the MobileFirst Operations Console and Administration Services.

### Task effects

#### `<installworklightadmin>`

The `<installworklightadmin>` task configures an application server to run an Administration Services WAR file as a web application and, optionally, to install the MobileFirst Operations Console. This task has the following effects:

- It declares the Administration Services web application in the specified context root, by default `/worklightadmin`.
- It declares data sources and – on WebSphere Application Server Full Profile – JDBC providers for Administration Services.
- It deploys the Administration Services on the application server.
- Optionally, it declares the MobileFirst Operations Console as a web application in the specified context root, by default `/worklightconsole`. If the MobileFirst Operations Console instance is specified, the Ant task declares the appropriate JNDI environment entry to communicate with the corresponding management service. For example:

```
<target name="admininstall">  
  <installworklightadmin servicewar="${worklight.service.war.file}">  
    <console install="${wladmin.console.install}" warFile="${worklight.console.war.file}"/>
```

- Optionally, it deploys the MobileFirst Operations Console WAR file on the application server.
- It configures configuration properties for the Administration Services by using JNDI environment entries. These JNDI environment entries also give some additional information about the application server topology, for example whether the topology is a stand-alone configuration, a cluster, or a server farm.
- Optionally, it configures users that it maps to roles used by the MobileFirst Operations Console and Administration Services web applications.
- It configures the application server for use of JMX.
- On WebSphere Application Server, it configures the necessary custom property for the web container.

#### `<updateworklightadmin>`

The `<updateworklightadmin>` task updates an already-configured MobileFirst web application on an application server. This task has the following effects:

- It updates the Administration Services WAR file. This file must have the same base name as the corresponding WAR file that was previously deployed.
- It updates the MobileFirst Operations Console WAR file. This file must have the same base name as the corresponding WAR file that was previously deployed.

The task does not change the application server configuration, that is, the web application configuration, data sources, JNDI environment entries, user-to-role mappings, and JMX configuration.

**Note:** On WebSphere Application Server Liberty profile, the task does not change the features, which leaves a potential non-minimal list of features in the `server.xml` file for the installed application.

### <uninstallworklightadmin>

The <uninstallworklightadmin> Ant task undoes the effects of an earlier run of <installworklightadmin>. This task has the following effects:

- It removes the configuration of the Administration Services web application with the specified context root. As a consequence, the task also removes the settings that were added manually to that application.
- It removes the Administration Services WAR file and the MobileFirst Operations Console WAR file from the application server as an option.
- It removes the data sources and – on WebSphere Application Server Full Profile – the JDBC providers for Administration Services.
- It removes the database drivers that were used by Administration Services from the application server.
- It removes the associated JNDI environment entries.
- It removes the users configured by the installworklightadmin invocation.
- It removes the JMX configuration.

### Attributes and elements

The <installworklightadmin>, <updateworklightadmin>, and <uninstallworklightadmin> tasks have the following attributes:

Table 14-20. Attributes for the <installworklightadmin>, <updateworklightadmin>, and <uninstallworklightadmin> Ant tasks

Attribute	Description	Required	Default
<b>contextroot</b>	Common prefix for URLs to admin services, to get information about MobileFirst runtime environments, applications, and adapters	No	/worklightadmin
<b>id</b>	Distinguishes different deployments	No	Empty
<b>environmentId</b>	Distinguishes different MobileFirst environments	No	Empty
<b>servicewar</b>	The WAR file for the Administration Services	No	The worklightadmin.war file is in the same directory as the worklight-ant-deployer.jar file.
<b>shortcutsDir</b>	Directory where to place shortcuts	No	None
<b>wasStartingWeight</b>	Start order for WebSphere Application Server. Lower values start first.	No	1

### contextroot and id

The contextroot and id attributes distinguish different deployments of MobileFirst Operations Console and Administration Services.

In WebSphere Application Server Liberty profiles and in Tomcat environments, the contextroot parameter is sufficient for this purpose. In

WebSphere Application Server Full profile environments, the `id` attribute is used instead. Without this `id` attribute, two WAR files with the same context roots might conflict and these files would not be deployed.

**environmentId**

Use the `environmentId` attribute to distinguish several environments, consisting each of MobileFirst Server administration and MobileFirst runtime web applications, that must operate independently. For example, with this option you can host a test environment, a pre-production environment, and a production environment on the same server or in the same WebSphere Application Server Network Deployment cell. This `environmentId` attribute creates a suffix that is added to MBean names that the Administration Services and the MobileFirst runtime projects use when they communicate through Java Management Extensions (JMX).

**servicewar**

Use the `servicewar` attribute to specify a different directory for the Administration Services WAR file. You can specify the name of this WAR file with an absolute path or a relative path.

**shortcutsDir**

The `shortcutsDir` attribute specifies where to place shortcuts to the MobileFirst Operations Console. If you set this attribute, you can add the following files to that directory:

- `mobilefirst-console.url`: This file is a Windows shortcut. It opens the MobileFirst Operations Console in a browser.
- `mobilefirst-console.sh`: This file is a UNIX shell script and opens the MobileFirst Operations Console in a browser.
- `worklight-admin-service.url`: This file is a Windows shortcut. It opens in a browser and calls a REST service that returns a list of the MobileFirst projects that can be managed in JSON format. For each listed MobileFirst project, some details are also available about their artifacts, such as the number of applications, the number of adapters, the number of active devices, the number of decommissioned devices. The list also indicates whether the MobileFirst project runtime is running or idle.
- `worklight-admin-service.sh`: This file is a UNIX shell script that provides the same output as the `worklight-admin-service.url` file.

**wasStartingWeight**

Use the `wasStartingWeight` attribute to specify a value that is used in WebSphere Application Server as a weight to ensure that a start order is respected. As a result of the start order value, the Administration Services web application is deployed and started before any other MobileFirst runtime projects. If MobileFirst projects are deployed or started before the web application, the JMX communication is not established and the runtime cannot synchronize with the administration database and cannot handle server requests.

The `<installworklightadmin>`, `<updateworklightadmin>`, and `<uninstallworklightadmin>` tasks support the following elements:

*Table 14-21. Inner elements for the `<installworklightadmin>`, `<updateworklightadmin>`, and `<uninstallworklightadmin>` Ant tasks*

Element	Description	Count
<code>applicationserver</code>	Application server	1
<code>console</code>	Administration console	0..1

Table 14-21. Inner elements for the <installworklightadmin>, <updateworklightadmin>, and <uninstallworklightadmin> Ant tasks (continued)

Element	Description	Count
<b>database</b>	Databases	1
<b>jmx</b>	Enable Java Management Extensions	1
<b>property</b>	Properties	0..∞
<b>user</b>	User to be mapped to a security role	0..∞

## To specify a MobileFirst Operations Console

The <console> element collects information to customize the installation of the MobileFirst Operations Console. This element has the following attributes:

Table 14-22. Attributes of the <console> element

Attribute	Description	Required	Default
<b>contextroot</b>	URI of the MobileFirst Operations Console	No	/worklightconsole
<b>install</b>	Indicates whether the MobileFirst Operations Console must be installed	No	Yes
<b>warfile</b>	Console WAR file	No	The worklightconsole.war file is in the same directory as the worklight-ant-deployer.jar file.

The <console> element supports the following element:

Table 14-23. Inner element for the <console> element

Element	Description	Count
<b>property</b>	Properties	0..∞

The <property> element specifies a deployment property to be defined in the application server. It has the following attributes:

Table 14-24. Attributes for the <property> element

Attribute	Description	Required	Default value
<b>name</b>	Name of the property	Yes	None
<b>value</b>	Value of the property	Yes	None

By using this element, you can define your own JNDI properties or override the default value of the JNDI properties that are provided by the Administration Services and the MobileFirst Operations Console WAR files.

For more information about the JNDI properties, see “List of JNDI properties for MobileFirst Server administration” on page 6-86.

## To specify an application server

Use the `<applicationserver>` element to define the parameters that depend on the underlying application server. The `<applicationserver>` element supports the following elements. The attributes and inner elements of these elements are described in tables 6 through 13 of “Ant tasks for installation of MobileFirst runtime environments” on page 14-16.

Table 14-25. Inner elements of the `<applicationserver>` element

Attribute	Description	Count
<b>websphereapplicationserver</b> or <b>was</b>	The parameters for WebSphere Application Server.	0..1
<b>tomcat</b>	The parameters for Apache Tomcat.	0..1

## To specify JMX communication between the MobileFirst Server administration and the MobileFirst projects

Use the `<jmx>` element to ensure that a JMX connection can be established between the MobileFirst Server administration and the MobileFirst runtime projects. The `<jmx>` element has the following attributes, which depend on the underlying application server.

Table 14-26. Attributes of the `<jmx>` element

Attribute	Description	Required	Default
<b>libertyAdminUser</b>	The administrator (for Liberty only)	No	None
<b>libertyAdminPassword</b>	The administrator password (for Liberty only).	No	None
<b>CreateLibertyAdmin</b>	Whether the <b>admin</b> user must be created in the basic registry, if it does not exist (for Liberty only).	No	true
<b>tomcatRMIPort</b>	The RMI port that Apache Tomcat uses to connect to MobileFirst projects (for Tomcat only)	No	8686
<b>tomcatSetEnvConfig</b>	Prevents automatic modification of <code>setenv.bat</code> and <code>setenv.sh</code> scripts. The valid values are <code>manual</code> and <code>auto</code> .	No	auto

**Note:** The **libertyAdminUser** and **libertyAdminPassword** attributes are not mandatory, but if you define one of these attributes, you must also define the other.

### **libertyAdminUser**

### **libertyAdminCreate**

### **libertyAdminPassword**

You use these attributes to create an admin user in the `server.xml` file, which is the configuration file for Liberty, in the basic registry section.

### **tomcatRMIPort**

If the default port 8686 is not available on the system, you use this attribute to specify a different port for JMX communication between the MobileFirst Server administration and the managed MobileFirst projects. In this case, the port values range from 1 to 65535.

### **tomcatSetEnvConfig**

You use this attribute to allow or prevent the `<installworklightadmin>` and `<uninstallworklightadmin>` Ant tasks from adding or removing contents to the `setenv.sh` or `setenv.bat` script, in the `<TomcatRootInstallDir>/bin` directory.

**Important:** Security warning. The default value `auto` does not secure the JMX communication. This setting is not suitable for production environments. In production environments, you must manually configure JMX with authentication, as described in the Enabling JMX Remote page of the Apache Tomcat user documentation.

Use the following values for this attribute:

- `manual`: The `<installworklightadmin>` and `<uninstallworklightadmin>` Ant tasks do not update the `setenv.bat` and `setenv.sh` script for JMX usage.

If you select the value `manual`, you must update the scripts manually to define the RMI port that is used for JMX communications internally between the Administration Services and the MobileFirst runtime environment, whether this connection must be secured or not with user or role authentication, or SSL. For more information, see the documentation of the JVM that you are using.

- `auto`: The `<installworklightadmin>` and `<uninstallworklightadmin>` Ant tasks update the `setenv.bat` and `setenv.sh` script automatically, for JMX usage. If these scripts do not exist, they are created before they are updated.

If you select the `auto` value, the following modifications are made to extend the `CATALINA_OPTS` environment variable:

– For `setenv.bat`:

```
REM Allow to inspect the MBeans through jconsole
set CATALINA_OPTS=%CATALINA_OPTS% -Dcom.sun.management.jmxremote
```

REM Configure JMX.

```
set CATALINA_OPTS=%CATALINA_OPTS% -Djava.rmi.server.hostname=localhost
set CATALINA_OPTS=%CATALINA_OPTS% -Dcom.sun.management.jmxremote.port=8686
set CATALINA_OPTS=%CATALINA_OPTS% -Dcom.sun.management.jmxremote.authenticate=false
set CATALINA_OPTS=%CATALINA_OPTS% -Dcom.sun.management.jmxremote.ssl=false
```

– For `setenv.sh`:

```
# Allow to inspect the MBeans through jconsole
CATALINA_OPTS="$CATALINA_OPTS -Dcom.sun.management.jmxremote"
```

# Configure JMX.

```
CATALINA_OPTS="$CATALINA_OPTS -Djava.rmi.server.hostname=localhost"
CATALINA_OPTS="$CATALINA_OPTS -Dcom.sun.management.jmxremote.port=8686"
CATALINA_OPTS="$CATALINA_OPTS -Dcom.sun.management.jmxremote.authenticate=false"
CATALINA_OPTS="$CATALINA_OPTS -Dcom.sun.management.jmxremote.ssl=false"
```

## To specify a connection to the administration database

The `<database>` element collects the parameters that specify a data source declaration in an application server to access the administration database.

You must declare a single database: `<database kind="WorklightAdmin">`. You specify the `<database>` element similarly to the `<configuredatabase>` Ant task, except that the `<database>` element does not have the `<dba>` and `<client>` elements. It might have `<property>` elements.

The `<database>` element has the following attributes:

Table 14-27. Attributes of the <database> element

Attribute	Description	Required	Default
<b>kind</b>	The kind of database ( <b>WorklightAdmin</b> )	Yes	None
<b>validate</b>	To validate whether the database is accessible	No	True

The <database> element supports the following elements. For more information about the configuration of these database elements, see 18 through 28 in “Ant tasks for installation of MobileFirst runtime environments.”

Table 14-28. Inner elements for the <applicationserver> element

Element	Description	Count
<b>db2</b>	Parameter for DB2 databases	0..1
<b>derby</b>	Parameter for Apache Derby databases	0..1
<b>mysql</b>	Parameter for MySQL databases	0..1
<b>oracle</b>	Parameter for Oracle databases	0..1
<b>driverclasspath</b>	Parameter for JDBC driver class path	0..1

## To specify a user and a security role

The <user> element collects the parameters about a user to include in a certain security role for an application.

Table 14-29. Attributes of the <user> element

Attribute	Description	Required	Default
<b>role</b>	A valid security role for the application	Yes	None
<b>name</b>	The user name	Yes	None
<b>password</b>	The password if the user needs to be created	No	None

After you defined users by using the <user> element, you can map them to any of the following roles for authentication in the MobileFirst Operations Console.

- worklightmonitor
- worklightoperator
- worklightdeployer
- worklightadmin

For information about which authorizations are implied by the specific roles, see the chapter about the “REST Services API” on page 9-4.

**Tip:** If users exist in an external LDAP directory, set only the **role** and **name** attributes but do not define any passwords.

---

## Ant tasks for installation of MobileFirst runtime environments

Reference information for the <configureapplicationserver>, <updateapplicationserver>, and <unconfigureapplicationserver> Ant tasks.



## Task effects

### <configureapplicationserver>

The <configureapplicationserver> Ant task configures an application server to run a MobileFirst project WAR file as a web application. This task has the following effects.

- It declares the MobileFirst web application in the specified context root, by default /worklight.
- It deploys the project WAR file on the application server.
- It declares data sources and “ on WebSphere Application Server full profile “ JDBC providers for runtime and reports.
- It deploys the MobileFirst Server runtime file worklight-jee-library.jar and the database drivers in the application server.
- It sets MobileFirst configuration properties through JNDI environment entries. These JNDI environment entries override the MobileFirst project default values that are contained in the worklight.properties file inside the WAR file.
- On WebSphere Application Server, it configures a web container custom property.

### <updateapplicationserver>

The <updateapplicationserver> Ant task updates an already-configured MobileFirst web application on an application server. This task has the following effects.

- It updates the project WAR file. The file must have the same base name as the project WAR file that was previously deployed.
- It updates the MobileFirst Server runtime worklight-jee-library.jar library file.

The task does not change the application server configuration, that is, the web application configuration, data sources, and JNDI environment entries.

**Note:** On WebSphere Application Server Liberty profile, the task does not change the features, which leaves a potential non-minimal list of features in the server.xml file for the installed application.

### <unconfigureapplicationserver>

The <unconfigureapplicationserver> Ant task undoes the effects of an earlier <configureapplicationserver> run. This task has the following effects.

- It removes the configuration of the MobileFirst web application with the specified context root. The task also removes the settings that have been added manually to that application.
- It removes the project WAR file from the application server.
- It removes the data sources and “ on WebSphere Application Server full profile “ the JDBC providers for runtime and reports.
- It removes the MobileFirst Server runtime worklight-jee-library.jar library file and the database drivers from the application server.
- It removes the associated JNDI environment entries.

## Attributes and elements

The <configureapplicationserver>, <updateapplicationserver>, and <unconfigureapplicationserver> tasks have the following attributes:

Table 14-30. Attributes for the <configureapplicationserver>, <updateapplicationserver>, and <unconfigureapplicationserver> Ant tasks

Attribute	Description	Required	Default
<b>contextroot</b>	Common prefix in URLs to the application (context root)	No	/worklight
<b>id</b>	Distinguishes different deployments	No	Empty
<b>environmentId</b>	Distinguishes different MobileFirst environments	No	Empty
<b>wasStartingWeight</b>	Start order for WebSphere Application Server. Lower values start first.	No	2
<b>shortcutsDir</b>	Directory where to place shortcuts	No	None

#### **contextroot and id**

The contextroot and id attributes distinguish different MobileFirst projects. By default, when a project is created in V6.0.0 of this product and higher, its context root is the name of the project. The default value of /worklight was chosen to facilitate compatibility with IBM Worklight V5.x applications.

In WebSphere Application Server Liberty profiles and in Tomcat environments, the contextroot parameter is sufficient for this purpose. In WebSphere Application Server full profile environments, the id attribute is used instead.

#### **environmentId**

Use the environmentId attribute to distinguish several environments, consisting each of MobileFirst Server administration and MobileFirst runtime web applications, that must operate independently. You must set this attribute to the same value for the runtime application as the one that was set in the <installworklightadmin> invocation, for the Administration Services application.

#### **wasStartingWeight**

Use the wasStartingWeight attribute to specify a value that is used in WebSphere Application Server as a weight to ensure that a start order is respected. As a result of the start order value, the MobileFirst Administration Services web application is deployed and started before any other MobileFirst runtime projects. If MobileFirst projects are deployed or started before the web application, the JMX communication is not established and you cannot manage your MobileFirst projects.

#### **shortcutsDir**

The shortcutsDir attribute for the <unconfigureApplicationServer> Ant task specifies where to expect the shortcuts to the MobileFirst Operations Console if it was installed by a version of the <configureApplicationServer> Ant task older than V6.2.0. If you set this attribute, the Ant task might remove the following files from that directory: worklight-console.url, worklight-console.sh, and worklight-console.html.

The <configureapplicationserver>, <updateapplicationserver>, and <unconfigureapplicationserver> tasks support the following elements:

Table 14-31. Inner elements for the <configureapplicationserver>, <updateapplicationserver>, and <unconfigureapplicationserver> Ant tasks

Element	Description	Count
<b>project</b>	Project	1
<b>property</b>	Properties	0..∞
<b>applicationserver</b>	Application server	1
<b>reports</b>	Reports <b>Note:</b> The predefined BIRT reports are deprecated in V7.0.0. Use “Operational analytics” on page 12-8 instead.	0..1
<b>database</b>	Databases	2

The <project> element specifies details about the project to deploy to the application server. It has the following attributes:

Table 14-32. Attributes for the <project> element

Attribute	Description	Required	Default
<b>warfile</b>	Project WAR file	Yes	None
<b>libraryfile</b>	File name of worklight-jee-library.jar	No	In the same directory as worklight-ant-deployer.jar
<b>migrate</b>	Whether to automigrate the WAR file to the current MobileFirst Server version	No	True
<b>migratedWarBackupFile</b>	Where to store a backup of the migrated WAR file	No	None

To create the warfile attribute, run the <war-builder> Ant task. See “Building a project WAR file with Ant” on page 10-4.

By default, the WAR file is automatically migrated to the current MobileFirst Server version. In this case, you can request a backup of the migrated WAR file on disk before it is deployed in the application server. To do so, specify a value for the **migratedWarBackupFile** attribute. If you set the migrate attribute to false, the WAR file is not migrated and, if the MobileFirst version that produced the WAR file is not suitable for the MobileFirst Server version, the deployment fails.

The <property> element specifies a deployment property to be defined in the application server. It has the following attributes:

Table 14-33. Attributes for the <property> element

Attribute	Description	Required	Default value
<b>name</b>	Name of the property	Yes	None
<b>value</b>	Value for the property	Yes	None

For general information about MobileFirst properties, or for a list of properties that you can set, see “Configuration of MobileFirst applications on the server” on page 10-48.

The <applicationserver> element describes the application server to which the MobileFirst application is deployed. It is a container for one of the following elements:

Table 14-34. Inner elements for the <applicationserver> element

Element	Description	Count
<b>websphereapplicationserver</b> or <b>was</b>	Parameters for WebSphere Application Server	0..1
<b>tomcat</b>	Parameters for Apache Tomcat	0..1

The <websphereapplicationserver> element (or <was> in its short form) denotes a WebSphere Application Server instance, version 7.0 or newer. WebSphere Application Server full profile (Base, and Network Deployment) are supported, as is Liberty profile (Core). Liberty profile Network Deployment is not yet supported. The <websphereapplicationserver> element has the following attributes:

Table 14-35. Attributes for the <websphereapplicationserver> or <was> element

Attribute	Description	Required	Default
<b>installdir</b>	WebSphere Application Server installation directory.	Yes	None
<b>profile</b>	WebSphere Application Server profile, or Liberty	Yes	None
<b>user</b>	WebSphere Application Server administrator name	Yes, except for Liberty	None
<b>password</b>	WebSphere Application Server administrator password	No	Queried interactively
<b>libertyEncoding</b>	Algorithm to encode data source passwords for WebSphere Application Server Liberty. The possible values are none, xor, and aes. <b>Note:</b> aes is no supported for WebSphere Application Server Liberty V8.5.0.x.  On WebSphere Application Server Liberty 8.5.5.x, if the aes encoding is requested, the clear password is passed as argument to the securityUtility program, which is called through an external process. You can see the password with a ps command, or in the /proc file system on UNIX operating systems.	No	xor
<b>libertyAESKey</b>	AES key to encode data source passwords for WebSphere Application Server Liberty with the AES algorithm, and with a key that is different from the default key. You must use this parameter only if a Liberty server is configured to use a non-default AES key. <b>Note:</b> Enter 12 asterisk symbols (*****). To be prompted interactively for the key.	No	The default key from the Liberty install

It supports the following elements for single-server deployment:

Table 14-36. Inner elements for the <was> element (single-server deployment)

Element	Description	Count
server	A single server	0..1

The <server> element, which is used in this context, has the following attributes:

Table 14-37. Inner elements for the <server> element (single-server deployment)

Attribute	Description	Required	Default
name	Server name	Yes	None

It supports the following elements for Network Deployment:

Table 14-38. Inner elements for the <was> element (network deployment)

Element	Description	Count
cell	The entire cell	0..1
cluster	All servers of a cluster	0..1
node	All servers in a node, clusters excluded	0..1
server	A single server	0..1

The <cell> element has no attributes.

The <cluster> element has the following attributes:

Table 14-39. Attributes for the <cluster> element (network deployment)

Attribute	Description	Required	Default
name	Cluster name	Yes	None

The <node> element has the following attributes:

Table 14-40. Attributes for the <node> element (network deployment)

Attribute	Description	Required	Default
name	Node name	Yes	None

The <server> element, which is used in a Network Deployment context, has the following attributes:

Table 14-41. Attributes for the <server> element (network deployment)

Attribute	Description	Required	Default
nodeName	Node name	Yes	None
serverName	Server name	Yes	None

The <tomcat> element denotes an Apache Tomcat server. It has the following attributes:

Table 14-42. Attributes of the <tomcat> element

Attribute	Description	Required	Default
<b>installdir</b>	Tomcat installation directory. For a Tomcat installation that is split between a CATALINA_HOME directory and a CATALINA_BASE directory, specify the value of the <b>CATALINA_BASE</b> environment variable.	Yes	None

The <reports> element specifies what set of BIRT \*.rptdesign report files to instantiate for access to the database of reports.

The <reports> element has the following attribute:

**Note:** The predefined BIRT reports are deprecated in V7.0.0. Use “Operational analytics” on page 12-8 instead.

Table 14-43. Attributes of the <reports> element

Attribute	Description	Required	Default
<b>tdir</b>	Destination directory	Yes	None

The <reports> element supports the following element:

Table 14-44. Inner elements for the <reports> element

Element	Description	Count
<b>fileset</b>	Set of files to copy and process	0..∞

A <reports> element without any inner <fileset> element instantiates all the report templates that are provided in the WorklightServer/report-templates/ directory in the MobileFirst Server distribution.

The <database> element specifies what information is necessary to access a particular database. Two databases must be declared: <database kind=“Worklight”> and <database kind=“WorklightReports”>. The <database> element is specified like the <configuredatabase> Ant task, except that it does not have the <dba> and <client> elements. It might, however, have <property> elements. The <database> element has the following attributes:

**Note:** The Reports database, referenced below as **WorklightReports** and **WLREPORT**, is deprecated in V7.0.0. Use “Operational analytics” on page 12-8 instead. Note that setting up the Reports database is optional in this release and prior releases.

Table 14-45. Attributes of the <database> element

Attribute	Description	Required	Default
<b>kind</b>	The kind of database: <b>Worklight</b> or <b>WorklightReports</b>	Yes	None
<b>validate</b>	To validate whether the database is accessible or not. The possible values are true or false.	No	true

The <database> element supports the following elements:

Table 14-46. Inner elements for the <database> element

Element	Description	Count
<b>derby</b>	Parameters for Derby	0..1
<b>db2</b>	Parameters for DB2	0..1
<b>mysql</b>	Parameters for MySQL	0..1
<b>oracle</b>	Parameters for Oracle	0..1
<b>driverclasspath</b>	JDBC driver class path	0..1

## To specify an Apache Derby database

The <derby> element has the following attributes:

Table 14-47. Attributes of the <derby> element

Attribute	Description	Required	Default
<b>database</b>	Database name	No	<b>WRKLGHT</b> or <b>WLREPORT</b> , depending on the kind
<b>datadir</b>	Directory that contains the databases	Yes	None
<b>schema</b>	Schema name	No	<b>WORKLIGHT</b>

The <derby> element supports the following element:

Table 14-48. Inner element for the <derby> element

Element	Description	Count
<b>property</b>	Data source property or JDBC connection property	0..sâ∆∆

For more information about the available properties, see the documentation for Class `EmbeddedDataSource40`. See also the documentation for Class `EmbeddedConnectionPoolDataSource40`.

For more information about the available properties for a Liberty server, see the documentation for **properties.derby.embedded** at Liberty profile: Configuration elements in the server.xml file.

When the `worklight-ant-deployer.jar` file is used within the installation directory of IBM MobileFirst Platform Foundation for iOS, a `<driverclasspath>` element is not necessary.

## To specify a DB2 database

The <db2> element has the following attributes:

Table 14-49. Attributes of the <db2> element

Attribute	Description	Required	Default
<b>database</b>	Database name	No	<b>WRKLGHT</b> or <b>WLREPORT</b> , depending on the kind
<b>server</b>	Host name of the database server	Yes	None

<b>port</b>	Port on the database server	No	50000
<b>user</b>	User name for accessing databases. This user does not need extended privileges on the databases. If you implement restrictions on the database, you can set a user with the restricted privileges that are listed in "Restricting database user permissions for IBM MobileFirst Platform Server runtime operations" on page 6-20.	Yes	None
<b>password</b>	Password for accessing databases	No	Queried interactively
<b>schema</b>	Schema name	No	Depends on the user

For more information about DB2 user accounts, see DB2 security model overview.

The <db2> element supports the following element:

Table 14-50. Inner elements for the <db2> element

Element	Description	Count
<b>property</b>	Data source property or JDBC connection property	0..∞

For more information about the available properties, see Properties for the IBM Data Server Driver for JDBC and SQLJ.

For more information about the available properties for a Liberty server, see the **properties.db2.jcc** section at Liberty profile: Configuration elements in the server.xml file.

The <driverclasspath> element must contain JAR files for the DB2 JDBC driver and the associated license. You can download DB2 JDBC drivers from DB2 JDBC Driver Versions.

### To specify a MySQL database

The <mysql> element has the following attributes:

Table 14-51. Attributes of the <mysql> element

Attribute	Description	Required	Default
<b>database</b>	Database name	No	WRKLGHT or WLREPORT, depending on kind
<b>server</b>	Host name of the database server	Yes	None
<b>port</b>	Port on the database server	No	3306



<b>user</b>	User name for accessing databases. This user does not need extended privileges on the databases. If you implement restrictions on the database, you can set a user with the restricted privileges that are listed in "Restricting database user permissions for IBM MobileFirst Platform Server runtime operations" on page 6-20.	Yes	None
<b>password</b>	Password for accessing databases	No	Queried interactively

Instead of database, server, and port, you can also specify a URL. In this case, use the following attributes:

Table 14-52. Alternative elements for the <mysql> element

Attribute	Description	Required	Default
<b>url</b>	URL for connection to the database	Yes	None
<b>user</b>	User name for accessing databases. This user does not need extended privileges on the databases. If you implement restrictions on the database, you can set a user with the restricted privileges that are listed in "Restricting database user permissions for IBM MobileFirst Platform Server runtime operations" on page 6-20.	Yes	None
<b>password</b>	Password for accessing databases	No	Queried interactively

For more information about MySQL user accounts, see MySQL User Account Management.

The <mysql> element supports the following element:

Table 14-53. Inner elements for the <mysql> element

Element	Description	Count
<b>property</b>	Data source property or JDBC connection property	0..∞

For more information about the available properties, see the documentation at Driver/Datasource Class Names, URL Syntax and Configuration Properties for Connector/J.

For more information about the available properties for a Liberty server, see the **properties** section at Liberty profile: Configuration elements in the server.xml file.

The <driverclasspath> element must contain a MySQL Connector/J JAR file. You can download it from Download Connector/J.

## To specify an Oracle database

The `<oracle>` element has the following attributes:

Table 14-54. Attributes of the `<oracle>` element

Attribute	Description	Required	Default
<b>database</b>	Database name, or Oracle service name <b>Note:</b> You must always use a service name to connect to a PDB database.	No	ORCL
<b>server</b>	Host name of the database server	Yes	None
<b>port</b>	Port on the database server	No	1521
<b>user</b>	User name for accessing databases. This user does not need extended privileges on the databases. If you implement restrictions on the database, you can set a user with the restricted privileges that are listed in “Restricting database user permissions for IBM MobileFirst Platform Server runtime operations” on page 6-20.  See the note under this table.	Yes	None
<b>password</b>	Password for accessing databases	No	Queried interactively

**Note:** For the **user** attribute, use preferably a user name in uppercase letters. Oracle user names are generally in uppercase letters. Unlike other database tools, the **configureapplicationserver** Ant task does not convert lowercase letters to uppercase letters in the user name. If the **configureapplicationserver** Ant task fails to connect to your database, try to enter the value for the **user** attribute in uppercase letters.

Instead of database, server, and port, you can also specify a URL. In this case, use the following attributes:

Table 14-55. Alternative attributes of the `<oracle>` element

Attribute	Description	Required	Default
<b>url</b>	URL for connection to the database	Yes	None
<b>user</b>	User name for accessing databases. This user does not need extended privileges on the databases. If you implement restrictions on the database, you can set a user with the restricted privileges that are listed in “Restricting database user permissions for IBM MobileFirst Platform Server runtime operations” on page 6-20.  See the note under this table.	Yes	None
<b>password</b>	Password for accessing databases	No	Queried interactively

**Note:** For the **user** attribute, use preferably a user name in uppercase letters. Oracle user names are generally in uppercase letters. Unlike other database tools,

the **configureapplicationserver** Ant task does not convert lowercase letters to uppercase letters in the user name. If the **configureapplicationserver** Ant task fails to connect to your database, try to enter the value for the **user** attribute in uppercase letters.

For more information about Oracle user accounts, see Overview of Authentication Methods.

For more information about Oracle database connection URLs, see the **Database URLs and Database Specifiers** section at Data Sources and URLs.

It supports the following elements:

Table 14-56. Inner elements for the <oracle> element

Element	Description	Count
<b>property</b>	Data source property or JDBC connection property	0..∞

For more information about the available properties, see the **Data Sources and URLs** section at Data Sources and URLs.

For more information about the available properties for a Liberty server, see the **properties.oracle** section at Liberty profile: Configuration elements in the server.xml file.

The <driverclasspath> element must contain an Oracle JDBC driver JAR file. You can download Oracle JDBC drivers from JDBC, SQLJ, Oracle JPublisher and Universal Connection Pool (UCP).

The <property> element, which can be used inside <derby>, <db2>, <mysql>, or <oracle> elements, has the following attributes:

Table 14-57. Attributes for the <property> element in a database-specific element

Attribute	Description	Required	Default
<b>name</b>	Name of the property	Yes	None
<b>type</b>	Java type of the property values, usually java.lang.String/Integer/Boolean	No	java.lang.String
<b>value</b>	Value for the property	Yes	None

## Ant tasks for installation of MobileFirst Data Proxy

Reference information for the <installdataprox>, <updatedataprox>, and <uninstalldataprox> Ant tasks.

### About the Ant tasks for installing MobileFirst Data Proxy

The purpose of these Ant Tasks is to configure the MobileFirst Data Proxy on an application server so that it can communicate with the following components:

- a Cloudant database (either Cloudant Managed or Cloudant Local)
- an Authorization Server that is embedded in a MobileFirst runtime environment.

For a Liberty server, and a stand-alone WebSphere Application Server, these Ant tasks install a Trust Association Interceptor (TAI), which acts as the front end for performing OAuth authentication of incoming requests to the MobileFirst Data Proxy.

**Note:** None of these Ant tasks install, update, or uninstall a MobileFirst runtime environment.

For more information about how to use these Ant tasks, see “Installing the MobileFirst Data Proxy with Ant tasks” on page 6-153.

For more information about installing a MobileFirst runtime environment, see “Installing the MobileFirst runtime environment” on page 6-97.

**Important:**

- The MobileFirst Data Proxy is not supported on Apache Tomcat, or on versions of WebSphere Application Server Liberty profile earlier than V8.5.5.0.
- You must install the TAI manually on WebSphere Application Server Network Deployment.

## Task effects

### <installdataprox>

The <installdataprox> Ant task configures an application server to run a MobileFirst Data Proxy. This task has the following effects:

- It deploys the MobileFirst Data Proxy WAR file on the application server.
- It configures a TAI on WebSphere Application Server Liberty and WebSphere Application Server standalone, and copies the requested files in the application server in the appropriate locations. On WebSphere Application Server standalone, it creates a configuration file for this TAI if that is required.
- It declares the MobileFirst web application in the specified context root, by default /imf-data-proxy.
- It sets MobileFirst Data Proxy configuration properties through JNDI environment entries.
- On WebSphere Application Server Liberty, it configures the web container.

### <updatedataprox>

The <updatedataprox> Ant task updates the MobileFirst Data Proxy web application, which is already configured, on an application server. This task has the following effects.

- It updates the project WAR file. The file must have the same base name as the project WAR file that was previously deployed.
- It updates the TAI files on WebSphere Application Server Liberty and WebSphere Application Server stand-alone.

The task does not change the application server configuration, which includes the web application configuration, data sources, and JNDI environment entries.

### <uninstalldataprox>

The <uninstalldataprox> Ant task undoes the effects of an earlier <installdataprox> run. This task has the following effects.

- It removes the configuration of the MobileFirst Data Proxy web application with the specified context root.
- It removes the MobileFirst Data Proxy WAR file from the application server.
- It removes the associated JNDI environment entries.

**Note:** It does not remove the TAI JAR and feature manifest files from the application server.

## Attributes and elements

The <installdataprox>, <updatedataprox>, and <uninstalldataprox> tasks have the following attributes:

Table 14-58. Attributes for the <installdataprox>, <updatedataprox>, and <uninstalldataprox> Ant tasks

Attribute	Description	Required	Default
<b>contextroot</b>	Common prefix in URLs to the application (context root)	No	/imf-data-proxy
<b>id</b>	Distinguishes different deployments	No	Empty
<b>serviceWar</b>	The WAR file for the MobileFirst Data Proxy.	No	The imf-data-proxy WAR file is in the directory Datastore, at the same level than the WorklightServer directory.
<b>DBAccount</b>	Cloudant database account, or host name of the MobileFirst Cloudant Local server.	Yes	None
<b>DBAccountUser</b>	User name for accessing the database.	Yes	None
<b>DBAccountPassword</b>	Password for accessing the database.	Yes	Queried interactively
<b>validate</b>	To validate whether the Cloudant database is accessible or not. The possible values are true or false.	No	true
<b>cloudantPort</b>	Port to access Cloudant.	No	443 or 80
<b>useHttps</b>	To indicate whether the access to Cloudant must use https. The possible values are true or false.	No	true

### contextroot and id

The contextroot and id attributes distinguish different MobileFirst projects.

In WebSphere Application Server Liberty profiles, the contextroot parameter is sufficient for this purpose. In WebSphere Application Server full profile environments, the id attribute is used instead.

### serviceWar

Use the serviceWar attribute to specify a different directory for the MobileFirst Data Proxy WAR file. You can specify the name of this WAR file with an absolute path or a relative path.

### DBAccount

The DBAccount attribute identifies either an Cloudant Managed account name or a user name defined in the configuration of a MobileFirst Cloudant Local database.

**DBAccountUser**

Use the `DBAccountUser` attribute to specify the name of a user to connect to Cloudant.

This user name can be an administrator or a non-administrator user. In all cases, the user name you provide must exist in Cloudant as the Ant task does not create it.

**DBAccountPassword**

Use the `DBAccountPassword` attribute to specify the password associated to the user specified with attribute `DBAccountUser`.

**validate**

When set to true, the `validate` attribute enables you to check that the Cloudant database identified by attribute `DBAccount` is on a reachable system and can be accessed using the credentials provided with attributes `DBAccountUser` and `DBAccountPassword`. By default, this validation is enabled.

**cloudantPort**

With the `cloudantPort` attribute, you can specify a port to access a Cloudant database directly, or a Load Balancer port if a Cloudant haproxy service is used to access the Cloudant database. If this attribute is not specified, the default port is set to 443, unless the `useHttps` attribute is set to false. In this case, the default port is set to 80.

**useHttps**

With the `useHttps` attribute, you can indicate which of the `http` or `https` protocol the MobileFirst Data Proxy must use to connect to the Cloudant database. The default protocol used is `https`.

The `<installdataprox>`, `<updatedataprox>`, and `<uninstalldataprox>` tasks support the following elements:

Table 14-59. Inner elements for the `<installdataprox>`, `<updatedataprox>`, and `<uninstalldataprox>` Ant tasks

Element	Description	Count
<b>authenticate</b>	TAI	0 for WebSphere Application Server Network Deployment  1 for WebSphere Application Server Liberty profile and WebSphere Application Server full profile
<b>applicationserver</b>	application server	1

**Important:** You cannot specify an **authenticate** element for WebSphere Application Server Network Deployment environments.

**To install a TAI**

Use the `<authentication>` element to define the TAI and, optionally, the location of the files that implement it. The attributes of this element are described in Table 3.

Table 14-60. Attributes for the <authentication> element

Attribute	Description	Count	Required	Default
<b>serverURL</b>	The Authorization Server URL	1	Yes	None
<b>taiJAR</b>	The TAI JAR file	0..1	No	File com.ibm.worklight.oauth.tai_1.0.0.jar located in a subdirectory external-server-libraries of the directory where you find worklight-ant-deployer.jar
<b>libertyFeatureManifest</b>	The TAI feature manifest (for Liberty only)	0..1	No	File 0authTai-1.0.mf located in a subdirectory external-server-libraries of the worklight-ant-deployer.jar location

**Note:** The taiJAR and libertyFeatureManifest attributes are not mandatory. For WebSphere Application Server full profile environments, you might want to specify a taiJAR attribute. For Liberty profile environments, if you specify one of these attributes, you must also specify the other.

#### **serverURL**

Use the serverURL attribute to specify the URL of a MobileFirst project in the form *http[s]://hostname:port/context-root*, where <context-root> is the context root of a MobileFirst project.

#### **taiJAR**

Use the taiJAR attribute to specify a different directory for the MobileFirst Data Proxy TAI JAR file. You can specify the name of this JAR file with an absolute path or a relative path. By default, the Ant task uses the file com.ibm.worklight.oauth.tai\_1.0.0.jar that is in a subdirectory external-server-libraries of the directory where worklight-ant-deployer.jar is.

#### **libertyFeatureManifest**

Use the libertyFeatureManifest attribute to specify a different directory for the Liberty feature manifest file. You can specify the name of this file with an absolute path or a relative path. By default, the Ant task uses the file 0authTai-1.0.mf that is in a subdirectory external-server-libraries of the worklight-ant-deployer.jar location.

### **To specify an application server**

Use the <applicationserver> element to define the parameters that depend on the underlying application server. The <applicationserver> element supports the following element. The attributes and inner elements of this element are described in tables 6 through 12 of “Ant tasks for installation of MobileFirst runtime environments” on page 14-16.

**Note:** You cannot specify Apache Tomcat, as this application server is not supported by MobileFirst Data Proxy.

Table 14-61. Inner elements for the <applicationserver> element

Element	Description	Count
<b>websphereapplicationserver</b> or <b>was</b>	The parameters for WebSphere Application Server.	1

## Internal runtime database tables

You can access a database of common tables from the MobileFirst Server. The database must not be written to, and it might change from one release to another.

The following table provides a list of common runtime database tables, their description, and how they are used.

Name	Description	Order of Magnitude
CLIENT_INSTANCES	Stores instances of client applications that have registered with the OAuth server.	1 row per device/application pair.
CLUSTER_SYNC	Internal cluster synchronization tasks.	10s of rows.
DEVICES	Tracks devices that access the platform. The devices are recorded as active or inactive, based on the configured decommissioning policy, and other information may be stored for them.	1 row per device that accesses the platform in the last <i>n</i> days, where <i>n</i> is the sum of the values for the <b>wl.device.decommission.when</b> and <b>wl.device.archiveDecommissioned</b> parameters.
GADGET_DEVICE_ASSOC	Stores relationships between a device and the applications that the device has used.	1 row per device/application pair.
GADGET_USER_PREF	User preferences according to unique user identifier. No user preferences are ready for immediate use. The App developer can add preferences.	If used, this table can contain 1 row per preference, per user.
LICENSE_TERMS	Stores the various license metrics captured every time the device decommissioning task is run.	10s of rows. Will not exceed the value set by the property <b>wl.device.decommission.when</b> .
PUSH_DEVICES	Push notification table. Stores a record per device.	1 row per device.
PUSH_SUBSCRIPTIONS	Push notification table. Stores a record per tag subscription or user subscription to event sources.	1 row per device subscription.
SSO_LOGIN_CONTEXTS	Stores the active sessions that use the SSO feature.	Depends if SSO is enabled. If enabled, there is one entry per session.
WORKLIGHT_VERSION	The product version.	1 row.

The following table provides a list of common reports database tables and their usage.

**Note:** The Reports database and all the tables listed below are deprecated in IBM MobileFirst Platform Foundation for iOS V7.0.0. Use “Operational analytics” on page 12-8 instead. Note that setting up the Reports database is optional in this release and prior releases.



Name	Description	Order of Magnitude
ACTIVITIES_CUBE	<p>A materialized table of the 4 dimensional data cube.</p> <p>Populated every night, based on the last 30 days of data. Can be used by BIRT or other reporting tools.</p>	Size depends on app and device usage, but is limited to the last 30 days for faster access to the last 30 days of activities.
APP_ACTIVITY_REPORT	<p>The reports row data. Data is aggregated by either our aggregation task or by the customer aggregation task.</p> <p>For more information about using the row data, see “Using raw data reports” on page 12-76.</p>	The size depends on application. The customer is responsible for purging older entries after aggregating to Data Warehouse.
FACT_ACTIVITIES	<p>Summarization of activities that are used for device analytics.</p> <p>Updated by MobileFirst Server every 24 hours with data from the APP_ACTIVITY_REPORT table. Primarily used by BIRT reports and by other reporting tools. The update interval can be configured with the <code>wl.db.factProcessingInterval</code> property. The processing and update can also be disabled by setting the <code>wl.db.factProcessingInterval</code> property to a negative value if only the raw data from the APP_ACTIVITY_REPORT table is of interest. For more information about the property, see “Device usage reports” on page 12-80.</p>	Size depends on app/device usage.
NOTIFICATION_ACTIVITIES	<p>Summarization of activities that are used for notification analytics.</p> <p>Updated with data from the NOTIFICATION_REPORT table. Primarily used by BIRT reports and by other reporting tools.</p>	Size depends on app/notification usage.
NOTIFICATION_PROC_REPORT	Internal table to store raw notification data. The data is aggregated by an aggregation task.	1 row per notification.
NOTIFICATION_REPORT	Each time the data processing is done, a time stamp is added to the PROC_REPORT table with the processing result (timestamp and number of processed entries).	About 72 rows per day.
OPENJPA_SEQUENCE_TABLE	Internal table created for JPA. Not used, and will be removed in the future.	n/a
PROC_REPORT	Internal table that is used for housekeeping and maintaining the state of the scheduler tasks.	About 72 rows per day.

The following table provides a list of common administration database tables, their description, and how they are used.

Name	Description	Order of Magnitude
ADAPTERS	Stores the adapter deployable elements. This table is used to synchronize the adapter deployable elements between cluster nodes. Many-to-many relationships with the PROJECTS table.	10s of rows.
APPLICATIONS	Stores the application deployable elements. This table is used to synchronize the application deployable elements between cluster nodes. Many-to-many relationships with the PROJECTS table.	10s of rows.
APPLICATIONS_ENVIRONMENTS	Environments (for example, iPhone) of deployed applications. Many-to-one relationships with the APPLICATIONS table.	10s of rows.
APP_VERSION_ACCESS_DATA	Stores the applications that have the remote disable mode to block or notify. References the APPLICATIONS_ENVIRONMENTS table.	10s of rows.
AUDIT_TRAIL	Stores an audit trail of all administrative actions performed on the administration server.	1,000s of rows.
BEACONS	Stores information about registered beacons.	1 row per registered beacon.
BEACON_TRIGGERS	Stores information about the action that is triggered when the user's mobile device comes in the vicinity of an associated beacon.	10s of rows.
BEACON_TRIGGER_ASSOC	Stores the association between beacons and triggers. Many-to-many relationship between beacons and beacon-triggers.	1 row for each association between a registered beacon and a beacon-trigger.
CONFIG_PROFILES	Stores custom logging configuration profiles that have been created by the server administrator.	1 row per configuration profile. Usually no more than 5-10 rows in total.
DIFFERENTIAL_DIRECT_UPDATE	Stores information on differential direct updates and their binaries.	1 row per environment per deployment.
FARM_CONFIG	Stores the configuration of farm nodes if a server farm is used.	10s of rows (empty if no server farm is used).
PROJECT	Stores the names of the deployed projects.	10s of rows.
PROJECT_ADAPTERS	Bidirectional association between projects and adapters.	10s of rows.
PROJECT_APPLICATIONS	Bidirectional association between projects and applications.	10s of rows.
PROJECT_LOCK	Internal cluster synchronization tasks.	10s of rows.
PUSH_ENVIRONMENTS	Push notification table. Stores details of push environments.	10s of rows.

Name	Description	Order of Magnitude
PUSH_TAGS	Push notification table. Stores details of tags defined.	10s of rows.
TRANSACTIONS	Internal cluster synchronization table storing the state of all current administrative actions.	10s of rows.
WORKLIGHTMGT_VERSION	The product version.	1 row.

## Sample configuration files

IBM MobileFirst Platform Foundation for iOS includes a number of sample configuration files to help you get started with the Ant tasks to install the MobileFirst Server administration and the MobileFirst runtime environment.

The easiest way to get started with the <configuredatabase>, <installworklightadmin> and <configureapplicationserver> Ant tasks is by working with the sample configuration files provided in the WorklightServer/configuration-samples/ directory of the MobileFirst Server distribution.

### Step 1

Pick the appropriate sample configuration file. The following files are provided

*Table 14-62. Sample configuration files provided with IBM MobileFirst Platform Foundation for iOS*

Task	Derby	DB2	MySQL	Oracle
Create databases with database administrator credentials	create-database-derby.xml	create-database-db2.xml	create-database-mysql.xml	create-database-oracle.xml
Install MobileFirst Server administration and MobileFirst runtime environment on Liberty	configure-liberty-derby.xml	configure-liberty-db2.xml	configure-liberty-mysql.xml (See Note on MySQL)	configure-liberty-oracle.xml
Install MobileFirst Server administration and MobileFirst runtime environment on WebSphere Application Server full profile, single server	configure-was-derby.xml	configure-was-db2.xml	configure-was-mysql.xml (See Note on MySQL)	configure-was-oracle.xml

Table 14-62. Sample configuration files provided with IBM MobileFirst Platform Foundation for iOS (continued)

Task	Derby	DB2	MySQL	Oracle
Install MobileFirst Server administration and MobileFirst runtime environment on WebSphere Application Server Network Deployment  (See Note on configuration files)	configure-wasnd-cluster-derby.xml  configure-wasnd-server-derby.xml  configure-wasnd-node-derby.xml  configure-wasnd-cell-derby.xml	configure-wasnd-cluster-db2.xml  configure-wasnd-server-db2.xml  configure-wasnd-node-db2.xml  configure-wasnd-cell-db2.xml	configure-wasnd-cluster-mysql.xml (See Note on MySQL)  configure-wasnd-server-mysql.xml (See Note on MySQL)  configure-wasnd-node-mysql.xml (See Note on MySQL)  configure-wasnd-cell-mysql.xml	configure-wasnd-cluster-oracle.xml  configure-wasnd-server-oracle.xml  configure-wasnd-node-oracle.xml  configure-wasnd-cell-oracle.xml
Install MobileFirst Server administration and MobileFirst runtime environment on Apache Tomcat	configure-tomcat-derby.xml	configure-tomcat-db2.xml	configure-tomcat-mysql.xml	configure-tomcat-oracle.xml
Install or upgrade IBM Worklight V5.0.6 on Liberty	redeploy506-liberty-derby.xml	redeploy506-liberty-db2.xml	redeploy506-liberty-mysql.xml (See Note on MySQL)	redeploy506-liberty-oracle.xml
Install or upgrade IBM Worklight V5.0.6 on WebSphere Application Server full profile, single server	redeploy506-was-derby.xml	redeploy506-was-db2.xml	redeploy506-was-mysql.xml (See Note on MySQL)	redeploy506-was-oracle.xml
Install or upgrade IBM Worklight V5.0.6 on WebSphere Application Server Network Deployment  (See Note on configuration files)	redeploy506-wasnd-cluster-derby.xml  redeploy506-wasnd-server-derby.xml  redeploy506-wasnd-node-derby.xml  redeploy506-wasnd-cell-derby.xml	redeploy506-wasnd-cluster-db2.xml  redeploy506-wasnd-server-db2.xml  redeploy506-wasnd-node-db2.xml  redeploy506-wasnd-cell-db2.xml	redeploy506-wasnd-cluster-mysql.xml (See Note on MySQL)  redeploy506-wasnd-server-mysql.xml (See Note on MySQL)  redeploy506-wasnd-node-mysql.xml (See Note on MySQL)  redeploy506-wasnd-cell-mysql.xml	redeploy506-wasnd-cluster-oracle.xml  redeploy506-wasnd-server-oracle.xml  redeploy506-wasnd-node-oracle.xml  redeploy506-wasnd-cell-oracle.xml

Table 14-62. Sample configuration files provided with IBM MobileFirst Platform Foundation for iOS (continued)

Task	Derby	DB2	MySQL	Oracle
Install or upgrade IBM Worklight V5.0.6 on Apache Tomcat	redeploy506-tomcat-derby.xml	redeploy506-tomcat-db2.xml	redeploy506-tomcat-mysql.xml	redeploy506-tomcat-oracle.xml

**Note on MySQL:** MySQL in combination with WebSphere Application Server Liberty profile or WebSphere Application Server full profile is not classified as a supported configuration. For more information, see WebSphere Application Server Support Statement. Consider using IBM DB2 or another database that is supported by WebSphere Application Server to benefit from a configuration that is fully supported by IBM Support.

**Note on configuration files for WebSphere Application Server Network Deployment:** The configuration files for wasnd contain a scope that can be set to **cluster**, **node**, **server**, or **cell**. For example, for configure-wasnd-cluster-derby.xml, the scope is **cluster**. These scope types define the deployment target as follows:

- **cluster:** To deploy to a cluster.
- **server:** To deploy to a single server that is managed by the deployment manager.
- **node:** To deploy to all the servers that are running on a node, but that do not belong to a cluster.
- **cell:** To deploy to all the servers on a cell.

## Step 2

Change the file access rights of the sample file to be as restrictive as possible. Step 3 requires that you supply some passwords. If you must prevent other users on the same computer from learning these passwords, you must remove the read permissions of the file for users other than yourself. You can use a command, such as the following examples:

- On UNIX:
 

```
chmod 600 configure-file.xml
```
- On Windows:
 

```
cacls configure-file.xml /P Administrators:F %USERDOMAIN%\%USERNAME%:F
```

## Step 3

Similarly, if the server is a WebSphere Application Server Liberty profile or Apache Tomcat server, and the server is meant to be started only from your user account, you must also remove the read permissions for users other than yourself from the following file:

- For WebSphere Application Server Liberty profile: wlp/usr/servers/<server>/server.xml
- For Apache Tomcat: conf/server.xml

## Step 4

Replace the placeholder values for the properties at the top of the file.

**Note:** The following special characters need to be escaped when used in values in Ant XML scripts:

- The dollar sign (\$) must be written as \$\$, unless you explicitly want to reference an Ant variable through the syntax `${variable}`, as described in Properties in the *Apache Ant Manual*.
- The ampersand character (&) must be written as `&amp;`, unless you explicitly want to reference an XML entity.
- Double quotation marks (") must be written as `&quot;`, except when inside a string that is enclosed in single quotation marks.

## Step 5

In the `<configureapplicationserver>` and `<unconfigureapplicationserver>` invocations (in target `install` and `uninstall`), define MobileFirst properties. For a list of properties that can be set, see “Configuration of MobileFirst applications on the server” on page 10-48. In production, you must often define the following specific properties:

- `publicWorkLightHostname`
- `publicWorkLightProtocol`
- `publicWorkLightPort`

## Step 6

Run the commands:

```
ant -f configure-file.xml admatabases
ant -f configure-file.xml databases
```

These commands ensure that the designated databases exist and contain the required tables for IBM MobileFirst Platform Foundation for iOS. The target `admatabases` must be run before the target `databases`. This is especially important in the case of an upgrade where management data is migrated from the runtime database to the administration database, which needs to have been initialized first by the target `admatabases`.

For an initial installation, and if a DBA has not created the databases manually, use the file in row “Create databases with database administrator credentials” of Table 14-62 on page 14-35. These files add special parameters to the `configuredatabase` Ant task (the DBA credentials). The parameters enable the Ant task to create a database and a user if required.

## Step 7

Run the command:

```
ant -f configure-file.xml admininstall
```

This command installs your Administration Services and MobileFirst Operations Console components onto the application server.

To install updated Administration Services and MobileFirst Operations Console components (for example, to apply a MobileFirst Server fix pack), run the command:

```
ant -f configure-file.xml minimal-admupdate
```

To reverse the installation step, run the command:

```
ant -f configure-file.xml admininstall
```

This command uninstalls the Administration Services and MobileFirst Operations Console components.

## Step 8

Run the command:

```
ant -f configure-file.xml install
```

This command installs your MobileFirst runtime environment as a .war file onto the application server.

To install an updated MobileFirst runtime environment onto the application server, run the command:

```
ant -f configure-file.xml minimal-update
```

To reverse the installation step, run the command:

```
ant -f configure-file.xml uninstall
```

This command uninstalls the MobileFirst runtime environment.

At least for WebSphere Application Server, it is a good idea to keep the modified *configure-file.xml* for later use when you install updates of the MobileFirst project's .war file. This file makes it possible to redeploy an updated .war file with the same MobileFirst properties. If you use the WebSphere Application Server administrative console to update the .war file, all properties that are configured for this web application are lost.





---

## Glossary

This glossary provides terms and definitions for IBM MobileFirst Platform Foundation software and documentation.

The following cross-references are used in this glossary:

- *See* refers you from a nonpreferred term to the preferred term or from an abbreviation to the spelled-out form.
- *See also* refers you to a related or contrasting term.

For other terms and definitions, see the IBM Terminology website (opens in new window).

“A” “B” on page 15-2 “C” on page 15-2 “D” on page 15-4 “E” on page 15-4 “F” on page 15-4 “G” on page 15-5 “H” on page 15-5 “I” on page 15-5 “J” on page 15-5 “K” on page 15-6 “L” on page 15-6 “M” on page 15-7 “N” on page 15-7 “O” on page 15-8 “P” on page 15-8 “R” on page 15-9 “S” on page 15-9 “T” on page 15-10 “U” on page 15-11 “V” on page 15-11 “W” on page 15-11 “X” on page 15-11

---

### A

#### **acquisition policy**

A policy that controls how data is collected from a sensor of a mobile device. The policy is defined by application code.

#### **adapter**

The server-side code of a MobileFirst application. Adapters connect to enterprise applications, deliver data to and from mobile applications, and perform any necessary server-side logic on sent data.

#### **administration database**

The database of the MobileFirst Operations Console and of the Administration Services. The database tables define elements such as applications, adapters, projects with their descriptions and orders of magnitude.

#### **Administration Services**

An application that hosts the REST services and administration tasks. The Administration Services application is packaged in its own WAR file.

**alias** An assumed or actual association between two data entities, or between a data entity and a pointer.

#### **Android**

A mobile operating system created by Google, most of which is released under the Apache 2.0 and GPLv2 open source licenses. See also mobile device.

**API** See application programming interface.

**app** A web or mobile device application. See also web application.

#### **Application Center**

A MobileFirst component that can be used to share applications and facilitate collaboration between team members in a single repository of mobile applications. See also Company Hub.

**Application Center installer**

An application that lists the catalog of available applications in the Application Center. The Application Center Installer must be present on a device so that one can install applications from a private application repository.

**application descriptor file**

A metadata file that defines various aspects of an application.

**application programming interface (API)**

An interface that allows an application program that is written in a high-level language to use specific data or functions of the operating system or another program.

**authentication**

A security service that provides proof that a user of a computer system is genuinely who that person claims to be. Common mechanisms for implementing this service are passwords and digital signatures. See also credential.

**authentication realm**

A combination of one authenticator and one login module. Each authentication realm defines its authentication flow. An authentication realm must have a corresponding challenge handler.

**authenticator**

1. A server-side component that issues a sequence of challenges on the server side and responds on the client side. See also challenge handler.
2. In the Kerberos protocol, a string of data that is generated by the client and sent with a ticket that is used by the server to certify the identity of the client.

---

**B****Base64**

A plain-text format that is used to encode binary data. Base64 encoding is commonly used in User Certificate Authentication to encode X.509 certificates, X.509 CSRs, and X.509 CRLs. See also DER encoded, PEM encoded.

**binary** Pertaining to something that is compiled, or is executable.

**BlackBerry OS**

A closed source, proprietary mobile operating system created by Research in Motion. See also mobile device.

**block** A collection of several properties (such as adapter, procedure, or parameter).

**broadcast notification**

A notification that is targeted to all of the users of a specific MobileFirst application. See also tag-based notification.

**build definition**

An object that defines a build, such as a weekly project-wide integration build.

---

**C**

**CA** See certificate authority.

**callback function**

Executable code that allows a lower-level software layer to call a function defined in a higher-level layer.

**catalog**

A collection of apps.

**certificate**

In computer security, a digital document that binds a public key to the identity of the certificate owner, thereby enabling the certificate owner to be authenticated. A certificate is issued by a certificate authority and is digitally signed by that authority. See also certificate authority.

**certificate authority (CA)**

A trusted third-party organization or company that issues the digital certificates. The certificate authority typically verifies the identity of the individuals who are granted the unique certificate. See also certificate.

**certificate authority enterprise application**

A company application that provides certificates and private keys for its client applications.

**certificate revocation list (CRL)**

A list of certificates that have been revoked before their scheduled expiration date. Certificate revocation lists are maintained by the certificate authority and used, during a Secure Sockets Layer (SSL) handshake to ensure that the certificates involved have not been revoked.

**challenge**

A request for certain information to a system. The information, which is sent back to the server in response to this request, is necessary for client authentication.

**challenge handler**

A client-side component that issues a sequence of challenges on the server side and responds on the client side. See also authenticator.

**client** A software program or computer that requests services from a server.

**client-side authentication component**

A component that collects client information, then uses login modules to verify this information.

**clone** An identical copy of the latest approved version of a component, with a new unique component ID.

**cluster**

A collection of complete systems that work together to provide a single, unified computing capability.

**company application**

An application that is designed for internal use inside a company.

**Company Hub**

An application that can distribute other specified applications to be installed on a mobile device. For example, Application Center is a Company Hub. See also Application Center.

**component**

A reusable object or program that performs a specific function and works with other components and applications.

**credential**

A set of information that grants a user or process certain access rights.

**CRL** See certificate revocation list.

---

**D****data source**

The means by which an application accesses data from a database.

**deployment**

The process of installing and configuring a software application and all its components.

**DER encoded**

Pertaining to a binary form of an ASCII PEM formatted certificate. See also Base64, PEM encoded.

**device** See mobile device.

**device context**

Data that is used to identify the location of a device. This data can include geographical coordinates, WiFi access points, and timestamp details. See also trigger.

**device enrollment**

The process of a device owner registering their device as trusted.

**documentify**

A JSONStore command used to create a document.

---

**E****emulator**

An application that can be used to run an application meant for a platform other than the current platform.

**encryption**

In computer security, the process of transforming data into an unintelligible form in such a way that the original data either cannot be obtained or can be obtained only by using a decryption process.

**enterprise application**

See company application.

**entity** A user, group, or resource that is defined to a security service.

**environment**

A specific instance of a configuration of hardware and software.

**event** An occurrence of significance to a task or system. Events can include completion or failure of an operation, a user action, or the change in state of a process.

**event source**

An object that supports an asynchronous notification server within a single Java virtual machine. Using an event source, the event listener object can be registered and used to implement any interface.

---

**F**

**facet** An XML entity that restricts XML data types.

**farm node**

A networked server that is housed in a server farm.

**fire** In object-oriented programming, to cause a state transition.

**fragment**

A file that contains HTML tags that can be appended to a parent element.

---

**G****gateway**

A device or program used to connect networks or systems with different network architectures.

**geocoding**

The process of identifying geocodes from more traditional geographic markers (addresses, postal codes, and so on). For example, a landmark can be located at the intersection of two streets, but the geocode of that landmark consists of a number sequence. See also geolocation.

**geofence**

A circle or a polygon that defines a geographical area.

**geolocation**

The process of pinpointing a location based on the assessment of various types of signals. In mobile computing, often WLAN access points and cell towers are used to approximate a location. See also geocoding, location services.

---

**H****homogeneous server farm**

A server farm in which all application servers are of the same type, level, and version.

**hybrid application**

An application that is primarily written in web-oriented languages (HTML5, CSS, and JS), but is wrapped in a native shell so that the app behaves like, and provides the user with all the capabilities of, a native app.

---

**I****in-house application**

See company application.

**inner application**

An application that contains the HTML, CSS, and JavaScript parts that run within a shell component. Inner applications must be packaged within a shell component to create a full hybrid application.

---

**J****Java Management Extensions (JMX)**

A means of doing management of and through Java technology. JMX is a universal, open extension of the Java programming language for management that can be deployed across all industries, wherever management is needed.

JMX See Java Management Extensions.

---

## K

### key

1. One or more characters within an item of data that are used to uniquely identify a record and establish its order with respect to other records.
2. A cryptographic mathematical value that is used to digitally sign, verify, encrypt, or decrypt a message. See also private key, public key.

### keychain

A password management system for Apple software. A keychain acts as a secure storage container for passwords that are used by multiple applications and services.

### key pair

In computer security, a public key and a private key. When the key pair is used for encryption, the sender uses the receiver's public key to encrypt the message, and the recipient uses their private key to decrypt the message. When the key pair is used for signing, the signer uses their private key to encrypt a representation of the message, and the recipient uses the sender's public key to decrypt the representation of the message for signature verification.

---

## L

### library

1. A system object that serves as a directory to other objects. A library groups related objects, and allows users to find objects by name.
2. A collection of model elements, including business items, processes, tasks, resources, and organizations.

### load balancing

A computer networking method for distributing workloads across multiple computers or a computer cluster, network links, central processing units, disk drives, or other resources. Successful load balancing optimizes resource use, maximizes throughput, minimizes response time, and avoids overload.

### local store

An area on a device where applications can locally store and retrieve data without the need for a network connection.

### location services

A feature that can be used to create differentiated services that are based on a user location. Location services involve collecting geolocation and WiFi data and transmitting this data to a server, where it can be used for executing business logic and analytics. Changes in the location data result in triggers being activated, which cause application logic to execute. See also geolocation.

### login module

A server-side entity that is responsible for verifying the user credentials and for creating a user identity object that holds the user properties for the remainder of the session.

---

## M

### **Managed Bean (MBean)**

In the Java Management Extensions (JMX) specification, the Java objects that implement resources and their instrumentation.

### **MBean**

See Managed Bean.

### **mobile**

See mobile device.

### **mobile client**

See Application Center installer.

### **mobile device (mobile)**

A telephone, tablet, or personal digital assistant that operates on a radio network. See also Android, BlackBerry OS.

### **MobileFirst adapter**

See adapter.

### **MobileFirst Data Proxy**

A server-side component to the IMFData SDK that can be used to secure mobile application calls to Cloudant by using MobileFirst Platform OAuth security capabilities. The MobileFirst Data Proxy requires an authentication through the trust association interceptor.

### **MobileFirst Operations Console**

A web-based interface that is used to control and manage MobileFirst runtime environments that are deployed in MobileFirst Server, and to collect and analyze user statistics.

### **MobileFirst runtime environment**

A mobile-optimized server-side component that runs the server side of your mobile applications (back-end integration, version management, security, unified push notification). Each runtime environment is packaged as a web application (WAR file).

### **MobileFirst Server**

A MobileFirst component that handles security, back-end connections, push notifications, mobile application management, and analytics. The MobileFirst Server is a collection of apps that run on an application server and acts as a runtime container for MobileFirst runtime environments.

### **MobileFirst Studio**

A MobileFirst component that is an integrated development environment (IDE) that can be used to develop and test mobile applications.

---

## N

### **native app**

An app that is compiled into binary code for use on the mobile operating system on the device.

**node** A logical group of managed servers.

### **notification**

An occurrence within a process that can trigger an action. Notifications can be used to model conditions of interest to be transmitted from a sender to a (typically unknown) set of interested parties (the receivers).

---

## O

### **OAuth**

An HTTP-based authorization protocol that gives third-party applications scoped access to a protected resource on behalf of the resource owner, by creating an approval interaction between the resource owner, client, and resource server.

---

## P

### **page navigation**

A browser feature that enables users to navigate backwards and forwards in a browser.

### **PEM encoded**

Pertaining to a Base64 encoded certificate. See also Base64, DER encoded.

**PKI** See public key infrastructure.

### **PKI bridge**

A MobileFirst Server concept that enables the User Certificate Authentication framework to communicate with a PKI.

**poll** To repeatedly request data from a server.

### **private key**

In secure communication, an algorithmic pattern used to encrypt messages that only the corresponding public key can decrypt. The private key is also used to decrypt messages that were encrypted by the corresponding public key. The private key is kept on the user system and is protected by a password. See also key, public key.

### **project**

The development environment for various components, such as applications, adapters, configuration files, custom Java code, and libraries.

### **project WAR file**

A web archive (WAR) file that contains the configurations for the MobileFirst runtime environment and is deployed on an application server.

### **provision**

To provide, deploy, and track a service, component, application, or resource.

**proxy** An application gateway from one network to another for a specific network application such as Telnet or FTP, for example, where a firewall proxy Telnet server performs authentication of the user and then lets the traffic flow through the proxy as if it were not there. Function is performed in the firewall and not in the client workstation, causing more load in the firewall.

### **public key**

In secure communication, an algorithmic pattern used to decrypt messages that were encrypted by the corresponding private key. A public key is also used to encrypt messages that can be decrypted only by the corresponding private key. Users broadcast their public keys to everyone with whom they must exchange encrypted messages. See also key, private key.

### **public key infrastructure (PKI)**

A system of digital certificates, certification authorities, and other



registration authorities that verify and authenticate the validity of each party involved in a network transaction. See also public key.

**push** To send information from a server to a client. When a server pushes content, it is the server that initiates the transaction, not a request from the client.

**push notification**

An alert indicating a change or update that appears on a mobile app icon.

---

## R

**realm** A collection of resource managers that honor a common set of user credentials and authorizations.

**reverse proxy**

An IP-forwarding topology where the proxy is on behalf of the back-end HTTP server. It is an application proxy for servers using HTTP.

**root** The directory that contains all other directories in a system.

---

## S

**SDK** See software development kit.

**security test**

An ordered set of authentication realms that is used to protect a resource such as an adapter procedure, an application, or a static URL.

**server farm**

A group of networked servers.

**server-side authentication component**

See authenticator.

**service**

A program that performs a primary function within a server or related software.

**session**

A logical or virtual connection between two stations, software programs, or devices on a network that allows the two elements to communicate and exchange data for the duration of the session.

**shell** A component that provides custom native capabilities and security features for applications.

**sideloading**

On Windows 8 environments, the process of loading a file of type appx on a mobile device without using the Windows Store.

**sign** To attach a unique electronic signature, derived from the sender's user ID, to a document or field when a document is mailed. Signing mail ensures that if an unauthorized user creates a new copy of a user's ID, the unauthorized user cannot forge signatures with it. In addition, the signature verifies that no one has tampered with the data while the message was in transit.

**simulator**

An environment for staging code that is written for a different platform. Simulators are used to develop and test code in the same IDE, but then

deploy that code to its specific platform. For example, one can develop code for an Android device on a computer, then test it using a simulator on that computer.

**skin** An element of a graphical user interface that can be changed to alter the appearance of the interface without affecting its functionality.

**slide** To move a slider interface item horizontally on a touchscreen. Typically, apps use slide gestures to lock and unlock phones, or toggle options.

**software development kit (SDK)**

A set of tools, APIs, and documentation to assist with the development of software in a specific computer language or for a particular operating environment.

**subelement**

In UN/EDIFACT EDI standards, an EDI data element that is part of an EDI composite data element. For example, an EDI data element and its qualifier are subelements of an EDI composite data element.

**subscription**

A record that contains the information that a subscriber passes to a local broker or server to describe the publications that it wants to receive.

**syntax** The rules for the construction of a command or statement.

**system message**

An automated message on a mobile device that provides operational status or alerts, for example if connections are successful or not.

---

## T

**tag-based notification**

A notification that is targeted to devices that are subscribed for a specific tag. Tags are used to represent topics that are of interest to a user. See also broadcast notification.

**TAI** See trust association interceptor.

**tap** To briefly touch a touchscreen. Typically, apps use tap gestures to select items (similar to a left mouse button click).

**template**

A group of elements that share common properties. These properties can be defined only once, at the template level, and are inherited by all elements that use the template.

**trigger**

A mechanism that detects an occurrence, and can cause additional processing in response. Triggers can be activated when changes occur in the device context. See also device context.

**trust association interceptor (TAI)**

The mechanism by which trust is validated in the product environment for every request received by the proxy server. The method of validation is agreed upon by the proxy server and the interceptor.

---

## U

### **Unstructured Supplementary Service Data (USSD)**

A communication technology that is used by GSM cellular telephones to send text messages between a mobile phone and an application program in the network. USSD establishes a real-time session between the mobile phone and the application that handles the service.

**USSD** See Unstructured Supplementary Service Data.

---

## V

**view** A pane that is outside of the editor area that can be used to look at or work with the resources in the workbench.

---

## W

### **web app**

See web application.

### **web application (web app)**

An application that is accessible by a web browser and that provides some function beyond static display of information, for instance by allowing the user to query a database. Common components of a web application include HTML pages, JSP pages, and servlets. See also app.

### **web application server**

The runtime environment for dynamic web applications. A Java EE web application server implements the services of the Java EE standard.

### **web resource**

Any one of the resources that are created during the development of a web application for example web projects, HTML pages, JavaServer Pages (JSP) files, servlets, custom tag libraries, and archive files.

### **widget**

A portable, reusable application or piece of dynamic content that can be placed into a web page, receive input, and communicate with an application or with another widget.

### **wrapper**

A section of code that contains code that could otherwise not be interpreted by the compiler. The wrapper acts as an interface between the compiler and the wrapped code.

---

## X

### **X.509 certificate**

A certificate that contains information that is defined by the X.509 standard.

---



---

## Support and comments

For the entire IBM MobileFirst Platform documentation set, training material and online forums where you can post questions, see the IBM website at:

<http://www.ibm.com/mobile-docs>

### Support

Software Subscription and Support (also referred to as Software Maintenance) is included with licenses purchased through Passport Advantage and Passport Advantage Express. For additional information about the International Passport Advantage Agreement and the IBM International Passport Advantage Express Agreement, visit the Passport Advantage website at:

<http://www.ibm.com/software/passportadvantage>

If you have a Software Subscription and Support in effect, IBM provides you assistance for your routine, short duration installation and usage (how-to) questions, and code-related questions. For additional details, consult your IBM Software Support Handbook at:

<http://www.ibm.com/support/handbook>

### Comments

We appreciate your comments about this publication. Please comment on specific errors or omissions, accuracy, organization, subject matter, or completeness of this document. The comments you send should pertain to only the information in this manual or product and the way in which the information is presented.

For technical questions and information about products and prices, please contact your IBM branch office, your IBM business partner, or your authorized remarketer.

When you send comments to IBM, you grant IBM a nonexclusive right to use or distribute your comments in any way it believes appropriate without incurring any obligation to you. IBM or any other organizations will only use the personal information that you supply to contact you about the issues that you state.

Thank you for your support.

If you would like a response from IBM, please provide the following information:

- Name
- Address
- Company or Organization
- Phone No.
- Email address



---

## Notices

This information was developed for products and services offered in the US. This material might be available from IBM in other languages. However, you may be required to own a copy of the product or product version in that language in order to access it.

IBM may not offer the products, services, or features discussed in this document in other countries. Consult your local IBM representative for information on the products and services currently available in your area. Any reference to an IBM product, program, or service is not intended to state or imply that only that IBM product, program, or service may be used. Any functionally equivalent product, program, or service that does not infringe any IBM intellectual property right may be used instead. However, it is the user's responsibility to evaluate and verify the operation of any non-IBM product, program, or service.

IBM may have patents or pending patent applications covering subject matter described in this document. The furnishing of this document does not grant you any license to these patents. You can send license inquiries, in writing, to:

*IBM Director of Licensing  
IBM Corporation  
North Castle Drive, MD-NC119  
Armonk, NY 10504-1785  
US*

For license inquiries regarding double-byte character set (DBCS) information, contact the IBM Intellectual Property Department in your country or send inquiries, in writing, to:

*Intellectual Property Licensing  
Legal and Intellectual Property Law  
IBM Japan Ltd.  
19-21, Nihonbashi-Hakozakicho, Chuo-ku  
Tokyo 103-8510, Japan*

INTERNATIONAL BUSINESS MACHINES CORPORATION PROVIDES THIS PUBLICATION "AS IS" WITHOUT WARRANTY OF ANY KIND, EITHER EXPRESS OR IMPLIED, INCLUDING, BUT NOT LIMITED TO, THE IMPLIED WARRANTIES OF NON-INFRINGEMENT, MERCHANTABILITY OR FITNESS FOR A PARTICULAR PURPOSE. Some jurisdictions do not allow disclaimer of express or implied warranties in certain transactions, therefore, this statement may not apply to you.

This information could include technical inaccuracies or typographical errors. Changes are periodically made to the information herein; these changes will be incorporated in new editions of the publication. IBM may make improvements and/or changes in the product(s) and/or the program(s) described in this publication at any time without notice.

Any references in this information to non-IBM websites are provided for convenience only and do not in any manner serve as an endorsement of those

websites. The materials at those websites are not part of the materials for this IBM product and use of those websites is at your own risk.

IBM may use or distribute any of the information you provide in any way it believes appropriate without incurring any obligation to you.

Licensees of this program who wish to have information about it for the purpose of enabling: (i) the exchange of information between independently created programs and other programs (including this one) and (ii) the mutual use of the information which has been exchanged, should contact:

*IBM Director of Licensing  
IBM Corporation  
North Castle Drive, MD-NC119  
Armonk, NY 10504-1785  
US*

Such information may be available, subject to appropriate terms and conditions, including in some cases, payment of a fee.

The licensed program described in this document and all licensed material available for it are provided by IBM under terms of the IBM Customer Agreement, IBM International Program License Agreement or any equivalent agreement between us.

The performance data and client examples cited are presented for illustrative purposes only. Actual performance results may vary depending on specific configurations and operating conditions.

Information concerning non-IBM products was obtained from the suppliers of those products, their published announcements or other publicly available sources. IBM has not tested those products and cannot confirm the accuracy of performance, compatibility or any other claims related to non-IBM products. Questions on the capabilities of non-IBM products should be addressed to the suppliers of those products.

This information contains examples of data and reports used in daily business operations. To illustrate them as completely as possible, the examples include the names of individuals, companies, brands, and products. All of these names are fictitious and any similarity to actual people or business enterprises is entirely coincidental.

#### COPYRIGHT LICENSE:

This information contains sample application programs in source language, which illustrate programming techniques on various operating platforms. You may copy, modify, and distribute these sample programs in any form without payment to IBM, for the purposes of developing, using, marketing or distributing application programs conforming to the application programming interface for the operating platform for which the sample programs are written. These examples have not been thoroughly tested under all conditions. IBM, therefore, cannot guarantee or imply reliability, serviceability, or function of these programs. The sample programs are provided "AS IS", without warranty of any kind. IBM shall not be liable for any damages arising out of your use of the sample programs.



Each copy or any portion of these sample programs or any derivative work must include a © (your company name) (year).  
Portions of this code are derived from IBM Corp. Sample Programs.  
© Copyright IBM Corp. \_enter the year or years\_.

---

## Trademarks

IBM, the IBM logo, and [ibm.com](http://ibm.com) are trademarks or registered trademarks of International Business Machines Corp., registered in many jurisdictions worldwide. Other product and service names might be trademarks of IBM or other companies. A current list of IBM trademarks is available on the web at "Copyright and trademark information" at [www.ibm.com/legal/copytrade.shtml](http://www.ibm.com/legal/copytrade.shtml).

Adobe, the Adobe logo, PostScript, and the PostScript logo are either registered trademarks or trademarks of Adobe Systems Incorporated in the United States, and/or other countries.

Linux is a registered trademark of Linus Torvalds in the United States, other countries, or both.

Microsoft, Windows, Windows NT, and the Windows logo are trademarks of Microsoft Corporation in the United States, other countries, or both.

Java and all Java-based trademarks and logos are trademarks or registered trademarks of Oracle and/or its affiliates.

UNIX is a registered trademark of The Open Group in the United States and other countries.

Node.js is a trademark of Joyent, Inc. and is used with its permission. This documentation is not formally endorsed by or affiliated with Joyent.

Other company products or service names may be trademarks or service marks of others.

This document may not be reproduced in whole or in part without the prior written permission of IBM.

---

## Terms and conditions for product documentation

Permissions for the use of these publications are granted subject to the following terms and conditions.

### Applicability

These terms and conditions are in addition to any terms of use for the IBM website.

### Personal use

You may reproduce these publications for your personal, noncommercial use provided that all proprietary notices are preserved. You may not distribute, display or make derivative work of these publications, or any portion thereof, without the express consent of IBM.

## Commercial use

You may reproduce, distribute and display these publications solely within your enterprise provided that all proprietary notices are preserved. You may not make derivative works of these publications, or reproduce, distribute or display these publications or any portion thereof outside your enterprise, without the express consent of IBM.

## Rights

Except as expressly granted in this permission, no other permissions, licenses or rights are granted, either express or implied, to the publications or any information, data, software or other intellectual property contained therein.

IBM reserves the right to withdraw the permissions granted herein whenever, in its discretion, the use of the publications is detrimental to its interest or, as determined by IBM, the above instructions are not being properly followed.

You may not download, export or re-export this information except in full compliance with all applicable laws and regulations, including all United States export laws and regulations.

IBM MAKES NO GUARANTEE ABOUT THE CONTENT OF THESE PUBLICATIONS. THE PUBLICATIONS ARE PROVIDED "AS-IS" AND WITHOUT WARRANTY OF ANY KIND, EITHER EXPRESSED OR IMPLIED, INCLUDING BUT NOT LIMITED TO IMPLIED WARRANTIES OF MERCHANTABILITY, NON-INFRINGEMENT, AND FITNESS FOR A PARTICULAR PURPOSE.

---

## IBM Online Privacy Statement

IBM Software products, including software as a service solutions, ("Software Offerings") may use cookies or other technologies to collect product usage information, to help improve the end user experience, to tailor interactions with the end user or for other purposes. In many cases no personally identifiable information is collected by the Software Offerings. Some of our Software Offerings can help enable you to collect personally identifiable information. If this Software Offering uses cookies to collect personally identifiable information, specific information about this offering's use of cookies is set forth below.

Depending upon the configurations deployed, this Software Offering may use session cookies that collect session information (generated by the application server). These cookies contain no personally identifiable information and are required for session management. Additionally, persistent cookies may be randomly generated to recognize and manage anonymous users. These cookies also contain no personally identifiable information and are required.

If the configurations deployed for this Software Offering provide you as customer the ability to collect personally identifiable information from end users via cookies and other technologies, you should seek your own legal advice about any laws applicable to such data collection, including any requirements for notice and consent. For more information about the use of various technologies, including cookies, for these purposes, see IBM's Privacy Policy at <http://www.ibm.com/privacy> and IBM's Online Privacy Statement at <http://www.ibm.com/privacy/details> the section entitled "Cookies, Web Beacons and Other Technologies" and the "IBM Software Products and Software-as-a-Service Privacy Statement" at <http://www.ibm.com/software/info/product-privacy>.

---

# Index

## Special characters

- 2-7, 8-232
- JMS adapters 8-134

## A

### access

- JavaScript adapters 8-160
- Access Control List
  - Application Center 6-198, 6-200
- access for users and groups
  - Application Center 6-198, 6-200, 6-201, 6-202
- access tokens 8-229
- accessibility 8-300
- ACL
  - Application Center 6-198, 6-200
- ACL management for Application Center with LDAP
  - WebSphere Application Server V8 6-202
- Ad Hoc Distribution 11-66
- adapter 8-114
  - SAP JCo 8-147
- adapter access 8-158, 8-160
- adapter code
  - Java, debugging 8-93
- adapter concurrency 8-122
- adapter configuration files
  - exporting 10-78
- adapter invocation 8-160
- adapter procedures
  - implementing 8-149
- adapter sandboxing 8-85
- adapter timeout 8-122
- adapter XML file 8-122
  - attributes 8-96
  - elements 8-96
  - sub-elements 8-96
- adapter XML file structure 8-96
- adapter XML schema 8-122
- adapter-based authenticator 8-274
- adapters 8-114, 10-69, 10-73
  - See also HTTP adapters
  - administering in console 10-77
  - anatomy 8-94
  - back-end responses 8-130
  - building
    - Ant task 10-69
  - Cast Iron 8-148
  - configuring 8-87, 8-112
  - configuring and implementing custom device provisioning 8-289
  - connectivity to back end 8-112
  - creating 8-87, 8-112
  - deleting 10-79
  - deploying
    - Ant task 10-69, 10-74
    - from MobileFirst Studio 8-156
    - from the console 10-79

- adapters (*continued*)
  - deploying between environments 10-1, 10-2
  - developing 8-112
  - Java 3-2
  - JavaScript, RESTful access 3-2
  - modifying 10-79
  - overview 8-85
  - replacing 10-79
  - See JMS adapters 8-134, 8-135
  - SQL 8-133
- adapters API 8-91
- administering
  - applications 11-1
  - apps and adapters
    - in MobileFirst Operations Console 10-77
- administration 6-44, 6-45, 12-17, 12-18, 12-19
- administration components and runtimes
  - asymmetric deployment 6-8
  - symmetric deployment 6-8
- administration databases 6-43
- administration services
  - Ant tasks
    - to deploy MobileFirst Operations Console and administration services 6-55
    - deploying with Ant tasks 6-55
  - Administration Services
    - installing during an upgrade 7-33
    - preparing the installation 7-9
- Advanced application authentication
  - checking 3-2
- AES specification
  - encryption algorithm 10-56
- analytics 6-145, 6-151, 12-6, 12-7, 12-8, 12-9, 12-12, 12-17, 12-18, 12-19, 12-21, 12-22, 12-23, 12-26, 12-29, 12-30, 12-31, 12-33, 12-35, 12-36, 12-37, 12-38, 12-39, 12-40, 12-41, 12-42, 12-44, 12-46, 12-47, 12-48, 12-50, 12-51, 12-52, 12-53, 12-59, 12-70, 12-71, 12-74
  - cluster deployment 12-68
  - configuring 6-151
  - installing 6-146, 6-147
  - product main features 2-1
  - production cluster setup 12-66
- analytics console 2-1
- android 8-124
- Android
  - application authenticity 8-248
  - configuring SSL with untrusted certificates 6-136
  - push notification from Application Center 11-72
  - specific requirements 11-66
- ANPS
  - SSL certificate in application descriptor 8-4
- ANT Grunt 8-15

### Ant tasks

- application servers 14-35
  - building adapters 10-69
  - building and deploying adapters and applications 10-69
  - building applications 10-69
  - configuring application servers 10-14, 10-16, 14-17, 14-35
    - WebSphere Application Server Network Deployment 10-16
  - configuring databases 10-13, 14-1
  - deploying adapters 10-74
  - deploying applications 10-74
  - deploying projects 10-69
  - for beacons and beacon triggers 11-23
  - for building projects 10-4
  - for IBM MobileFirst Platform Foundation for iOS installation 14-10
  - for product upgrades 7-11
  - installing 14-27
  - reference 14-35
  - sample configuration files 14-35
  - to create and configure databases for MobileFirst Server 6-53
  - updating deployment scripts 7-52
- anti 8-252
- Apache 10-28
- Apache Tomcat 6-86
  - topologies 6-8, 6-11
- Apache Tomcat server
  - manual configuration 6-71, 6-182, 10-38
- API 8-255
- API reference 9-1
- API, OAuth TAI 9-4
- app authenticity checks
  - enabling 10-51
  - extended 10-51
- app thinning support 3-7
- App Transport Security (ATS)
  - TLS 8-13
- app transport security support 3-7
- Apple
  - Ad Hoc Distribution 11-66
  - Apple provisioning profiles 11-66
  - Apple Push Notification Service (APNS)
    - push notification for iOS devices 8-206
  - Apple Swift
    - creating a project 8-9
  - Apple watchOS 2 8-14
- Application Center 6-22, 6-183, 6-281
  - access for users and groups 6-198, 6-200, 6-201, 6-202
  - application version numbers 11-66
  - configuring Derby manually on Tomcat 6-175
  - configuring Liberty profile for Oracle manually 6-180

- Application Center (*continued*)
    - configuring Tomcat for DB2 manually 6-171
    - configuring WebSphere Application Server for DB2 manually 6-170
    - configuring WebSphere Application Server for Derby manually 6-173
    - configuring WebSphere Application Server manually 6-185
    - deploying WAR files 6-183
    - installing manually 6-168
    - LDAP and WebSphere Application Server V7 6-198
    - LDAP and WebSphere Application Server V8 6-200, 6-201
    - managing and installing self-signed CA certificates in a test environment 6-221
    - manual configuration of DB2 6-169
    - product main features 2-1
    - setting up your Derby database manually 6-172
    - setting up your MySQL database manually 6-175
    - setting up your DB2 database manually 6-168
    - updating production apps 10-98
  - Application Center Access Control List Virtual Member Manager 6-200
  - Application Center access control with LDAP on WebSphere Application Server V8 6-202
  - Application Center client
    - configuring for push notification 11-72
  - Application Center console
    - troubleshooting a corrupted login page on Safari 11-78
  - application descriptors
    - for native applications for iOS 8-4
  - application server 6-23, 6-47, 6-50, 7-1, 7-4, 7-7
    - configuring
      - Ant task 10-14, 10-16, 14-35
      - Ant tasks 14-17
      - reference 14-35
  - application servers
    - supported for server farm
      - configuration 6-98
  - application store 2-1
  - applications
    - See also* recommended applications
    - administering 11-1
    - authenticity 8-248
    - building
      - Ant task 10-69
    - creating 8-2
    - deploying
      - Ant task 10-69, 10-74
    - developing 8-2
    - developing and publishing
      - product main features 2-1
    - hybrid 8-2
    - installing on an iOS mobile device 11-106, 11-112
    - native 8-2
  - applications (*continued*)
    - protecting traffic with
      - DataPower 6-122
    - storing properties in encrypted format 10-56
    - version numbers in Application Center 11-66
    - web 8-2
  - apps 8-15
    - administering in console 10-77
    - deleting 10-78
    - deploying 10-78
    - deploying between environments 10-1, 10-2
    - production apps
      - best practices 10-98
    - submitting 10-78
    - updating in production 10-98
  - architecture
    - push notification 8-204
  - ARM-based tablets
    - Windows executable files 11-66
  - asymmetric deployment
    - plan for administration components and runtimes 6-8
    - WebSphere Application Server Network Deployment 6-15
  - authentication 6-281
    - HTTP basic 6-127
    - of mobile devices 8-257
    - Secure Sockets Layer (SSL) 12-102
    - through a reverse proxy
      - header-based or LTPA-based 13-3
      - to protect application traffic 6-122
  - authentication configuration
    - attributes of login modules 8-282
    - authentication realms 8-252
    - authenticators 8-257
      - configuring
        - authenticators 8-262
        - realms 8-262
      - header login module 8-284
      - LDAP login module 8-286
      - login modules 8-257
        - attributes 8-282
        - header 8-284
        - LDAP 8-286
        - non-validating 8-283
        - single identity 8-284
        - WASLTPAModule 8-285
      - non-validating login module 8-283
      - single identity login module 8-284
      - WASLTPAModule login module 8-285
  - authentication configuration file 8-260
  - authentication realms 8-252
  - authenticationConfig.xml 8-260
  - authenticators 8-257
    - adapter-based 8-274
    - configuring 8-262
    - customizing 8-269
    - form-based 8-263, 8-265
    - header 8-274
    - LTPA 8-281
    - persistent cookie 8-274
  - authenticity
    - of MobileFirst applications 8-248
  - authenticity checks
    - disabling 10-51
    - enabling 10-51
    - extended 10-51
  - auto-provisioning 8-257
- ## B
- back end
    - method for push notification architecture 8-204
    - polling method
      - JMS, for push notification 8-204
  - back-end connections
    - product main features 2-1
  - back-end services 8-114
    - BPM 8-114
    - REST 8-114
    - SAP 8-114
    - WSDL 8-114
  - backward-compatibility 7-1
  - basic registry 6-281
  - BasicAuthenticator 8-263
  - beacon triggers
    - Ant task 11-23
  - beacons
    - Ant task 11-23
  - benefits of adapters 8-94
  - best practices
    - for design and architecture decisions 5-1
    - samples
      - terms and conditions of use 5-1
  - BIRT
    - installing on Apache Tomcat 12-84
    - installing on WebSphere Application Server Liberty profile 12-86
  - bit code support 3-7
  - Bitcode
    - build options 8-14
  - BlackBerry
    - push notification from Application Center 11-72
    - specific requirements 11-66
  - broadcast notifications
    - sending to the device 8-214
    - unsubscription 8-207
  - browsers
    - Safari 11-78
  - building a project
    - Ant task 10-4
  - building adapters
    - Ant task 10-69
  - building applications
    - Ant task 10-69, 10-73
  - building from IBM Worklight V6.0.0 10-73
  - Business Intelligence Reporting Tools (BIRT)
    - installing on WebSphere Application Server full profile 12-89
- ## C
- CA certificates 8-288
    - file name extensions 6-221

- Cast Iron
  - integration with IBM MobileFirst Platform Foundation for iOS 13-2
- Cast IRON adapter
  - connectionPolicy 8-99
  - elements 8-99
- Cast IRON adapter XML file 8-99
- Cast IRON adapter XML file structure 8-99
- Cast Iron adapters 8-148
- certificate authority (CA) 8-289
  - definition 6-136
  - for Secure Sockets Layer (SSL) configuration 12-102
- certificate keys
  - for application authenticity 8-248
- certificate signing request (CSR)
  - in custom device provisioning 8-289
  - to implement client-side components for custom device provisioning 8-290
  - to implement client-side components for native iOS 8-292
- certificates
  - See also* CA certificates
  - errors 12-102
  - self-signed
    - to configure SSL 6-135
  - untrusted
    - configuring SSL 6-136
  - X.509 12-102
  - X509 certificate 8-257
- challenge handling for application security 8-248
- changes 3-1
- chart types 12-22
- classic security
  - overview 8-243
- CLI 8-15
- CLI commands 8-16, 8-22, 8-28, 8-34, 8-39, 8-45, 8-51, 8-56, 8-62, 8-68, 8-74, 8-79
- client access
  - adapters 8-158
- client configuration 12-112
- client property file 8-124
- client property files
  - for native iOS applications 8-6
- client side
  - authentication certificates 12-102
  - components for custom device provisioning 8-290
  - components for native iOS 8-292
- client-side
  - API 9-183
- client-side API
  - iOS 9-2
  - Objective-C and Apple Swift language 9-2
- Cloudant 9-183
- cluster information 12-17
- clustering 12-52
- clusters
  - and application authenticity 8-248
  - installing a fix pack 7-56

- clusters (*continued*)
  - Security Socket Layer (SSL)
    - provided by the MobileFirst instance 6-240
    - tuning back-end connections for MobileFirst Server 6-105
  - collecting data 12-36
  - command 8-15
  - command-line interface
    - commands 8-16, 8-22, 8-28, 8-34, 8-39, 8-45, 8-51, 8-56, 8-62, 8-68, 8-74, 8-79
  - Company Hub
    - Windows Phone 8 applications 11-66
  - compatibility 7-1
  - completing
    - configuration 7-58
    - IBM MobileFirst Platform Foundation for iOS 7-58
  - configuration 10-81
    - security 6-117
  - configuration API 8-91
  - configuration files
    - for server farms 6-98
    - sample files 6-55
  - configurations 12-71
    - supported for LIPA security 10-90
  - configureapplicationserver
    - Ant task 14-17
  - configuredatabase
    - Ant task 14-1
  - configuring 10-28
    - adapters 8-87, 8-112
    - Ant tasks 14-27
    - Apache 10-28
    - Apache Tomcat 6-47, 6-63, 6-67, 6-77
    - application server 6-47
    - authenticators 8-262
    - custom device provisioning 8-289
    - Derby 10-28
    - device auto provisioning 8-288
    - implementing
      - custom device provisioning 8-289
    - MobileFirst Server
      - MySQL 6-143
    - realms 8-262
    - server farms 6-98
    - single sign-on 8-298, 8-299
    - user authentication 6-83, 6-84, 6-85, 6-86
    - WebSphere Application Server 6-50
    - WebSphere Application Server Liberty profile 6-47
    - WebSphere Application Server Network Deployment 6-50
  - Configuring
    - DB2 HADR seamless failover 6-22
    - MobileFirst Data Proxy 6-153
  - configuring LDAP for Application Center
    - WebSphere Application Center V8 6-201
    - WebSphere Application Server V7 6-198
  - connectionPolicy
    - attributes 8-99, 8-101, 8-104, 8-109, 8-110
    - elements 8-99, 8-101, 8-104, 8-110

- console
  - administering apps and adapters 10-77
- context root 14-17
- create adapters
  - BPM 8-115
  - RESTful 8-116
  - SAP 8-118
  - WSDL 8-119
- creating
  - adapters 8-87, 8-112
  - administration database 6-43
  - applications 8-2
- creating adapters
  - BPM 8-115
  - Business Process Manager create adapters 8-115
  - RESTful 8-116
  - SAP Gateway 8-118
  - Web Service Definition Language 8-119
- creating the Oracle database 6-45
- Cross Origin Resource Sharing (CORS)
  - JNDI properties 6-86
- cross site 8-252
- cross-site 8-252
- CSRF 8-252
- custom chart definitions 3-8
- custom charts 12-12, 12-21, 12-22, 12-23, 12-26, 12-29, 12-30, 12-31, 12-33, 12-35, 12-36, 12-37, 12-38, 12-39, 12-40, 12-41, 12-42, 12-44, 12-46, 12-47
- custom device provisioning
  - client-side and server-side implementation 8-289
  - client-side components 8-290
  - configuring 8-289
- custom requests to resources, with Objective-C 8-242
- custom security tests
  - to implement client-side components for custom device provisioning 8-290
  - to implement client-side components for native iOS 8-292
- custome certificate authorities (CA) 12-102
- customizing
  - authenticators 8-269
  - login modules 8-269
- customSecurityTest 8-249

## D

- data
  - stored as large objects (LOBs) 6-108
- data capture 12-9
- Data Management Zone (DMZ)
  - in MobileFirst topologies 6-240
- data purging 12-18
- data sharing
  - See* simple data sharing
- data sources 6-22
- Database user permissions for MobileFirst Server runtime operations 6-20
- databases
  - configuring 10-17

- databases (*continued*)
    - Ant task 10-14, 10-16, 14-1, 14-35
    - configuring by using Ant tasks 10-13
    - creating 10-17
    - creating and configuring for
      - MobileFirst Server by using Ant tasks 6-53
    - DB2
      - failure to create 6-281
      - optimizing and tuning 6-108
      - upgrading for runtime and reports 7-36
  - DataPower
    - used as security gateway to protect application traffic 6-122
  - DB2 6-60
    - configuring manually for Application Center on Tomcat 6-171
    - configuring Tomcat manually 10-23
    - configuring WebSphere Application Server Liberty manually for MobileFirst Server 6-57
    - configuring WebSphere Application Server manually for Application Center 6-170
    - configuring WebSphere Application Server manually for MobileFirst Server 6-58
    - setting up your database manually 10-18
    - setting up your database manually for Application Center 6-168
    - setting up your database manually for MobileFirst Server 6-56
  - DB2 database
    - created by the installer 6-44
  - DB2 databases
    - failure to create 6-281
  - DB2 SQL Error 6-145, 6-222
  - Debugging Java adapter code 8-93
  - default security domain 6-157
  - deleting
    - adapters 10-79
    - apps 10-78
  - deploying
    - adapters 10-1, 10-2
      - from MobileFirst Studio 8-156
      - from the console 10-79
    - apps 10-1, 10-2, 10-78
    - MobileFirst Server
      - by using the Server Configuration Tool 10-9
      - project WAR file 10-5
      - updated apps 10-98
  - deploying adapters
    - Ant task 10-69, 10-74
  - deploying applications
    - Ant task 10-69, 10-73, 10-74
  - deploying projects
    - Ant task 10-69
  - deployment scripts
    - deploying 7-52
  - deprecated API 3-9
  - deprecated features 3-8, 3-9
  - Derby 6-63, 10-28
    - configuring manually for Application Center on Tomcat 6-175
  - Derby (*continued*)
    - configuring WebSphere Application Server manually 10-26
    - configuring WebSphere Application Server manually for Application Center 6-173
    - configuring WebSphere Application Server manually for MobileFirst Server 6-62
    - configuring your database manually for MobileFirst Server 6-61
    - not supported for production 6-53
    - setting up the database manually for Application Center 6-172
    - setting up your database manually 10-24
  - Derby databases 6-61
    - manual configuration 6-61
    - not supported by server farms 6-98
    - WebSphere Application Server Liberty profile server 6-61
  - developing
    - applications 8-2
    - developing applications
      - product main features 2-1
  - Developing Java adapters 8-87
  - development environment 2-1, 7-1, 7-4, 7-7
  - device
    - management 12-95, 12-96, 12-98, 12-99
  - device access management 12-96
  - device auto provisioning
    - configuring 8-288
  - devices
    - authentication 8-257
    - configuring for push notification 11-72
    - provisioning 8-257
    - disabling an app 11-3
    - distribution structure 6-39
    - MobileFirst Server 6-39
- E**
- Eclipse 6-1
    - supported versions 2-7
  - editors 8-15
  - enabling 8-254, 12-98
  - encryption
    - for storing properties 10-56
  - endpoint
    - test token 8-241
    - token validation 8-238
  - Endpoint Manager
    - overview 13-5
  - endpoints 8-158
  - environments 8-2
    - production 10-1
    - QA 10-1
    - test 10-1
  - error
    - configuration 6-49
    - deploying with Application Center console 6-222
    - deploying with MobileFirst console 6-145
  - error (*continued*)
    - jmx configuration 6-49
    - transaction log full 6-145, 6-222
    - event types 12-12
    - event-source based notifications
      - sending to the device 8-214
    - examples 8-185
    - exporting
      - adapter configuration files 10-78
    - exporting data 12-47
    - extended application authentication
      - checking 3-2
- F**
- failure 8-171
  - favorite applications
    - push notification 11-72
  - feature comparison 12-7
  - feature table 2-8
  - feature-platform matrix 2-8
  - federal 11-123
  - Federal Desktop Core Configuration 11-123
  - Federal Information Processing Standards (FIPS)
    - security standards 11-124
  - files
    - of native API applications for iOS, copying 8-7
  - filters 12-29
  - fix pack 7-53, 7-54, 7-55, 7-58
  - fix packs
    - installing in a new cluster 7-56
  - flow chart 12-23
  - for downloading to get started tutorials
    - to get started 5-1
  - for iOS native applications
    - simple data sharing 8-254
  - form-based authenticator 8-263
  - form-based authenticators
    - implementing 8-265
  - FormBasedAuthenticator 8-263
  - framework
    - JavaScript adapter 8-94
- G**
- generating 8-114
  - Generating adapters
    - BPM 8-115
    - RESTful services 8-116
    - SAP 8-118
    - WSDL 8-119
  - getting started 5-1
  - glossary 15-1
- H**
- handling
    - interactive push notification
      - hybrid 8-209
      - ios 8-209
      - native 8-209

- handling (*continued*)
  - silent push notification
    - hybrid 8-211
    - ios 8-211
    - native 8-211
- hardware calculator 5-1
- header authenticator 8-274
- header login module 8-284
- header-based authentication
  - through reverse proxy 13-3
- HeaderAuthenticator 8-274
- HeaderLoginModule 8-284
- heap size
  - setting for the JVM 6-105
- homogeneous server farms
  - supported 6-98
- how to
  - invoke SAP JCo adapter 8-148
  - start SAP JCo adapter 8-148
- HTTP
  - adapters 8-114
    - basic authentication, rules 6-127
    - Strict Transport Security standards 6-86
- HTTP adapter
  - connectionPolicy 8-101
  - elements 8-101
- HTTP adapter XML file 8-101
- HTTP adapter XML file structure 8-101
- HTTP adapters 8-127, 8-128
  - and WebSphere Application Server
    - SSL configuration 10-54
  - encoding a SOAP XML envelope 8-125
- HTTP connections
  - tuning 6-105
- HTTP plug-in file 7-59
- HTTPS protocol
  - JNDI properties 6-86
- hybrid applications
  - accessibility 8-300
- hybrid development 2-1
- hybrid mixed development 2-1

## I

- IBM Cloudant database
  - JNDI properties 6-86
- IBM Installation Manager 6-1, 6-29
- IBM MobileFirst Platform Foundation for
  - ios 7-53, 8-15
    - classic security 8-243
    - integrating IBM Endpoint Manager 13-5
    - OAuth 8-221
    - security
      - IBM Endpoint Manager 13-5
- IBM Tealeaf
  - client-side integration 13-8
- IBM WebSphere Application Server 7-55
- ID tokens 8-229
- IDE 8-15
- implementing
  - adapter procedures 8-149
- in-place upgrade
  - versus rolling upgrade 7-16

- install
  - fix pack 7-55
- installation 6-1, 6-4, 6-29, 6-145, 6-151, 6-281
  - Ant tasks 14-10
  - of MobileFirst Server, tutorial 6-23
- installdatapxy
  - Ant task 14-27
- installing
  - Administration Services 6-43
    - preparation tasks 7-9
  - fix pack 7-56
  - IBM MobileFirst Platform Foundation for
    - ios 7-56
  - MobileFirst Operations Console 6-43
    - preparation tasks 7-9
  - MobileFirst Server
    - administration 6-43
      - by using the Server Configuration Tool 6-51
- Installing
  - Manually 6-154
  - MobileFirst Data Proxy 6-153, 6-154
  - MobileFirst OAuth Trust Association
    - Interceptor 6-157, 6-158
- installworklightadmin
  - Ant task 14-10
- integrating
  - Trusteer for ios 13-9
- integration
  - IBM Tealeaf 13-8, 13-9
- interactive notifications 8-209
- interface 8-15
- invalid server farm configurations 6-98
- invoke
  - SAP JCo adapter 8-148
- Invoking an SAP JCo adapter 8-148
- ios
  - application authenticity 8-248
  - application descriptor 8-4
  - client property file for native applications 8-6
  - configuring SSL with untrusted certificates 6-136
  - developing native applications 8-4
    - creating a Swift project 8-9
  - push notification from Application Center 11-72
  - specific requirements 11-66
- ios applications
  - Objective-C client-side API 9-2
- ios devices
  - installing applications 11-112
  - installing the client 11-106
  - ios 9, establishing trust on a provisioning file 11-106, 11-112
- ios examples 8-185
- ios native applications
  - single sign-on (SSO) 8-295
- ips 9 support 3-7

## J

- Java adapter code 8-87
- Java adapters
  - benefits 8-85
  - developing 8-87

- Java Management Extensions (JMX)
  - configuring for Tomcat 6-47
  - JNDI properties 6-86
- Java Message Service (JMS)
  - polling method for push notification 8-204
- Java Persistence API (JPA)
  - JNDI properties 6-86
- Java Runtime Environment (JRE)
  - trusstores 10-54
- java server side API 8-91
- Java virtual machine (JVM)
  - setting the heap size 6-105
- JavaScript
  - E4X 8-125
  - for adapter-based
    - authenticators 8-274
    - reserved words 8-4
  - Rhino container 8-150
  - to configure and implement custom device provisioning 8-289
- JavaScript adapter framework 8-94
- JavaScript adapters
  - benefits 8-94
  - overview 8-94
- JavaScript frameworks
  - accessibility 8-300
- JAX-RS service 8-87
- JMS adapter
  - connectionPolicy 8-104
  - elements 8-104
- JMS adapter XML file 8-104
- JMS adapter XML file structure 8-104
- JMS adapters
  - connecting to a Liberty profile server 8-135
  - connecting to a WebSphere Application Server messaging provider 8-134
  - connecting to WebSphere MQ 8-137
- JNDI properties 6-86
  - encoding 10-56
  - IBM Cloudant database 6-86
  - MobileFirst projects, configuring 10-61
  - to install a mobile client on an ios mobile device 11-106
  - to install applications on an ios mobile device 11-112
- JSON objects
  - formatting, JNDI property 6-86
- JSONStore 8-161, 8-184, 8-185
  - advanced 8-178
  - API 8-165
  - concurrency 8-181
  - error codes 8-171
  - errors 8-170
  - examples 8-174
  - Federal Information Processing Standards (FIPS) 11-124
  - general terminology 8-162
  - multiple user support 8-179
  - Objective-C 8-175
  - overview 8-161, 8-169
  - performance 8-179
  - security 8-178
  - sync 8-181

JSONStore (*continued*)  
troubleshooting 8-168, 8-169

## K

Keychain Access Group  
single sign-on (SSO) on for native iOS applications 8-295  
keys  
See certificate keys. 8-248  
keystores  
for server certificates 12-102  
Keytool  
for self-signed certificates 6-135  
known issues 3-10, 4-1  
known limitations 4-1

## L

large objects (LOBs)  
constraining size of 6-108  
LDAP  
Application Center on WebSphere Application Server V7 6-198  
Application Center on WebSphere Application Server V8 6-200, 6-201, 6-202  
LDAP login module 8-286  
LdapLoginModule 8-286  
Liberty profile 12-110, 12-113  
configuring endpoint 6-81  
configuring for DB2 manually for MobileFirst Server 6-57  
configuring for Oracle for Application Center 6-180  
configuring manually 10-40  
configuring manually for Application Center 6-169, 6-183  
JMS adapters 8-135  
Oracle  
configuring Liberty profile manually for Application Center 6-180  
property encryption 10-56  
setting JVM memory options 6-105  
tuning HTTP connections 6-105  
libraries  
of native API applications for iOS, copying 8-7  
license tracking 12-115  
Lightweight Directory Access Protocol Application Center on WebSphere Application Server V7 6-198  
Application Center on WebSphere Application Server V8 6-200, 6-201, 6-202  
limitations  
of the Server Configuration Tool 6-3  
Server Configuration Tool 10-9  
line 8-15  
local test servers  
and command-line interface (CLI) 8-16, 8-22, 8-28, 8-34, 8-39, 8-45, 8-51, 8-56, 8-62, 8-68, 8-74, 8-79  
logger API 8-91  
logging 12-1

logging (*continued*)  
JNDI properties 6-86  
login modules 8-257  
attributes 8-282  
customizing 8-269  
header 8-284  
LDAP 8-286  
non-validating 8-283  
single identity 8-284  
WASLTPAModule 8-285  
login page  
of the Application Center console, troubleshooting for Safari 11-78  
logs  
location 12-1  
monitoring 12-1  
of local test servers 8-16, 8-22, 8-28, 8-34, 8-39, 8-45, 8-51, 8-56, 8-62, 8-68, 8-74, 8-79  
LOGSECOND 6-145, 6-222  
LTPA 10-81, 10-83, 10-84, 10-94  
advanced security features 10-94  
supported configurations 10-90  
LTPA authenticator 8-281  
LTPA-based authentication through reverse proxy 13-3

## M

management console 2-1  
management operations 7-55  
manual configuration  
configuring DB2 for MobileFirst Server on Tomcat 6-60  
configuring DB2 for MobileFirst Server on WebSphere Application Server Liberty 6-57  
configuring DB2 for on Tomcat 10-23  
configuring WebSphere Application Server for Derby 10-26  
configuring WebSphere Application Server for Derby for MobileFirst Server 6-62  
configuring WebSphere Application Server for Derby sfor Application Center 6-173  
configuring your Derby database for MobileFirst Server 6-61  
DB2 for Application Center on WebSphere Application Server Liberty profile 6-169  
DB2 for WebSphere Application Server 10-20  
DB2 for WebSphere Application Server for MobileFirst Server 6-58  
DB2 for WebSphere Application Server manually for Application Center 6-170  
of WebSphere Application Server 10-42  
Oracle database 6-179  
Oracle databases 10-34  
setting up your DB2 database 10-18  
setting up your DB2 database for Application Center 6-168  
setting up your DB2 database for MobileFirst Server 6-56

manual configuration (*continued*)  
setting up your Derby database 10-24  
setting up your Derby database Application Center 6-172  
setting up your MySQL database 10-29  
setting up your MySQL database for Application Center 6-175  
setting up your MySQL database for MobileFirst Server 6-64  
setting up your Oracle database for MobileFirst Server 6-68  
Tomcat for DB2 for Application Center 6-171  
WebSphere Application Server for Application Center 6-185  
WebSphere Application Server Liberty profile 10-40  
WebSphere Application Server Liberty profile for Application Center 6-183  
manual configuration of WebSphere Application Server Liberty 6-183  
manual installation  
Application Center 6-168  
Manual installation 6-154  
manually 6-63, 6-67  
memory options  
setting for MobileFirst Server optimization 6-105  
metric group 12-26  
migrating 7-1  
migrating existing apps 7-3  
migrating existing projects 7-3  
migration 7-1, 7-3, 7-4, 7-7  
mobile applications 2-1  
mobile client  
installing on an iOS mobile device 11-106  
mobile devices  
See devices  
mobile operations 8-252, 12-100, 12-102, 12-103, 12-104, 12-105, 12-109, 12-110, 12-111, 12-112, 12-113, 12-114  
mobile security tests  
to implement client-side components for custom device provisioning 8-290  
to implement client-side components for native iOS 8-292  
MobileFirst  
classic security overview 8-243  
OAuth overview 8-221  
security configuration 10-81  
MobileFirst applications  
accessibility 8-300  
MobileFirst Command Line Interface Project 7-3  
MobileFirst Data Proxy 6-153, 6-154  
MobileFirst Operations Console  
Access Disabled 11-3  
Active 11-3  
administering apps and adapters 10-77



- MobileFirst Operations Console
  - (continued)
  - Ant tasks
    - to deploy MobileFirst Operations Console and administration services 6-55
  - controlling application
    - authenticity 8-248
  - deploying with Ant tasks 6-55
  - installing 6-43
  - installing during an upgrade 7-33
- MobileFirst Project Upgrader 7-3
- MobileFirst projects
  - configuring with JNDI properties 10-61
- MobileFirst runtime environment 7-31
  - shutting down 7-31
- MobileFirst Server 6-4, 6-19, 6-22, 6-23, 6-44, 6-45, 6-65, 7-4, 7-5, 7-53, 7-58
  - administration 6-63, 6-67, 6-71, 6-83, 6-84, 6-85, 6-86
  - configuring Tomcat for DB2 manually 6-60
  - configuring WebSphere Application Server for DB2 manually 6-58
  - configuring WebSphere Application Server for Derby manually 6-62
  - configuring WebSphere Application Server Liberty profile 6-72
  - configuring your Derby database manually 6-61
  - creating and configuring databases by using Ant tasks 6-53
  - installation
    - planning, for MobileFirst Server 6-3
  - installation, tutorial 6-23
  - keystores 12-102
  - migration 7-1
  - Oracle database
    - creating for MobileFirst Server administration 6-45
    - planning installation of 6-3
    - server farms, upgrading 7-39
    - setting up your DB2 database manually 6-56
    - setting up your MySQL database manually 6-64
    - setting up your Oracle database manually 6-68
    - Transport Layer Security v1.2 (TLS v1.2) 6-133
    - upgrade 7-1
- MobileFirst Server administration 6-61, 6-65, 6-69, 6-77
  - configuring for DB2 manually for WebSphere Application Server Liberty 6-57
  - installing by using the Server Configuration Tool 6-51
- MobileFirst Server runtime environment
  - upgrading 7-38
- MobileFirst ServerMobileFirst Server
  - internal configuration 6-105
  - optimizing and tuning 6-105
- MobileFirst Studio
  - migration 7-1

- MobileFirst Studio (continued)
  - upgrade path 7-1
- mobileSecurityTest 8-249
- modifying
  - adapters 10-79
- monitoring 12-1
  - product main features 2-1
- multi-tenancy 12-18
- MySQL 6-67, 6-143
  - setting up your database manually 10-29
  - setting up your database manually for Application Center 6-175
  - setting up your database manually for MobileFirst Server 6-64
  - stale connections 6-143
- MySQL databases 6-65
  - created by the installation tools 6-45
  - manual configuration 6-65
  - WebSphere Application Server 6-65
  - WebSphere Application Server Liberty profile server 6-65

## N

- native 8-15
- native API applications
  - for iOS
    - application descriptor 8-4
    - copying files 8-7
- native applications
  - accessibility 8-300
  - developing 8-4
  - for iOS 8-4
    - creating a Swift project 8-9
- native development 2-1
- native iOS applications
  - client property file 8-6
  - client-side components 8-292
- Network Address Translation (NAT) devices
  - topologies 6-240
- new cluster 7-59
- new features 3-1
- non-validating login module 8-283
- NonValidatingLoginModule 8-283
- notification
  - broadcast 8-207
- notifications
  - tag-based, sending 8-214
- NTLM authentication
  - ServerIdentity 8-127
  - userIdentity 8-128
- OAuth 3-2
  - overview 8-221
- OAuth TAI API 9-4
- OAuth TAI, securing with 8-230
- OAuth tokens 8-229
- OAuth, for WebSphere Application Server 8-232
- OAuth, for WebSphere Application Server Liberty 8-232
- Objective-C 9-183

- Objective-C (continued)
  - client-side API for iOS 9-2
- offline mode
  - product main features 2-1
- One-Time URLs
  - controlled by a JNDI property 11-106
- OpenJPA
  - See Java Persistence API (JPA) 6-86
- operating systems
  - specific requirements 11-66
  - supported 2-7
- operational 12-8, 12-74
- operational analytics 12-17
- optimizing MobileFirst Server
  - performance 6-105
- optional 6-43
- Oracle
  - setting up your database manually 6-179, 10-34
  - setting up your database manually for MobileFirst Server 6-68
- Oracle Database Configuration Assistant (DBCA)
  - creating an Oracle database for MobileFirst Server administration 6-45
- Oracle databases 6-69, 6-71, 6-181, 6-182, 10-36, 10-38
  - Apache Tomcat server 6-71, 6-182, 10-38
  - manual configuration 6-69, 6-71, 6-181, 6-182, 10-36, 10-38
  - WebSphere Application Server 6-69, 6-181, 10-36
  - WebSphere Application Server Liberty profile server 6-69
- orchestrations
  - integrating applications with Cast Iron 13-2
- overview 8-184, 10-79
  - Java adapters 8-85
  - JavaScript adapters 8-94
  - rolling upgrade 7-55

## P

- partitions
  - database optimization 6-108
- patterns 12-37, 12-38, 12-39, 12-40, 12-41, 12-42, 12-44, 12-46
- performance 12-70, 12-99
  - tuning back-end connections 6-105
- performande
  - optimizing for MobileFirst Server 6-105
- persistent cookie authenticator 8-274
- PersistentCookieAuthenticator 8-274
- PKI bridge 12-103, 12-104, 12-105, 12-109
- planning
  - application server 6-23
  - creation 6-19
  - databases 6-19
  - rolling upgrade 7-54
  - topology 6-23
- polling events source
  - configuring push notifications 8-216
- ports 12-51

- prerequisites 6-4
- procedures
  - invoking 8-157
  - running 8-157
  - testing 8-157
- product overview 2-1
- production deployment 12-52
- production environment 7-1, 7-4, 7-7
- profiles
  - See* Ad Hoc Distribution
- project databases
  - optimizing and tuning 6-108
- projects 8-2
  - building
    - Ant task 10-4
    - CLI 8-16
    - command line 8-16
    - command-line 8-16
    - deploying
      - Ant task 10-69
- properties 12-71
  - storing in encrypted format 10-56
- property files
  - for native iOS applications 8-6
- provisioning
  - devices 8-288
  - unique device ID 8-257
- proxy
  - See* DataPower 6-122
- proxy settings
  - for push notification 8-203
- public key infrastructure (PKI)
  - certificates 6-136
  - for the User Certificate Authentication feature 12-102
- purging data 6-108
- push API 8-91
- push notification
  - architecture 8-203, 8-204
  - broadcast 8-207
  - iOS 8-206
  - mechanism 8-203
  - product main features 2-1
  - proxy settings 8-203
  - sending to the device 8-214
  - setting up 8-206
  - tag-based notification 8-210, 8-214
  - WebSphere DataPower as a proxy 13-10
- push notification problems 8-221
- push notification problems iOS 8-221
- push notifications 8-216
  - datasource custom property 8-216
  - IBM DB2 8-216
  - polling event source 8-216
  - SMS 8-215
  - subscribing 8-208
  - WebSphere Application Server 8-216

## R

- raw reports 12-19
- realm 8-252, 10-84
- realms
  - authentication 8-252
  - configuring 8-262
  - for application authenticity 8-248

- recommended applications
  - push notification 11-72
- reference 6-86
- release notes 3-1, 3-10
  - known limitations 3-10
- releases 7-1
- remote disable 11-3
  - default behavior 11-3
  - modifying the default behavior 11-3
- remoteDisable 11-3
- removed features 3-8, 3-10
- replacing
  - adapters 10-79
- replicas 12-59
- Report viewer 12-84
- reports 12-7
  - installing BIRT on WebSphere Application Server full profile 12-89
  - raw data 12-77
  - upgrading database schemas 7-36
- resources
  - accessibility 8-300
  - custom requests using Objective-C 8-242
- REST 8-15
- RESTful access
  - JavaScript adapters 8-158
- restoring
  - configuration 7-62
  - IBM MobileFirst Platform Foundation for iOS 7-62
- restricting 6-20
- reverse proxies
  - configuring MobileFirst Server 6-133
  - single sign-on configuration 8-295
- reverse proxy 8-298, 8-299
  - deployment of topologies of server farm and WebSphere Application Server Network Deployment 6-18
  - integration and authentication 13-3
  - MobileFirst acting as 6-240
- RFC 6797
  - HTTP Strict Transport Security standards 6-86
- Rhino container 8-150
- roles
  - mapping users 14-10
- rollback procedure 7-62
- rolling upgrade 7-53, 7-55, 7-58, 7-62
  - versus in-place upgrade 7-16
- root CA certificate
  - definition 6-136
- root certificates
  - self-signed CA certificates in an Application Center test environment 6-221
- rules
  - for HTTP basic authentication 6-127
- running
  - IBM Installation Manager 6-29
- runtime middleware 2-1

## S

- Safari browsers
  - troubleshooting a corrupted Application Center login page 11-78
- samples 5-1
  - for configuration files 6-55
- sandboxing
  - adapters 8-85
- SAP
  - adapters 8-114
- SAP Gateway adapter
  - connectionPolicy 8-106
- SAP JCo adapter
  - connectionPolicy 8-109
- SAP JCo adapter XML file 8-109
- SAP JCo adapter XML file structure 8-109
- SAP JCo adapters 8-147
- scalability
  - guide to scalability and hardware sizing 5-1
- search 12-6
- Secure Socket Layer (SSL) configuration
  - configuring in WebSphere Application Server, HTTP adapters 10-54
- Secure Sockets Layer (SSL)
  - to configure authentication 12-102
- securing
  - administration
    - MobileFirst Server 6-117
- security 10-79, 10-83, 10-84, 10-85, 10-94, 12-48, 12-50
  - advanced features 10-94
  - application authenticity 8-248
  - configuration 6-117
  - configuring a MobileFirst instance 10-81
  - customizing authenticators and login modules 8-269
  - DataPower features to protect application traffic 6-122
  - Federal Information Processing Standards (FIPS) 11-124
  - for One-Time URLs 11-106
  - HTTP Strict Transport Security standards 6-86
  - IBM Endpoint Manager 13-5
  - LTPA 10-94
  - mapping users to roles 14-10
  - product main features 2-1
  - supported configurations for LTPA 10-90
  - tests 8-249
  - Transport Layer Security v1.2 6-133
- security API 8-91
- security filter
  - for Node.js 8-230
- security framework
  - overview 8-221
- security tests
  - mobile or custom, configuring single sign-on 8-295
- security utilities 8-184, 8-185
- securityTest 8-249

- self-signed certificates
  - CA certificates, managing and installing in an Application Center test environment 6-221
  - not supported by the User Certificate Authentication feature 12-102
  - to configure SSL 6-135
- sending
  - interactive push notification 8-209
  - silent push notification 8-211
- server configuration 12-102, 12-111
- Server Configuration Tool
  - deploying a MobileFirst Server 10-9
  - installation tool for MobileFirst Server 6-3
  - installing MobileFirst Server administration 6-51
  - limitations 10-9
- server farm
  - reverse proxy 6-18
- server farms 7-39
  - homogeneous, as opposed to heterogeneous 6-98
  - installation, specific configuration 6-3
  - invalid configuration 6-98
  - not supported by the Server Configuration Tool 6-3, 10-9
  - planning the configuration 6-98
  - when to declare 6-98
- server requirements 12-109
- server side
  - authentication certificates 12-102
- servers
  - for local tests 8-16, 8-22, 8-28, 8-34, 8-39, 8-45, 8-51, 8-56, 8-62, 8-68, 8-74, 8-79
- services discovery wizard 8-114
- session affinity 7-59
- setup 8-185
- shards 12-53
- sharing
  - See* simple data sharing
- Short Message Service (SMS)
  - as a form of push notification 8-203
- sideloading Windows applications 11-66
- silent notification 8-211
- simple data sharing 8-253, 8-254, 8-255
  - enabling for iOS native applications 8-254
  - limitations 8-256
  - overview 8-253
  - troubleshooting 8-256
- single identity login module 8-284
- single sign-on (SSO)
  - configuring for devices 8-295
- SingleIdentityLoginModule 8-284
- skins 8-2
  - adding by using the command-line interface (CLI) 8-16, 8-22, 8-28, 8-34, 8-39, 8-45, 8-51, 8-56, 8-62, 8-68, 8-74, 8-79
- SMS
  - push notification 8-215
  - two-way communication 8-219
- SOAP
  - generating adapters 8-114
  - services in HTTP adapters 8-125
- SOAP (*continued*)
  - web services 8-114
- software development kits
  - supported 2-7
- source control 8-2
- specific security domain 6-158
- SQL adapter
  - connectionPolicy 8-110
  - elements 8-110
- SQL adapter XML file 8-110
- SQL adapter XML file structure 8-110
- SQL adapters 8-133
- SSL
  - configuring between adapters and back-end servers 6-135
  - Configuring for Application Center 6-219
  - configuring with untrusted certificates 6-136
  - JNDI properties 6-86
  - security with a server farm 6-98
  - setting up certificate keystore 10-55
  - untrusted certificates
    - configuring SSL 6-136
- SSL certificate
  - for native iOS applications 8-4
- SSO (single sign-on) mechanism
  - optimization and tuning of MobileFirst Server 6-105
- stopping
  - management operations 7-55
  - runtime environments 7-31
- Studio 8-15
- submitting
  - apps 10-78
- Swift 9-183
  - creating a project 8-9
- switching
  - HTTP traffic 7-59
- symmetric deployment
  - plan for administration components and runtimes 6-8
- symmetric-key algorithm
  - for encrypting properties 10-56
- T**
- tablets
  - See* ARM-based tablets
- tag-based notifications
  - sending 8-214
  - sending to the device 8-214
- Tealeaf
  - integration 13-8
  - server-side integration 13-9
- terminology 8-254, 15-1
- terms and conditions of use
  - for samples 5-1
- test environments
  - managing and installing self-signed CA certificates 6-221
- test servers
  - local, and command-line interface (CLI) 8-16, 8-22, 8-28, 8-34, 8-39, 8-45, 8-51, 8-56, 8-62, 8-68, 8-74, 8-79
- testing adapter
  - CLI (command line interface) 8-157
- testing adapter (*continued*)
  - command line interface (CLI) 8-157
  - Postman 8-157
  - studio 8-157
- testing applications
  - product main features 2-1
- tests
  - security 8-249
- TLS v1.2
  - See* Transport Layer Security v1.2
- to MobileFirst ServerV7.0.0 7-7
- tokens
  - for challenge handling 8-248
- Tomcat
  - configuring Derby manually for Application Center 6-175
  - configuring for DB2 manually for Application Center 6-171
  - configuring for DB2 manually for MobileFirst Server 6-60
  - configuring for MobileFirst Server administration manually 6-77
  - configuring the JMX connection 6-47
  - setting JVM memory options 6-105
  - tuning HTTP connections 6-105
- tools 8-15
- topologies 6-23, 10-94
- topology
  - asymmetric deployment 6-15
  - MobileFirst instance 6-240
  - plan deployment of administration components and runtimes 6-8
  - reverse proxy with server farm and WebSphere Application Server Network Deployment 6-18
  - server farm 6-11
  - stand-alone 6-8
  - WebSphere Application Server Network Deployment 6-15
- tracking licenses 12-115
- traffic of mobile applications
  - protecting with DataPower 6-122
- Transport Layer Security (TLS) 8-13
- Transport Layer Security v1.2
  - configuring MobileFirst Server 6-133
- troubleshooting 4-1, 6-281, 12-114
  - corrupted Application Center login page in Safari browsers 11-78
  - DB2 databases 6-281
  - jmx configuration 6-49
  - liberty profile 6-49
  - push notification 8-221
- trusstores
  - and SSL configuration 10-54
- Trust Association Interceptor 6-157, 6-158, 8-230
- trusted certificates 6-136
- Trusteer 10-81, 10-85
  - assessment 10-89
- Trusteer for iOS
  - integration 13-9
- trusstores
  - for client certificates 12-102
- tutorials
  - basic installation of MobileFirst Server 6-23

tutorials and samples 5-1

## U

unconfigureapplicationserve  
  Ant task 14-17

uninstallation 6-281

uninstalldataprox  
  Ant task 14-27

uninstalling  
  IBM MobileFirst Platform Foundation  
  for iOS 7-62

uninstalling from  
  old cluster 7-62

uninstallworklightadmin  
  Ant task 14-10

unique device ID 8-257

United States Government Configuration  
  Baseline 11-123

Unstructured Supplementary Service  
  Data (USSD)  
  command-line option 8-16, 8-22,  
  8-28, 8-34, 8-39, 8-45, 8-51, 8-56, 8-62,  
  8-68, 8-74, 8-79

updateapplicationserver  
  Ant task 14-17

updatedataprox  
  Ant task 14-27

updateworklightadmin  
  Ant task 14-10

updating  
  DB2 schema names 7-51

upgrade path 7-1

upgraded CLI 7-3

upgrades  
  from V5.0.6.x 7-11  
  from V6.0.0.x 7-11  
  in-place or rolling upgrade 7-16  
  installing Administration Services  
  and 7-33  
  of MobileFirst Server runtime  
  environments 7-38  
  of server farms to MobileFirst Server  
  V 7.0.0 7-39  
  to V7.0.0 7-7

upgrading 7-4, 7-5, 7-7  
  MobileFirst Server 7-4, 7-5  
  in production 7-4, 7-5  
  overview 7-5

upgrading to MobileFirst Server V  
  7.0.0 7-39

user authentication for MobileFirst  
  Application Center 6-202

user certificate authentication 12-100,  
  12-102, 12-103, 12-104, 12-105, 12-109,  
  12-110, 12-111, 12-112, 12-113, 12-114

User Certificate Authentication  
  feature 12-102

user certificate enrollment 8-252

user to device mapping 12-96

## V

verifying  
  IBM MobileFirst Platform Foundation  
  for iOS 7-58  
  installation 7-58

version 7-1

version control 8-2

versions 7-1

versions of applications  
  in Application Center 11-66

Virtual Member Manager  
  Application Center Access Control  
  List 6-200

VMM  
  Virtual Member Manager 6-200

## W

WAR files  
  Ant task for building a project 10-4

WAR files for MobileFirst projects  
  deploying 10-5

WASLTPAModule login module 8-285

web browsers  
  supported 2-7

web development 2-1

webSecurityTest 8-249

WebSphere 12-68

WebSphere Application Server 6-157,  
  6-158, 8-134  
  configuring for Application  
  Center 6-185  
  configuring for DB2 manually for  
  Application Center 6-170  
  configuring for DB2 manually for  
  MobileFirst Server 6-58  
  configuring for Derby  
  manually 10-26  
  configuring for Derby manually for  
  Application Center 6-173  
  configuring for Derby manually for  
  MobileFirst Server 6-62  
  configuring manually 10-42  
  configuring manually for DB2 10-20  
  Liberty profile 6-72  
  manual configuration 6-65, 6-69,  
  6-72, 6-74, 6-181, 10-36  
  outbound dynamic  
  configuration 10-54  
  property encryption 10-56  
  setting JVM memory options 6-105  
  SOAP XML envelope for HTTP  
  adapters 8-125  
  SSL configuration and HTTP  
  adapters 10-54  
  tuning HTTP connections 6-105

WebSphere Application Server full  
  profile 6-84  
  installing BIRT 12-89  
  topologies 6-8, 6-11

WebSphere Application Server Liberty  
  configuring manually 10-40  
  Setting up an IBM HTTP  
  Server 6-252

WebSphere Application Server Liberty  
  profile 6-85, 6-281  
  installing BIRT 12-86  
  topologies 6-8, 6-11

WebSphere Application Server Liberty  
  profile server  
  manual configuration 6-61, 6-65, 6-69

WebSphere Application Server Network  
  Deployment 6-157, 6-158  
  configuring application servers  
  Ant tasks 10-16  
  reverse proxy 6-18  
  topologies 6-15

WebSphere Application Server V7  
  configuring LDAP for Application  
  Center 6-198

WebSphere Application Server V8  
  configuring LDAP for Application  
  Center 6-201  
  managing ACL for Application Center  
  with LDAP 6-202

WebSphere DataPower  
  push notification proxy 13-10

WebSphere MQ  
  JMS adapters 8-137

WebSphereFormBasedAuthenticator 8-  
  281

WebSphereLoginModule 8-285

what's new 3-1, 3-2, 3-4, 3-7, 3-8, 3-9,  
  3-10  
  API 3-5  
  external library 3-5

Windows 8  
  sideloading applications 11-66  
  specific requirements 11-66

Windows Phone 8  
  application enrollment token 11-66  
  specific requirements 11-66

wl\_unprotected 8-249

wladm  
  Ant task for beacon and beacon  
  triggers 11-23  
  program  
  beacon triggers 11-50  
  beacons 11-50

## X

X.509 certificates 12-102  
  *See* self-signed certificates

X509 certificate  
  for mobile device  
  authentication 8-257

Xcode 8-14

XCode IDE  
  creating a Swift project 8-9

XML envelope  
  for SOAP-based services in HTTP  
  adapters 8-125

XSRF 8-252