



IBM Retail Store Solutions

IBM Point-of-Sale Teleconference Series: October 19, 2004

Tammy Priest

Agenda

- Introduction and Marketing Update – Tammy Priest
 - FS/TEC
 - 2005 Retail Store Solutions Education Conference
 - Customer Reference Incentive
 - SurePOS 500 Trade-in program and co-marketing incentive
 - Self Checkout Update
 - Education Update

- Competitive Advantages of the SurePOS 500 – Mike West

- Software Maintenance Education – Armando Sardellitti

Foodservice Technology Conference

- October 24-27, 2004
 - Gaylord Palms Resort and Convention Center, Orlando, FL
- Booth #1101
- Are you exhibiting at FS/TEC?
 - If so, contact Belinda Whitaker-Gary to have your company represented in IBM's Booth Directory
 - bfw@us.ibm.com
- Executive Briefings – over 15 topics will be covered
 - For a complete list of briefing topics, contact your Distributor
 - To sign up for a briefing, contact Jim Richardson at wjr@us.ibm.com
- To register for the event, visit www.fstec.com
- For questions about the IBM booth at FS/TEC, please contact Belinda Whitaker-Gary at bfw@us.ibm.com

2005 Retail Store Solutions Education Conference

- January 30 – February 2, 2005, Long Beach, CA
- Registration begins October 15, 2004
 - www.pc.ibm.com/store/rssec
- New activities for this 2005 include:
 - Fully global Worldwide event
 - Earn PartnerWorld credits onsite – complete the Technical and Sales Mastery Exam
 - New sponsorship opportunities for Business Partners
 - Contact Pete Benda at pbenda@us.ibm.com, or 919-301-5595
 - Optional Sunday activities
- Other opportunities:
 - Pre-schedule meetings with IBM executives
 - Meet with other award winning Business Partners and ISVs

Customer Reference Incentive

- Get a **FREE** admission to the 2005 Retail Store Solutions Education Conference by submitting a Customer Reference
 - \$900 USD Value
 - Have your customer win listed in the IBM Customer Reference Database
 - Be a featured Business Partner in our IBM newsletter to over 100 POS sales representatives
 - Forms available from Cathy Wagner: cew@us.ibm.com

IBM SurePOS 500 Programs to Promote Customer Satisfaction

- End User Trade-in Program for SurePOS 500
 - Announced September 7, 2005, Letter # 304-152
 - http://www.ibm.com/isource/cgi-bin/goto?it=usa_annred&on=304-152
 - End User Customers can receive
 - \$400 rebate for replacing a 5X1 model with a 5X3 model
 - \$600 rebate for replacing a 5X2 model with a 5X3 model

- IBM SurePOS 500 Marketing Incentive

IBM will fund 100% (up to \$4,000) of an approved, end-user facing, demand generation activity that promotes the SurePOS 500 Trade In Program

- IBM Business Partner must
 - Submit application to Nancy Greene by November 1, 2004
 - Submit invoices to Nancy Greene by November 31, 2004
 - Send to nagreene@us.ibm.com

Self Checkout Update

- Self Checkout Account Management class
 - Being converted to a self-study format
 - Available for download by the end of November
 - After you download and complete the course, you may submit the checklist and apply for approval to sell self checkout via the same process
- **Remember**
 - You MUST identify a self checkout project manager and send them to the Project Management class within 60 days of receiving your approval to sell self checkout
- The last Self Checkout Project Management class of the year
 - December 6-10 in Jacksonville, FL.
 - To enroll, go to www.ibm.com/education/retail
- For questions, or if you need a copy of the checklist, please contact Cathy Wagner at cew@us.ibm.com

Upcoming education

www.ibm.com/education/retail for more information

- **RE3000**: Data Integration Facility course is now available!
- **RE2150D**: IBM SurePOS ACE V3 Loyalty course will be updated by November 15
- Self Checkout Account Management course (**self-study version**) will be available end of November
- **RE9500**: Electronic Check Conversion will be available by November 15
- **RE6000**: IRES Technical course will be available by the end of November
- Self Checkout Project Management course in Jacksonville, FL from December 6-10. This will be your last chance to take this course until after the facility relocates to Raleigh. Next class will not be scheduled until late 1Q05/early 2Q05!



IBM Retail Store Solutions

IBM SurePOS 500 – Competitive Advantages



Agenda

- IBM SurePOS 500 – A Superior POS Platform
- Infrared vs. Resistive & Capacitive Touch Technologies
- IBM SurePOS 500 vs. NCR RealPOS 70
- IBM SurePOS 500 vs. Wincor Nixdorf Beetle /iPOS
- Summary & Wrap-Up



IBM SurePOS 500 – Superior POS Platform

Investment Protection

- Unique design characteristics
 - Infra red touch technology
 - Cooling tunnel
- Supports wireless, multi-monitor dual screen & remote systems management
- Fast, industry standard processor
- Improved MSR
 - Programmable
 - Foil cards
 - Improved Bios & driver support
- Retail hardening
 - Spill resistant – Isolated key components

Connectivity Expandability

- Fixed tailgate
- Enhanced cable management
- Legacy migration (RS-232) to USB & powered USB



Configuration Flexibility

- Sleek & compact
- Minimized footprint & shorter height
- Fits more environments
- Wall mounting for drive thru & kiosk
- Fits directly on top of cash drawer w/ foot
- Backward compatible to current SP500 trays

SurePOS 500 – Infrared Technology

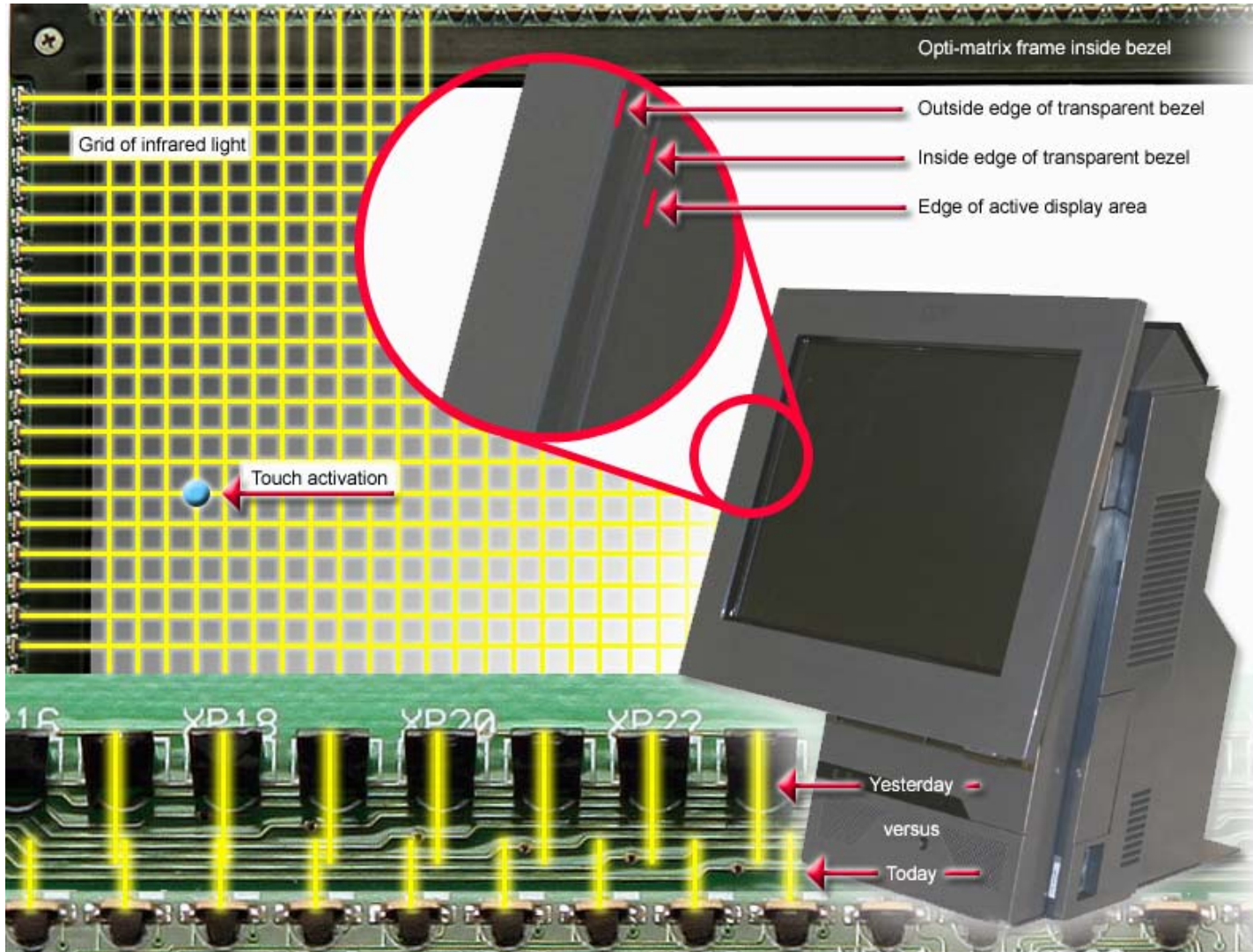

Touch Technologies – How They Work

Resistive Touch Screen

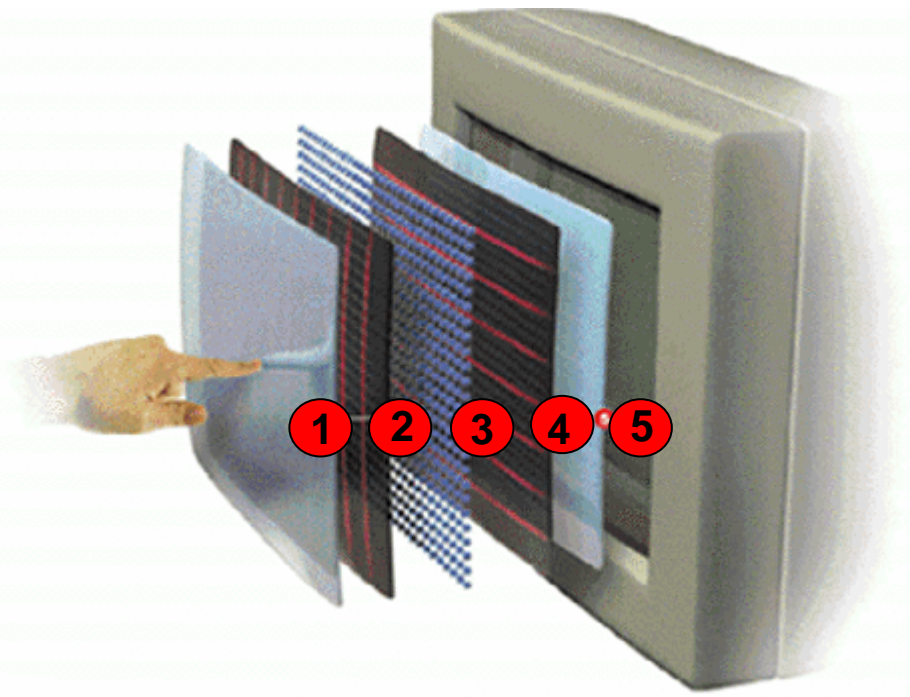

- ① Polyester cover sheet – scratch resistant
- ② Conductive coating
- ③ Spacer dots
- ④ Conductive coating
- ⑤ Glass panel

Capacitive Touch Screen

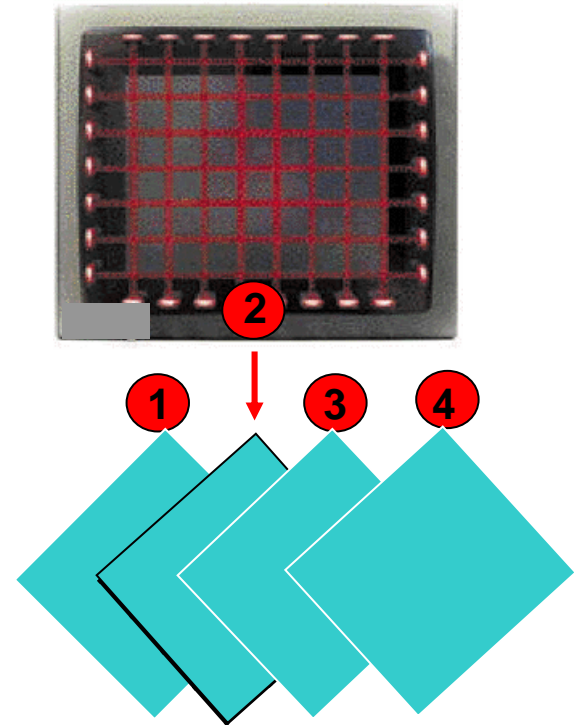

- ① Cover sheet – scratch resistant
- ② Electrode pattern
- ③ Conductive coating
- ④ Glass panel

Touch Technologies – Usability Comparison

	Capacitive	Resistive	Infrared
Transmittance	Medium 80% - 85%	Poor 75% - 80%	Excellent 92%
Glare	Poor	Moderate	Excellent
Durability	Very Good	Poor	Excellent
Reliability	Good	Poor	Excellent
Sealability	Good	Very Good	Excellent
Calibration issues	Yes	Yes	Self calibrating
Gloved Finger	No	Yes	Yes
Stylus	No	Yes	Yes
Long Fingernail	No	Yes	Yes
Credit Card	No	Yes	Yes

SurePOS 500 & Cooling Tunnel Technology

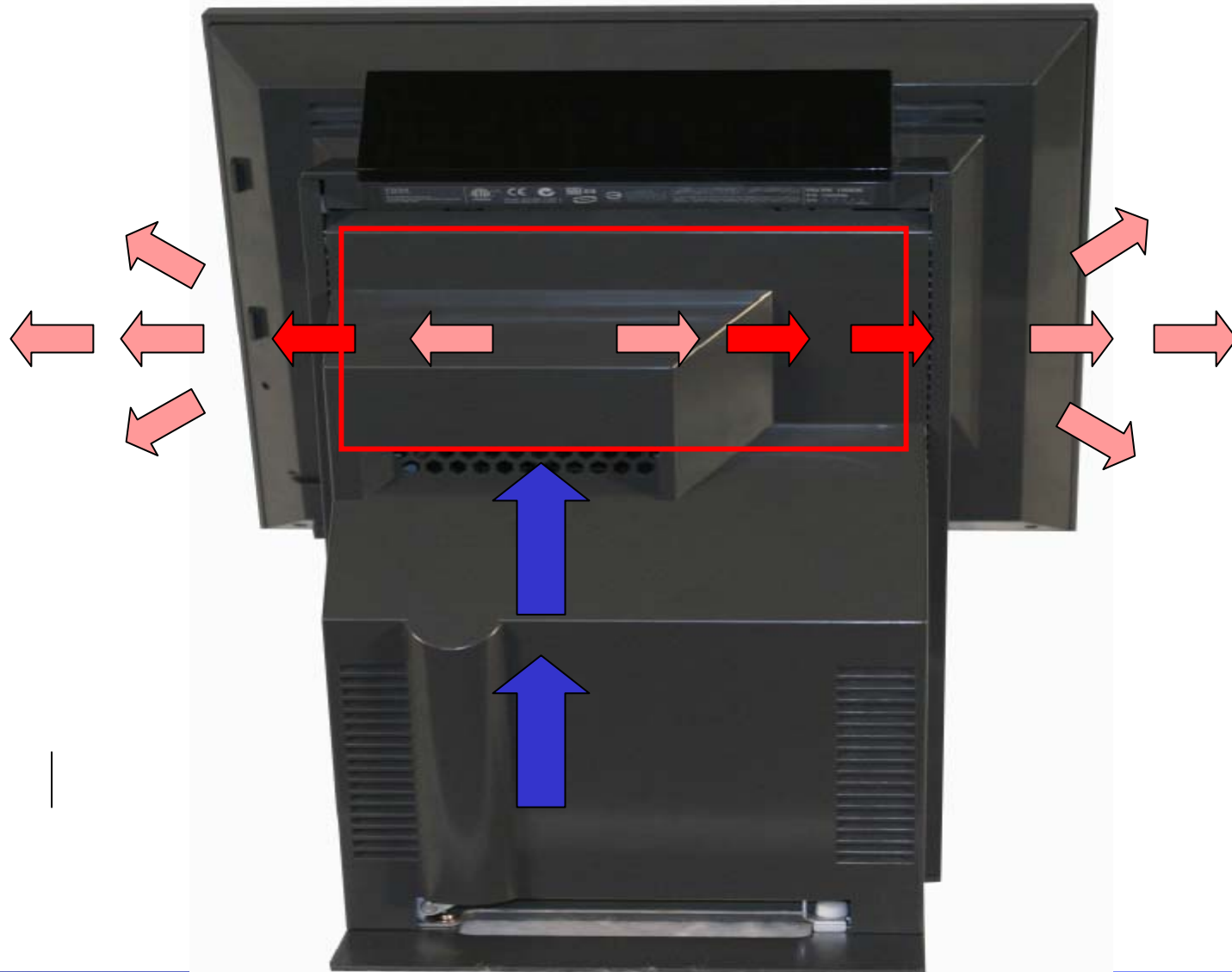

IBM SurePOS 500 vs. NCR RealPOS 70



Product Attribute Comparison



IBM

SurePOS 500



NCR

RealPOS 70



Micros

Eclipse



Par

POS 4XP



Wincor Nixdorf

Beetle /iPOS

	IBM	NCR	Micros	Par	Wincor Nixdorf
Investment Protection	✓	✓	✓	✓	✓
Connectivity / Expandability	★	✓	✓	✓	✓
Configuration Flexibility	★	✓	▲	▲	✓
Serviceability	▲	★	▲	▲	▲
Price	✓	✓	✓	✓	★

Legend: ★ Leadership ✓ Competitive ▲ Meets Reqs ○ Noncompetitive

Product Attribute Comparison

IBM offers:

- Superior unique design characteristics
 - Infrared touch technology
 - Cooling tunnel technology
- Superior connectivity & expandability
 - Fixed tailgate
 - 3x more USB connectivity
 - Side access ports
 - 512MB compact flash (need for XPe)
- Superior configuration flexibility
 - Counter or wall mount options
 - Reuse existing integration trays

NCR offers:

- Superior serviceability
 - “Tool-free” service



	SurePOS 500	RealPOS 70
Investment Protection	✓	✓
Connectivity / Expandability	★	✓
Configuration Flexibility	★	✓
Serviceability	▲	★
Price	✓	✓

SurePOS 500 – Superior Connectivity & Expandability



- Fixed tailgate – No peripheral cable flex or fatigue
- Floating tailgate – Peripheral cables may become unseated and disconnect from panel

IBM SurePOS 500 – Fixed tailgate



Cable clamp



NCR RealPOS 70



NCR RealPOS 70 – Floating tailgate

Defense Against NCR Tool-Free Serviceability Claims - Anatomy of a Service Call

- What POS components generate a service call?

Answer: Majority (90%) placed on peripherals

- How do service costs breakout?

Answer: Main component is total time to complete call

- Is service only about replacing physical components in a damaged unit?

Answer: No! Minority (10%) attributed to system unit. App reload.

- How does tool-free serviceability design affect POS retail hardening?

Answer: Snap & hook components more vulnerable to harsh retail world

- How does tool-free serviceability design affect POS security?

Answer: Easy to remove & replace = Easy to take & access

- Will a customer get a cost return on the tool-free serviceability features?

Answer: No?



IBM SurePOS 500 vs. NCR RealPOS 70 - Summary

- IBM SurePOS 500 offers:

- ★ Superior unique design characteristics
- ★ Superior connectivity & expandability
- ★ Superior configuration flexibility



- Front service & “tool-free” serviceability not proven to save retail service costs
- “Snap & hook” components raise retail hardened and security questions

IBM SurePOS 500 vs. Wincor Nixdorf Beetle /iPOS



Product Attribute Comparison



IBM



NCR



Micros



Par



Wincor Nixdorf

	SurePOS 500	RealPOS 70	Eclipse	POS 4XP	Beetle /iPOS
--	-------------	------------	---------	---------	--------------

Investment Protection	✓	✓	✓	✓	✓
Connectivity / Expandability	★	✓	✓	✓	✓
Configuration Flexibility	★	✓	▲	▲	✓
Serviceability	▲	★	▲	▲	▲
Price	✓	✓	✓	✓	★

Legend:	★ Leadership	✓ Competitive	▲ Meets Reqs	○ Noncompetitive
----------------	--------------	---------------	--------------	------------------

Product Attribute Comparison

- Superior unique design characteristics
 - Infrared touch technology
 - Cooling tunnel technology
 - Form factor (style + design)
 - Spill resistant

- Superior connectivity & expandability
 - Fixed tailgate
 - Faster processor
 - More system + video memory
 - More standard RS-232 ports
 - 3x more USB connectivity
 - Powered USB
 - Robust power management
 - Auto sensing power supply
 - Side access ports

- Superior configuration flexibility
 - Reuse existing integration trays

- Price
- Configuration flexibility
 - POS board



	SurePOS 500	Beetle /iPOS
Investment Protection	✓	✓
Connectivity / Expandability	★	✓
Configuration Flexibility	★	✓
Serviceability	▲	▲
Price	✓	★

SurePOS 500 – Superior Connectivity & Expandability



- Fixed tailgate – No peripheral cable flex or fatigue
- Floating tailgate – Peripheral cables may become unseated and disconnect from panel

IBM SurePOS 500 – Fixed tailgate

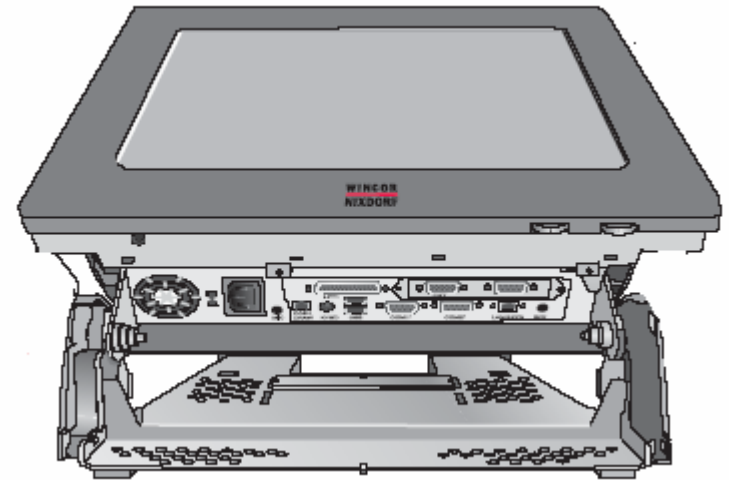

Wincor /iPOS – Floating tailgate

Cable clamp

SurePOS 500 – Superior Spill Resistant Design ★



SurePOS 500

- Spill resistant – louvered vents
- Design channels fluids off of POS
- Air intake recessed in rear cover



Beetle /iPOS

- Recessed seam – allows fluids into chassis
- Speakers susceptible to spills
- Claim “Splash Proof” design

SurePOS 500 – Superior Style & Design ★

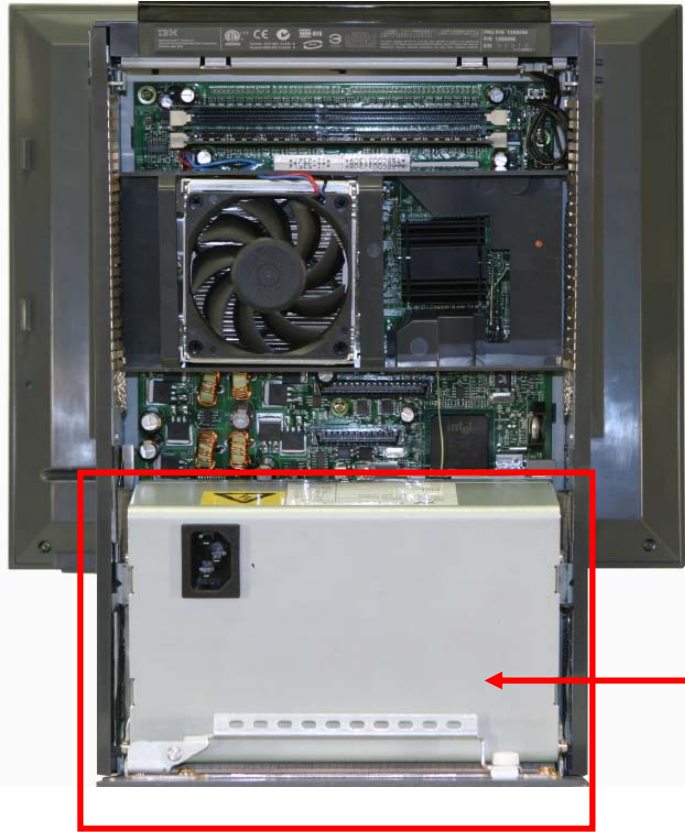

SurePOS 500

- Beetle /iPOS components mounted behind bezel – making terminal “top heavy”

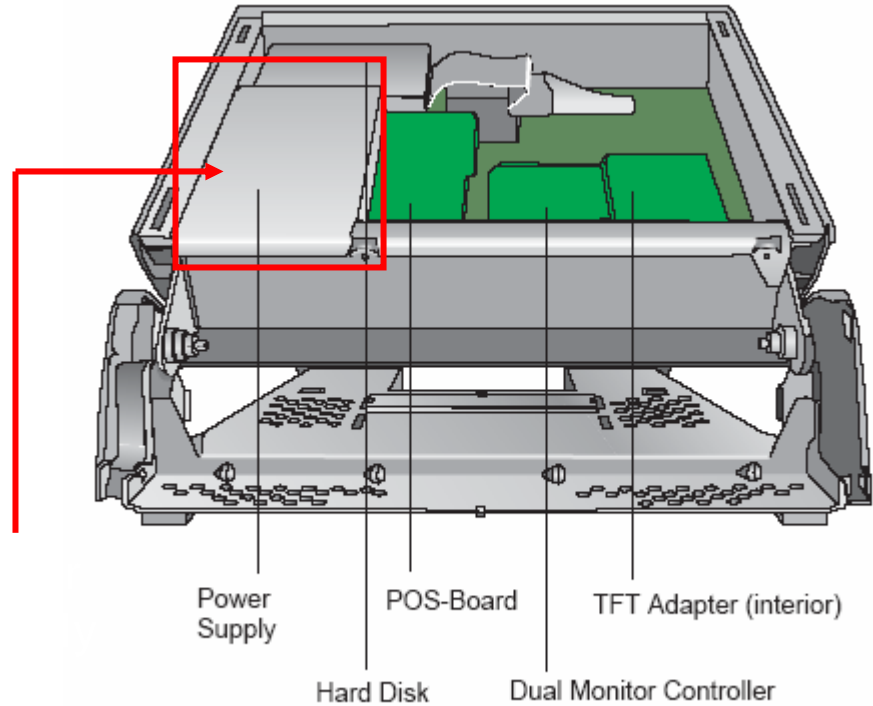

Beetle /iPOS

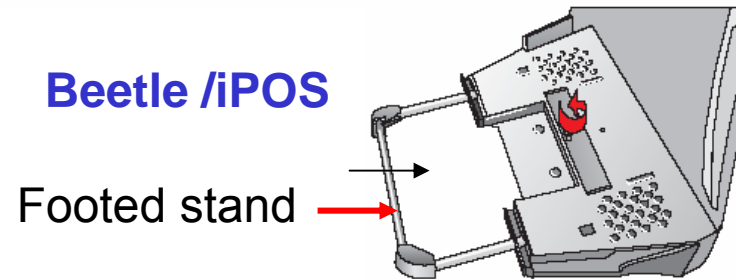

SurePOS 500 – Superior Connectivity & Expandability



	SurePOS 500	Beetle /iPOS	IBM Advantage
Processor	2.0GHz Intel Celeron	1.7GHz Intel P4	+
Base Memory	128MB	64MB	+
Memory Capacity	Up to 2GB	Up to 512MB	+
Video Memory	8MB – 64MB UMA	4MB – 10MB	+
RS-232 Ports	4	2 std.	+
USB Ports	6	2	+
Powered USB Ports	2	0	+
Power Management	APM, ACPI	APM	+
Power Supply	76W / 200W switched power	115V or 230V Manual power	+
Spill Resistant	Yes	No	+

Wincor Beetle /iPOS – POS Board (opt.)



- 2x RS-232 (not powered) + cash drawer

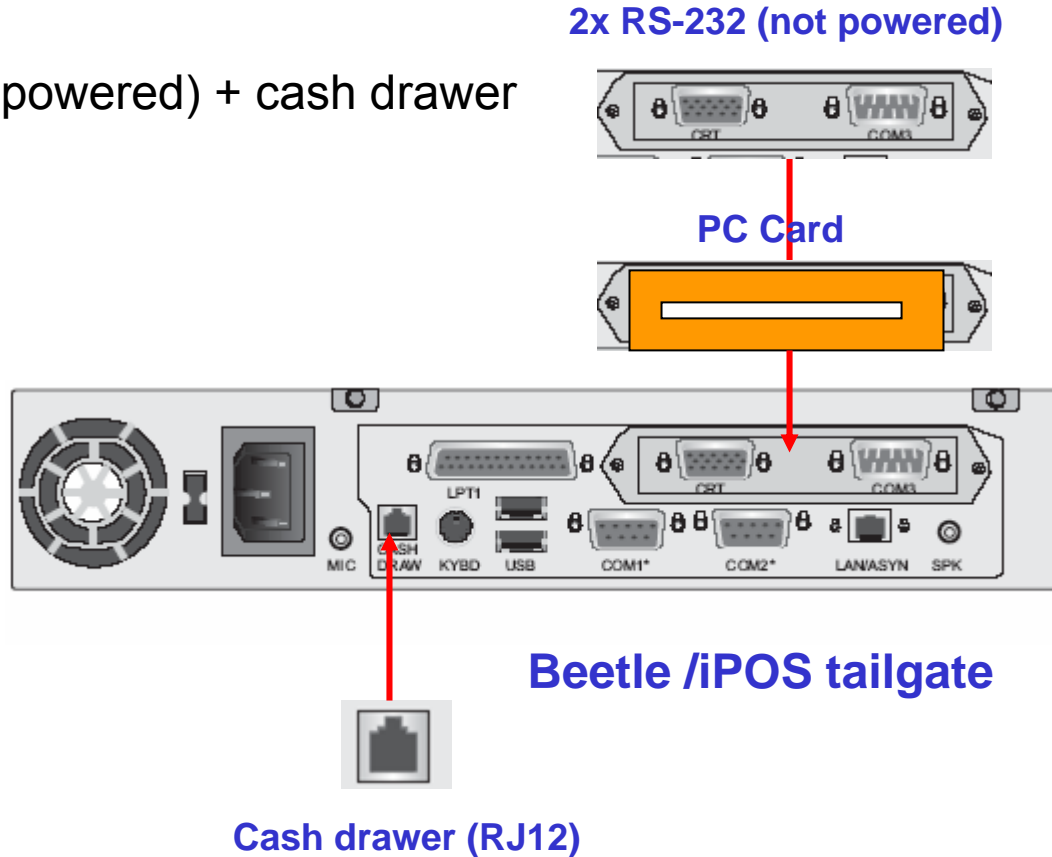

(120W power supply)

SurePOS 500 – Superior Configuration Flexibility



SurePOS 500

- Counter and wall mount options
- Reuse existing integration trays

Beetle /iPOS

- Counter and wall mount options only



IBM SurePOS 500 – Summary & Wrap Up

- IBM SurePOS 500 offers:

- ★ Superior unique design characteristics
- ★ Superior connectivity & expandability
- ★ Superior configuration flexibility

