

Advanced Analytics Data to Smart Decisions

Richard Wozniak

Program Director IBM Information Management

Presentation developed by IBM Research
Business Analytics and Mathematical Science Group

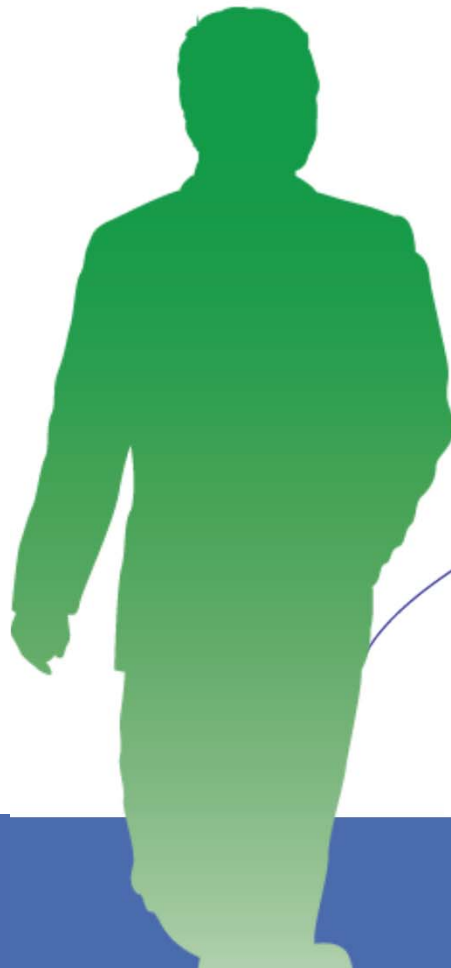

IBM Information
ON Demand 2010



INFORMATION-LED
TRANSFORMATION



January 21 - SINGAPORE • January 26 – MALAYSIA • January 28 - THAILAND

Agenda

- Overview of Advanced Analytics
- The Importance of Advanced Analytics Today
- IBM's Approach
 - Healthcare
 - Supply Chain
 - System Risk Modeling
- Research Frontiers

Advanced Analytics

is the use of data and models to provide insight to guide decisions

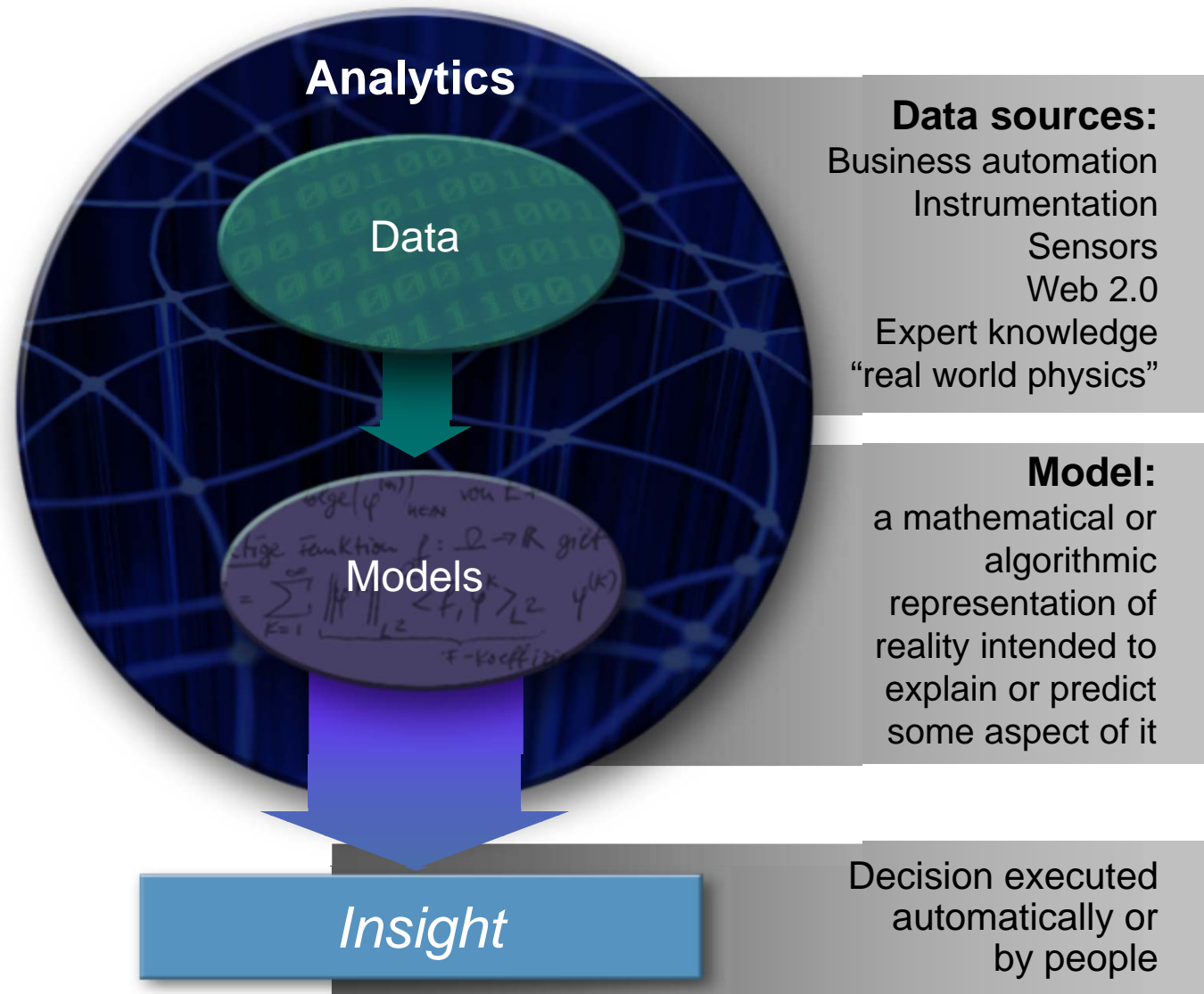

Models Have Been Used for Decades in Engineering

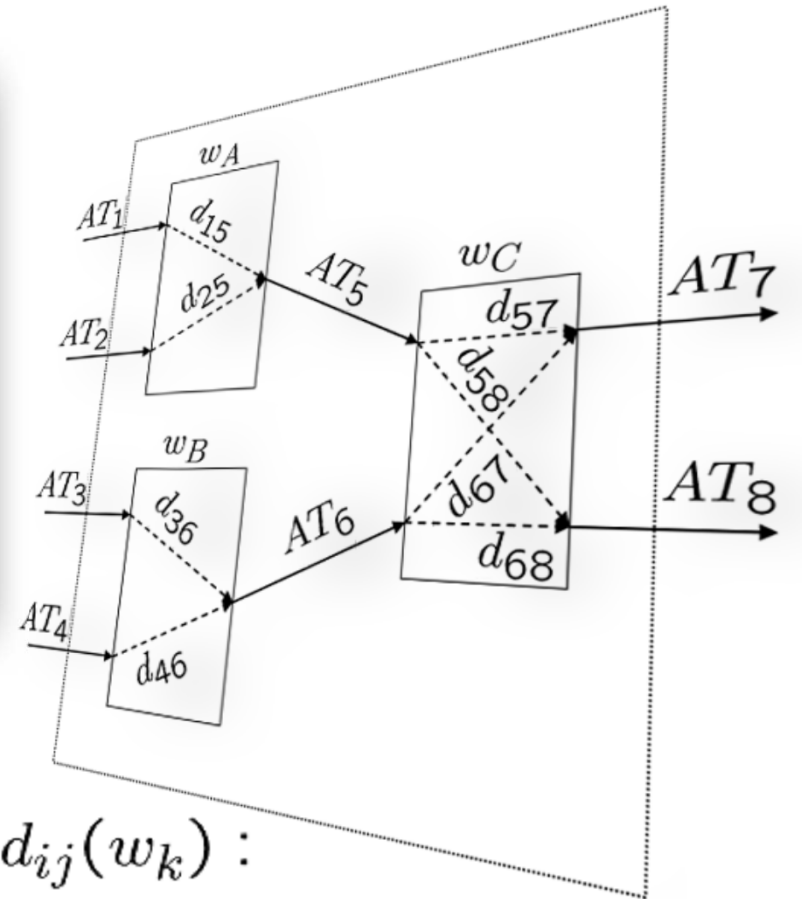
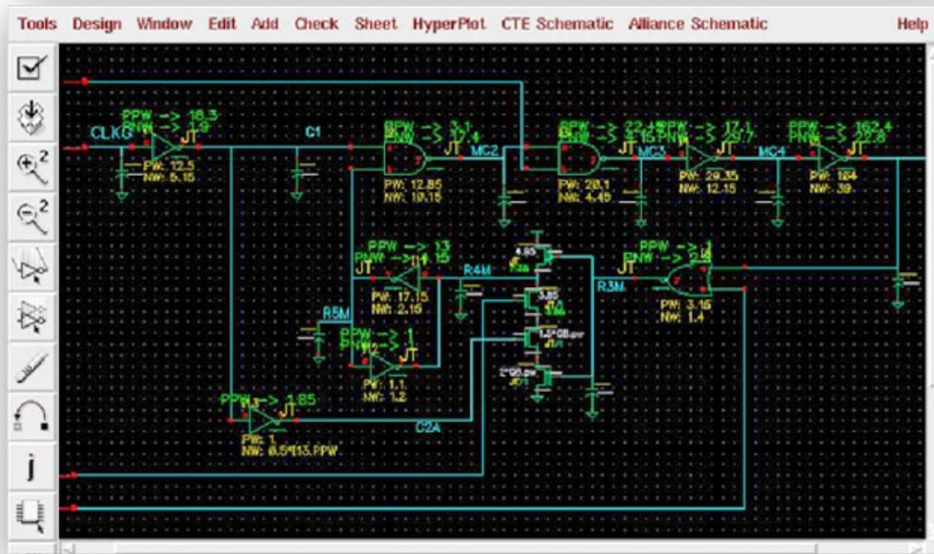

$$\begin{aligned} \min_{w_k} \quad & \max\{AT_i : i \in PO\} \\ \text{s.t.} \quad & AT_j = \max\{AT_i + d_{ij}(w_k) : \\ & \quad j \in \text{input}(i)\} \\ & w_k^L \leq w_k \leq w_k^U \end{aligned}$$

Some Instances of Advanced Analytics Have Become Mainstream

- Digital Maps
- User interface
- Robust Algorithm
- Sufficient computation power

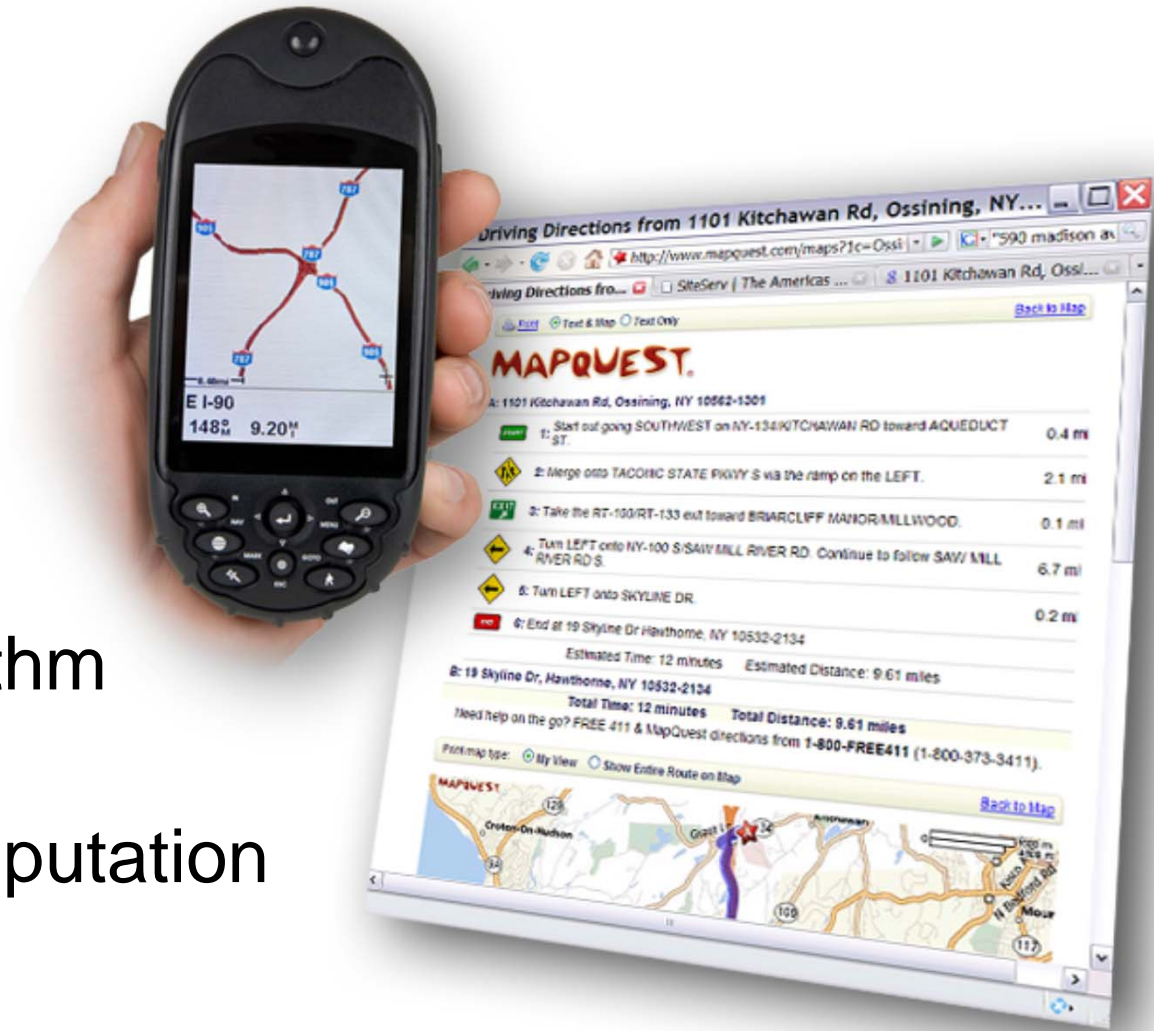

Why Are Advanced Analytics Important Now?

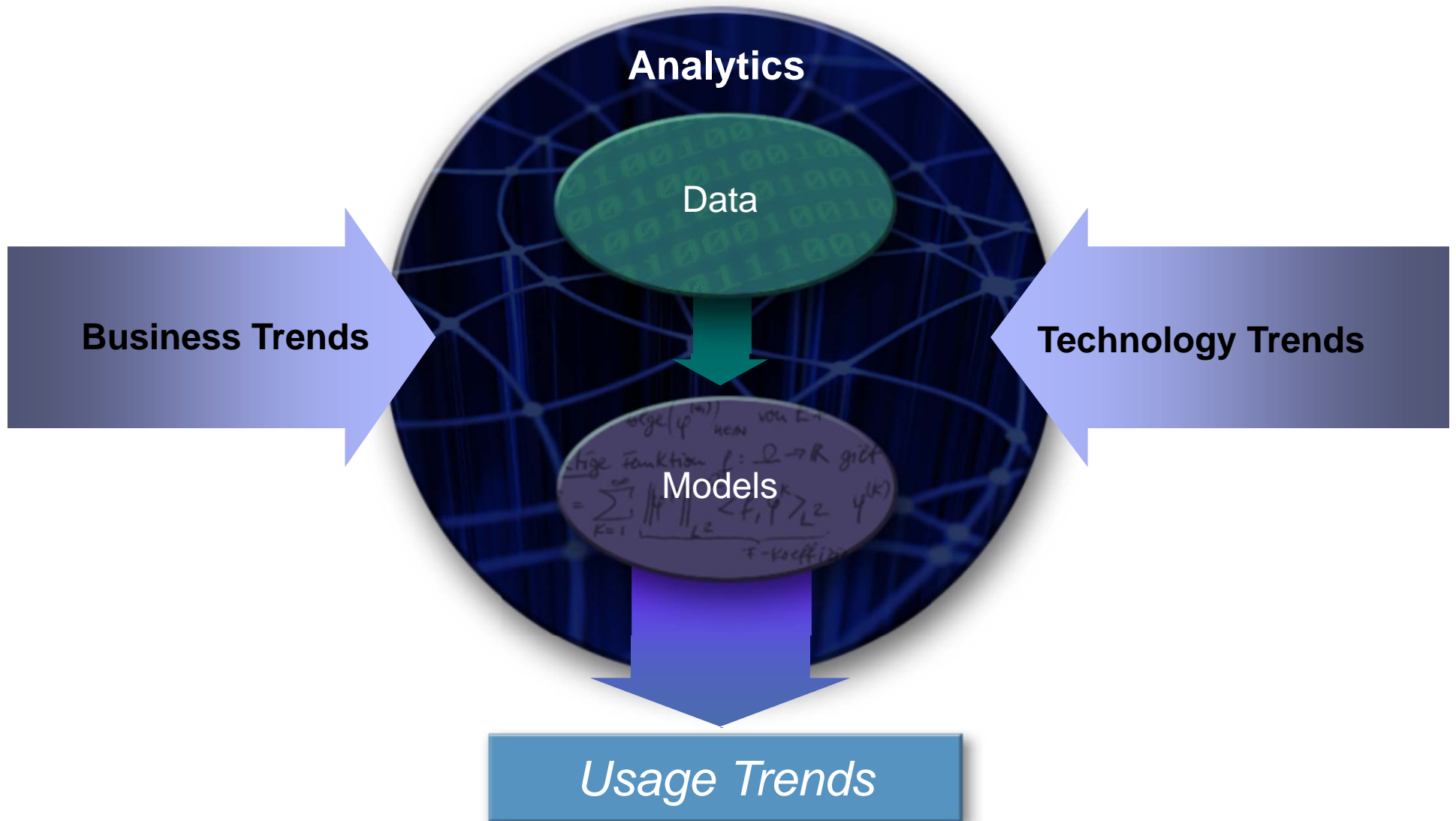

Advanced Analytics Provide Competitive Advantage

Sales Analytics for IBM increases revenue by over \$1B

Claims analytics saved SSA over \$2 billion and reduced the average approval time by 70 days



Customer Relationship Analytics for MTN reduces customer churn

Collection Optimization will increase NY revenue by \$100M over 3 years

Optimized generation saves Red Eléctrica de España €50,000 per day

Analytics Landscape

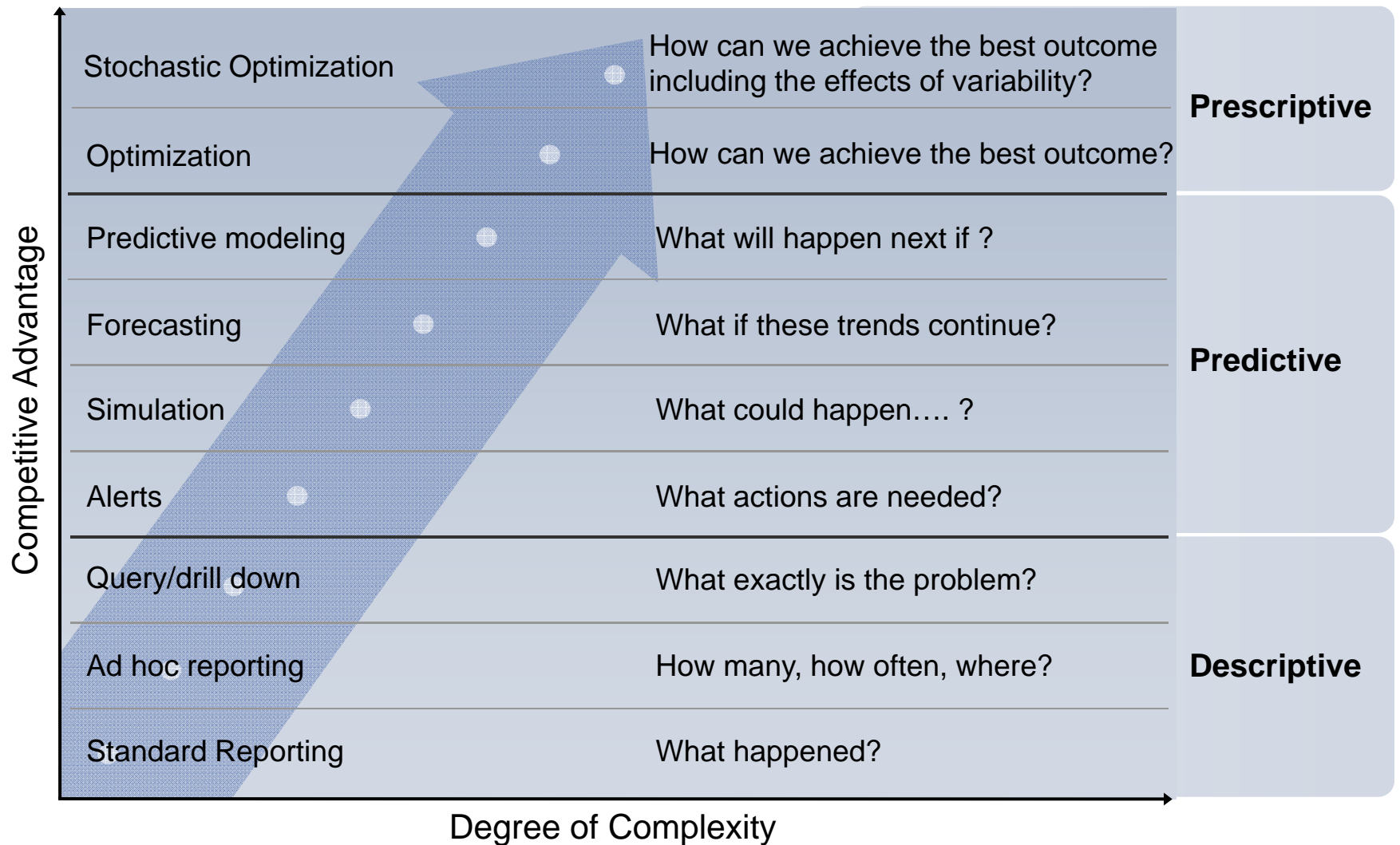

Based on: Competing on Analytics, Davenport and Harris, 2007

Analytics Opportunity Framework

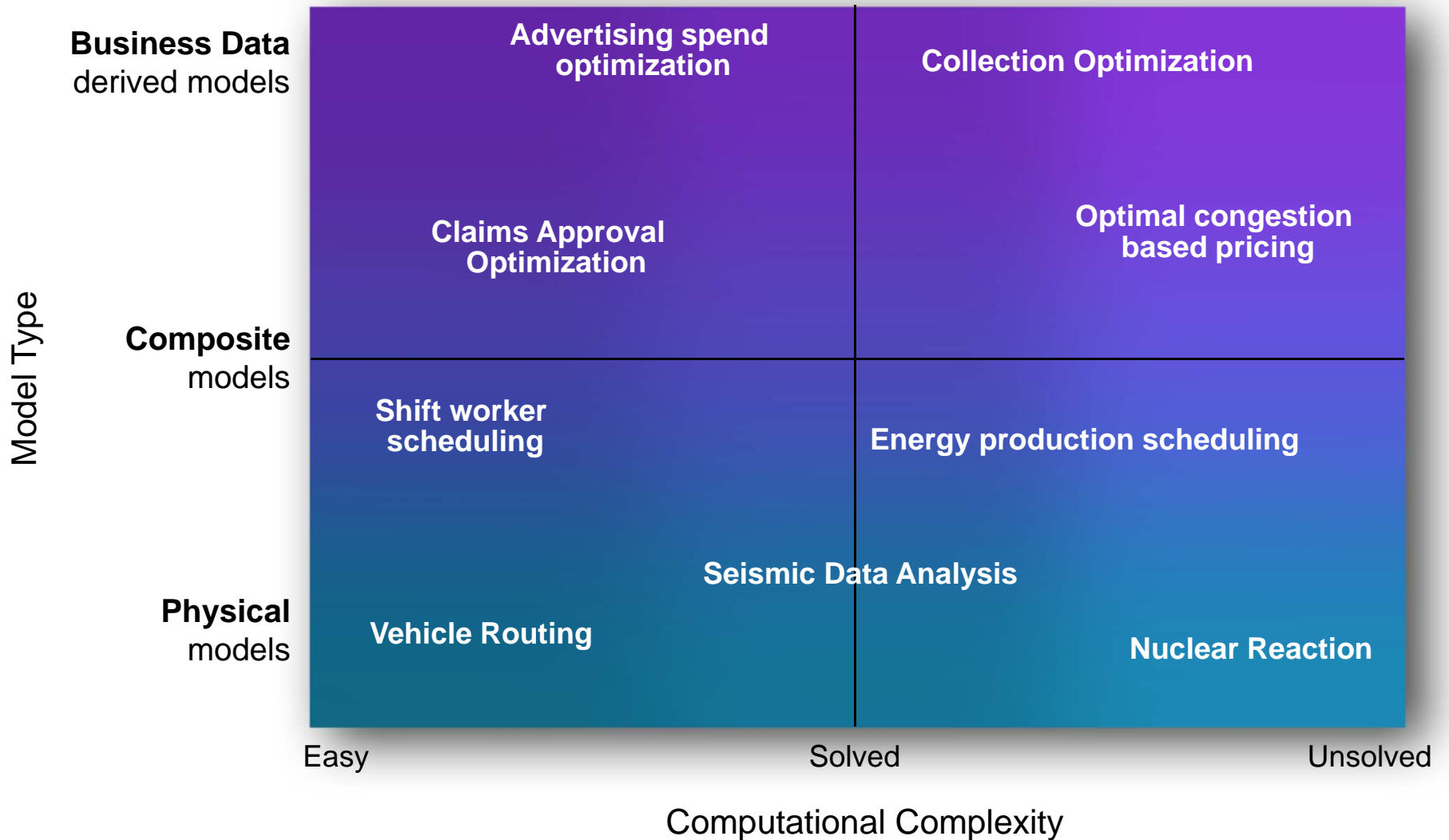

IBM Approach

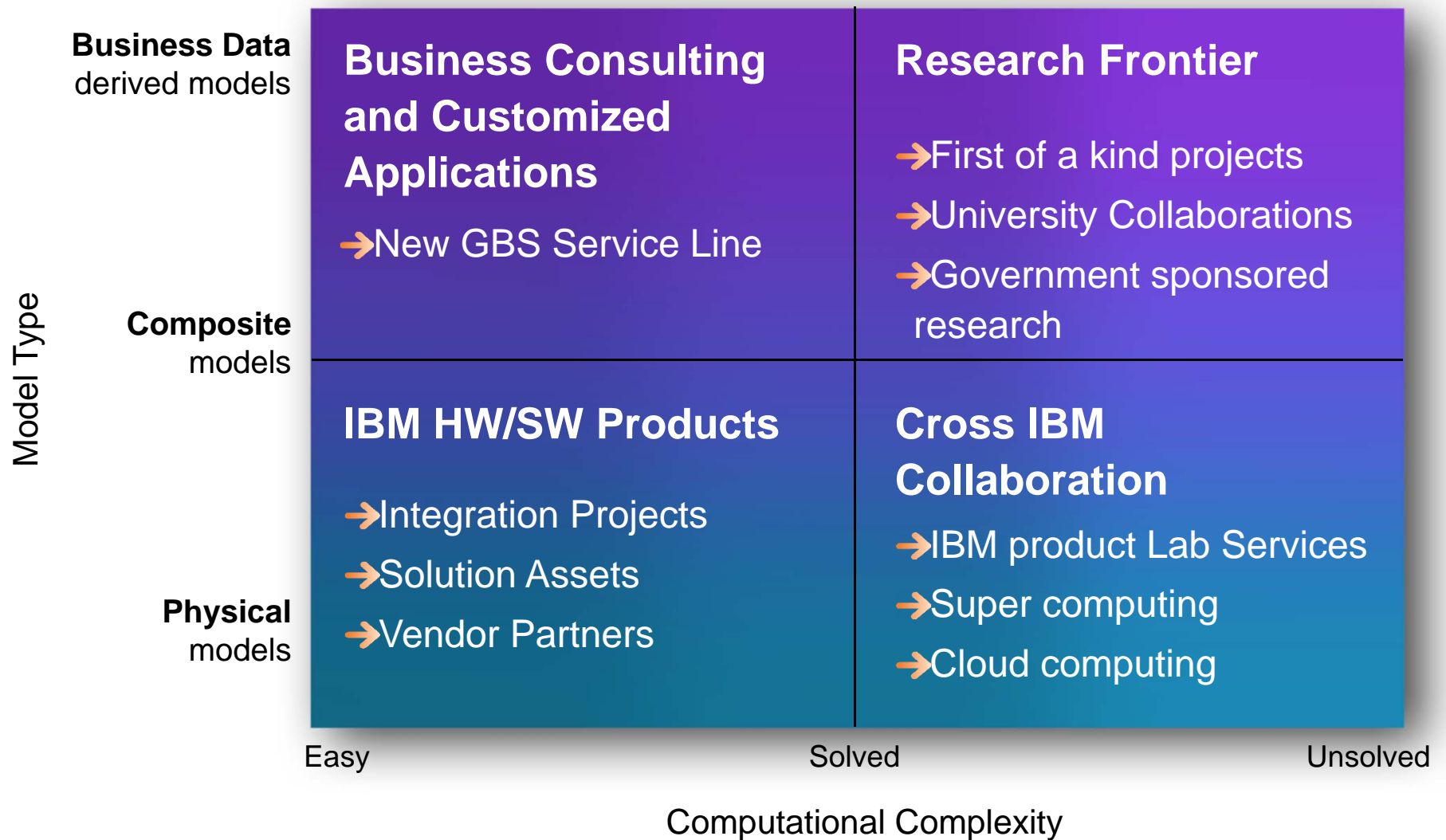

Analytics Landscape

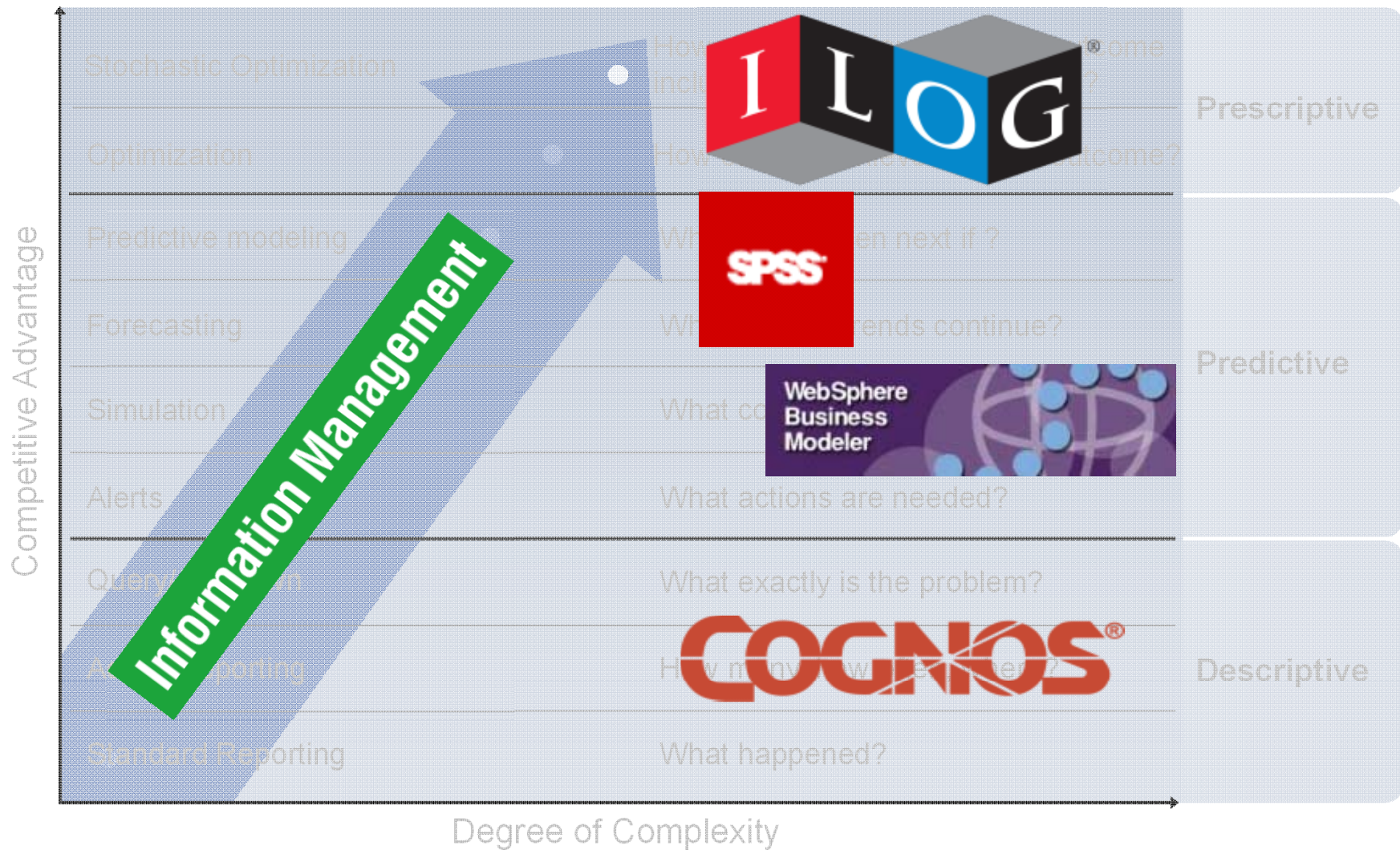

Based on: Competing on Analytics, Davenport and Harris, 2007

New Analytics Workload Optimized Systems

Custom Solutions

IBM Servers, Storage, Software and Services

A wide ranging portfolio for assembling a customized Analytics environment.



**Analytics solutions
for any client need**

IBM Smart Analytics System

Optimized Analytics Solutions

Powerful and flexible system with a growing spectrum of analytics capabilities to simplify deployment, optimize performance and.. speed better business results..

*Fast,
Flexible,
Affordable*



InfoSphere Balanced Warehouse with Solid State Disk storage

Optimized 1.8TB Datamart

...

IBM Smart Analytics Optimizer *Technology Preview*

Optimize existing Data systems

Integrates into your existing environment to optimize analytic query performance, without replicating data across the enterprise.

*Technology
preview
on
System z*



**Today's
News...**

Analytics workload optimized systems

Healthcare Analytics: Selected Activities and Opportunities

Clinical

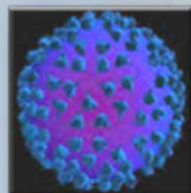

EuResists improves prediction of patient response to therapy to 76%



Timely alerts prevent sepsis



Mining huge collection of treatment and diagnosis data

Opportunities:

Comparative Effectiveness Research,
Detecting drug interactions,
Prognosis Prediction

Operational



Fraud and Abuse Management reduces improper payments by 40%.

Opportunities:

Forecasting
Workforce management



Scheduling

Policy/Strategy

Public health modeling



Opportunities:

Outcome-based reimbursement
Policy analysis

The Next Generation of Supply Chain Analytics Requires Cross Enterprise Data Aggregation

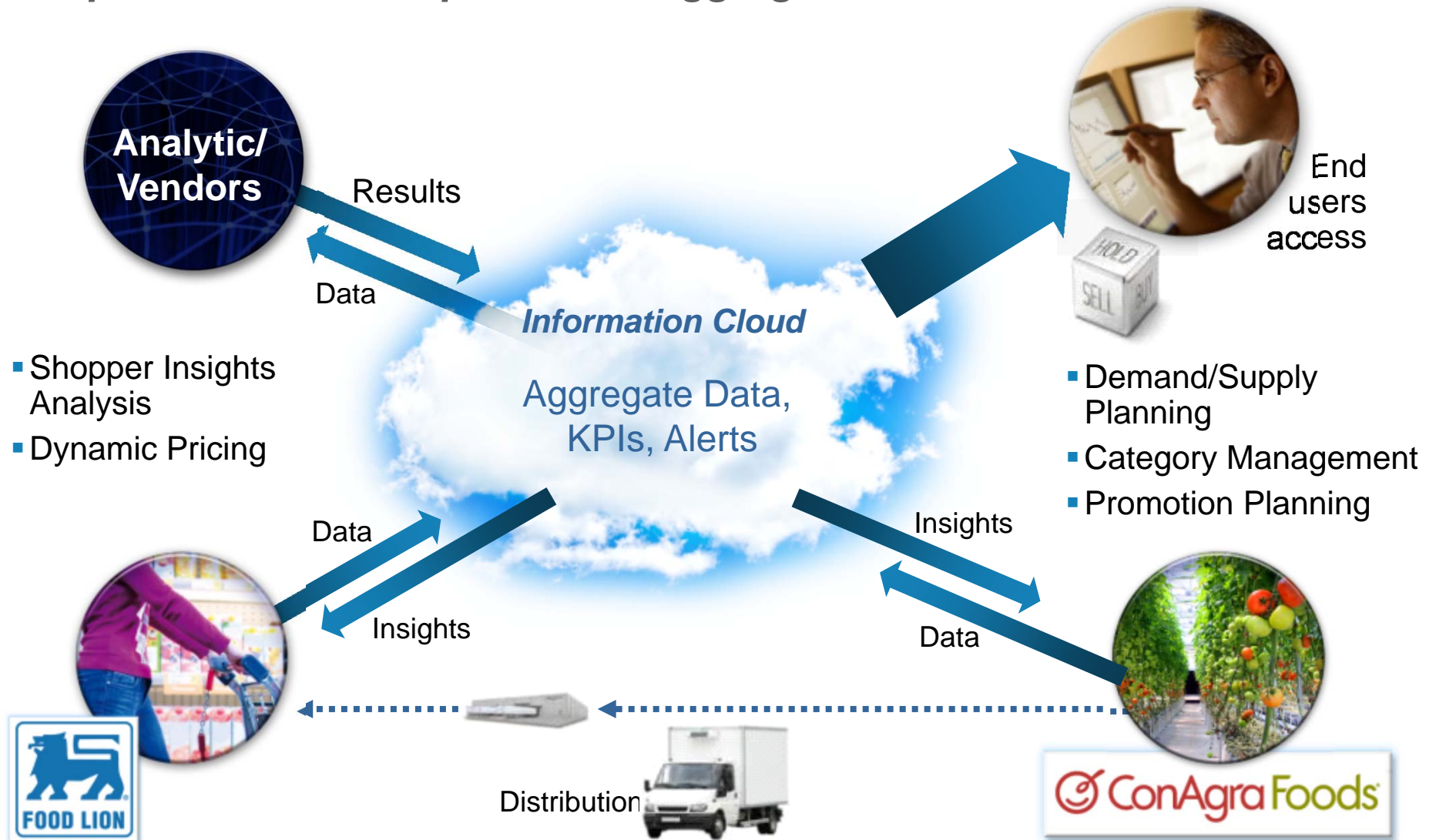

Prototyping Capabilities Needed to Model Systemic Risk

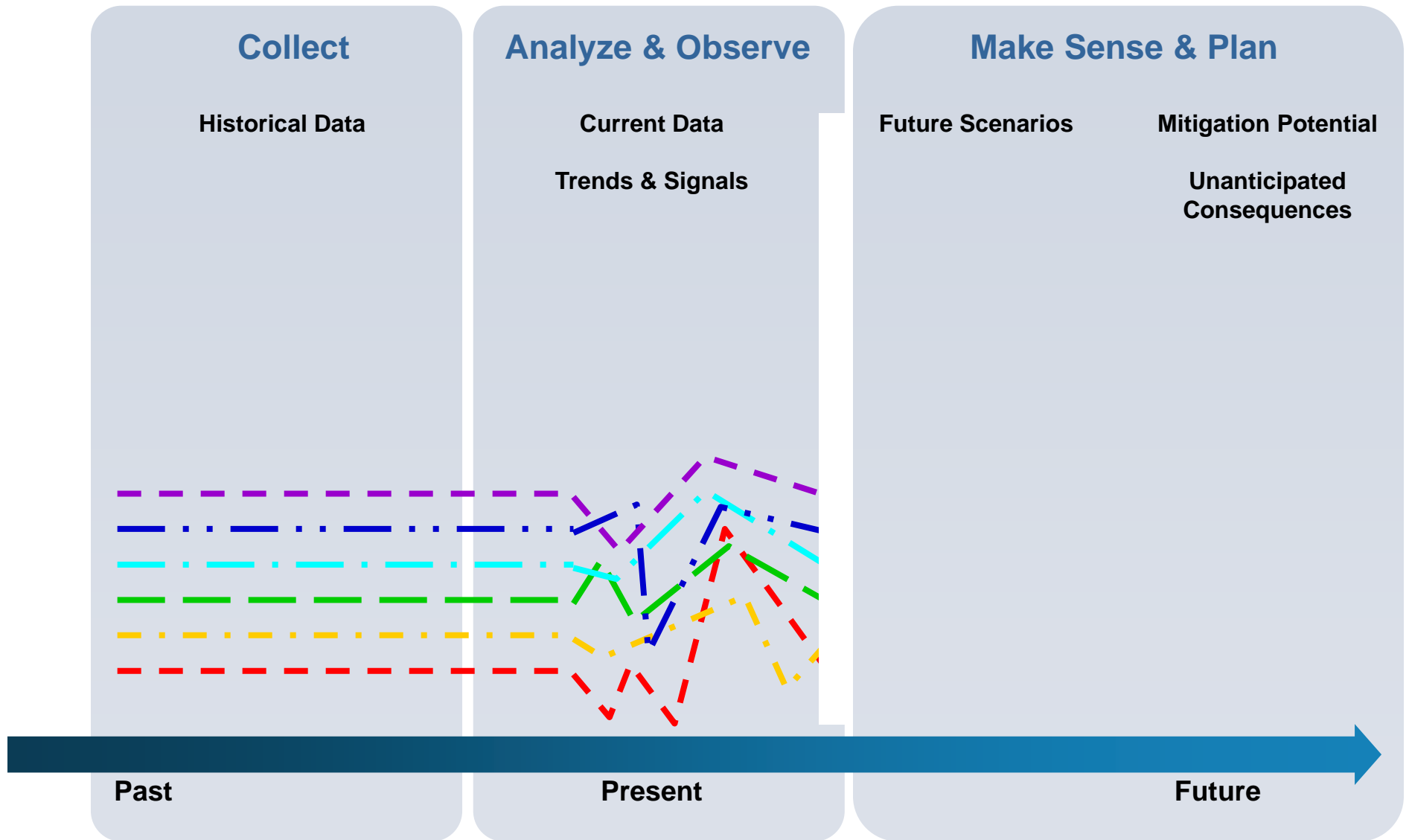

Prototyping Capabilities Needed to Model Systemic Risk

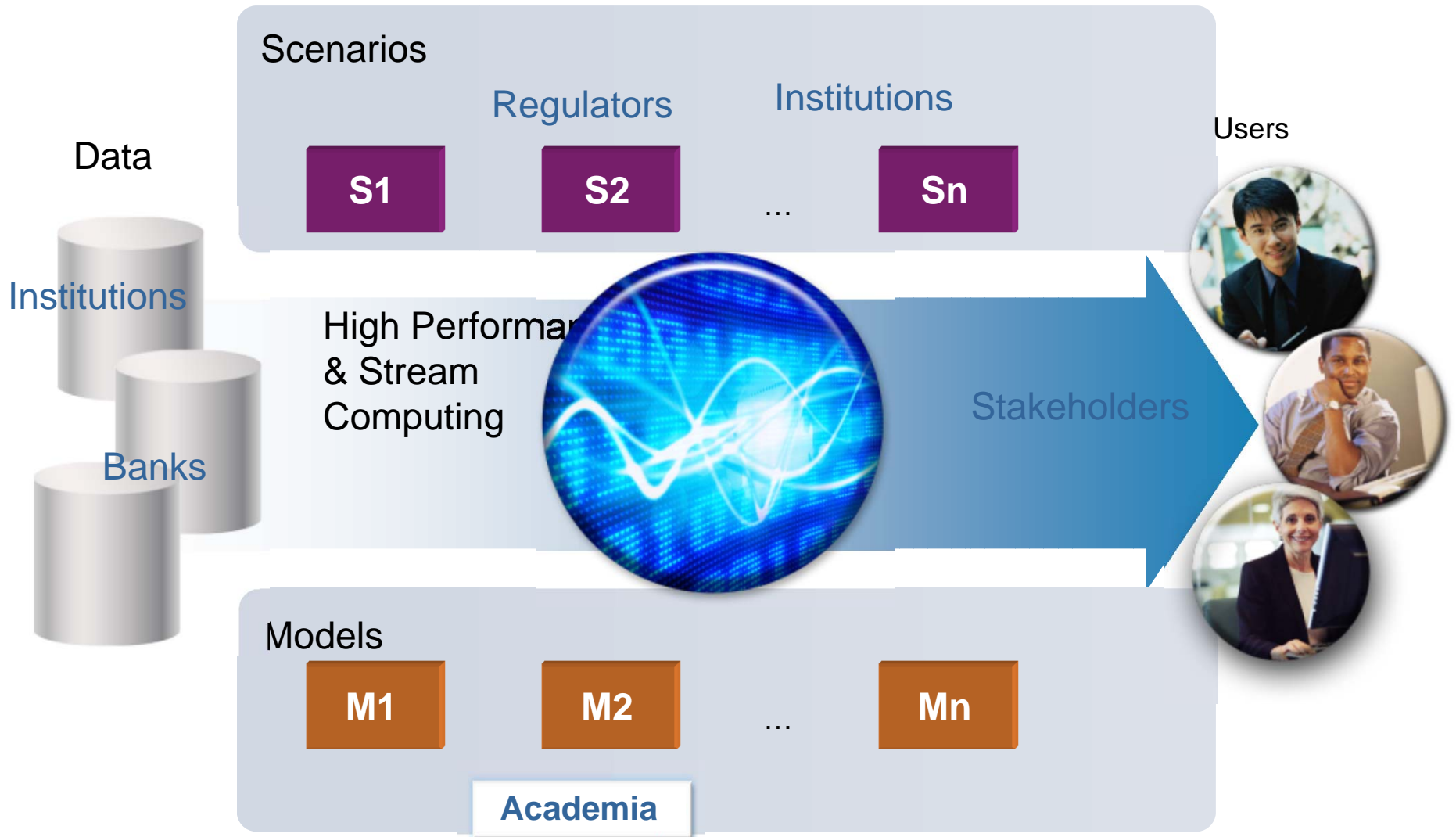

Research Frontiers

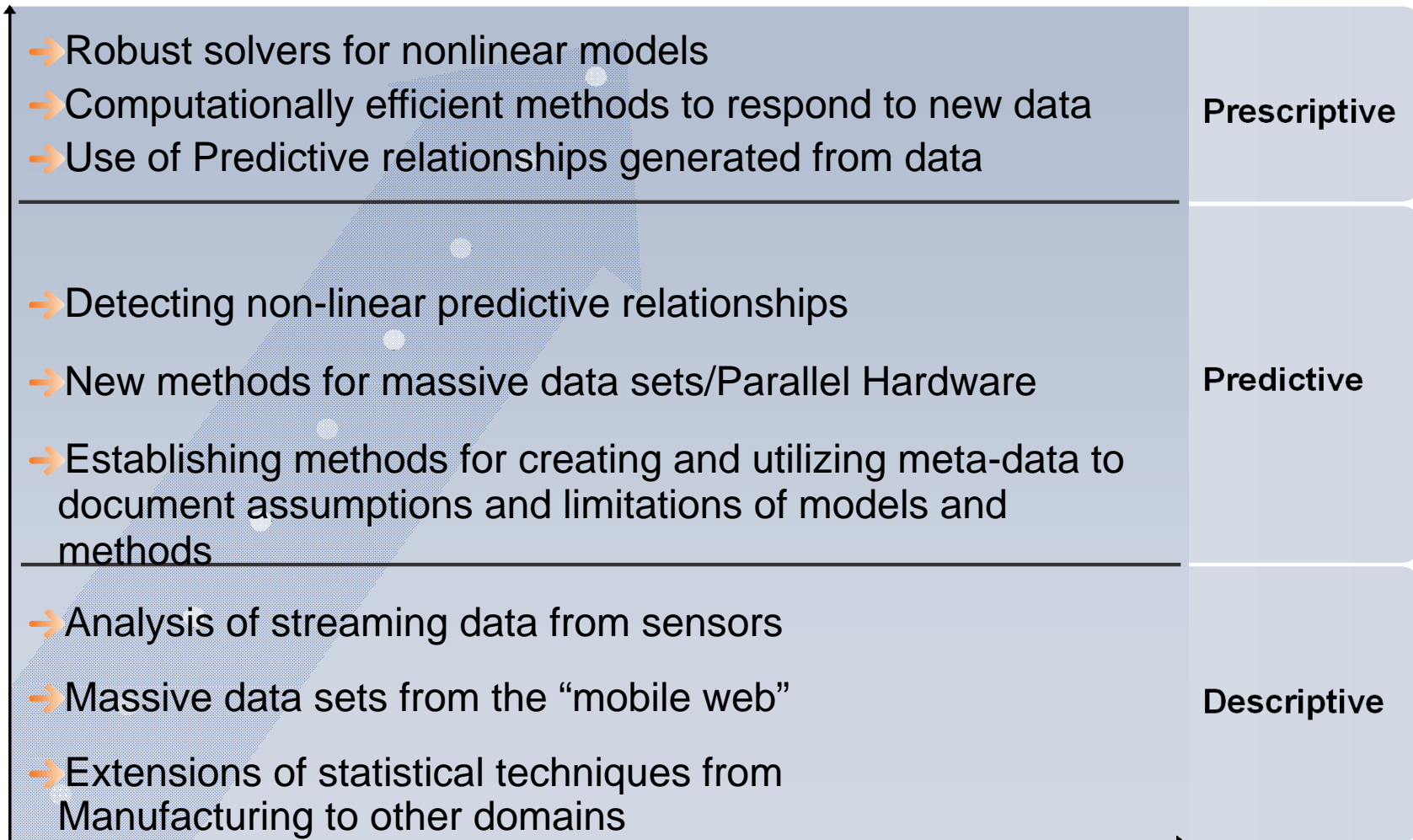

Tax Revenue Collection Optimization

Using Predicted relationships to Optimize Resource Allocation

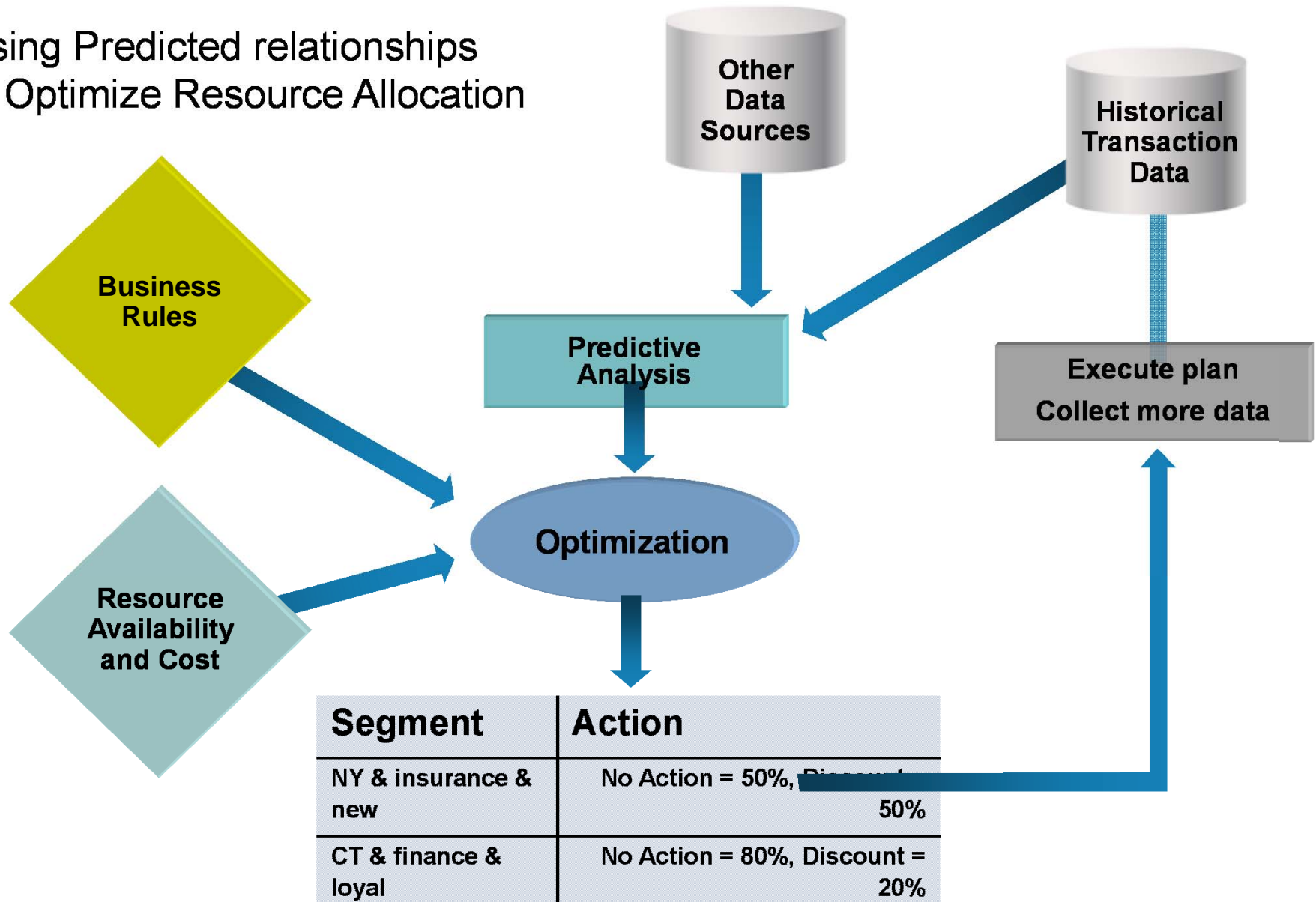

Summary

Advanced analytics extending from the domain of science & engineering to the world of business

- Fueled by the availability of data, computational power and the need to make better choices
- IBM is positioned for leadership in the new era of data-driven business management
- IBM's advanced analytics capability is a marketplace differentiator
- Our collaboration with clients is enabling discovery in new areas
- Significant research opportunity remains

