



# WebSphere MQ for z/OS as the messaging backbone for SOA, Web 2.0 and file transfer



# Trademarks

The following are trademarks of the International Business Machines Corporation in the United States, other countries, or both. For a complete list of IBM trademarks please visit [www.ibm.com/legal/copytrade.shtml](http://www.ibm.com/legal/copytrade.shtml)

CICS	IBM Logo	S/390
DB2	IMS	Tivoli
E-business logo	iSeries	VM/ESA
ESCON	MVS	VSE/ESA
eServer	OS/390	WebSphere
FICON	pSeries	z/OS
IBM	Rational	zSeries
Smart SOA	RS/6000	System z

Java and all Java-based trademarks are trademarks of Sun Microsystems, Inc. in the United States, other countries, or both.

Microsoft, Windows, Windows NT, and the Windows logo are trademarks of Microsoft Corporation in the United States, other countries, or both.

Microsoft trademark guidelines

Intel is a registered trademark of Intel Corporation in the United States and other countries.

UNIX is a registered trademark of The Open Group in the United States and other countries.

Linux is a registered trademark of Linus Torvalds in the United States, other countries, or both.

Other company, product, or service names may be trademarks or service marks of others.

# Agenda

- **The role of WebSphere MQ in SOA**
- **WebSphere MQ for z/OS V6 highlights**
- **What's new in WebSphere for z/OS MQ V7**
- **WebSphere MQ and the Web**
- **WebSphere MQ and Files**
- **Summary**

# IBM's Vision – SOA Messaging Backbone

- Addressing the full spectrum of transport requirements

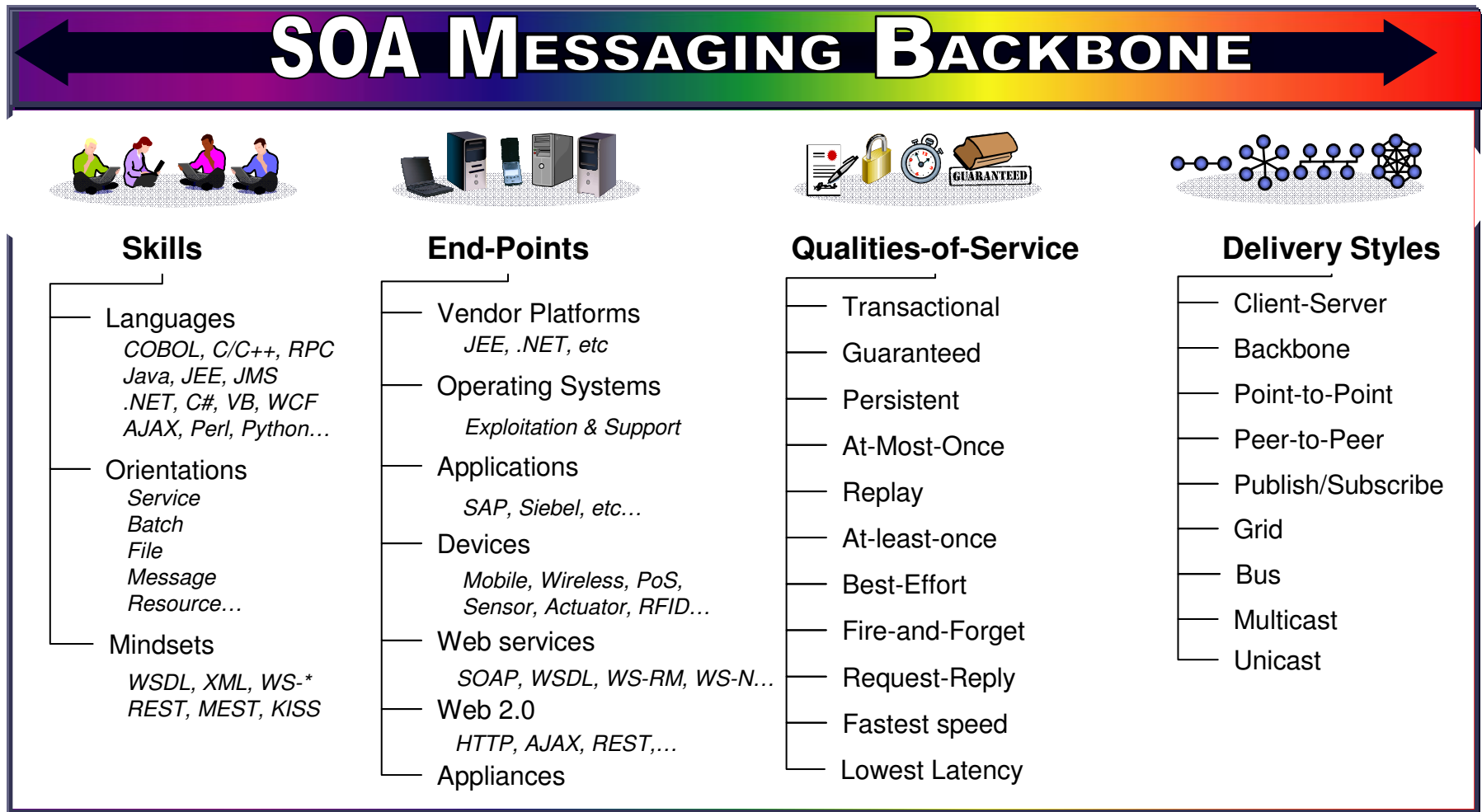

# Full support for transactional environments

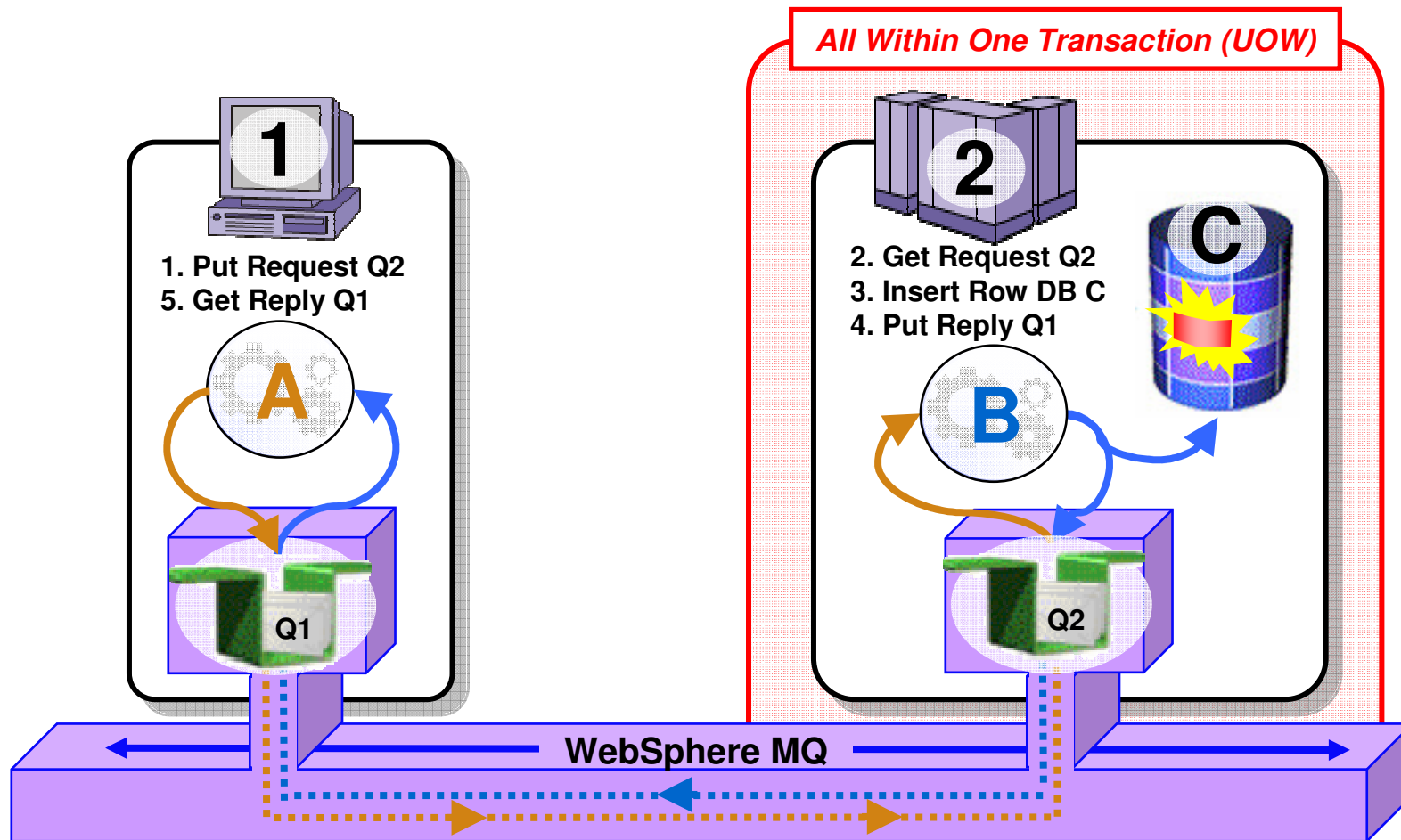

- Full support for CICS, IMS, WAS, DB2 SPs & Batch RSS
- Reliable Two-Phase commit involving other Resource Managers e.g. DB2

# Shared queues on z/OS

- Exploits Parallel Sysplex
- Automatic load balancing
- Scalable throughput
- Multiple processors can access the same queue
- Queue sharing groups
- VIPA support

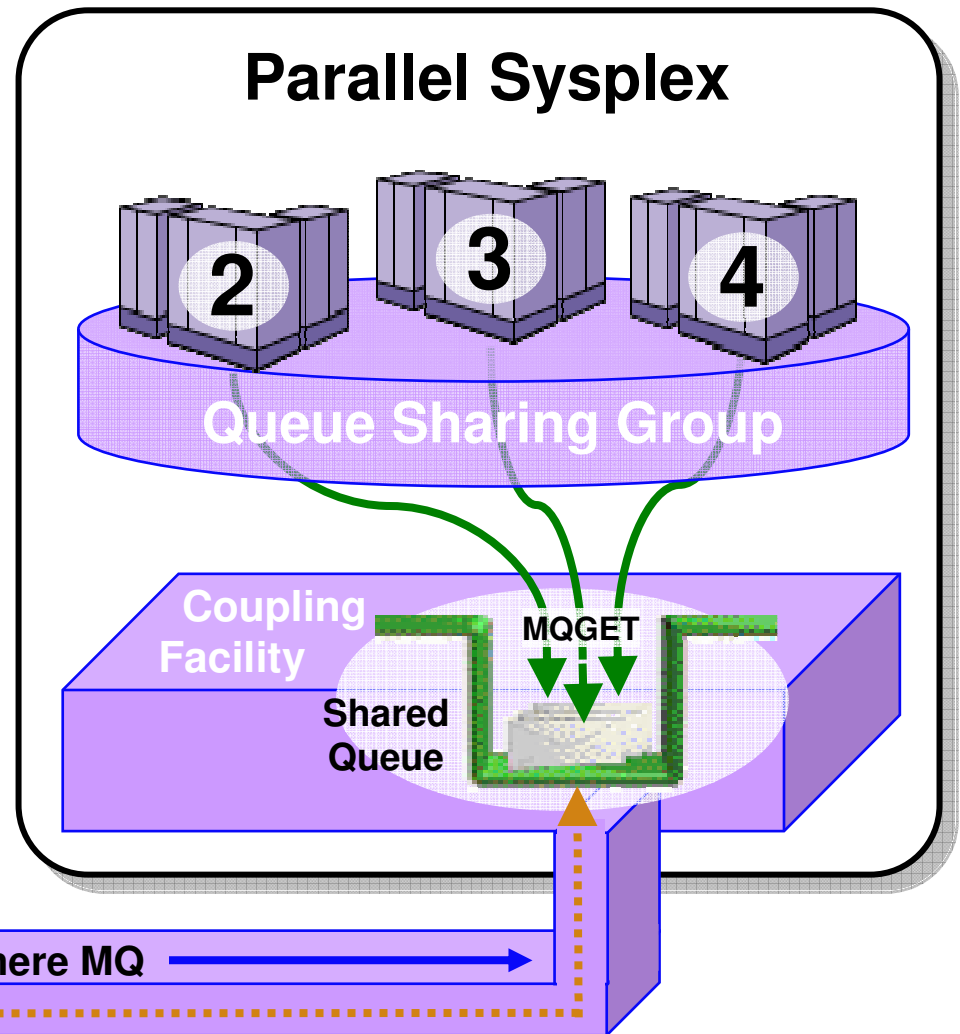
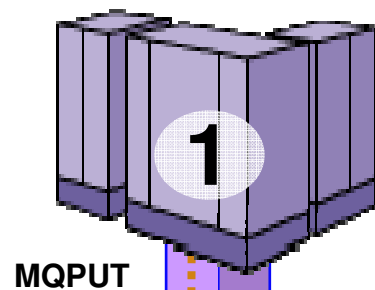

# Highly Available with Failover for z/OS

- **Failure isolation**
  - Automatic peer recovery for failing Servers, Applications or Queue Managers
- **In-flight MQPUTs and MQGETs are rolled back**
  - Since messages are not hosted in any Queue Manager there are no marooned messages
- **24 x 7 availability**
- **Leverages ARM (Automatic Restart Manager)**

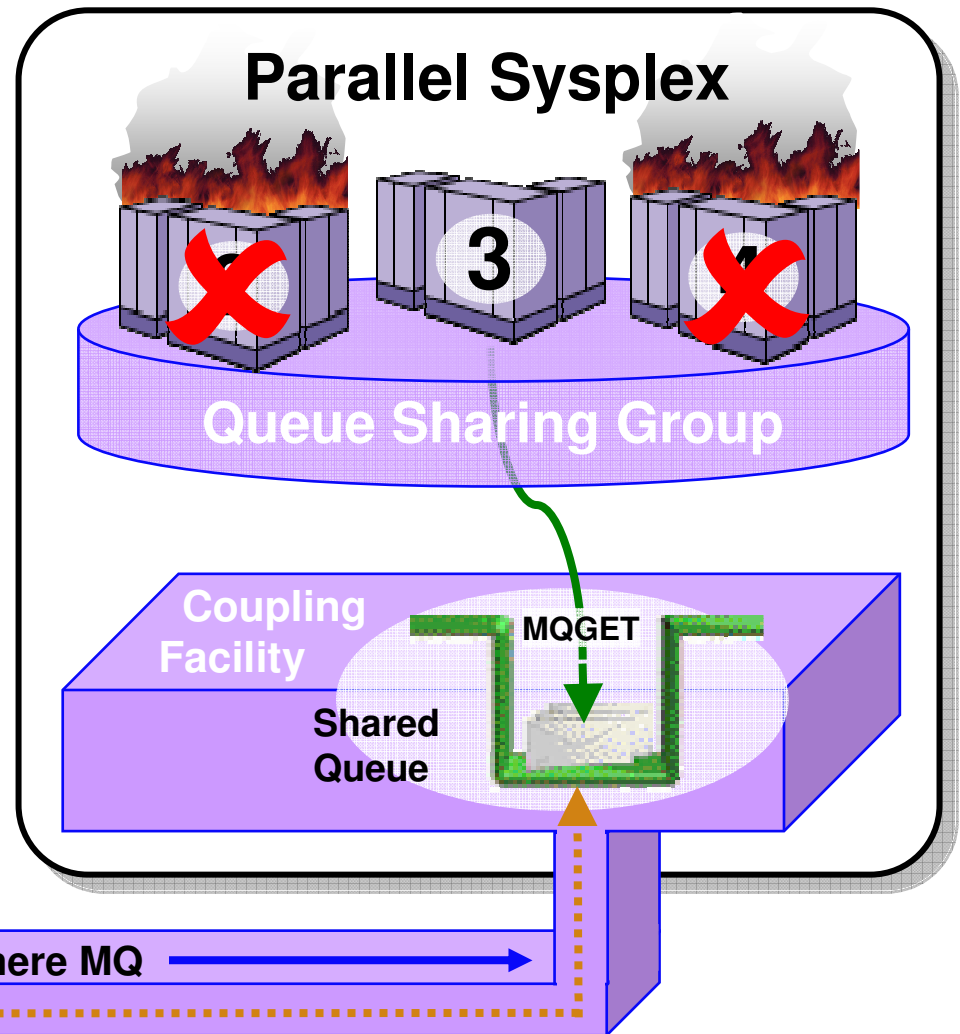
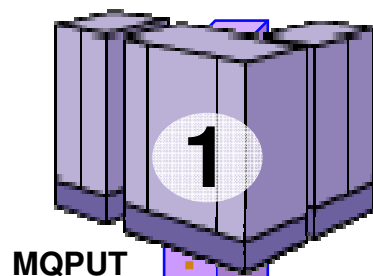



# Security

- **Security is #1 concern of CIOs**
  
- **Secure Sockets Layer (SSL)**
  - Provides channel-level security
  - WebSphere MQ V5.3 introduced SSL support
    - Uses the z/OS Cryptographic Services System SSL function
  
- **Security Server on z/OS (previously RACF)**
  - WebSphere MQ for z/OS has always provided close integration with RACF and 3<sup>rd</sup>-party alternatives
  - Security Server (RACF) can protect the resources that WebSphere MQ for z/OS owns and manages from access by unauthorized users
  
- **WebSphere MQ Extended Security Edition for z/OS**
  - Provides advanced security capabilities leveraging Tivoli security technology

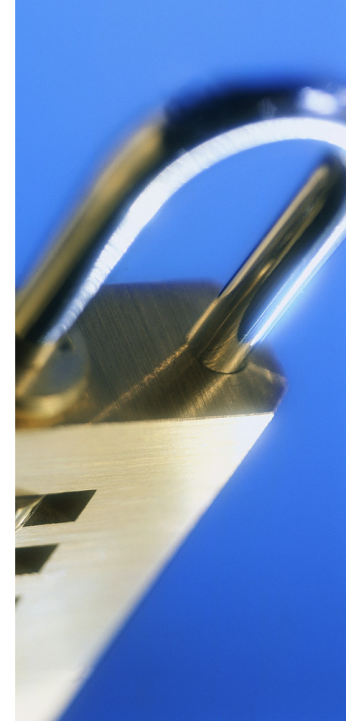



## Standards - JMS 1.1 and J2EE

- **JMS 1.1 is latest level of standard, and is required for J2EE compliance**
- **Joins pub/sub and point-to-point methods into a single set of methods**
  - Backwards-compatible
  - JMS applications can still use the older 1.02 APIs
- **WMQ JMS is always supported inside WAS and now also for WebLogic**
  - It is not the “embedded” provider for WAS6, but still (of course) can be used
- **V6 also includes MA0C Publish/Subscribe component on distributed platforms only**
  - Making it easier to use full JMS function without downloading or buying extras

# XMS

- **Common messaging API across IBM providers**
  - Transport neutral - WMQ, Real-Time, and WAS V6 Messaging
  - JMS-like API for other languages
  - Simplified Point-to-Point and Publish/Subscribe messaging
- **Decoupled administration**
  - XMS and JMS use the same administered Connection Factories and Destinations
- **XMS 1.2 for C/C++ available as SupportPac IA94**
  - Category 3 SupportPac
  - Initially for Windows, Linux, Solaris
- **XMS 1.2 for .NET available as SupportPac IA9H**
  - Now a Category 3 SupportPac
  - "Fully managed" code for WMQ, WAS Messaging and Real-Time clients
  - .NET support enables C#, VB .NET etc. languages
- **Inclusion with WMQ in future Fix Pack or Version**

## Improved capabilities for WMQ Clusters

- **New options make large clusters easier to handle**
  - Based on real customer scenarios
  - Providing greater flexibility in prioritising and assigning “weights” to the default round-robin algorithm
- **Can create backup networks that are automatically used when all prime servers are unavailable**
- **Can restrict the number of active outbound channels**
- **Can override the “always select local queue if it exists” rule**
- **Can ask for more work to be sent to more powerful servers**
- **No automatic feedback from servers; attributes could be adjusted by system monitors**

# Improved z/OS Monitoring, Management and Availability

- **Improved monitoring and problem determination**
  - Who is using the Qmgr
  - Additional status information
- **PCF support on z/OS**
  - V6 explorer can extend its administration capability to z/OS V6 Queue Managers
- **Improved Availability for z/OS**
  - 63KB message size limit for Shared Queue messages now removed
  - Dynamic recovery from Shared Queue Administration Structure failure
  - Non-shared message pagesets can now be up to 64GB in size
  - Dynamic addition and deletion of pagesets and buffer pools
  - Dynamic addition and deletion of buffers in a buffer pool
  - Dynamic addition of active log datasets
  - Pre-emptive pageset expansion
  - Dynamic setting of Distributed Queueing (CHIN) parameters
  - Multiple TCP/IP stack support
  - Multiple browsers for the CICS Bridge
  - SUSPEND/RESUME IMS Bridge commands
- **Improved support in CICS TS V3.2**
  - CICS-MQ Adapter, CICS-MQ Trigger Monitor, CICS-MQ Bridge integrated in CICS TS 3.2
  - Exploitation of CICS OTE, improved diagnostics and statistics

# IS02 Supportpac: Message Broker Admin Plug-in

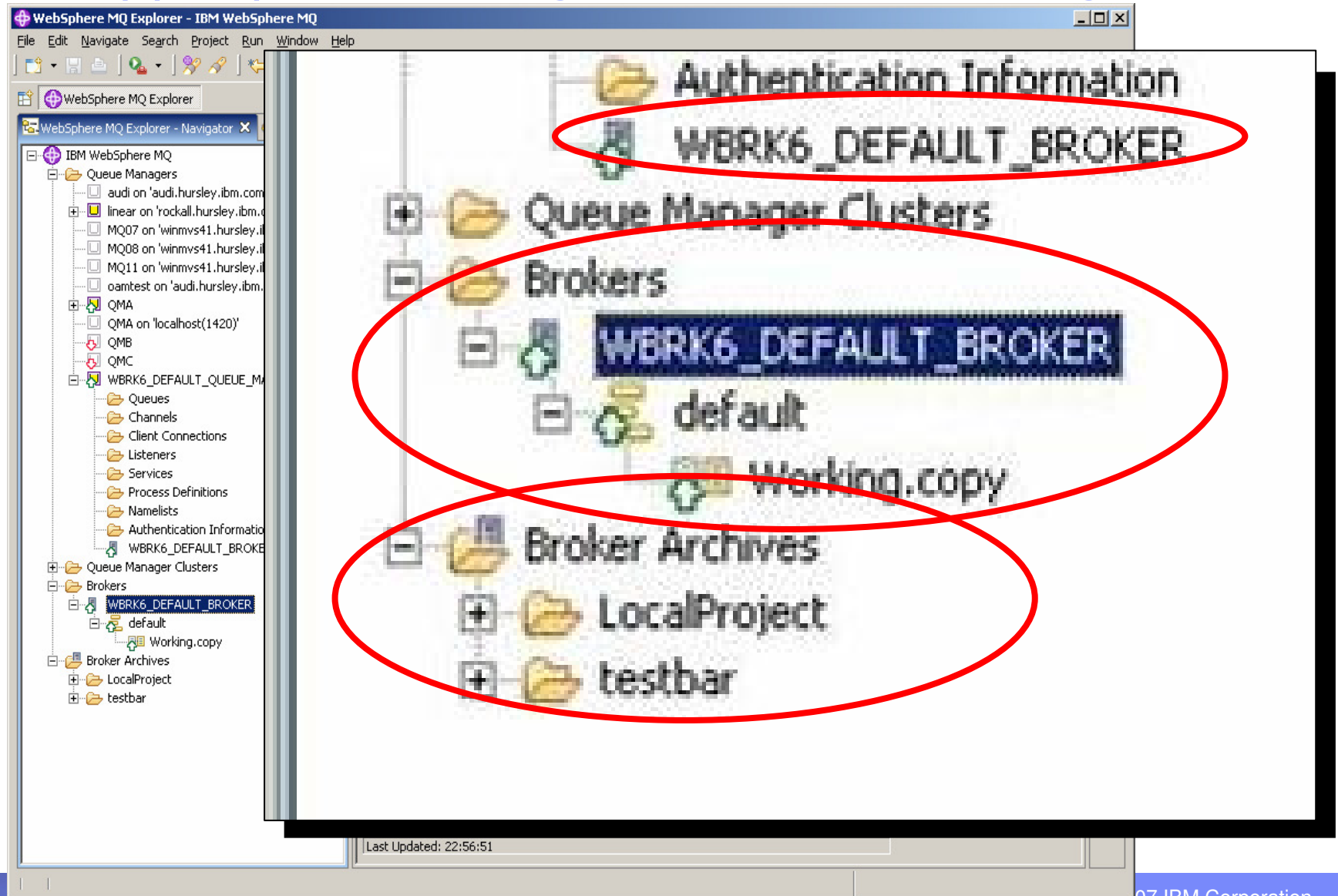

# WebSphere MQ V7:

*The Latest Evolution of IBM's SOA Messaging Backbone*

- *Reliable SOA*
  - Makes Web Services mission-critical
  - Web 2.0 ready!
- *Universal JMS*
  - The only messaging system that works as a JMS under “any” JEE Server
- *Non-JMS Messaging*
  - Non-Java environments (Microsoft, COBOL, RPG, C++)
- *Best-of-Breed Publish-Subscribe*
  - Highly scalable, highly functional.
- *Managed FTP*
  - New feature (coming in 4Q'08)

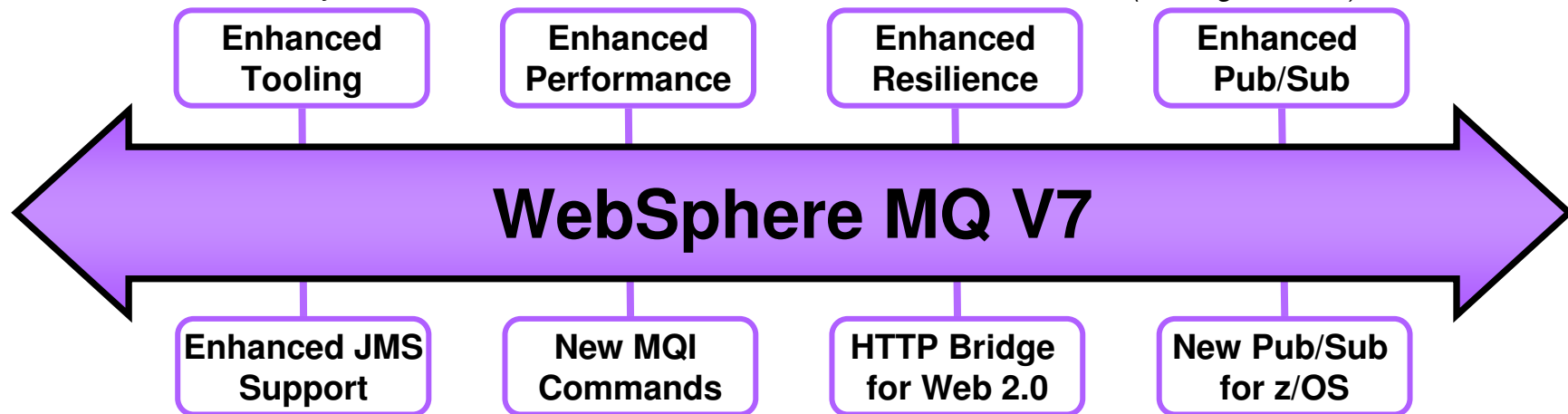

1. Premier ease-of-use for improved developer productivity
2. Turbo-charged performance and enhanced resilience
3. WebSphere MQ goes Web 2.0!
4. Publish-and-Subscribe support for z/OS

1.

# Enhancing Usability of IBM's SOA Messaging Backbone

## 1. Premier ease-of-use for improved developer productivity

- Graphical configuration of JMS and Publish-and-Subscribe

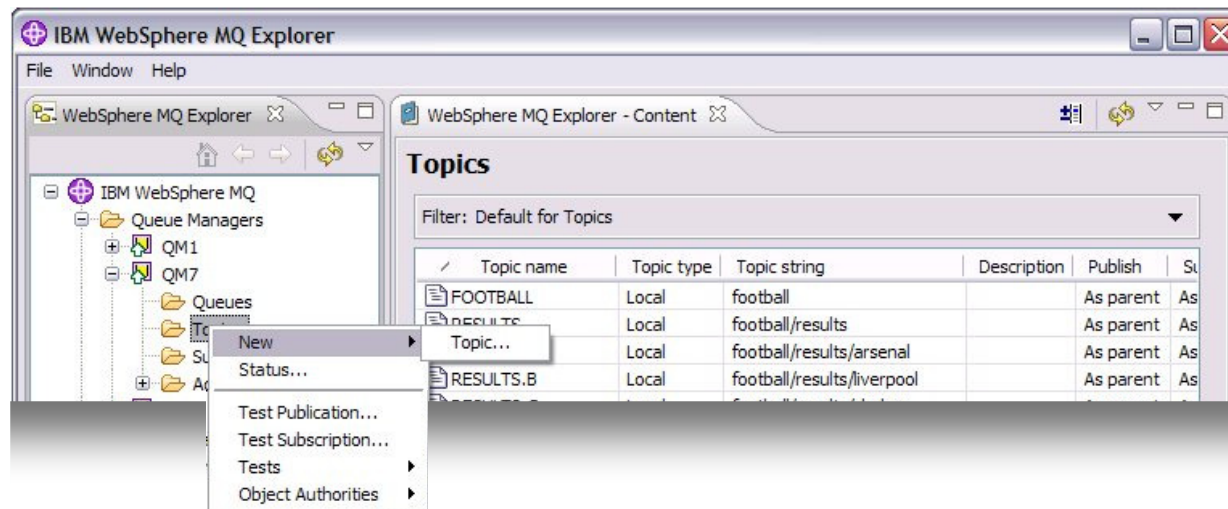

- New MQI verbs providing greater flexibility for

- Selecting messages for processing
- Adding custom properties to messages
- Automatically notifying applications when messages arrive



# MQI Enhancements - Message Properties

- **Arbitrary values associated with the message but not part of the body**
  - Like a user-extendable MQMD
  - Already part of JMS
- **New verbs including MQSETMP and MQINQMP**
  - Properties can be integers, strings, boolean, etc.
- **Easier to use than RFH2 folders**
  - Receiving apps do not see them unless they want
  - No need to parse and skip over message headers
- **Configuration options for compatibility**
  - Queue and channel attributes define behaviour
  - Defaults will create RFH2 folders
- **Permits explicit statement of relationships between messages**
  - eg Message X is a **REPLY** to Message Y
  - Messages referred to by handles

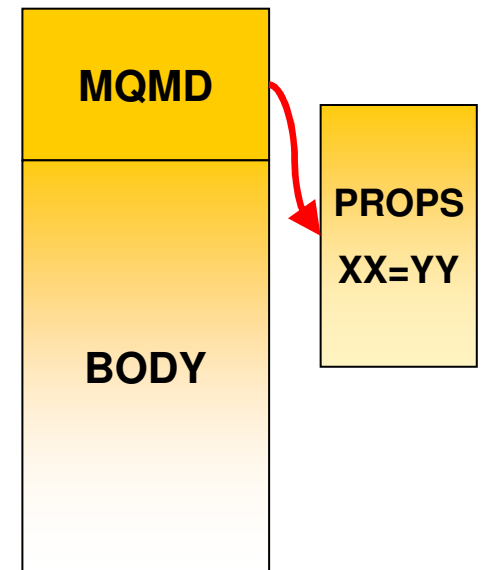

## Other MQI Enhancements

- **Asynchronous Message Reception**
  - New verb **MQCB** defines a callback function
  - Automatically Invoked when a message arrives
  - No need for MQGET(WAIT) or MQGET(SIGNAL)
  - A thread can receive messages from multiple queues
  - New verb **MQCTL** to start and stop message delivery to callback
- **Selectors**
  - Use a SQL92 clause to select messages by properties including MQMD fields
  - Can be specified on MQOPEN, MQCB for filtering messages
  - Selection is done inside queue manager
  - Not looking inside message body
    - Message Broker still required for content filtering
- **Cooperative Browsing and Message Tokens**
  - Efficient interface for applications reading from the same queue
  - Example: "master" program browses a queue telling "slaves" which message to work with, based on elements within the message
  - No races – messages locked but available to any cooperating process

# WMQ Explorer Enhancements

- **Sets**
  - Queue Managers can be partitioned into sets within the Navigator
  - For example "Test", "Production"
- **Security Configuration**
  - Easy to define channel exits, userid/password configurations
  - Configured for each queue manager or for all queue managers in a set
  - Password manager included
  - Still recommend security exit or service for authentication at the server
- **Tighter JMS integration**
  - Creating an queue/topic can define a JMS destination at the same time
- **Message browser configuration**
  - Number, size of messages
- **Plug-in Migration**
  - Explorer now based on Eclipse 3.3 – compatibility not guaranteed
  - Major change is availability of supported PCF classes
- **Using MQ Explorer with MQ for z/OS**
  - you can use the MQ Explorer, which runs on the Windows and Linux on x86 platforms, to manage the z/OS parts of your WebSphere MQ network without having to buy the Client Attach Feature

# Enhancing Usability of IBM's SOA Messaging Backbone

## 1. Premier ease-of-use for improved developer productivity

- Heart-beat monitoring of client connections
  - To help increase messaging availability
- Pre-emptive delivery of messages for increased throughput
  - A.k.a Message Read-Ahead
- New Quality-of-Service that avoids waiting for confirmation of delivery – enables “receipts” to be received later
  - Can help increase application throughput
  - A.k.a Asynchronous consume

# Client Enhancements

- **Client Performance**
  - Traditional WMQ non-persistent messages more reliable than some need
  - "Read Ahead" for Receiving Messages/Publications
  - "Asynchronous Put" for Sending/Publishing Messages
- **Client Connection Management**
  - Shared Client Conversations
  - Implementation also gives us more heartbeat opportunities
    - Faster failure notification for clients
  - Client Connections
    - Automatic workload distribution via CCDT
    - Control number of connected clients at a queue manager
  - Free connections to z/OS for administration programs like WMQ Explorer
    - Limited number of clients permitted by V7 license without CAF

# Enhancing Performance of IBM's SOA Messaging Backbone

## 2. Turbo-charged performance and enhanced resilience

- Enhanced publish-and-subscribe performance
  - Increased throughput by up to 20%\* (Distributed)
  - New publish-and-Subscribe support added in this release (z/OS)
  
- Enhanced JMS performance
  - Increasing JMS selectors by up to 250%\* (Distributed)
  - Increasing JMS listener throughput by up to 45%\* (Distributed)
  - Increasing JMS listener throughput by up to 220%\* (z/OS)
  
- Enhanced Clients performance
  - Increased throughout of non-persistent messaging by up to 300%\* (Distributed)

Preliminary results observed on pre-release level code.  
For the latest performance information please click on  
*Performance Reports* at [www.ibm.com/webspheremq/support](http://www.ibm.com/webspheremq/support)

## WMQ Performance

Moving more JMS function into the MQI allows more function to run in compiled code

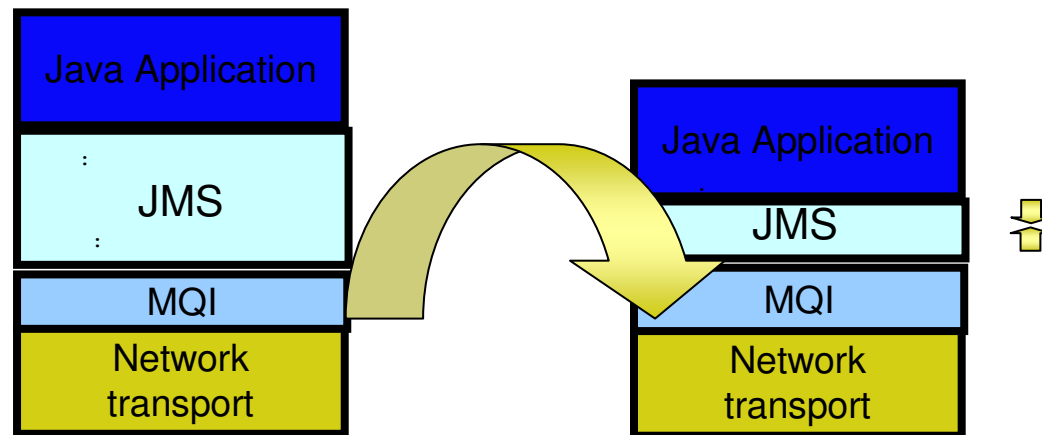

- **Persistent pub/sub throughput increased up to 60%**
- **Non-persistent client throughput increased up to 300%**
- **JMS Selector rates improved up to 250%**
- **Message Listener (MDB) throughput improved up to 45%**
  - Latency also improved
- **Measurements taken from pre-release code ; performance reports will be published as usual on SupportPac site**





# Enhancing Web 2.0 Connectivity for IBM's SOA Messaging Backbone

## 3. WebSphere MQ goes Web 2.0!

- Helps enrich Web 2.0 applications with real business data
  - Distributed and z/OS platforms
- Developer needs no MQ skills
  - Uses Ajax and simple RESTful interface to access data by URIs
- Helps simplify deployment and maintenance of large scale distributed applications
  - Enables simple access to MQ without need to install MQ clients

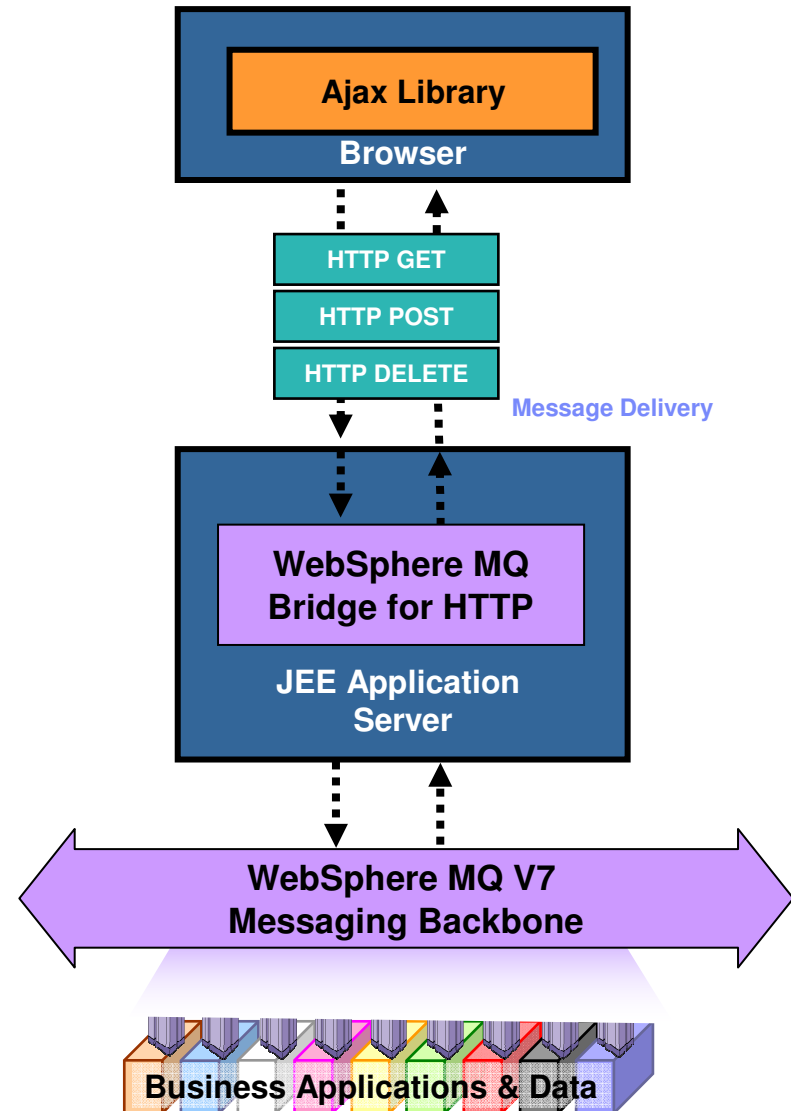

# WebSphere MQ Bridge for HTTP - Architectural Overview

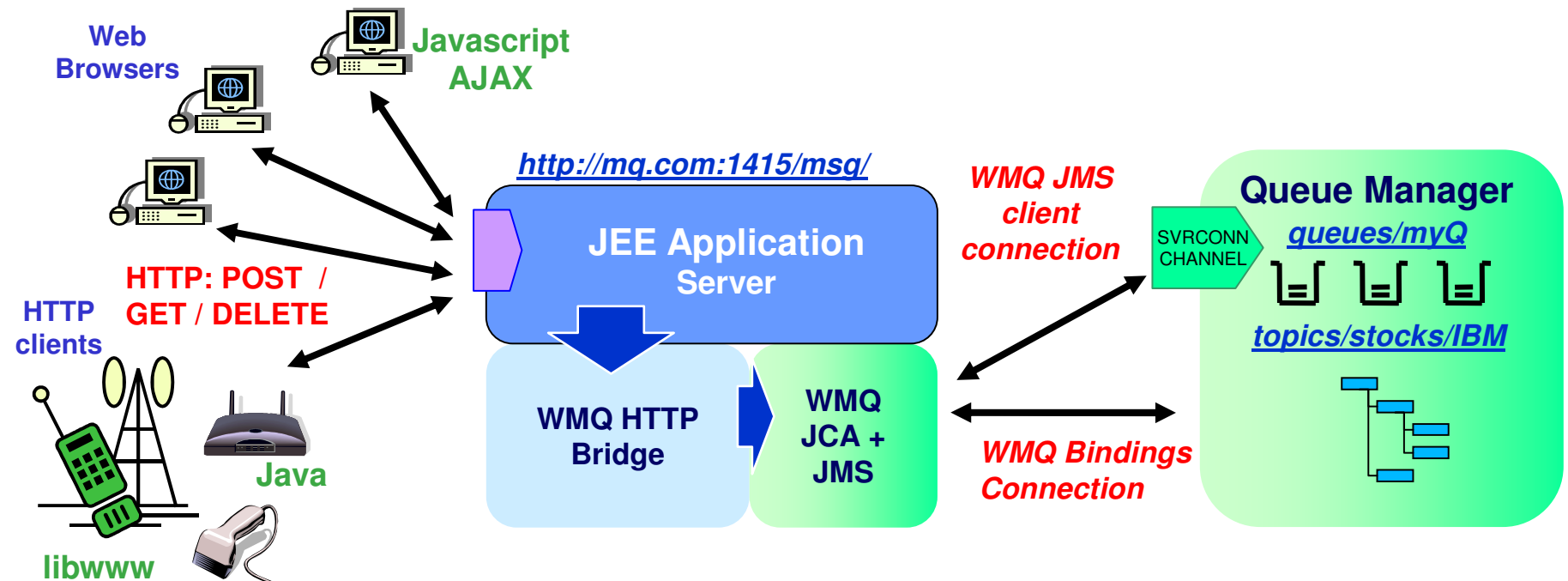

- Key features of the WebSphere MQ Bridge for HTTP -
  - Maps URIs to queues and topics
  - Enables MQPUT and MQGET from
    - Web Browser
    - Lightweight client
- Alternative non-servlet implementation available as MA94

## HTTP-MQI Verb / Resource Mapping

- **Define URI to identify queue (or topic)**
- **Modelled on REST principles**
  - Simple translation of HTTP to MQI
- **Message Format:**
  - Header fields (MQMD) conveyed in HTTP headers
  - Body is passed in HTTP entity body
  - Message type is conveyed in HTTP Content-Type
    - “text/plain” or “text/html” equate to WMQ string messages (MQFMT\_STRING)
    - All other media types map to WMQ binary messages (MQFMT\_NONE)

		HTTP verb mapping			
Resource	Sample URIs	GET	POST	PUT	DELETE
Messages	<a href="http://host/msg/queue/qname/">http://host/msg/queue/qname/</a> <a href="http://host/msg/topic/topic_path/">http://host/msg/topic/topic_path/</a>	MQGET w. browse	MQPUT	-	MQGET

# Enabling Flexible Delivery on z/OS for IBM's SOA Messaging Backbone

## 4. Publish-and-Subscribe for z/OS

- Dynamic and flexible way of determining where messages are sent
- Helps reduce the cost, time and skills involved when changes are required
- Helps define new paths of information flow in an ad hoc manner

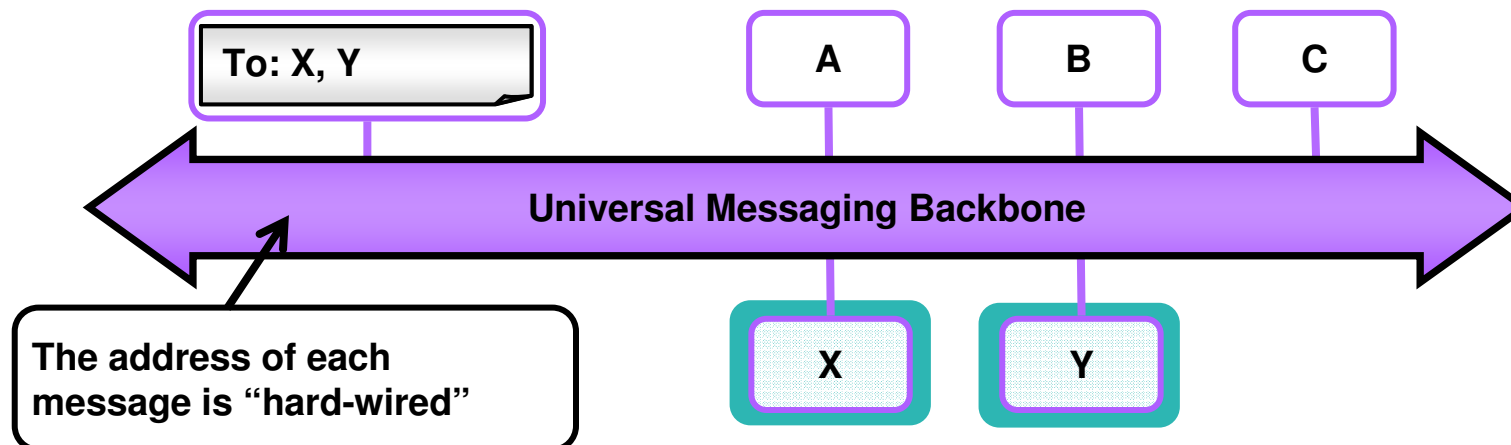

# Enabling Flexible Delivery on z/OS for IBM's SOA Messaging Backbone

## 4. Publish-and-Subscribe for z/OS

- Dynamic and flexible way of determining where messages are sent
- Helps reduce the cost, time and skills involved when changes are required
- Helps define new paths of information flow in an ad hoc manner

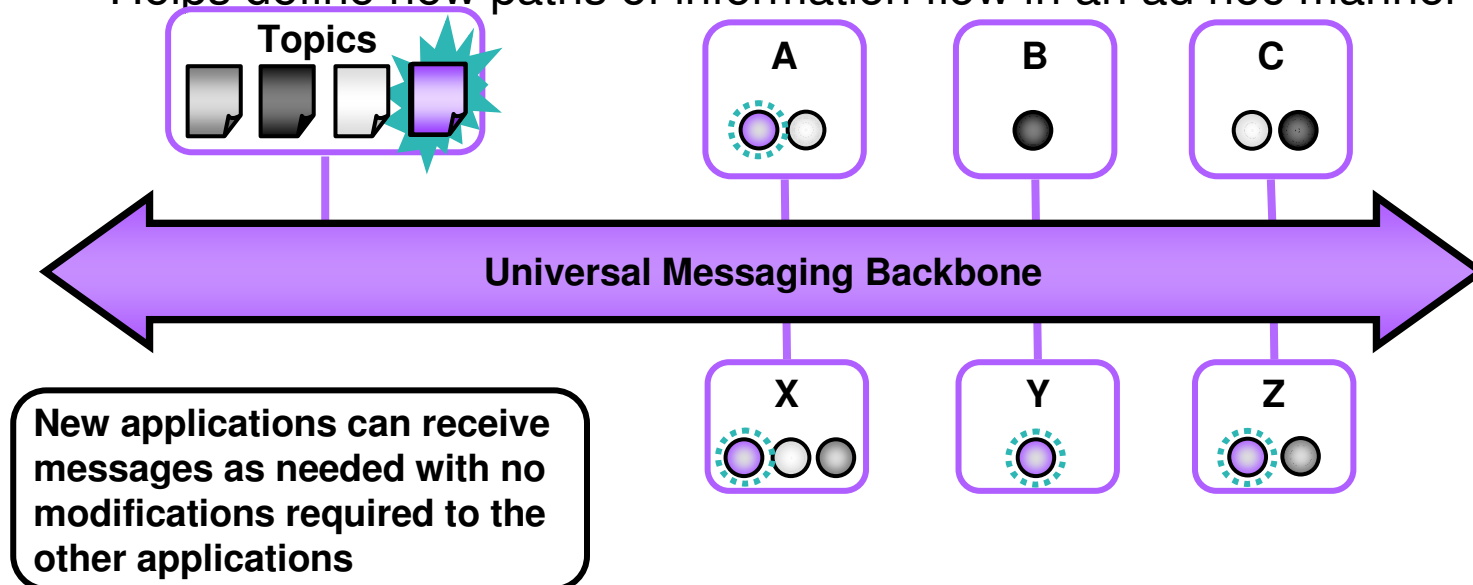

## Publish/Subscribe is available for the first time on z/OS

- **A natural part of the JMS API**
  - Combines both Publish/Subscribe and Point-to-Point patterns
  - Now also a natural part of the native MQI
- **Point-to-point asynchronous messaging decouples applications**
  - But still implies a one-one relationship between sender and receiver
- **Publish/subscribe is a further stage of decoupling**
  - Sender has no direct knowledge of how many (if any) apps will see a message
  - Link between applications is a **Topic**, not a **Queue**
- **WMQ V6 (Distributed) included a Publish/Subscribe broker (formerly MA0C)**
  - Compatibility mode available in V7
- **Implementation substantially improved with V7**

# Publish/Subscribe in the WMQ Explorer

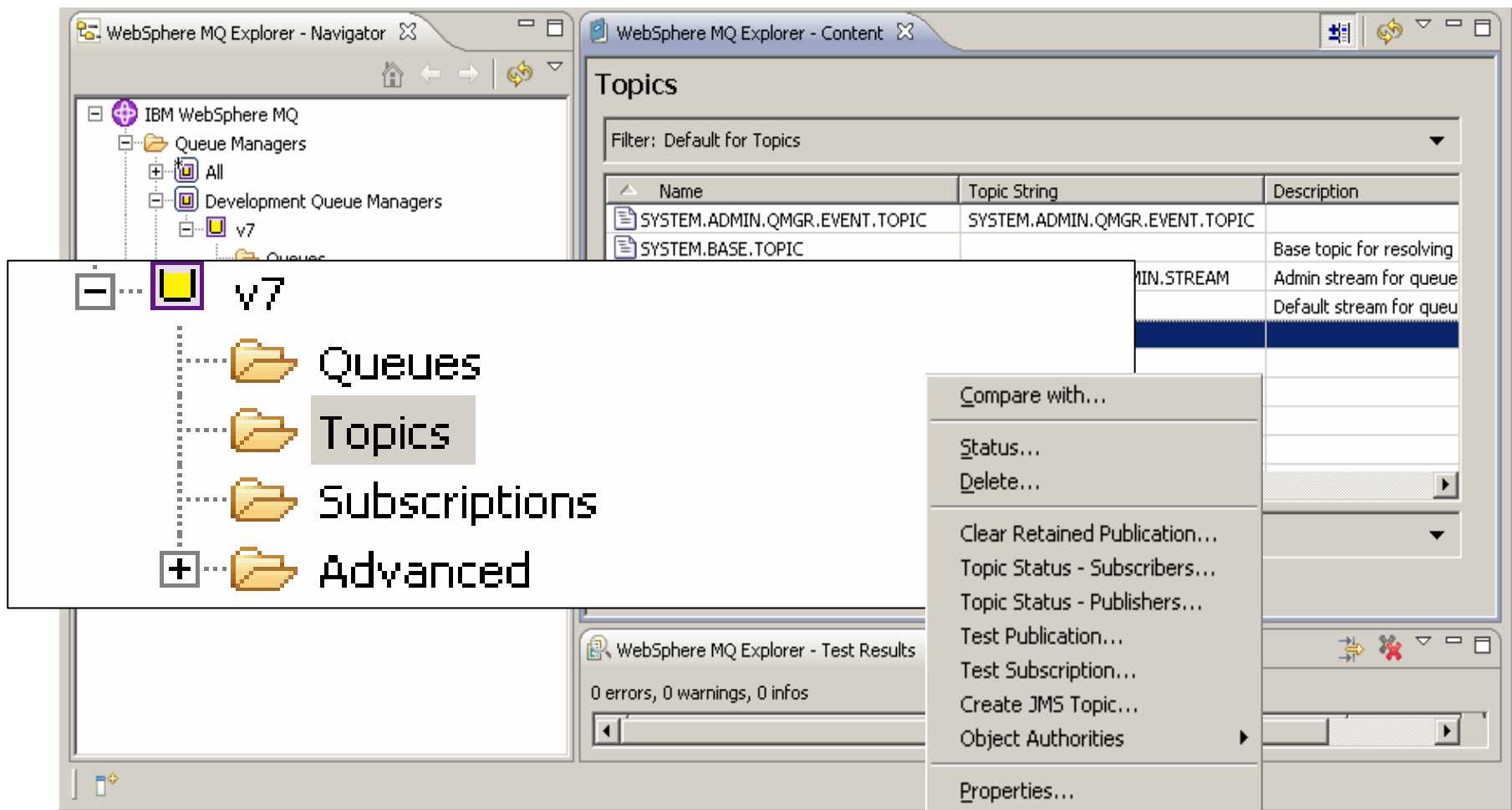



# Publish/Subscribe Topologies

- **WMQ V6 publish/subscribe networks based on hierarchies**
  - All brokers linked in parent/child tree
- **WMB publish/subscribe networks based on hierarchies of collectives**
  - All systems in a collective are connected to each other (mesh)
  - Also has "clones"
- **New product built on hierarchies and clusters**
  - With interoperability to other pub/sub systems through hierarchies
- **Clusters are built on existing WMQ cluster technology**
  - Cluster can be defined independently of any existing cluster used for queuing
  - Behaves in a similar way to WMB collective
- **Design gives**
  - Scalability
  - Availability
  - Ease of administration

# Publish/Subscribe Application Programming

- **Cannot significantly change the JMS API**
  - But we want some of its facilities more easily available in the MQI
  - To improve MQI programming and improve (make thinner) the JMS layer
  - JMS implementation exploits new MQI functions
- **New verb for subscribing**
  - So you do not need to build RFH or RFH2 headers in the application
  - **MQSUB** registers a subscription
    - Includes information about where messages will be read from
    - Do not need to specify a queue – can be automatically assigned
  - Retained publications delivered immediately after subscribing
- **New options on existing verbs**
  - MQOPEN to get access to a topic
  - MQCLOSE deregisters a subscription
  - MQPUT, MQGET to publish and to receive publications
- **Sample programs included to demonstrate use**

# Queue Manager Sets

The screenshot shows the IBM WebSphere MQ Explorer interface. On the left, a tree view displays the hierarchy of Queue Managers. A pop-up window is overlaid on the tree, showing a detailed view of the 'Queue Managers' folder. The 'Development Queue Managers' set is highlighted with a blue dashed border. The right pane shows the 'Queue Managers Set Development Queue Managers [manual set]' with a table of queue manager details.

Queue manager name	Command level	Queue manager status	Platform	Queue-sharing group
qz	700	Running	Unix	

# MQ and Web Services

# WebSphere MQ makes Reliable Web services possible

- **Many developers today connect Web services using HTTP**
  - May seem “good-enough” to start with but doesn’t address reliability and auditability and locks-up the services whilst they are communicating

## WebSphere MQ provides a layer of messaging services to help make SOAP exchanges:

- ✓ *More reliable than those sent over HTTP*
- ✓ *Transactional – allowing service resources to be updated atomically so they retain integrity and failures can be recovered and retried*
- ✓ *Arrive in the same order as they were sent*
- ✓ *Decoupled in time – so that they can handle other requests whilst waiting for responses*
- ✓ *Buffered so that SOAP requests can be throttled for batch-style Web services*
- ✓ *Clustered so that SOAP requests can be processed in parallel by multiple service providers*
- ✓ *Easily integrated with applications that are not enabled for SOA*
- ✓ *More auditable*

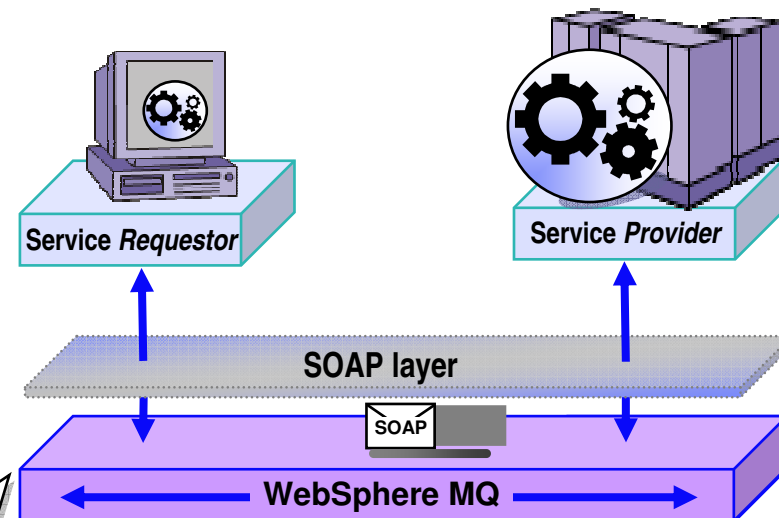

- **Web services that interoperate with HTTP will also work with WebSphere MQ**
- **Sender and listener support for**
  - Axis host Web services environment
  - .NET host Web services environment

## Standards - WS-\* and SOAP / WMQ-JMS

- **WMQ acts as a SOAP transport for WS-\* Web services and this offers a number of advantages compared to HTTP transport -**
  - Improved reliability – invaluable for one-way message exchange patterns – since with HTTP there is no way for the Web service requestor to know if the request has been successful. SOAP/JMS is really capable of fire-and-forget
  - Manageability
    - WMQ / JMS messages are more tangible and traceable than HTTP requests
  - Asynchronous invocation
    - Limited (short term) asynchrony has existed in .NET for some time, and it has been added to Java JAX-WS. This does not offer any guidance on how to persist and correlate requests over a long time. True queued asynchrony adds resilience – (both parties don't need to be running at the same time), and requests can be longer running than typical HTTP request.
- **SupportPac MA0R was incorporated into WMQ v6**
- **Defines how SOAP messages should be carried over WMQ - thus ensuring interoperability between CICS, MQ, and WAS**

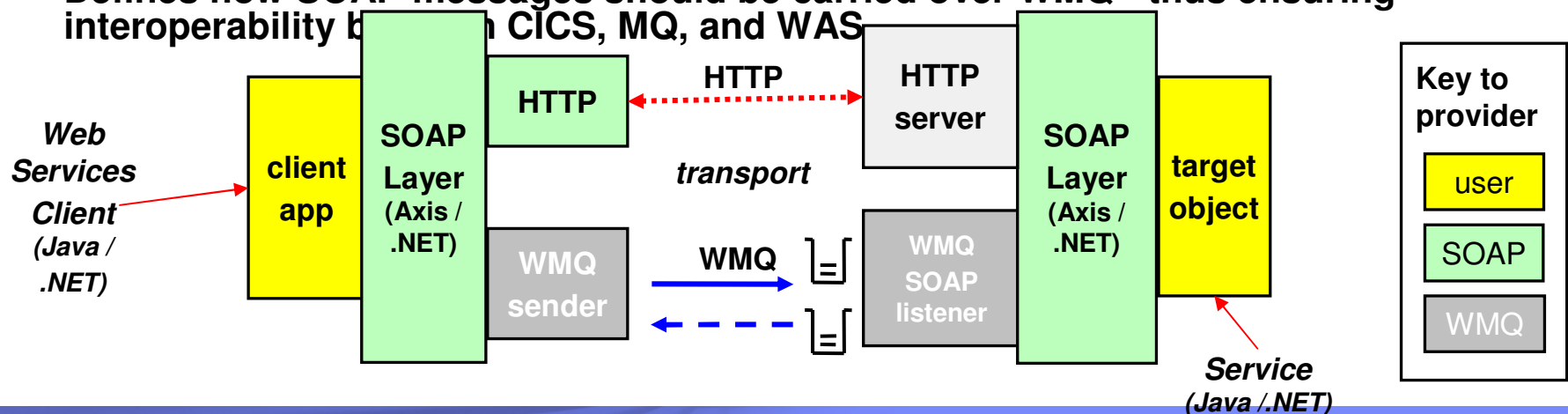

## WMQ as an SOA Asset - Service Descriptions

- **A standard way to describe all WMQ apps as SOA assets (services)**
  - To be inventoried, and catalogued in Service Registry
  - To be re-used as services in composite SOA applications
  - To be managed and traced with SOA tools
- **IBM has created the WMQ Service Definition and SOAP binding**
  - IRI for WMQ addresses (“wmq:”)
    - Message destinations - Queues or Topics
    - Other resources - Qmgrs, channels, channel status etc.
  - WSDL bindings to define application properties
    - Also defines the Message Exchange Pattern; Request queue; Response queue; Correlation style; Message format; Message persistence, priority etc.
- **Published as SupportPac MA93**



## WebSphere MQ V7.0.0.1 – Coming soon!

- **Accelerates use of MQ applications in SOA**
  - Graphical wizard to generate MQ Service Definitions (WSDL) for existing applications
- **Increases Governance of MQ networks**
  - Enables WebSphere Service Registry & Repository to govern MQ applications controlling changes throughout lifecycle
- **Promotes reuse of MQ applications services**
  - Provide visibility to MQ applications by cataloging them as services
  - Enables re-use based on usage by processes
- **Apply SOA best practices to MQ solutions**
  - Use MQ applications as services in SOA just like other services

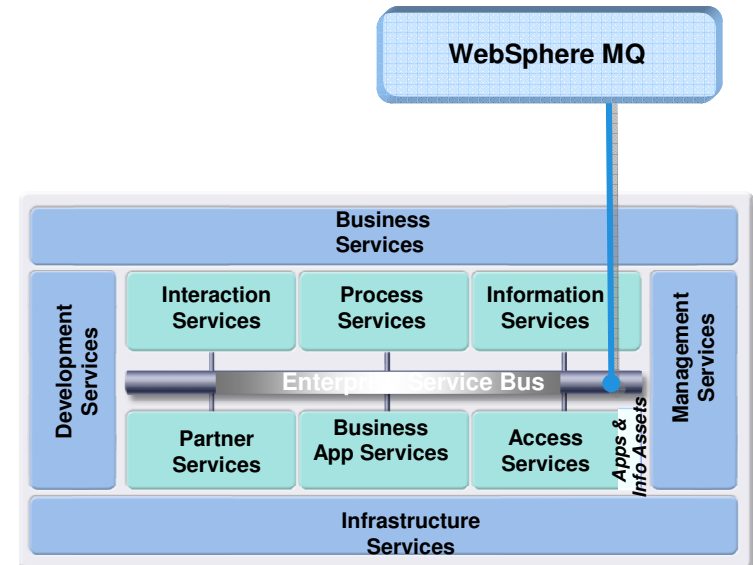

# WebSphere MQ and Linux for System z

# Why MQ for Linux on System z – Consolidation!

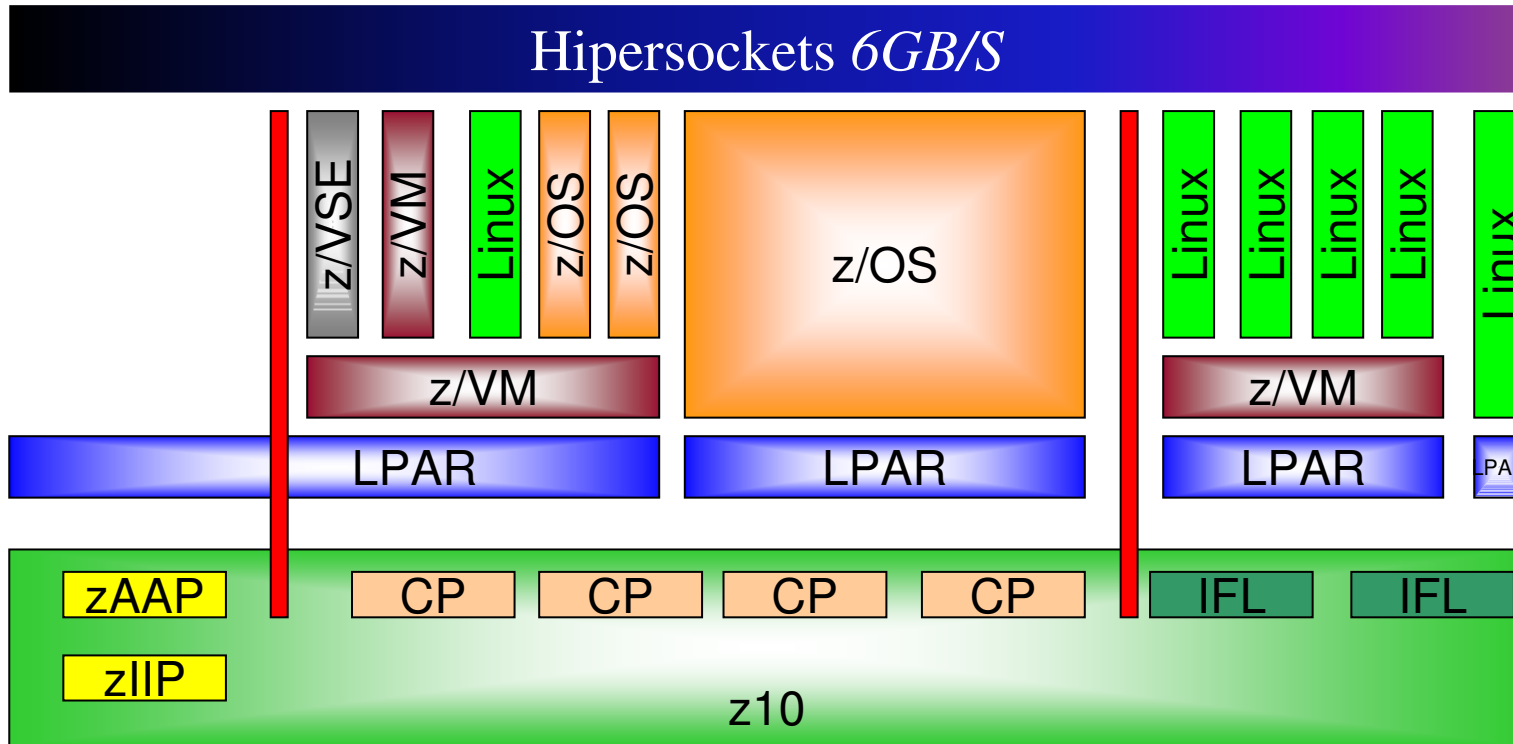

## HiperSockets – the biggest feature

- Like a windows loopback adapter
- Internal LAN
- Instead of using the network, uses memory
- Not quite memory speed, there is still some processing going on

## Manuals:

- WebSphere MQ for Linux Quick Beginnings - GC34-6480
- Redbooks:
- HiperSockets Implementation Guide - SG24-6816

# MQ and Files

## Introducing WebSphere MQ File Transfer Edition for z/OS V7.0

- **The newest member of the WebSphere MQ family**

- Builds upon WebSphere MQ's proven transport backbone
- Licensed as a trade-up from WebSphere MQ on distributed platforms

- **Will deliver robust solution for Managed File Transfer**

- Enable control of all aspects of file movement between IT systems
- Provide file delivery reliability
- Optimized for both small and massive files
- Provides audit trail of transfers

- **Designed to integrate with IBM's SOA portfolio**

- Enables files to be delivered to WebSphere Message Broker for File Processing

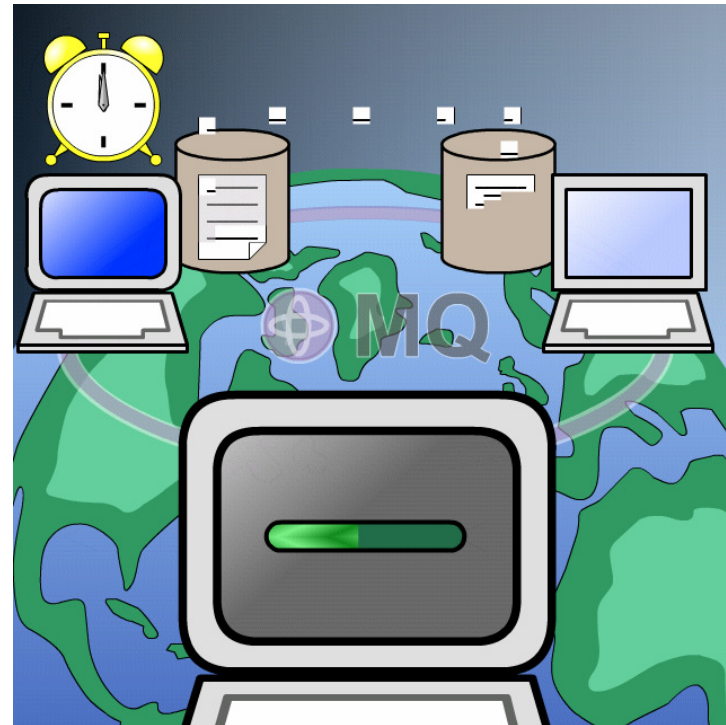

# What is Managed File Transfer?

- **Enables managed movement of files and documents between IT systems**
  - Auditable
  - Reliable
  - Secure
  - Any size file
  - Automated
    - Eliminating need to manually detect transfer problems and restart transfers
  - Backbone
    - Across distributed IT systems that need not be directly connected
  - Time-independent
    - Without requiring IT systems and network to be constantly available
  - Centralized control
    - Enabling remote management and monitoring of all aspects of transfer
  
- **Managed File Transfer is a strategic part of an organization's IT infrastructure**
  - Should be aligned with other transport mechanisms e.g. messaging
  - Managed File Transfer should work with and re-enforce SOA initiatives
    - Including applying ESB capabilities to files

# WebSphere MQ File Transfer Edition

- Adds file transfer services to WebSphere MQ to enable movement of files – regardless of size – in a managed way (reliable, auditable, secure)
- Multi-purpose infrastructure – for both files and messages

- ✓ Flexible backbone for transfers – not a single-hop solution like FTP
- ✓ Multi-purpose – use for messages and files
- ✓ Auditable with logging subsystem that tracks transfer at source and at destination for audit purposes
- ✓ Massive files – larger than MQ messages
- ✓ Reliability leveraging the MQ transport
- ✓ Integration with MQ-enabled apps and ESBs
- ✓ No need to program – no need to use APIs
- ✓ Simple graphical tooling enabling remote configuration
- ✓ Automatic file conversion and compression
- ✓ Security - of file payload using SSL
- ✓ Visual transfer status reporting
- ✓ Support for many supported MQ environments

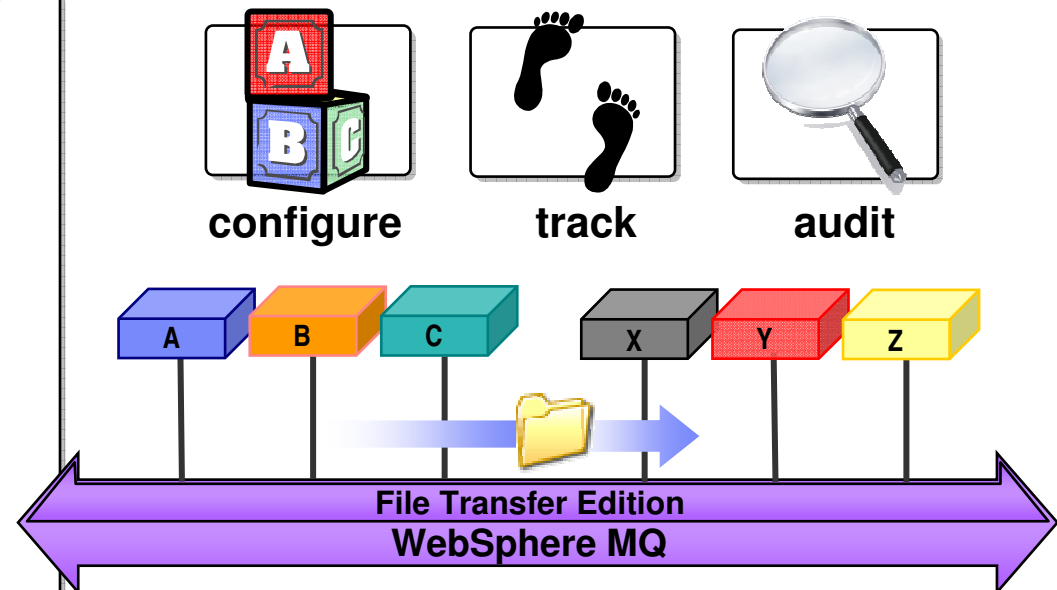

# Architecture

- Enables remote GUI configuration and admin using same tooling as MQ
- Tooling publishes transfer requests to Backbone
- “Agents” running alongside Queues managers publish audit trail to Coordination Center
- “Agents” monitor file directories, load/unload files & perform pre- & post-transfer activities
- Coordination Queue manager publishes transfer status, process and audit trail
- Coordination Queue manager requires MQ V7.0
- Multiple Coordination Queue manager could control transfers, capture audit log and publish status

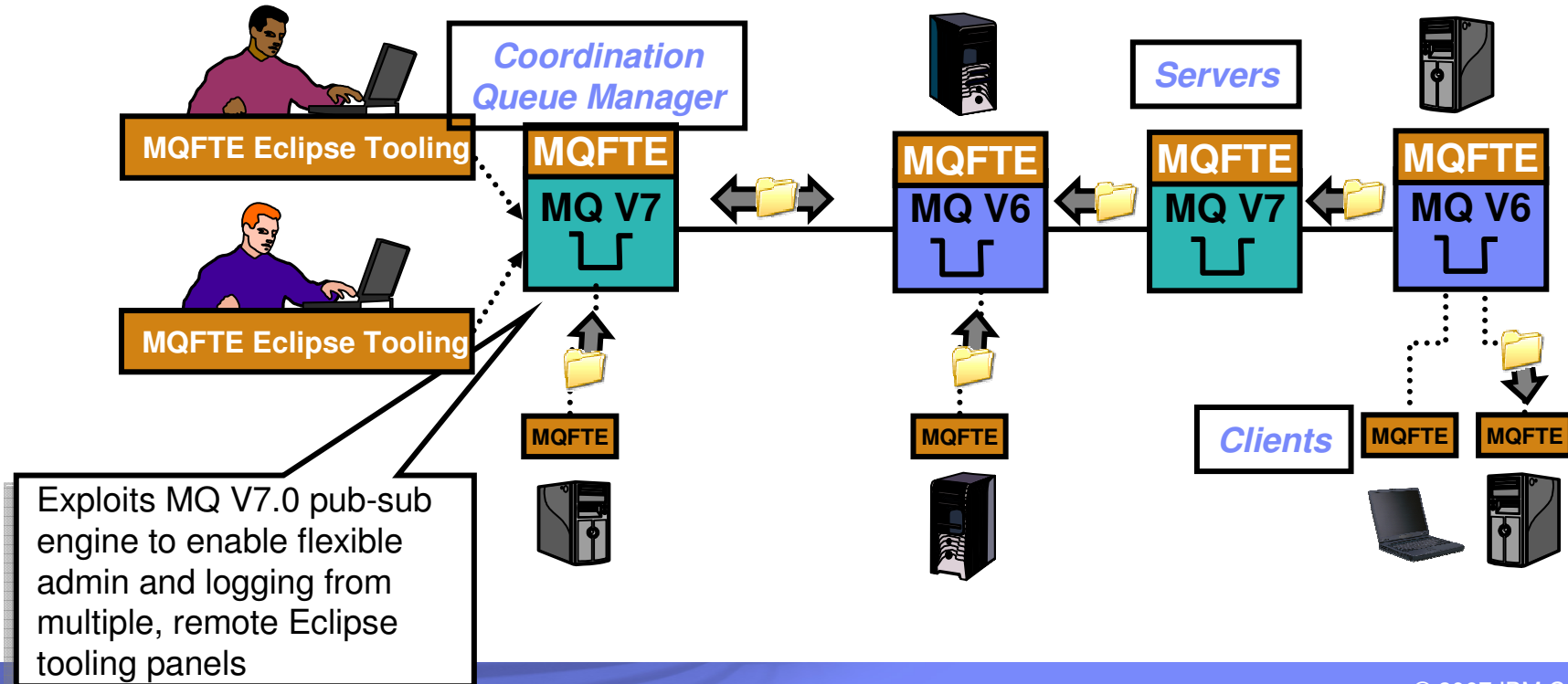



# Key Themes for WebSphere MQ File Transfer Edition

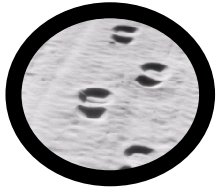

## **Auditable**

Audit logs of transfers at source and target  
Audit data persisted to MQ queues and/or relational database.  
Captures time-stamped log at source and target



## **Ease-of-Use**

Remote console for transfer initiation, unattended operation, scripting, scheduling, restart policies, status display  
Integrated with MQ Explorer configuration tooling



## **Simplicity**

Small footprint, fast install  
No need to write code or use API to configure transfers – Enabled via GUI  
Leverages WebSphere MQ – no other technology pre-reqs



## **Security**

Access to individual files subject to file system permissions  
Link level security (inheriting MQ SSL security)

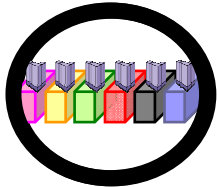

## **Breadth**

Support WebSphere MQ V6 and V7 for transfers  
Core Platform support (Windows, z/OS, Linux (32 Bit), Solaris, AIX, HP)  
Good file type support (ASCII/EBCDIC, CR/LF, Flat files, z/OS QSAM, BPAM, VSAM)



## **Automated Transfers**

Transfers can be scheduled to repeat at predetermined intervals  
Transfers can be triggered by range of file system events e.g. new files, updated file, etc.

# Apply to Join the Early Access Program

- What is it?
  - Opportunity to get early access to pre-GA code
  - Influence product directions and features
  - Build product knowledge and skills
  
- When does it start?
  - You can apply to join anytime after July 8<sup>th</sup> 2008
  
- How can I apply?
  1. Email [filetransfer@uk.ibm.com](mailto:filetransfer@uk.ibm.com) to request to join
  2. If accepted by IBM, receive your unique numerical key and URL address
  3. Use your Key to log on to the Early Access Program site
  4. Read & accept the Program terms
  
- What is required to join?
  - A specific Non-Disclosure Agreement (NDA) must be signed
  - Can be signed electronically via the Betaworks Web site
  
- What do I receive?
  - Download regular code drops of the latest pre-GA iterations
  - Opportunity to provide product feedback direct to labs
  - Product roadmap details and materials
  
- Who can I contact with more questions?
  - Send an email to [filetransfer@uk.ibm.com](mailto:filetransfer@uk.ibm.com)

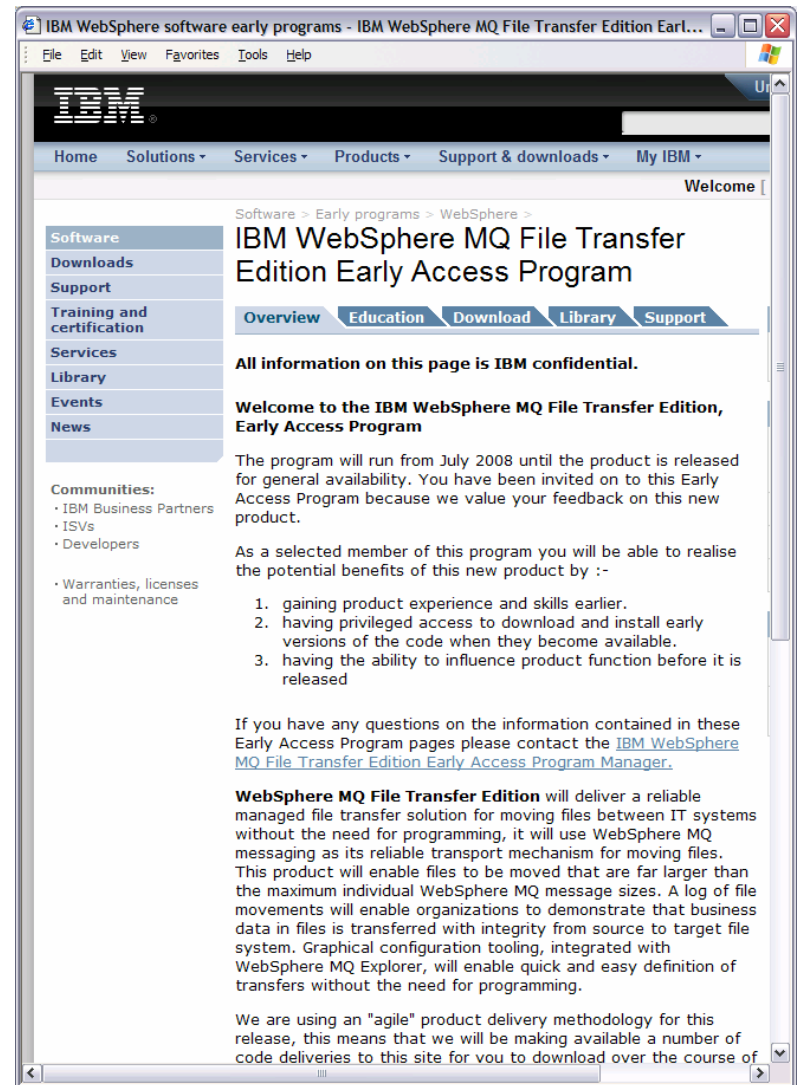

# WebSphere MQ Version 7 - Summary

- **Improvements to publish/subscribe**
- **Improvements to JMS layer**
- **Ease-of-use for administrators**
- **Ease-of-use for MQI programmers**
- **Performance**
- **Continues to extend the enterprise messaging foundation in the SOA world**
- **Key Dates:**
  - Distributed V5.3 End of Service in **September 2007**
  - z/OS V5.3.1 End of Service in **April 2008**
  - Fee-based service extensions normally available for an extra 2 years
  - V6 - No End of Service or Withdrawal from Marketing dates set
  - V7 - Announcement 1 April 2008
  - V7 - GA 27 June 08
  - File Transfer edition V7.0 planned availability Dec 2008
  - Look at URL for most recent info
    - <http://www-306.ibm.com/software/info/supportlifecycle/>

## Next Steps and more information

- **Talk with your IBM representative and IBM Business Partners to identify ways to help achieve your business goals with WebSphere MQ**
  
- **More information about WebSphere MQ can be found here**
  - [www.ibm.com/webspheremq](http://www.ibm.com/webspheremq)
  - [www.ibm.com/software/integration/wmq/zos/](http://www.ibm.com/software/integration/wmq/zos/)
  
- **WebSphere MQ File Transfer Edition**
  - <http://www-306.ibm.com/software/integration/wmq/filetransfer/>
  
- **Additional materials**
  - White paper: The Value of WebSphere MQ for z/OS for the CICS customers  
<ftp://ftp.software.ibm.com/software/integration/wmq/WSW11355-USEN-00.pdf>
  - Article: Connecting System z applications with IBM WebSphere MQ on z/OS <http://www-306.ibm.com/software/tivoli/features/ccr2/ccr2-2007-12/connecting.html>
  - Introducing reliable, Managed File Transfer for z/OS  
<http://www.ibm.com/software/os/systemz/telecon/27aug/index.html>

Thank  
YOU





# Additional Information





# Migrating to WebSphere MQ for z/OS V7

General Guidance and Q&As

July 2008



## MQ Version to Version Migration

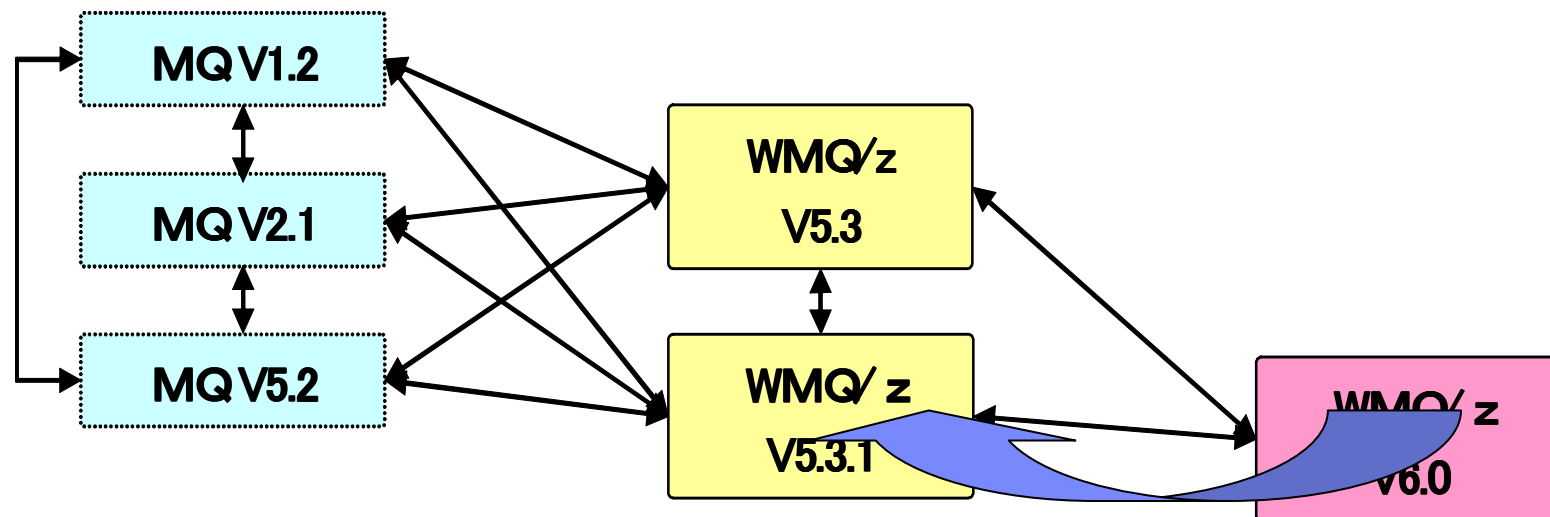

Supported backward  
migration path till 30 April 2008

**Recommendation: migrate from older versions straight to MQ V6**

Prior to MQ V5.3 the Product was called MQSeries



## MQ Version migration to MQ V7

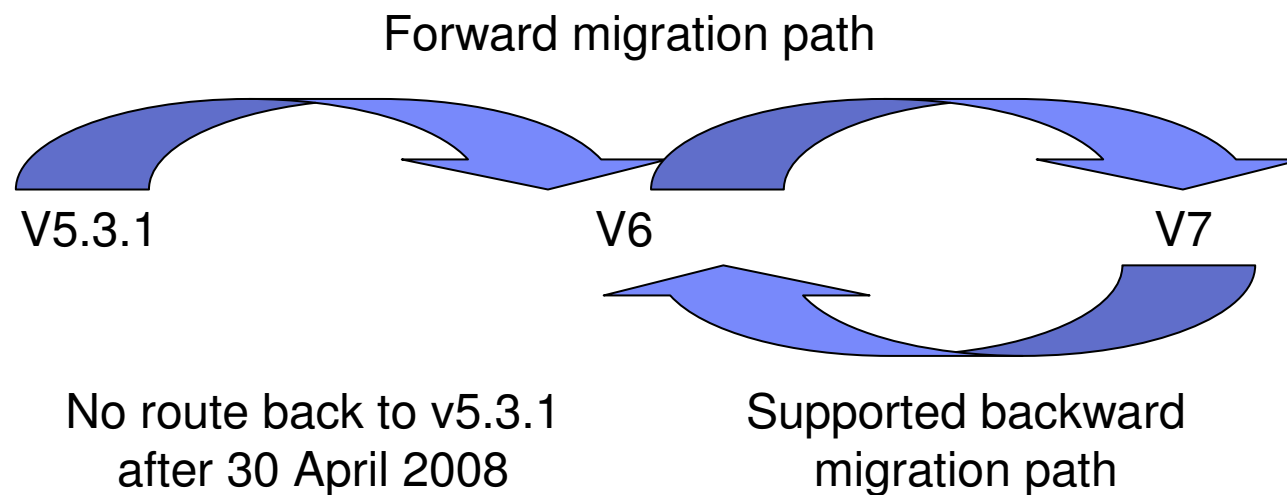

### Customers still on MQ V5.3.1 should not wait for MQ V7

**Notes:**

1. **The following v6 APARs are required if you are using Queue Sharing Groups (QSGs) and/or need rollback capability.**  
**Target date for delivery: End of September 2008**
  - **To enable coexistence of v6 and v7 Qmgrs in a QSG: PK64466**
  - **To enable backward migration from v7 to v6: PK64463**

# Alternative Path to MQ V7

Forward migration path

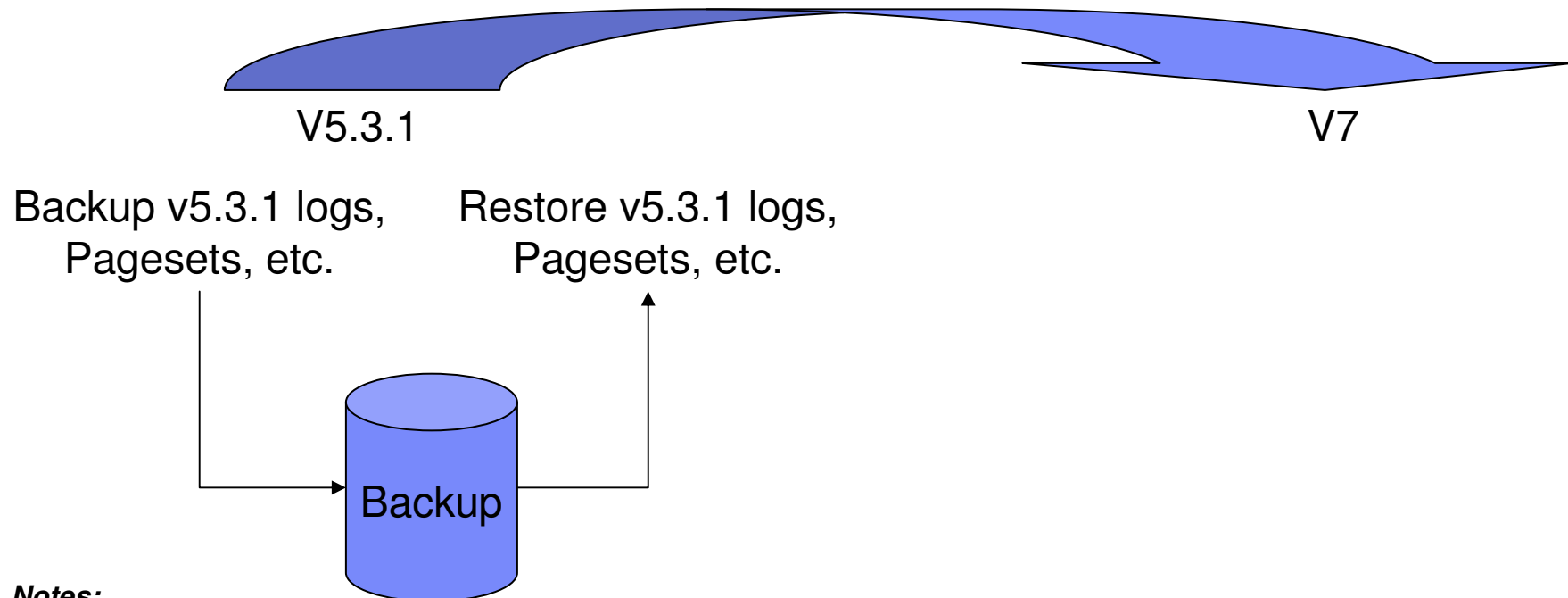

## Notes:

1. *If any v5.3.1 queue managers to be migrated are members of a Queue Sharing Group (QSG), then all queue managers in the QSG will have to be upgraded to v7 at the same time.*
2. *If you do choose to go back to v5.3.1, any work done under v7 will effectively be lost.*
3. *Only consider this option if:*
  - *You do not need experience for your production migration.*
  - *You don't use queue sharing groups or you have sufficient knowledge and experience for migrating QSG definitions.*
  - *You know you will never have to fallback.*
  - *You understand the risks of using unsupported v5.3.1 code from its end of service until you choose to install V7.*

## Q & A

- Question: **WMQ V7 slides state that it's possible "... to migrate up to v7 from v531 but there will be no support for fall back to v531". What does this mean in detail, particularly to QSG users?**
  - **Answer:** This means that you will be able to stop your qmgr(s) at v531. Perform migration actions, then restart them at v7. However, if things go wrong, there is no path back to v531. You are reliant on having taken backups of your qmgr logs (containing CF structure backups for shared queues), pagesets and DB2 tables prior to performing the migration actions and restoring them should you need to revert to the v531 configuration. Specifically, a v531 qmgr will not startup in a QSG that has been migrated to v7, a v531 qmgr will not startup if its pagesets have been used in a v7 qmgr.
  
- Question: **There definitely is \*no\* utility that updates QSG DB2 tables for compatibility between V5 and V7. From this, I conclude that - all members of a QSG have to be switched to V7 at one time (if the "switch" is from V531 Y V7) -- TRUE?**
  - **Answer:** Correct. We provide job CSQ45ATB which adds additional tables and columns to existing tables as required by a V7 qmgr. Running this job is one of the migration actions. As you are avoiding V6 you will have a disruptive migration path to V7 - it is not possible to maintain availability of the QSG during migration.

## Q & A (Continued)

- Question: **v531 Shared queue object definitions can only be "migrated" by means of saving them at v531 and restoring them at v7 -TRUE?**
  - **Answer:** Saving the definitions is required to re-activate them at the V7 level, because the DB2 tables have to re-built from scratch (at the V7 layout). In addition, saving definitions prior to migration is a sensible precaution. You will have to restore them if you needed to fallback to the v531 configuration.
  
- Question: **What about shared queue messages (CF structure contents)? Will a queue manager started at v7 be able to access CF structures and their contents, as they have been left over by the v531 queue manager?**
  - **Answer:** Yes

## Q & A (Continued)

- **Question: I understand that the "migration" surely can be done by means of a WMQ cold start at v7, after definitions and (if necessary) queue contents have been saved at the old V5 level- with both logs, BSDSs and PSIDs created new. The question is: will/ should it be possible to keep the PSID contents, thus preserving (non-shared) object definitions and messages and just newly create the logs and the BSDSs, apply the CSQUTIL/RESETPAGE function to the PSIDs, and then restart at v7 (of course, the DB2 stuff would have to be re-created new completely). So, will v7 be able to work with a consistent set of PSIDs produced and closed at v5?**
  - **Answer:** It will be possible to cleanly stop a qmgr at v5.3.1. Perform the migration actions, then restart that qmgr at v7 without loss of persistent messages and other data. This would be our advised approach (rather than the cold starting you mention above - if you cannot afford to go via v6)



# Introduction to WebSphere MQ for z/OS concepts



# WebSphere MQ connects virtually anything

WebSphere MQ has probably the software industry's **broadest** support for:

- programming languages
- messaging interfaces
- application environments
- OS platforms

*Ubiquity of support gives developers the freedom to choose the technologies they prefer and already have skills in and can connect together what they already have...*

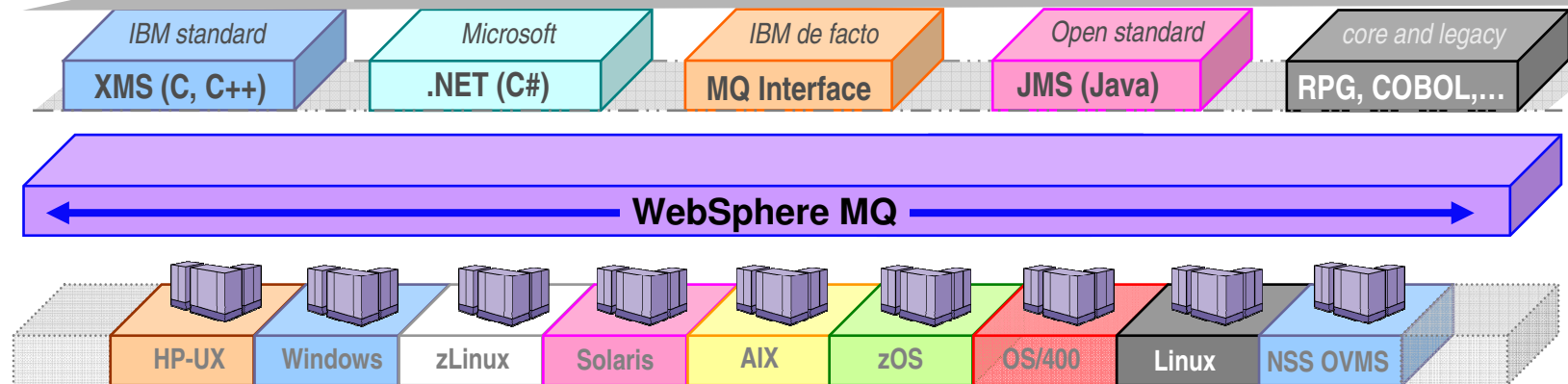

**80+ platform configurations**

## How does WebSphere MQ work?

- **Connects applications using Messages sent via Queues.**
- **Queues are owned by Queue Managers which store and forward messages.**
- **Routing is dynamic and configurable**
- This allows applications to be very loosely coupled...
  - Cuts location dependencies
    - Sender does not need to know where the receiver is running
  - Cuts timing dependencies (asynchronous)
    - Sender does not need to know whether the receiver is running
  - Cuts platform dependencies
    - Sender does not need to know the platform the receiver is running
  - Cuts data dependencies
    - With a Broker they do not even need to agree on the data format

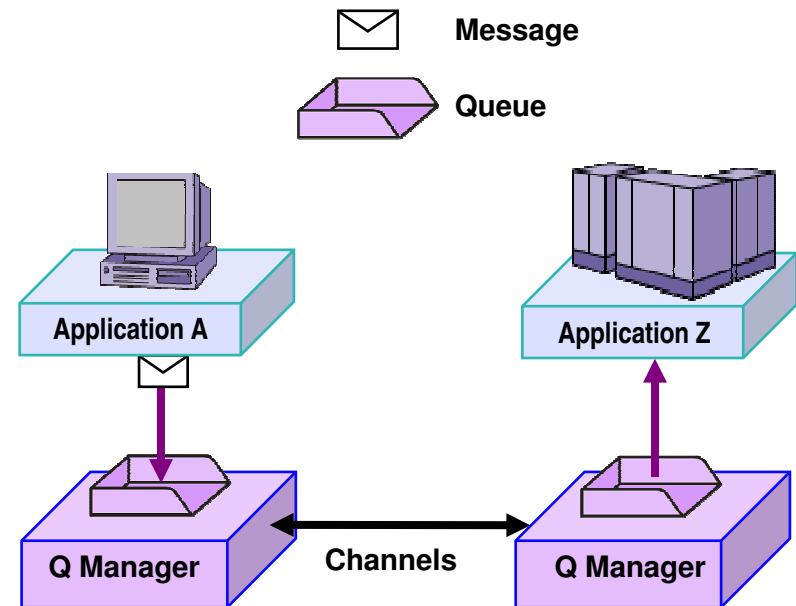



# Pseudo-synchronous or asynchronous styles

Customer-facing transaction.  
Pseudo-synchronous does NOT mean slow !!

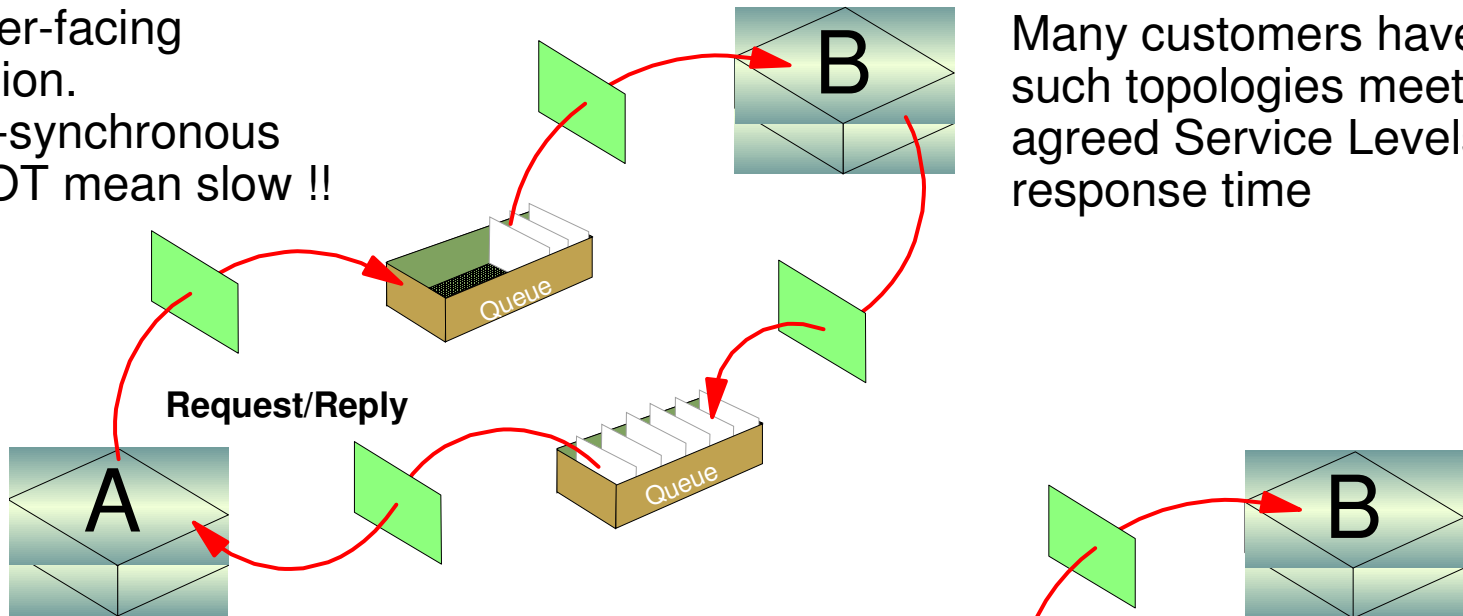

Many customers have such topologies meeting agreed Service Levels of response time

Could also be a Customer-facing transaction but no response is required.

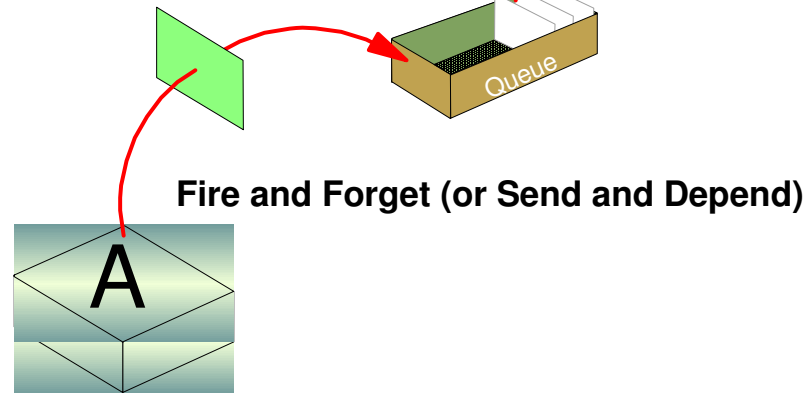

# Pseudo-synchronous and asynchronous styles

## Enables parallel processing

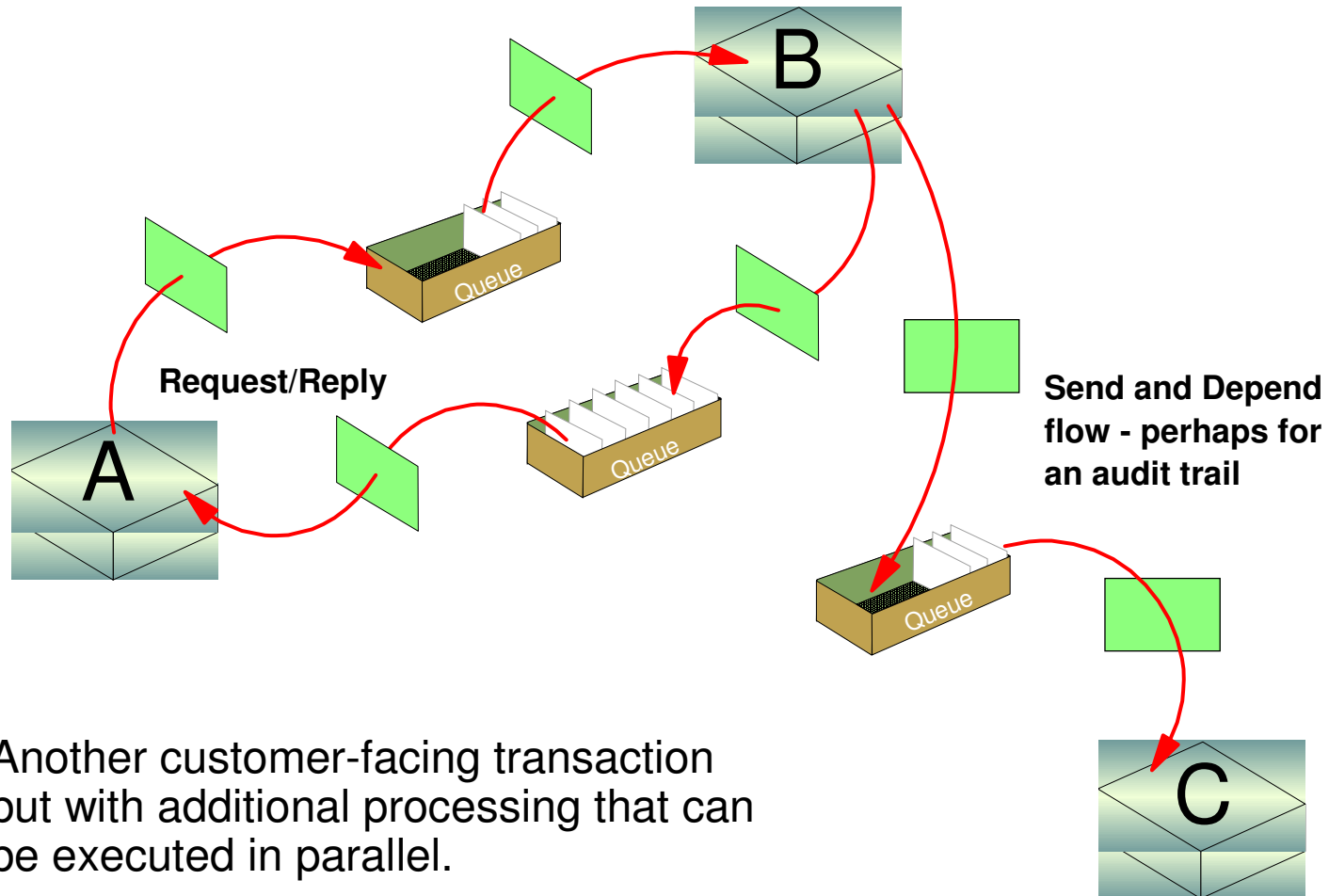

# Transactional support ensures all or nothing

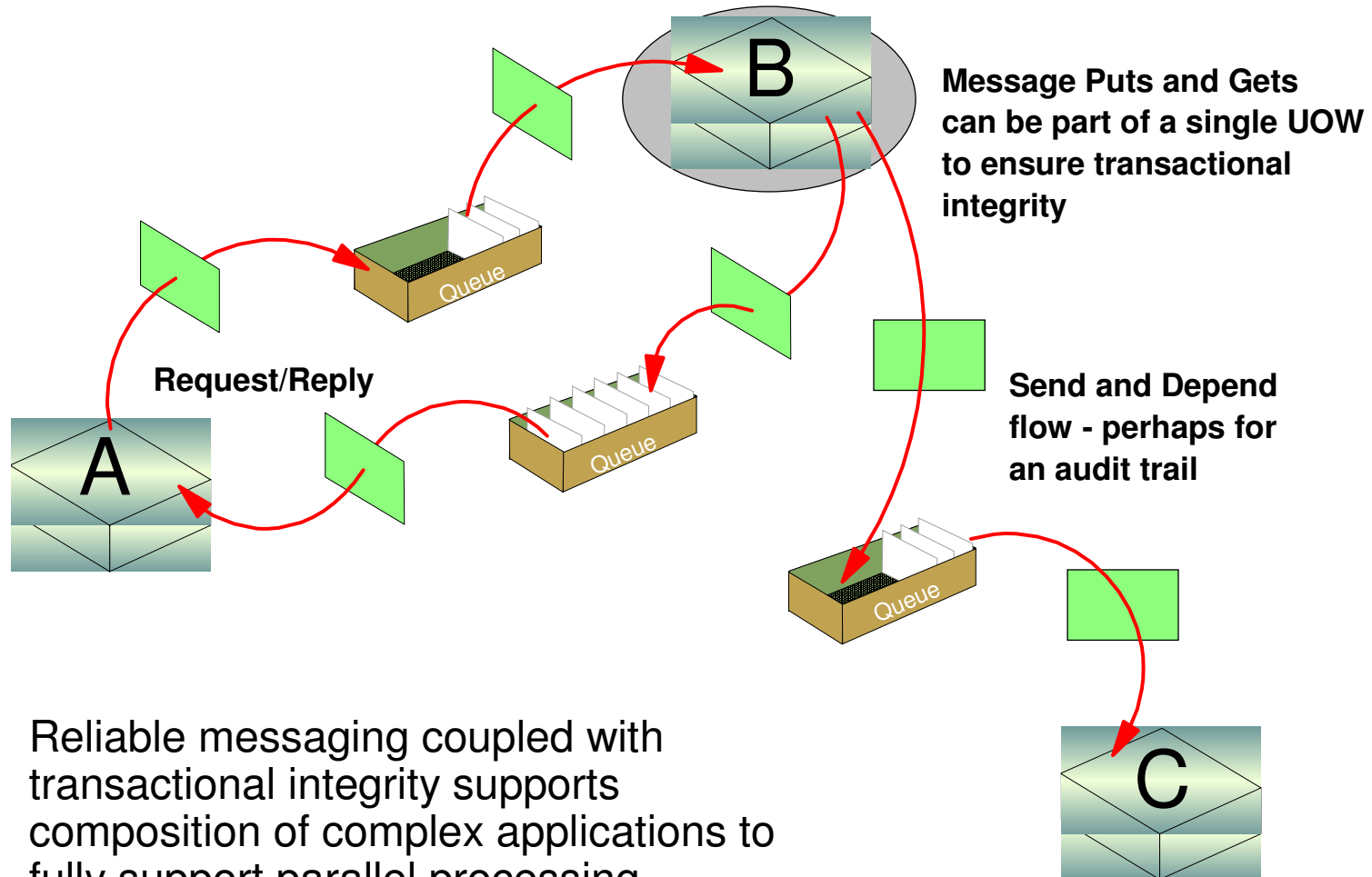

Reliable messaging coupled with transactional integrity supports composition of complex applications to fully support parallel processing.

# Full support for transactional environments

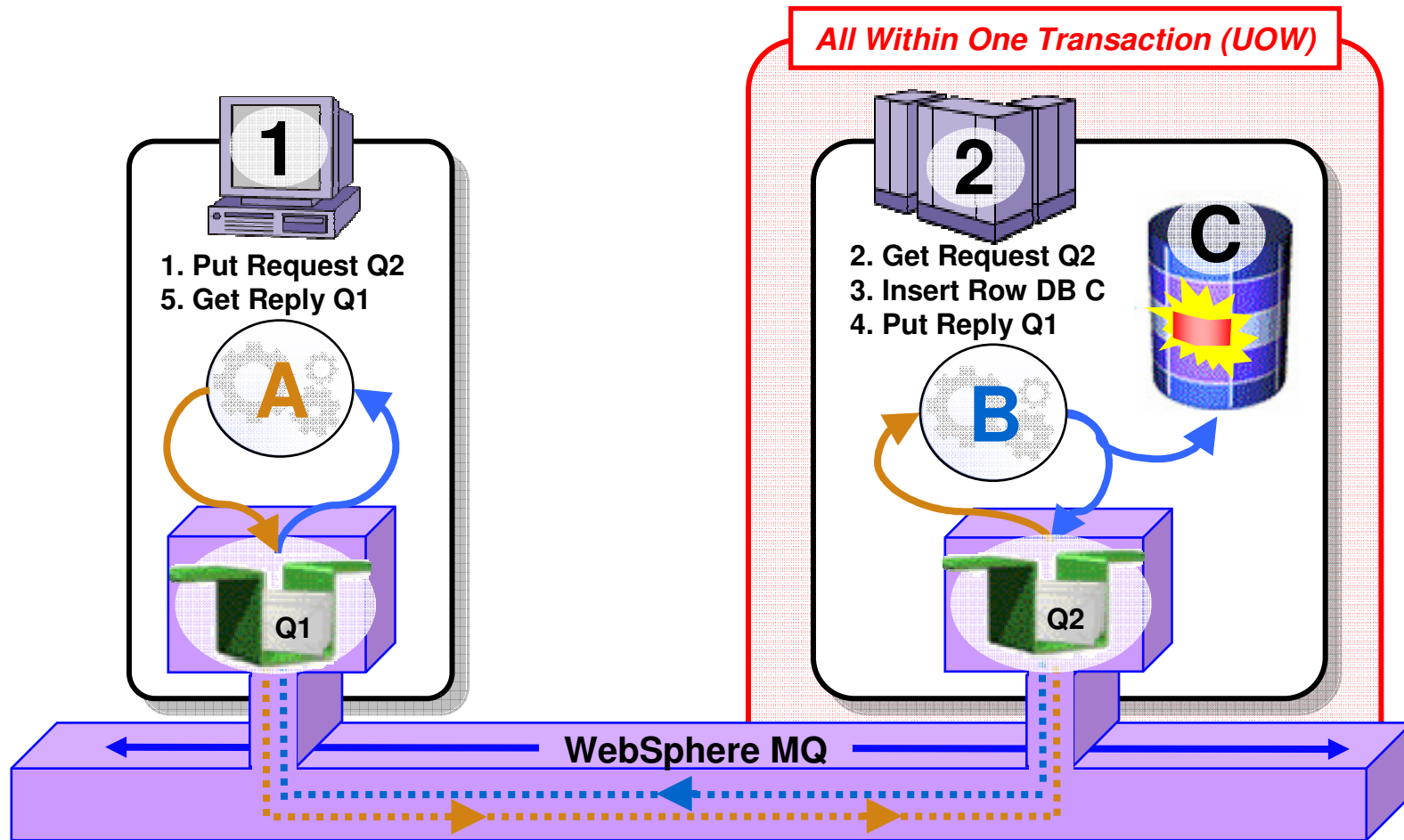

- Full support for CICS, IMS, WAS, DB2 SPs & Batch RSS
- Reliable Two-Phase commit involving other Resource Managers e.g. DB2

## Loosely coupled interaction style

Through correct use of ALIAS queue definitions, the application interaction can be augmented at any point in the flow to enable additional processing without application change.

This example shows a classic use of WebSphere Message Broker – Application D here - which in turn provides rich capabilities for augmentation, routing, transformation etc.

All of the above provides flexibility in placement of business logic

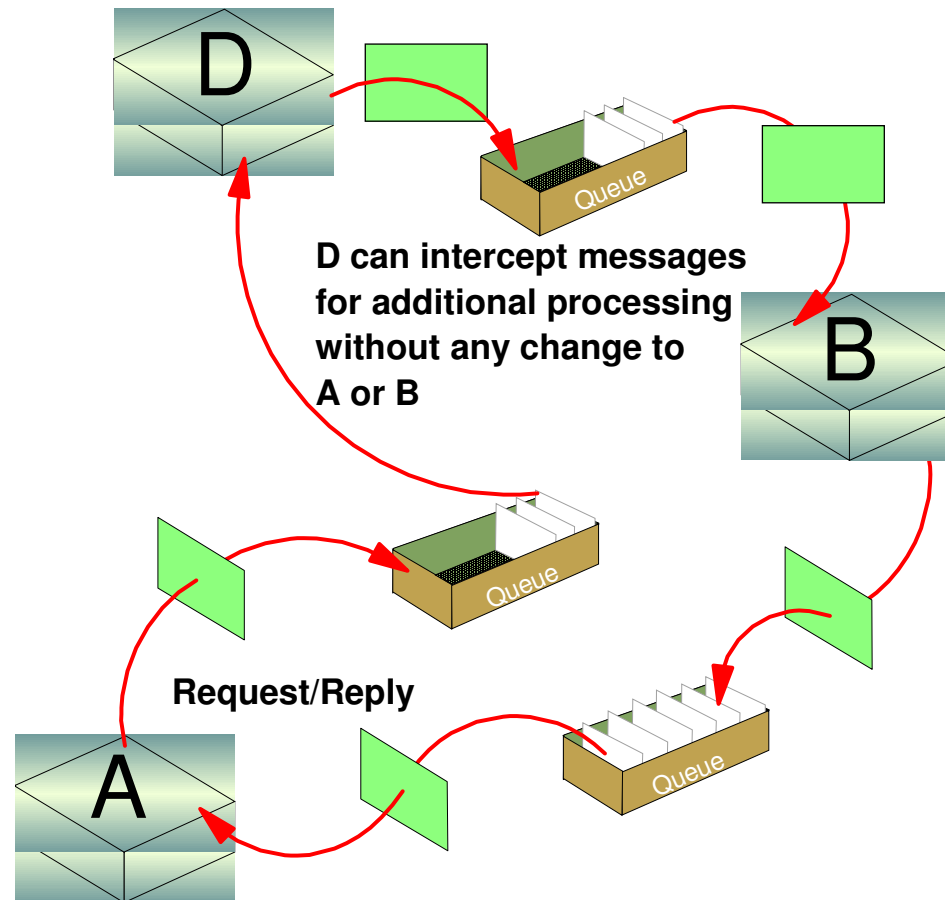

# Workload Balancing with Clustering

- “Round Robin” balancing by default
- Custom balancing algorithms can be added as workload exits
- MQ V6 provides additional balancing based on assigned priorities & weightings

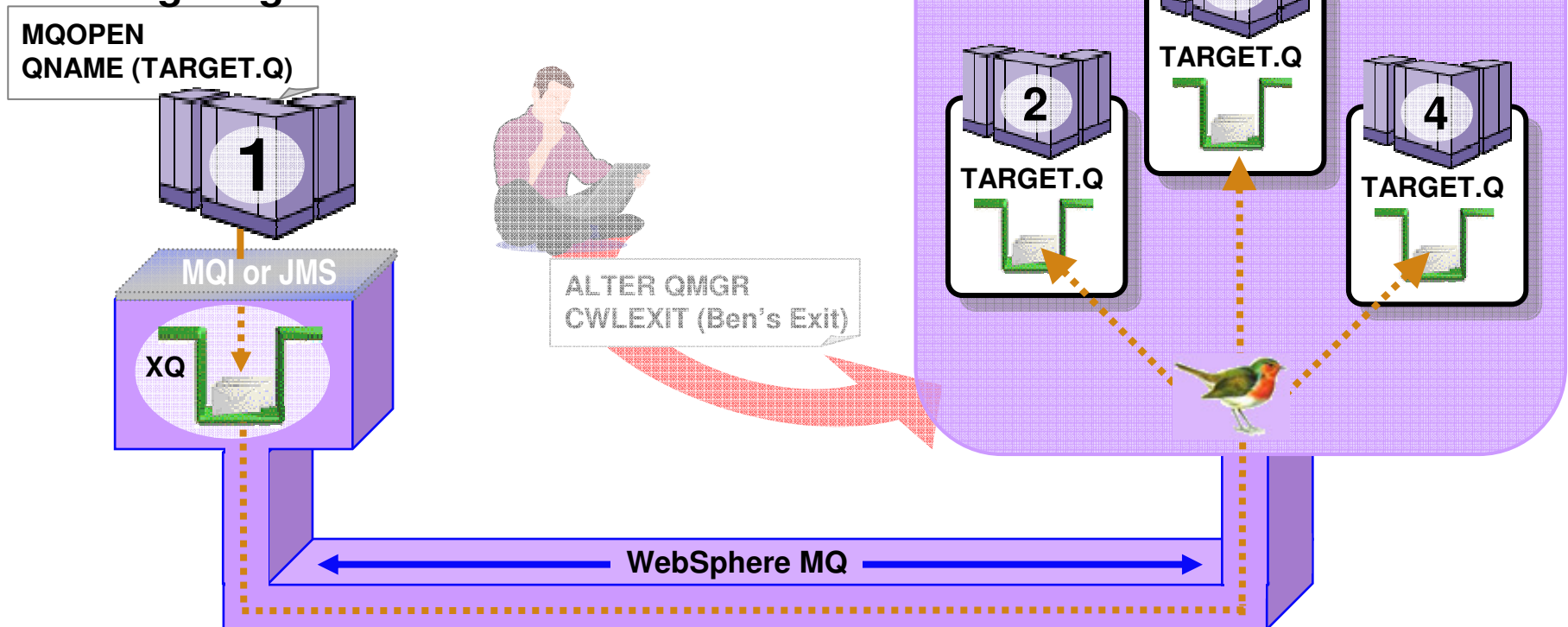

# Shared queues on z/OS

- Exploits Parallel Sysplex
- Automatic load balancing
- Scalable throughput
- Multiple processors can access the same queue
- Queue sharing groups
- VIPA support

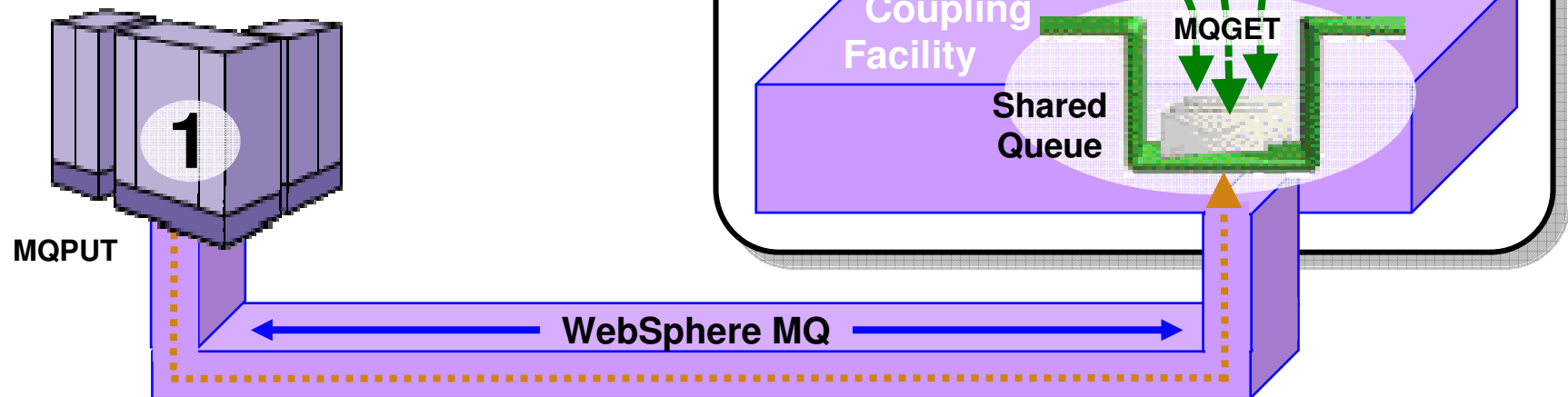

# Highly Available with Failover for z/OS

- **Failure isolation**
  - Automatic peer recovery for failing Servers, Applications or Queue Managers
- **In-flight MQPUTs and MQGETs are rolled back**
  - Since messages are not hosted in any Queue Manager there are no marooned messages
- **24 x 7 availability**
- **Leverages ARM (Automatic Restart Manager)**

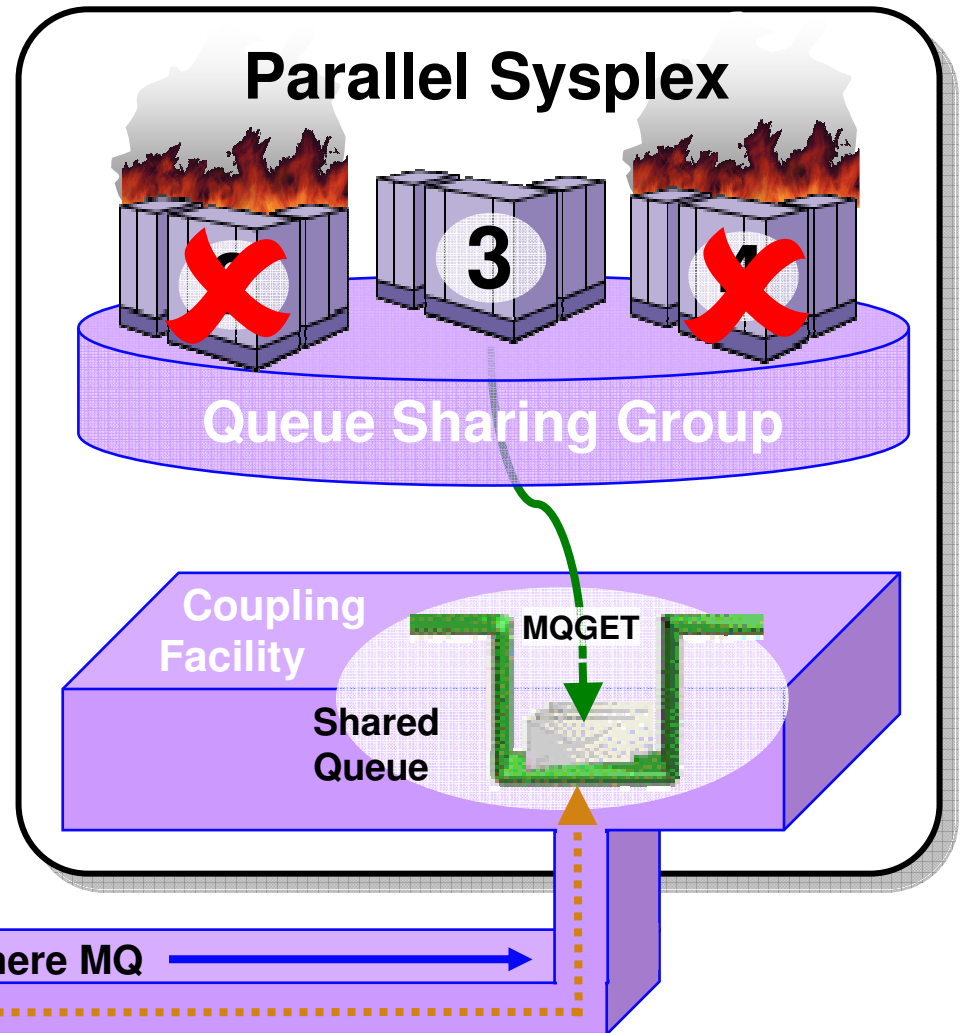
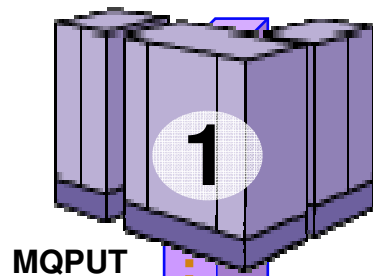



# Accessing CICS, IMS, DB2 SPs and Batch/TSO

*Explicitly – Using the MQI or JMS API*

- Gives CICS and IMS access to messages from other z/OS regions and other non-z/OS platforms
- Allows other applications to access CICS and IMS without using CICS or IMS APIs

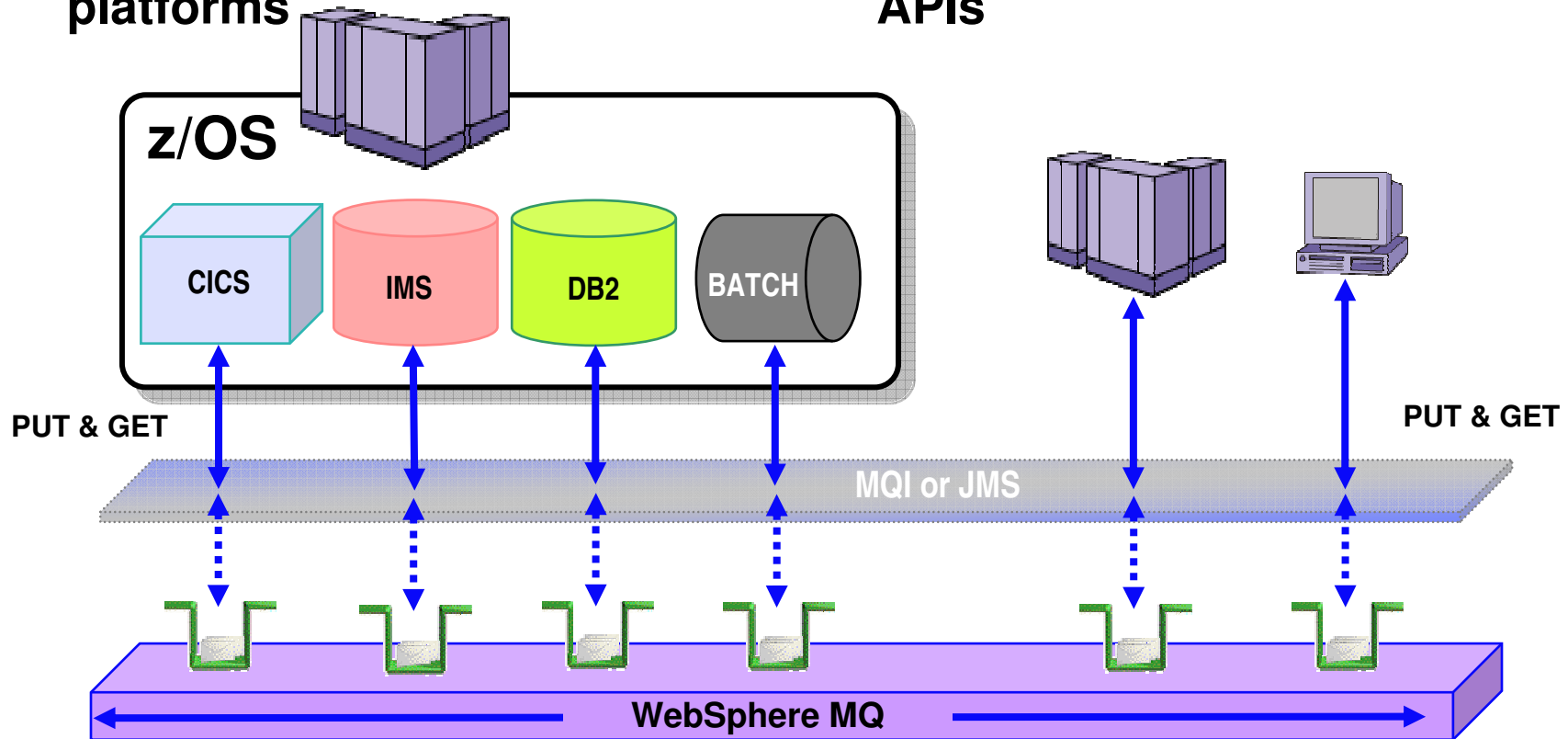

# Accessing CICS and IMS

*Implicitly – Using the Bridges supplied for CICS and IMS*

- **CICS and IMS applications use the native APIs:**
  - EXEC CICS BMS, GU, ISRT...
- **Allows other applications to access CICS and IMS without using CICS or IMS APIs**

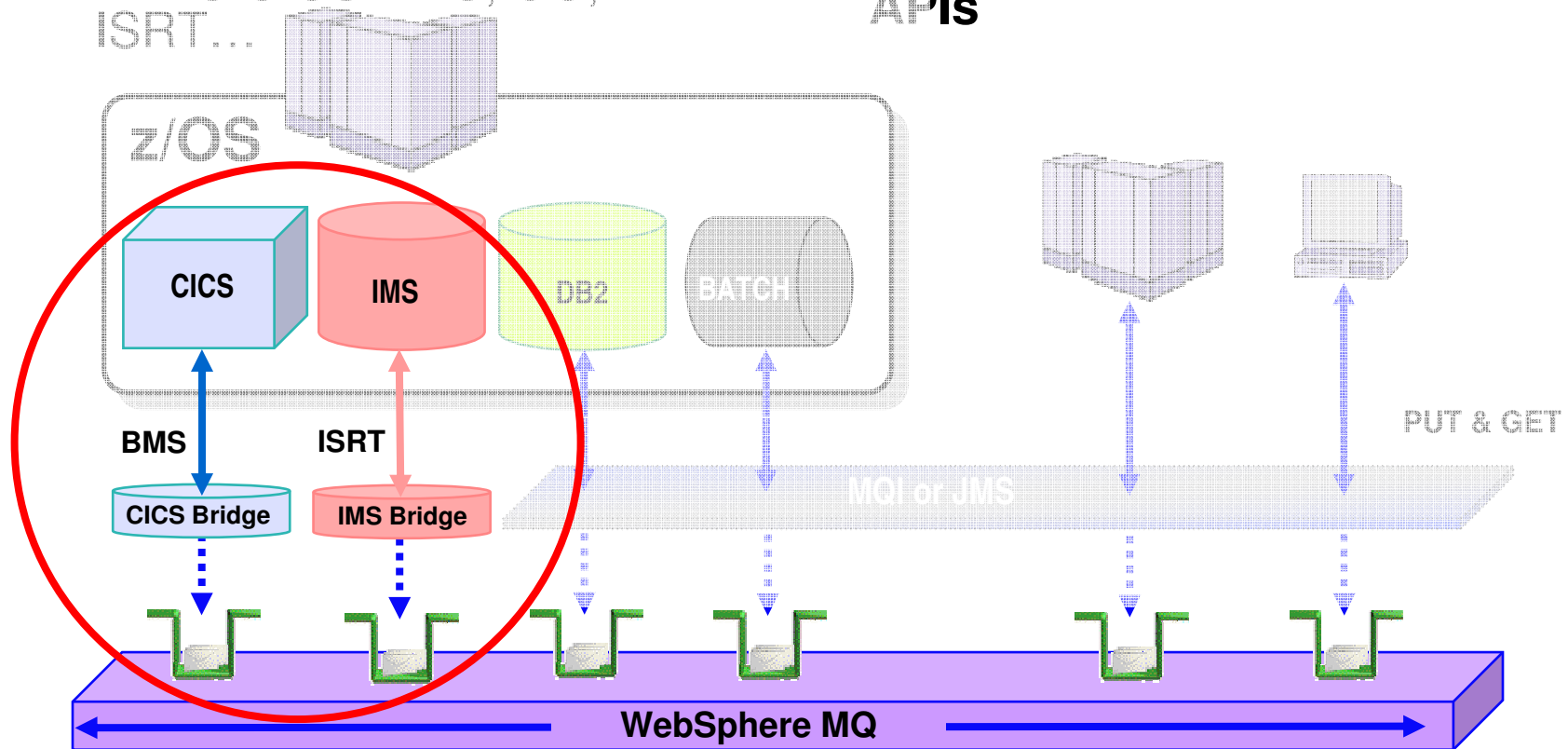

## New Cluster Options

- **Weighting & priorities**
- **Include local instance**

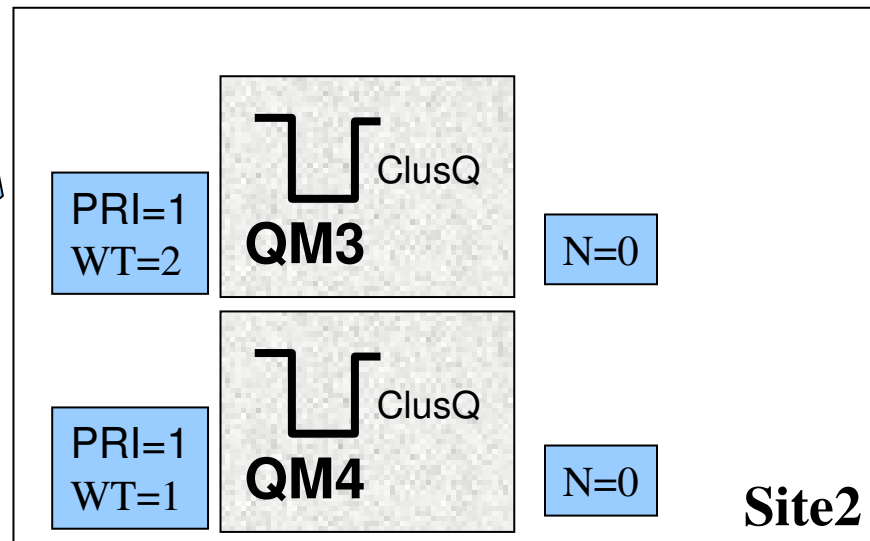
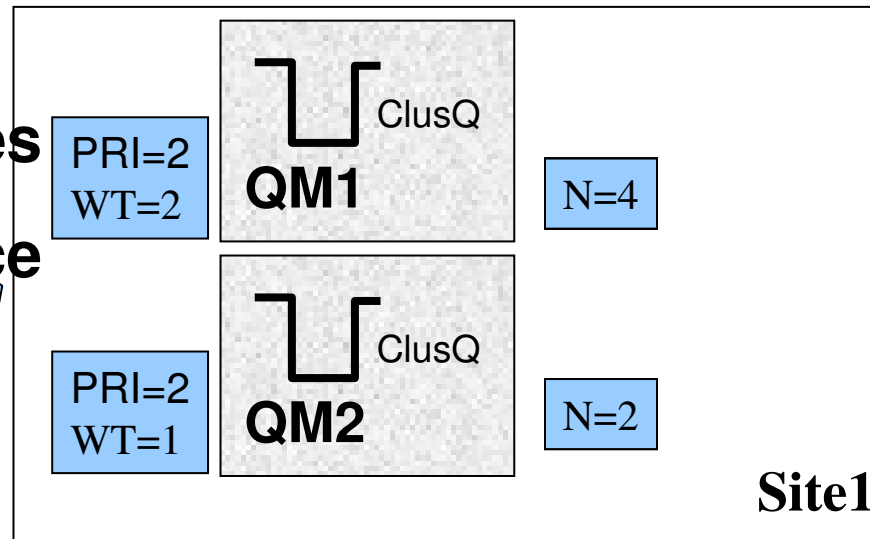
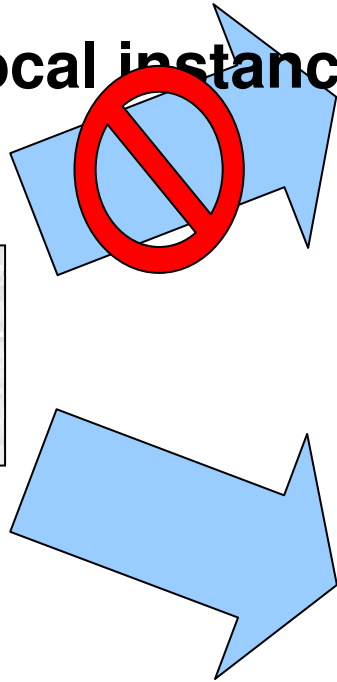
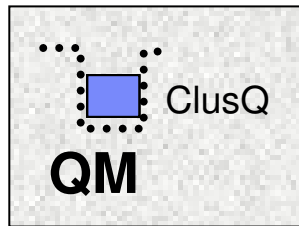

# New Cluster Options

- **Weighting & priorities**
- **Include local instance**

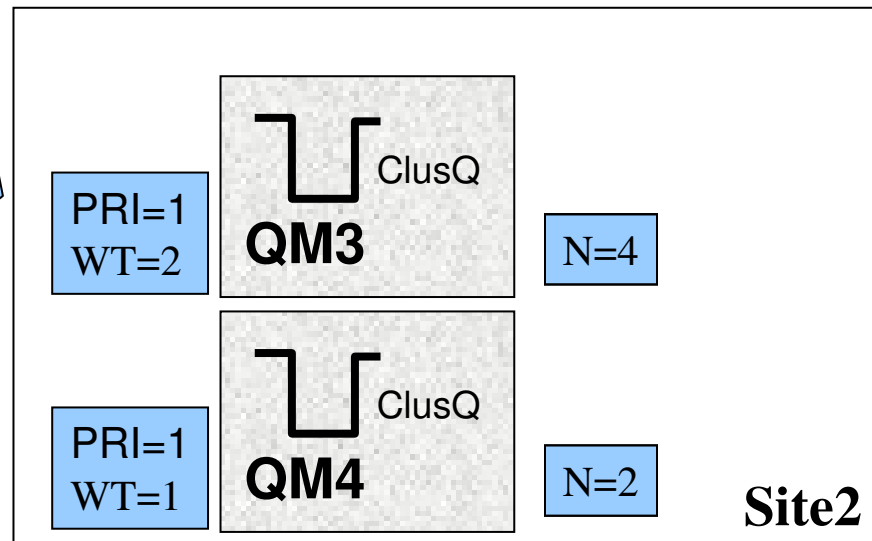
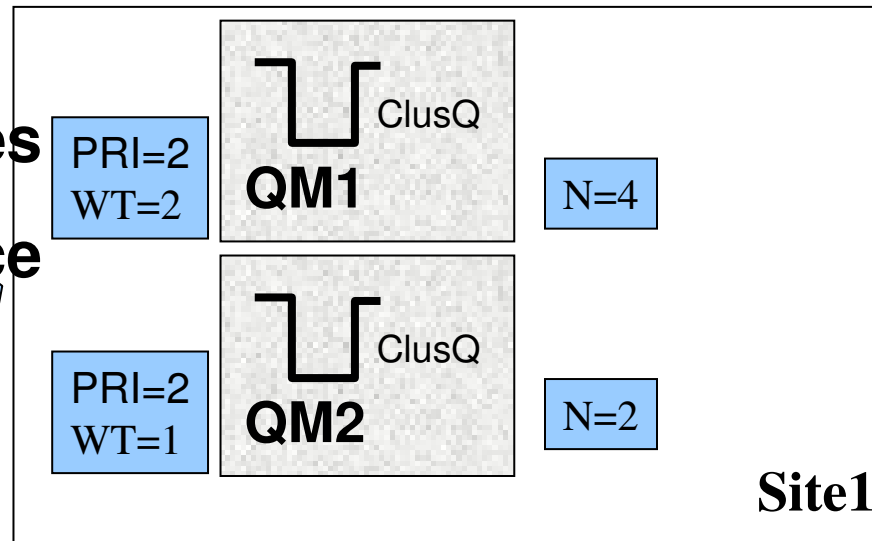
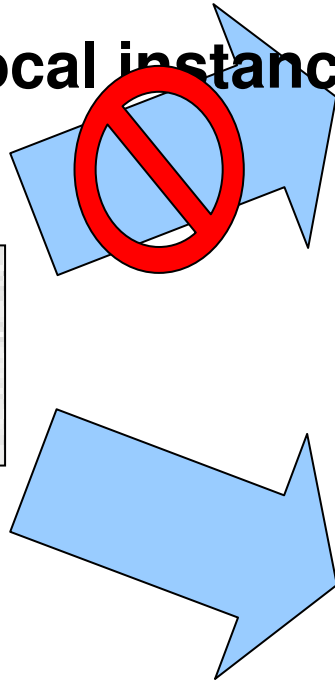
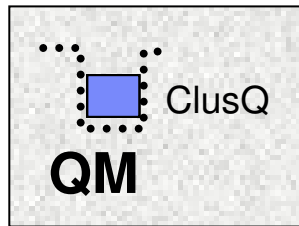

# WebSphere MQ for z/OS V6 and recent SupportPac highlights

- **The details of z/OS availability**

## z/OS Availability – Large shared queue messages

- **Removes the 63KB limit for shared queues so removing a significant constraint for WMQ application exploitation of shared queues**
  - Maximum shared queue message length now 100MB
    - same as that for non-shared messages
- **Uses DB2 to store large message payloads as BLOBs**
  - Header stored as V5.3 in CF with pointer to BLOB
  - Transparent to applications
  - Small messages stored as in V5.3, without DB2
- **There are performance implications ...**
  - Expect degradation (indications are >4x for large persistent messages)
  - All customer feedback indicates that only a small percentage of applications that use shared queues will have messages > 63KB so the performance cost is believed to be acceptable

## z/OS Availability – SQ Admin. Structure recovery

- **The Shared Queue Administration structure holds key WMQ control information across the queue-sharing group**
  - Transaction state information to enable peer recovery
  - Serialised application support information
  - Structure interest information
- **But with WMQ V5.3 a loss of this structure will cause each connected Queue Manager to fail resulting in a total loss of the queue-sharing group**
- **In WMQ V6 this limitation is removed**
  - Queue Managers will reconnect to/reallocate the structure
  - This is done automatically - no operator intervention required
  - Structure will be rebuilt from log data
  - Until the rebuild is complete some shared queue functions will not be available
    - no new shared channels can start
    - no Application structure rebuild is possible
    - no Queue Manager peer recovery is possible
  - BUT .. Existing applications will carry on running to completion and the vast majority of new applications can start and also run to completion

# z/OS Availability – SQ Admin V5.3.1 v V6

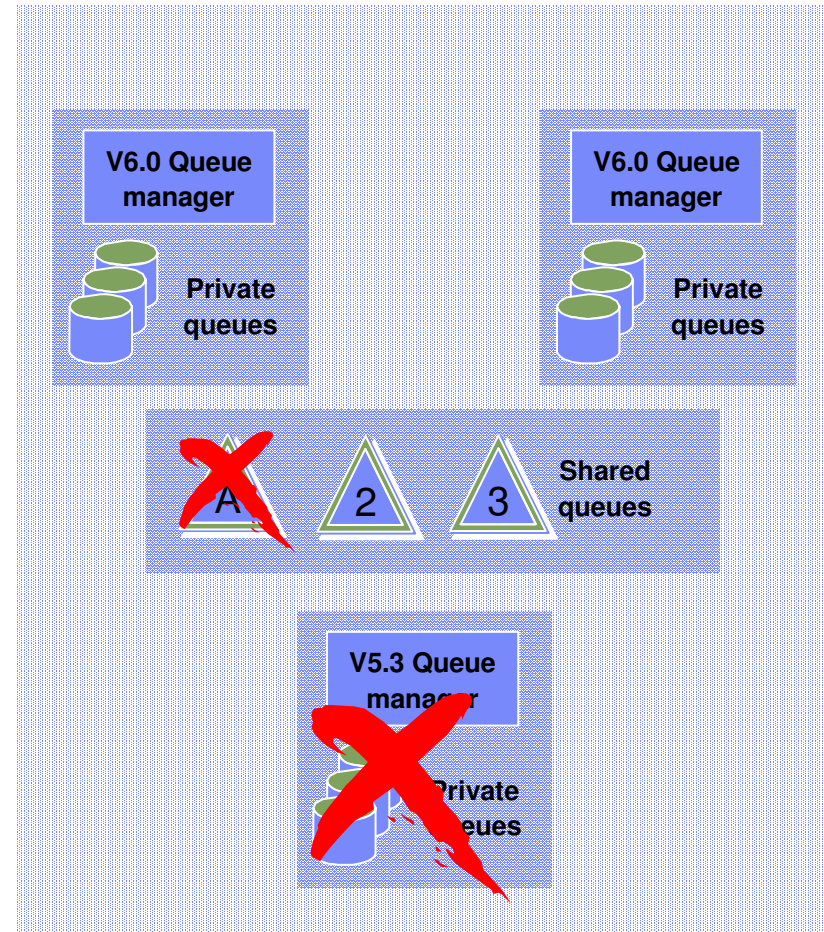
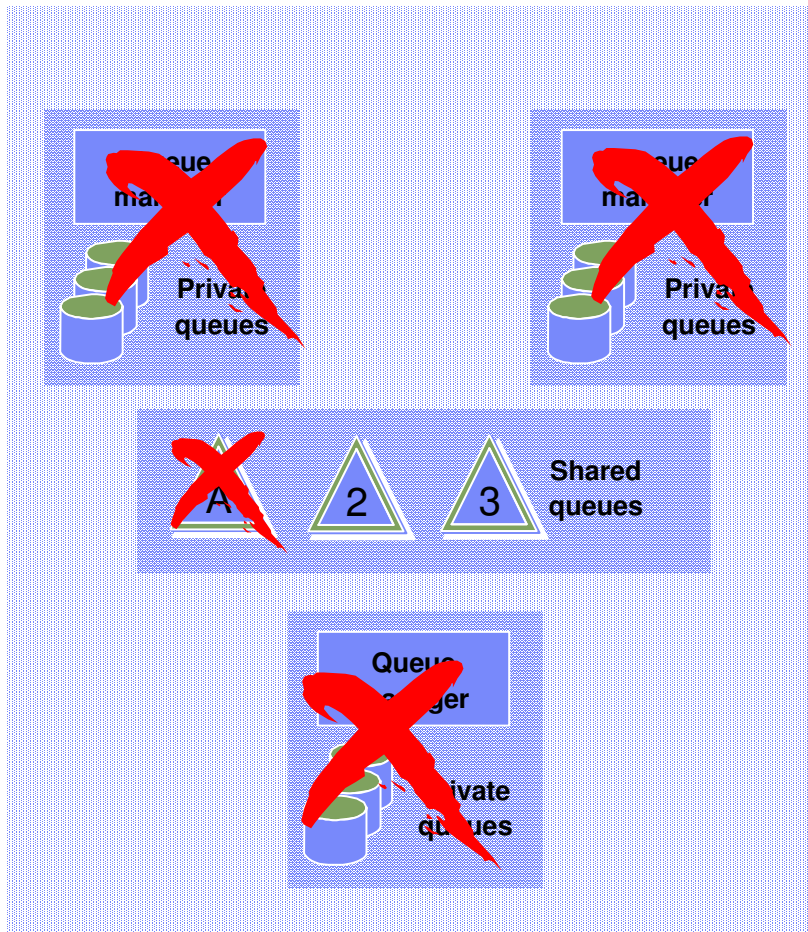



## z/OS Availability – 64GB Page sets

- **In order to have page sets that exceed 4GB -**
  - NEW PAGE SETS MUST BE CREATED
- **Page sets MUST be DEFINED with an SMS DATA CLASS that specifies –**
  - "EXTENDED ADDRESSABILITY"
- **Create replacement page sets with the SAME SIZE as the page set that they replace, and REPRO old page sets to the new page sets - these page sets will 'grow' beyond 4GB by page set expansion**
- **Or brand new page sets can be allocated > 4GB and formatted ready for use**
- **Update QMGR JCL to point to new page sets**
- **Note: Existing page sets can continue to be used, but they will continue to have a maximum size of 4GB**

## z/OS Availability – Dynamic CHIN parameter setting

- **CSQXPARM parameters are now attributes of the Queue Manager object**
  - Supports common methodology for “Queue Manager” parameter changes between z/OS and Distributed Websphere MQ
- **So with WMQ V6 no need for CHIN recycle**
- **Note: Some specific attributes may still require a recycle, determined on a case by case basis.**
- **Example –**
  - ALTER QMGR      ADOPTCHK(ALL)  
                         ADOPTINT(120)  
                                 ADOPTMCA(NO)  
   TCPKEEP(YES)  
   RCVTIME(X2)  
   RCVTMIN(120)

## z/OS Availability – Multiple TCP/IP stack support

- **In some recovery scenarios WMQ may be running on a different LPAR with a different TCP/IP stack**
- **In these scenarios need to be able to specify both a Listener stack and the stack that an Outbound Channel should use**
- **New CHIN parameter TCPSTACK -**
  - TCPSTACK=SINGLE
    - Restricts channels and listeners to the stack named in TCPNAME
    - CHIN will behave the same as with WMQ V5.3
  - TCPSTACK=MULTIPLE
    - Channels and listeners may bind to any available stack

## z/OS Availability – V5.3 CICS Bridge Monitor

- **The CICS Bridge provides MQ interface to legacy CICS applications**
- **With WMQ 5.3 it comes in two flavours -**
  - DPL Bridge - Link to program with data in Commarea
  - 3270 Bridge - Transaction with BMS map
    - Uses CICS Attach bridge facility
- **Bridge monitor browses queue, performs authority checks and starts a transaction to process the message.**
- **BUT .. Significant restrictions**
  - Only one bridge monitor per bridge queue
  - 3270 transactions cannot be routed to AORs
  - Reduces reliability and scalability because tied to single region
- **Some enhancements introduced in MQ 5.3.1**
  - Reply expiration, null truncation, sync on return

## z/OS Availability – CICS Bridge with WMQ V5.3

### CICSA

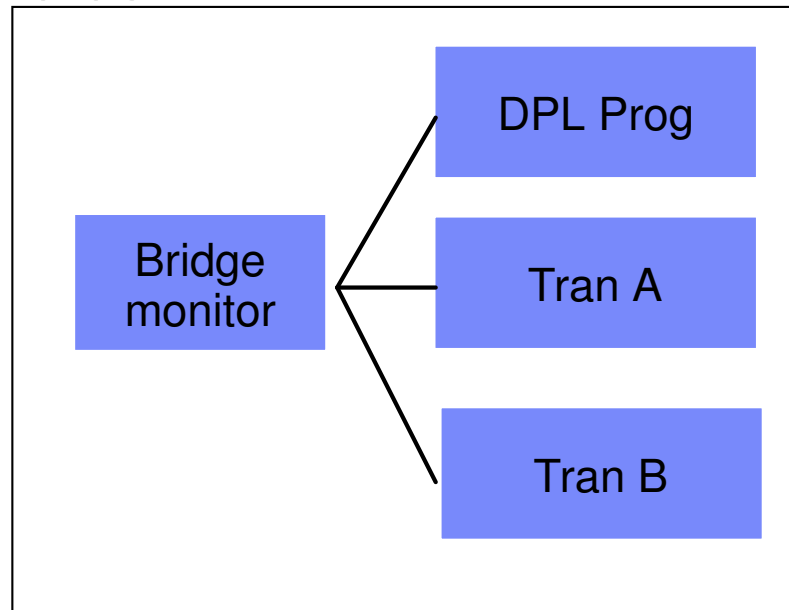

Each instance of the Bridge must have exclusive access to the Bridge Queue.

Also the form of the EXEC CICS START does NOT allow transaction routing so TRAN A and TRAN B can only run in the CICSA region.

# WebSphere MQ Bridge for HTTP

**Before** MQI, JMS, XMS

MQ Client MQPUT, MQGET MQ Server **MQ backbone** Enterprise Applications

- Applications can only connect to the MQ backbone using an MQ Client (or local Server)
- MQ Clients are free BUT their deployment can create an inhibitor to MQ adoption
  - Clients need to be installed and configured – a potential provisioning challenge for large numbers
  - They have a small footprint (Approx. 3-10 MB) – but this could still pose problems for some applications / users

**After** http://mq/queue

Web 2.0  
AJAX  
REST http://mq/queue POST, GET J2EE App Server MQPUT  
MQGET MQ Server **MQ backbone** Enterprise Applications

HTTP App MQ Bridge for HTTP

- Provides a bridge between HTTP applications and WebSphere MQ
  - Maps messages from HTTP URLs to MQ Queues and MQ Topics (provides Pub/Sub)
- Uses the HTTP/HTTPS stack on J2EE App Servers – connects via JCA
  - Works with any J2EE Server with JCA support including WAS Community Edition

**Key Benefits**

- Zero client solution for connecting to an MQ network – eliminates need for MQ client for simple access
- Easy way for Web developers that create Web 2.0, AJAX, REST Web services to connect to MQ
  - e.g. Web pages can dynamically update themselves on-the-fly using data from the MQ backbone

## z/OS Availability – V6 CICS Bridge Monitor enhancements

- **Multiple bridge monitors for single queue**
- **Transaction Routing**
- **Tolerate & return additional headers (e.g. RFH2)**
- **Honour Backout threshold and requeue queue name**
- **Error messages to CICS joblog option**
- **Optional reply to queue**
- **Enhanced passticket support**
- **Honour MQRO\_DISCARD\_MSG and MQRO\_PASS\_DISCARD\_AND\_EXPIRY**