



***The Modern Mainframe...
At the Heart of Your Business***

Consolidating Data on System z



© 2006 IBM Corporation

Why Put Data on DB2 for z/OS?

Corporate data is crucial to our next generation solutions.

Oracle RAC claims to provide a lower cost solution.



**Service Oriented Finance
CIO**

Lets see why the world's largest corporations rely on DB2 for z/OS.



IBM

DB2 Proven Success in the Finance Industry

- DB2 for z/OS is in 25 of the top 25 banks worldwide
- Why?
 - ▶ Highest Scalability – Near-linear scalability and workload management
 - ▶ Highest Availability – DB2 provides nearly continuous availability
 - ▶ Proven Security and Compliance – RACF, Encryption, DB2 Audit Management Expert
 - ▶ Better Support of Current Technology Trends – Native XML support and SAP optimization
 - ▶ Lowest overall TCO

Comparison of Data Sharing Architectures

DB2 for z/OS Centralized Sysplex Design

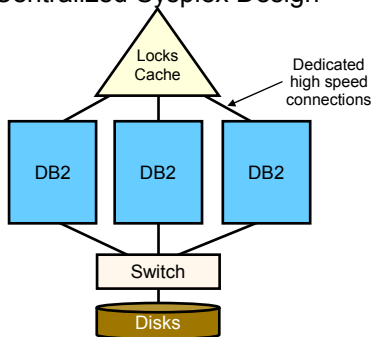

High speed centralized
lock manager in
coupling facility

Oracle RAC Distributed Lock and Data Design

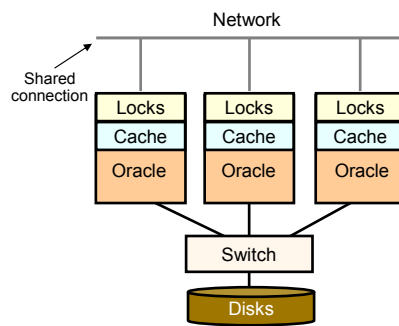

Distributed lock
management with
high messaging **overhead**

The DB2 Sysplex Design Scales Linearly

- Beyond two members, DB2 clustering overhead is low, usually between ½% and 1% for each additional image
 - ▶ Coupling facility processor handles the workload of lock and cache management
 - ▶ Hardware invalidates local copies without local processor interrupt
 - ▶ Result is near linear scale out

- Oracle RAC does not scale well beyond 4 to 6 nodes
 - ▶ The local processor overhead grows as nodes are added
 - ▶ More overhead means less transaction throughput per local processor
 - ▶ Result is limited scale out

Centralized Coupling Facility Permits Efficient Lock and Cache Management in DB2

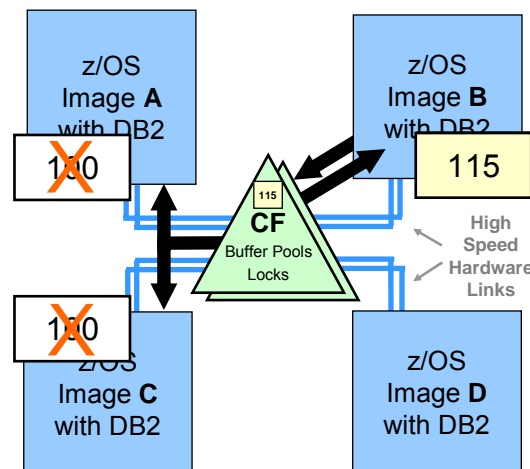

A, B, and C have read locks with local copies

1. B Obtains write lock
2. B Updates local copy
3. B Caches update in buffer pool
4. CF invalidates all cached copies without interrupting processors

Cache and locks are maintained with no inter-node disturbance!

Why is Oracle RAC Scalability Limited?

RAC Inefficiencies increase as a cluster grows

- RAC Nodes must constantly communicate to process requests to maintain distributed cache and lock data
- Adding additional nodes to the cluster results in increased inter-node communication which requires additional local processor and network time
- RAC distributed lock management overhead increases faster than the added capacity of more nodes

Let's look at some examples...

06 - Consolidating Data on System z v2.5.ppt

8

Oracle RAC: Lock Management Overhead

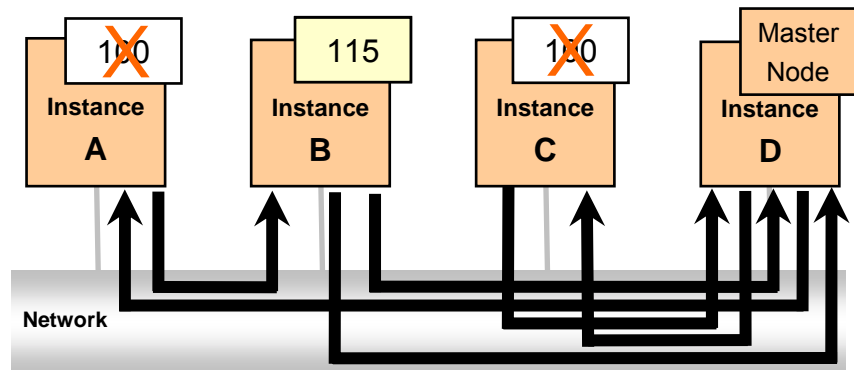

Lock Assume

7. B Updates local copy

Inter-node connections: 6

In a cluster with 4 nodes, an update operation may need 6 network connections and two in-memory calls (not shown).

Example based on Oracle's US Patent 7,107,319 B2.

06 - Consolidating Data on System z v2.5.ppt

9

Result: DB2 Scales Out, Oracle RAC is Limited

- DB2 for z/OS provides near-linear scalability with relatively little overhead as nodes are added
- With Oracle RAC, overhead increases rapidly as additional nodes are added and performance degrades after only 4 to 6 nodes

Sources: "Scale-up versus scale-out using Oracle 10g with HP StorageWorks", Hewlett-Packard, 2005

"Enterprise Data Base Clustering Solutions" ITG, October 2003

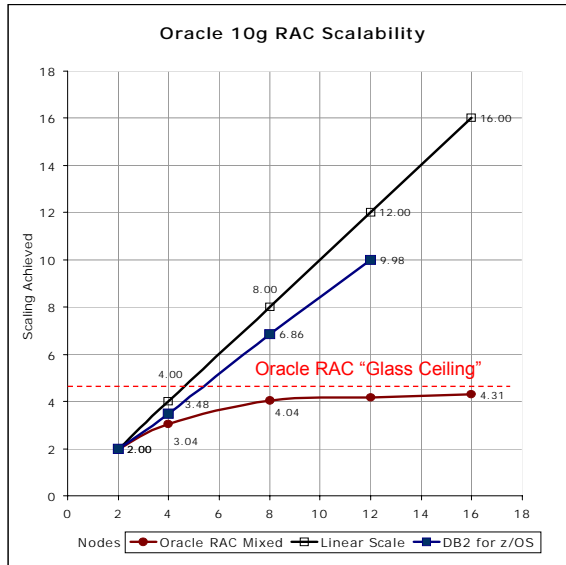

06 - Consolidating Data on System z v2.5.ppt

10

Oracle RAC Overhead Wastes Processing Power in Each Node

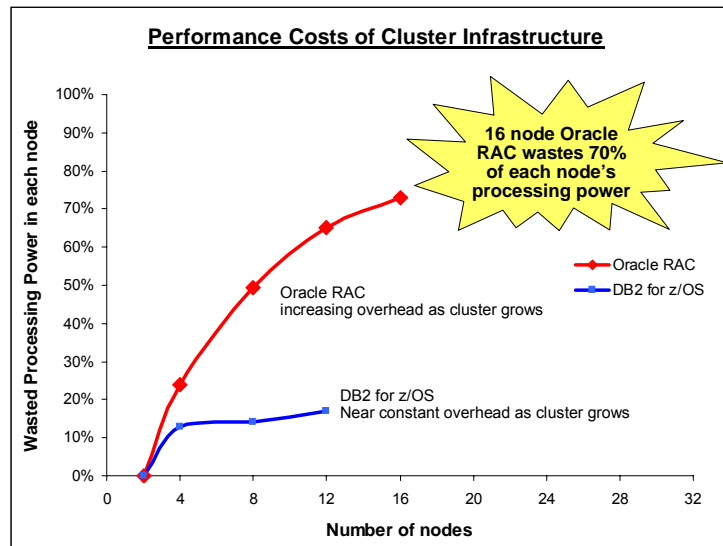

Oracle RAC source: "Scale-up versus scale-out using Oracle 10g with HP StorageWorks", Hewlett-Packard, 2005

DB2 for z/OS source: "Enterprise Data Base Clustering Solutions" ITG, October 2003

06 - Consolidating Data on System z v2.5.ppt

12

Partitioning is Necessary to Effectively Use Oracle RAC Above 4 to 6 Nodes

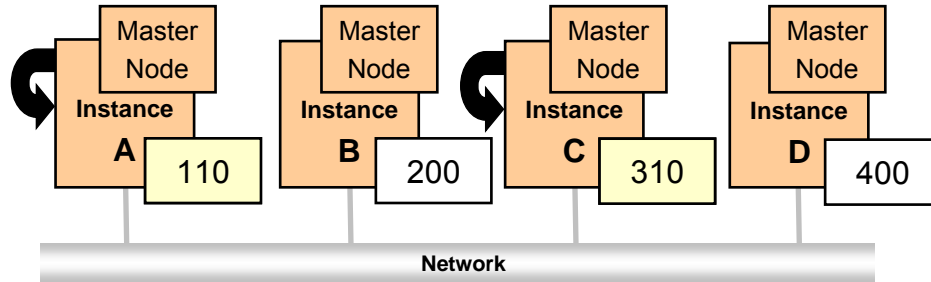

- Partitioning associates the data, buffer, and lock manager with a particular server node
- All work requests affecting the associated data partition must be executed by the owning node
- Partitioning requires a redesign and reimplementaion of the database and the application (big job on Oracle!)
- Partitioning may not always be possible depending on the workload

06 - Consolidating Data on System z v2.5.ppt

13

Fractional Availability Improvements are Important

- Fractional Improvements Result in Millions in Savings
- Financial Impact of Downtime Per Hour for financial industry is \$ 1145K
- Financial Services Company Example:
 - ▶ \$300B assets, 2500+ branches, 15M customers
 - ▶ Retail banking, loans, mortgages, wealth management, credit cards
 - ▶ CRM System – branches, financial advisors, call centers, internet
 - ▶ Number of users – 20,000+

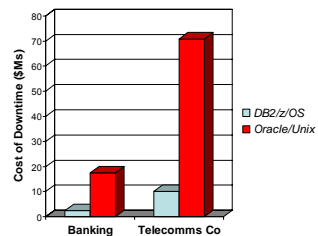

	Unix/Oracle	zSeries/DB2
Availability %	99.825%	99.975%
Annual outage	15h 20m	2h 11m
Cost of Downtime	\$17.6M	\$2.5M

\$15.1 Million dollar difference!

Sources: Picking up the value of PKI: Leveraging z/OS for Improving Manageability, Reliability, and Total Cost of Ownership of PKI and Digital Certificates by Jerald Murphy: 2007

06 - Consolidating Data on System z v2.5.ppt

16

Data Security and Compliance: DB2 for z/OS Has a Proven Track Record

DB2 for z/OS Security

- Less than 10 security related patches in the last 10 years
- Proven RACF and Multi Level Security
 - ▶ End to end security including applications disks, printers and network
- DB2 Test Database Generator
 - ▶ Ensures anonymous access to data necessary for testing
- DB2 Archive Expert
 - ▶ Allows customers to easily archive and access data
- DB2 Audit Management Expert
 - ▶ Supports compliance requirements
- End-to-end encryption via hardware assist

Oracle's Security Exposures

- **C/NET - 01/17/2007**
"Oracle plugs 51 security flaws" including **26** for database
- **ComputerWorld - 10/17/2006**
"Oracle releases 101 patches in quarterly update" including **63** for database
- **NGS Research - 11/21/2006**
"The conclusion is clear – if security robustness and a high degree of assurance are concerns when looking to purchase database server software – given these results one should not be looking at Oracle as a serious contender."
- **eWeek.com – July 2007**
45 security patches, including **17** for database

XML Usage is Increasing

- SOA
 - ▶ Web Services messages are XML
Web Services are the foundation of service oriented architecture
- Business-to-Business Integration
 - ▶ Platform-independent transport mechanism.
Business transactions may be defined in XML
- Forms and Document Processing
 - ▶ Government and legal industry require digital signature
 - ▶ Documents often contain sub-documents
Documents are increasing created and exchanged in XML

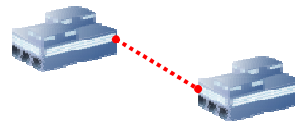

XML – The Change Is Fundamental

- Relational is a data model
 - Relations (tables)
 - Attributes (columns)
 - Set based w/ some sequences
 - Strict schema

POID	CustomerID	ItemID
12	1	2
102	3	4
102	3	5

id	LastName	FirstName	Street	City	State	Zip
1	Pirahesh	Hamid	1 Harry Rd	San Jose	CA	95141
3	Seinger	Pat	555 Bailey Ave	San Jose	CA	95141

ItemID	Name
2	#6 wire nut
5	Small Walrus
4	Apollo moon rocket

- XML is a data model
 - Hierarchical tree structure
 - Nodes (elements, attributes, comments, etc.)
 - Relationships between nodes
 - Sequence based w/ some sets
 - Flexible schema

```
<? xml version="1.0" ?>
<paymentRequest id="12345" >
  <payment>
    <payment_name>Loan</payment_name>
  </payment>
  <payee_info>
    <payee_amt>$97.85</payee_amt>
  </payee_info>
  <remitter>
    <name>John Smith Co</name>
    <address>
      <street>1234 W. Main</street>
      <city>Yonkers</city>
      <state>NY</state>
      <zip>11111</zip>
    </address>
  </remitter>
</paymentRequest>
```

DB2 9 Supports Native Storage and Retrieval of XML Data as Well as Relational Data

Use SQL/XML to access both types of data

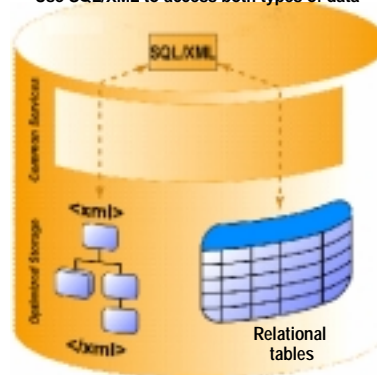

XML integrated in all facets of DB2!

New XML applications benefit from:

- Ability to seamlessly leverage relational investment
- Proven Infrastructure that provides enterprise-class capabilities

DB2 9 Has Better Support for XML

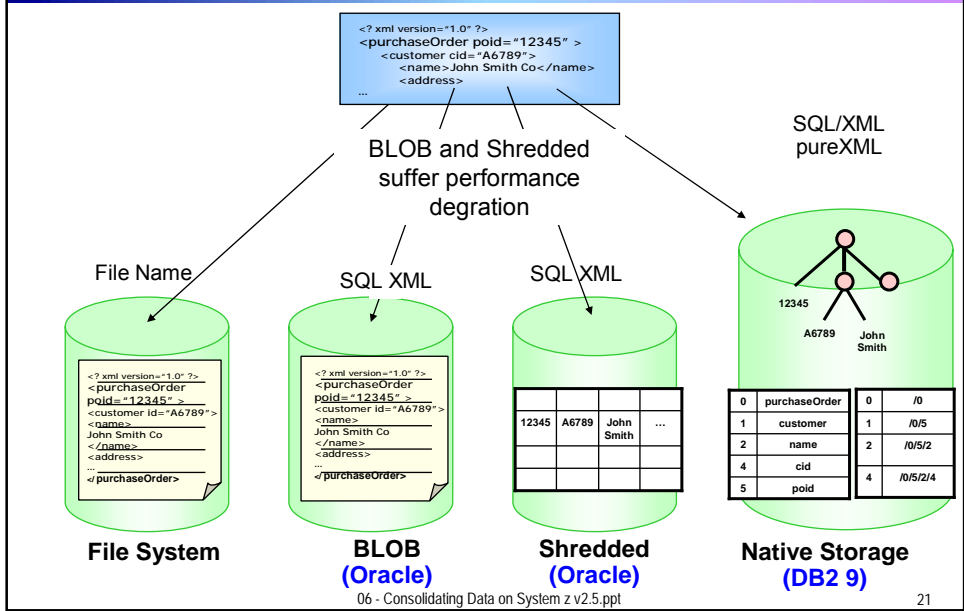

DB2 XML Performance Beats Oracle

DB2 Performance Normalized to Oracle Performance

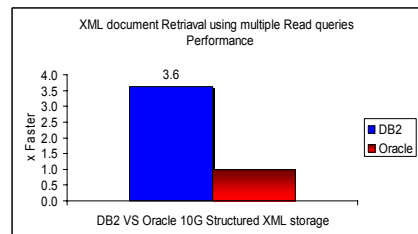
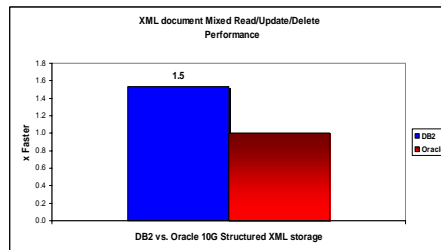
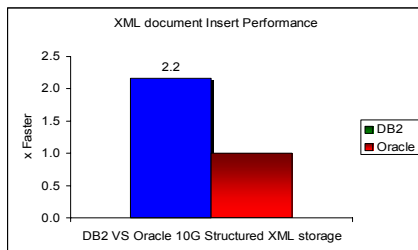

DB2 9 performs 1.5 to 3.6 times faster than Oracle 10G on XML operations

Note: Performance results are for DB2 UDB, DB2 9 for z/OS is expected to have similar results

NY Department of Taxation and Finance – Extend Data to Include XML

- NY Department of Taxation and Finance has 3600 different tax forms
 - ▶ Schema Diversity
- Typically not every field in a form is used
 - ▶ Sparse Data
- Many forms change every year
 - ▶ Schema Evolution
- A natural case for XML !
- Solution – Extend System z
 - ▶ Electronic submission with WebSphere
 - ▶ Store tax forms using DB2 native XML capabilities

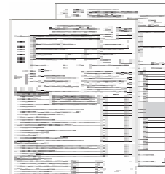
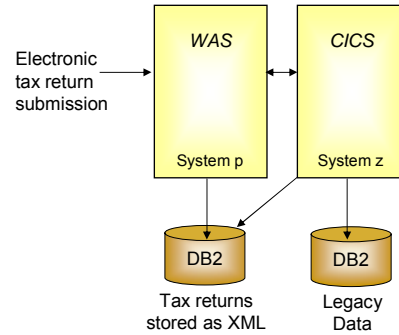

06 - Consolidating Data on System z v2.5.ppt

23

DB2 for z/OS Is Optimized to be *the* Data Server for SAP

- Partnership with SAP
 - ▶ 13 years of DB2 partnership with SAP
 - ▶ Joint development team with SAP to integrate SAP and DB2 solutions
 - ▶ DB2 for z/OS V8: more than 50 features by SAP
 - V8: more than 50 features requested by SAP
 - ▶ DB2 for z/OS V9: approximately 40 features requested by SAP
 - ▶ No unique features in SAP exploit Oracle

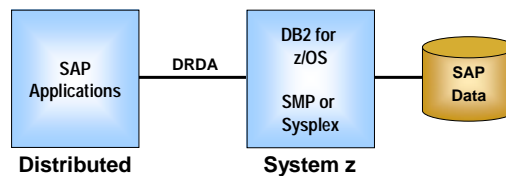

06 - Consolidating Data on System z v2.5.ppt

24

DB2 for z/OS Is Optimized to be *the* Data Server for SAP

Examples:

- Ease-of-Use
 - ▶ Easy to clone DB2 instances, such as test environment
 - ▶ Customized SAP 'Tuner'
- Less DBA skills and activities required
 - ▶ Large Object Management, SAP uses large objects a lot
 - ▶ DB2 Recovery Expert for automatic recovery and backup
 - ▶ Real-time Statistics Utility provides automatic scheduling information
 - ▶ BACKUP and RESTORE system enhancements
- SAP-specific enhancements to DB2 Query Optimizer
 - ▶ Enhancements for SAP Business Intelligence query performance
 - ▶ Enhancements for SAP OLTP products
- High Performance
 - ▶ SAP Business Warehouse performance gains through Dynamic Index ANDing

06 - Consolidating Data on System z v2.5.ppt

25

North American Retailer Saves by Licensing DB2 from SAP

- OEM agreement allows for DB2, DB2 Utilities and DB2 connect for restricted use
- DB2, Utilities and DB2 connect only



298 MSU's dedicated
2094-704 z9

	Full Use Software from IBM over 3 years			Restricted Use Software from SAP
	DB2	DB2 Utilities	DB2 Connect	SW bundle
MLC	\$1,334,520			n/a
OTC		\$92,880	\$91,287	\$458,648
S&S		\$41,796	\$36,515	\$233,913
3 Year Costs	\$1,596,997			\$692,561
Savings of over \$900K and 57% for Data Serving on System z!				

SAP OEM Savings

Get More Business Results Out of Your Data

Our branch offices have separate databases.
Each branch is analyzing customers and sales on their own.



Service Oriented Finance
Marketing

Looking at data in isolation can miss larger trends and opportunities



IBM

06 - Consolidating Data on System z v2.5.ppt

27

Service Oriented Finance Needs a Data Warehouse to Make Optimal Business Decisions

- Each branch is responsible for its own marketing campaign
- Corporate marketing gets reports from each of the branches based on local results
- Corporate marketing needs to spot trends to know what campaigns are most effective region-wide
- A corporate data warehouse would give marketing the data to easily do comparisons between the branches and promote best practices

06 - Consolidating Data on System z v2.5.ppt

28

Use DB2 for z/OS to Build Your Corporate Data Warehouse

Performance features for Data Warehouse solutions

- Parallel Queries
 - ▶ Exploit multiple processors if available
- Materialized query table
 - ▶ Save and reuse previous partial query results
- Star Schema Join Enhancement
 - ▶ Performance enhancements for typical data warehouse accesses

06 - Consolidating Data on System z v2.5.ppt

30

Use WebSphere DataStage to Load Your Data Warehouse From the Branches

- Data Transformation and Movement
 - ▶ Extract data from source
 - ▶ Transform data
 - ▶ Load data into data warehouse
 - ▶ DataStage Designer tool creates DataStage **ETL** jobs

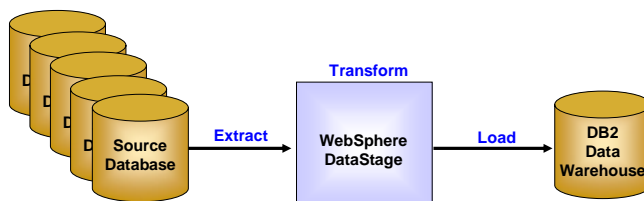

06 - Consolidating Data on System z v2.5.ppt

33

Data Stage Transforms Data on the Fly

Different field names
 Different field order
 Add Branch Identifier
 Different currency format



PROD ID	CUST ID	BRANCH ID	QTY	AMT	SALEDATE
000 101	100	01	01	10,000.00	2007-02-28
000 121	100	01	03	500.50	2007-02-28
000 101	101	01	01	20,000.00	2007-03-01

Data Warehouse



Transform

PRODUCT	QTY	CUSTNO	AMOUNT	DATE

Branch Data

DEMO: Run DataStage ETL Job

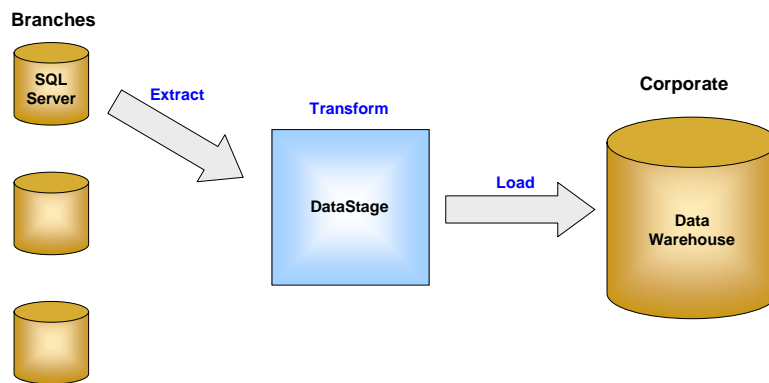

US Retailer Improves Response Time by Collocating OLTP and DW Databases

- A major US retailer moves their data warehouse from distributed servers to System z9
- On average they reduce query processing times by 80% (17 minutes to 3 minutes)
- They save CPU cycles in avoiding TCP/IP traffic to build the data warehouse on distributed
- This customer has 5.5TB data warehouse and front-ends it with **MicroStrategy** and **SAS**

06 - Consolidating Data on System z v2.5.ppt

39

DB2 for z/OS Has the Lowest TCO

Capability is important, but cost is a big concern for us



On Demand Bank
CIO

DB2 for z/OS costs less than Oracle RAC



IBM

06 - Consolidating Data on System z v2.5.ppt

40

Storage Costs: DB2 Provides More Storage Savings than Oracle

- DB2 for z/OS lowers TCO by reducing storage needed
 - ▶ TPC-H Benchmark: DB2 compression of 59% vs 29% for Oracle RAC

- Storage savings with DB2 vs. Oracle for a 100TB data base

	Oracle	DB2 for z/OS*
Storage System	HP XP12000 Storage	IBM System Storage DS8100
Overall database compression ratio (using TPC-H benchmark results)	29%	59%
For 100 TB uncompressed data storage needed	75 TB of HP Storage	42 TB of IBM Storage
Cost of storage	\$3.33M (\$3.1M + \$0.225M**)	\$1.45M
With compression, storage for DB2 costs <u>56% less</u> than for Oracle		

- * DB2 for z/OS achieves similar compression ratios to those of DB2 for LUW
- ** HP Storage Software charge

06 - Consolidating Data on System z v2.5.ppt

41

New zIIP Processor Dramatically Lowers Cost

What Workloads Can Be Run on a zIIP?

- How much DB2 workload can typically be run on a zIIP?
 - ▶ Queries received via DRDA Remote Access Protocol (**Database Server scenarios**)
 - Up to 40%
 - ▶ Parallel queries (**Data Warehouse scenario**)
 - Up to 80%
 - ▶ Some of **index maintenance** utilities

- Offloads to zIIP specialty processor reduce DB2 load and charges on general purpose processors
 - ▶ For sub capacity pricing, the offload must occur at a time that will reduce billable rolling average

- IBM has tools to help customers estimate their off load potential

06 - Consolidating Data on System z v2.5.ppt

42

Case Study: Consolidate Data Server For SAP On Mainframe With Disaster Recovery

Existing Mainframe



Existing processors:
9 general purpose
4000 MIPS of existing
DB2 workload

Existing Disaster Recovery Site



Existing processors:
Pay for one general
purpose processor
for hot disaster
switch over and eight
"dark" DR processors
at \$30K

Add 1 LPAR for New SAP Data Server w 42 TB Storage

Prod

966 MIPS additional workload

Add two processors:
1 zIIP
386 MIPS (40%)
1 General purpose
580 MIPS (60%)

Or add HP Integrity rx8640 Server w 75 TB storage

Prod



16 Chip
32 Core

84,042 RPE's

And Add Disaster Recovery

Prod

Pay for Capacity Backup
2 processors
\$30K each

And Add Disaster Recovery w 75 TB storage

Prod



16 Chip
32 Core

84,042 RPE's

3 year cost of acquisition \$5.19 M

3 year cost of acquisition \$10.90 M

** Production RPE's required = 966 x 87 = 84,042*

06 - Consolidating Data on System z v2.5.ppt 43

SAP Data Server With Disaster Recovery Incremental Cost Breakdown

Mainframe Incremental Hardware				Mainframe Incremental Software			
OTC		ANNUAL		OTC		ANNUAL	
1 General Processor	\$1,452,500	Processor Maintenance * (For year 2, 3)	\$80,868	Storage SW	\$281,588	DB2 MLC x12	\$33,840
1 zIIP Processor	\$125,000					zOS MLC x12	\$34,944
2 DR Processors	\$60,000						
IBM Storage (42TBx2)	\$2,899,602	Storage Maintenance	0				
TOTAL	\$4,537,102	TOTAL	\$80,868 (year 2, 3)	TOTAL	\$281,588	TOTAL	\$68,784

Distributed Incremental Hardware				Distributed Incremental Software			
OTC		ANNUAL		OTC		ANNUAL	
HP Processors	\$1,207,878	Processor Maintenance (prepaid in year 1 for 3 years)	\$82,093	Oracle EE	\$1,280,000	Oracle S&S	\$281,600
HP storage (75TBx2)	\$6,214,938	Storage Maintenance	\$61,902	Unix	\$252,096	Unix S&S	\$71,637
				Storage SW	\$450,200		(Prepaid in year 1 for 3 years)
TOTAL	\$7,422,816	TOTAL	\$308,180 (year 1) \$61,902 (year 2, 3)	TOTAL	\$1,982,296	TOTAL	\$496,512 (year 1) \$281,600 (year 2, 3)

** Mainframe Processor Maintenance includes the maintenance for general purpose processors and specialty engines*

06 - Consolidating Data on System z v2.5.ppt 44

Disaster Recovery is Expensive With HP/Oracle

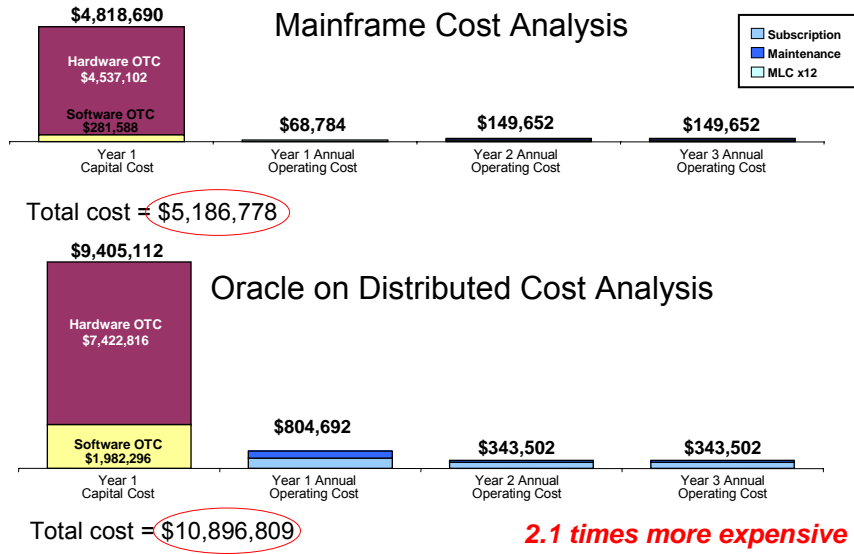

06 - Consolidating Data on System z v2.5.ppt

45

SAP Data Server With Disaster Recovery – Mainframe Costs Are Lower Regardless of Data Server Size

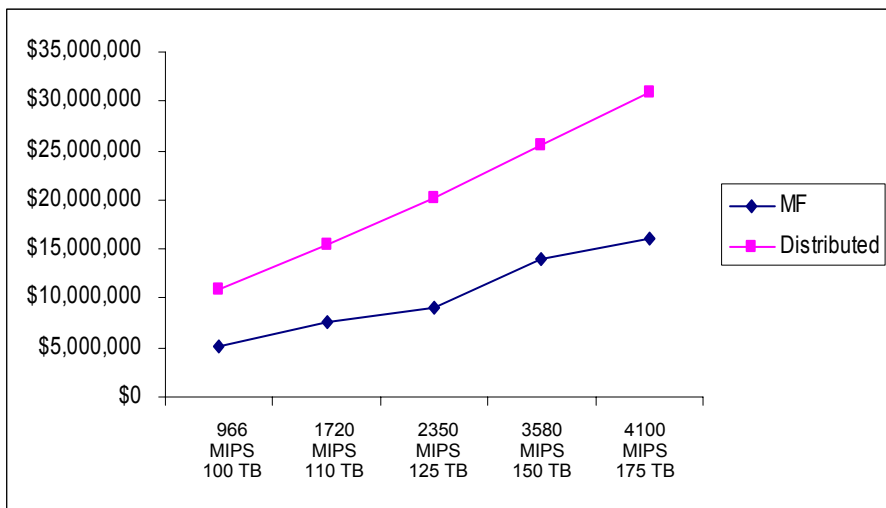

06 - Consolidating Data on System z v2.5.ppt

46

Case Study: Consolidate New Data Warehouse Application on Mainframe With Disaster Recovery

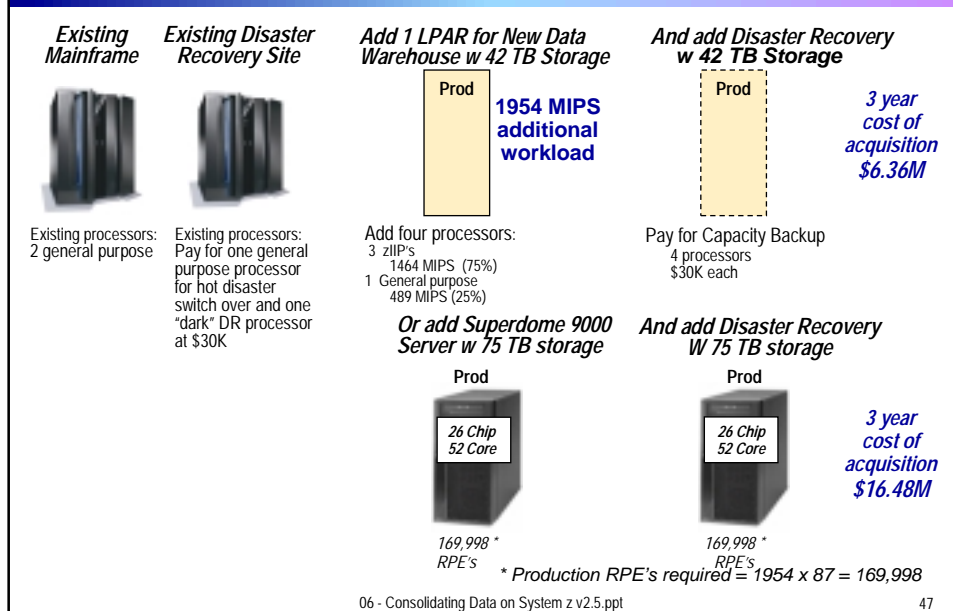

The World Relies on DB2 for System z – You Can Too

- Over 10,000 Licenses World Wide
- Over 8 Million Clients
- Over 3,000 TBs of Production Data
- Over 700 ISV Applications and Packages
- Owns 96% of Relational System z Market Place

