

Delivering Enterprise Scale with Cognos 8 for Linux on System z

Presenter: Mike Biere
IBM WW Marketing Mgr.
IBM Silicon Valley Lab
mbiere@us.ibm.com
Session: 007

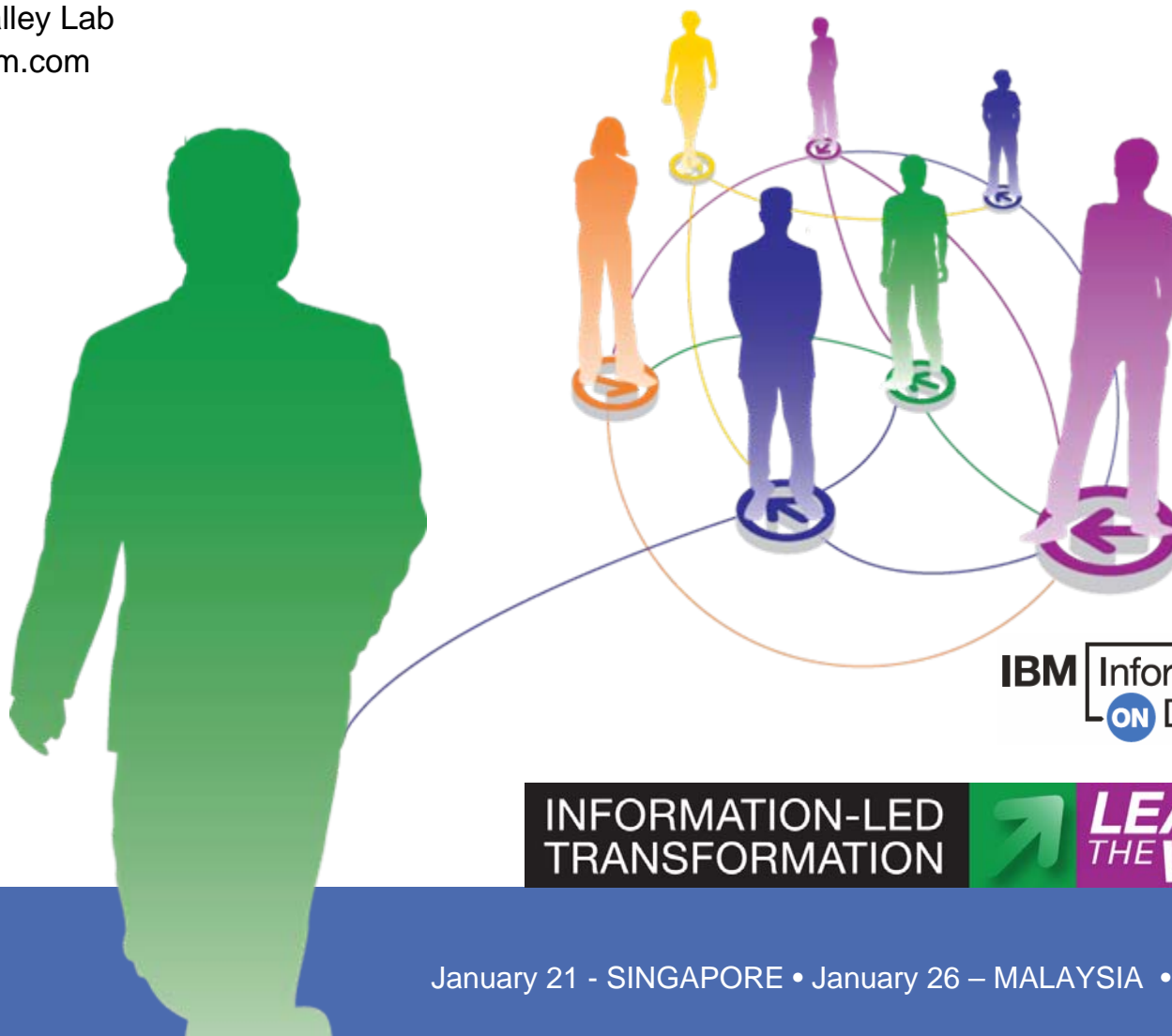

IBM Information
ON Demand 2010

INFORMATION-LED
TRANSFORMATION



LEAD
THE WAY



IBM

January 21 - SINGAPORE • January 26 – MALAYSIA • January 28 - THAILAND

Disclaimer

© Copyright IBM Corporation [current year]. All rights reserved.

U.S. Government Users Restricted Rights - Use, duplication or disclosure restricted by GSA ADP Schedule Contract with IBM Corp.

THE INFORMATION CONTAINED IN THIS PRESENTATION IS PROVIDED FOR INFORMATIONAL PURPOSES ONLY. WHILE EFFORTS WERE MADE TO VERIFY THE COMPLETENESS AND ACCURACY OF THE INFORMATION CONTAINED IN THIS PRESENTATION, IT IS PROVIDED “AS IS” WITHOUT WARRANTY OF ANY KIND, EXPRESS OR IMPLIED. IN ADDITION, THIS INFORMATION IS BASED ON IBM’S CURRENT PRODUCT PLANS AND STRATEGY, WHICH ARE SUBJECT TO CHANGE BY IBM WITHOUT NOTICE. IBM SHALL NOT BE RESPONSIBLE FOR ANY DAMAGES ARISING OUT OF THE USE OF, OR OTHERWISE RELATED TO, THIS PRESENTATION OR ANY OTHER DOCUMENTATION. NOTHING CONTAINED IN THIS PRESENTATION IS INTENDED TO, NOR SHALL HAVE THE EFFECT OF, CREATING ANY WARRANTIES OR REPRESENTATIONS FROM IBM (OR ITS SUPPLIERS OR LICENSORS), OR ALTERING THE TERMS AND CONDITIONS OF ANY AGREEMENT OR LICENSE GOVERNING THE USE OF IBM PRODUCTS AND/OR SOFTWARE.

Abstract

- When you choose to use IBM System z as your platform of choice for your IBM Cognos 8 Business Intelligence (BI) deployment, you are choosing to simplify the management and maintenance of your enterprise BI infrastructure.
 - This session will help you determine when BI on System z is a good strategy for your organization.
 - You'll learn best practices for deploying IBM Cognos 8 BI for Linux on System z in large scale environments, including how to configure zLinux and IBM z/VM to support optimal IBM Cognos 8 performance and use of System z resources.
 - The session also addresses scalability, reliability and security requirements.

Agenda

1. The state of the market
2. Why IBM
3. The value of leveraging System z for a Cognos 8 BI deployment
4. The best practices for deploying Cognos 8 BI to leverage the value of System z
 - Virtualization Layers w/ System z
 - Cognos 8 Architecture
 - Cognos 8 Deployment on System z

Observations from 31 years of BI

- Earlier stages were often more organized (centralized control, competency centers, tighter control of data access)
- The emergence of PC tools and client/server architectures offered many choices that have not proven to be cost effective
- Most enterprises have been permissive about the number of BI tools (approved lists etc.) with little internal guidance
- Customers today complain about the number of BI tools in house but feel trapped by the user populations
- Movement toward centralized control as BI tools have become more 'thin' and integrated suites are emerging in the industry
- Everyone talks about an enterprise mission yet few accomplish it due to internal complexities

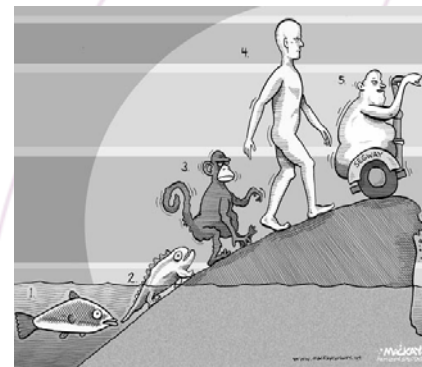

Analysts Predict Move to Right-Time BI

By 2012, BI Platform capabilities will be embedded as a service within **75% of new business applications**.

By 2012, emerging technologies will significantly drive adoption of **BI to 50% of business users**

(e.g. interactive visualization, in-memory analytics, search, SaaS and SOA)

Source : Gartner BI Summit 2008, 4/2008

As increased usage & growth occur, what is the plan to accommodate them?



Embedded Analytics

Dashboards

Mash ups

Financial Planning

Scorecards

Organization Moving Towards BI Standardization

- A reduced set of BI tools
- Interlocking information sources
- An 'information agenda' – how and what data will be necessary for analysis
- An infrastructure to support these goals
- Strategy and standard for scale and deployment
- Common, well understood goals and mission

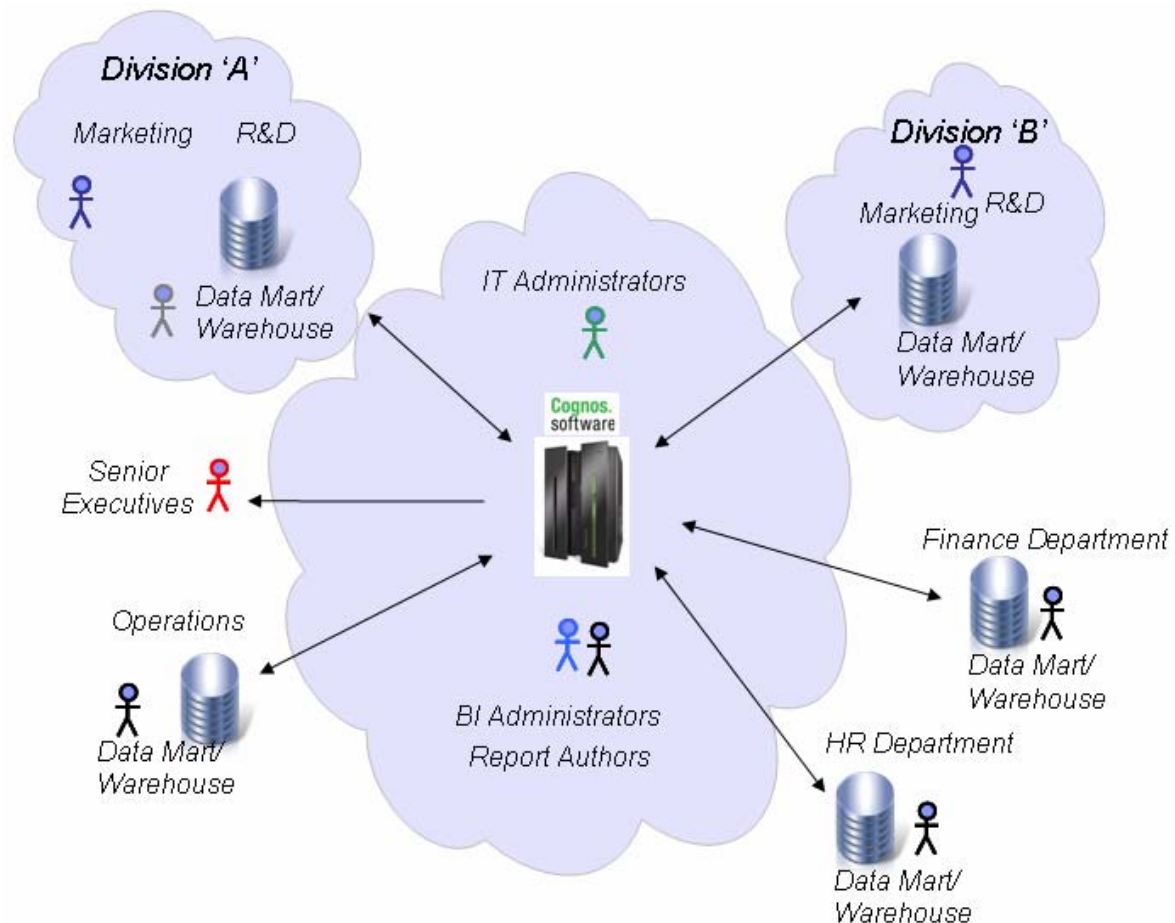

Benefits of BI at the Enterprise Level

- Rapid, accurate decision making
- Rapid deployment and higher penetration of BI usage
- Confidence in the accuracy and quality of the data
- Information in a right-time mode timed to address the business issues not an artificial time table
- Lower TCO - reduced costs (servers, power, staff, annual maintenance)
- Validation of BI analytics at all levels (sharing information across corporate entities will tend to force this)
- Higher leverage of existing skills



IBM is investing to accelerate your information-led transformation

Over **\$12B** in software investments since 2005

Over **4,000** Dedicated Consultants

Analytics in a Box to Accelerate Time to Value

Largest Math Department in Private Industry

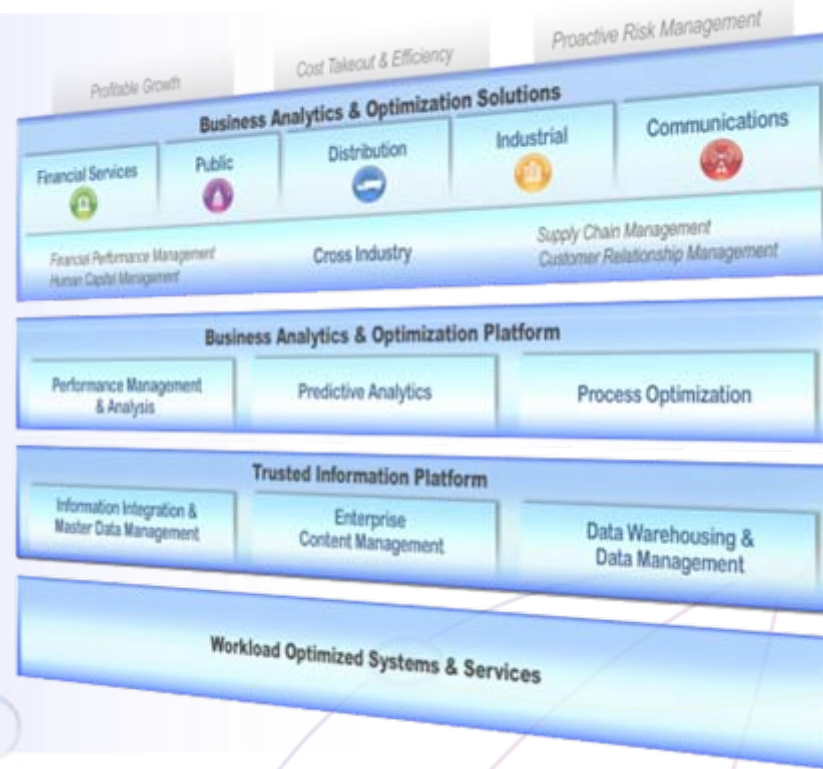

“Since 2006, IBM has deliberately & doggedly constructed an unparalleled portfolio... it's difficult to see how any competitors will be able to compete anytime soon...”



“IBM, not SAP or Oracle, is now the industry's premo analytics solution/platform vendor...”

The IBM Solution: IBM Information Server

Delivering information you can trust

IBM Information Server

Unified Deployment

Understand



Discover, model, and govern information structure and content

Cleanse



Standardize, merge, and correct information

Transform



Combine and restructure information for new uses

Deliver



Synchronize, virtualize and move information for in-line delivery

Unified Metadata Management

Parallel Processing

Rich Connectivity to Applications, Data, and Content

InfoSphere Warehouse on System z

- ➔ Adds core data warehouse and analytics capability to DB2 for z/OS
 - Advanced physical database modeling and design
 - in-database data movement and manipulation capabilities of SQL Warehouse Tool (SQW)
 - Optimize multidimensional reporting and analysis of data with Cubing Service
- ➔ Additional capabilities available as part of a broad System z Solution
 - Cognos 8 BI
 - InfoSphere Data Architect
 - Information Server
 - MDM Server
 - Industry Data Models

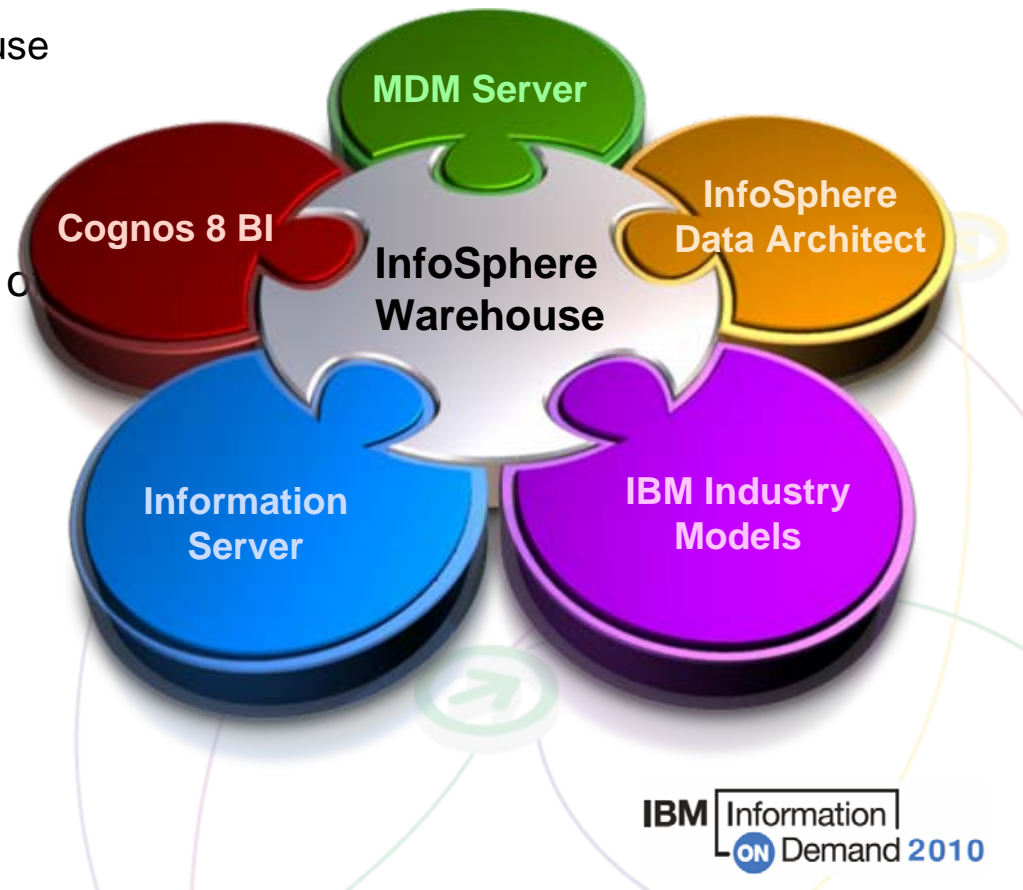

IBM Cognos 8 BI for Linux on System z

**Broad
Range of BI
Capabilities**

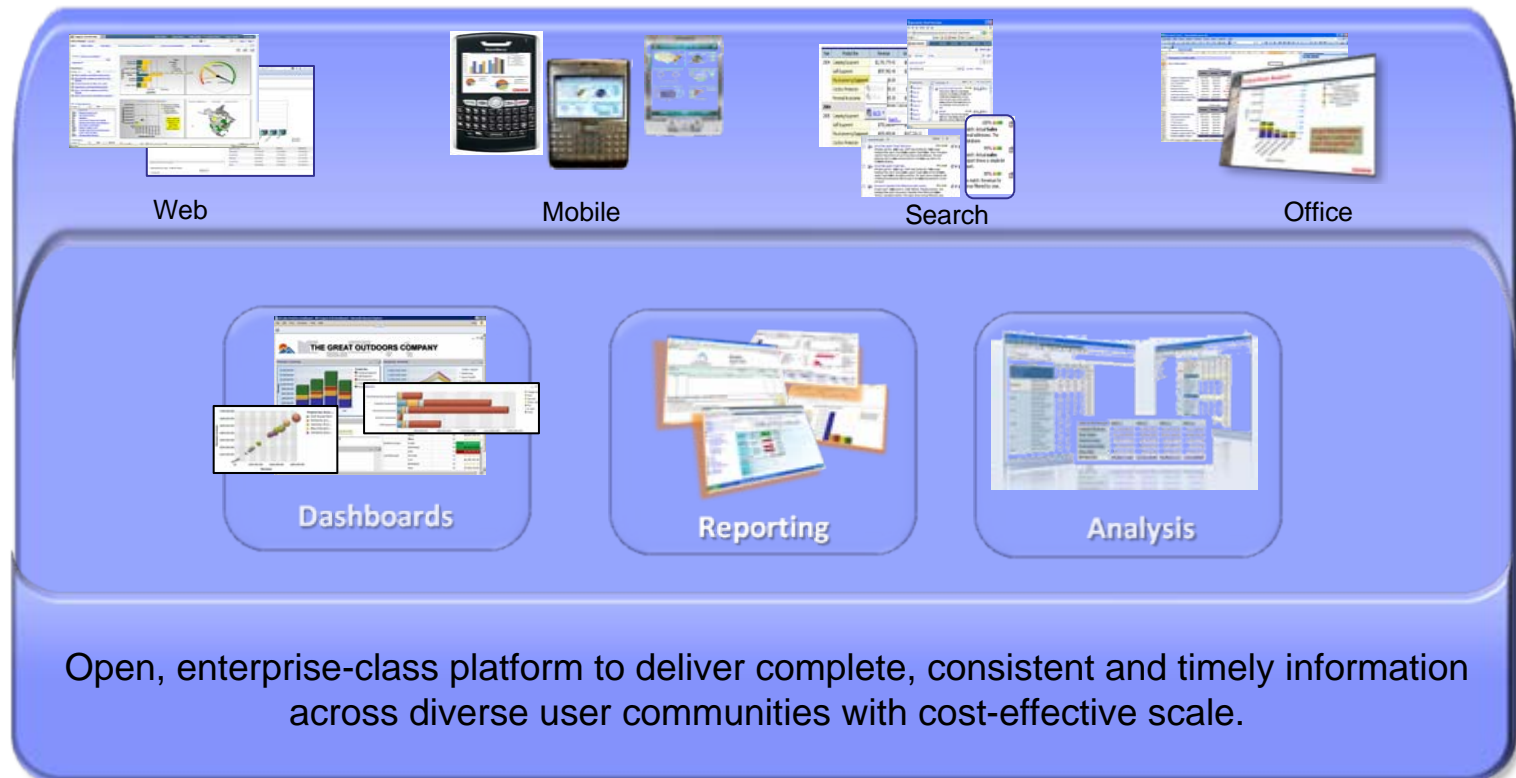

**Open
Enterprise-
class Platform**

**Proven
technology
leadership
with IBM**

IBM System z

Delivering a cool, dynamic Business Intelligence Infrastructure on System z and IBM Storage

An SOA to deploy successfully within changing environments

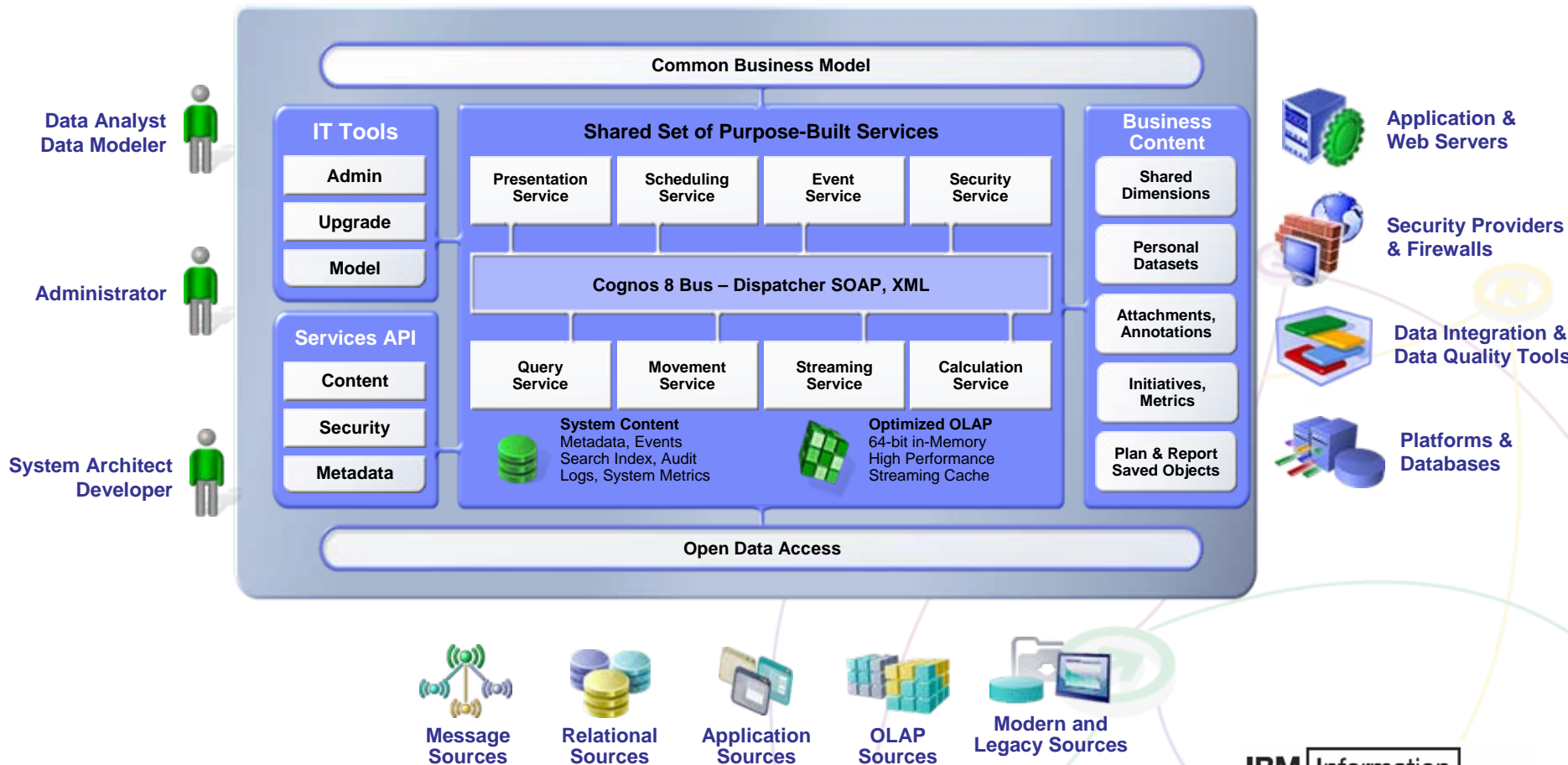

Why Leverage System z for your Enterprise BI?

- A significant savings in the:
 - Hardware,
 - Software,
 - Operating and
 - People costs
- Faster time to value:
 - A reduction in the time and speed associated with deploying BI
- Industry leading
 - Scalability,
 - Reliability,
 - Availability and
 - Security
- Simplified and faster access to the data on System z.

Cost Savings

Your IT Cost may vary:

Up to 80% Saving in IT Cost

→ Up to 96% Less Hardware

760 x86 Processor Cores vs 26 IFLs

→ Potential for dramatic reductions in software expense for processor based licenses

→ Potential reductions in power and cooling

Up to 93% Savings in KWatts and Energy Costs in this scenario

→ Up to 46% Less Space

→ Up to 89% People savings

→ Increased processor utilization

→ Industry leading Security

Energize your IT savings with z10 EC.

**Consolidating 760 Linux servers
z/VM Virtualization versus x86
Oracle DB Workload
3-Year Total IT Cost**

**\$56 M Savings versus
x86 without Virtualization**

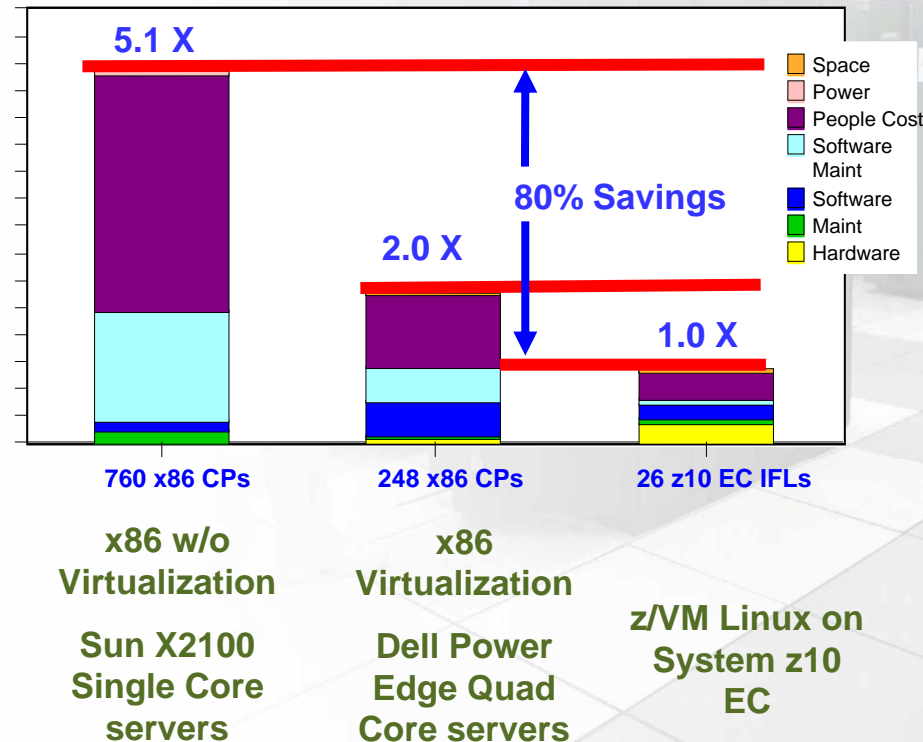

Faster Time to Value



- A z10 EC mainframe with z/VM can create a new virtual image in 10 seconds to run a new application on hardware that you already own.
- Forward binary capability for new generations. Multiple image maintenance is much faster.
- x86 Virtualization products can virtualize quickly, to a point. Extending capabilities: When will you run out of images or need a new server? Speed and ease of deploying logical and physical servers? Technology refresh?
- Ordering and installing a new x86 server can take days or weeks. Lots of effort going to a new generation of server and operating system.

System z with z/VM speeds server positioning and gives on demand flexibility

Scalability



IBM System z

Testing demonstrated IBM Cognos 8 BI for Linux on System z **scales linearly** to large user groups.

Linear Scalability
IBM Cognos 8 BI for Linux on System z

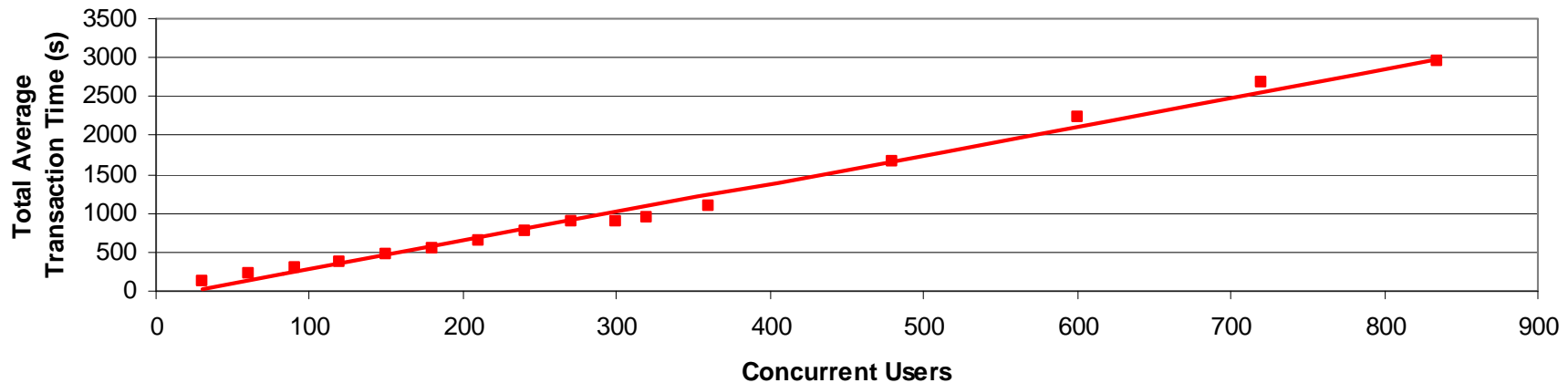

“Cognos, ...makes it easy for companies to deploy BI and PM to a broader user population, while minimizing the resulting workload for IT departments.”

- Nucleus Research, Cognos Takes on the Rest of the Enterprise, November, 2007

- Testing was conducted on up to **90,000 named users**

Reliability and Availability

→ Operate without failure

- Automatic failure or potential failures detection
- Instructions are executed 2x and compared

→ Operate in a non-disruptive mode

- The Five 9's of availability ... top in the industry
- Non-disruptive upgrade path
- Changes are applied online while the system is operating
- Hipersocket processing of data makes new information more readily available



Security

System z - LPARs and Operating Systems

- Security built into OS and hardware
- EAL5 certification for IBM eServer zSeries 900 (z900), z990, and IBM System z9, z10 EC
- EAL4+ certification for z/OS 1.9 with RACF®
- EAL4+ certification for Linux for System z
- EAL4+ certification for z/VM 5.3 with RACF®
- Cryptographic support



**Security for virtualizing sensitive and mission critical workloads.
Reliability, Availability and Serviceability for world-class Quality of Service.**



Simplified and Faster Access to the Data on System z

- Proven Work Load Manager that automatically monitors and apportions system resources to all processes, “BI, queries, OLTP, etc,” based upon defined business service rules and authorizations
- Quick replication of transactional data to the BI data warehouses or marts on System z for rapid access
- Co-location of data with the Cognos solution to provide the simplest, shortest and fastest path to and from the data



The Best Practices for Deploying Cognos 8 BI to Leverage the Value of System z

- Virtualization Layers w/ System z
- Cognos 8 Architecture
- Cognos 8 Deployment on System z

The Best Practices for Deploying IBM Cognos 8 BI to Leverage the Value of System z

- Virtualization Layers w/ System z
- Cognos 8 Architecture
- Cognos 8 Deployment on System z



Virtualization Concepts

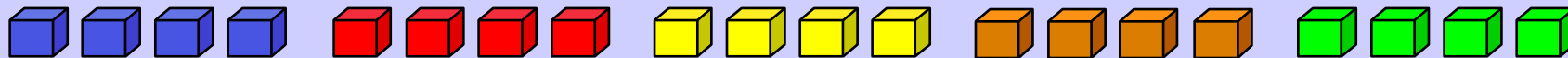

Virtual Resources

- Proxies for real resources: **same interfaces/functions, different attributes.**
- May be part of a physical resource or multiple physical resources.

Virtualization

- Creates virtual resources and "maps" them to real resources.
- Primarily accomplished with software and/or firmware.

Resources

- Components with **architected interfaces/functions.**
- May be centralized or distributed. Usually physical.
- Examples: memory, disk drives, networks, servers.



- Separates presentation of resources to users from actual resources
- Aggregates pools of resources for allocation to users as virtual resources



The Power and Flexibility of System z Virtualization

- Over 40 years of continuous innovation in virtualization technologies
- Architecture designed and optimized for resource **over commitment**
- Multiple images concurrently share all physical CPU and I/O resources
- Resources delivered **as needed, automatically**, based on business-oriented goals
- New OS images can be started without affecting ongoing work
- Hardware assists used to accelerate virtualization operations (e.g., SIE)

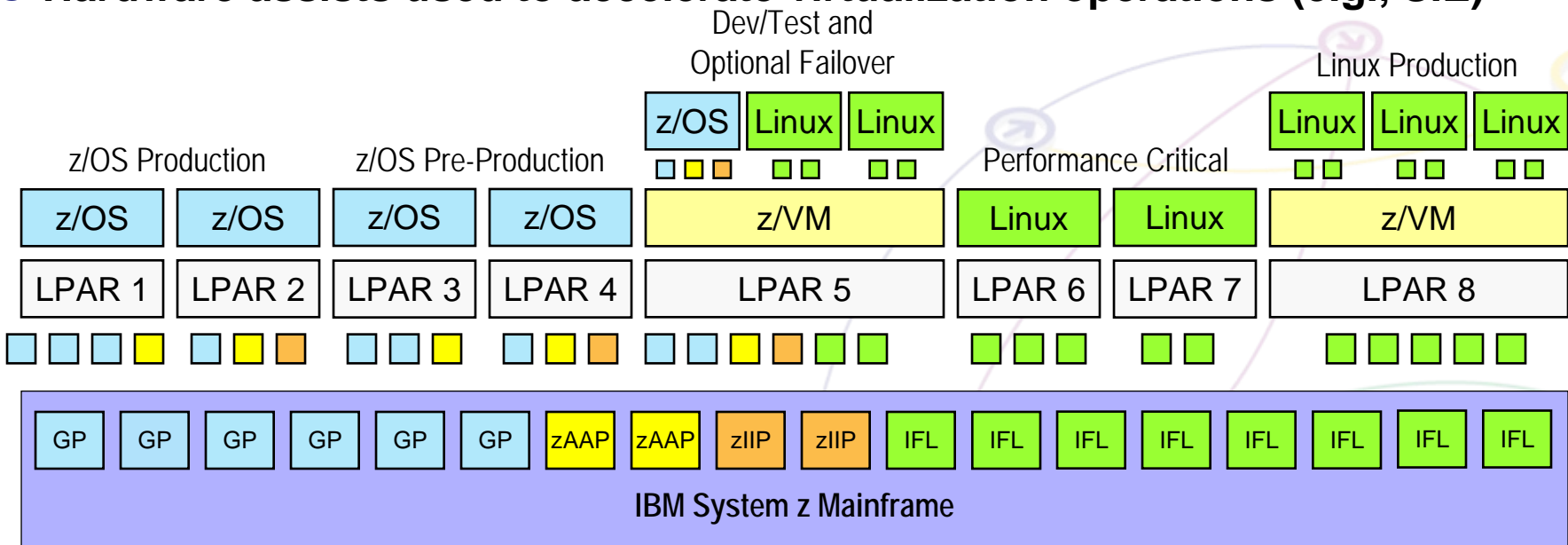

IBM System z Virtualization Leadership

Extreme Levels of CPU Sharing

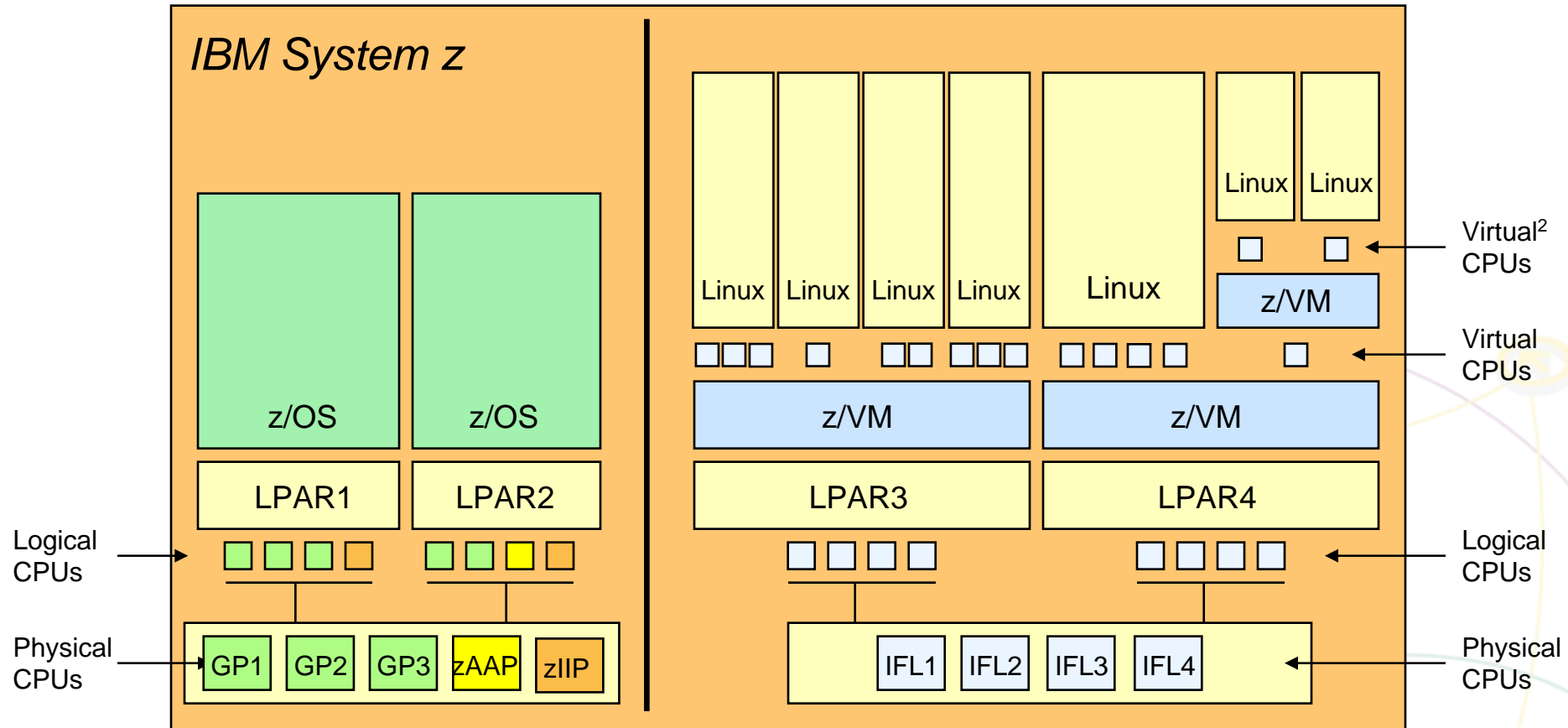

The Best Practices for Deploying IBM Cognos 8 BI to Leverage the Value of System z

- Virtualization Layers w/ System z
- Cognos 8 Architecture
- Cognos 8 Deployment on System z

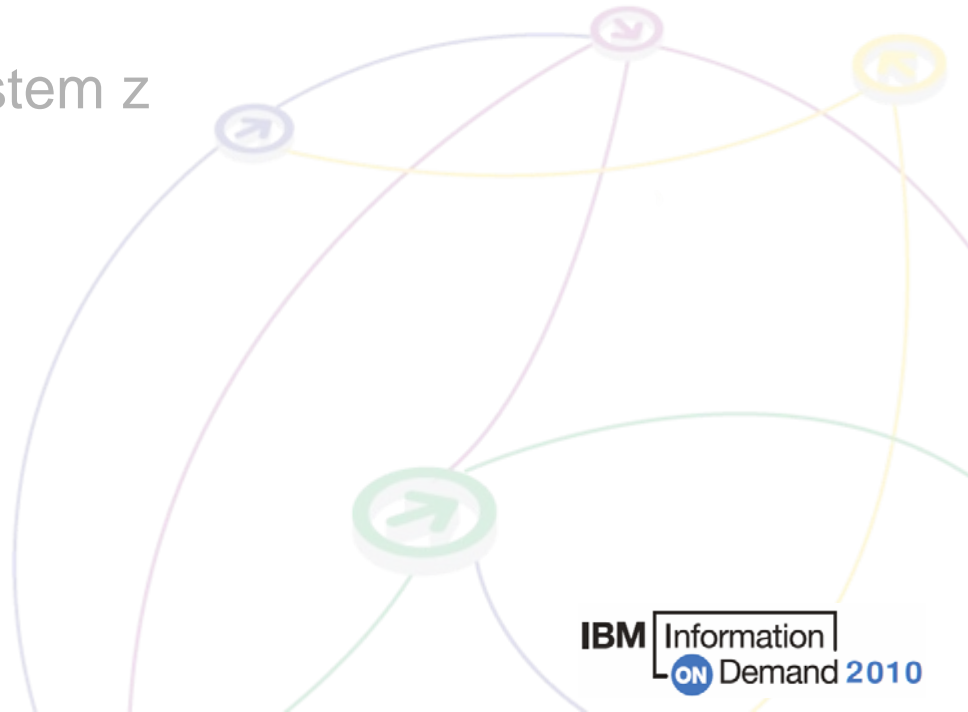

IBM Cognos 8 BI Architecture

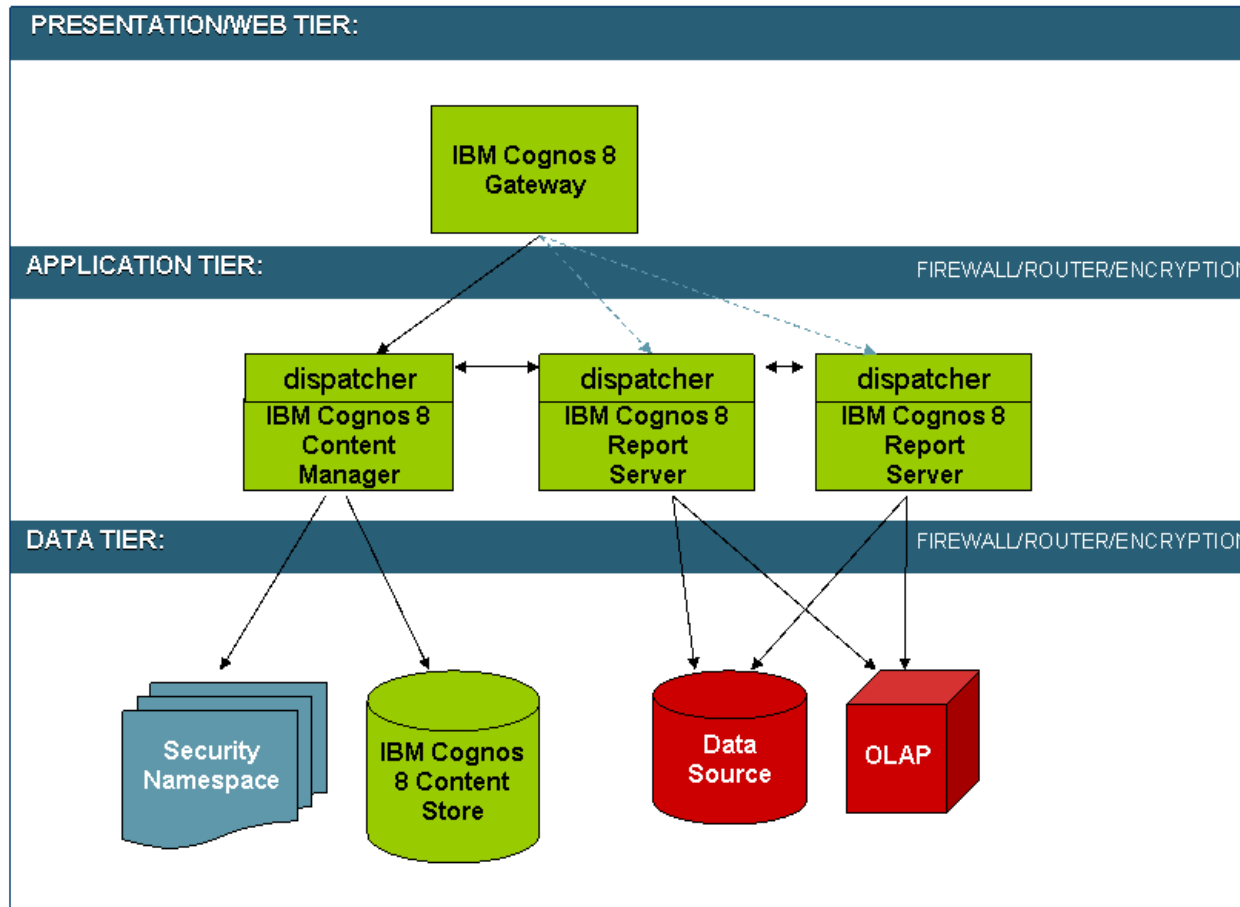

The Best Practices for Deploying IBM Cognos 8 BI to Leverage the Value of System z

- Virtualization Layers w/ System z
- Cognos 8 Architecture
- Cognos 8 Deployment on System z

Sample IBM Cognos 8 BI v4 CPU Usage

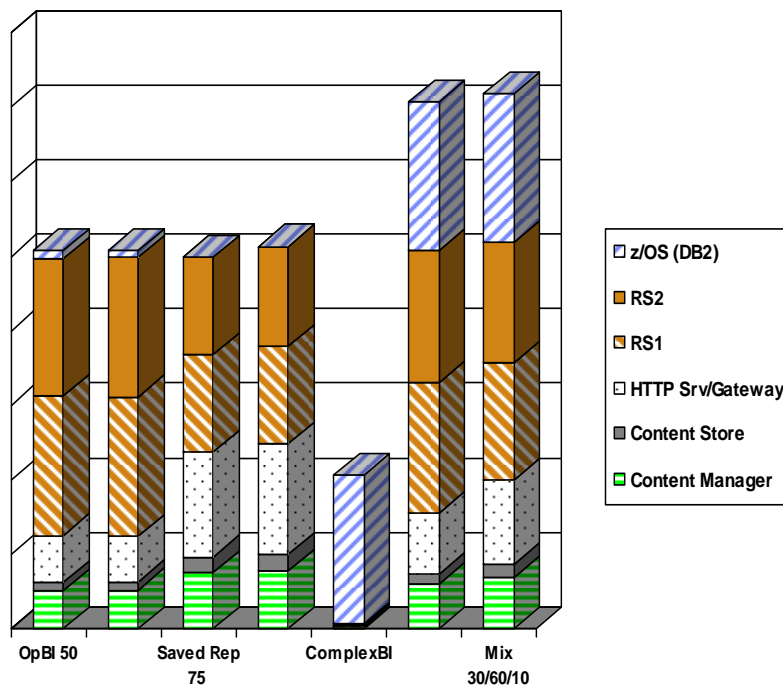

- CPU usage dependent upon application requirements and Cognos implementation
- Individual Cognos component server utilization varies significantly
- Unused capacity likely exists in some Cognos server components
- Virtualization may improve utilization of unused capacity

Cognos 8 BI Deployments on System z

Building Blocks

- IBM Cognos 8 BI for Linux on System z
- 31-bit WebSphere for Linux on System z
- DB2 or Oracle 10g
- 64-bit Linux
- z/VM
- LDAP optional

Sample Cognos 8 BI for Linux-in-z/VM IFL Configuration

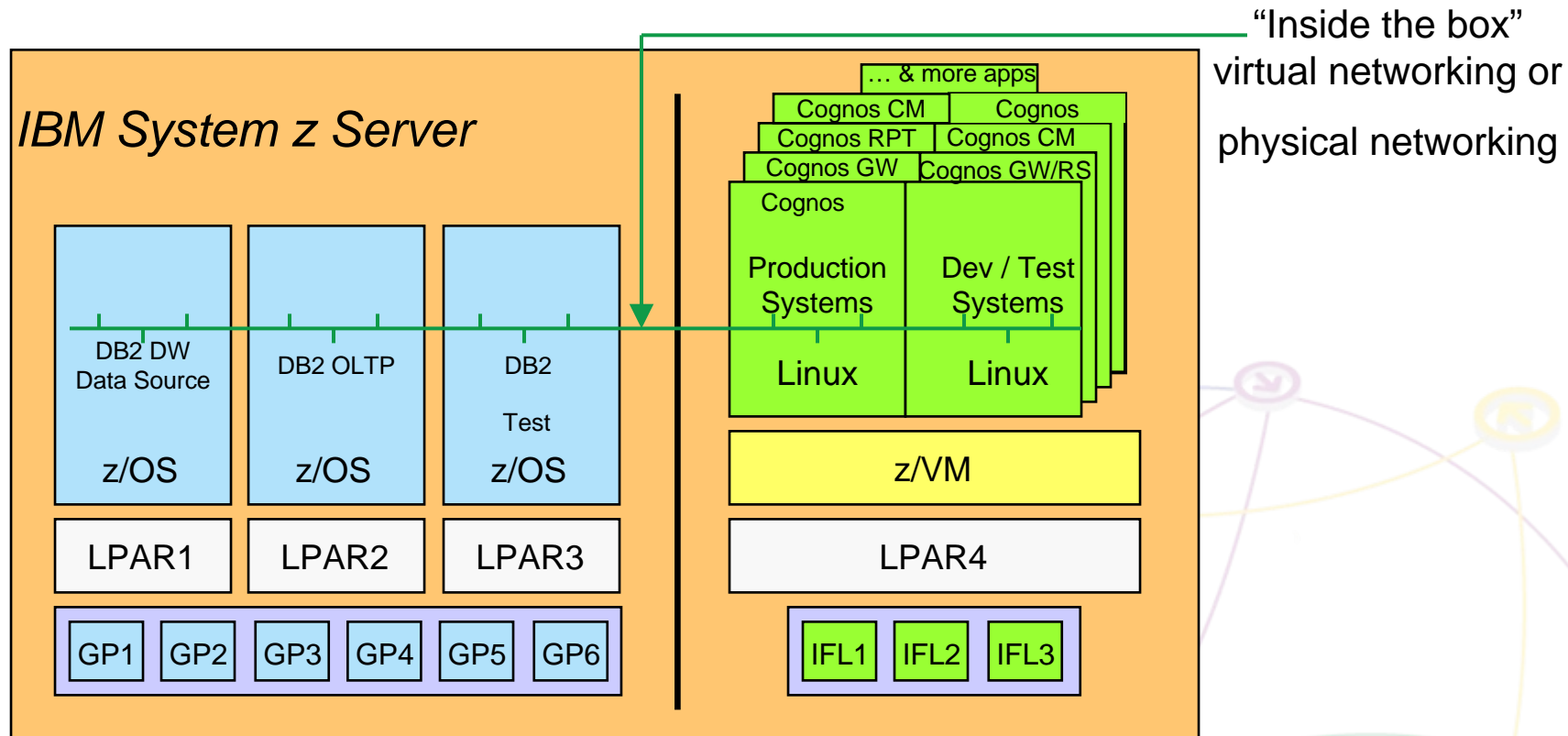

...a potential source of cost savings given z/VM's ability to over-commit CPU capacity

IBM Cognos 8 BI in z/VM “Distributed” Deployment

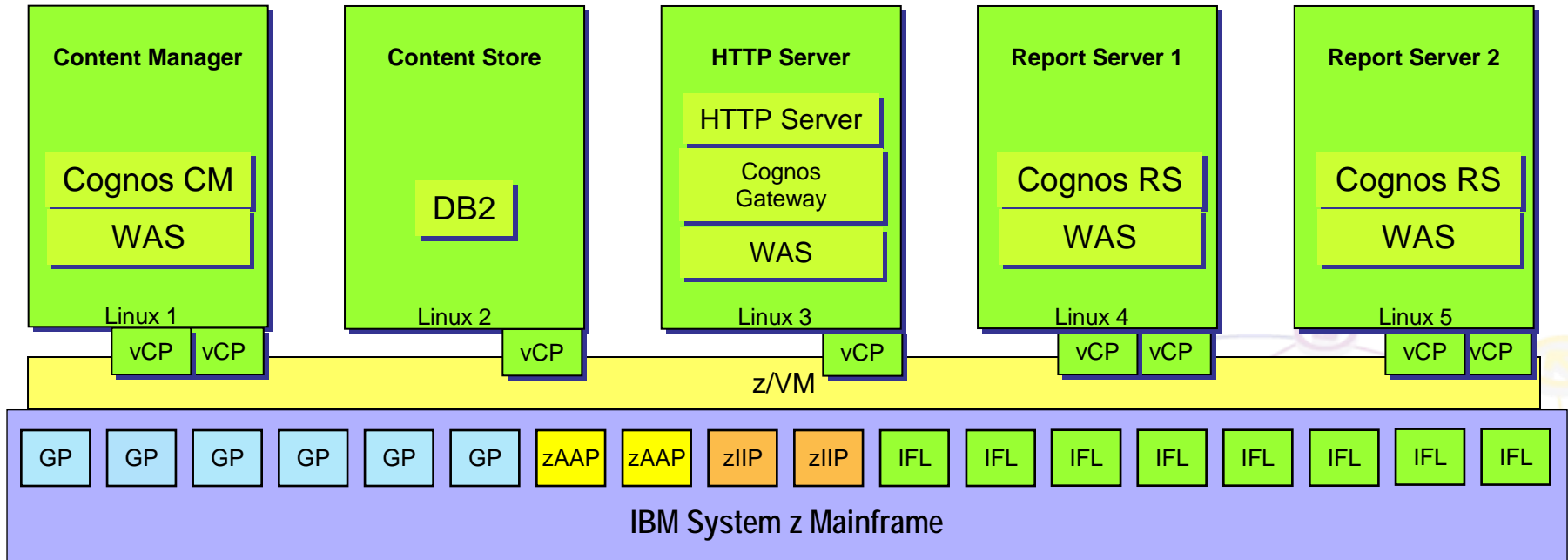

- Number of virtual Cognos instances – similar to other platforms’ physical servers
- Cognos components distributed on individual Linux “guest” servers
- Number of virtual CPs per Cognos instance same as other distributed deployments -- minimum 2 virtual CPs per Content Manager and Report Servers instance

Sample IBM Cognos 8 BI v4 CPU Usage

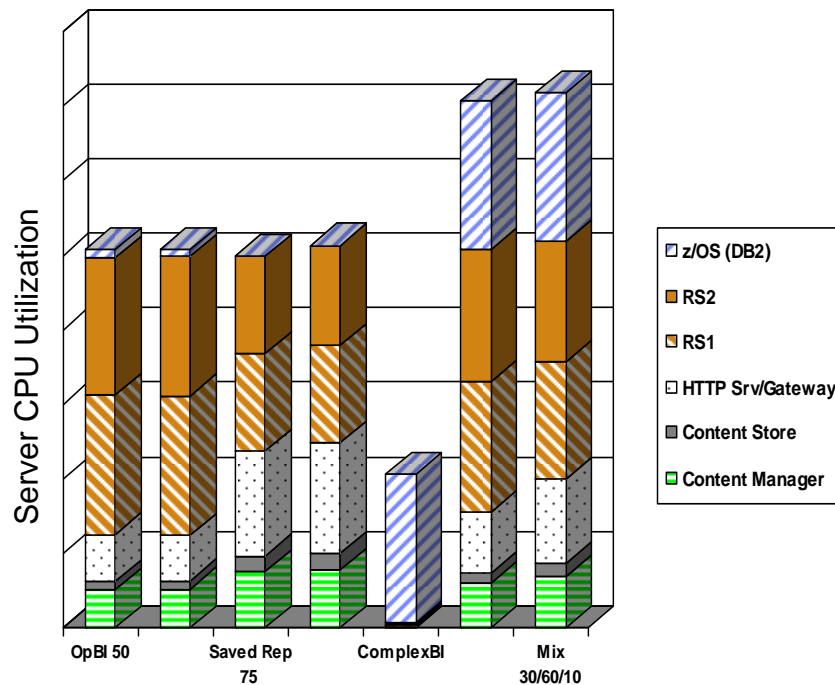

- Individual Cognos component server utilization varies significantly
- Unused capacity likely exists in some Cognos server components
- z/VM virtualization dynamically re-allocates resources on an as needed basis

CPU usage profiles dependent upon application requirements and Cognos implementation

IBM Cognos 8 BI in z/VM

“Distributed” Deployment with Over-commit

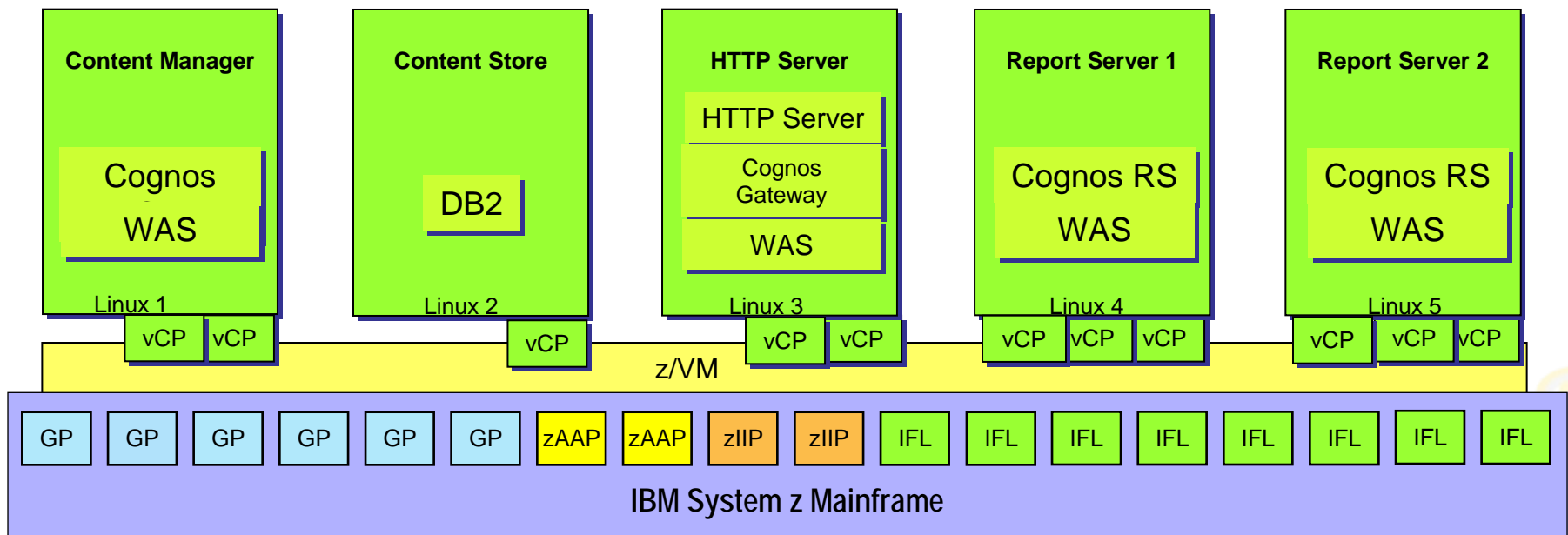

- Total allocation of real GPs/IFLs to z/VM remains the same
- Number of virtual Cognos instances – similar to other platforms’ physical servers or partitions
- Individual Cognos components distributed on individual Linux “guest” servers
- Number of virtual CPUs /Cognos instance increased on high CPU instances to enable use of excess capacity from low CPU instances
- Number of virtual CPUs/Cognos instance should be less than or equal to number of GPs/IFLs assigned to z/VM LPAR
- Over-commit ratio (sum of virtual resource type/real resource type assigned to z/VM LPAR) varies from 1.5/1 to 20/1 or more – highly dependent upon how active the guest server is

Multiple Linux systems – virtualization with CPU over-allocation

Avg. txn duration (lower is better)

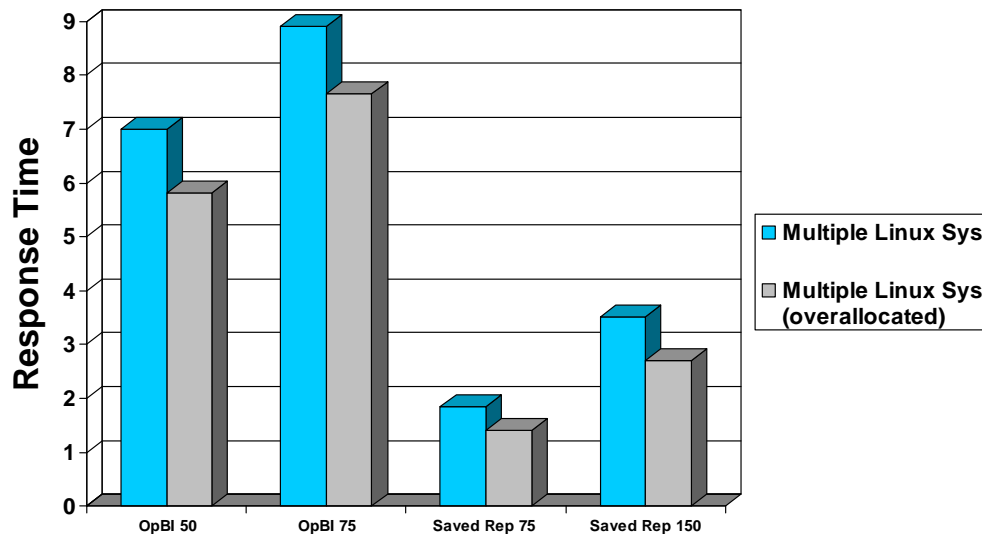

Throughput (txn/min) (higher is better)

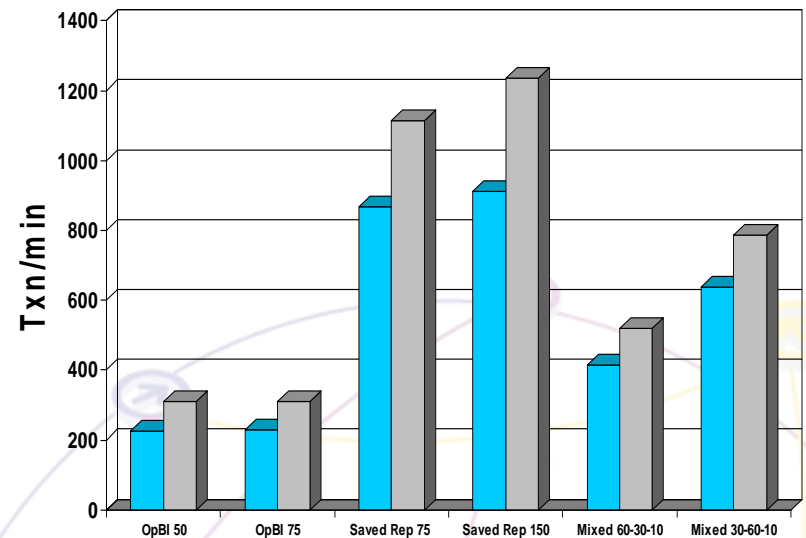

- With additional virtual CPU capacity available to the Report Server and HTTP Server, response times were lowered, and more transactions could be processed.

31-bit Cognos 8 BI in 64-bit Linux

Single virtual server – multiple JVMs vs single JVM

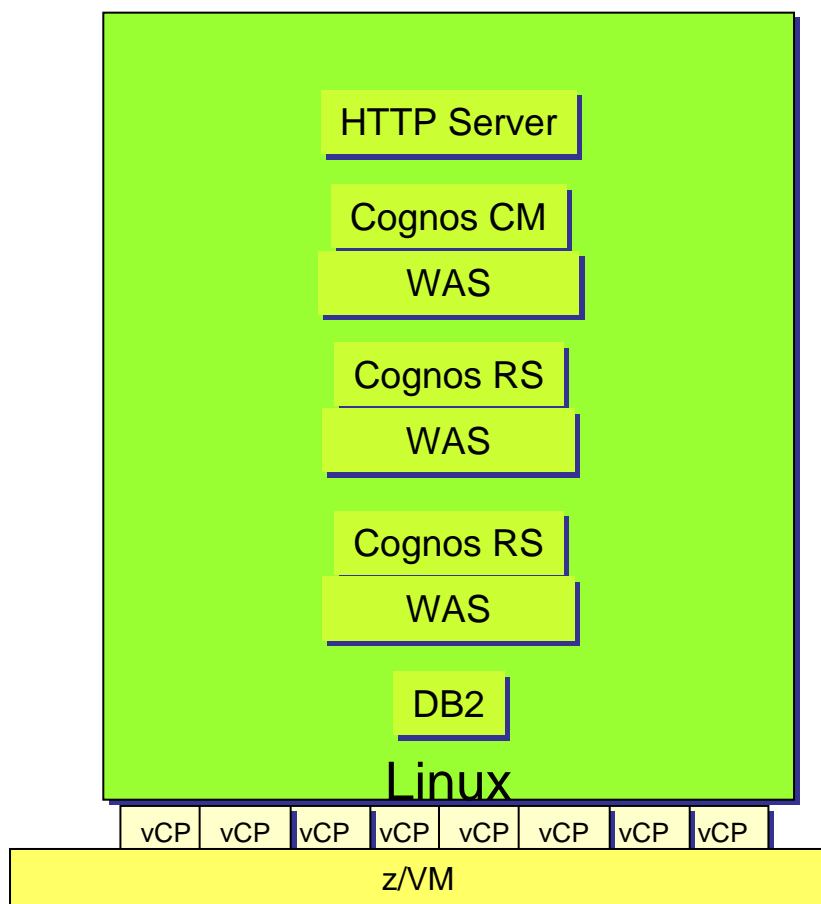

- All Cognos components are in a single 64 bit Linux image, either in multiple JVMs or a single JVM
- Each JVM is limited to ~1.1 GB
- Total number of WebSphere JVMs may need to be the same total number of JVMs needed in traditional distributed platform deployment
- Java memory guidelines follow traditional Cognos proven practice:
 - JVM memory is native heap plus JVM heap (java objects)
 - Recommendation: 768M (RS) or 512M (CM) for JVM heap

IBM Cognos 8 BI JVM Deployments

Avg txn duration (lower is better)

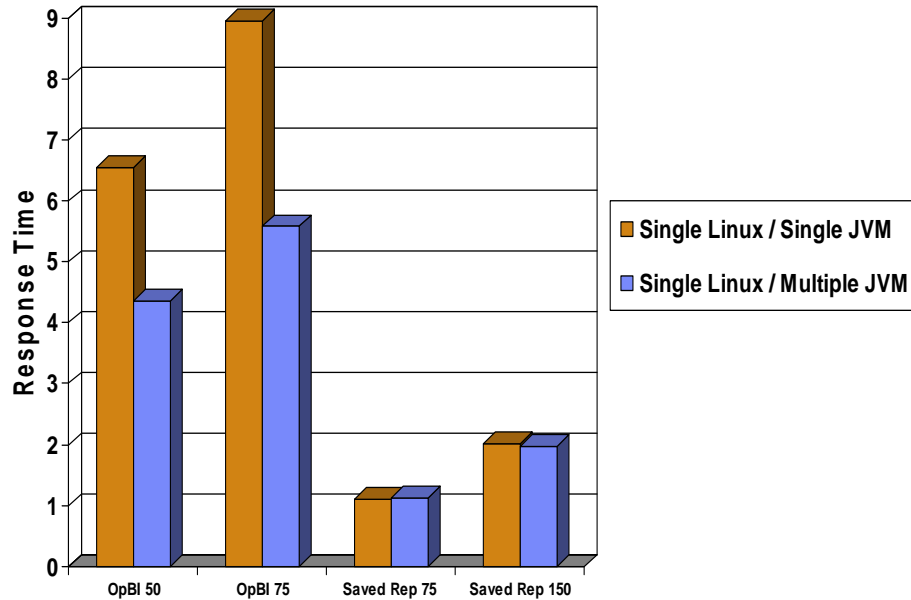

Throughput (txn/min) (higher is better)

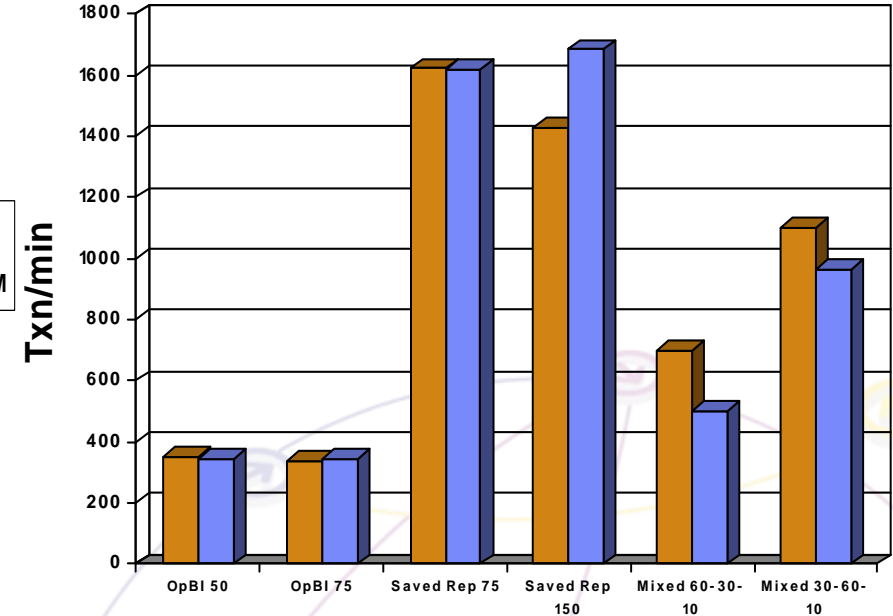

- Multiple JVMs improve response time when many Cognos 8 functions are exercised concurrently, likely due to better memory utilization and less garbage collection.
- Whether a single or multiple JVMs provide better throughput appears dependent upon workload characteristics and concurrency level. Additional studies will occur in this area.

IBM Cognos 8 BI Scalability

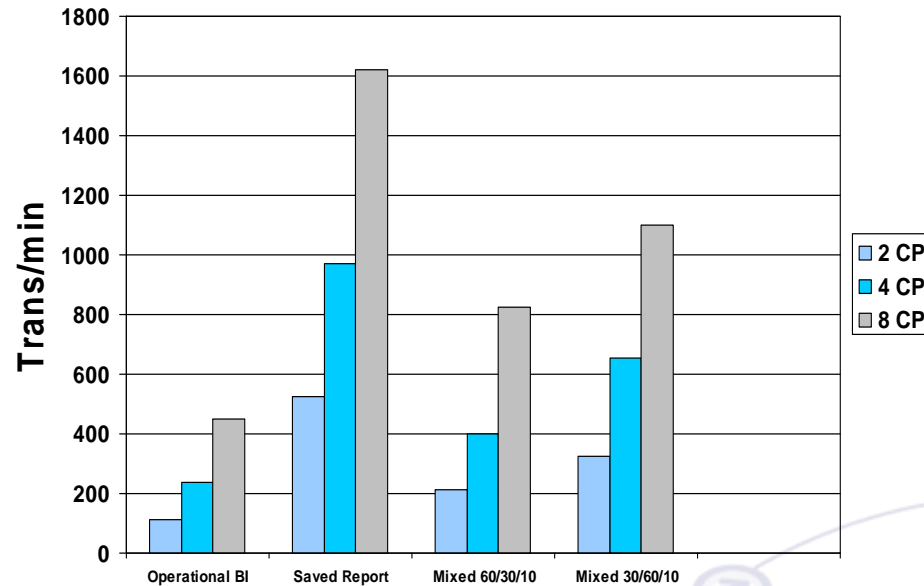

IBM Cognos 8 BI exhibits excellent scalability on Linux for System z with the measured workloads. As the number of processors is doubled, the transaction completion rate also doubles.

Implementation Considerations

- Existing z/VM Linux and Cognos 8 BI proven practices apply:
 - z/VM
 - Linux
 - Cognos 8, WebSphere, DB2
- Changes from default systems settings
 - **Linux settings**
 - **Ulimit**
 - The default number of open files per userid on our Linux system was set to 8192 (check with “ulimit -a”). This is not sufficient for DB2 UDB for Linux, Unix, Windows. The IBM InfoCenter recommends setting the “ulimit” value to 65536.
 - **Nofile**

Running multiple WebSphere Application Server instances (java processes) on the same system may also require an increasing amount of open files

- “nofile” setting in /etc/security/limits.conf for both db2inst1 and root:
 - root hard nofile 32000
 - db2inst1 hard nofile 21000

Implementation Considerations

- Changes from default systems settings
 - **WAS settings**
 - **VM hosting the Content Manager with a JVM heap size of 512 MB and the JVMs running the report servers with 768 MB.**
 - **Web Session thread pools from 50 (default) to 500, allowing to exceed this limit, if required.**
 - **Cognos 8 BI settings**
 - BI workload dependent

Numius's Client Success Story - Is using Cognos 8 BI for Linux on System z, and here's why:

For internal data analysis, process management and for external communication with its 10.000 B2B clients and with about 200 B2B business partners

Requirements:

- Numius's client faced strongly **degrading performance**, both for database queries as well as for OLAP processing.
- Numius's client wanted to **outsource** entire computer infrastructure to a central computing centre.
- Numius's client wants to **achieve economies of scale** by simplifying the heterogeneous distributed computing architecture.
- Numius's client wants to use its business intelligence tools as an **individualised communication channel** with its stakeholders (clients, business partners, shareholders,...)

Solution:

- **To successfully port an existing business intelligence environment from an Intel-HP / Windows – HPUX – Oracle 10g – MS SQL server 2000 architecture to an IBM Cognos 8.3 on System z – IBM DB2 9 for z/OS architecture.**

Results:

- The application was successfully and without loss of functionality ported to the System z platform with no redevelopment required.
- The client's application did not require a redesign to accommodate its growth in data volumes or in terms of users.
- Reports that were not practically useable at client's site now become relevant again. Reports that did not run at client's site now are runnable.
- Client would be able to serve many multiples of current number of users with the very simple architecture from the PoC.
- Client could scale out to more complex architecture without increased hardware complexity.
- Test results showed System z produced 400X the output of the previous system given the same processing time

Selecting an Application

Where To Start

→ Good planning is essential

- If You Don't Know Where You Are Going, You Won't Know When You Get There
- Sizing Is Critical – Cognos with Techline Can Provide The Following
 - Cognos BI 8.4 Sizing
 - SURF - SCON Utilization Reduction Facility
 - zRace – Sizing with TCO
 - z/VM Planner for Linux Guest Sizing



Selecting an Application

Where To Start

- ➔ **Start with Cognos 8 BI applications that are on lower utilized servers or is a new well defined application**
 - **Select application with multi-server implementation for a PoC**
 - PoC should not be a performance test
 - It should be several application servers
 - **Form a team (business liaison, BI Support, DB Support, IT Systems Support)**
 - **Start with smaller databases, work towards larger databases (10s of Gbytes to Terabytes)**



Your Key Resource

- All performance related data contained in this section were obtained with IBM Cognos 8 BI v4 accessing a 10 TB z/OS DB2 data source and are further described in
- [Deploying and Scaling IBM Cognos 8 BI for Linux on System z](#)

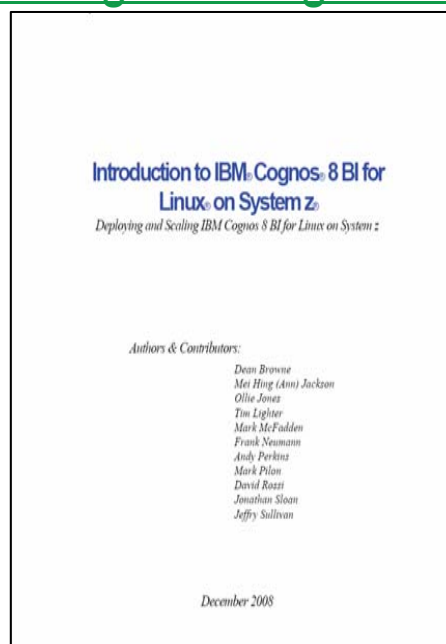

Additional Information Sources

- [Cognos 8 Business Intelligence Landing Page](#)
- [IBM System z10™ Enterprise Class Announcement Landing Page](#)
- [New to the System z Landing Page](#)
- [Redbooks](#)
 - Cognos, Linux and System z Redbooks
 - SG24-7637, Enterprise Data Warehousing with DB2 9 for z/OS
 - SG24-7674, 50 TB Data Warehouse Benchmark on IBM System z (DRAFT)
- [Hints and Tips for Selecting and Tuning Database and I/O options](#)
- [General z/VM Tuning Tips](#)
- [z/VM Release Performance Topics](#)
- [Much information on open source and IBM products](#)

Thank YOU