

MQSeries®



# Intercommunication



MQSeries®



# Intercommunication

**Note!**

Before using this information and the product it supports, be sure to read the general information under “Appendix E. Notices” on page 641.

**Fourth edition (March 2000)**

This edition applies to the following products:

- MQSeries for AIX<sup>®</sup> V5.1
- MQSeries for AS/400<sup>®</sup> V5.1
- MQSeries for AT&T GIS UNIX<sup>®</sup> V2.2
- MQSeries for Compaq (DIGITAL) OpenVMS, V2.2.1.1
- MQSeries for DIGITAL UNIX (Compaq Tru64 UNIX), V2.2.1
- MQSeries for HP-UX, V5.1
- MQSeries for OS/390<sup>®</sup> V2.1
- MQSeries for OS/2<sup>®</sup> Warp V5.1
- MQSeries for SINIX and DC/OSx, V2.2
- MQSeries for Sun Solaris, V5.1
- MQSeries for Tandem NonStop Kernel, V2.2.0.1
- MQSeries for VSE/ESA<sup>™</sup> V2.1
- MQSeries for Windows V2.0
- MQSeries for Windows V2.1
- MQSeries for Windows NT, V5.1

and to all subsequent releases and modifications until otherwise indicated in new editions.

© **Copyright International Business Machines Corporation 1993, 2000 . All rights reserved.**

US Government Users Restricted Rights – Use, duplication or disclosure restricted by GSA ADP Schedule Contract with IBM Corp.

# Contents

Figures . . . . . xi

Tables . . . . . xiii

About this book . . . . . xv

Who this book is for . . . . . xv

What you need to know to understand this book. . . xv

How to use this book. . . . . xvi

    Appearance of text in this book . . . . . xvi

    Terms used in this book. . . . . xvii

Summary of changes . . . . . xix

Changes for this edition (SC33-1872-03). . . . . xix

Changes for the previous edition (SC33-1872-02) . . . xix

Changes for the second edition (SC33-1872-01) . . . xx

Part 1. Introduction . . . . . 1

Chapter 1. Concepts of intercommunication . . . . . 3

What is intercommunication? . . . . . 3

    How does distributed queuing work? . . . . . 3

Distributed queuing components . . . . . 7

    Message channels. . . . . 7

    Message channel agents . . . . . 9

    Transmission queues . . . . . 10

    Channel initiators and listeners. . . . . 10

    Channel-exit programs . . . . . 12

Dead-letter queues . . . . . 13

Remote queue definitions. . . . . 14

How to get to the remote queue manager . . . . . 14

    Multi-hopping . . . . . 14

    Sharing channels . . . . . 14

    Using different channels . . . . . 15

    Using clustering. . . . . 16

Chapter 2. Making your applications communicate . . . . . 17

How to send a message to another queue manager . . 17

    Defining the channels . . . . . 18

    Defining the queues . . . . . 19

    Sending the messages . . . . . 20

    Starting the channel . . . . . 20

Triggering channels. . . . . 20

Safety of messages . . . . . 22

    Fast, nonpersistent messages . . . . . 22

    Undelivered messages. . . . . 23

Chapter 3. More about intercommunication . . . . . 25

Addressing information . . . . . 25

What are aliases? . . . . . 25

    Queue name resolution . . . . . 26

Queue manager alias definitions . . . . . 26

    Outbound messages - remapping the queue manager name . . . . . 26

    Outbound messages - altering or specifying the transmission queue. . . . . 27

    Inbound messages - determining the destination . . 27

Reply-to queue alias definitions . . . . . 28

    What is a reply-to queue alias definition? . . . . 28

    Reply-to queue name . . . . . 29

Networks . . . . . 29

    Channel and transmission queue names. . . . . 29

    Network planner . . . . . 31

Part 2. How intercommunication works . . . . . 33

Chapter 4. MQSeries distributed-messaging techniques . . . 35

Message flow control . . . . . 35

    Queue names in transmission header. . . . . 36

    How to create queue manager and reply-to aliases . . . . . 36

Putting messages on remote queues . . . . . 37

    More about name resolution. . . . . 38

Choosing the transmission queue . . . . . 39

Receiving messages. . . . . 40

    Receiving alias queue manager names . . . . . 40

Passing messages through your system . . . . . 41

    Method 1: Using the incoming location name . . . 42

    Method 2: Using an alias for the queue manager . 42

    Method 3: Selecting a transmission queue . . . . 42

    Using these methods . . . . . 42

Separating message flows . . . . . 42

Concentrating messages to diverse locations . . . . 44

Diverting message flows to another destination . . 45

Sending messages to a distribution list . . . . . 46

Reply-to queue . . . . . 47

    Reply-to queue alias example . . . . . 48

    How the example works . . . . . 50

    How the queue manager makes use of the reply-to queue alias. . . . . 51

    Reply-to queue alias walk-through . . . . . 51

Networking considerations . . . . . 52

Return routing . . . . . 53

Managing queue name translations . . . . . 53

Message sequence numbering . . . . . 54

    Sequential retrieval of messages . . . . . 55

    Sequence of retrieval of fast, nonpersistent messages . . . . . 56

Loopback testing . . . . . 56

Chapter 5. DQM implementation . . . . . 57

Functions of DQM . . . . . 57

Message sending and receiving. . . . . 58

Channel parameters . . . . .	59
Channel status and sequence numbers . . . . .	59
Channel control function . . . . .	59
Preparing channels . . . . .	60
Channel states . . . . .	62
Stopping and quiescing channels (not MQSeries for Windows). . . . .	67
Stopping and quiescing channels (MQSeries for Windows) . . . . .	68
Restarting stopped channels . . . . .	69
In-doubt channels . . . . .	69
Problem determination . . . . .	71
What happens when a message cannot be delivered? . . . . .	71
Initialization and configuration files . . . . .	73
OS/390 without CICS . . . . .	73
OS/390 using CICS. . . . .	73
Windows NT . . . . .	73
OS/2, Digital OpenVMS, Tandem NSK, OS/400 and UNIX systems . . . . .	73
VSE/ESA . . . . .	75
Data conversion . . . . .	75
Writing your own message channel agents . . . . .	75

## Chapter 6. Channel attributes . . . . . 77

Channel attributes in alphabetical order . . . . .	77
Alter date (ALTDATE). . . . .	78
Alter time (ALTTIME). . . . .	78
Auto start (AUTOSTART). . . . .	78
Batch interval (BATCHINT). . . . .	79
Batch size (BATCHSZ). . . . .	79
Channel name (CHANNEL). . . . .	80
Channel type (CHLTYPE) . . . . .	81
CICS profile name . . . . .	81
Cluster (CLUSTER). . . . .	81
Cluster namelist (CLUSNL) . . . . .	82
Connection name (CONNAME) . . . . .	82
Convert message (CONVERT) . . . . .	83
Description (DESCR) . . . . .	84
Disconnect interval (DISCINT) . . . . .	84
Heartbeat interval (HBINT) . . . . .	85
Long retry count (LONGRTY) . . . . .	85
Long retry interval (LONGTMR) . . . . .	85
LU 6.2 mode name (MODENAME) . . . . .	86
LU 6.2 transaction program name (TPNAME) . . . . .	86
Maximum message length (MAXMSGL). . . . .	87
Maximum transmission size . . . . .	87
Message channel agent name (MCANAME) . . . . .	87
Message channel agent type (MCATYPE) . . . . .	88
Message channel agent user identifier (MCAUSER) . . . . .	88
Message exit name (MSGEXIT) . . . . .	88
Message exit user data (MSGDATA) . . . . .	89
Message-retry exit name (MREXIT) . . . . .	89
Message-retry exit user data (MRDATA). . . . .	89
Message retry count (MRRTY) . . . . .	89
Message retry interval (MRTMR) . . . . .	89
Network-connection priority (NETPRTY) . . . . .	90
Nonpersistent message speed (NPMSPEED) . . . . .	90
Password (PASSWORD) . . . . .	90
PUT authority (PUTAUT). . . . .	90

Queue manager name (QMNAME) . . . . .	91
Receive exit name (RCVEXIT) . . . . .	91
Receive exit user data (RCVDATA) . . . . .	92
Security exit name (SCYEXIT) . . . . .	92
Security exit user data (SCYDATA) . . . . .	93
Send exit name (SENDEXIT). . . . .	93
Send exit user data (SENDDATA) . . . . .	93
Sequence number wrap (SEQWRAP) . . . . .	93
Sequential delivery . . . . .	93
Short retry count (SHORTRTY) . . . . .	93
Short retry interval (SHORTTMR) . . . . .	94
Target system identifier . . . . .	94
Transaction identifier . . . . .	94
Transmission queue name (XMITQ) . . . . .	94
Transport type (TRPTYPE) . . . . .	95
User ID (USERID) . . . . .	95

## Chapter 7. Example configuration chapters in this book . . . . . 97

Network infrastructure . . . . .	98
Communications software . . . . .	98
How to use the communication examples . . . . .	99
IT responsibilities . . . . .	100

---

## Part 3. DQM in MQSeries for OS/2 Warp, Windows NT, Digital OpenVMS, Tandem NSK, and UNIX systems . . . . . 101

### Chapter 8. Monitoring and controlling channels on distributed platforms . . . 105

The DQM channel control function . . . . .	105
Functions available . . . . .	106
Getting started with objects. . . . .	108
Creating objects . . . . .	108
Creating default objects . . . . .	108
Creating a channel . . . . .	109
Displaying a channel . . . . .	110
Displaying channel status . . . . .	110
Starting a channel . . . . .	110
Renaming a channel . . . . .	111
Channel attributes and channel types . . . . .	111
Channel functions . . . . .	112

### Chapter 9. Preparing MQSeries for distributed platforms . . . . . 117

Transmission queues and triggering . . . . .	117
Creating a transmission queue. . . . .	117
Triggering channels . . . . .	117
Channel programs. . . . .	119
Other things to consider. . . . .	119
Undelivered-message queue . . . . .	119
Queues in use . . . . .	120
Multiple message channels per transmission queue . . . . .	120
Security of MQSeries objects . . . . .	120
System extensions and user-exit programs. . . . .	121

Running channels and listeners as trusted applications . . . . .	121
What next? . . . . .	122

**Chapter 10. Setting up communication for OS/2 and Windows NT. . . . . 123**

Deciding on a connection . . . . .	123
Defining a TCP connection . . . . .	124
Sending end. . . . .	124
Receiving on TCP . . . . .	124
Defining an LU 6.2 connection . . . . .	126
Sending end for OS/2 . . . . .	127
Sending end for Windows NT. . . . .	127
Receiving on LU 6.2 . . . . .	127
Defining a NetBIOS connection . . . . .	128
Defining the MQSeries local NetBIOS name . . . . .	129
Establishing the queue manager NetBIOS session, command, and name limits . . . . .	130
Establishing the LAN adapter number . . . . .	130
Initiating the connection. . . . .	130
Target listener . . . . .	131
Defining an SPX connection . . . . .	131
Sending end. . . . .	131
Receiving on SPX . . . . .	132
IPX/SPX parameters . . . . .	133

**Chapter 11. Example configuration - IBM MQSeries for OS/2 Warp. . . . . 137**

Configuration parameters for an LU 6.2 connection	137
Configuration worksheet . . . . .	137
Explanation of terms . . . . .	140
Establishing an LU 6.2 connection . . . . .	142
Defining local node characteristics . . . . .	142
Connecting to a peer system . . . . .	150
Connecting to a host system . . . . .	153
Verifying the configuration . . . . .	157
What next? . . . . .	158
Establishing a TCP connection. . . . .	158
What next? . . . . .	159
Establishing a NetBIOS connection . . . . .	160
Establishing an SPX connection . . . . .	160
IPX/SPX parameters . . . . .	160
SPX addressing. . . . .	161
Using the SPX KEEPALIVE option . . . . .	162
Receiving on SPX . . . . .	162
MQSeries for OS/2 Warp configuration. . . . .	162
Basic configuration . . . . .	163
Channel configuration . . . . .	163
Running channels as processes or threads . . . . .	167

**Chapter 12. Example configuration - IBM MQSeries for Windows NT. . . . . 169**

Configuration parameters for an LU 6.2 connection	169
Configuration worksheet . . . . .	170
Explanation of terms . . . . .	172
Establishing an LU 6.2 connection . . . . .	174
Configuring the local node . . . . .	174
Adding a connection . . . . .	176
Adding a partner . . . . .	178
Adding a CPI-C entry . . . . .	179

Configuring an invokable TP . . . . .	179
What next? . . . . .	181
Establishing a TCP connection. . . . .	181
What next? . . . . .	181
Establishing a NetBIOS connection . . . . .	181
Establishing an SPX connection . . . . .	182
IPX/SPX parameters . . . . .	182
SPX addressing. . . . .	183
Receiving on SPX . . . . .	183
MQSeries for Windows NT configuration . . . . .	184
Default configuration. . . . .	184
Basic configuration . . . . .	184
Channel configuration . . . . .	185
Automatic startup. . . . .	189
Running channels as processes or threads . . . . .	189

**Chapter 13. Setting up communication in UNIX systems . . . . . 191**

Deciding on a connection . . . . .	191
Defining a TCP connection . . . . .	191
Sending end. . . . .	191
Receiving on TCP . . . . .	192
Defining an LU 6.2 connection . . . . .	194
Sending end. . . . .	195
Receiving on LU 6.2 . . . . .	195

**Chapter 14. Example configuration - IBM MQSeries for AIX. . . . . 197**

Configuration parameters for an LU 6.2 connection	197
Configuration worksheet . . . . .	197
Explanation of terms . . . . .	200
Establishing a session using Communications Server for AIX V5 . . . . .	202
Configuring your node . . . . .	202
Configuring connectivity to the network . . . . .	203
Defining a local LU . . . . .	205
Defining a transaction program . . . . .	206
Establishing a TCP connection. . . . .	209
What next? . . . . .	209
Establishing a UDP connection . . . . .	209
What next? . . . . .	209
MQSeries for AIX configuration . . . . .	209
Basic configuration . . . . .	210
Channel configuration . . . . .	210

**Chapter 15. Example configuration - IBM MQSeries for DIGITAL UNIX (Compaq Tru64 UNIX). . . . . 215**

Establishing a TCP connection. . . . .	215
What next? . . . . .	215
MQSeries for DIGITAL UNIX (Compaq Tru64 UNIX) configuration . . . . .	215
Basic configuration . . . . .	216
Channel configuration . . . . .	216

**Chapter 16. Example configuration - IBM MQSeries for HP-UX . . . . . 219**

Configuration parameters for an LU 6.2 connection	219
Configuration worksheet . . . . .	219

Explanation of terms . . . . .	222
Establishing a session using HP SNAplus2 . . . . .	223
SNAplus2 configuration . . . . .	223
APPC configuration . . . . .	227
HP-UX operation . . . . .	237
What next? . . . . .	237
Establishing a TCP connection. . . . .	237
What next? . . . . .	237
MQSeries for HP-UX configuration . . . . .	238
Basic configuration . . . . .	238
Channel configuration . . . . .	238

**Chapter 17. Example configuration - IBM MQSeries for AT&T GIS UNIX**

<b>Version 2.2 . . . . .</b>	<b>243</b>
Configuration parameters for an LU 6.2 connection	243
Configuration worksheet . . . . .	243
Explanation of terms . . . . .	246
Establishing a connection using AT&T GIS SNA Server . . . . .	246
Defining local node characteristics . . . . .	247
Connecting to a partner node . . . . .	249
Configuring a remote node. . . . .	249
What next? . . . . .	251
Establishing a TCP connection. . . . .	251
What next? . . . . .	251
MQSeries for AT&T GIS UNIX configuration . . . . .	251
Basic configuration . . . . .	252
Channel configuration . . . . .	252

**Chapter 18. Example configuration - IBM MQSeries for Sun Solaris . . . . .**

<b>Version 2.2 . . . . .</b>	<b>257</b>
Configuration parameters for an LU 6.2 connection	257
Configuration worksheet . . . . .	257
Explanation of terms . . . . .	260
Establishing a connection using SunLink Version 9.1 . . . . .	261
SunLink 9.1 base configuration . . . . .	261
Configuring a PU 2.1 server . . . . .	262
Adding a LAN connection . . . . .	263
Configuring a connection to a remote PU . . . . .	264
Configuring an independent LU . . . . .	265
Configuring a partner LU . . . . .	267
Configuring the session mode. . . . .	268
Configuring a transaction program . . . . .	269
CPI-C side information . . . . .	270
What next? . . . . .	271
Establishing a TCP connection. . . . .	271
What next? . . . . .	271
MQSeries for Sun Solaris configuration. . . . .	271
Basic configuration . . . . .	272
Channel configuration . . . . .	272

**Chapter 19. Setting up communication in Digital OpenVMS systems. . . . .**

<b>Version 2.2 . . . . .</b>	<b>277</b>
Deciding on a connection . . . . .	277
Defining a TCP connection . . . . .	278
Sending end. . . . .	278
Receiving channels using Compaq (DIGITAL) TCP/IP services (UCX) for OpenVMS . . . . .	278

Receiving channels using Cisco MultiNet for OpenVMS . . . . .	279
Receiving channels using Attachmate PathWay for OpenVMS . . . . .	280
Receiving channels using Process Software Corporation TCPware . . . . .	280
Defining an LU 6.2 connection . . . . .	281
SNA configuration. . . . .	281
Specifying SNA configuration parameters to MQSeries. . . . .	283
Sample MQSeries configuration . . . . .	284
Problem solving . . . . .	285
Defining a DECnet Phase IV connection . . . . .	285
Sending end. . . . .	286
Receiving on DECnet Phase IV . . . . .	286
Defining a DECnet Phase V connection. . . . .	286

**Chapter 20. Setting up communication in Tandem NSK . . . . .**

<b>Version 2.2 . . . . .</b>	<b>289</b>
Deciding on a connection . . . . .	289
SNA channels . . . . .	289
LU 6.2 responder processes. . . . .	291
TCP channels . . . . .	291
Communications examples . . . . .	292
SNAX communications example . . . . .	292
ICE communications example . . . . .	299
TCP/IP communications example . . . . .	303

**Chapter 21. Message channel planning example for distributed platforms . . . . .**

<b>Version 2.2 . . . . .</b>	<b>305</b>
What the example shows . . . . .	305
Queue manager QM1 example . . . . .	307
Queue manager QM2 example . . . . .	308
Running the example. . . . .	309
Expanding this example. . . . .	309

**Chapter 22. Example SINIX and DC/OSx configuration files. . . . .**

<b>Version 2.2 . . . . .</b>	<b>311</b>
Configuration file on bight . . . . .	312
Configuration file on forties . . . . .	313
Working configuration files for Pyramid DC/OSx . . . . .	313
Output of dbd command . . . . .	314

**Part 4. DQM in MQSeries for OS/390. . . . .**

**Chapter 23. Monitoring and controlling channels on OS/390 . . . . .**

<b>Version 2.2 . . . . .</b>	<b>321</b>
The DQM channel control function . . . . .	321
Using the panels and the commands . . . . .	322
Using the initial panel . . . . .	322
Managing your channels . . . . .	324
Defining a channel . . . . .	324
Altering a channel definition . . . . .	325
Displaying a channel definition . . . . .	325
Displaying information about DQM. . . . .	326
Deleting a channel definition . . . . .	326



Starting a channel initiator . . . . .	327
Stopping a channel initiator . . . . .	328
Starting a channel listener . . . . .	329
Stopping a channel listener . . . . .	329
Starting a channel . . . . .	330
Testing a channel . . . . .	331
Resetting message sequence numbers for a channel . . . . .	332
Resolving in-doubt messages on a channel . . . . .	333
Stopping a channel . . . . .	334
Displaying channel status . . . . .	335
Displaying cluster channels. . . . .	337

**Chapter 24. Preparing MQSeries for OS/390 . . . . . 339**

Setting up communication . . . . .	339
TCP setup . . . . .	339
APPC/MVS setup. . . . .	341
Defining DQM requirements to MQSeries . . . . .	342
Defining MQSeries objects . . . . .	342
Synchronization queue . . . . .	343
Channel command queues . . . . .	343
Channel operation considerations . . . . .	344
OS/390 Automatic Restart Management (ARM) . . . . .	344

**Chapter 25. Message channel planning example for OS/390 . . . . . 345**

What the example shows . . . . .	345
Queue manager QM1 example . . . . .	346
Queue manager QM2 example . . . . .	347
Running the example. . . . .	349
Expanding this example. . . . .	349

**Chapter 26. Monitoring and controlling channels in OS/390 with CICS . . . . . 351**

The DQM channel control function . . . . .	351
CICS regions . . . . .	352
Starting DQM panels . . . . .	352
The Message Channel List panel . . . . .	353
Keyboard functions . . . . .	353
Selecting a channel . . . . .	354
Working with channels . . . . .	354
Creating a channel . . . . .	356
Altering a channel. . . . .	356
Browsing a channel . . . . .	356
Renaming a channel . . . . .	357
Selected menu-bar choice . . . . .	357
Edit menu-bar choice. . . . .	367
View menu-bar choice . . . . .	371
Help menu-bar choice . . . . .	372
The channel definition panels . . . . .	372
Channel menu-bar choice . . . . .	373
Help menu-bar choice . . . . .	373
Channel settings panel fields . . . . .	374
Details of sender channel settings panel . . . . .	376
Details of receiver channel settings panel . . . . .	377
Details of server channel settings panel. . . . .	378
Details of requester channel settings panel. . . . .	379

**Chapter 27. Preparing MQSeries for OS/390 when using CICS . . . . . 381**

Setting up CICS communication for MQSeries for OS/390 . . . . .	381
Connecting CICS systems . . . . .	381
Defining an LU 6.2 connection . . . . .	382
Installing the connection. . . . .	383
Communications between CICS systems attached to one queue manager . . . . .	383
Defining DQM requirements to MQSeries . . . . .	384
Defining MQSeries objects . . . . .	384
Multiple message channels per transmission queue . . . . .	384
Channel operation considerations . . . . .	385

**Chapter 28. Message channel planning example for OS/390 using CICS . . . . . 387**

**Chapter 29. Example configuration - IBM MQSeries for OS/390 . . . . . 395**

Configuration parameters for an LU 6.2 connection . . . . .	395
Configuration worksheet . . . . .	396
Explanation of terms . . . . .	398
Establishing an LU 6.2 connection . . . . .	400
Defining yourself to the network . . . . .	400
Defining a connection to a partner . . . . .	402
What next? . . . . .	402
Establishing an LU 6.2 connection using CICS . . . . .	402
Defining a connection . . . . .	402
Defining the sessions. . . . .	403
Installing the new group definition . . . . .	404
What next? . . . . .	404
Establishing a TCP connection. . . . .	404
What next? . . . . .	405
MQSeries for OS/390 configuration . . . . .	405
Channel configuration . . . . .	405
Defining a local queue . . . . .	409
Defining a remote queue . . . . .	412
Defining a sender channel when not using CICS . . . . .	413
Defining a receiver channel when not using CICS . . . . .	415
Defining a sender channel using CICS . . . . .	417
Defining a receiver channel using CICS . . . . .	418

**Part 5. DQM in MQSeries for AS/400 . . . . . 421**

**Chapter 30. Monitoring and controlling channels in MQSeries for AS/400 . . . . . 423**

The DQM channel control function . . . . .	423
Operator commands . . . . .	424
Getting started . . . . .	426
Creating objects . . . . .	426
Creating a channel . . . . .	426
Starting a channel . . . . .	429
Selecting a channel . . . . .	430

Browsing a channel . . . . .	430
Renaming a channel . . . . .	432
Work with channel status . . . . .	432
Work-with-channel choices . . . . .	434
Panel choices . . . . .	435
F6=Create . . . . .	435
2=Change . . . . .	436
3=Copy . . . . .	436
4=Delete . . . . .	437
5=Display . . . . .	437
8=Work with Status . . . . .	437
13=Ping . . . . .	437
14=Start . . . . .	437
15=End . . . . .	438
16=Reset . . . . .	439
17=Resolve . . . . .	439

<b>Chapter 31. Preparing MQSeries for AS/400 . . . . .</b>	<b>441</b>
Creating a transmission queue. . . . .	441
Triggering channels . . . . .	443
Channel programs. . . . .	445
Channel states on OS/400 . . . . .	446
Other things to consider. . . . .	447
Undelivered-message queue . . . . .	447
Queues in use . . . . .	447
Maximum number of channels . . . . .	447
Multiple message channels per transmission queue . . . . .	447
Security of MQSeries for AS/400 objects . . . . .	447
System extensions and user-exit programs. . . . .	448

<b>Chapter 32. Setting up communication for MQSeries for AS/400. . . . .</b>	<b>449</b>
Deciding on a connection . . . . .	449
Defining a TCP connection . . . . .	449
Receiving on TCP . . . . .	450
Defining an LU 6.2 connection . . . . .	451
Initiating end (Sending) . . . . .	452
Initiated end (Receiver) . . . . .	455

<b>Chapter 33. Example configuration - IBM MQSeries for AS/400 . . . . .</b>	<b>459</b>
Configuration parameters for an LU 6.2 connection . . . . .	459
Configuration worksheet . . . . .	459
Explanation of terms . . . . .	462
Establishing an LU 6.2 connection . . . . .	464
Local node configuration . . . . .	464
Connection to partner node . . . . .	465
What next? . . . . .	469
Establishing a TCP connection. . . . .	469
Adding a TCP/IP interface. . . . .	469
Adding a TCP/IP loopback interface . . . . .	469
Adding a default route . . . . .	470
What next? . . . . .	470
MQSeries for AS/400 configuration . . . . .	471
Basic configuration . . . . .	471
Channel configuration . . . . .	471
Defining a queue . . . . .	475
Defining a channel . . . . .	476

<b>Chapter 34. Message channel planning example for OS/400 . . . . .</b>	<b>477</b>
What the example shows . . . . .	477
Queue manager QM1 example . . . . .	478
Queue manager QM2 example . . . . .	480
Running the example. . . . .	482
Expanding this example. . . . .	482

---

## Part 6. DQM in MQSeries for VSE/ESA . . . . . 483

<b>Chapter 35. Example configuration - MQSeries for VSE/ESA . . . . .</b>	<b>485</b>
Configuration parameters for an LU 6.2 connection . . . . .	485
Configuration worksheet . . . . .	485
Explanation of terms . . . . .	487
Establishing an LU 6.2 connection . . . . .	488
Defining a connection . . . . .	488
Defining a session. . . . .	488
Installing the new group definition . . . . .	489
What next? . . . . .	489
Establishing a TCP connection. . . . .	490
MQSeries for VSE/ESA configuration . . . . .	490
Configuring channels. . . . .	490
Defining a local queue . . . . .	493
Defining a remote queue . . . . .	495
Defining a SNA LU 6.2 sender channel. . . . .	497
Defining a SNA LU6.2 receiver channel. . . . .	498
Defining a TCP/IP sender channel . . . . .	500
Defining a TCP receiver channel . . . . .	501

---

## Part 7. Further intercommunication considerations . . . . . 503

<b>Chapter 36. Channel-exit programs . . . . .</b>	<b>505</b>
What are channel-exit programs? . . . . .	505
Processing overview . . . . .	506
Channel security exit programs . . . . .	507
Channel send and receive exit programs . . . . .	512
Channel message exit programs . . . . .	514
Channel message retry exit program. . . . .	516
Channel auto-definition exit program . . . . .	516
Transport-retry exit program . . . . .	517
Writing and compiling channel-exit programs . . . . .	518
MQSeries for OS/390 without CICS . . . . .	520
MQSeries for OS/390 using CICS. . . . .	521
MQSeries for AS/400. . . . .	521
MQSeries for OS/2 Warp . . . . .	522
Windows 3.1 client . . . . .	524
MQSeries for Windows NT server, MQSeries client for Windows NT, and MQSeries client for Windows 95 and Windows 98 . . . . .	524
MQSeries for Windows . . . . .	526
MQSeries for AIX . . . . .	526
MQSeries for Compaq (DIGITAL) OpenVMS . . . . .	528
MQSeries for DIGITAL UNIX (Compaq Tru64 UNIX). . . . .	529
MQSeries for HP-UX. . . . .	530

MQSeries for AT&T GIS UNIX . . . . .	531
MQSeries for Sun Solaris . . . . .	532
MQSeries for SINIX and DC/OSx . . . . .	532
MQSeries for Tandem NonStop Kernel . . . . .	533
Supplied channel-exit programs using DCE security services . . . . .	537
What do the DCE channel-exit programs do?	537
How do the DCE channel-exit programs work?	538
How to use the DCE channel-exit programs . . . . .	540

**Chapter 37. Channel-exit calls and data structures. . . . . 543**

Data definition files . . . . .	544
MQ_CHANNEL_EXIT - Channel exit . . . . .	546
Syntax. . . . .	546
Parameters . . . . .	546
Usage notes . . . . .	548
C invocation. . . . .	549
COBOL invocation . . . . .	549
PL/I invocation . . . . .	549
RPG invocation (ILE). . . . .	549
RPG invocation (OPM) . . . . .	550
System/390® assembler invocation . . . . .	550
MQ_CHANNEL_AUTO_DEF_EXIT - Channel auto-definition exit . . . . .	551
Syntax. . . . .	551
Parameters . . . . .	551
Usage notes . . . . .	551
C invocation. . . . .	552
COBOL invocation . . . . .	552
RPG invocation (ILE). . . . .	552
RPG invocation (OPM) . . . . .	552
System/390 assembler invocation. . . . .	552
MQXWAIT - Wait . . . . .	553
Syntax. . . . .	553
Parameters . . . . .	553
C invocation. . . . .	554
System/390 assembler invocation. . . . .	554
MQ_TRANSPORT_EXIT - Transport retry exit . . . . .	555
Syntax. . . . .	555
Parameters . . . . .	555
Usage notes . . . . .	555
C invocation. . . . .	555
MQCD - Channel data structure . . . . .	556
Fields . . . . .	558
C declaration . . . . .	580
COBOL declaration . . . . .	582
PL/I declaration . . . . .	584
ILE RPG declaration . . . . .	585
OPM RPG declaration . . . . .	587
System/390 assembler declaration . . . . .	589
MQCXP - Channel exit parameter structure . . . . .	591
Fields . . . . .	591
C declaration . . . . .	601
COBOL declaration . . . . .	601
PL/I declaration . . . . .	602
ILE RPG declaration . . . . .	602
OPM RPG declaration . . . . .	603
System/390 assembler declaration . . . . .	604
MQTXP - Transport-exit data structure . . . . .	605
Fields . . . . .	605

C declaration . . . . .	608
MQXWD - Exit wait descriptor structure . . . . .	609
Fields . . . . .	609
C declaration . . . . .	610
System/390 assembler declaration . . . . .	610

**Chapter 38. Problem determination in DQM . . . . . 611**

Error message from channel control . . . . .	611
Ping . . . . .	611
Dead-letter queue considerations . . . . .	612
Validation checks . . . . .	612
In-doubt relationship . . . . .	613
Channel startup negotiation errors . . . . .	613
When a channel refuses to run . . . . .	613
Triggered channels . . . . .	614
Conversion failure. . . . .	615
Network problems . . . . .	615
Dial-up problems . . . . .	615
Retrying the link . . . . .	615
Retry considerations . . . . .	615
Data structures . . . . .	616
User exit problems . . . . .	616
Disaster recovery . . . . .	616
Channel switching. . . . .	617
Connection switching. . . . .	617
Client problems . . . . .	617
Terminating clients . . . . .	617
Error logs . . . . .	618
Error logs for OS/2 and Windows NT . . . . .	618
Error logs on UNIX systems . . . . .	618
Error logs on DOS, Windows 3.1, and Windows 95 and Windows 98 clients . . . . .	618
Error logs on OS/390. . . . .	619
Error logs on MQSeries for Windows . . . . .	619
Error logs on MQSeries for VSE/ESA . . . . .	619
Error logs on MQSeries for Tandem NSK . . . . .	619

**Part 8. Appendixes . . . . . 621**

<b>Appendix A. Channel planning form . . . . .</b>	<b>623</b>
How to use the form . . . . .	623

**Appendix B. Constants for channels and exits . . . . . 627**

List of constants . . . . .	627
MQ_* (Lengths of character string and byte fields) . . . . .	627
MQCD_* (Channel definition structure length) . . . . .	628
MQCD_* (Channel definition structure version) . . . . .	628
MQCDC_* (Channel data conversion) . . . . .	628
MQCF_* (Channel capability flags) . . . . .	628
MQCHT_* (Channel type) . . . . .	628
MQCXP_* (Channel-exit parameter structure identifier). . . . .	628
MQCXP_* (Channel-exit parameter structure version) . . . . .	629
MQMCAT_* (MCA type) . . . . .	629
MQNPMS_* (Nonpersistent message speed) . . . . .	629

MQPA_* (Put authority) . . . . .	629
MQSID_* (Security identifier) . . . . .	629
MQSIDT_* (Security identifier type) . . . . .	630
MQTXP_* (Transport retry exit structure identifier). . . . .	630
MQTXP_* (Transport retry exit version) . . . . .	630
MQXCC_* (Exit response) . . . . .	630
MQXPT_* (Transmission protocol type). . . . .	630
MQXR_* (Exit reason) . . . . .	630
MQXR2_* (Secondary exit response). . . . .	630
MQXT_* (Exit identifier). . . . .	631
MQXUA_* (Exit user area) . . . . .	631
MQXWD_* (Exit wait descriptor structure identifier). . . . .	631
MQXWD_* (Exit wait descriptor version) . . . . .	631

**Appendix C. Queue name resolution 633**

What is queue name resolution? . . . . .	635
How queue name resolution works . . . . .	636

**Appendix D. Configuration file stanzas for distributed queuing . . . . . 637**

**Appendix E. Notices . . . . . 641**

Programming interface information . . . . .	642
Trademarks . . . . .	643

**Glossary of terms and abbreviations 645**

**Bibliography. . . . . 659**

MQSeries cross-platform publications . . . . .	659
MQSeries platform-specific publications . . . . .	661
Softcopy books . . . . .	662
BookManager format . . . . .	662
HTML format . . . . .	662
Portable Document Format (PDF) . . . . .	662
PostScript format . . . . .	662
Windows Help format . . . . .	662
MQSeries information available on the Internet . . . . .	662
Related publications . . . . .	662
Programming . . . . .	662
OS/390 . . . . .	662
CICS . . . . .	662
OS/400 . . . . .	663
Digital. . . . .	663
SNA . . . . .	663
UNIX . . . . .	663

**Index . . . . . 665**

**Sending your comments to IBM . . . 679**

---

## Figures

1. Overview of the components of distributed queuing . . . . .	4	43. Resetting channel sequence numbers . . . . .	332
2. Sending messages . . . . .	5	44. Resolving in-doubt messages . . . . .	333
3. Sending messages in both directions . . . . .	6	45. Stopping a channel . . . . .	334
4. A cluster of queue managers . . . . .	7	46. Listing channel connections . . . . .	336
5. A sender-receiver channel . . . . .	8	47. Displaying channel connections - first panel . . . . .	337
6. A cluster-sender channel . . . . .	8	48. Displaying channel connections - second panel . . . . .	337
7. A requester-server channel . . . . .	9	49. Listing cluster channels . . . . .	338
8. A requester-sender channel . . . . .	9	50. The message channel example for MQSeries for OS/390 . . . . .	345
9. Channel initiators and listeners . . . . .	11	51. Sample configuration of channel control and MCA . . . . .	352
10. Sequence in which channel exit programs are called . . . . .	13	52. The Message Channel List panel . . . . .	353
11. Passing through intermediate queue managers . . . . .	14	53. The Message Channel List panel pull-down menus . . . . .	355
12. Sharing a transmission queue . . . . .	15	54. The Channel pull-down menu . . . . .	357
13. Using multiple channels . . . . .	15	55. Sender/server Stop action window . . . . .	360
14. The concepts of triggering . . . . .	21	56. Requester/receiver Stop action window . . . . .	361
15. Queue manager alias . . . . .	27	57. The Reset Channel Sequence Number action window . . . . .	363
16. Reply-to queue alias used for changing reply location . . . . .	28	58. The Resolve Channel action window . . . . .	364
17. Network diagram showing all channels . . . . .	30	59. An example of a sender channel Display Channel Status window . . . . .	365
18. Network diagram showing QM-concentrators . . . . .	32	60. An example of a receiver channel Display Channel Status window . . . . .	365
19. A remote queue definition is used to resolve a queue name to a transmission queue to an adjacent queue manager . . . . .	38	61. The Ping action window . . . . .	366
20. The remote queue definition allows a different transmission queue to be used . . . . .	39	62. The Exit confirmation secondary window . . . . .	367
21. Receiving messages directly, and resolving alias queue manager name . . . . .	40	63. The Copy action window . . . . .	368
22. Three methods of passing messages through your system . . . . .	41	64. The Create action window . . . . .	369
23. Separating messages flows . . . . .	43	65. Example of default values during Create for a channel . . . . .	369
24. Combining message flows on to a channel . . . . .	44	66. The Delete action window . . . . .	370
25. Diverting message streams to another destination . . . . .	45	67. The Find a Channel action window . . . . .	370
26. Reply-to queue name substitution during PUT call . . . . .	47	68. The Include search criteria action window . . . . .	371
27. Reply-to queue alias example . . . . .	49	69. The Help pull-down menu . . . . .	372
28. Distributed queue management model . . . . .	58	70. The Help choice pull-down menu . . . . .	373
29. Channel states . . . . .	62	71. The sender channel settings panel . . . . .	376
30. Flows between channel states . . . . .	63	72. The sender channel settings panel - screen 2 . . . . .	376
31. What happens when a message cannot be delivered . . . . .	72	73. The receiver channel settings panel . . . . .	377
32. MQSeries channel to be set up in the example configuration chapters in this book . . . . .	97	74. The receiver channel settings panel - screen 2 . . . . .	377
33. Local LU window . . . . .	205	75. The server channel settings panel . . . . .	378
34. Mode window . . . . .	206	76. The server channel settings panel - screen 2 . . . . .	378
35. CPI-C side information file for SunLink Version 9.0 . . . . .	271	77. The requester channel settings panel . . . . .	379
36. The message channel example for OS/2, Windows NT, and UNIX systems . . . . .	306	78. The requester channel settings panel - screen 2 . . . . .	379
37. The operations and controls initial panel . . . . .	322	79. CICS LU 6.2 connection definition . . . . .	383
38. Listing channels . . . . .	323	80. Connecting two queue managers in MQSeries for OS/390 using CICS . . . . .	387
39. Starting a system function . . . . .	327	81. Sender settings (1) . . . . .	389
40. Stopping a function control . . . . .	328	82. Sender settings (2) . . . . .	390
41. Starting a channel . . . . .	330	83. Connection definition (1) . . . . .	390
42. Testing a channel . . . . .	331	84. Connection definition (2) . . . . .	391
		85. Connection definition (1) . . . . .	391
		86. Connection definition (2) . . . . .	392
		87. Receiver channel settings (1) . . . . .	392
		88. Receiver channel settings (2) . . . . .	393



89. Channel Initiator APPL definition . . . . .	401	122. Sample DEF file for a channel exit on OS/2	523
90. Channel Initiator initialization parameters	401	123. Sample make file for a channel exit on OS/2	523
91. Channel Initiator initialization parameters	405	124. Sample source code for a channel exit on	
92. Create channel (1) . . . . .	427	Windows 3.1 . . . . .	524
93. Create channel (2) . . . . .	428	125. Sample source code for a channel exit on	
94. Create channel (3) . . . . .	428	Windows NT, Windows 95, or Windows 98	525
95. Create channel (4) . . . . .	429	126. Sample DEF file for Windows NT, Windows	
96. Work with channels . . . . .	430	95, Windows 98, or Windows . . . . .	526
97. Display a TCP/IP channel (1) . . . . .	431	127. Sample source code for a channel exit on	
98. Display a TCP/IP channel (2) . . . . .	431	Windows . . . . .	526
99. Display a TCP/IP channel (3) . . . . .	432	128. Sample source code for a channel exit on AIX	527
100. Channel status (1) . . . . .	433	129. Sample compiler and loader commands for	
101. Channel status (2) . . . . .	433	channel exits on AIX . . . . .	527
102. Channel status (3) . . . . .	434	130. Sample export file for AIX . . . . .	528
103. Create a queue (1) . . . . .	441	131. Sample make file for AIX . . . . .	528
104. Create a queue (2) . . . . .	442	132. Sample source code for a channel exit on	
105. Create a queue (3) . . . . .	442	Digital OVMS . . . . .	528
106. Create a queue (4) . . . . .	443	133. Sample source code for a channel exit on	
107. Create process (1) . . . . .	444	DIGITAL UNIX . . . . .	530
108. Create process (2) . . . . .	445	134. Sample compiler and loader commands for	
109. LU 6.2 communication setup panel - initiating		channel exits on DIGITAL UNIX . . . . .	530
end . . . . .	452	135. Sample source code for a channel exit on	
110. LU 6.2 communication setup panel - initiated		HP-UX. . . . .	531
end . . . . .	455	136. Sample compiler and loader commands for	
111. LU 6.2 communication setup panel - initiated		channel exits on HP-UX . . . . .	531
end . . . . .	456	137. Sample source code for a channel exit on	
112. The message channel example for MQSeries		AT&T GIS UNIX . . . . .	531
for AS/400 . . . . .	477	138. Sample compiler and loader commands for	
113. Channel configuration panel . . . . .	501	channel exits on AT&T GIS UNIX. . . . .	532
114. Security exit loop . . . . .	506	139. Sample source code for a channel exit on Sun	
115. Example of a send exit at the sender end of		Solaris . . . . .	532
message channel . . . . .	506	140. Sample compiler and loader commands for	
116. Example of a receive exit at the receiver end		channel exits on Sun Solaris. . . . .	532
of message channel . . . . .	507	141. Sample source code for a channel exit on	
117. Sender-initiated exchange with agreement	509	SINIX and DC/OSx . . . . .	533
118. Sender-initiated exchange with no agreement	510	142. Sample compiler and loader commands for	
119. Receiver-initiated exchange with agreement	511	channel exits on SINIX and DC/OSx. . . . .	533
120. Receiver-initiated exchange with no		143. Security exit flows . . . . .	538
agreement. . . . .	511	144. Name resolution . . . . .	633
121. Sample source code for a channel exit on		145. qm.ini stanzas for distributed queuing	638
OS/2 . . . . .	522		

---

## Tables

1. Example of channel names . . . . .	30	25. Configuration worksheet for AT&T GIS SNA Services . . . . .	243
2. Three ways of using the remote queue definition object . . . . .	37	26. Configuration worksheet for MQSeries for AT&T GIS UNIX . . . . .	253
3. Reply-to queue alias . . . . .	51	27. Configuration worksheet for SunLink Version 9.1 . . . . .	257
4. Queue name resolution at queue manager QMA . . . . .	54	28. Configuration worksheet for MQSeries for Sun Solaris . . . . .	272
5. Queue name resolution at queue manager QMB. . . . .	54	29. Channel tasks . . . . .	324
6. Reply-to queue name translation at queue manager QMA . . . . .	54	30. Settings on the local OS/390 system for a remote queue manager platform . . . . .	341
7. Functions available in OS/2, Windows NT, Digital OpenVMS, Tandem NSK, and UNIX systems . . . . .	106	31. Program and transaction names . . . . .	351
8. Channel attributes for the channel types in OS/2, Windows NT, Digital OpenVMS, Tandem NSK, and UNIX systems . . . . .	111	32. Message Channel List menu-bar choices . . . . .	354
9. Channel programs for OS/2 and Windows NT . . . . .	119	33. Menu-bar choices on channel panels . . . . .	372
10. Channel programs for UNIX systems, Digital OpenVMS, and Tandem NSK . . . . .	119	34. Channel attribute fields per channel type . . . . .	374
11. Default outstanding connection requests on OS/2 and Windows NT . . . . .	125	35. Settings for LU 6.2 TP name on the local OS/390 system for a remote queue manager platform . . . . .	374
12. Settings on the local OS/2 or Windows NT system for a remote queue manager platform . . . . .	126	36. Configuration worksheet for OS/390 using LU 6.2 . . . . .	396
13. Default outstanding connection requests on OS/2 and Windows NT . . . . .	132	37. Configuration worksheet for MQSeries for OS/390 . . . . .	406
14. Configuration worksheet for Communications Manager/2 . . . . .	138	38. Channel attribute fields per message channel type. . . . .	435
15. Configuration worksheet for MQSeries for OS/2 Warp . . . . .	164	39. Program and transaction names . . . . .	445
16. Configuration worksheet for IBM Communications Server for Windows NT . . . . .	170	40. Channel states on OS/400 . . . . .	446
17. Configuration worksheet for MQSeries for Windows NT . . . . .	185	41. Settings on the local OS/400 system for a remote queue manager platform . . . . .	451
18. Default outstanding connection requests . . . . .	193	42. Configuration worksheet for SNA on an AS/400 system . . . . .	460
19. Settings on the local UNIX system for a remote queue manager platform . . . . .	194	43. Configuration worksheet for MQSeries for AS/400 . . . . .	472
20. Configuration worksheet for Communications Server for AIX . . . . .	197	44. Configuration worksheet for VSE/ESA using APPC . . . . .	485
21. Configuration worksheet for MQSeries for AIX . . . . .	211	45. Configuration worksheet for MQSeries for VSE/ESA . . . . .	490
22. Configuration worksheet for MQSeries for DIGITAL UNIX (Compaq Tru64 UNIX) . . . . .	216	46. Channel exits available for each channel type . . . . .	505
23. Configuration worksheet for HP SNAplus2 . . . . .	219	47. Identifying API calls . . . . .	514
24. Configuration worksheet for MQSeries for HP-UX. . . . .	239	48. Fields in MQCD . . . . .	556
		49. Fields in MQCXP . . . . .	591
		50. Fields in MQTXP . . . . .	605
		51. Fields in MQXWD . . . . .	609
		52. Channel planning form . . . . .	625
		53. Channel planning form . . . . .	626





---

## About this book

This book describes intercommunication between MQSeries products. It introduces the concepts of intercommunication; transmission queues, message channel agent programs, and communication links, that are brought together to form message channels. It describes how geographically separated queue managers are linked together by message channels to form a network of queue managers. It discusses the distributed-queuing management (DQM) facility of IBM® MQSeries, which provides the services that enable applications to communicate via queue managers.

DQM provides communications that conform to the MQSeries Message Channel Protocol. Each MQSeries product has its own implementation of this specification, and this book is concerned with these implementations.

---

## Who this book is for

This book is for anyone needing a description of DQM. In addition, the following readers are specifically addressed:

- Network planners responsible for designing the overall queue manager network.
- Local channel planners responsible for implementing the network plan on one node.
- Application programmers responsible for designing applications that include processes, queues, and channels, perhaps without the assistance of a systems administrator.
- Systems administrators responsible for monitoring the local system, controlling exception situations, and implementing some of the planning details.
- System programmers with responsibility for designing and programming the user exits.

---

## What you need to know to understand this book

To use and control DQM you need to have a good knowledge of MQSeries in general. You also need to understand the MQSeries products for the specific platforms you will be using, and the communications protocols that will be used on those platforms.

## How to use this book

This book has the following parts:

**“Part 1. Introduction” on page 1**

Introduces the concepts of MQSeries intercommunication.

**“Part 2. How intercommunication works” on page 33**

Describes the functions performed by the distributed-queuing management (DQM) facilities. Read this part to understand DQM’s role in the context of MQSeries.

**“Part 3. DQM in MQSeries for OS/2 Warp, Windows NT, Digital OpenVMS, Tandem NSK, and UNIX systems” on page 101**

Is specific to MQSeries products on distributed platforms. It helps you to install and customize DQM on these platforms. It explains how to establish message channels to other systems and how to manage and control them.

**“Part 4. DQM in MQSeries for OS/390” on page 319**

Is specific to MQSeries for OS/390. It helps you to install and customize DQM. It explains how to establish message channels to other systems and how to manage and control them.

**“Part 5. DQM in MQSeries for AS/400” on page 421**

Is specific to MQSeries for AS/400. It helps you to install and customize DQM. It explains how to establish message channels to other systems and how to manage and control them.

**“Part 6. DQM in MQSeries for VSE/ESA” on page 483**

Is specific to MQSeries for VSE/ESA. It contains an example of how to set up communication to other systems.

**“Part 7. Further intercommunication considerations” on page 503**

Tells you about channel exit programs, which are an optional feature of DQM that allow you to add your own facilities to distributed queuing. It gives some guidance on the problems you may experience, how to recognize these problems, and what to do about them.

**The Appendixes**

contain extra information that is pertinent to DQM:

Appendix A. Channel planning form gives an explanation of one suggested method of planning and maintaining DQM objects and channels.

Appendix B. Constants for channels and exits gives the values of named constants that apply to the channels and exits in the MQI that are discussed in this book.

Appendix C. Queue name resolution provides a detailed description of name resolution by queue managers. You need to understand this process in order to take full advantage of DQM.

Appendix D. Configuration file stanzas for distributed queuing gives information about the configuration file stanzas that relate to distributed queuing.

## Appearance of text in this book

This book uses the following type styles:

*CompCode*

Example of the name of a parameter of a call

## Terms used in this book

In the body of this book, the following shortened names are used:

**CICS®** The CICS Transaction Server for OS/390 (CICS/Enterprise Systems Architecture) product. (Note that, unlike other MQSeries books, this book does not use the term generically to include other CICS products such as CICS for VSE/ESA.)

**OS/2** OS/2 Warp

**OS/390**

In general, function described in this book as supported by MQSeries for OS/390 is also supported by MQSeries for MVS/ESA™.

The term “UNIX systems” is used to denote the following UNIX operating systems:

- AIX
- AT&T GIS UNIX
- Digital UNIX (Compaq Tru64 UNIX)
- HP-UX
- SINIX and DC/OSx
- Sun Solaris

Throughout this book, the name `mqmtop` has been used to represent the name of the base directory where MQSeries is installed on UNIX systems.

- For AIX, the name of the actual directory is `/usr/mqm`
- For other UNIX systems, the name of the actual directory is `/opt/mqm`

There is a glossary and a bibliography at the back of the book.

## About this book

---

## Summary of changes

This information describes changes to the MQSeries product and changes to this edition of the *MQSeries Intercommunication* book.

Changes since the previous edition of the book are marked in the left-hand margin with vertical bars.

---

### Changes for this edition (SC33-1872-03)

This edition of *MQSeries Intercommunication* includes:

- Addition of support for MQSeries for AS/400 V5.1.
- Addition of support for MQSeries for DIGITAL UNIX (Compaq Tru64 UNIX), V2.2.1.
- Addition of support for MQSeries for Tandem NonStop Kernel, V2.2.0.1.

---

### Changes for the previous edition (SC33-1872-02)

The previous edition of *MQSeries Intercommunication* applies to the following versions and releases of MQSeries products:

- MQSeries for AIX V5.1
- MQSeries for AS/400 V4R2M1
- MQSeries for HP-UX V5.1
- MQSeries for OS/2 Warp V5.1
- MQSeries for OS/390 V2.1
- MQSeries for Sun Solaris V5.1
- MQSeries for VSE/ESA V2.1
- MQSeries for Windows NT V5.1

Major new function supplied with each of these MQSeries products is summarized below:

- Additional new function and changes in MQSeries for OS/390
  - Automatic Restart Manager (ARM).
  - TCP OpenEdition<sup>®</sup> sockets interface.
  - Screens in “Chapter 23. Monitoring and controlling channels on OS/390” on page 321.
- MQSeries queue manager clusters implemented on MQSeries for AIX, HP-UX, OS/2 Warp, OS/390, Sun Solaris, and Windows NT.
- Using the TCP listener backlog option on UNIX systems.
- Additional new function in MQSeries for AIX, V5.1
  - The UDP transport protocol is supported.
  - Sybase databases can participate in global units of work.
  - Multithreaded channels are supported.
  - “Configuration parameters for an LU 6.2 connection” on page 197.
- Additional new function in MQSeries for HP-UX, V5.1
  - MQSeries for HP-UX, V5.1 runs on both HP-UX V10.20 and HP-UX V11.0.
  - Multithreaded channels are supported.
  - Both HP-UX kernel threads and DCE threads are supported.

## Changes

- Additional new function in MQSeries for Sun Solaris, V5.1
  - MQSeries for Sun Solaris, V5.1 runs on both Sun Solaris V2.6 and Sun Solaris 7.
  - Sybase databases can participate in global units of work.
  - Multithreaded channels are supported.
  - “Establishing a connection using SunLink Version 9.1” on page 261.
- Windows NT registry—now used to hold all configuration and related data. The contents of any configuration (.INI) files from previous MQSeries installations of MQSeries for Windows NT products are migrated into the registry; the .INI files are then deleted.
- “MQSeries for VSE/ESA configuration” on page 490.
- Transport-retry exit program for MQSeries for AIX V5.1 and MQSeries for Windows V2.0.
- ADOPTNEWMCA, ADOPTNEWMCATIMEOUT, and ADOPTNEWMCACHECK configuration stanzas.

---

## Changes for the second edition (SC33-1872-01)

Major changes for the second edition include:

- Addition of support for MQSeries for AS/400 V4R2.
- Addition of support for MQSeries for Tandem NonStop Kernel, V2.2.
- Addition of an example LU 6.2 configuration using IBM Communications Server for Windows NT.
- Technical improvements throughout the book.

---

## Part 1. Introduction

<b>Chapter 1. Concepts of intercommunication</b> . . . . .	3	How to send a message to another queue manager	17
What is intercommunication? . . . . .	3	Defining the channels . . . . .	18
How does distributed queuing work? . . . . .	3	Defining the queues . . . . .	19
What do we call the components? . . . . .	4	Sending the messages . . . . .	20
Components needed to send a message . . . . .	5	Starting the channel . . . . .	20
Components needed to return a message . . . . .	5	Triggering channels. . . . .	20
Cluster components . . . . .	6	Safety of messages . . . . .	22
Distributed queuing components . . . . .	7	Fast, nonpersistent messages . . . . .	22
Message channels. . . . .	7	Undelivered messages. . . . .	23
Sender-receiver channels . . . . .	8	<b>Chapter 3. More about intercommunication</b> . . . . .	25
Server-receiver channel . . . . .	8	Addressing information . . . . .	25
Cluster-sender channels. . . . .	8	What are aliases? . . . . .	25
Requester-server channel . . . . .	9	Queue name resolution . . . . .	26
Requester-sender channel . . . . .	9	Queue manager alias definitions . . . . .	26
Cluster-receiver channels . . . . .	9	Outbound messages - remapping the queue manager name . . . . .	26
Message channel agents . . . . .	9	Outbound messages - altering or specifying the transmission queue. . . . .	27
Transmission queues . . . . .	10	Inbound messages - determining the destination	27
Channel initiators and listeners. . . . .	10	Reply-to queue alias definitions . . . . .	28
Channel-exit programs . . . . .	12	What is a reply-to queue alias definition? . . . . .	28
Dead-letter queues . . . . .	13	Reply-to queue name . . . . .	29
Remote queue definitions. . . . .	14	Networks . . . . .	29
How to get to the remote queue manager . . . . .	14	Channel and transmission queue names. . . . .	29
Multi-hopping . . . . .	14	Network planner . . . . .	31
Sharing channels . . . . .	14		
Using different channels . . . . .	15		
Using clustering. . . . .	16		
<b>Chapter 2. Making your applications communicate</b> . . . . .	17		

This part of the book introduces MQSeries intercommunication. The description in this part is general, and is not restricted to a particular platform or system.

**Note:** Some references are made to individual MQSeries products. Details are given only for the products that this edition of the book applies to (see the edition notice for information about which MQSeries products these are).

## Introduction



---

## Chapter 1. Concepts of intercommunication

This chapter introduces the concepts of intercommunication in MQSeries.

- The basic concepts of intercommunication are explained in “What is intercommunication?”
- The objects that you need for intercommunication are described in “Distributed queuing components” on page 7.

This chapter goes on to introduce:

- “Dead-letter queues” on page 13
- “Remote queue definitions” on page 14
- “How to get to the remote queue manager” on page 14

---

### What is intercommunication?

In MQSeries, intercommunication means sending messages from one queue manager to another. The receiving queue manager could be on the same machine or another; nearby or on the other side of the world. It could be running on the same platform as the local queue manager, or could be on any of the platforms supported by MQSeries. This is called a *distributed* environment. MQSeries handles communication in a distributed environment such as this using Distributed Queue Management (DQM).

The local queue manager is sometimes called the *source queue manager* and the remote queue manager is sometimes called the *target queue manager* or the *partner queue manager*.

### How does distributed queuing work?

Figure 1 on page 4 shows an overview of the components of distributed queuing.

## What is intercommunication?

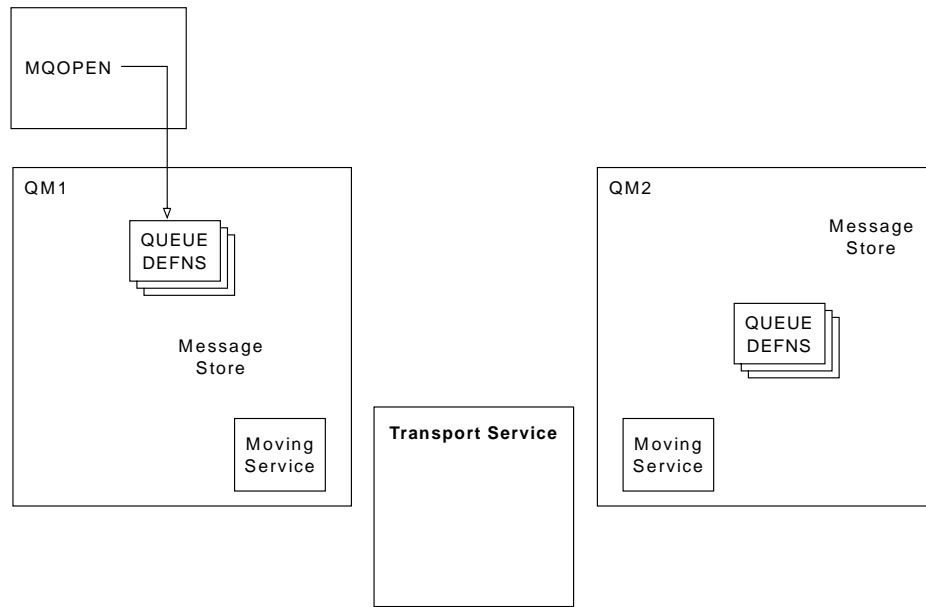

Figure 1. Overview of the components of distributed queuing

1. An application uses the MQOPEN call to open a queue so that it can put messages on it.
2. A queue manager has a definition for each of its queues, specifying information such as the maximum number of messages allowed on the queue.
3. If the messages are destined for a queue on a remote system, the local queue manager holds them in a message store until it is ready to forward them to the remote queue manager. This can be transparent to the application.
4. Each queue manager contains communications software called the *moving service* component; through this, the queue manager can communicate with other queue managers.
5. The *transport service* is independent of the queue manager and can be any one of the following (depending on the platform):
  - Systems Network Architecture Advanced Program-to Program Communication (SNA APPC)
  - Transmission Control Protocol/Internet Protocol (TCP/IP)
  - Network Basic Input/Output System (NetBIOS)
  - Sequenced Packet Exchange (SPX)
  - User-Datagram Protocol (UDP)

## What do we call the components?

1. MQSeries applications put messages onto a local queue, that is, a queue on the same queue manager.
2. A queue manager has a definition for each of its queues. It may also have definitions for queues that are owned by other queue managers. These are called *remote queue definitions*.
3. If the messages are destined for a remote queue manager, the local queue manager stores them on a *transmission queue* until it is ready to send them to the remote queue manager. A transmission queue is a special type of local queue on which messages are stored until they can be successfully transmitted and stored at the remote queue manager.
4. The software that handles the sending and receiving of messages is called the *Message Channel Agent (MCA)*.

## What is intercommunication?

5. Messages are transmitted between queue managers on a *channel*. A channel is a one-way communication link between two queue managers. It can carry messages destined for any number of queues at the remote queue manager.

### Components needed to send a message

If a message is to be sent to a remote queue manager, the local queue manager needs definitions for a transmission queue and a channel.

Each end of a channel has a separate definition, defining it, for example, as the sending end or the receiving end. A simple channel consists of a *sender* channel definition at the local queue manager and a *receiver* channel definition at the remote queue manager. These two definitions must have the same name, and together constitute one channel.

There is also a *message channel agent* (MCA) at each end of a channel.

Each queue manager should have a *dead-letter queue*. Messages are put on this queue if, for some reason, they cannot be delivered to their destination.

Figure 2 shows the relationship between queue managers, transmission queues, channels, and MCAs.

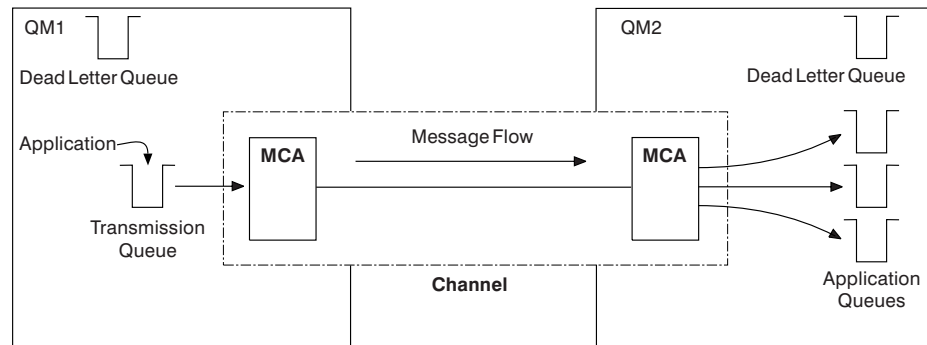

Figure 2. Sending messages

### Components needed to return a message

If your application requires messages to be returned from the remote queue manager, you need to define another channel, to run in the opposite direction between the queue managers, as shown in Figure 3 on page 6.

## What is intercommunication?

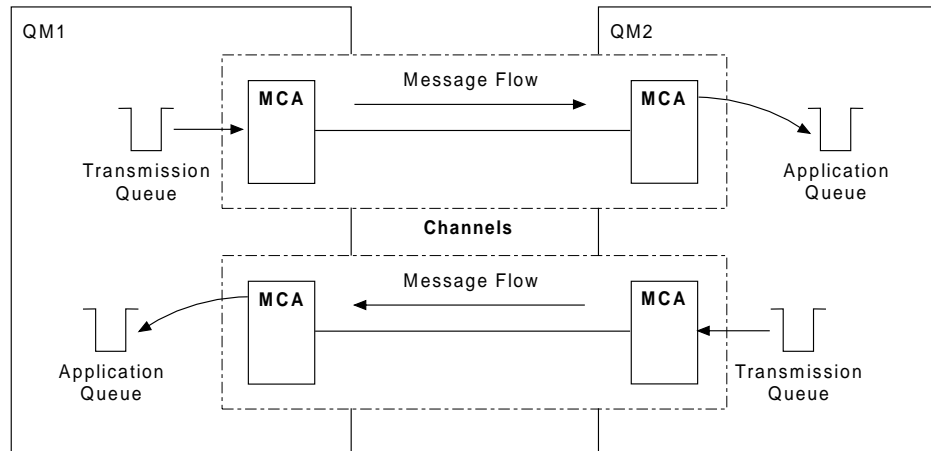

Figure 3. Sending messages in both directions

### Cluster components

An alternative to the traditional MQSeries network is the use of clusters. Clusters are supported on V5.1 of MQSeries for AIX, AS/400, HP-UX, OS/2 Warp, Sun Solaris, and Windows NT and MQSeries for OS/390 only.

A cluster is a network of queue managers that are logically associated in some way. You can group queue managers in a cluster so that queue managers can make the queues that they host available to every other queue manager in the cluster. Assuming you have the necessary network infrastructure in place, any queue manager can send a message to any other queue manager in the same cluster without the need for explicit channel definitions, remote-queue definitions, or transmission queues for each destination. Every queue manager in a cluster has a single transmission queue that transmits messages to any other queue manager in the cluster. Each queue manager needs to define only one cluster-receiver channel and one cluster-sender channel.

Figure 4 on page 7 shows the components of a cluster called CLUSTER:

- CLUSTER contains three queue managers, QM1, QM2, and QM3.
- QM1 and QM2 host repositories of information about the queue managers and queues in the cluster.
- QM2 and QM3 host some cluster queues, that is, queues that are accessible to any other queue manager in the cluster.
- Each queue manager has a cluster-receiver channel called TO.qmgr on which it can receive messages.
- Each queue manager also has a cluster-sender channel on which it can send information to one of the repository queue managers.
- QM1 and QM3 send to the repository at QM2 and QM2 sends to the repository at QM1.

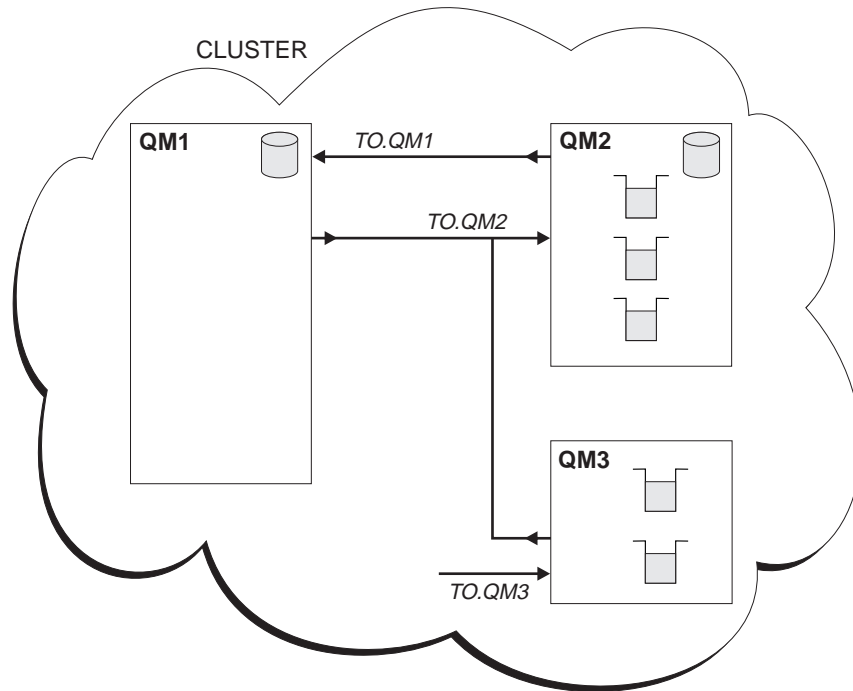

Figure 4. A cluster of queue managers

As with distributed queuing, you use the MQPUT call to put a message to a queue at any queue manager. You use the MQGET call to retrieve messages from a local queue.

For further information about clusters, see the *MQSeries Queue Manager Clusters* book.

---

## Distributed queuing components

This section describes the components of distributed queuing. These are:

- Message channels
- Message channel agents
- Transmission queues
- Channel initiators and listeners
- Channel-exit programs

### Message channels

Message channels are the channels that carry messages from one queue manager to another.

Do not confuse message channels with MQI channels. There are two types of MQI channel, server-connection and client-connection. These are discussed in the *MQSeries Clients* book.

The definition of each end of a message channel can be one of the following types:

- Sender
- Receiver
- Server
- Requester
- Cluster sender
- Cluster receiver

## Distributed queuing components

A message channel is defined using one of these types defined at one end, and a compatible type at the other end. Possible combinations are:

- Sender-receiver
- Requester-server
- Requester-sender (callback)
- Server-receiver
- Cluster sender-cluster receiver

### Sender-receiver channels

A sender in one system starts the channel so that it can send messages to the other system. The sender requests the receiver at the other end of the channel to start. The sender sends messages from its transmission queue to the receiver. The receiver puts the messages on the destination queue.

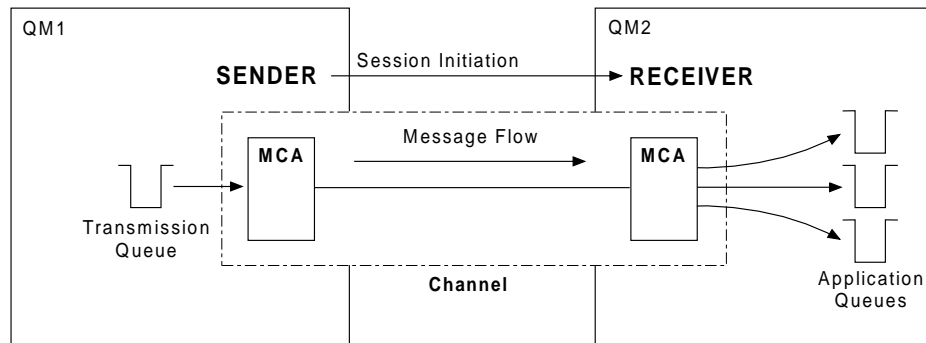

Figure 5. A sender-receiver channel

### Server-receiver channel

This is similar to sender-receiver but applies only to *fully qualified* servers, that is server channels that have the connection name of the partner specified in the channel definition. Channel startup must be initiated at the server end of the link. The illustration of this is similar to the illustration in Figure 5.

### Cluster-sender channels

In a cluster, each queue manager has a cluster-sender channel on which it can send cluster information to one of the repository queue managers. Queue managers can also send messages to other queue managers on cluster-sender channels.

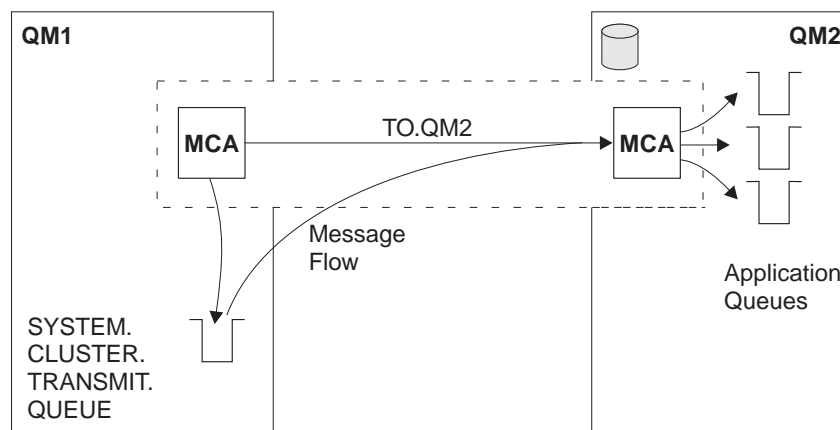

Figure 6. A cluster-sender channel

### Requester-server channel

A requester in one system starts the channel so that it can receive messages from the other system. The requester requests the server at the other end of the channel to start. The server sends messages to the requester from the transmission queue defined in its channel definition.

A server channel can also initiate the communication and send messages to a requester, but this applies only to *fully qualified* servers, that is server channels that have the connection name of the partner specified in the channel definition. A fully qualified server may either be started by a requester, or may initiate a communication with a requester.

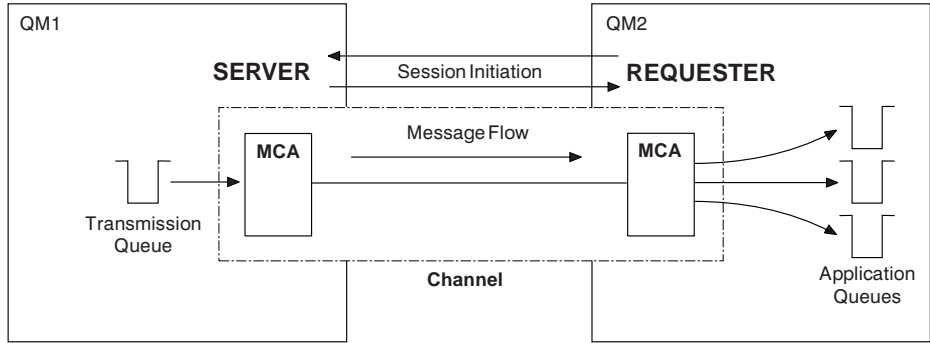

Figure 7. A requester-server channel

### Requester-sender channel

The requester starts the channel and the sender terminates the call. The sender then restarts the communication according to information in its channel definition (this is known as *callback*). It sends messages from the transmission queue to the requester.

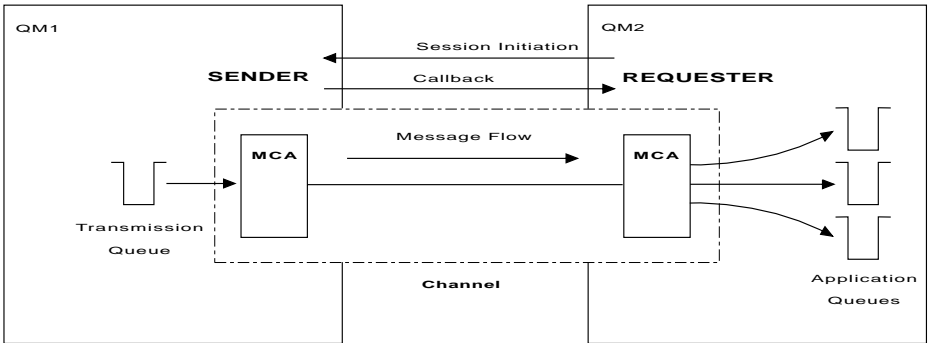

Figure 8. A requester-sender channel

### Cluster-receiver channels

In a cluster, each queue manager has a cluster-receiver channel on which it can receive messages and information about the cluster. The illustration of this is similar to the illustration in Figure 6 on page 8.

## Message channel agents

A *message channel agent* (MCA) is a program that controls the sending and receiving of messages. There is one message channel agent at each end of a channel. One

## Distributed queuing components

MCA takes messages from the transmission queue and puts them on the communication link. The other MCA receives messages and delivers them to the remote queue manager.

A message channel agent is called a *caller MCA* if it initiated the communication or, otherwise, is called a *responder MCA*. A caller MCA may be associated with a sender, server (fully qualified), or requester channel. A responder MCA, may be associated with any type of message channel.

## Transmission queues

A *transmission queue* is a special type of local queue used to store messages temporarily before they are transmitted by the MCA to the remote queue manager. In a distributed-queuing environment, you need to define one transmission queue for each sending MCA.

You specify the name of the transmission queue in a *remote queue definition*, (see “Remote queue definitions” on page 14). If you do not specify the name, the queue manager looks for a transmission queue with the same name as the remote queue manager.

You can specify the name of a default transmission queue for the queue manager. This is used if you do not specify the name of the transmission queue, and a transmission queue with the same name as the remote queue manager does not exist.

## Channel initiators and listeners

A *channel initiator* acts as a *trigger monitor* for sender MCAs, because a transmission queue may be defined as a triggered queue. When a message arrives on a transmission queue that satisfies the triggering criteria for that queue, a message is sent to the initiation queue, triggering the channel initiator to start the appropriate sender MCA. You can also start server MCAs in this way if you specified the connection name of the partner in the channel definition. This means that channels can be started automatically, based upon messages arriving on the appropriate transmission queue.

You need a *channel listener* program to start receiving (responder) MCAs. Responder MCAs are started in response to a startup request from the sending MCA; the channel listener detects incoming network requests and starts the associated channel.

Figure 9 on page 11 shows how channel initiators and channel listeners are used.



## Distributed queuing components

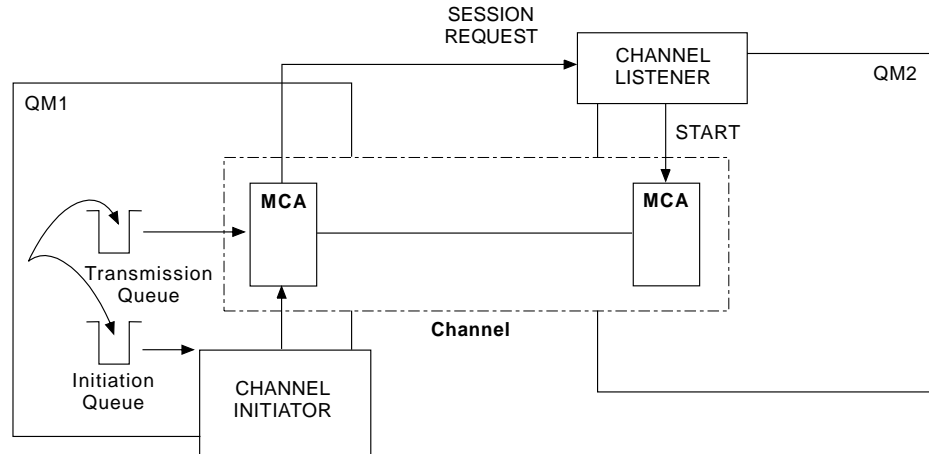

Figure 9. Channel initiators and listeners

The implementation of channel initiators is platform specific.

- On OS/390 without CICS, there is one channel initiator for each queue manager and it runs as a separate address space. You start it using the MQSeries command `START CHINIT`, which you would normally issue as part of your queue manager startup. It monitors the system-defined queue `SYSTEM.CHANNEL.INITQ`, which is the initiation queue for all the transmission queues.
- On OS/390, if you are using CICS for distributed queuing, there is no channel initiator. To implement triggering, use the CICS trigger monitor transaction, `CKTL`, to monitor the initiation queue.
- MQSeries for Windows does not support triggering and does not have channel initiators.
- On other platforms, you can start as many channel initiators as you like, specifying a name for the initiation queue for each one. Normally you need only one initiator. V5.1 of MQSeries for AIX, AS/400, HP-UX, OS/2 Warp, Sun Solaris, and Windows NT allows you to start three, by default, but you can change this value. On these platforms that support clustering, when you start a queue manager, a channel initiator is automatically started too.

The channel initiator is also required for other functions, discussed later in this book.

The implementation of channel listeners is platform specific.

- Use the channel listener programs provided by MQSeries if you are using native OS/390 communications for distributed queuing, MQSeries for Compaq (DIGITAL) OpenVMS, MQSeries for Tandem NonStop Kernel, or MQSeries for Windows,
- If you are using CICS for distributed queuing on OS/390, you do not need a channel listener because CICS provides this function.
- On OS/400, use the channel listener program provided by MQSeries if you are using TCP/IP. If you are using SNA, you do not need a listener program. SNA starts the channel by invoking the receiver program on the remote system.
- On OS/2 and Windows NT, you can use either the channel listener program provided by MQSeries, or the facilities provided by the 'operating system' (for example, Attach manager for LU 6.2 communications on OS/2). If performance is important in your environment and if the environment is stable, you can choose to run the MQSeries listener as a trusted application as described in

## Distributed queuing components

“Running channels and listeners as trusted applications” on page 121. See the *MQSeries Application Programming Guide* for information about trusted applications.

- On UNIX systems, use the channel listener program provided by MQSeries or the facilities provided by the ‘operating system’ (for example, inetd for TCP/IP communications).

## Channel-exit programs

If you want to do some additional processing (for example, encryption or data compression) you can write your own channel-exit programs, or sometimes use SupportPacs. The Transaction Processing SupportPacs library for MQSeries is available on the Internet at: > >

<http://www.ibm.com/software/ts/mqseries/txppacs/>

MQSeries calls channel-exit programs at defined places in the processing carried out by the MCA. There are six types of channel exit:

### Security exit

Used for security checking.

### Message exit

Used for operations on the message, for example, encryption prior to transmission.

### Send and receive exits

Used for operations on split messages, for example, data compression and decompression.

### Message-retry exit

Used when there is a problem putting the message to the destination

### Channel auto-definition exit

Used to modify the supplied default definition for an automatically defined receiver or server-connection channel.

### Transport-retry exit

Used to suspend data being sent on a channel when communication is not possible.

The sequence of processing is as follows:

1. The security exits are called after the initial data negotiation between both ends of the channel. These must end successfully for the startup phase to complete and to allow messages to be transferred.
2. The message exit is called by the sending MCA, and then the send exit is called for each part of the message that is transmitted to the receiving MCA.
3. The receiving MCA calls the receive exit when it receives each part of the message, and then calls the message exit when the whole message has been received.

This is illustrated in Figure 10 on page 13.

## Distributed queuing components

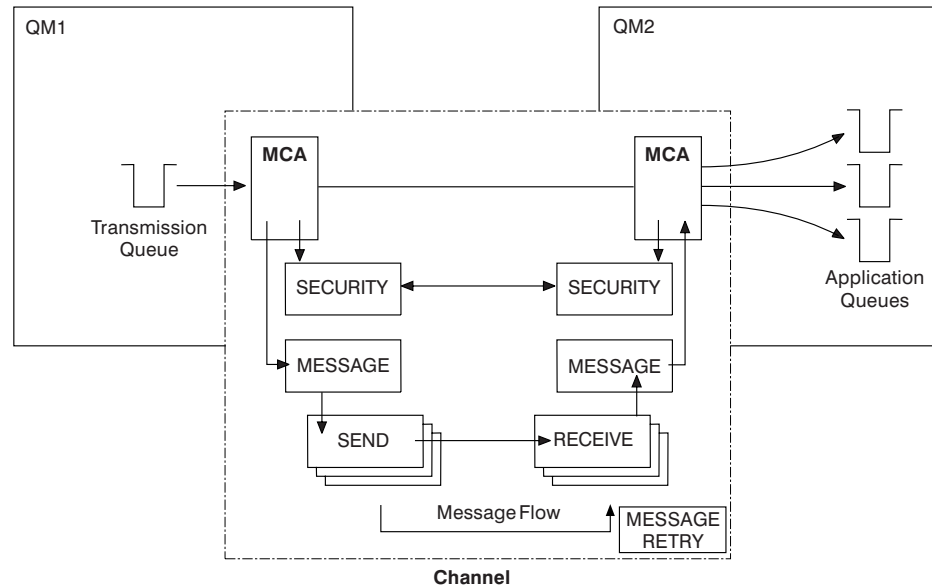

Figure 10. Sequence in which channel exit programs are called

The *message-retry exit* is used to determine how many times the receiving MCA will attempt to put a message to the destination queue before taking alternative action. This exit program is described in “MQ\_CHANNEL\_EXIT - Channel exit” on page 546. It is not supported on MQSeries for Windows.

For more information about channel exits, see “Chapter 36. Channel-exit programs” on page 505.

---

## Dead-letter queues

The *dead-letter queue* (or undelivered-message queue) is the queue to which messages are sent if they cannot be routed to their correct destination. Messages are put on this queue when they cannot be put on the destination queue for some reason (for example, because the queue does not exist, or because it is full). Dead-letter queues are also used at the sending end of a channel, for data-conversion errors.

We recommend that you define a dead-letter queue for each queue manager. If you do not, and the MCA is unable to put a message, it is left on the transmission queue and the channel is stopped.

Also, if fast, nonpersistent messages (see “Fast, nonpersistent messages” on page 22) cannot be delivered and no DLQ exists on the target system, these messages are discarded.

However, using dead-letter queues can affect the sequence in which messages are delivered, and so you may choose not to use them.

Dead-letter queues are not supported on MQSeries for Windows.

## Remote queue definitions

Whereas applications can retrieve messages only from local queues, they can put messages on local queues or remote queues. Therefore, as well as a definition for each of its local queues, a queue manager may have *remote queue definitions*. These are definitions for queues that are owned by another queue manager. The advantage of remote queue definitions is that they enable an application to put a message to a remote queue without having to specify the name of the remote queue or the remote queue manager, or the name of the transmission queue. This gives you location independence.

There are other uses for remote queue definitions, which will be described later.

## How to get to the remote queue manager

You may not always have one channel between each source and target queue manager. Consider these alternative possibilities.

### Multi-hopping

If there is no direct communication link between the source queue manager and the target queue manager, it is possible to pass through one or more *intermediate queue managers* on the way to the target queue manager. This is known as a *multi-hop*.

You need to define channels between all the queue managers, and transmission queues on the intermediate queue managers. This is shown in Figure 11.

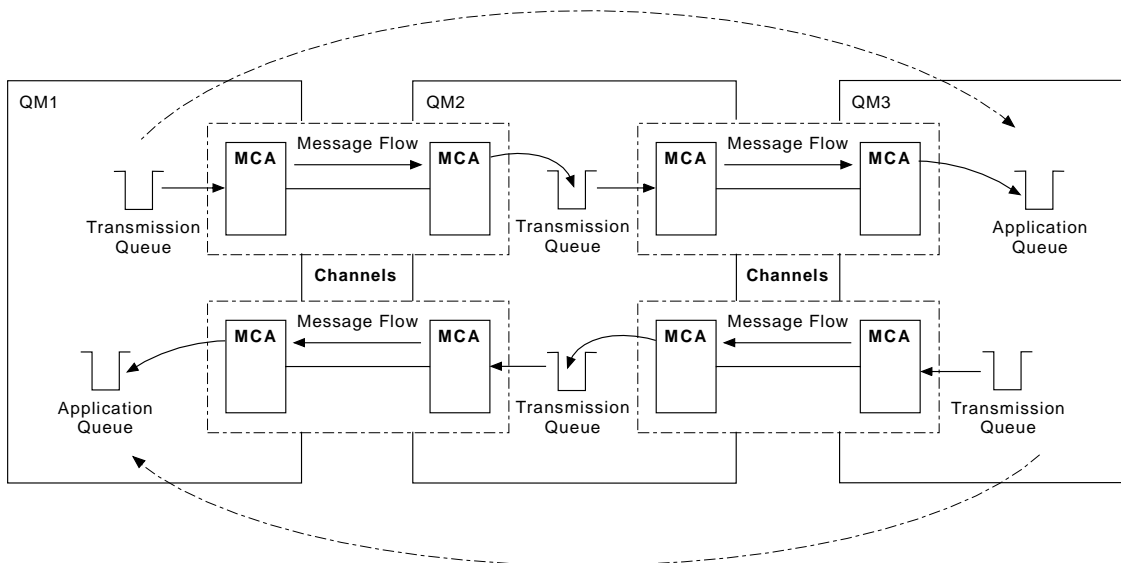

Figure 11. Passing through intermediate queue managers

### Sharing channels

As an application designer, you have the choice of 1) forcing your applications to specify the remote queue manager name along with the queue name, or 2) creating a *remote queue definition* for each remote queue to hold the remote queue manager name, the queue name, and the name of the transmission queue. Either way, all messages from all applications addressing queues at the same remote location have

their messages sent through the same transmission queue. This is shown in Figure 12.

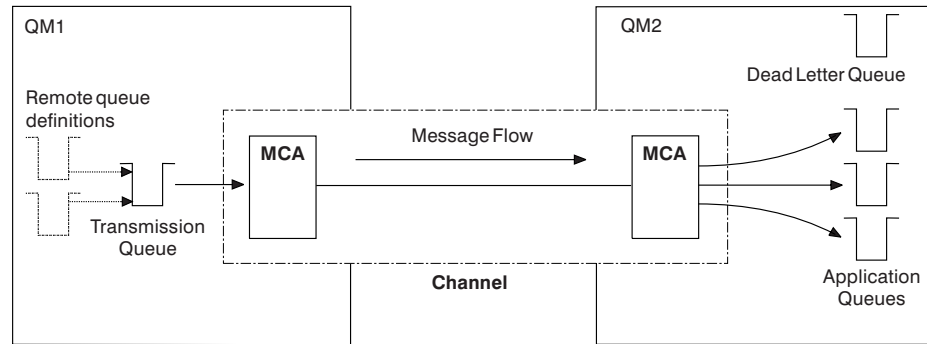

Figure 12. Sharing a transmission queue

Figure 12 illustrates that messages from multiple applications to multiple remote queues can use the same channel.

## Using different channels

If you have messages of different types to send between two queue managers, you can define more than one channel between the two. There are times when you need alternative channels, perhaps for security purposes, or to trade off delivery speed against sheer bulk of message traffic.

To set up a second channel you need to define another channel and another transmission queue, and create a remote queue definition specifying the location and the transmission queue name. Your applications can then use either channel but the messages will still be delivered to the same target queues. This is shown in Figure 13.

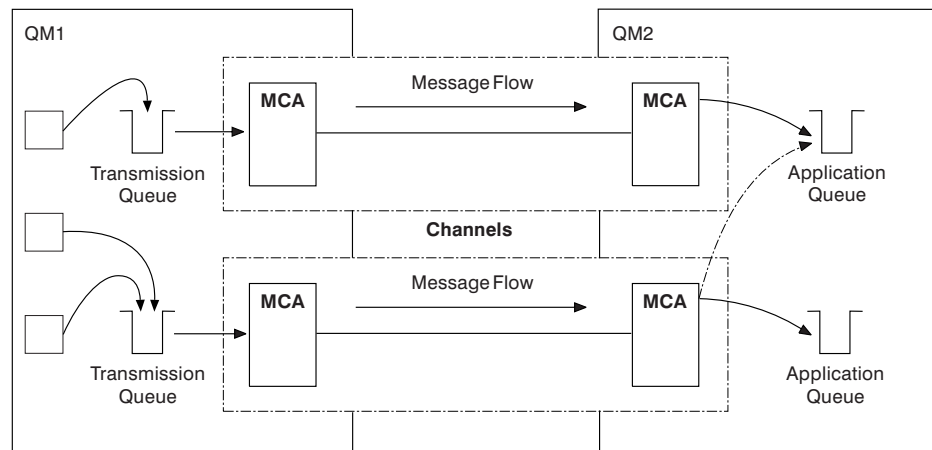

Figure 13. Using multiple channels

When you use remote queue definitions to specify a transmission queue, your applications must **not** specify the location (that is, the destination queue manager) themselves. If they do, the queue manager will not make use of the remote queue definitions. Remote queue definitions make the location of queues and the transmission queue transparent to applications. Applications can put messages to a

## Getting to remote queue manager

*logical* queue without knowing where the queue is located and you can alter the *physical* queue without having to change your applications.

## Using clustering

Every queue manager within a cluster defines a cluster-receiver channel and when another queue manager wants to send a message to that queue manager, it defines the corresponding cluster-sender channel automatically. For example, if there is more than one instance of a queue in a cluster, the cluster-sender channel could be defined to any of the queue managers that host the queue. MQSeries uses a workload management algorithm that uses a round-robin routine to select the best queue manager to route a message to. For more information about this, see the *MQSeries Queue Manager Clusters* book.

---

## Chapter 2. Making your applications communicate

This chapter provides more detailed information about intercommunication between MQSeries products. Before reading this chapter it is helpful to have an understanding of channels, queues, and the other concepts introduced in “Chapter 1. Concepts of intercommunication” on page 3.

This chapter covers the following topics:

- “How to send a message to another queue manager”
- “Triggering channels” on page 20
- “Safety of messages” on page 22

---

### How to send a message to another queue manager

This section describes the simplest way to send a message from one queue manager to another.

Before you do this you need to do the following:

1. Check that your chosen communication protocol is available.
2. Start the queue managers.
3. Start the channel initiators.
4. Start the listeners.

On MQSeries for Windows, instead of steps 2, 3, and 4, you start a *connection*, which includes a queue manager, channels, and a listener. See the *MQSeries for Windows User's Guide* for more information.

You also need to have the correct MQSeries security authorization (except on MQSeries for Windows) to create the objects required.

To send messages from one queue manager to another:

- Define the following objects on the source queue manager:
  - Sender channel
  - Remote queue
  - Initiation queue (required on OS/390, otherwise optional)
  - Transmission queue
  - Dead-letter queue (recommended)
  - Process (required on OS/390, otherwise optional)
- Define the following objects on the target queue manager:
  - Receiver channel
  - Target queue
  - Dead-letter queue (recommended)

You can use several different methods to define these objects, depending on your MQSeries platform:

#### **OS/390 or MVS/ESA**

If you are using native OS/390 communications, you can use the Operation and Control panels or information from the *MQSeries Command Reference* book. If you are using CICS for distributed queuing, you must use the supplied CICS application CKMC for channels.

## Sending messages

### OS/400®

You can use the panel interface, the control language (CL) commands described in the *MQSeries for AS/400 System Administration*, MQSeries commands described in the *MQSeries Command Reference* book, or the programmable command format (PCF) commands described in the *MQSeries Programmable System Management* book.

### MQSeries for Windows

You can use MQSC commands, PCF commands, or the MQSeries properties dialog. Not all MQSC and PCF commands are supported; see the *MQSeries for Windows User's Guide*.

**Note:** On MQSeries for Windows there is no initiation queue, dead-letter queue, or process.

### OS/2, Windows NT, UNIX systems, and Digital OpenVMS

You can use the MQSeries commands described in the *MQSeries Command Reference* book, or the PCF commands described in the *MQSeries Programmable System Management* book. On Windows NT only, you can also use the graphical user interfaces, the MQSeries explorer and the MQSeries Web Administration.

### Tandem NSK

You can use MQSC commands, PCF commands, or the Message Queue Management facility. See the *MQSeries for Tandem NonStop Kernel System Management Guide* for more information about the control commands and the Message Queue Management facility.

### VSE/ESA

You can use the panel interface as described in the *MQSeries for VSE/ESA System Management Guide*.

The different methods are described in more detail in the platform-specific parts of this book.

## Defining the channels

To send messages from one queue manager to another, you need to define two channels; one on the source queue manager and one on the target queue manager.

### On the source queue manager

Define a channel with a channel type of SENDER. You need to specify the following:

- The name of the transmission queue to be used (the XMITQ attribute).
- The connection name of the partner system (the CONNAME attribute).
- The name of the communication protocol you are using (the TRPTYPE attribute). For V5.1 of MQSeries for AIX, AS/400, HP-UX, OS/2 Warp, Sun Solaris, and Windows NT, and MQSeries for Windows, you do not have to specify this. You can leave it to pick up the value from your default channel definition. On MQSeries for Windows the protocol must be TCP or UDP. On MQSeries for VSE/ESA, the protocol must be TCP or LU 6.2; you can choose T or L accordingly on the **Maintain Channel Definition** menu.

Details of all the channel attributes are given in “Chapter 6. Channel attributes” on page 77.



**On the target queue manager**

Define a channel with a channel type of RECEIVER, and the **same** name as the sender channel.

Specify the name of the communication protocol you are using (the TRPTYPE attribute). For V5.1 of MQSeries for AIX, AS/400, HP-UX, OS/2 Warp, Sun Solaris, and Windows NT, and MQSeries for Windows, you do not have to specify this. You can leave it to pick up the value from your default channel definition. On MQSeries for Windows the protocol must be TCP. If you are using CICS to define a channel, you cannot specify TRPTYPE. Instead you should accept the defaults provided. On MQSeries for VSE/ESA, you can choose T (TCP) or U (UDP) on the **Maintain Channel Definition** menu.

Note that other than on MQSeries for Windows, receiver channel definitions can be generic. This means that if you have several queue managers communicating with the same receiver, the sending channels can all specify the same name for the receiver, and one receiver definition will apply to them all.

When you have defined the channel, you can test it using the PING CHANNEL command. This command (which is not supported on MQSeries for Windows) sends a special message from the sender channel to the receiver channel and checks that it is returned.

**Defining the queues**

To send messages from one queue manager to another, you need to define up to six queues; four on the source queue manager and two on the target queue manager.

**On the source queue manager**

- Remote queue definition

In this definition you specify the following:

**Remote queue manager name**

The name of the target queue manager.

**Remote queue name**

The name of the target queue on the target queue manager.

**Transmission queue name**

The name of the transmission queue. You do not have to specify this. If you do not, a transmission queue with the same name as the target queue manager is used, or, if this does not exist, the default transmission queue is used. You are advised to give the transmission queue the same name as the target queue manager so that the queue is found by default.

- Initiation queue definition

Not supported on MQSeries for Windows, required on OS/390, and is optional on other platforms. On OS/390 you must use the initiation queue called SYSTEM.CHANNEL.INITQ and you are recommended to do so on other platforms also.

- Transmission queue definition

A local queue with the USAGE attribute set to XMITQ. If you are using the MQSeries for AS/400 V5.1 native interface, the USAGE attribute is \*TMQ.

## Sending messages

- Dead-letter queue definition—recommended (not applicable to MQSeries for Windows)  
Define a dead-letter queue to which undelivered messages can be written.

On OS/390 you should also define a *process* if you want your channels to be triggered automatically. (See “Triggering channels”.)

### On the target queue manager

- Local queue definition  
The target queue. The name of this queue must be the same as that specified in the remote queue name field of the remote queue definition on the source queue manager.
- Dead-letter queue definition—recommended (not applicable to MQSeries for Windows)  
Define a dead-letter queue to which undelivered messages can be written.

## Sending the messages

When you put messages on the remote queue defined at the source queue manager, they are stored on the transmission queue until the channel is started. When the channel has been started, the messages are sent to the target queue on the remote queue manager.

## Starting the channel

Start the channel on the sending queue manager using the START CHANNEL command. When you start the sending channel, the receiving channel is started automatically (by the listener) and the messages are sent to the target queue. Both ends of the message channel must be running for messages to be transferred.

Because the two ends of the channel are on different queue managers, they could have been defined with different attributes. To resolve any differences, there is an initial data negotiation between the two ends when the channel starts. In general, the two ends of the channel agree to operate with the attributes needing the fewer resources, thus enabling larger systems to accommodate the lesser resources of smaller systems at the other end of the message channel.

The sending MCA splits large messages before sending them across the channel. They are reassembled at the remote queue manager. This is transparent to the user.

---

## Triggering channels

This explanation is intended as an overview of triggering concepts. You can find a complete description in the *MQSeries Application Programming Guide*.

For platform-specific information see the following:

- For OS/2, Windows NT, UNIX systems, Digital OpenVMS, and Tandem NSK, “Triggering channels” on page 117
- For OS/390 without CICS, “Defining MQSeries objects” on page 342
- For OS/390 using CICS, “How to trigger channels” on page 358
- For OS/400, “Triggering channels” on page 443

Triggering is not supported on MQSeries for Windows.

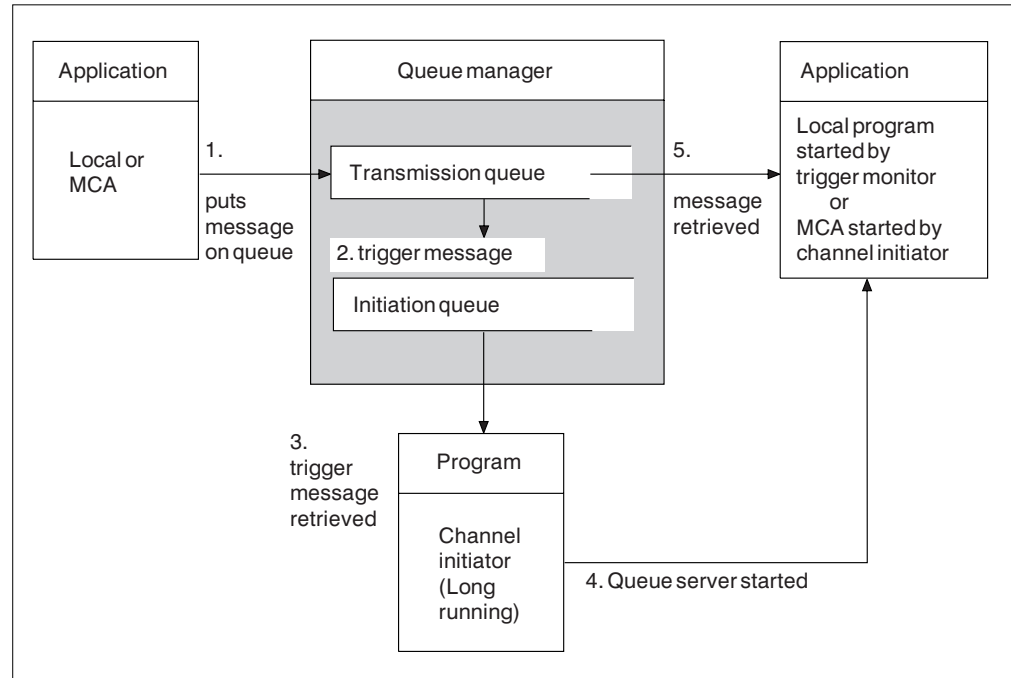

Figure 14. The concepts of triggering

The objects required for triggering are shown in Figure 14. It shows the following sequence of events:

1. The local queue manager places a message from an application or from a message channel agent (MCA) on the transmission queue.
2. When the triggering conditions are fulfilled, the local queue manager places a trigger message on the initiation queue.
3. The long-running channel initiator program monitors the initiation queue, and retrieves messages as they appear.
4. The trigger monitor processes the trigger messages according to information contained in them. This information may include the channel name, in which case a special type of trigger monitor called a channel initiator starts the corresponding MCA.
5. The local application or the MCA, having been triggered, retrieves the messages from the transmission queue.

To set up this scenario, you need to:

- Create the transmission queue with the name of the initiation queue (that is, `SYSTEM.CHANNEL.INITQ`) in the corresponding attribute.
- Ensure that the initiation queue (`SYSTEM.CHANNEL.INITQ`) exists.
- Ensure that the channel initiator program is available and running. The trigger monitor program must be provided with the name of the initiation queue in its start command. On OS/390 without CICS, the name of the initiation queue is fixed, so is not used on the start command.
- Create the process definition for the triggering, if it does not exist, and ensure that its *UserData* field contains the name of the channel it serves. For V5.1 of MQSeries for AIX, AS/400, HP-UX, OS/2 Warp, Sun Solaris, and Windows NT, the process definition is optional (it is not supported on MQSeries for VSE/ESA). Instead, you can specify the channel name in the *TriggerData* attribute of the transmission queue. V5.1 of MQSeries for AIX, AS/400, HP-UX,

## Triggering channels

OS/2 Warp, Sun Solaris, and Windows NT allow the channel name to be specified as blank, in which case the first available channel definition with this transmission queue is used.

- Ensure that the transmission queue definition contains the name of the process definition to serve it, (if applicable), the initiation queue name, and the triggering characteristics you feel are most suitable. The trigger control attribute allows triggering to be enabled, or not, as necessary.

### Notes:

1. An initiation queue and trigger process can be used to trigger any number of channels.
2. Any number of initiation queues and trigger processes can be defined.
3. A trigger type of FIRST is recommended, to avoid flooding the system with channel starts.

---

## Safety of messages

In addition to the usual recovery features of MQSeries, distributed queue management ensures that messages are delivered properly by using a syncpoint procedure coordinated between the two ends of the message channel. If this procedure detects an error, it closes the channel to allow you to investigate the problem, and keeps the messages safely in the transmission queue until the channel is restarted.

The syncpoint procedure has an added benefit in that it attempts to recover an *in-doubt* situation when the channel starts up. (*In-doubt* is the status of a unit of recovery for which a syncpoint has been requested but the outcome of the request is not yet known.) Also associated with this facility are the two functions:

1. Resolve with commit or backout
2. Reset the sequence number

The use of these functions occurs only in exceptional circumstances because the channel recovers automatically in most cases.

## Fast, nonpersistent messages

In V5.1 of MQSeries for AIX, AS/400, HP-UX, OS/2 Warp, Sun Solaris, and Windows NT, MQSeries for OS/390 without CICS and MQSeries for Windows V2.1, the nonpersistent message speed (NPMSPEED) channel attribute can be used to specify that any nonpersistent messages on the channel are to be delivered quickly. For more information about this attribute, see “Nonpersistent message speed (NPMSPEED)” on page 90. If a channel terminates while fast, nonpersistent messages are in transit, the messages may be lost and it is up to the application to arrange for their recovery if required. Similarly, if the MQPUT command fails for any reason, the messages are lost.

Every effort is made to deliver fast, nonpersistent messages safely. Unless there is a problem with the message, such as a data-conversion problem or a message-size problem, the message is delivered. The safety of an individual message is not affected by sequence-number problems or problems with other messages in the same batch.

In MQSeries for Compaq (DIGITAL) OpenVMS fast messages are defined differently. To enable fast messages on a channel, of type sender, server, receiver, or requester, set the following definitions at both ends of the channel after the CHLTYPE:

```
DESCR('>>> description') +
```

Specifying >>> as the first characters in the channel description defines the channel as fast for nonpersistent messages.

**Note:** If the other end of the channel does not support the option, the channel runs at normal speed.

## Undelivered messages

For information about what happens when a message cannot be delivered, see “What happens when a message cannot be delivered?” on page 71.

## Introduction

---

## Chapter 3. More about intercommunication

This chapter mentions three aliases:

- Remote queue definition
- Queue manager alias definition
- Reply-to queue alias definition

These are all based on the *remote queue definition* object introduced in “Remote queue definitions” on page 14.

This discussion does not apply to *alias queues*. These are described in the *MQSeries Application Programming Guide*.

This chapter also discusses “Networks” on page 29.

---

### Addressing information

In a single-queue-manager environment, the address of a destination queue is established when an application opens a queue for putting messages to. Because the destination queue is on the same queue manager, there is no need for any addressing information.

In a distributed environment the queue manager needs to know not only the destination queue name, but also the location of that queue (that is, the queue manager name), and the route to that remote location (that is, the transmission queue). When an application puts messages that are destined for a remote queue manager, the local queue manager adds a transmission header to them before placing them on the transmission queue. The transmission header contains the name of the destination queue and queue manager, that is, the *addressing information*. The receiving channel removes the transmission header and uses the information in it to locate the destination queue.

You can avoid the need for your applications to specify the name of the destination queue manager if you use a remote queue definition. This definition specifies the name of the remote queue, the name of the remote queue manager to which messages are destined, and the name of the transmission queue used to transport the messages.

---

### What are aliases?

Aliases are used to provide a quality of service for messages. The queue manager alias enables a system administrator to alter the name of a target queue manager without causing you to have to change your applications. It also enables the system administrator to alter the route to a destination queue manager, or to set up a route that involves passing through a number of other queue managers (multi-hopping). The reply-to queue alias provides a quality of service for replies.

Queue manager aliases and reply-to queue aliases are created using a remote-queue definition that has a blank RNAME. These definitions do not define real queues; they are used by the queue manager to resolve physical queue names, queue manager names, and transmission queues.

Alias definitions are characterized by having a blank RNAME.

## What are aliases?

### Queue name resolution

Queue name resolution occurs at every queue manager each time a queue is opened. Its purpose is to identify the target queue, the target queue manager (which may be local), and the route to that queue manager (which may be null). The resolved name has three parts: the queue manager name, the queue name, and, if the queue manager is remote, the transmission queue.

When a remote queue definition exists, no alias definitions are referenced. The queue name supplied by the application is resolved to the name of the destination queue, the remote queue manager, and the transmission queue specified in the remote queue definition. For more detailed information about queue name resolution, see “Appendix C. Queue name resolution” on page 633.

If there is no remote queue definition and a queue manager name is specified, or resolved by the name service, the queue manager looks to see if there is a queue manager alias definition that matches the supplied queue manager name. If there is, the information in it is used to resolve the queue manager name to the name of the destination queue manager. The queue manager alias definition can also be used to determine the transmission queue to the destination queue manager.

If the resolved queue name is not a local queue, both the queue manager name and the queue name are included in the transmission header of each message put by the application to the transmission queue.

The transmission queue used usually has the same name as the resolved queue manager, although this may be changed by a remote queue definition or a queue manager alias definition. If you have not defined a transmission queue with the name of the resolved queue manager and there is no transmission queue defined by the remote queue definitions or queue manager alias definitions, but you have defined a default transmission queue, the default transmission queue is used.

**Note:** Names of queue managers running on OS/390 are limited to four characters.

---

## Queue manager alias definitions

Queue manager alias definitions apply when an application that opens a queue to put a message, specifies the queue name **and** the queue manager name.

Queue manager alias definitions have three uses:

- When sending messages, remapping the queue manager name
- When sending messages, altering or specifying the transmission queue
- When receiving messages, determining whether the local queue manager is the intended destination for those messages

### Outbound messages - remapping the queue manager name

Queue manager alias definitions can be used to remap the queue manager name specified in an MQOPEN call. For example, an MQOPEN call specifies a queue name of THISQ and a queue manager name of YOURQM. At the local queue manager there is a queue manager alias definition like this:

```
DEFINE QREMOTE (YOURQM) RQMNAME (REALQM)
```

This shows that the real queue manager to be used, when an application puts messages to queue manager YOURQM, is REALQM. If the local queue manager is REALQM, it puts the messages to the queue THISQ, which is a local queue. If the



## Queue manager alias definitions

local queue manager is not called REALQM, it routes the message to a transmission queue called REALQM. The queue manager changes the transmission header to say REALQM instead of YOURQM.

### Outbound messages - altering or specifying the transmission queue

Figure 15 shows a scenario where messages arrive at queue manager 'QM1' with transmission headers showing queue names at queue manager 'QM3'. In this scenario, 'QM3' is reachable by multi-hopping through 'QM2'.

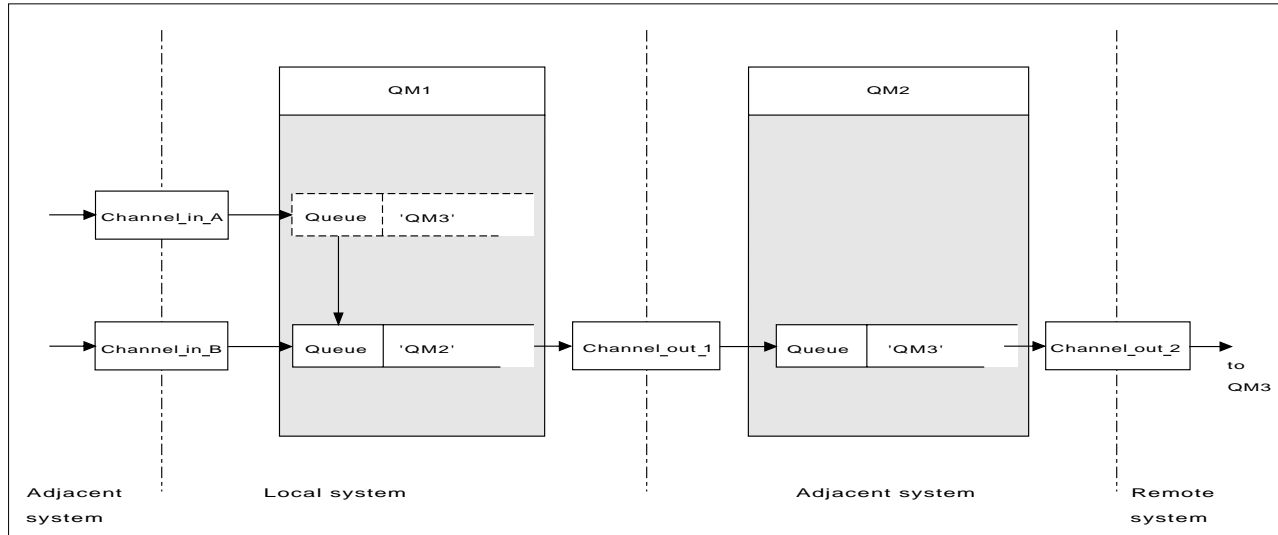

Figure 15. Queue manager alias

All messages for 'QM3' are captured at 'QM1' with a queue manager alias. The queue manager alias is named 'QM3' and contains the definition 'QM3 via transmission queue QM2'. The definition looks like this:

```
DEFINE QREMOTE (QM3) RNAME() RQMNAME(QM3) XMITQ(QM2)
```

The queue manager puts the messages on transmission queue 'QM2' but does not make any alteration to the transmission queue header because the name of the destination queue manager, 'QM3', does not alter.

All messages arriving at 'QM1' and showing a transmission header containing a queue name at 'QM2' are also put on the 'QM2' transmission queue. In this way, messages with different destinations are collected onto a common transmission queue to an appropriate adjacent system, for onward transmission to their destinations.

### Inbound messages - determining the destination

A receiving MCA opens the queue referenced in the transmission header. If a queue manager alias definition exists with the same name as the queue manager referenced, then the queue manager name received in the transmission header is replaced with the RQMNAME from that definition.

This has two uses:

- Directing messages to another queue manager
- Altering the queue manager name to be the same as the local queue manager

## Reply-to queue alias definitions

When an application needs to reply to a message it may look at the data in *message descriptor* of the message it received to find out the name of the queue to which it should reply. It is up to the sending application to suggest where replies should be sent and to attach this information to its messages. This has to be coordinated as part of your application design.

### What is a reply-to queue alias definition?

A reply-to queue alias definition specifies alternative names for the reply information in the message descriptor. The advantage of this is that you can alter the name of a queue or queue manager without having to alter your applications. Queue name resolution takes place at the sending end, before the message is put to a queue.

**Note:** This is an unusual use of queue-name resolution. It is the only situation in which name resolution takes place at a time when a queue is not being opened.

Normally an application specifies a reply-to queue and leaves the reply-to queue manager name blank. The queue manager fills in its own name at put time. This works well except when you want alternate channels to be used for replies. In this situation, the queue manager names specified in transmission-queue headers do not match “real” queue manager names but are re-specified using queue manager alias definitions. In order to return replies along similar alternate routes, it is necessary to map reply-to queue data as well, using reply-to queue alias definitions.

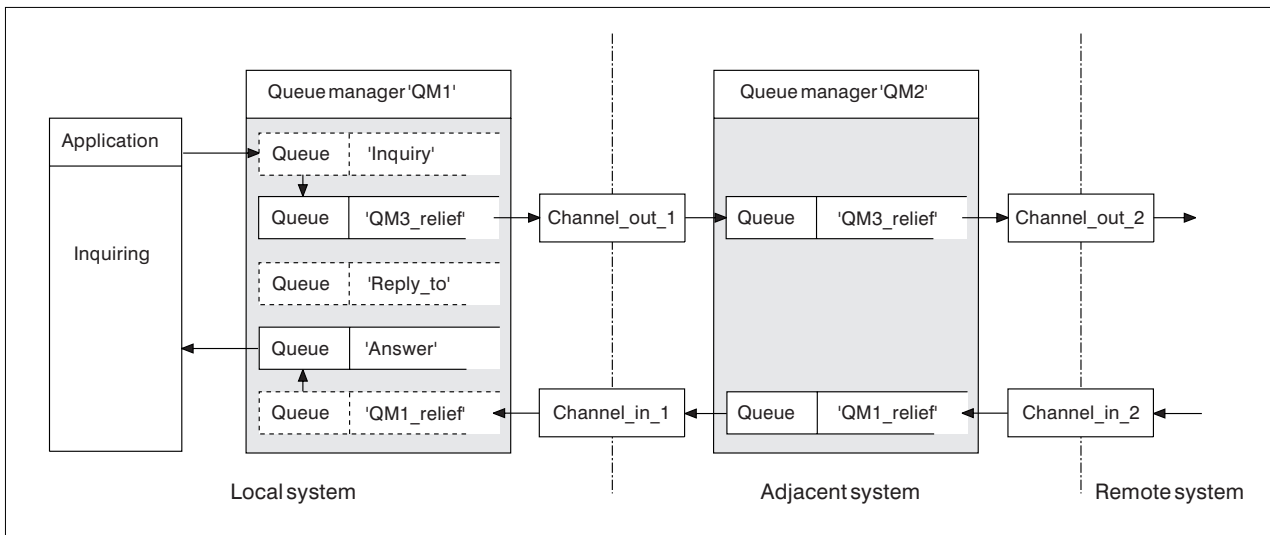

Figure 16. Reply-to queue alias used for changing reply location

In the example in Figure 16:

1. The application puts a message using the MQPUT call and specifying the following in the message descriptor:

```
ReplyToQ='Reply_to'
ReplyToQMgr=''
```

## Reply-to queue alias definitions

Note that ReplyToQMgr must be blank in order for the reply-to queue alias to be used.

2. You create a reply-to queue alias definition called 'Reply\_to', which contains the name 'Answer', and the queue manager name 'QM1\_relief'.

```
DEFINE QREMOTE ('Reply_to') RNAME ('Answer')
              RQMNAME ('QM1_relief')
```
3. The messages are sent with a message descriptor showing ReplyToQ='Answer' and ReplyToQMgr='QM1\_relief'.
4. The application specification must include the information that replies are to be found in queue 'Answer' rather than 'Reply\_to'.

To prepare for the replies you have to create the parallel return channel. This involves defining:

- At QM2, the transmission queue named 'QM1\_relief'

```
DEFINE QLOCAL ('QM1_relief') USAGE(XMITQ)
```
- At QM1, the queue manager alias queue 'QM1\_relief'

```
DEFINE QREMOTE ('QM1_relief') RNAME() RQMNAME(QM1)
```

This queue manager alias queue terminates the chain of parallel return channels and captures the messages for QM1.

If you think you might want to do this at sometime in the future, arrange for your applications to use the alias name from the start. For now this is a normal queue alias to the reply-to queue, but later it can be changed to a queue manager alias.

## Reply-to queue name

Care is needed with naming reply-to queues. The reason that an application puts a reply-to queue name in the message is that it can specify the queue to which its replies will be sent. But when you create a reply-to queue alias definition with this name, you cannot have the actual reply-to queue (that is, a local queue definition) with the same name. Therefore, the reply-to queue alias definition must contain a new queue name as well as the queue manager name, and the application specification must include the information that its replies will be found in this other queue.

The applications now have to retrieve the messages from a different queue from the one they named as the reply-to queue when they put the original message.

---

## Networks

So far this book has covered creating channels between your system and any other system with which you need to have communications, and creating multi-hop channels to systems where you have no direct connections. The message channel connections described in the scenarios are shown as a network diagram in Figure 17 on page 30.

## Channel and transmission queue names

You can give transmission queues any name you like, but to avoid confusion, you can give them the same names as the destination queue manager names, or queue manager alias names, as appropriate, to associate them with the route they use. This gives a clear overview of parallel routes that you create through intermediate (multi-hopped) queue managers.

## Networks

This is not quite so clear-cut for channel names. The channel names in Figure 17 for QM2, for example, must be different for incoming and outgoing channels. All channel names may still contain their transmission queue names, but they must be qualified to make them unique.

For example, at QM2, there is a QM3 channel coming from QM1, and a QM3 channel going to QM3. To make the names unique, the first one may be named 'QM3\_from\_QM1', and the second may be named 'QM3\_from\_QM2'. In this way, the channel names show the transmission queue name in the first part of the name, and the direction and adjacent queue manager name in the second part of the name.

A table of suggested channel names for Figure 17 is given in Table 1.

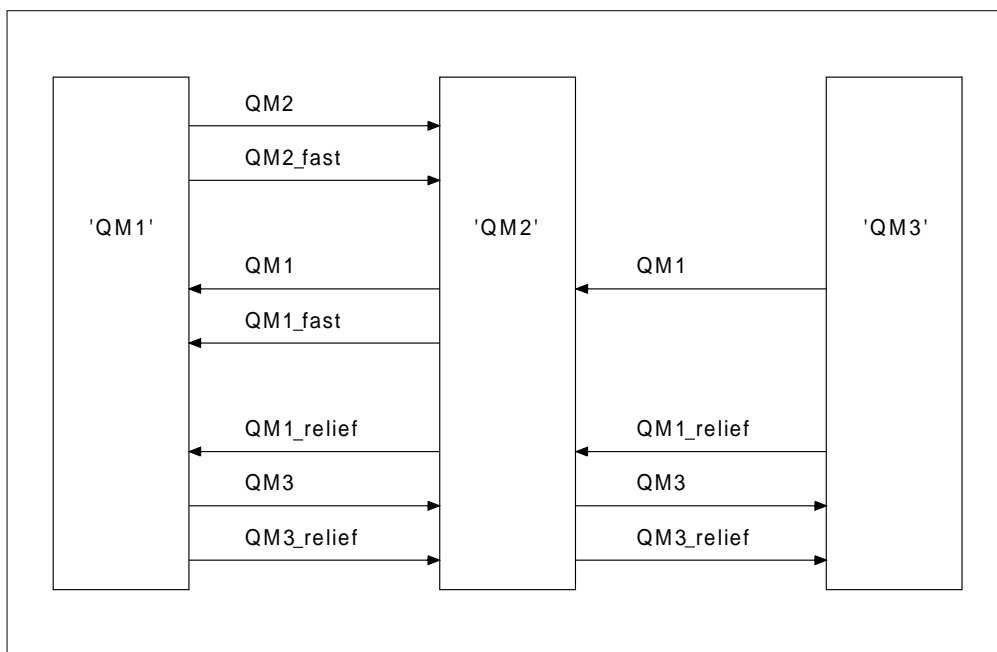

Figure 17. Network diagram showing all channels

Table 1. Example of channel names

Route name	Queue managers hosting channel	Transmission queue name	Suggested channel name
QM1	QM1 & QM2	QM1 (at QM2)	QM1.from.QM2
QM1	QM2 & QM3	QM1 (at QM3)	QM1.from.QM3
QM1_fast	QM1 & QM2	QM1_fast (at QM2)	QM1_fast.from.QM2
QM1_relief	QM1 & QM2	QM1_relief (at QM2)	QM1_relief.from.QM2
QM1_relief	QM2 & QM3	QM1_relief (at QM3)	QM1_relief.from.QM3
QM2	QM1 & QM2	QM2 (at QM1)	QM2.from.QM1
QM2_fast	QM1 & QM2	QM2_fast (at QM1)	QM2_fast.from.QM1
QM3	QM1 & QM2	QM3 (at QM1)	QM3.from.QM1
QM3	QM2 & QM3	QM3 (at QM2)	QM3.from.QM2
QM3_relief	QM1 & QM2	QM3_relief (at QM1)	QM3_relief.from.QM1
QM3_relief	QM2 & QM3	QM3_relief (at QM2)	QM3_relief.from.QM2

### Notes:

1. On MQSeries for OS/390, queue manager names are limited to 4 characters.

2. You are strongly recommended to name all the channels in your network uniquely. As shown in Table 1 on page 30, including the source and target queue manager names in the channel name is a good way to do this.

## Network planner

This chapter has discussed application designer, systems administrator, and channel planner functions. Creating a network assumes that there is another, higher level function of *network planner* whose plans are implemented by the other members of the team.

If an application is used widely, it is more economical to think in terms of local access sites for the concentration of message traffic, using wide-band links between the local access sites, as shown in Figure 18.

In this example there are two main systems and a number of satellite systems (The actual configuration would depend on business considerations.) There are two concentrator queue managers located at convenient centers. Each QM-concentrator has message channels to the local queue managers:

- QM-concentrator 1 has message channels to each of the three local queue managers, QM1, QM2, and QM3. The applications using these queue managers can communicate with each other through the QM-concentrators.
- QM-concentrator 2 has message channels to each of the three local queue managers, QM4, QM5, and QM6. The applications using these queue managers can communicate with each other through the QM-concentrators.
- The QM-concentrators have message channels between themselves thus allowing any application at a queue manager to exchange messages with any other application at another queue manager.

## Introduction

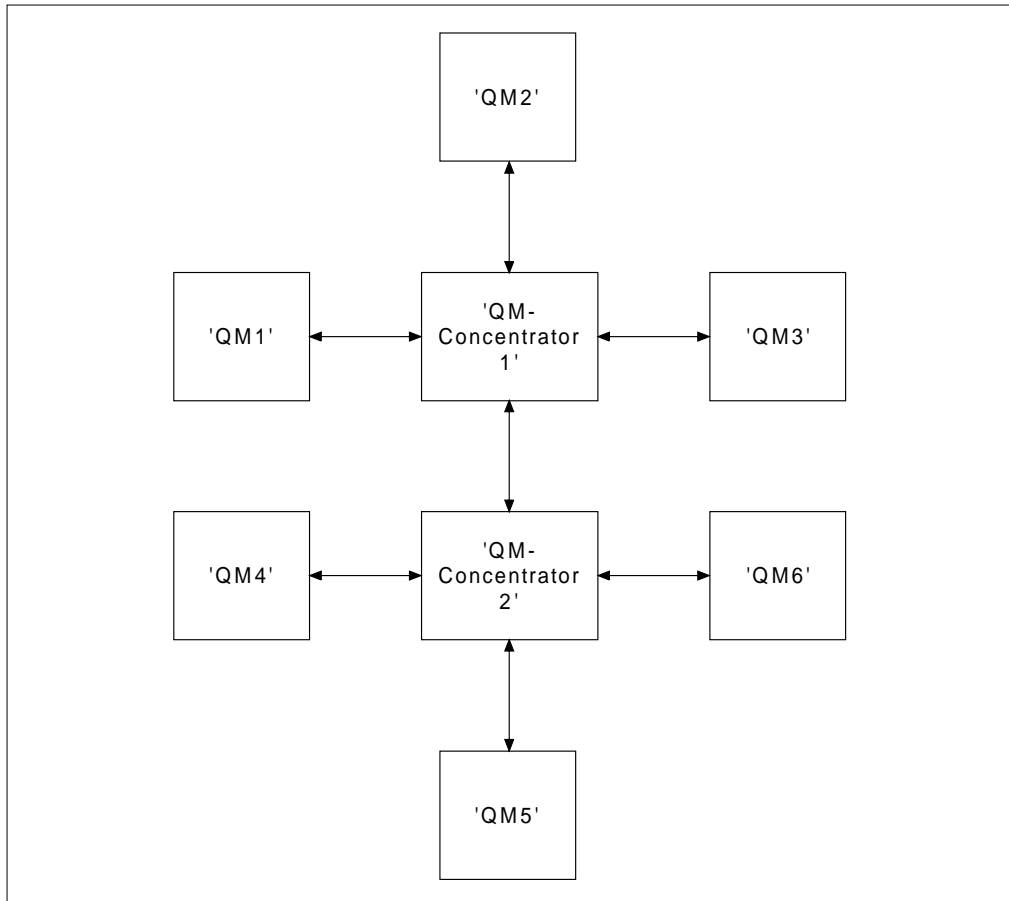

Figure 18. Network diagram showing QM-concentrators

---

## Part 2. How intercommunication works

<b>Chapter 4. MQSeries distributed-messaging techniques</b> . . . . .	35
Message flow control . . . . .	35
Queue names in transmission header . . . . .	36
How to create queue manager and reply-to aliases . . . . .	36
Putting messages on remote queues . . . . .	37
More about name resolution . . . . .	38
Choosing the transmission queue . . . . .	39
Receiving messages . . . . .	40
Receiving alias queue manager names . . . . .	40
Passing messages through your system . . . . .	41
Method 1: Using the incoming location name . . . . .	42
Method 2: Using an alias for the queue manager . . . . .	42
Method 3: Selecting a transmission queue . . . . .	42
Using these methods . . . . .	42
Separating message flows . . . . .	42
Concentrating messages to diverse locations . . . . .	44
Diverting message flows to another destination . . . . .	45
Sending messages to a distribution list . . . . .	46
Reply-to queue . . . . .	47
Reply-to queue alias example . . . . .	48
Definitions used in this example at QM1 . . . . .	49
Definitions used in this example at QM2 . . . . .	50
Put definition at QM1 . . . . .	50
Put definition at QM2 . . . . .	50
How the example works . . . . .	50
How the queue manager makes use of the reply-to queue alias . . . . .	51
Reply-to queue alias walk-through . . . . .	51
Networking considerations . . . . .	52
Return routing . . . . .	53
Managing queue name translations . . . . .	53
Message sequence numbering . . . . .	54
Sequential retrieval of messages . . . . .	55
Sequence of retrieval of fast, nonpersistent messages . . . . .	56
Loopback testing . . . . .	56
<b>Chapter 5. DQM implementation</b> . . . . .	57
Functions of DQM . . . . .	57
Message sending and receiving . . . . .	58
Channel parameters . . . . .	59
Channel status and sequence numbers . . . . .	59
Channel control function . . . . .	59
Preparing channels . . . . .	60
Auto-definition of channels . . . . .	60
Defining other objects . . . . .	61
Starting a channel (not MQSeries for Windows) . . . . .	61
Starting a channel on MQSeries for Windows . . . . .	61
Channel states . . . . .	62
Current and active . . . . .	62
Channel errors . . . . .	65
Checking that the other end of the channel is still available . . . . .	66
Stopping and quiescing channels (not MQSeries for Windows) . . . . .	67
Stopping and quiescing channels (MQSeries for Windows) . . . . .	68
Restarting stopped channels . . . . .	69
In-doubt channels . . . . .	69
Problem determination . . . . .	71
Command validation . . . . .	71
Processing problems . . . . .	71
Messages and codes . . . . .	71
What happens when a message cannot be delivered? . . . . .	71
Initialization and configuration files . . . . .	73
OS/390 without CICS . . . . .	73
OS/390 using CICS . . . . .	73
Windows NT . . . . .	73
OS/2, Digital OpenVMS, Tandem NSK, OS/400 and UNIX systems . . . . .	73
MQSeries configuration file . . . . .	74
Queue manager configuration file . . . . .	74
VSE/ESA . . . . .	75
Data conversion . . . . .	75
Writing your own message channel agents . . . . .	75
<b>Chapter 6. Channel attributes</b> . . . . .	77
Channel attributes in alphabetical order . . . . .	77
Alter date (ALTDATE) . . . . .	78
Alter time (ALTTIME) . . . . .	78
Auto start (AUTOSTART) . . . . .	78
Batch interval (BATCHINT) . . . . .	79
Batch size (BATCHSZ) . . . . .	79
Channel name (CHANNEL) . . . . .	80
Channel type (CHLTYPE) . . . . .	81
CICS profile name . . . . .	81
Cluster (CLUSTER) . . . . .	81
Cluster namelist (CLUSNL) . . . . .	82
Connection name (CONNNAME) . . . . .	82
Convert message (CONVERT) . . . . .	83
Description (DESCR) . . . . .	84
Disconnect interval (DISCINT) . . . . .	84
Heartbeat interval (HBINT) . . . . .	85
Long retry count (LONGRTY) . . . . .	85
Long retry interval (LONGTMR) . . . . .	85
LU 6.2 mode name (MODENAME) . . . . .	86
LU 6.2 transaction program name (TPNAME) . . . . .	86
Maximum message length (MAXMSGL) . . . . .	87
Maximum transmission size . . . . .	87
Message channel agent name (MCANAME) . . . . .	87
Message channel agent type (MCATYPE) . . . . .	88
Message channel agent user identifier (MCAUSER) . . . . .	88
Message exit name (MSGEXIT) . . . . .	88
Message exit user data (MSGDATA) . . . . .	89
Message-retry exit name (MREXIT) . . . . .	89
Message-retry exit user data (MRDATA) . . . . .	89
Message retry count (MRRTY) . . . . .	89

## Intercommunication

Message retry interval (MRTMR) . . . . .	89	Short retry interval (SHORTTMR) . . . . .	94
Network-connection priority (NETPRTY) . . . . .	90	Target system identifier . . . . .	94
Nonpersistent message speed (NPMSPEED) . . . . .	90	Transaction identifier . . . . .	94
Password (PASSWORD) . . . . .	90	Transmission queue name (XMITQ) . . . . .	94
PUT authority (PUTAUT). . . . .	90	Transport type (TRPTYPE) . . . . .	95
Queue manager name (QMNAME) . . . . .	91	User ID (USERID) . . . . .	95
Receive exit name (RCVEXIT) . . . . .	91		
Receive exit user data (RCVDATA) . . . . .	92	<b>Chapter 7. Example configuration chapters in</b>	
Security exit name (SCYEXIT) . . . . .	92	<b>this book</b> . . . . .	97
Security exit user data (SCYDATA) . . . . .	93	Network infrastructure . . . . .	98
Send exit name (SENDEXIT). . . . .	93	Communications software . . . . .	98
Send exit user data (SENDDATA) . . . . .	93	How to use the communication examples . . . . .	99
Sequence number wrap (SEQWRAP) . . . . .	93	IT responsibilities . . . . .	100
Sequential delivery . . . . .	93		
Short retry count (SHORTRTY) . . . . .	93		

This part of the book gives more details about how intercommunication works. The description in this part is general, and is not restricted to a particular platform or system.



---

## Chapter 4. MQSeries distributed-messaging techniques

This chapter describes techniques that are of use when planning channels. It introduces the concept of message flow control and explains how this is arranged in distributed queue management (DQM). It gives more detailed information about the concepts introduced in the preceding chapters and starts to show how you might use distributed queue management. This chapter covers the following topics:

- “Message flow control”
- “Putting messages on remote queues” on page 37
- “Choosing the transmission queue” on page 39
- “Receiving messages” on page 40
- “Passing messages through your system” on page 41
- “Separating message flows” on page 42
- “Concentrating messages to diverse locations” on page 44
- “Diverting message flows to another destination” on page 45
- “Sending messages to a distribution list” on page 46
- “Reply-to queue” on page 47
- “Networking considerations” on page 52
- “Return routing” on page 53
- “Managing queue name translations” on page 53
- “Message sequence numbering” on page 54
- “Loopback testing” on page 56

---

### Message flow control

Message flow control is a task that involves the setting up and maintenance of message routes between queue managers. This is very important for routes that multi-hop through many queue managers.

You control message flow using a number of techniques that were introduced in “Chapter 2. Making your applications communicate” on page 17. If your queue manager is in a cluster, message flow is controlled using different techniques as described in the *MQSeries Queue Manager Clusters* book.

This chapter describes how you use your system’s queues, alias queue definitions, and message channels to achieve message flow control.

You make use of the following objects:

- Transmission queues
- Message channels
- Remote queue definition
- Queue manager alias definition
- Reply-to queue alias definition

The queue manager and queue objects are described in the *MQSeries System Administration* book for MQSeries for AIX, HP-UX, OS/2 Warp, Sun Solaris, and Windows NT, in the *MQSeries for AS/400 V5.1 System Administration* book for MQSeries for AS/400, or in the *MQSeries System Management Guide* for your platform. Message channels are described in “Message channels” on page 7. The following techniques use these objects to create message flows in your system:

- Putting messages to remote queues
- Routing via particular transmission queues
- Receiving messages

## Message flow control

- Passing messages through your system
- Separating message flows
- Switching a message flow to another destination
- Resolving the reply-to queue name to an alias name

### Note

All the concepts described in this chapter are relevant for all nodes in a network, and include sending and receiving ends of message channels. For this reason, only one node is illustrated in most examples, except where the example requires explicit cooperation by the administrator at the other end of a message channel.

Before proceeding to the individual techniques it is useful to recap on the concepts of name resolution and the three ways of using remote queue definitions. See “Chapter 3. More about intercommunication” on page 25.

## Queue names in transmission header

The queue name used by the application, the logical queue name, is resolved by the queue manager to the destination queue name, that is, the physical queue name. This destination queue name travels with the message in a separate data area, the transmission header, until the destination queue has been reached after which the transmission header is stripped off.

You will be changing the queue manager part of this queue name when you create parallel classes of service. Remember to return the queue manager name to the original name when the end of the class of service diversion has been reached.

## How to create queue manager and reply-to aliases

As discussed above, the remote queue definition object is used in three different ways. Table 2 on page 37 explains how to define each of the three ways:

- Using a remote queue definition to redefine a local queue name.

The application provides only the queue name when opening a queue, and this queue name is the name of the remote queue definition.

The remote queue definition contains the names of the target queue and queue manager, and optionally, the definition can contain the name of the transmission queue to be used. If no transmission queue name is provided, the queue manager uses the new queue manager name for the transmission queue name. If a transmission queue of this name is not defined, but a default transmission queue is defined, the default transmission queue is used.

- Using a remote queue definition to redefine a queue manager name.

The application, or channel program, provides a queue name together with the remote queue manager name when opening the queue.

If you have provided a remote queue definition with the same name as the queue manager name, and you have left the queue name in the definition blank, then the queue manager will substitute the queue manager name in the open call with the queue manager name in the definition.

In addition, the definition can contain the name of the transmission queue to be used. If no transmission queue name is provided, the queue manager takes the new queue manager name for the transmission queue name. If a transmission queue of this name is not defined, but a default transmission queue is defined, the default transmission queue is used.

- Using a remote queue definition to redefine a reply-to queue name.  
Each time an application puts a message to a queue, it may provide the name of a reply-to queue for answer messages but with the queue manager name blank. If you provide a remote queue definition with the same name as the reply-to queue then the local queue manager replaces the reply-to queue name with the queue name from your definition.  
You may provide a queue manager name in the definition, but not a transmission queue name.

Table 2. Three ways of using the remote queue definition object

Usage	Queue manager name	Queue name	Transmission queue name
1. Remote queue definition (on OPEN call)			
Supplied in the call	blank or local QM	(*) required	-
Supplied in the definition	required	required	optional
2. Queue manager alias (on OPEN call)			
Supplied in the call	(*) required and not local QM	required	-
Supplied in the definition	required	blank	optional
3. Reply-to queue alias (on PUT call)			
Supplied in the call	blank	(*) required	-
Supplied in the definition	optional	optional	blank
<b>Note:</b> (*) means that this name is the name of the definition object			

For a formal description, see “Appendix C. Queue name resolution” on page 633.

## Putting messages on remote queues

In a distributed-queuing environment, a transmission queue and channel are the focal point for all messages to a location whether the messages originate from applications in your local system, or arrive through channels from an adjacent system. This is shown in Figure 19 on page 38 where an application is placing messages on a logical queue named ‘QA\_norm’. The name resolution uses the remote queue definition ‘QA\_norm’ to select the transmission queue ‘QMB’, and adds a transmission header to the messages stating ‘QA\_norm at QMB’.

Messages arriving from the adjacent system on ‘Channel\_back’ have a transmission header with the physical queue name ‘QA\_norm at QMB’, for example. These messages are placed unchanged on transmission queue QMB.

The channel moves the messages to an adjacent queue manager.

## Messages on remote queues

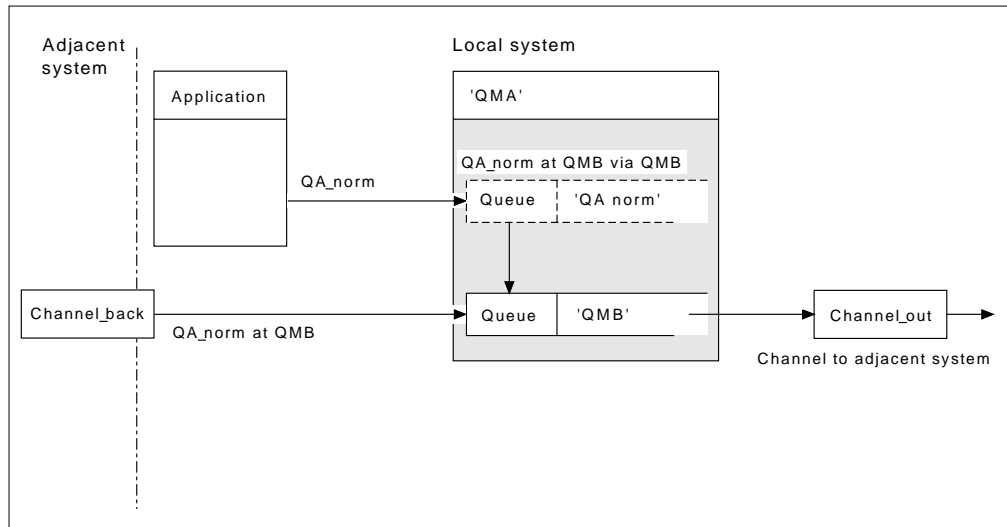

Figure 19. A remote queue definition is used to resolve a queue name to a transmission queue to an adjacent queue manager. Note: The dashed outline represents a remote queue definition. This is not a real queue, but a name alias that is controlled as though it were a real queue.

Your part in this scenario is to:

- Define the message channel from the adjacent system
- Define the message channel to the adjacent system
- Create the transmission queue 'QMB'
- Define the remote queue object 'QA\_norm' to resolve the queue name used by applications to the desired destination queue name, destination queue manager name, and transmission queue name

In a clustering environment, you only need to define a cluster-receiver channel at the local queue manager. You do not need to define a transmission queue or a remote queue object. For information about this, see the *MQSeries Queue Manager Clusters* book.

### More about name resolution

The effect of the remote queue definition is to define a physical destination queue name and queue manager name; these names are put in the transmission headers of messages.

Incoming messages from an adjacent system have already had this type of name resolution carried out by the original queue manager, and have the transmission header showing the physical destination queue name and queue manager name. These messages are unaffected by remote queue definitions.

## Choosing the transmission queue

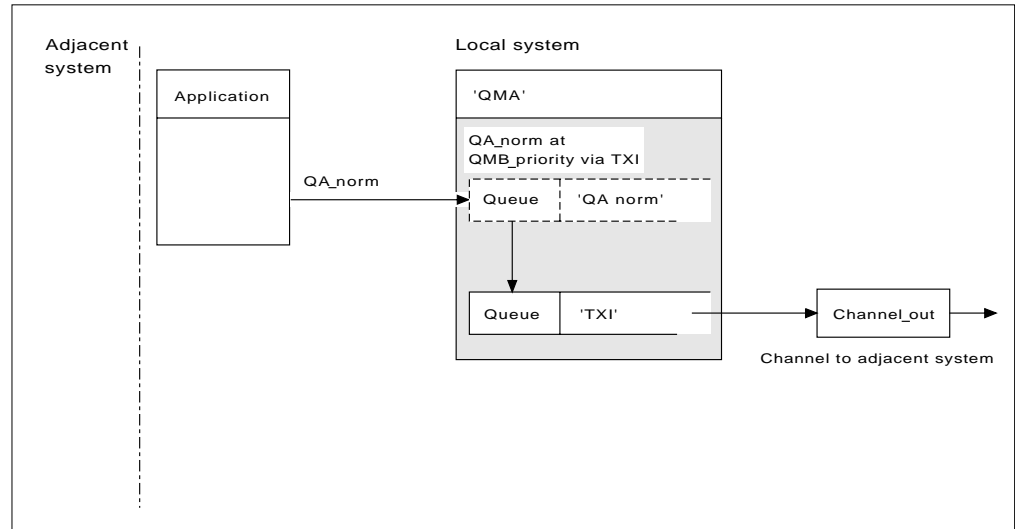

Figure 20. The remote queue definition allows a different transmission queue to be used

In a distributed-queuing environment, when you need to change a message flow from one channel to another, use the same system configuration as shown in Figure 19 on page 38. Figure 20 shows how you use the remote queue definition to send messages over a different transmission queue, and therefore over a different channel, to the same adjacent queue manager.

In Figure 20, you provide:

- The remote queue object 'QA\_norm' to choose:
  - Queue 'QA\_norm' at the remote queue manager
  - Transmission queue 'TX1'
  - Queue manager 'QMB\_priority'
- The transmission queue 'TX1'. Specify this in the definition of the channel to the adjacent system

Messages are placed on transmission queue 'TX1' with a transmission header containing 'QA\_norm at QMB\_priority', and are sent over the channel to the adjacent system.

The channel\_back has been left out of this illustration because it would need a queue manager alias; this is discussed in the following example.

In a clustering environment, you do not need to define a transmission queue or a remote queue definition. For more information about this, see the *MQSeries Queue Manager Clusters* book.

## Receiving messages

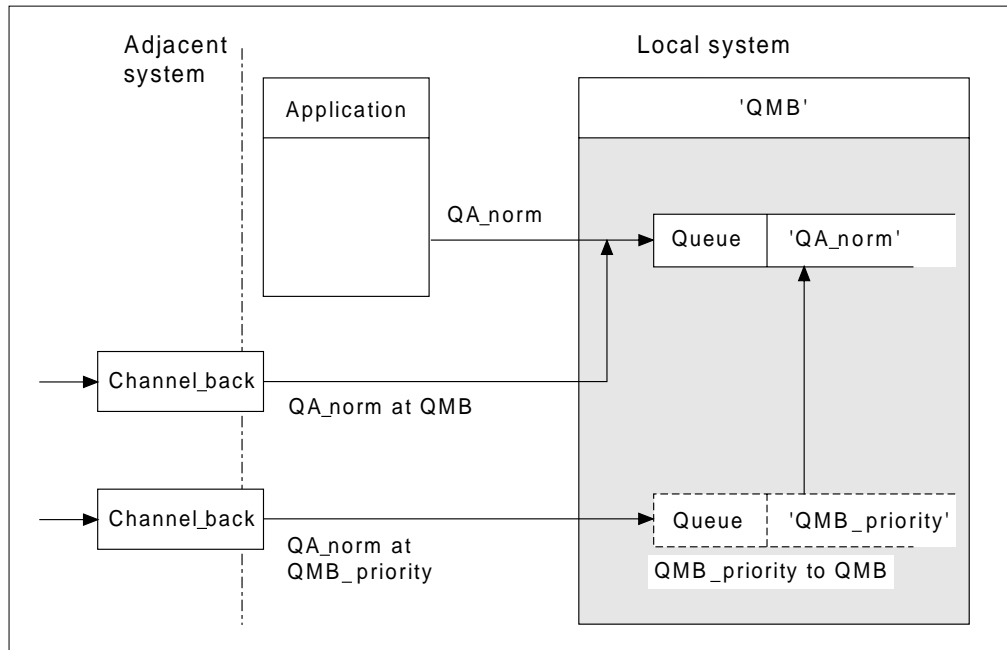

Figure 21. Receiving messages directly, and resolving alias queue manager name

As well as arranging for messages to be sent, you also arrange for messages to be received from adjacent queue managers. Received messages contain the physical name of the destination queue manager and queue in the transmission header. They are treated exactly the same as messages from a local application that specifies both queue manager name and queue name. Because of this, you need to ensure that messages entering your system do not have an unintentional name resolution carried out. See Figure 21 for this scenario.

For this scenario, you prepare:

- Message channels to receive messages from adjacent queue managers
- A queue manager alias definition to resolve an incoming message flow, 'QMB\_priority', to the local queue manager name, 'QMB'
- The local queue, 'QA\_norm', if it does not already exist

### Receiving alias queue manager names

The use of the queue manager alias definition in this illustration has not selected a different destination queue manager. Messages passing through this local queue manager and addressed to 'QMB\_priority' are intended for queue manager 'QMB'. The alias queue manager name is used to create the separate message flow.

## Passing messages through your system

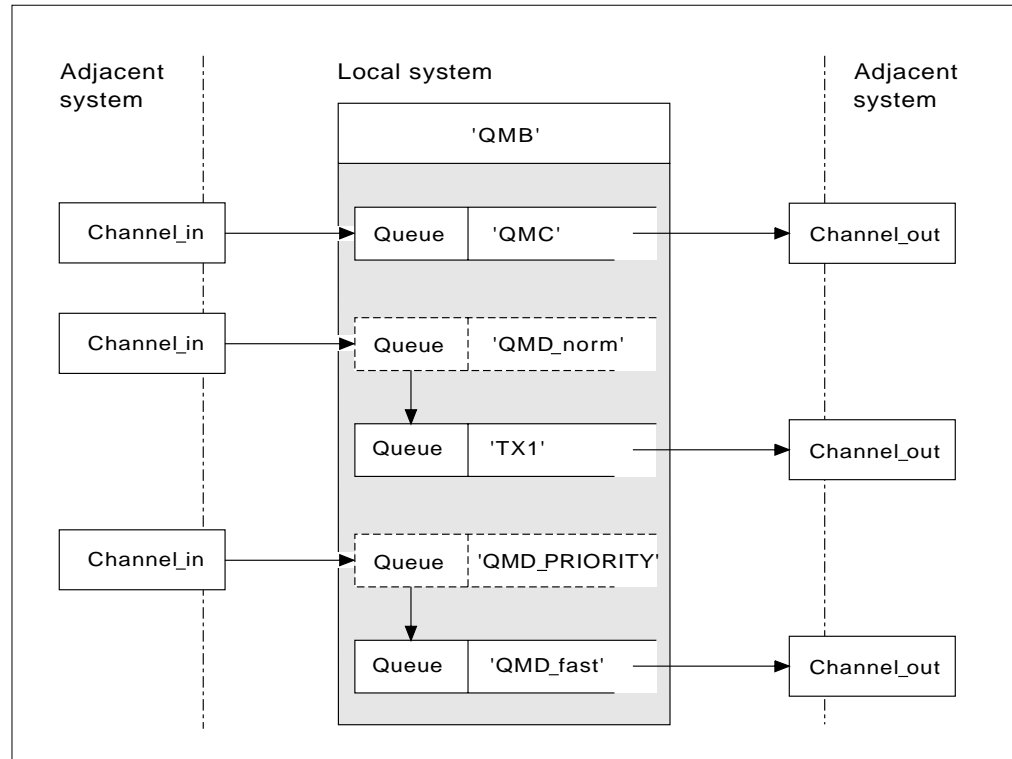

Figure 22. Three methods of passing messages through your system

Following on from the technique shown in Figure 21 on page 40, where you saw how an alias flow is captured, Figure 22 illustrates the ways networks are built up by bringing together the techniques we have discussed.

The scenario shows a channel delivering three messages with different destinations:

1. 'QMB at QMC'
2. 'QMB at QMD\_norm'
3. 'QMB at QMD\_PRIORITY'

You need to pass the first message flow through your system unchanged; the second message flow through a different transmission queue and channel, while reverting the messages from the alias queue manager name 'QMD\_norm' to the physical location 'QMD'; and the third message flow simply chooses a different transmission queue without any other change.

In a clustering environment, all messages are passed through the cluster transmission queue, SYSTEM.CLUSTER.TRANSMIT.QUEUE. This is illustrated in Figure 4 on page 7.

The following methods describe techniques applicable to a distributed-queuing environment:

## Passing messages through system

### Method 1: Using the incoming location name

When you need to receive messages with a transmission header containing another location name, the simplest preparation is to have a transmission queue with that name, 'QMC' in this example, as a part of a channel to an adjacent queue manager. The messages are delivered unchanged.

### Method 2: Using an alias for the queue manager

The second method is to use the queue manager alias object definition, but specify a new location name, 'QMD', as well as a particular transmission queue, 'TX1'. This action:

- Terminates the alias message flow set up by the queue manager name alias 'QMD\_norm'. That is the named class of service 'QMD\_norm'.
- Changes the transmission headers on these messages from 'QMD\_norm' to 'QMD'.

### Method 3: Selecting a transmission queue

The third method is to have a queue manager alias object defined with the same name as the destination location, 'QMD\_PRIORITY', and use the definition to select a particular transmission queue, 'QMD\_fast', and therefore another channel. The transmission headers on these messages remain unchanged.

## Using these methods

For these scenarios, you prepare the:

- Input channel definitions
- Output channel definitions
- Transmission queues:
  - QMC
  - TX1
  - QMD\_fast
- Queue manager alias definitions:
  - QMD\_norm with 'QMD\_norm to QMD via TX1'
  - QMD\_PRIORITY with 'QMD\_PRIORITY to QMD\_PRIORITY via QMD\_fast'

#### Note

None of the message flows shown in the example changes the destination queue. The queue manager name aliases simply provide separation of message flows.

---

## Separating message flows

In a distributed-queuing environment, the need to separate messages to the same queue manager into different message flows can arise for a number of reasons. For example:

- You may need to provide a separate flow for very large, large, medium, and small messages. This also applies in a clustering environment and, in this case, you may create clusters that overlap. There are a number of reasons you might do this, for example:
  - To allow different organizations to have their own administration.
  - To allow independent applications to be administered separately.



## Separating message flows

- To create a class of service. For example you could have a cluster called STAFF that is a subset of the cluster called STUDENTS. When you put a message to a queue advertised in the STAFF cluster, a restricted channel is used. When you put a message to a queue advertised in the STUDENTS cluster, either a general channel or a restricted channel may be used.
- To create test and production environments.
- It may be necessary to route incoming messages via different paths from the path of the locally generated messages.
- Your installation may require to schedule the movement of messages at certain times (for example, overnight) and the messages then need to be stored in reserved queues until scheduled.

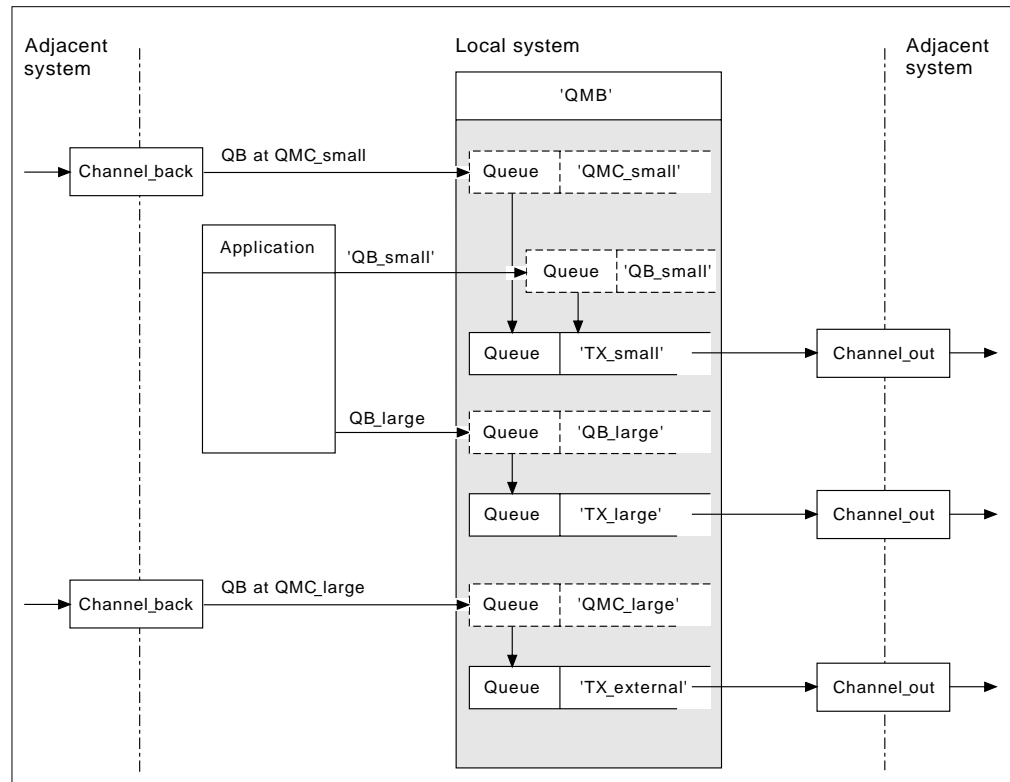

Figure 23. Separating messages flows

In the example shown in Figure 23, the two incoming flows are to alias queue manager names 'QMC\_small' and 'QMC\_large'. You provide these flows with a queue manager alias definition to capture these flows for the local queue manager. You have an application addressing two remote queues and you need these message flows to be kept separate. You provide two remote queue definitions that specify the same location, 'QMC', but specify different transmission queues. This keeps the flows separate, and nothing extra is needed at the far end as they have the same destination queue manager name in the transmission headers. You provide:

- The incoming channel definitions
- The two remote queue definitions QB\_small and QB\_large
- The two queue manager alias definitions QMC\_small and QMC\_large
- The three sending channel definitions
- Three transmission queues: TX\_small, TX\_large, and TX\_external

## Separating message flows

### Coordination with adjacent systems

When you use a queue manager alias to create a separate message flow, you need to coordinate this activity with the system administrator at the remote end of the message channel to ensure that the corresponding queue manager alias is available there.

## Concentrating messages to diverse locations

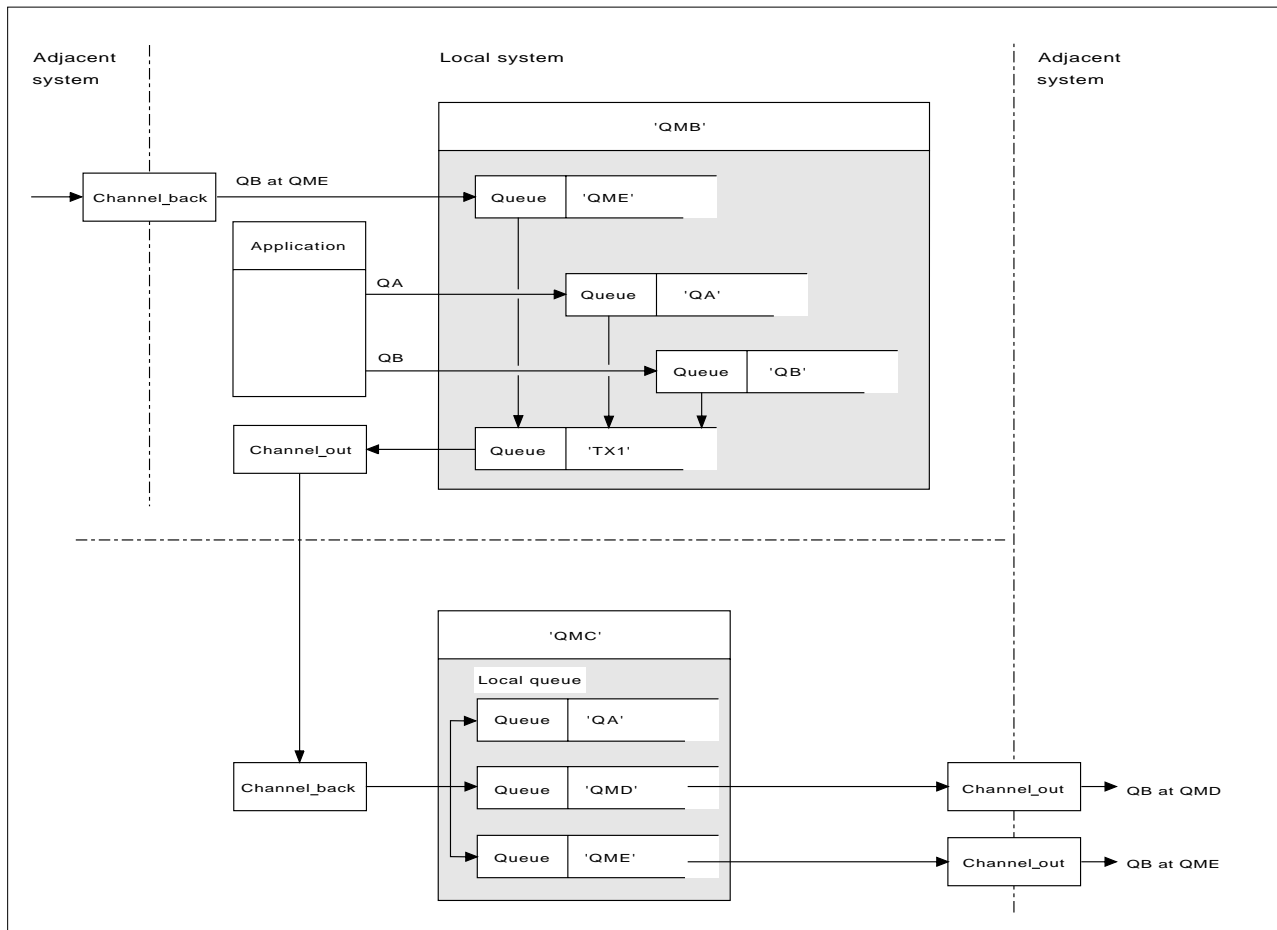

Figure 24. Combining message flows on to a channel

Figure 24 illustrates a distributed-queuing technique for concentrating messages that are destined for various locations on to one channel. Two possible uses would be:

- Concentrating message traffic through a gateway
- Using wide bandwidth highways between nodes

In this example, messages from different sources, local and adjacent, and having different destination queues and queue managers, are flowed via transmission queue 'TX1' to queue manager QMC. Queue manager QMC delivers the messages according to the destinations, one set to a transmission queue 'QMD' for onward

## Concentrating messages

transmission to queue manager QMD, another set to a transmission queue 'QME' for onward transmission to queue manager QME, while other messages are put on the local queue 'QA'.

You provide:

- Channel definitions
- Transmission queue TX1
- Remote queue definitions:
  - QA with 'QA at QMC via TX1'
  - QB with 'QB at QMD via TX1'
- Queue manager alias definition:
  - QME with 'QME via TX1'

Your colleague controlling QMC provides:

- Receiving channel definition with the same channel name
- Transmission queue QMD with associated sending channel definition
- Transmission queue QME with associated sending channel definition

---

## Diverting message flows to another destination

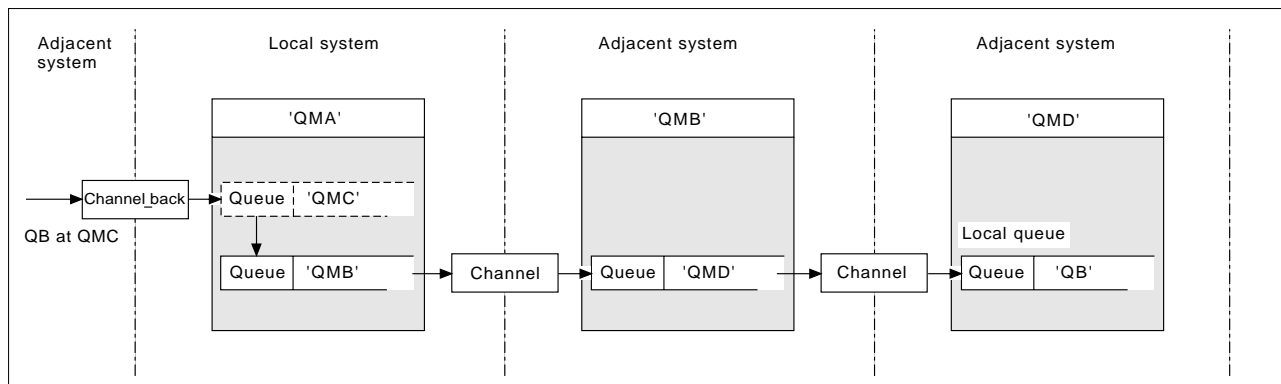

Figure 25. Diverting message streams to another destination

Figure 25 illustrates how you can redefine the destination of certain messages. Incoming messages to QMA are destined for 'QB at QMC'. They would normally arrive at QMA and be placed on a transmission queue called QMC which would have been part of a channel to QMC. QMA must divert the messages to QMD, but is able to reach QMD only over QMB. This method is useful when you need to move a service from one location to another, and allow subscribers to continue to send messages on a temporary basis until they have adjusted to the new address.

The method of rerouting incoming messages destined for a certain queue manager to a different queue manager uses:

- A queue manager alias to change the destination queue manager to another queue manager, and to select a transmission queue to the adjacent system
- A transmission queue to serve the adjacent queue manager
- A transmission queue at the adjacent queue manager for onward routing to the destination queue manager

You provide:

- Channel\_back definition
- Queue manager alias object definition QMC with QB at QMD via QMB

## Diverting message flows

- Channel\_out definition
- The associated transmission queue QMB

Your colleague who controls QMB provides:

- The corresponding channel\_back definition
- The transmission queue, QMD
- The associated channel definition to QMD

You can use aliases within a clustering environment. For information about this, see the *MQSeries Queue Manager Clusters* book.

---

## Sending messages to a distribution list

In MQSeries for AIX, AS/400, HP-UX, OS/2 Warp, Sun Solaris, and Windows NT, an application can send a message to several destinations with a single MQPUT call. This applies in both a distributed-queuing environment and a clustering environment. You have to define the destinations in a distribution list, as described in the *MQSeries Application Programming Guide*.

Not all queue managers support distribution lists. When an MCA establishes a connection with a partner, it determines whether or not the partner supports distribution lists and sets a flag on the transmission queue accordingly. If an application tries to send a message that is destined for a distribution list but the partner does not support distribution lists, the sending MCA intercepts the message and puts it onto the transmission queue once for each intended destination.

A receiving MCA ensures that messages sent to a distribution list are safely received at all the intended destinations. If any destinations fail, the MCA establishes which ones have failed so that it can generate exception reports for them and can try to resend the messages to them.

## Reply-to queue

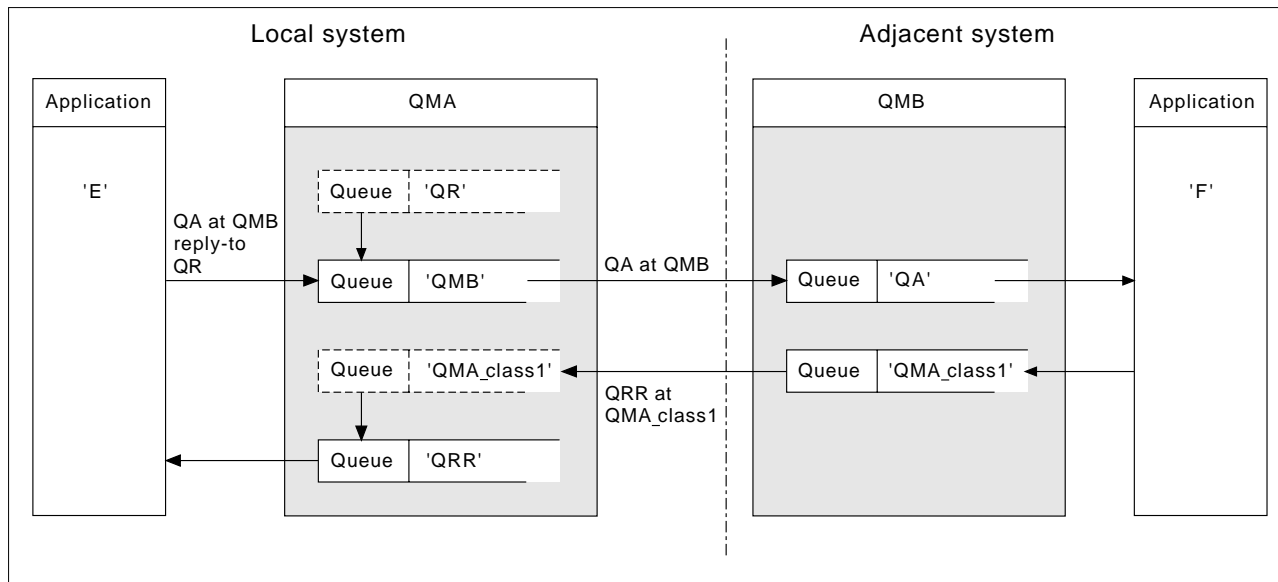

Figure 26. Reply-to queue name substitution during PUT call

A complete remote queue processing loop using a reply-to queue is shown in Figure 26. This applies in both a distributed-queuing environment and a clustering environment. The details are as shown in Table 6 on page 54.

The application opens QA at QMB and puts messages on that queue. The messages are given a reply-to queue name of QR, without the queue manager name being specified. Queue manager QMA finds the reply-to queue object QR and extracts from it the alias name of QRR and the queue manager name QMA\_class1. These names are put into the reply-to fields of the messages.

Reply messages from applications at QMB are addressed to QRR at QMA\_class1. The queue manager alias name definition QMA\_class1 is used by the queue manager to flow the messages to itself, and to queue QRR.

This scenario depicts the way you give applications the facility to choose a class of service for reply messages, the class being implemented by the transmission queue QMA\_class1 at QMB, together with the queue manager alias definition, QMA\_class1 at QMA. In this way, you can change an application's reply-to queue so that the flows are segregated without involving the application. That is, the application always chooses QR for this particular class of service, and you have the opportunity to change the class of service with the reply-to queue definition QR.

You create:

- Reply-to queue definition QR
- Transmission queue object QMB
- Channel\_out definition
- Channel\_back definition
- Queue manager alias definition QMA\_class1
- Local queue object QRR, if it does not exist

Your colleague at the adjacent system creates the:

## Reply-to queue

- Receiving channel definition
- Transmission queue object QMA\_class1
- Associated sending channel

Your application programs use:

- Reply-to queue name QR in put calls
- Queue name QRR in get calls

In this way, you may change the class of service as necessary, without involving the application, by changing the reply-to alias 'QR', together with the transmission queue 'QMA\_class1' and queue manager alias 'QMA\_class1'.

If no reply-to alias object is found when the message is put on the queue, the local queue manager name is inserted in the blank reply-to queue manager name field, and the reply-to queue name remains unchanged.

### **Name resolution restriction**

Because the name resolution has been carried out for the reply-to queue at 'QMA' when the original message was put, no further name resolution is allowed at 'QMB', that is, the message is put with the physical name of the reply-to queue by the replying application.

Note that the applications must be aware of the naming convention that the name they use for the reply-to queue is different from the name of the actual queue where the return messages are to be found.

For example, when two classes of service are provided for the use of applications with reply-to queue alias names of 'C1\_alias', and 'C2\_alias', the applications use these names as reply-to queue names in the message put calls, but the applications will actually expect messages to appear in queues 'C1' and 'C2', respectively.

However, an application is able to make an inquiry call on the reply-to alias queue to check for itself the name of the real queue it must use to get the reply messages.

## Reply-to queue alias example

This example illustrates the use of a reply-to alias to select a different route (transmission queue) for returned messages. The use of this facility requires the reply-to queue name to be changed in cooperation with the applications.

As shown in Figure 27 on page 49, the return route must be available for the reply messages, including the transmission queue, channel, and queue manager alias.

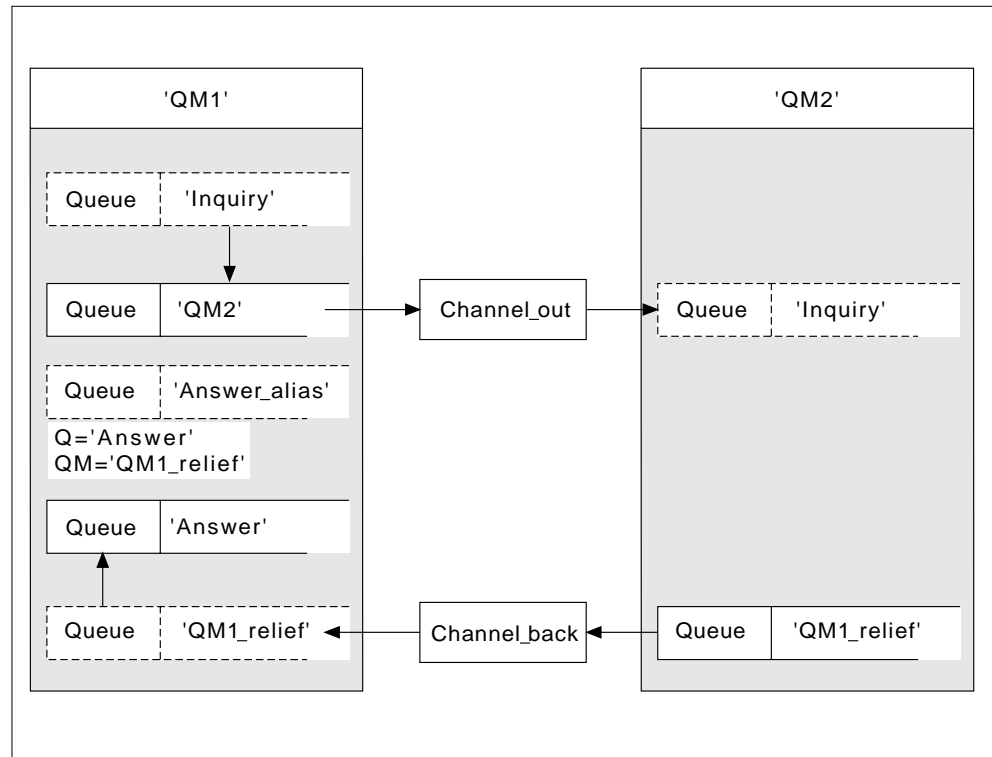

Figure 27. Reply-to queue alias example

This example is for requester applications at 'QM1' that send messages to server applications at 'QM2'. The servers' messages are to be returned through an alternative channel using transmission queue 'QM1\_relief' (the default return channel would be served with a transmission queue 'QM1').

The reply-to queue alias is a particular use of the remote queue definition named 'Answer\_alias'. Applications at QM1 include this name, 'Answer\_alias', in the reply-to field of all messages that they put on queue 'Inquiry'.

Reply-to queue definition 'Answer\_alias' is defined as 'Answer at QM1\_relief'. Applications at QM1 expect their replies to appear in the local queue named 'Answer'.

Server applications at QM2 use the reply-to field of received messages to obtain the queue and queue manager names for the reply messages to the requester at QM1.

#### Definitions used in this example at QM1

The system supervisor at QM1 must ensure that the reply-to queue 'Answer' is created along with the other objects. The name of the queue manager alias, marked with a '\*', must agree with the queue manager name in the reply-to queue alias definition, also marked with an '\*'.

## Reply-to queue

Object	Definition
Local transmission queue	QM2
Remote queue definition	Object name Inquiry Remote queue manager name QM2 Remote queue name Inquiry Transmission queue name QM2 (DEFAULT)
Queue manager alias	Object name QM1_relief * Queue manager name QM1 Queue name (blank)
Reply-to queue alias	Object name Answer_alias Remote queue manager name QM1_relief * Remote queue name Answer

### Definitions used in this example at QM2

The system supervisor at QM2 must ensure that the local queue exists for the incoming messages, and that the correctly named transmission queue is available for the reply messages.

Object	Definition
Local queue	Inquiry
Transmission queue	QM1_relief

### Put definition at QM1

Applications fill the reply-to fields with the reply-to queue alias name, and leave the queue manager name field blank.

Field	Content
Queue name	Inquiry
Queue manager name	(blank)
Reply-to queue name	Answer_alias
Reply-to queue manager	(blank)

### Put definition at QM2

Applications at QM2 retrieve the reply-to queue name and queue manager name from the original message and use them when putting the reply message on the reply-to queue.

Field	Content
Queue name	Answer
Queue manager name	QM1_relief

## How the example works

In this example, requester applications at QM1 always use 'Answer\_alias' as their reply-to queue in the relevant field of the put call, and they always retrieve their messages from the queue named 'Answer'.

The reply-to queue alias definitions are available for use by the QM1 system supervisor to change the name of the reply-to queue 'Answer', and of the return route 'QM1\_relief'.

Changing the queue name 'Answer' is normally not useful because the QM1 applications are expecting their answers in this queue. However, the QM1 supervisor is able to change the return route (class of service), as necessary.



## How the queue manager makes use of the reply-to queue alias

Queue manager QM1 retrieves the definitions from the reply-to queue alias when the reply-to queue name, included in the put call by the application, is the same as the reply-to queue alias, and the queue manager part is blank.

The queue manager replaces the reply-to queue name in the put call with the queue name from the definition. It replaces the blank queue manager name in the put call with the queue manager name from the definition.

These names are carried with the message in the message descriptor.

Table 3. Reply-to queue alias

Field name	Put call	Transmission header
Queue name	Answer_alias	Answer
Queue manager name	(blank)	QM1_relief

## Reply-to queue alias walk-through

To complete this example, let us take a walk through the process, from an application putting a message on a remote queue at queue manager 'QM1', through to the same application removing the reply message from the alias reply-to queue.

1. The application opens a queue named 'Inquiry', and puts messages to it. The application sets the reply-to fields of the message descriptor to:

Reply-to queue name	Answer_alias
Reply-to queue manager name	(blank)

2. Queue manager 'QM1' responds to the blank queue manager name by checking for a remote queue definition with the name 'Answer\_alias'. If none is found, the queue manager places its own name, 'QM1', in the reply-to queue manager field of the message descriptor.
3. If the queue manager finds a remote queue definition with the name 'Answer\_alias', it extracts the queue name and queue manager names from the definition (queue name='Answer' and queue manager name='QM1\_relief') and puts them into the reply-to fields of the message descriptor.
4. The queue manager 'QM1' uses the remote queue definition 'Inquiry' to determine that the intended destination queue is at queue manager 'QM2', and the message is placed on the transmission queue 'QM2'. 'QM2' is the default transmission queue name for messages destined for queues at queue manager 'QM2'.
5. When queue manager 'QM1' puts the message on the transmission queue, it adds a transmission header to the message. This header contains the name of the destination queue, 'Inquiry', and the destination queue manager, 'QM2'.
6. The message arrives at queue manager 'QM2', and is placed on the 'Inquiry' local queue.
7. An application gets the message from this queue and processes the message. The application prepares a reply message, and puts this reply message on the reply-to queue name from the message descriptor of the original message. This is:

Reply-to queue name	Answer
Reply-to queue manager name	QM1_relief

## Reply-to queue

8. Queue manager 'QM2' carries out the put command, and finding that the queue manager name, 'QM1\_relief', is a remote queue manager, it places the message on the transmission queue with the same name, 'QM1\_relief'. The message is given a transmission header containing the name of the destination queue, 'Answer', and the destination queue manager, 'QM1\_relief'.
9. The message is transferred to queue manager 'QM1' where the queue manager, recognizing that the queue manager name 'QM1\_relief' is an alias, extracts from the alias definition 'QM1\_relief' the physical queue manager name 'QM1'.
10. Queue manager 'QM1' then puts the message on the queue name contained in the transmission header, 'Answer'.
11. The application extracts its reply message from the queue 'Answer'.

---

## Networking considerations

In a distributed-queuing environment, because message destinations are addressed with just a queue name and a queue manager name, the following rules apply:

1. Where the queue manager name is given, and the name is different from the local queue manager's name:
  - A transmission queue must be available with the same name, and this transmission queue must be part of a message channel moving messages to another queue manager, or
  - A queue manager alias definition must exist to resolve the queue manager name to the same, or another queue manager name, and optional transmission queue, or
  - If the transmission queue name cannot be resolved, and a default transmission queue has been defined, the default transmission queue is used.
2. Where only the queue name is supplied, a queue of any type but with the same name must be available on the local queue manager. This queue may be a remote queue definition which resolves to: a transmission queue to an adjacent queue manager, a queue manager name, and an optional transmission queue.

To see how this works in a clustering environment, see the *MQSeries Queue Manager Clusters* book.

Consider the scenario of a message channel moving messages from one queue manager to another in a distributed-queuing environment.

The messages being moved have originated from any other queue manager in the network, and some messages may arrive that have an unknown queue manager name as destination. This can occur when a queue manager name has changed or has been removed from the system, for example.

The channel program recognizes this situation when it cannot find a transmission queue for these messages, and places the messages on your undelivered-message (dead-letter) queue. It is your responsibility to look for these messages and arrange for them to be forwarded to the correct destination, or to return them to the originator, where this can be ascertained.

Exception reports are generated in these circumstances, if report messages were requested in the original message.

**Name resolution convention**

It is strongly recommended that name resolution that changes the identity of the destination queue, (that is, logical to physical name changing), should only occur once, and only at the originating queue manager.

Subsequent use of the various alias possibilities should be used only when separating and combining message flows.

**Return routing**

Messages may contain a return address in the form of the name of a queue and queue manager. This applies in both a distributed-queuing environment and a clustering environment. This address is normally specified by the application that creates the message, but may be modified by any application that subsequently handles the message, including user exit applications.

Irrespective of the source of this address, any application handling the message may choose to use this address for returning answer, status, or report messages to the originating application.

The way these response messages is routed is not different from the way the original message is routed. You need to be aware that the message flows you create to other queue managers will need corresponding return flows.

**Physical name conflicts**

The destination reply-to queue name has been resolved to a physical queue name at the original queue manager, and must not be resolved again at the responding queue manager.

This is a likely possibility for name conflict problems that can only be prevented by a network-wide agreement on physical and logical queue names.

**Managing queue name translations**

This description is mainly provided for application designers and channel planners concerned with an individual system that has message channels to adjacent systems. It takes a local view of channel planning and control.

When you create a queue manager alias definition or a remote queue definition, the name resolution is carried out for every message carrying that name, regardless of the source of the message. To oversee this situation, which may involve large numbers of queues in a queue manager network, you keep tables of:

- The names of source queues and of source queue managers with respect to resolved queue names, resolved queue manager names, and resolved transmission queue names, with method of resolution
- The names of source queues with respect to:
  - Resolved destination queue names
  - Resolved destination queue manager names
  - Transmission queues
  - Message channel names

## Managing queue name translations

- Adjacent system names
- Reply-to queue names

**Note:** The use of the term *source* in this context refers to the queue name or the queue manager name provided by the application, or a channel program when opening a queue for putting messages.

An example of each of these tables is shown in Table 4, Table 5, and Table 6.

The names in these tables are derived from the examples in this chapter, and this table is not intended as a practical example of queue name resolution in one node.

Table 4. Queue name resolution at queue manager QMA

Source queue specified when queue is opened	Source queue manager specified when queue is opened	Resolved queue name	Resolved queue manager name	Resolved transmission queue name	Resolution type
QA_norm	-	QA_norm	QMB	QMB	Remote queue
(any)	QMB	-	-	QMB	(none)
QA_norm	-	QA_norm	QMB	TX1	Remote queue
QB	QMC	QB	QMD	QMB	Queue manager alias

Table 5. Queue name resolution at queue manager QMB

Source queue specified when queue is opened	Source queue manager specified when queue is opened	Resolved queue name	Resolved queue manager name	Resolved transmission queue name	Resolution type
QA_norm	-	QA_norm	QMB	-	(none)
QA_norm	QMB	QA_norm	QMB	-	(none)
QA_norm	QMB_PRIORITY	QA_norm	QMB	-	Queue manager alias
(any)	QMC	(any)	QMC	QMC	(none)
(any)	QMD_norm	(any)	QMD_norm	TX1	Queue manager alias
(any)	QMD_PRIORITY	(any)	QMD_PRIORITY	QMD_fast	Queue manager alias
(any)	QMC_small	(any)	QMC_small	TX_small	Queue manager alias
(any)	QMC_large	(any)	QMC_large	TX_external	Queue manager alias
QB_small	QMC	QB_small	QMC	TX_small	Remote queue
QB_large	QMC	QB_large	QMC	TX_large	Remote queue
(any)	QME	(any)	QME	TX1	Queue manager alias
QA	QMC	QA	QMC	TX1	Remote queue
QB	QMD	QB	QMD	TX1	Remote queue

Table 6. Reply-to queue name translation at queue manager QMA

Application design		Reply-to alias definition	
Local QMGR	Queue name for messages	Reply-to queue alias name	Redefined to
QMA	QRR	QR	QRR at QMA_class1

## Message sequence numbering

The message sequence numbering function is useful in some environments, especially when messages are to be guaranteed to be delivered, delivered without duplication, and stored in the same order as they were taken from the transmission queue. Each message sent using message sequencing is tagged with an individual sequence number, which is increased by one for each message sent. The sequence number is assigned by the sending channel. In some implementations, this sequence number is then regarded as a permanent attribute of the message, and is retained by the receiving channel; in other implementations, it is removed by the receiving channel.

Cooperating channels must be capable of:

- Respecting the sequential delivery attribute in their channel definition record
- Identifying or assigning a sequence number for each message sent or received
- Recording the sequence number assigned to the last message committed, on *hardened media* for use in recovery
- Recording the sequence numbers such that they can be read by status commands for problem resolution
- Detecting out-of-sequence conditions, such as duplicate numbers or gaps, and returning an appropriate error indication

Sequence numbering is incompatible with the use of multiple channels to serve one transmission queue.

The sequence number of the last committed message or LUWID is recorded at the receiving end of a channel. This number is used at the sending end when sequential delivery of messages has been selected. It is also used during resequencing, on startup and restarts, to ensure that both ends of the link agree on which messages have been transferred successfully.

The number stored at the sending end is incremented by one before being used; this means that the current sequence number is the number of the last message sent, and the numbering is independent of the instance of the MCA.

## Sequential retrieval of messages

If an application puts a sequence of messages to the same destination queue, those messages can be retrieved in sequence by a *single* application with a sequence of get operations, if, for local queuing, the following conditions are met:

- All of the put requests were done from the same application
- All of the put requests were either from the same unit of work, or all the put requests were made outside of a unit of work
- The application getting the message does not deliberately change the order of retrieval, for example by specifying a particular *MsgId* or *CorrelId* or by using message priorities
- Only one application is doing get operations to retrieve the messages from the destination queue, unless the applications doing the get operations ensure, for example, by specifying a *CorrelId*, that a single application always gets all of the messages in each sequence put by a sending application
- Only one channel is serving the transmission queue
- The messages are not nonpersistent messages on a fast channel

**Note:** Messages from other tasks and units of work may be interspersed with the sequence, even where the sequence was put from within a single unit of work.

The order is preserved for remote queuing, but only if the configuration is such that there can be only one path for the messages in the sequence, from the application making the put request, through its queue manager, through intercommunication, to the destination queue manager and the target queue.

**Note:** Messages that are destined for remote queues can also become out of sequence if one or more of them is put to a dead-letter queue (for example, if a queue is temporarily full).

## Message sequence numbering

If there is a possibility that some messages may be sent via a different path, for example because of reconfiguration, the order at the destination cannot be guaranteed.

## Sequence of retrieval of fast, nonpersistent messages

In MQSeries for AIX, AS/400, HP-UX, OS/2 Warp, OS/390 without CICS, Sun Solaris, Windows V2.1, and Windows NT, nonpersistent messages on a fast channel may overtake persistent messages on the same channel and so arrive out of sequence. The receiving MCA puts the nonpersistent messages on the destination queue immediately and makes them visible. Persistent messages are not made visible until the next syncpoint.

---

## Loopback testing

*Loopback testing* is a technique on non-OS/390 platforms that allows you to test a communications link without actually linking to another machine. You set up a connection between two queue managers as though they are on separate machines, but you test the connection by looping back to another process on the same machine. This means that you can test your communications code without requiring an active network.

The way you do this depends on which products and protocols you are using. For example the command to allow TCP/IP loopback testing on OS/2 without a network, is:

```
ifconfig lo ipaddress
```

On Windows NT, you can use the “loopback” adapter.

Refer to the documentation for the products you are using for more information.

---

## Chapter 5. DQM implementation

This chapter describes the implementation of the concepts introduced in “Chapter 2. Making your applications communicate” on page 17.

Distributed queue management (DQM):

- Enables you to define and control communication channels between queue managers
- Provides you with a message channel service to move messages from a type of *local queue*, known as a transmission queue, to communication links on a local system, and from communication links to local queues at a destination queue manager
- Provides you with facilities for monitoring the operation of channels and diagnosing problems, using panels, commands, and programs

This chapter discusses:

- “Functions of DQM”
- “Message sending and receiving” on page 58
- “Channel control function” on page 59
- “What happens when a message cannot be delivered?” on page 71
- “Initialization and configuration files” on page 73
- “Data conversion” on page 75
- “Writing your own message channel agents” on page 75

---

### Functions of DQM

Distributed queue management has these functions:

- Message sending and receiving
- Channel control
- Initialization file
- Data conversion
- Channel exits

Channel definitions associate channel names with transmission queues, communication link identifiers, and channel attributes. These are kept in a channel definition file (CDF), implemented in different ways on different platforms. Message sending and receiving is controlled by programs known as *message channel agents* (MCAs), which use the channel definitions to start up and control communication.

The MCAs in turn are controlled by DQM itself. The structure is platform dependent, but typically includes listeners and trigger monitors, together with operator commands and panels.

A *message channel* is a one-way pipe for moving messages from one queue manager to another. Thus a message channel has two end-points, represented by a pair of MCAs. Each end-point has a definition of its end of the message channel. For example, one end would define a sender, the other end a receiver.

## Functions of DQM

For details of how to define channels, see:

- “Chapter 8. Monitoring and controlling channels on distributed platforms” on page 105
- “Chapter 23. Monitoring and controlling channels on OS/390” on page 321
- “Chapter 26. Monitoring and controlling channels in OS/390 with CICS” on page 351
- “Chapter 30. Monitoring and controlling channels in MQSeries for AS/400” on page 423

For information about channel exits, see “Chapter 36. Channel-exit programs” on page 505.

## Message sending and receiving

Figure 28 shows the relationships between entities when messages are transmitted, and shows the flow of control.

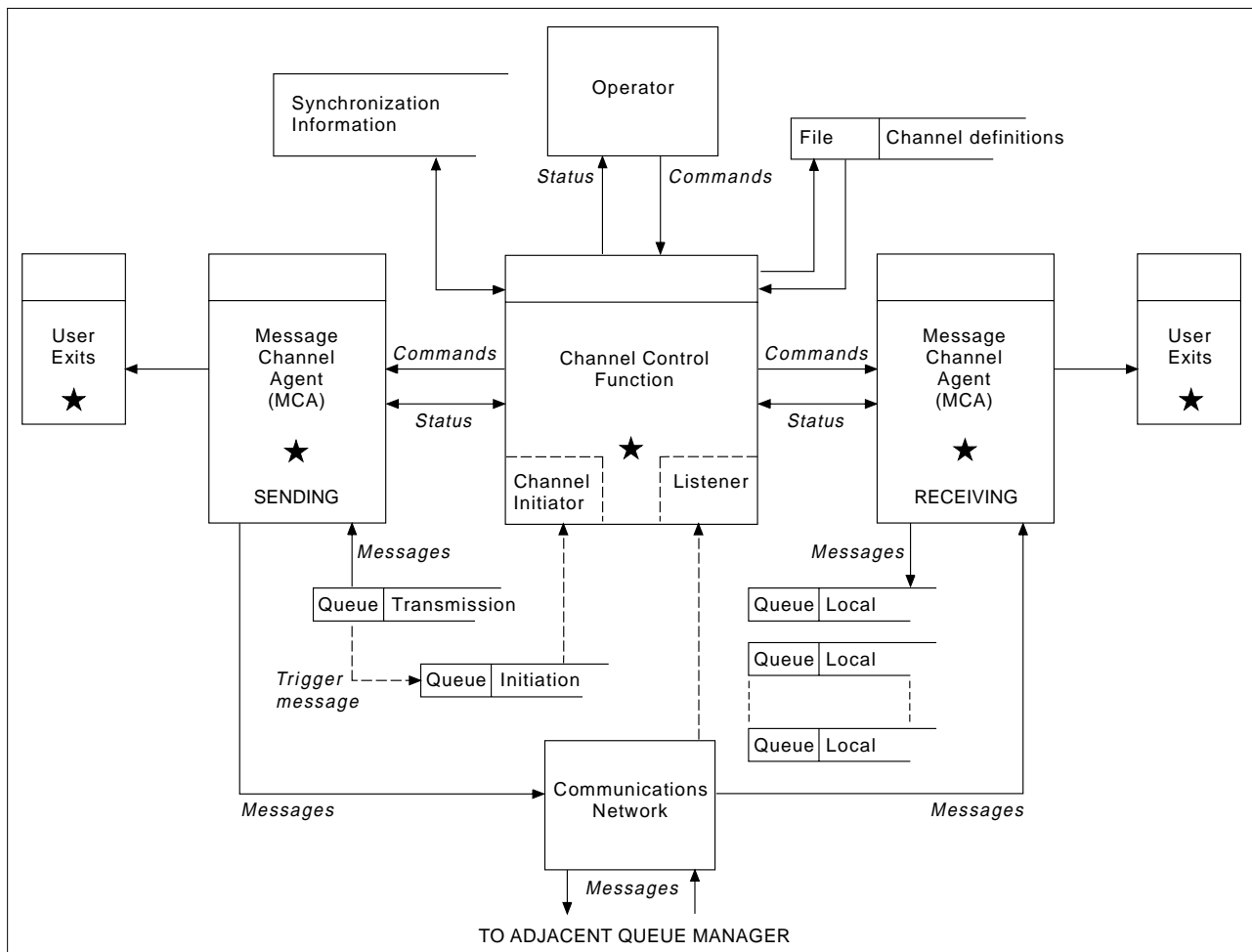

Figure 28. Distributed queue management model

### Notes:

1. There is one MCA per channel, depending on the platform. There may be one or more channel control functions for a given queue manager.



2. The implementation of MCAs and channel control functions is highly platform dependent; they may be programs or processes or threads, and they may be a single entity or many comprising several independent or linked parts.
3. All components marked with a star can use the MQI.

### Channel parameters

An MCA receives its parameters in one of several ways:

- If started by a command, the channel name is passed in a data area. The MCA then reads the channel definition directly to obtain its attributes.
- For sender, and in some cases server channels, the MCA can be started automatically by the queue manager trigger. The channel name is retrieved from the trigger process definition, where applicable, and is passed to the MCA. The remaining processing is the same as that described above.
- If started remotely by a sender, server, requester, or client-connection, the channel name is passed in the initial data from the partner message channel agent. The MCA reads the channel definition directly to obtain its attributes.

Certain attributes not defined in the channel definition are also negotiable:

#### Split messages

If one end does not support this, split messages will not be sent.

#### Conversion capability

If one end cannot perform the necessary code page conversion or numeric encoding conversion when needed, the other end must handle it. If neither end supports it, when needed, the channel cannot start.

#### Distribution list support

If one end does not support distribution lists, the partner MCA sets a flag in its transmission queue so that it will know to intercept messages intended for multiple destinations.

### Channel status and sequence numbers

Message channel agent programs keep records of the current sequence number and logical unit of work number for each channel, and of the general status of the channel. Some platforms allow you to display this status information to help you control channels.

---

## Channel control function

The channel control function provides facilities for you to define, monitor, and control channels. Commands are issued through panels, programs, or from a command line to the channel control function. The panel interface also displays channel status and channel definition data.

**Note:** For the channel control function on MQSeries for OS/2 Warp, Windows NT, Windows V2.1, UNIX systems, Digital OpenVMS, and Tandem NSK, you can use Programmable Command Formats or those MQSeries commands (MQSC) and control commands that are detailed in “Chapter 8. Monitoring and controlling channels on distributed platforms” on page 105.

The commands fall into the following groups:

- Channel administration
- Channel control
- Channel status monitoring

## Channel control function

Channel administration commands deal with the definitions of the channels. They enable you to:

- Create a channel definition
- Copy a channel definition
- Alter a channel definition
- Delete a channel definition

Channel control commands manage the operation of the channels. They enable you to:

- Start a channel
- Stop a channel
- Re-synchronize with partner (in some implementations)
- Reset message sequence numbers
- Resolve an in-doubt batch of messages
- Ping; send a test communication across the channel (not on MQSeries for Windows)

Channel monitoring displays the state of channels, for example:

- Current channel settings
- Whether the channel is active or inactive
- Whether the channel terminated in a synchronized state

## Preparing channels

Before trying to start a message channel or MQI channel, you must make sure that all the attributes of the local and remote channel definitions are correct and compatible. “Chapter 6. Channel attributes” on page 77 describes the channel definitions and attributes.

Although you set up explicit channel definitions, the channel negotiations carried out when a channel starts up may override one or other of the values defined. This is quite normal, and transparent, and has been arranged like this so that otherwise incompatible definitions can work together.

### Auto-definition of channels

In MQSeries for AIX, AS/400, HP-UX, OS/2 Warp, Sun Solaris, Windows NT, and OS/390 (cluster-receiver and cluster-sender channels only), if there is no appropriate channel definition, then for a receiver or server-connection channel that has auto-definition enabled, a definition is created automatically. The definition is created using:

1. The appropriate model channel definition, SYSTEM.AUTO.RECEIVER or SYSTEM.AUTO.SVRCONN. The model channel definitions for auto-definition are the same as the system defaults, SYSTEM.DEF.RECEIVER and SYSTEM.DEF.SVRCONN, except for the description field, which is “Auto-defined by” followed by 49 blanks. The systems administrator can choose to change any part of the supplied model channel definitions.
2. Information from the partner system. The partner’s values are used for the channel name and the sequence number wrap value.
3. A channel exit program, which you can use to alter the values created by the auto-definition. See “Channel auto-definition exit program” on page 516.

The description is then checked to determine whether it has been altered by an auto-definition exit or because the model definition has been changed. If the first 44 characters are still “Auto-defined by” followed by 29 blanks, the queue manager name is added. If the final 20 characters are still all blanks the local time and date are added.

Once the definition has been created and stored the channel start proceeds as though the definition had always existed. The batch size, transmission size, and message size are negotiated with the partner.

### Defining other objects

Before a message channel can be started, both ends must be defined (or enabled for auto-definition) at their respective queue managers. The transmission queue it is to serve must be defined to the queue manager at the sending end, and the communication link must be defined and available. In addition, it may be necessary for you to prepare other MQSeries objects, such as remote queue definitions, queue manager alias definitions, and reply-to queue alias definitions, so as to implement the scenarios described in “Chapter 2. Making your applications communicate” on page 17.

For information about MQI channels, see the *MQSeries Clients* book.

### Starting a channel (not MQSeries for Windows)

A channel can be caused to start transmitting messages in one of four ways. It can be:

- Started by an operator (not receiver or server-connection channels).
- Triggered from the transmission queue (sender, and possibly server channels only). You will need to prepare the necessary objects for triggering channels.
- Started from an application program (not receiver or server-connection channels).
- Started remotely from the network by a sender, requester, server, or client-connection channel. Receiver, and possibly server and requester channel transmissions, are started this way; so are server-connection channels. The channels themselves must already be started (that is, enabled).

**Note:** Because a channel is ‘started’ it is not necessarily transmitting messages, but, rather, it is ‘enabled’ to start transmitting when one of the four events described above occurs. The enabling and disabling of a channel is achieved using the START and STOP operator commands.

### Starting a channel on MQSeries for Windows

On MQSeries for Windows you start channels in the following ways:

- Using the start connection function of the MQSeries for Windows properties dialog. This function starts the components defined for the connection. The components are a queue manager, and optionally, a *channel group*. The channel group can contain the listener and up to eight channels. See the *MQSeries for Windows User's Guide*.
- Using the START CHANNEL MQSC command or, in Version 2.1, the START CHANNEL PCF command. This command starts just the specified channel. The queue manager must already be running.

## Channel control function

### Channel states

Figure 29 shows the hierarchy of all possible channel states, and Figure 30 on page 63 shows the links between them. These apply to all types of message channel. On MQSeries for AIX, AS/400, HP-UX, OS/2 Warp, OS/390, Sun Solaris, and Windows NT, these states apply also to server-connection channels.

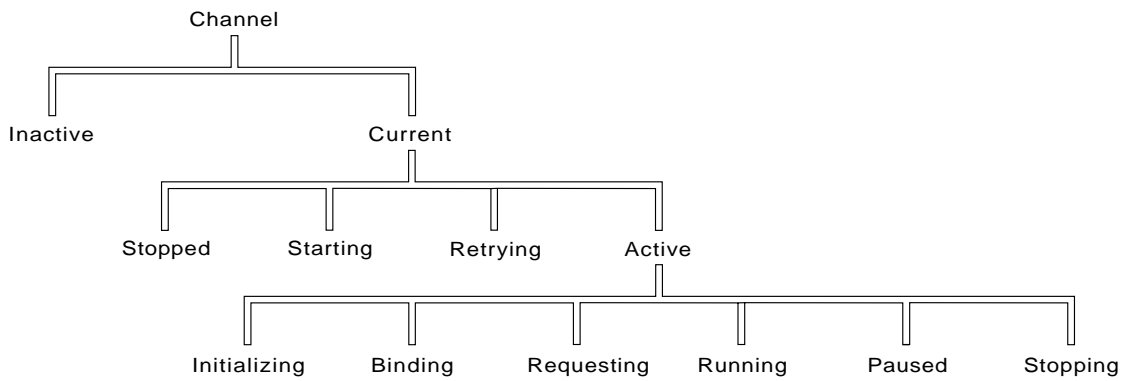

Figure 29. Channel states

#### Current and active

The channel is “current” if it is in any state other than inactive. A current channel is “active” unless it is in **RETRYING**, **STOPPED**, or **STARTING** state.

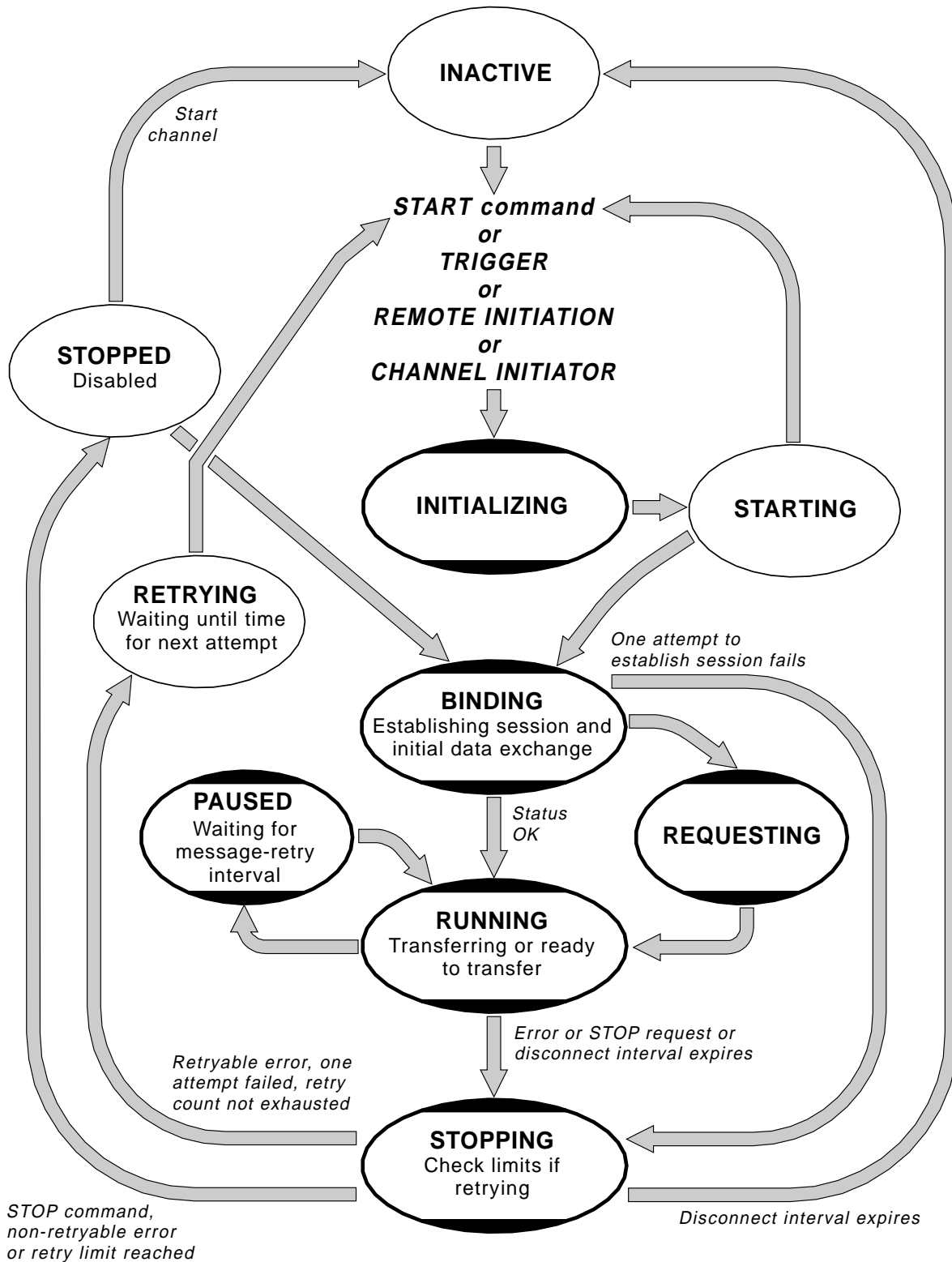

Figure 30. Flows between channel states

**Notes:**

1. When a channel is in one of the six states highlighted in Figure 30 (INITIALIZING, BINDING, REQUESTING, RUNNING, PAUSED, or STOPPING), it is consuming resource and a process or thread is running; the

## Channel control function

channel is *active*. (INITIALIZING occurs only on V5.1 of MQSeries for AIX, AS/400, HP-UX, OS/2 Warp, Sun Solaris, and Windows NT. PAUSED does not occur on OS/390.)

2. When a channel is in STOPPED state, the session may be active because the next state is not yet known.

**Specifying the maximum number of current channels:** You can specify the maximum number of channels that can be current at one time. This is the number of channels that have entries in the channel status table, including channels that are retrying and channels that are disabled (that is, stopped). Specify this in the channel initiator parameter module for OS/390, the queue manager initialization file for OS/400, the queue manager configuration file for OS/2, Tandem NSK, and UNIX systems, or the registry for Windows NT. For more information about the values you set using the initialization or the configuration file see “Appendix D. Configuration file stanzas for distributed queuing” on page 637. For more information about specifying the maximum number of channels, see the *MQSeries System Administration* book for V5.1 of MQSeries for AIX, HP-UX, OS/2 Warp, Sun Solaris, and Windows NT, the *MQSeries for AS/400 V5.1 System Administration* book for MQSeries for AS/400, or the *MQSeries System Management Guide* for your platform.

### Notes:

1. On MQSeries for AIX, AS/400, HP-UX, OS/2 Warp, OS/390, Sun Solaris, and Windows NT, server-connection channels are included in this number.
2. A channel must be current before it can become active. If a channel is started, but cannot become current, the start fails.
3. If you are using CICS for distributed queuing on OS/390, you cannot specify the maximum number of channels.
4. MQSeries for Windows does not support the *qm.ini* file. The maximum number of current channels and the maximum number of active channels is eight.

**Specifying the maximum number of active channels:** You can also specify the maximum number of active channels (except on MQSeries for OS/390 using CICS and MQSeries for Windows). You can do this to prevent your system being overloaded by a large number of starting channels. If you use this method, you should set the disconnect interval attribute to a low value to allow waiting channels to start as soon as other channels terminate.

Each time a channel that is retrying attempts to establish connection with its partner, it must become an active channel. If the attempt fails, it remains a current channel that is not active, until it is time for the next attempt. The number of times that a channel will retry, and how often, is determined by the retry count and retry interval channel attributes. There are short and long values for both these attributes. See “Chapter 6. Channel attributes” on page 77 for more information.

When a channel has to become an active channel (because a *START* command has been issued, or because it has been triggered, or because it is time for another retry attempt), but is unable to do so because the number of active channels is already at the maximum value, the channel waits until one of the active slots is freed by another channel instance ceasing to be active. If, however, a channel is starting because it is being initiated remotely, and there are no active slots available for it at that time, the remote initiation is rejected.

Whenever a channel, other than a requester channel, is attempting to become active, it goes into the *STARTING* state. This is true even if there is an active slot

immediately available, although in this case it will only be in STARTING state for a very short time. However, if the channel has to wait for an active slot, it is in STARTING state while it is waiting.

Requester channels do not go into STARTING state. If a requester channel cannot start because the number of active channels is already at the limit, the channel abends.

Whenever a channel, other than a requester channel, is unable to get an active slot, and so waits for one, a message is written to the log or the OS/390 console, and an event is generated. When a slot is subsequently freed and the channel is able to acquire it, another message and event are generated. Neither of these events and messages are generated if the channel is able to acquire a slot straightaway.

If a STOP CHANNEL command is issued while the channel is waiting to become active, the channel goes to STOPPED state. A Channel-Stopped event is raised as usual.

On MQSeries for AIX, AS/400, HP-UX, OS/2 Warp, OS/390, Sun Solaris, and Windows NT, server-connection channels are included in the maximum number of active channels.

For more information about specifying the maximum number of active channels, see the *MQSeries System Administration* book for V5.1 of MQSeries for AIX, HP-UX, OS/2 Warp, Sun Solaris, and Windows NT, the *MQSeries for AS/400 V5.1 System Administration* book for MQSeries for AS/400, the *MQSeries for Windows User's Guide*, or the *MQSeries System Management Guide* for your platform.

### Channel errors

Errors on channels cause the channel to stop further transmissions. If the channel is a sender or server, it goes to RETRY state because it is possible that the problem may clear itself. If it cannot go to RETRY state, the channel goes to STOPPED state. For sending channels, the associated transmission queue is set to GET(DISABLED) and triggering is turned off. (A STOP command takes the side that issued it to STOPPED state; only expiry of the disconnect interval will make it end normally and become inactive.) Channels that are in STOPPED state need operator intervention before they will restart (see "Restarting stopped channels" on page 69).

**Note:** For Digital OpenVMS, OS/2 Warp, OS/400, UNIX systems, Tandem NSK, and Windows NT, in order for retry to be attempted a channel initiator must be running. On platforms other than V5.1 of MQSeries for AIX, AS/400, HP-UX, OS/2 Warp, Sun Solaris, and Windows NT, the channel initiator must be monitoring the initiation queue specified in the transmission queue that the channel is using. MQSeries for Windows does not have a channel initiator; restarts are controlled by the MQSeries properties daemon task running in the background.

"Long retry count (LONGRTY)" on page 85 describes how retrying works. If the error clears, the channel restarts automatically, and the transmission queue is reenabled. If the retry limit is reached without the error clearing, the channel goes to STOPPED state. A stopped channel must be restarted manually by the operator. If the error is still present, it does not retry again. When it does start successfully, the transmission queue is reenabled.

On MQSeries for AIX, HP-UX, OS/2 Warp, OS/390 without CICS, Sun Solaris, and Windows NT, if the channel initiator or queue manager stops while a channel is in



## Channel control function

RETRYING or STOPPED status, the channel status is remembered when the channel initiator or queue manager is restarted.

On MQSeries for OS/2 Warp, Windows NT, OS/400, Tandem NSK, and UNIX systems, if a channel is unable to put a message to the target queue because that queue is full or put inhibited, the channel can retry the operation a number of times (specified in the message-retry count attribute) at a given time interval (specified in the message-retry interval attribute). Alternatively, you can write your own message-retry exit that determines which circumstances cause a retry, and the number of attempts made. The channel goes to PAUSED state while waiting for the message-retry interval to finish.

See “Chapter 6. Channel attributes” on page 77 for information about the channel attributes, and “Chapter 36. Channel-exit programs” on page 505 for information about the message-retry exit.

### Checking that the other end of the channel is still available

In MQSeries for AIX, AS/400, HP-UX, OS/2 Warp, OS/390 without CICS, Sun Solaris, and Windows NT, you can use the heartbeat-interval channel attribute to specify that flows are to be passed from the sending MCA when there are no messages on the transmission queue. This is described in “Heartbeat interval (HBINT)” on page 85.

In MQSeries for AIX, AS/400, HP-UX, OS/2 Warp, OS/390 without CICS, Sun Solaris, VSE/ESA, and Windows NT, if you are using TCP as your transport protocol, you can use the SO\_KEEPALIVE option on the TCP/IP socket. If you specify this option, TCP periodically checks that the other end of the connection is still available, and if it is not, the channel is terminated.

In MQSeries for AIX, AS/400, HP-UX, OS/2 Warp, Sun Solaris, and Windows NT, if you are using TCP as your transport protocol, the receiving end of inactive connections can also be closed if no data is received for a period of time. This period of time is determined according to the HBINT (heartbeat interval) value.

The timeout value is set as follows:

1. For an initial number of flows, before any negotiation has taken place, the timeout is twice the HBINT value from the channel definition.
2. When the channels have negotiated a HBINT value, the timeout is set to twice this value.

#### Notes:

1. If either of the above values is zero, then there is no timeout.
2. For connections that do not support heartbeats, the HBINT value is negotiated to zero in step 2 and hence there is no timeout, so we must use TCP/IP KEEPALIVE.
3. For client connections, heartbeats are only flowed from the server when the client issues an MQGET call with wait; none are flowed during other MQI calls. Therefore, you are not recommended to set the heartbeat interval too small for client channels. For example, if the heartbeat is set to ten seconds, an MQCMIT call will fail (with MQRC\_CONNECTION\_BROKEN) if it takes longer than twenty seconds to commit because no data will have been flowed during this time. This can happen with large units of work. However, it should not happen if appropriate values are chosen for the heartbeat interval because only MQGET with wait should take significant periods of time.



4. Aborting the connection after twice the heartbeat interval is valid because we expect flows (data or heartbeat) at least every heartbeat interval. If the heartbeat interval is set too small, however, problems can occur, especially if channel exits are in use. For example, if the HBINT value is one second, and a send or receive exit is used, the receiving end will only wait for two seconds before aborting the channel. This may not be long enough if the sending MCA spends a long time in the send exit, perhaps encrypting the message.

If you have unreliable channels that are suffering from TCP errors, use of `SO_KEEPALIVE` will mean that your channels are more likely to recover.

You can specify time intervals to control the behavior of the `SO_KEEPALIVE` option. When you change the time interval, only TCP/IP channels started after the change are affected. The value that you choose for the time interval should be less than the value of the disconnect interval for the channel.

For more information about using the `SO_KEEPALIVE` option on OS/390, see the *MQSeries for OS/390 System Management Guide*. For other platforms, see the chapter about setting up communications for your platform in this manual.

## Stopping and quiescing channels (not MQSeries for Windows)

Message channels are designed to be long-running connections between queue managers with orderly termination controlled only by the disconnect interval channel attribute. This mechanism works well unless the operator needs to terminate the channel before the disconnect time interval expires. This can occur in the following situations:

- System quiesce
- Resource conservation
- Unilateral action at one end of a channel

In this case, an operator command is provided to allow you to stop the channel. The command provided varies by platform, as follows:

**For OS/390 without CICS:**

The `STOP CHANNEL MQSC` command or the Stop a channel panel

**For OS/390 using CICS:**

The Stop option on the Message Channel List panel

**For OS/2, Windows NT, Digital OpenVMS, Tandem NSK, and UNIX systems:**

The `STOP CHANNEL MQSC` or `PCF` command

**For OS/400:**

`ENDMQMCHL` or the END option on the `WRKMQMCHL` panel

**For VSE/ESA:**

The `CLOSE` command from the `MQMMSK` panel or `MQCL` transaction closes (rather than stops) the channel.

For all of these commands there is a `FORCE` and a `QUIESCE` option. The `FORCE` option attempts to stop the channel immediately and may require the channel to resynchronize when it restarts because the channel may be left in doubt. The `QUIESCE` option attempts to end the current batch of messages and then terminate the channel. Note that both of these options leave the channel in a `STOPPED` state, requiring operator intervention to restart it.

Stopping the channel at the sending end is quite effective but does require operator intervention to restart. At the receiving end of the channel, things are much more

## Channel control function

difficult because the MCA is waiting for data from the sending side, and there is no way to initiate an *orderly* termination of the channel from the receiving side; the stop command is pending until the MCA returns from its wait for data.

Consequently there are three recommended ways of using channels, depending upon the operational characteristics required:

- If you want your channels to be long running, you should note that there can be orderly termination only from the sending end. When channels are interrupted, that is, stopped, operator intervention (a START CHANNEL command) is required in order to restart them.
- If you want your channels to be active only when there are messages for them to transmit, you should set the disconnect interval to a fairly low value. Note that the default setting is quite high and so is not recommended for channels where this level of control is required. Because it is difficult to interrupt the receiving channel, the most economical option is to have the channel automatically disconnect and reconnect as the workload demands. For most channels, the appropriate setting of the disconnect interval can be established heuristically.
- For MQSeries for AIX, AS/400, HP-UX, OS/2 Warp, OS/390 without CICS, Sun Solaris, and Windows NT, you can use the heartbeat-interval attribute to cause the sending MCA to send a heartbeat flow to the receiving MCA during periods in which it has no messages to send. This releases the receiving MCA from its wait state and gives it an opportunity to quiesce the channel without waiting for the disconnect interval to expire. Give the heartbeat interval a lower value than the value of the disconnect interval.

### Notes:

1. It is particularly advisable to set the disconnect interval to a low value, or to use heartbeats, for server channels. This is to allow for the case where the requester channel ends abnormally (for example, because the channel was canceled) when there are no messages for the server channel to send. In this case, the server does not detect that the requester has ended (it will only do this the next time it tries to send a message to the requester). While the server is still running, it holds the transmission queue open for exclusive input in order to get any more messages that may arrive on the queue. If an attempt is made to restart the channel from the requester, the start request receives an error because the server still has the transmission queue open for exclusive input. It is necessary to stop the server channel, and then restart the channel from the requester again.
2. On OS/390, without CICS, and on V5.1 of MQSeries for AIX, AS/400, HP-UX, OS/2 Warp, Sun Solaris, and Windows NT, server-connection channels can also be stopped like receiver channels.

## Stopping and quiescing channels (MQSeries for Windows)

On MQSeries for Windows you can stop or quiesce channels in the following ways:

- Using the stop connection function of the MQSeries for Windows properties dialog. This function stops the queue manager and any channels. Channels are forced to stop if necessary and may go into in-doubt status if a batch of messages is currently in transit. Any fast, nonpersistent messages that are in transit are lost.

- Using the STOP CHANNEL MQSC command or, in Version 2.1, the STOP CHANNEL PCF command. You can specify a FORCE or QUIESCE option on this command. Using this command stops just the specified channel and leaves the queue manager running.

### Restarting stopped channels

When a channel goes into STOPPED state (either because you have stopped the channel manually using one of the methods given in “Stopping and quiescing channels (not MQSeries for Windows)” on page 67, or because of a channel error) you have to restart the channel manually.

To do this, issue one of the following commands:

**For MQSeries for OS/390 without CICS:**

The START CHANNEL MQSC command or the Start a channel panel

**For MQSeries for OS/390 using CICS:**

The Start option on the Message Channel List panel

**For MQSeries for OS/2 Warp, Windows NT, Digital OpenVMS, Tandem NSK, and UNIX systems:**

The START CHANNEL MQSC or PCF command

**For MQSeries for AS/400:**

The START command on the WRKMQMCHL panel, the STRMQMCHL command, or the START CHANNEL MQSC or PCF command

**For MQSeries for Windows:**

The START CHANNEL MQSC command, in Version 2.1 the START CHANNEL PCF command, or the start connection function of the MQSeries properties dialog.

**For MQSeries for VSE/ESA:**

The OPEN command from the MQMMSK panel or MQCL transaction opens (rather than restarts) the channel.

For sender or server channels, when the channel entered the STOPPED state, the associated transmission queue was set to GET(DISABLED) and triggering was set off. When the start request is received, these attributes are reset automatically. On V5.1 of MQSeries for AIX, HP-UX, OS/2 Warp, Sun Solaris, and Windows NT, and MQSeries for OS/390 without CICS, if the channel initiator or queue manager stops while a channel is in RETRYING or STOPPED status, the channel status is remembered when the channel initiator or queue manager is restarted. On other platforms (apart from MQSeries for Windows), if the channel initiator or queue manager is restarted the status is lost and you have to alter the queue attributes manually to reenble triggering of the channel.

**Note:** If you are using CICS for distributed queuing on OS/390, these queue attributes are not reset automatically; you always have to alter them manually when you restart a channel.

### In-doubt channels

Observe the distinction between a channel being in doubt, which means that it is in doubt with its partner channel about which messages have been sent and received, and the queue manager being in doubt about which messages should be committed to a queue.

## Channel control function

Normally, all resolution of in-doubt situations on channels is handled automatically. Even if communication is lost, leaving the channel in doubt with a batch of messages at the sender whose receipt status is unknown, the situation will be resolved when communications are reestablished. Sequence number and LUWID records are kept for this purpose. (In fact, channels are only in doubt for the short period at the end of a batch while LUWID information is exchanged, and no more than one batch of messages can be in doubt for each channel.)

In exceptional circumstances it is possible to manually resynchronize the channel. (In this case, the term *manual* may refer to operators or to programs that contain MQSeries system management commands.) The manual resynchronization process works as follows. MQSC commands are used in this description; you can use the PCF equivalents instead.

1. On platforms other than MQSeries for Windows, use the DISPLAY CHSTATUS command to find the last-committed logical unit of work ID (LUWID) for **each** side of the channel. Do this using the following commands:

- For the in-doubt side of the channel:  
`DISPLAY CHSTATUS(name) SAVED CURLUWID`

You can use the CONNAME and XMITQ parameters to further identify the channel.

- For the receiving side of the channel:  
`DISPLAY CHSTATUS(name) SAVED LSTLUWID`

You can use the CONNAME parameter to further identify the channel.

The commands are different because only one side (the sending side) of the channel can be in doubt. The receiving side is never in doubt.

On MQSeries for AS/400, the DISPLAY CHSTATUS command can be executed from a file using the STRMQMMQSC command. Alternatively, the Work with MQM Channel Status CL command, WRKMQMCHST, provides similar function.

On MQSeries for Windows, the DISPLAY CHSTATUS command is not supported. Instead, use the Status button on the Components tab of the MQSeries for Windows properties dialog.

2. If you find that the two LUWIDs are the same, the receiving side has committed the unit of work that the sender considers to be in doubt. Therefore, the sending side can remove the in-doubt messages from the transmission queue and reenact it. This is done with the following channel RESOLVE command:

```
RESOLVE CHANNEL(name) ACTION(COMMIT)
```

3. If you find that the two LUWIDs are different, the receiving side has not committed the unit of work that the sender considers to be in doubt. On some platforms you can find out how many messages are in doubt by displaying the saved channel status. The sending side needs to retain the in-doubt messages on the transmission queue and resend them. This is done with the following channel RESOLVE command:

```
RESOLVE CHANNEL(name) ACTION(BACKOUT)
```

On MQSeries for AS/400, the Resolve MQM Channel command, RSVMQMCHL, provides a similar function.

Once this process is complete the channel will no longer be in doubt. This means that, if required, the transmission queue can be used by another channel.

### Problem determination

There are two distinct aspects to problem determination:

- Problems discovered when a command is being submitted
- Problems discovered during operation of the channels

### Command validation

Commands and panel data must be free from errors before they are accepted for processing. Any errors found by the validation are immediately notified to the user by error messages.

Problem diagnosis begins with the interpretation of these error messages and taking the recommended corrective action.

### Processing problems

Problems found during normal operation of the channels are notified to the system console or the system log or, for MQSeries for Windows, the channel log. Problem diagnosis begins with the collection of all relevant information from the log, and continues with analysis to identify the problem.

Confirmation and error messages are returned to the terminal that initiated the commands, when possible.

### Messages and codes

Where provided, the *Messages and Codes* manual of the particular platform can help with the primary diagnosis of the problem.

---

## What happens when a message cannot be delivered?

Figure 31 on page 72 shows the processing that occurs when an MCA is unable to put a message to the destination queue. (Note that the options shown do not apply on all platforms.)

## Undelivered messages

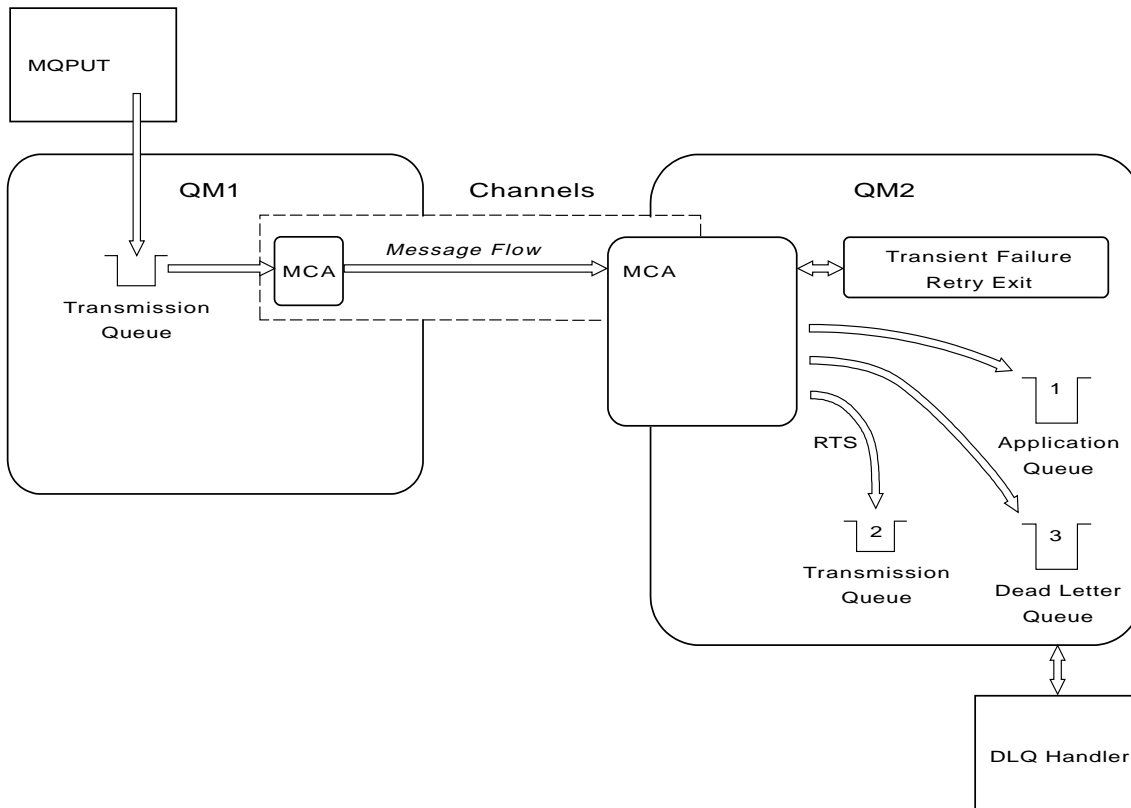

Figure 31. What happens when a message cannot be delivered

As shown in the figure, the MCA can do several things with a message that it cannot deliver. The action taken is determined by options specified when the channel is defined and on the MQPUT options for the message.

### 1. Message-retry

If the MCA is unable to put a message to the target queue for a reason that could be transitory (for example, because the queue is full), the MCA has the option to wait and retry the operation later. You can determine if the MCA waits, for how long, and how many times it retries.

- You can specify a message-retry time and interval for MQPUT errors when you define your channel. If the message cannot be put to the destination queue because the queue is full, or is inhibited for puts, the MCA retries the operation the number of times specified, at the time interval specified.
- You can write your own message-retry exit. The exit enables you to specify under what conditions you want the MCA to retry the MQPUT or MQOPEN operation. Specify the name of the exit when you define the channel.

Message-retry is not available on MQSeries for OS/390, MQSeries for Windows, or MQSeries for VSE/ESA.

### 2. Return-to-sender

If message-retry was unsuccessful, or a different type of error was encountered, the MCA can send the message back to the originator.

To enable this, you need to specify the following options in the message descriptor when you put the message to the original queue:

- The MQRO\_EXCEPTION\_WITH\_FULL\_DATA report option

- The MQRO\_DISCARD\_MSG report option
- The name of the reply-to queue and reply-to queue manager

If the MCA is unable to put the message to the destination queue, it generates an exception report containing the original message, and puts it on a transmission queue to be sent to the reply-to queue specified in the original message. (If the reply-to queue is on the same queue manager as the MCA, the message is put directly to that queue, not to a transmission queue.)

Return-to-sender is not available on OS/390 or VSE/ESA.

### 3. Dead-letter queue

If a message cannot be delivered or returned, it is put on to the dead-letter queue. You can use the DLQ handler to process the message. This is described in the *MQSeries System Administration* book for V5.1 of MQSeries for AIX, HP-UX, OS/2 Warp, Sun Solaris, and Windows NT, the *MQSeries for AS/400 V5.1 System Administration* book for MQSeries for OS/400, or in the *MQSeries System Management Guide* for your platform. (The DLQ handler is not supported on OS/390.)

If the dead-letter queue is not available, the sending MCA leaves the message on the transmission queue, and the channel stops. On a fast channel, nonpersistent messages that cannot be written to a dead-letter queue are lost.

Dead-letter queues are not supported on MQSeries for Windows.

---

## Initialization and configuration files

The handling of channel initialization data depends on your MQSeries platform.

### OS/390 without CICS

In MQSeries for OS/390 without CICS, initialization and configuration information is in the channel initiator parameter module CSQXPARM. You can also put commands in the CSQINPX initialization input data set, which is processed every time you start the channel initiator if you specify the optional DD statement CSQINPX in the channel initiator started task procedure. See the *MQSeries for OS/390 System Management Guide* for information about both of these.

### OS/390 using CICS

In MQSeries for OS/390 using CICS there is no channel initiator.

### Windows NT

On MQSeries for Windows NT, the *registry* file holds basic configuration information about the MQSeries installation. That is, information relevant to all of the queue managers on the MQSeries system and also information relating to individual queue managers.

### OS/2, Digital OpenVMS, Tandem NSK, OS/400 and UNIX systems

On MQSeries for OS/2 Warp, MQSeries for Compaq (DIGITAL) OpenVMS, MQSeries for Tandem NonStop Kernel, OS/400 and MQSeries on UNIX systems, there are *configuration files* to hold basic configuration information about the MQSeries installation.



## Initialization and configuration files

There are two configuration files: one applies to the machine, the other applies to an individual queue manager.

### MQSeries configuration file

This holds information relevant to all of the queue managers on the MQSeries system. The file is called MQSINI on Tandem NSK and mqs.ini on other platforms. It is fully described in the *MQSeries System Administration* book for MQSeries for AIX, MQSeries for HP-UX, MQSeries for OS/2 Warp, and MQSeries for Sun Solaris, in the *MQSeries for AS/400 V5.1 System Administration* book for MQSeries for AS/400, or in the *MQSeries System Management Guide* for your platform.

### Queue manager configuration file

The queue manager configuration file holds configuration information relating to one particular queue manager. The file is called QMINI on Tandem NSK, and qm.ini on other platforms.

It is created during queue manager creation and may hold configuration information relevant to any aspect of the queue manager. Information held in the file includes details of how the configuration of the log differs from the default in MQSeries configuration file.

The queue manager configuration file is held in the root of the directory tree occupied by the queue manager. On MQSeries for Windows NT, the qm.ini file is held in the registry. For example, for the DefaultPath attributes, the queue manager configuration files for a queue manager called QMNAME would be:

For OS/2:

```
c:\mqm\qmgrs\QMNAME\qm.ini
```

For UNIX systems:

```
/var/mqm/qmgrs/QMNAME/qm.ini
```

For Digital OpenVMS:

```
mqs_root:[mqm.qmgrs.QMNAME]qm.ini
```

For Tandem NSK:

The file is held in the subvolume of the queue manager. For example, the path and name for a configuration file for a queue manager called QMNAME could be \$VOLUME.QMNAME.QMINI.

An excerpt of a qm.ini file follows. It specifies that the TCP/IP listener is to listen on port 2500, the maximum number of current channels is to be 200 and the maximum number of active channels is to be 100.

```
TCP:
  Port=2500
CHANNELS:
  MaxChannels=200
  MaxActiveChannels=100
```

**Note:** For Tandem NSK, the format of the qm.ini file is slightly different. For more details about this, see the *MQSeries for Tandem NonStop Kernel System Management Guide*.

For OS/400:

```
/QIBM/UserData/mqm/qmgrs/QMNAME/qm.ini
```



For more information about qm.ini files see “Appendix D. Configuration file stanzas for distributed queuing” on page 637. For more information about QMINI files see the *MQSeries for Tandem NonStop Kernel System Management Guide*.

### VSE/ESA

There is no qm.ini file on VSE/ESA. Instead, use the Configuration main menu on the MQMMCFG panel to configure the queue manager.

---

## Data conversion

An MQSeries message consists of two parts:

- Control information in a message descriptor
- Application data

Either of the two parts may require data conversion when sent between queues on different queue managers. For information about data conversion, see the *MQSeries Application Programming Guide*.

---

## Writing your own message channel agents

MQSeries products other than MQSeries for Windows allow you to write your own message channel agent (MCA) programs or to install one from an independent software vendor. You might want to do this to make an MQSeries product interoperate over your own, proprietary communications protocol or to send messages over a protocol that MQSeries does not support. (You cannot write your own MCA to interoperate with an MQSeries-supplied MCA at the other end.)

If you decide to use an MCA that was not supplied by MQSeries, you need to consider the following.

### Message sending and receiving

You need to write a sending application that gets messages from wherever your application puts them, for example from a transmission queue (see the *MQSeries Application Programming Reference* book), and sends them out on a protocol with which you want to communicate. You also need to write a receiving application that takes messages from this protocol and puts them onto destination queues. The sending and receiving applications use the message queue interface (MQI) calls, not any special interfaces.

You need to ensure that messages are delivered once and once only. Syncpoint coordination can be used to help with this.

### Channel control function

You need to provide your own administration functions to control channels. You cannot use MQSeries channel administration functions either for configuring (for example, the DEFINE CHANNEL command) or monitoring (for example, DISPLAY CHSTATUS) your channels.

### Initialization file

You need to provide your own initialization file, if you require one.

### Application data conversion

You will probably want to allow for data conversion for messages you send to a different system. If so, use the MQGMO\_CONVERT option on the MQGET call when retrieving messages from wherever your application puts them, for example the transmission queue.

## Writing message channel agents

### User exits

Consider whether you need user exits. If so, you can use the same interface definitions that MQSeries uses.

### Triggering

If your application puts messages to a transmission queue, you can set up the transmission queue attributes so that your sending MCA is triggered when messages arrive on the queue.

### Channel initiator

You may need to provide your own channel initiator.

---

## Chapter 6. Channel attributes

The previous chapters have introduced the basic concepts of the product, the business perspective basis of its design, its implementation, and the control features.

This chapter describes the channel attributes held in the channel definitions. This is product-sensitive programming interface information.

You choose the attributes of a channel to be optimal for a given set of circumstances for each channel. However, when the channel is running, the actual values may have changed during startup negotiations. See “Preparing channels” on page 60.

Many attributes have default values, and you can use these for most channels. However, in those circumstances where the defaults are not optimal, refer to this chapter for guidance in selecting the correct values.

**Note:** In MQSeries for AS/400, most parameters can be specified as \*SYSDFTCHL, which means that the value is taken from the system default channel in your system.

---

### Channel attributes in alphabetical order

MQSeries for some platforms may not implement all the attributes shown in the list. Exceptions and platform differences are mentioned in the individual attribute descriptions, where relevant.

The keyword that you can specify in MQSC is shown in brackets for each attribute. (Attributes that apply only to MQSeries for OS/390 with CICS do not have MQSC keywords.)

The attributes are arranged in alphabetical order, as follows:

Attribute	See page...
Auto start (AUTOSTART)	78
Alter date (ALTDATE)	78
Alter time (ALTTIME)	78
Batch interval (BATCHINT)	79
Batch size (BATCSZ)	79
Channel name (CHANNEL)	80
Channel type (CHLTYPE)	81
CICS profile name	81
Cluster (CLUSTER)	81
Cluster namelist (CLUSNL)	82
Connection name (CONNAME)	82
Convert message (CONVERT)	83
Description (DESCR)	84
Disconnect interval (DISCINT)	84
Heartbeat interval (HBINT)	85
Long retry count (LONGRTY)	85
Long retry interval (LONGTMR)	85

## Channel attributes

Attribute	See page...
LU 6.2 mode name (MODENAME)	86
LU 6.2 transaction program name (TPNAME)	86
Maximum message length (MAXMSGL)	87
Maximum transmission size	87
Message channel agent name (MCANAME)	87
Message channel agent type (MCATYPE)	88
Message channel agent user identifier (MCAUSER)	88
Message exit name (MSGEXIT)	88
Message exit user data (MSGDATA)	89
Message-retry exit name (MREXIT)	89
Message-retry exit user data (MRDATA)	89
Message retry count (MRRTY)	89
Message retry interval (MRTMR)	89
Nonpersistent message speed (NPMSPEED)	90
Network-connection priority (NETPRTY)	90
Password (PASSWORD)	90
PUT authority (PUTAUT)	90
Queue manager name (QMNAME)	91
Receive exit name (RCVEXIT)	91
Receive exit user data (RCVDATA)	92
Security exit name (SCYEXIT)	92
Security exit user data (SCYDATA)	93
Send exit name (SENDEXIT)	93
Send exit user data (SENDDATA)	93
Sequence number wrap (SEQWRAP)	93
Sequential delivery	93
Short retry count (SHORTRTY)	93
Short retry interval (SHORTTMR)	94
Target system identifier	94
Transmission queue name (XMITQ)	94
Transport type (TRPTYPE)	95
User ID (USERID)	95

### Alter date (ALTDATE)

This is the date on which the definition was last altered, in the form yyyy-mm-dd.

This parameter is supported on AIX, HP-UX, OS/2 Warp, OS/390, OS/400, Sun Solaris, and Windows NT only.

### Alter time (ALTTIME)

This is the time at which the definition was last altered, in the form hh:mm:ss.

This parameter is supported on AIX, HP-UX, OS/2 Warp, OS/390, OS/400, Sun Solaris, and Windows NT only.

### Auto start (AUTOSTART)

In MQSeries for Tandem NonStop Kernel there is no SNA listener process. Each channel initiated from a remote system must have its own, unique TP name on which it can listen. Such channels must be defined to MQSC with the attribute AUTOSTART(ENABLED) to ensure that there is an LU 6.2 responder process listening on this TP name whenever the queue manager is started.

SNA channels defined AUTOSTART(DISABLED) do not listen for incoming SNA requests. LU 6.2 responder processes are not started for such channels.

### Batch interval (BATCHINT)

In V5.1 of MQSeries for AIX, AS/400, HP-UX, OS/2 Warp, Sun Solaris, and Windows NT, and MQSeries for OS/390 without CICS, you can specify a period of time, in milliseconds, during which the channel will keep a batch open even if there are no messages on the transmission queue. You can specify any number of milliseconds, from zero through 999 999 999. The default value is zero.

If you do not specify a batch interval, the batch closes when the number of messages specified in BATCHSZ has been sent or when the transmission queue becomes empty. On lightly loaded channels, where the transmission queue frequently becomes empty the effective batch size may be much smaller than BATCHSZ.

You can use the BATCHINT attribute to make your channels more efficient by reducing the number of short batches. Be aware, however, that you may slow down the response time, because batches will last longer and messages will remain uncommitted for longer.

If you specify a BATCHINT, batches close only when one of the following conditions is met:

- The number of messages specified in BATCHSZ have been sent.
- There are no more messages on the transmission queue and a time interval of BATCHINT has elapsed while waiting for messages (since the first message of the batch was retrieved).

**Note:** BATCHINT specifies the total amount of time that is spent waiting for messages. It does not include the time spent retrieving messages that are already available on the transmission queue, or the time spent transferring messages.

This attribute applies only to sender, cluster-sender, server, and cluster-receiver channels.

### Batch size (BATCHSZ)

The batch size is the maximum number of messages to be sent before a syncpoint is taken. The batch size does not affect the way the channel transfers messages; messages are always transferred individually, but are committed or backed out as a batch.

To improve performance, you can set a batch size to define the maximum number of messages to be transferred between two *syncpoints*. The batch size to be used is negotiated when a channel starts up, and the lower of the two channel definitions is taken. On some implementations, the batch size is calculated from the lowest of the two channel definitions and the two queue manager MAXUMSGS/MAXSMMSG values. The actual size of a batch can be less than this; for example, a batch completes when there are no messages left on the transmission queue or the batch interval expires.

A large value for the batch size increases throughput, but recovery times are increased because there are more messages to back out and resend. The default

## Batch size (BATCHSZ)

BATCHSZ is 50, and you are advised to try that value first. You might choose a lower value for BATCHSZ if your communications are unreliable, making the need to recover more likely.

Syncpoint procedure needs a unique logical unit of work identifier to be exchanged across the link every time a syncpoint is taken, to coordinate batch commit procedures.

If the synchronized batch commit procedure is interrupted, an *in-doubt* situation may arise. In-doubt situations are resolved automatically when a message channel starts up. If this resolution is not successful, manual intervention may be necessary, making use of the RESOLVE command.

Some considerations when choosing the number for batch size:

- If the number is too large, the amount of queue space taken up on both ends of the link becomes excessive. Messages take up queue space when they are not committed, and cannot be removed from queues until they are committed.
- If there is likely to be a steady flow of messages, you can improve the performance of a channel by increasing the batch size. However, this has the negative effect of increasing restart times, and very large batches may also affect performance.
- If message flow characteristics indicate that messages arrive intermittently, a batch size of 1 with a relatively large disconnect time interval may provide a better performance.
- The number may be in the range 1 through 9999. However, for data integrity reasons, channels connecting to any of the current platforms, as described in this book, should specify a batch size greater than 1. (A value of 1 is for use with Version 1 products, apart from MQSeries for MVS/ESA.)  
For OS/390 using CICS it must also be at least 3 less than the value set by the DEFINE MAXSMMSG command.
- Even though nonpersistent messages on a fast channel do not wait for a syncpoint, they do contribute to the batch-size count.

## Channel name (CHANNEL)

Specifies the name of the channel definition. The name can contain up to 20 characters, although as both ends of a message channel must have the same name, and other implementations may have restrictions on the size, the actual number of characters may have to be smaller.

Where possible, channel names should be unique to one channel between any two queue managers in a network of interconnected queue managers.

The name must contain characters from the following list:

Alphabetic	(A-Z, a-z; note that uppercase and lowercase are significant)
Numerics	(0-9)
Period	(.)
Forward slash	(/)
Underscore	(_)
Percentage sign	(%)

**Notes:**

1. Embedded blanks are not allowed, and leading blanks are ignored.
2. On systems using EBCDIC Katakana, you cannot use lowercase characters.

## Channel type (CHLTYPE)

Specifies the type of the channel being defined. The possible channel types are:

**Message channel types:**

- Sender
- Server (not MQSeries for VSE/ESA)
- Cluster-sender (MQSeries for OS/390 without CICS, V5.1 of MQSeries for AIX, AS/400, HP-UX, OS/2 Warp, Sun Solaris, and Windows NT only)
- Receiver
- Requester (not MQSeries for VSE/ESA)
- Cluster-receiver (MQSeries for OS/390 without CICS, V5.1 of MQSeries for AIX, AS/400, HP-UX, OS/2 Warp, Sun Solaris, and Windows NT only)

**MQI channel types:**

- Client-connection (MQSeries for OS/2 Warp, Windows NT, UNIX systems, VSE/ESA, DOS, Windows 3.1, Windows 95, and Windows 98 only)

**Note:** Client-connection channels can also be defined on OS/390 for use on other platforms.

- Server-connection (not MQSeries for OS/390 using CICS)

The two ends of a channel must have the same name and have compatible types:

- Sender with receiver
- Requester with server
- Requester with sender (for Call\_back)
- Server with receiver (server is used as a sender)
- Client-connection with server-connection
- Cluster-sender with cluster-receiver

## CICS profile name

This is for OS/390 using CICS only, to give extra definition for the session characteristics of the connection when CICS performs a communication session allocation, for example to select a particular COS.

The name must be known to CICS and be one to eight alphanumeric characters long.

## Cluster (CLUSTER)

The name of the cluster to which the channel belongs. The maximum length is 48 characters conforming to the rules for naming MQSeries objects.

This parameter is valid only for cluster-sender and cluster-receiver channels. Up to one of the resultant values of CLUSTER or CLUSNL can be nonblank. If one of the values is nonblank, the other must be blank.

This parameter is supported on AIX, HP-UX, OS/2 Warp, OS/390 without CICS, OS/400, Sun Solaris, and Windows NT only.

## Cluster namelist (CLUSNL)

### Cluster namelist (CLUSNL)

The name of the namelist that specifies a list of clusters to which the channel belongs.

This parameter is valid only for cluster-sender and cluster-receiver channels. Up to one of the resultant values of CLUSTER or CLUSNL can be nonblank. If one of the values is nonblank, the other must be blank.

This parameter is supported on AIX, HP-UX, OS/2 Warp, OS/390 without CICS, OS/400, Sun Solaris, and Windows NT only.

### Connection name (CONNAME)

This is the communications connection identifier. It specifies the particular communications link to be used by this channel.

This attribute is required for sender channels, requester channels, and client-connection channels. It does not apply to receiver or server-connection channel types.

It is optional for server channels, except on OS/390 using CICS where it is required in the channel definition, but is ignored unless the server is initiating the conversation.

For OS/390 using CICS this attribute names the CICS communication connection identifier for the session to be used for this channel. The name is one to four alphanumeric characters long.

Otherwise, the name is up to 48 characters for OS/390, 264 characters for other platforms, and:

#### If the transport type is TCP

This is either the hostname or the network address of the remote machine. For example, (MACH1.ABC.COM) or (19.22.11.162). It may include the port number, for example (MACHINE(123)).

#### If the transport type is UDP

For MQSeries for AIX and MQSeries for Windows V2.0 only, UDP is an alternative to TCP. As with TCP/IP, it is either the hostname or the network address of the remote machine.

#### If the transport type is LU 6.2

For Version 5.1 of MQSeries for OS/2, OS/400, Windows NT, and UNIX systems, give the fully-qualified name of the partner LU if the TPNAME and MODENAME are specified. For other versions or if the TPNAME and MODENAME are blank, give the CPI-C side information object name as described in the section in this book about setting up communication for your platform.

On OS/390 there are two forms in which to specify the value:

- Logical unit name

The logical unit information for the queue manager, comprising the logical unit name, TP name, and optional mode name. This can be specified in one of 3 forms:

luname, for example IGY12355

luname/TPname, for example IGY12345/APING

luname/TPname/modename, for example IGY12345/APINGD/#INTER



## Connection name (CONNAME)

For the first form, the TP name and mode name must be specified for the TPNAME and MODENAME attributes; otherwise these attributes must be blank.

**Note:** For client-connection channels, only the first form is allowed.

- Symbolic name

The symbolic destination name for the logical unit information for the queue manager, as defined in the side information data set. The TPNAME and MODENAME attributes must be blank.

**Note:** For cluster-receiver channels, the side information is on the other queue managers in the cluster. Alternatively, in this case it can be a name that a channel auto-definition exit can resolve into the appropriate logical unit information for the local queue manager.

For Digital OpenVMS, specify the Gateway Node name, the Access Name to the channel program, and the TPNAME used to invoke the remote program. For example: `CONNAME('SNAGWY.VMSREQUESTER(HOSTVR)')`.

For Tandem NonStop Kernel, the value depends on whether SNAX or ICE is used; see “Chapter 20. Setting up communication in Tandem NSK” on page 289.

### If the transmission protocol is NetBIOS

This is the NetBIOS name defined on the remote machine.

### If the transmission protocol is SPX

This is an SPX-style address consisting of a 4-byte network address, a 6-byte node address and a 2-byte socket number. Enter these in hexadecimal, with the network and node addresses separated by a fullstop and the socket number in brackets. For example:

```
CONNAME('0a0b0c0d.804abcde23a1(5e86)')
```

If the socket number is omitted, the default MQSeries SPX socket number is used. The default is X'5E86'.

**Note:** The definition of transmission protocol is contained in “Transport type (TRPTYPE)” on page 95.

## Convert message (CONVERT)

Application message data is usually converted by the receiving application. However, if the remote queue manager is on a platform that does not support data conversion, use this channel attribute to specify that the message should be converted into the format required by the receiving system **before** transmission.

This attribute applies only to sender, cluster-sender, server, and cluster-receiver channels and does not apply to MQSeries for OS/390 with CICS or MQSeries for Windows.

The possible values are ‘yes’ and ‘no’. If you specify ‘yes’, the application data in the message is converted before sending if you have specified one of the appropriate built-in format names (see the *MQSeries Application Programming Guide*). If you specify ‘no’, the application data in the message is not converted before sending.

## Description (DESCR)

### Description (DESCR)

This contains up to 64 bytes of text that describes the channel definition.

**Note:** The maximum number of characters is reduced if the system is using a double byte character set (DBCS).

Use characters from the character set identified by the coded character set identifier (CCSID) for the queue manager to ensure that the text is translated correctly if it is sent to another queue manager.

### Disconnect interval (DISCINT)

This is a time-out attribute, specified in seconds, for the server, cluster-sender, sender, and cluster-receiver channels. The interval is measured from the point at which a batch ends, that is when the batch size is reached or when the batch interval expires and the transmission queue becomes empty. If no messages arrive on the transmission queue during the specified time interval, the channel closes down. (The time is approximate.)

The close-down exchange of control data between the two ends of the channel includes an indication of the reason for closing. This ensures that the corresponding end of the channel remains available to start up again.

On all platforms except OS/390 with CICS, you can specify any number of seconds from zero through 999 999 where a value of zero means no disconnect; wait indefinitely.

In OS/390 using CICS, you can specify any number of seconds from zero through 9999 where a value of zero means disconnect as soon as the transmission queue is empty.

**Note:** Performance is affected by the value specified for the disconnect interval.

A very low value (a few seconds) may cause excessive overhead in constantly starting up the channel. A very large value (more than an hour) could mean that system resources are unnecessarily held up. For V5.1 of MQSeries for AIX, AS/400, HP-UX, OS/2 Warp, Sun Solaris, and Windows NT and MQSeries for OS/390 without CICS, you can also specify a heartbeat interval, so that when there are no messages on the transmission queue, the sending MCA will send a heartbeat flow to the receiving MCA, thus giving the receiving MCA an opportunity to quiesce the channel without waiting for the disconnect interval to expire. For these two values to work together effectively, the heartbeat interval value must be significantly lower than the disconnect interval value.

A value for the disconnect interval of a few minutes is a reasonable value to use. Change this value only if you understand the implications for performance, and you need a different value for the requirements of the traffic flowing down your channels.

For more information, see “Stopping and quiescing channels (not MQSeries for Windows)” on page 67.

## Heartbeat interval (HBINT)

This attribute applies to V5.1 of MQSeries for AIX, AS/400, HP-UX, OS/2 Warp, Sun Solaris, and Windows NT and MQSeries for OS/390 without CICS. You can specify the approximate time between heartbeat flows that are to be passed from a sending MCA when there are no messages on the transmission queue. Heartbeat flows unblock the receiving MCA, which is waiting for messages to arrive or for the disconnect interval to expire. When the receiving MCA is unblocked it can disconnect the channel without waiting for the disconnect interval to expire. Heartbeat flows also free any storage buffers that have been allocated for large messages and close any queues that have been left open at the receiving end of the channel.

The value is in seconds and must be in the range 0 through 999 999. A value of zero means that no heartbeat flows are to be sent. The default value is 300. To be most useful, the value should be significantly less than the disconnect interval value.

This attribute is valid for sender, cluster-sender, server, receiver, cluster-receiver, and requester channels. Other than on OS/390 and OS/400, it also applies to server-connection and client-connection channels. On these channels, heartbeats flow when a server MCA has issued an MQGET command with the WAIT option on behalf of a client application.

## Long retry count (LONGRTY)

Specify the maximum number of times that the channel is to try allocating a session to its partner. If the initial allocation attempt fails, the *short retry count* number is decremented and the channel retries the remaining number of times. If it still fails, it retries a *long retry count* number of times with an interval of *long retry interval* between each try. If it is still unsuccessful, the channel closes down. The channel must subsequently be restarted with a command (it is not started automatically by the channel initiator).

(Retry is not attempted if the cause of failure is such that a retry is not likely to be successful.)

If the channel initiator or queue manager stops while the channel is retrying, the *short retry count* and *long retry count* are reset when the channel initiator or queue manager is restarted.

The *long retry count* attribute is valid only for channel types of sender, cluster-sender, server, and cluster-receiver. It is also valid for requester channels on OS/390 if you are using CICS. It may be set from zero through 999 999 999. On OS/390 using CICS, it may be set from zero through 999, and the long and short retries have the same count.

**Note:** For OS/2, OS/400, UNIX systems, and Windows NT, in order for retry to be attempted a channel initiator must be running. The channel initiator must be monitoring the initiation queue specified in the transmission queue that the channel is using.

## Long retry interval (LONGTMR)

The approximate interval in seconds that the channel is to wait before retrying to establish connection, during the long retry mode.

## Long retry interval (LONGTMR)

The interval between retries may be extended if the channel has to wait to become active.

The channel tries to connect *long retry count* number of times at this long interval, after trying the *short retry count* number of times at the short retry interval.

This is valid only for channel types of sender, cluster-sender, server, and cluster-receiver. It is also valid for requester channels on OS/390 if you are using CICS. It may be set from zero through 999 999. On OS/390 using CICS, it may be set from zero through 999.

## LU 6.2 mode name (MODENAME)

This is for use with LU 6.2 connections. It gives extra definition for the session characteristics of the connection when a communication session allocation is performed.

When using side information for SNA communications, the mode name is defined in the CPI-C Communications Side Object or APPC side information and this attribute should be left blank; otherwise, it should be set to the SNA mode name.

The name must be one to eight alphanumeric characters long.

It is not valid for receiver or server-connection channels.

## LU 6.2 transaction program name (TPNAME)

This is for use with LU 6.2 connections. It is the name, or generic name, of the transaction program (MCA) to be run at the far end of the link.

When using side information for SNA communications, the transaction program name is defined in the CPI-C Communications Side Object or APPC side information and this attribute should be left blank. Otherwise, this name is required by sender channels and requester channels except on OS/390 using CICS where it is required in the channel definition but is ignored unless the server is initiating the conversation.

On platforms other than Tandem NSK, the name can be up to 64 characters long. See “Chapter 20. Setting up communication in Tandem NSK” on page 289 for more information about that platform.

If the remote system is MQSeries for OS/390 using CICS, the transaction is:

- CKRC when you are defining a sender channel, or a server channel that acts as a sender
- CKSV when you are defining a requester channel of a requester-server pair
- CKRC when you are defining a requester channel of a requester-sender pair

On other platforms, this should be set to the SNA transaction program name, unless the CONNAME contains a side-object name in which case it should be set to blanks. The actual name is taken instead from the CPI-C Communications Side Object, or the APPC side information data set.

This information is set in a different way on other platforms; see the section in this book about setting up communication for your platform.

## Maximum message length (MAXMSGL)

Specifies the maximum length of a message that can be transmitted on the channel.

On AIX, HP-UX, OS/2 Warp, OS/400, Sun Solaris, Windows NT, and VSE/ESA, specify a value greater than or equal to zero, and less than or equal to the maximum message length for the queue manager. See the MAXMSGL parameter of the *MQSeries Command Reference* book for more information. On other platforms, specify a value greater than or equal to zero, and less than or equal to 4 194 304 bytes.

Because various implementations of MQSeries systems exist on different platforms, the size available for message processing may be limited in some applications. This number must reflect a size that your system can handle without stress. When a channel starts up, the lower of the two numbers at each end of the channel is taken.

### Notes:

1. If splitting of messages is not supported at either end of a channel, the maximum message size cannot be greater than the negotiated maximum transmission size.
2. The IBM MQSeries products that this edition of the book applies to all support message splitting. Other MQSeries products do not support message splitting.
3. For a comparison of the functions available, including the different maximum message lengths available see the *MQSeries Planning Guide* and the *MQSeries Application Programming Guide*.
4. You may use a maximum message size of 0 which will be taken to mean that the size is to be set to the local queue manager maximum value.

## Maximum transmission size

If you are using CICS for distributed queuing on OS/390, you can specify the maximum transmission size, in bytes, that your channel is allowed to use when transmitting a message, or part of a message. When a channel starts up, this value is negotiated between the sending and receiving channels and the lower of the two values is agreed. The maximum size is 32 000 bytes on TCP/IP, but the maximum usable size is 32 000 bytes less the message descriptor. On VSE/ESA, the maximum size is 64 000 bytes on SNA.

Use this facility to ensure that system resources are not exceeded by your channels. Set this value in conjunction with the maximum message size, remembering to allow for message descriptors. An error situation may be created if the message size is allowed to exceed the transmission size, and message splitting is not supported.

### Notes:

1. If channel startup negotiation results in a size less than the minimum required for the local channel program, no messages can be transferred.
2. The IBM MQSeries products that this edition of the book applies to all support message splitting. Other MQSeries products do not support message splitting.

## Message channel agent name (MCANAME)

This attribute is reserved and should not be used.

## MCA type (MCATYPE)

### Message channel agent type (MCATYPE)

For MQSeries for AIX, AS/400, Windows NT, HP-UX, OS/2, and Sun Solaris, this attribute may be specified as a 'process' or a 'thread'. This parameter is valid for channel types of sender, cluster-sender (on V5.1 of MQSeries for AIX, AS/400, HP-UX, OS/2 Warp, Sun Solaris, and Windows NT only), server, requester, or cluster-receiver. On MQSeries for OS/390, it is supported only for channels with a channel type of cluster-receiver. The MCA type is used when the channel is started locally to determine how the channel is run.

Advantages of running as a process include:

- Isolation for each channel providing greater integrity
- Job authority specific for each channel
- Control over job scheduling

Advantages of threads include:

- Much reduced use of storage
- Easier configuration by typing on the command line
- Faster execution - it is quicker to start a thread than to instruct the operating system to start a process

For channel types of sender, server, and requester, the default is 'process'. For channel types of cluster-sender and cluster-receiver, the default is 'thread'. These defaults can change during your installation.

If you specify 'process' on the channel definition, a runmqchi process is started. If you specify 'thread', the MCA runs on a thread of the MQCHI process. On the machine that receives the inbound allocates, the MCA runs as a thread or process depending on whether you specify inetd or MQLSR.

### Message channel agent user identifier (MCAUSER)

This is not valid for OS/390 using CICS; it is not valid for channels of client-connection type.

This attribute is the user identifier (a string) to be used by the MCA for authorization to access MQSeries resources, including (if PUT authority is DEF) authorization to put the message to the destination queue for receiver or requester channels.

On MQSeries for Windows NT, the user identifier may be domain-qualified by using the format, user@domain, where the domain must be either the Windows NT domain of the local system or a trusted domain.

If this attribute is blank, the MCA uses its default user identifier.

### Message exit name (MSGEXIT)

Specifies the name of the user exit program to be run by the channel message exit. In V5.1 of MQSeries for AIX, AS/400, HP-UX, OS/2 Warp, Sun Solaris, and Windows NT this can be a list of names of programs that are to be run in succession. Leave blank, if no channel message exit is in effect.

The format and maximum length of this attribute depend on the platform, as for "Receive exit name (RCVEXIT)" on page 91.

## Message exit name (MSGEXIT)

The message exit is not supported on client-connection or server-connection channels.

## Message exit user data (MSGDATA)

Specifies user data that is passed to the channel message exits.

In V5.1 of MQSeries for AIX, AS/400, HP-UX, OS/2 Warp, Sun Solaris, and Windows NT, you can run a sequence of message exits. The limitations on the user data length and an example of how to specify MSGDATA for more than one exit are as shown for RCVDATA. See “Receive exit user data (RCVDATA)” on page 92.

On other platforms the maximum length of the string is 32 characters.

## Message-retry exit name (MREXIT)

Specifies the name of the user exit program to be run by the message-retry user exit. Leave blank if no message-retry exit program is in effect.

The format and maximum length of the name depend on the platform, as for “Receive exit name (RCVEXIT)” on page 91.

This parameter is only valid for receiver, cluster-receiver, and requester channels. It is not supported on MQSeries for OS/390 or MQSeries for Windows.

## Message-retry exit user data (MRDATA)

This is passed to the channel message-retry exit when it is called.

This parameter is only valid for receiver, cluster-receiver, and requester channels. It is not supported on MQSeries for OS/390 or MQSeries for Windows.

## Message retry count (MRRTY)

This is the number of times the channel will retry before it decides it cannot deliver the message.

This attribute controls the action of the MCA only if the message-retry exit name is blank. If the exit name is not blank, the value of MRRTY is passed to the exit for the exit’s use, but the number of retries performed (if any) is controlled by the exit, and not by this attribute.

The value must be in the range 0 to 999 999 999. A value of zero means that no retries will be performed.

This parameter is only valid for receiver, cluster-receiver, and requester channels. It is not supported on MQSeries for OS/390 or MQSeries for Windows.

## Message retry interval (MRTMR)

This is the minimum interval of time that must pass before the channel can retry the MQPUT operation. This time interval is in milliseconds.

This attribute controls the action of the MCA only if the message-retry exit name is blank. If the exit name is not blank, the value of MRTMR is passed to the exit for the exit’s use, but the retry interval is controlled by the exit, and not by this attribute.



## Message retry interval (MRTMR)

The value must be in the range 0 to 999 999 999. A value of zero means that the retry will be performed as soon as possible (provided that the value of MRRTY is greater than zero).

This parameter is only valid for receiver, cluster-receiver, and requester channels. It is not supported on MQSeries for OS/390 or MQSeries for Windows.

## Network-connection priority (NETPRTY)

The priority for the network connection. Distributed queuing will choose the path with the highest priority if there are multiple paths available. The value must be in the range 0 through 9; 0 is the lowest priority.

This parameter is valid only for cluster-receiver channels.

This parameter is valid only on AIX, HP-UX, OS/2 Warp, OS/390 without CICS, OS/400, Sun Solaris, and Windows NT.

## Nonpersistent message speed (NPMSPEED)

For V5.1 of MQSeries for AIX, AS/400, HP-UX, OS/2 Warp, Sun Solaris, and Windows NT, MQSeries for OS/390 without CICS, and MQSeries for Windows V2.1, you can specify the speed at which nonpersistent messages are to be sent. You can specify either 'normal' or 'fast'. The default is 'fast', which means that nonpersistent messages on a channel need not wait for a syncpoint before being made available for retrieval. The advantage of this is that nonpersistent messages become available for retrieval far more quickly. The disadvantage is that because they do not wait for a syncpoint, messages may be lost if there is a transmission failure or if the channel stops when the messages are in transit. See "Fast, nonpersistent messages" on page 22.

This attribute is valid for sender, cluster-sender, server, receiver, cluster-receiver, and requester channels.

## Password (PASSWORD)

You can specify a password of maximum length 12 characters, although only the first 10 characters are used.

The password may be used by the MCA when attempting to initiate a secure LU 6.2 session with a remote MCA. It is valid for channel types of sender, server, requester, or client-connection.

This does not apply to MQSeries for OS/390 except for client-connection channels, and does not apply to MQSeries for Windows.

## PUT authority (PUTAUT)

Use this field to choose the type of security processing to be carried out by the MCA when executing 1) an MQPUT command to the destination queue (for message channels) ,or 2) an MQI call (for MQI channels). (PUT security is not supported on MQSeries for Windows.)

You can choose one of the following:

### **Process security, also called default authority (DEF)**

Default user ID is used.



## PUT authority (PUTAUT)

On OS/390, this might involve using both the user ID received from the network and that derived from MCAUSER.

On other platforms, with Process security, you choose to have the queue security based on the user ID that the process is running under. If MCAUSER is not blank, the user ID has the value of MCAUSER; otherwise, the user ID is that of the process, or user, running the MCA at the receiving end of the message channel.

The queues are opened with this user ID, and the open option MQOO\_SET\_ALL\_CONTEXT.

### Context security (CTX)

Alternate user ID is used from the context information associated with a message.

On OS/390, this may involve also using either the user ID received from the network, or the user ID derived from MCAUSER, or both.

The *UserIdentifier* in the message descriptor is moved into the *AlternateUserId* field in the object descriptor. The queue is opened with the open options MQOO\_SET\_ALL\_CONTEXT and MQOO\_ALTERNATE\_USER\_AUTHORITY.

### Only Message Channel Agent security (ONLYMCA)

This is supported on OS/390 only and is the same as process security but any user ID received from the network is not used.

### Alternate Message Channel Agent security (ALTMCA)

This is supported on OS/390 only and is the same as context security but any user ID received from the network is not used.

This parameter is only valid for receiver, requester, cluster-receiver, and server-connection channels. Context security and alternate message channel agent security are not supported on server-connection channels.

Further details about context fields and open options can be found in the *MQSeries Application Programming Guide*. Further details about security can be found in the *MQSeries System Administration* book for V5.1 of MQSeries for AIX, HP-UX, OS/2 Warp, Sun Solaris, and Windows NT, the *MQSeries for AS/400 V5.1 System Administration* book for MQSeries for AS/400, the *MQSeries for Windows User's Guide*, or in the *MQSeries System Management Guide* or *MQSeries Administration Guide* for your platform.

## Queue manager name (QMNAME)

This applies to a channel of client-connection type only. It is the name of the queue manager or queue manager group to which an MQSeries client application can request connection.

## Receive exit name (RCVEXIT)

Specifies the name of the user exit program to be run by the channel receive user exit. In V5.1 of MQSeries for AIX, AS/400, HP-UX, OS/2 Warp, Sun Solaris, and Windows NT this can be a list of names of programs that are to be run in succession. Leave blank, if no channel receive user exit is in effect.

The format and maximum length of this attribute depend on the platform:

- On OS/390 it is a load module name, maximum length 8 characters, except for client-connection channels where the maximum length is 128 characters.
- On OS/400 it is of the form:

## Receive exit name (RCVEXIT)

*libname/progname*

when specified in CL commands.

When specified in MQSeries Commands (MQSC) it has the form:

*progname libname*

where *progname* occupies the first 10 characters, and *libname* the second 10 characters (both blank-padded to the right if necessary). The maximum length of the string is 20 characters.

- On OS/2 and Windows it is of the form:

*dllname(functionname)*

where *dllname* is specified without the suffix “.DLL”. The maximum length of the string is 40 characters.

- On UNIX systems, Digital OpenVMS, and Tandem NSK it is of the form:

*libraryname(functionname)*

The maximum length of the string is 40 characters.

In V5.1 of MQSeries for AIX, AS/400, HP-UX, OS/2 Warp, Sun Solaris, and Windows NT you can specify a list of receive, send, or message exit program names. The names should be separated by a comma, a space, or both. For example:

```
RCVEXIT(exit1 exit2)
MSGEXIT(exit1,exit2)
SENDEXIT(exit1, exit2)
```

In V5.1 of MQSeries for AIX, AS/400, HP-UX, OS/2 Warp, Sun Solaris, and Windows NT the total length of the string of exit names and strings of user data for a particular type of exit is limited to 500 characters. In MQSeries for AS/400 you can list up to 10 exit names.

## Receive exit user data (RCVDATA)

Specifies user data that is passed to the receive exit.

In V5.1 of MQSeries for AIX, AS/400, HP-UX, OS/2 Warp, Sun Solaris, and Windows NT, you can run a sequence of receive exits. The string of user data for a series of exits should be separated by a comma, spaces, or both. For example:

```
RCVDATA(exit1_data exit2_data)
MSGDATA(exit1_data,exit2_data)
SENDDATA(exit1_data, exit2_data)
```

In V5.1 of MQSeries for AIX, AS/400, HP-UX, OS/2 Warp, Sun Solaris, and Windows NT the length of the string of exit names and strings of user data is limited to 500 characters. In MQSeries for AS/400 you can specify up to 10 exit names and the length of user data for each is limited to 32 characters.

On other platforms the maximum length of the string is 32 characters.

## Security exit name (SCYEXIT)

Specifies the name of the exit program to be run by the channel security exit. Leave blank if no channel security exit is in effect.

## Security exit name (SCYEXIT)

The format and maximum length of the name depend on the platform, as for “Receive exit name (RCVEXIT)” on page 91.

## Security exit user data (SCYDATA)

Specifies user data that is passed to the security exit. The maximum length is 32 characters.

## Send exit name (SENDEXIT)

Specifies the name of the exit program to be run by the channel send exit. In V5.1 of MQSeries for AIX, AS/400, HP-UX, OS/2 Warp, Sun Solaris, and Windows NT this can be a list of names of programs that are to be run in sequence. Leave blank if no channel send exit is in effect.

The format and maximum length of this attribute depend on the platform, as for “Receive exit name (RCVEXIT)” on page 91.

## Send exit user data (SENDDATA)

Specifies user data that is passed to the send exit.

In V5.1 of MQSeries for AIX, AS/400, HP-UX, OS/2 Warp, Sun Solaris, and Windows NT, you can run a sequence of send exits. The limitations on the user data length and an example of how to specify SENDDATA for more than one exit, are as shown for RCVDATA. See “Receive exit user data (RCVDATA)” on page 92.

On other platforms the maximum length of the string is 32 characters.

## Sequence number wrap (SEQWRAP)

This is the highest number the message sequence number reaches before it restarts at 1. In OS/390 using CICS, this number is of interest only when sequential delivery of messages is selected. It is not valid for channel types of client-connection or server-connection.

The value of the number should be high enough to avoid a number being reissued while it is still being used by an earlier message. The two ends of a channel must have the same sequence number wrap value when a channel starts up; otherwise, an error occurs.

The value may be set from 100 through 999 999 999 (1 through 9 999 999 for OS/390 using CICS).

## Sequential delivery

This applies only to OS/390 using CICS. Set this to ‘YES’ when using sequential numbering of messages. If one side of the channel requests this facility, it must be accepted by the other side.

There could be a performance penalty associated with the use of this option.

For other platforms, the MCA always uses message sequence numbering.

## Short retry count (SHORTRTY)

Specify the maximum number of times that the channel is to try allocating a session to its partner. If the initial allocation attempt fails, the *short retry count* is decremented and the channel retries the remaining number of times with an

## Short retry count (SHORTRTY)

interval, defined in the *short retry interval* attribute, between each attempt. If it still fails, it retries *long retry count* number of times with an interval of *long retry interval* between each attempt. If it is still unsuccessful, the channel terminates.

(Retry is not attempted if the cause of failure is such that a retry is not likely to be successful.)

If the channel initiator or queue manager stops while the channel is retrying, the *short retry count* and *long retry count* are reset when the channel initiator or queue manager is restarted.

The *short retry count* attribute is valid only for channel types of sender, cluster-sender, server, and cluster-receiver. It is also valid for requester channels on OS/390 if you are using CICS. It may be set from zero through 999 999 999 (1 through 999 for OS/390 using CICS, and the long and short retries have the same count).

**Note:** For MQSeries for OS/2 Warp, OS/400, UNIX systems, and Windows NT, in order for retry to be attempted a channel initiator must be running. The channel initiator must be monitoring the initiation queue specified in the transmission queue that the channel is using.

## Short retry interval (SHORTTMR)

Specify the approximate interval in seconds that the channel is to wait before retrying to establish connection, during the short retry mode.

The interval between retries may be extended if the channel has to wait to become active.

This attribute is valid only for channel types of sender, cluster-sender, server, and cluster-receiver. It is also valid for requester channels on OS/390 if you are using CICS. It may be set from zero through 999 999. (0 through 999 for OS/390 using CICS).

## Target system identifier

This is for OS/390 using CICS only. It identifies the particular CICS system where the sending or requesting channel transaction is to run.

The default is blank, which means the CICS system where you are logged on. The name may be one through four alphanumeric characters.

## Transaction identifier

This only applies to OS/390 using CICS.

The name of the local CICS transaction that you want to start. If you do not specify a value, the name of the supplied transaction for the channel type is used.

## Transmission queue name (XMITQ)

The name of the transmission queue from which messages are retrieved. This is required for channels of type sender or server, it is not valid for other channel types.

## Transmission queue name (XMITQ)

Provide the name of the transmission queue to be associated with this sender or server channel, that corresponds to the queue manager at the far side of the channel. The transmission queue may be given the same name as the queue manager at the remote end.

## Transport type (TRPTYPE)

This does not apply to OS/390 using CICS.

The possible values are:

LU62	LU 6.2
TCP	TCP/IP (1)
UDP	UDP (2)
NETBIOS	NetBIOS (3)
SPX	SPX (3)
<b>Notes:</b> <ol style="list-style-type: none"><li>1. MQSeries for Windows Version 2.1 supports TCP only.</li><li>2. UDP is supported on MQSeries for AIX and MQSeries for Windows Version 2.0 only.</li><li>3. For use on OS/2 and Windows NT. Can also be used on OS/390 for defining client-connection channels for use on OS/2 and Windows NT.</li></ol>	

## User ID (USERID)

On V5.1 of MQSeries for AIX, AS/400, HP-UX, OS/2 Warp, Sun Solaris, and Windows NT, you can specify a task user identifier of 20 characters. On other platforms, you can specify a task user identifier of maximum length 12 characters, although only the first 10 characters are used.

The user ID may be used by the MCA when attempting to initiate a secure SNA session with a remote MCA. It is valid for channel types of sender, server, requester, or client-connection.

This does not apply to MQSeries for OS/390 except for client-connection channels.

## Intercommunication

---

## Chapter 7. Example configuration chapters in this book

Throughout the following parts of the book, there is a series of chapters containing examples of how to configure the various platforms to communicate with each other. These chapters describe tasks performed to establish a working MQSeries network. The tasks were to establish MQSeries *sender* and *receiver* channels to enable bi-directional message flow between the platforms over all supported protocols.

Figure 32 is a conceptual representation of a single channel and the MQSeries objects associated with it.

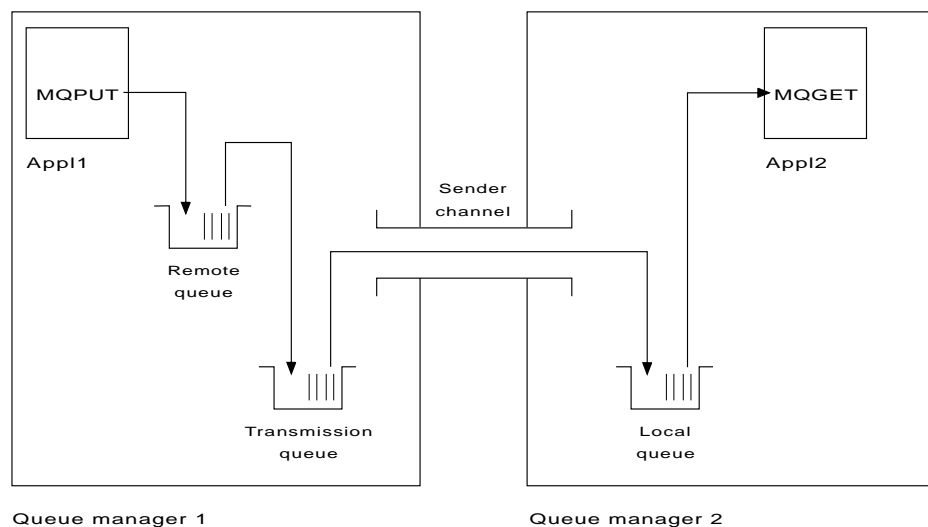

Figure 32. MQSeries channel to be set up in the example configuration chapters in this book

This is a simple example, intended to introduce only the basic elements of the MQSeries network. It does not demonstrate the use of triggering which is described in “Triggering channels” on page 20.

The objects in this network are:

- A remote queue
- A transmission queue
- A local queue
- A sender channel

App1 and App12 are both application programs; App1 is putting messages and App12 is receiving them.

App1 puts messages to a remote queue. The definition for this remote queue specifies the name of a target queue manager, a local queue on that queue manager, and a transmission queue on this the local queue manager.

When the queue manager receives the request from App1 to put a message to the remote queue, it looks at the queue definition and sees that the destination is remote. It therefore puts the message straight onto the transmission queue

## Example configurations

specified in the definition. The message remains on the transmission queue until the channel becomes available, which may happen immediately.

A sender channel has in its definition a reference to one, and one only, transmission queue. When a channel is started, and at other times during its normal operation, it will look at this transmission queue and send any messages on it to the target system. The message has in its transmission header details of the destination queue and queue manager.

The intercommunication examples in the following chapters describe in detail the creation of each of the objects described above, for a variety of platform combinations.

On the target queue manager, definitions are required for the local queue and the receiver side of the channel. These objects operate independently of each other and so can be created in any sequence.

On the local queue manager, definitions are required for the remote queue, the transmission queue, and the sender side of the channel. Since both the remote queue definition and the channel definition refer to the transmission queue name, it is advisable to create the transmission queue first.

---

## Network infrastructure

The configuration examples assume that all the systems are connected to a Token Ring network with the exception of OS/390 and VSE/ESA, which communicate via a 3745 (or equivalent) that is attached to the Token Ring, and Sun Solaris, which is on an adjacent local area network (LAN) also attached to the 3745.

It is also assumed that, for SNA, all the required definitions in VTAM<sup>®</sup> and network control program (NCP) are in place and activated for the LAN-attached platforms to communicate over the wide area network (WAN).

Similarly, for TCP, it is assumed that nameserver function is available, either via a domain nameserver or via locally held tables (for example a host file).

---

## Communications software

Working configurations are given in the following chapters for the following network software products:

- SNA
  - Communications Manager/2 Version 1.11
  - Communications Server for Windows NT, Version 5.0
  - AIX Communications Server, V5.0
  - Hewlett-Packard SNAplus2
  - AT&T GIS SNA Services Version 2.06 or later
  - OS/400 Version 4 Release 4
  - SunLink Peer-to-Peer Version 9.1
  - OS/390 Version 2 Release 4
  - CICS/VSE<sup>®</sup> Version 2 Release 1



- TCP
  - TCP for OS/2 Version 2
  - Microsoft Windows NT Version 4 or later
  - AIX Version 4 Release 1.4
  - HP-UX Version 10.2 or later
  - AT&T GIS UNIX Release 2.03.01
  - Sun Solaris Release 2.4
  - OS/400 Version 4 Release 4
  - TCP for OS/390
  - Digital UNIX Version 4.0 or later
- NetBIOS
- SPX
- UDP

---

## How to use the communication examples

The following chapters contain example configurations:

- “Chapter 11. Example configuration - IBM MQSeries for OS/2 Warp” on page 137
- “Chapter 12. Example configuration - IBM MQSeries for Windows NT” on page 169
- “Chapter 14. Example configuration - IBM MQSeries for AIX” on page 197
- “Chapter 15. Example configuration - IBM MQSeries for DIGITAL UNIX (Compaq Tru64 UNIX)” on page 215
- “Chapter 16. Example configuration - IBM MQSeries for HP-UX” on page 219
- “Chapter 17. Example configuration - IBM MQSeries for AT&T GIS UNIX Version 2.2” on page 243
- “Chapter 18. Example configuration - IBM MQSeries for Sun Solaris” on page 257
- “Chapter 29. Example configuration - IBM MQSeries for OS/390” on page 395
- “Chapter 33. Example configuration - IBM MQSeries for AS/400” on page 459
- “Chapter 35. Example configuration - MQSeries for VSE/ESA” on page 485

The information in the example-configuration chapters describes the tasks that were carried out on a single platform, to set up communication to another of the platforms, and then describes the MQSeries tasks to establish a working channel to that platform. Wherever possible, the intention is to make the information as generic as possible. Thus, to connect any two MQSeries queue managers on different platforms, you should need to refer to only the relevant two chapters. Any deviations or special cases are highlighted as such. Of course, you can also connect two queue managers running on the same platform (on different machines or on the same machine). In this case, all the information can be derived from the one chapter.

The examples only cover how to set up communications where clustering is not being used. For information about setting up communications while using clustering, see the *MQSeries Queue Manager Clusters* book. The communications' configuration values given here still apply.

Each chapter contains a worksheet in which you can find the parameters used in the example configurations. There is a short description of each parameter and some guidance on where to find the equivalent values in your system. When you have a set of values of your own, record these in the spaces on the worksheet. As you proceed through the chapter, you will find cross-references to these values as you need them.

## Using communication examples

### Notes:

1. Example queue manager names usually reflect the platform that the queue manager runs on, but MVS is used for both OS/390 and MVS/ESA, which are essentially the same.
2. The **sequence number wrap** value for sender definitions defaults to 999999999 for Version 2 MQSeries products.
3. For connections to MQSeries for OS/390 the examples, in general, cover only connection without using CICS. See “Chapter 27. Preparing MQSeries for OS/390 when using CICS” on page 381 for information about connecting using CICS.

## IT responsibilities

Because the IT infrastructure can vary greatly between organizations, it is difficult to indicate who, within an organization, controls and maintains the information required to complete each parameter value. To understand the terminology used in the following chapters, consider the following guidelines as a starting point.

- *System administrator* is used to describe the person (or group of people) who installs and configures the software for a specific platform.
- *Network administrator* is used to describe the person who controls LAN connectivity, LAN address assignments, network naming conventions, and so on. This person may be in a separate group or may be part of the system administration group.

In most OS/390 installations, there is a group responsible for updating the ACF/VTAM®, ACF/NCP, and TCP/IP software to support the network configuration. The people in this group should be the main source of information needed when connecting any MQSeries platform to MQSeries for OS/390. They may also influence or mandate network naming conventions on LANs and you should verify their span of control before creating your definitions.

- A specific type of administrator, for example *CICS administrator* is indicated in cases where we can more clearly describe the responsibilities of the person.

The example-configuration chapters do not attempt to indicate who is responsible for and able to set each parameter. In general, several different people may be involved.

---

## Part 3. DQM in MQSeries for OS/2 Warp, Windows NT, Digital OpenVMS, Tandem NSK, and UNIX systems

### Chapter 8. Monitoring and controlling channels

on distributed platforms . . . . .	105
The DQM channel control function . . . . .	105
Functions available . . . . .	106
Getting started with objects. . . . .	108
Creating objects . . . . .	108
Creating default objects . . . . .	108
How are default objects created? . . . . .	109
Changing the default objects . . . . .	109
Creating a channel . . . . .	109
Create channel example . . . . .	109
Displaying a channel . . . . .	110
Display channel examples . . . . .	110
Displaying channel status . . . . .	110
Display channel status examples . . . . .	110
Starting a channel . . . . .	110
Renaming a channel . . . . .	111
Channel attributes and channel types . . . . .	111
Channel functions . . . . .	112
Create . . . . .	113
Change . . . . .	113
Delete . . . . .	113
Display . . . . .	113
Display Status . . . . .	113
Ping . . . . .	113
Start . . . . .	114
Stop . . . . .	115
Reset . . . . .	116
Resolve . . . . .	116

### Chapter 9. Preparing MQSeries for distributed platforms

Transmission queues and triggering . . . . .	117
Creating a transmission queue. . . . .	117
Triggering channels . . . . .	117
Example definitions for triggering . . . . .	118
Examples for V5.1 of MQSeries for AIX, HP-UX, OS/2 Warp, Sun Solaris, and Windows NT . . . . .	118
Starting the channel initiator . . . . .	118
Stopping the channel initiator . . . . .	118
Channel programs. . . . .	119
Other things to consider. . . . .	119
Undelivered-message queue . . . . .	119
Queues in use . . . . .	120
Multiple message channels per transmission queue . . . . .	120
Security of MQSeries objects . . . . .	120
On UNIX systems, Digital OpenVMS, and Tandem NSK . . . . .	120
On Windows NT . . . . .	121
User IDs across systems. . . . .	121
User IDs on OS/2. . . . .	121
System extensions and user-exit programs. . . . .	121

Running channels and listeners as trusted applications . . . . .	121
What next? . . . . .	122

### Chapter 10. Setting up communication for OS/2 and Windows NT

Deciding on a connection . . . . .	123
Defining a TCP connection . . . . .	124
Sending end. . . . .	124
Receiving on TCP . . . . .	124
Using the TCP/IP listener . . . . .	124
Using the TCP listener backlog option . . . . .	125
Using the MQSeries listener . . . . .	125
Using the TCP/IP SO_KEEPALIVE option . . . . .	126
Defining an LU 6.2 connection . . . . .	126
Sending end for OS/2 . . . . .	127
Sending end for Windows NT. . . . .	127
Receiving on LU 6.2 . . . . .	127
Using the RUNMQLSR command . . . . .	127
Using Communications Manager/2 on OS/2 . . . . .	128
Using Microsoft SNA Server on Windows NT . . . . .	128
Defining a NetBIOS connection . . . . .	128
Defining the MQSeries local NetBIOS name . . . . .	129
Establishing the queue manager NetBIOS session, command, and name limits . . . . .	130
Establishing the LAN adapter number . . . . .	130
Initiating the connection. . . . .	130
Target listener . . . . .	131
Defining an SPX connection . . . . .	131
Sending end. . . . .	131
Using the SPX KEEPALIVE option (OS/2 only) . . . . .	132
Receiving on SPX . . . . .	132
Using the TCP listener backlog option . . . . .	132
Using the MQSeries listener . . . . .	133
IPX/SPX parameters . . . . .	133
OS/2 . . . . .	134
DOS and Windows 3.1 client . . . . .	134
Windows NT . . . . .	135
Windows 95 and Windows 98 . . . . .	135

### Chapter 11. Example configuration - IBM MQSeries for OS/2 Warp

Configuration parameters for an LU 6.2 connection . . . . .	137
Configuration worksheet . . . . .	137
Explanation of terms . . . . .	140
Establishing an LU 6.2 connection . . . . .	142
Defining local node characteristics . . . . .	142
Configuring a DLC . . . . .	144
Configuring the local node . . . . .	145
Adding a local LU. . . . .	147
Adding a transaction program definition . . . . .	147
Configuring a mode . . . . .	148
Connecting to a peer system . . . . .	150

## DQM in distributed platforms

Adding a peer connection . . . . .	150
Defining a partner LU . . . . .	151
Connecting to a host system . . . . .	153
Adding a host connection . . . . .	154
Defining a partner LU . . . . .	155
Verifying the configuration . . . . .	157
What next? . . . . .	158
Establishing a TCP connection. . . . .	158
What next? . . . . .	159
Establishing a NetBIOS connection . . . . .	160
Establishing an SPX connection . . . . .	160
IPX/SPX parameters . . . . .	160
IPX . . . . .	161
SPX . . . . .	161
SPX addressing. . . . .	161
Using the SPX KEEPALIVE option . . . . .	162
Receiving on SPX . . . . .	162
Using the MQSeries listener . . . . .	162
MQSeries for OS/2 Warp configuration. . . . .	162
Basic configuration . . . . .	163
Channel configuration . . . . .	163
MQSeries for OS/2 Warp sender-channel definitions using SNA . . . . .	166
MQSeries for OS/2 Warp receiver-channel definitions using SNA . . . . .	166
MQSeries for OS/2 Warp sender-channel definitions using TCP . . . . .	166
MQSeries for OS/2 Warp receiver-channel definitions using TCP/IP . . . . .	166
MQSeries for OS/2 Warp sender-channel definitions using NetBIOS . . . . .	167
MQSeries for OS/2 Warp receiver-channel definitions using NetBIOS . . . . .	167
MQSeries for OS/2 Warp sender-channel definitions using IPX/SPX . . . . .	167
MQSeries for OS/2 Warp receiver-channel definitions using IPX/SPX . . . . .	167
Running channels as processes or threads . . . . .	167

### Chapter 12. Example configuration - IBM

<b>MQSeries for Windows NT</b> . . . . .	169
Configuration parameters for an LU 6.2 connection . . . . .	169
Configuration worksheet . . . . .	170
Explanation of terms . . . . .	172
Establishing an LU 6.2 connection . . . . .	174
Configuring the local node . . . . .	174
Adding a connection . . . . .	176
Adding a partner . . . . .	178
Adding a CPI-C entry . . . . .	179
Configuring an invokable TP . . . . .	179
What next? . . . . .	181
Establishing a TCP connection. . . . .	181
What next? . . . . .	181
Establishing a NetBIOS connection . . . . .	181
Establishing an SPX connection . . . . .	182
IPX/SPX parameters . . . . .	182
SPX addressing. . . . .	183
Receiving on SPX . . . . .	183
Using the MQSeries listener . . . . .	183
MQSeries for Windows NT configuration . . . . .	184
Default configuration. . . . .	184

Basic configuration . . . . .	184
Channel configuration . . . . .	185
MQSeries for Windows NT sender-channel definitions using SNA . . . . .	187
MQSeries for Windows NT receiver-channel definitions using SNA . . . . .	187
MQSeries for Windows NT sender-channel definitions using TCP/IP . . . . .	188
MQSeries for Windows NT receiver-channel definitions using TCP . . . . .	188
MQSeries for Windows NT sender-channel definitions using NetBIOS . . . . .	188
MQSeries for Windows NT receiver-channel definitions using NetBIOS . . . . .	188
MQSeries for Windows NT sender-channel definitions using SPX. . . . .	188
MQSeries for Windows NT receiver-channel definitions using SPX. . . . .	189
Automatic startup . . . . .	189
Running channels as processes or threads . . . . .	189

### Chapter 13. Setting up communication in UNIX systems.

Deciding on a connection . . . . .	191
Defining a TCP connection . . . . .	191
Sending end. . . . .	191
Receiving on TCP . . . . .	192
Using the TCP/IP listener . . . . .	192
Using the TCP listener backlog option . . . . .	193
Using the MQSeries listener . . . . .	193
Using the TCP/IP SO_KEEPALIVE option . . . . .	194
Defining an LU 6.2 connection . . . . .	194
Sending end. . . . .	195
Receiving on LU 6.2 . . . . .	195

### Chapter 14. Example configuration - IBM

<b>MQSeries for AIX</b> . . . . .	197
Configuration parameters for an LU 6.2 connection . . . . .	197
Configuration worksheet . . . . .	197
Explanation of terms . . . . .	200
Establishing a session using Communications Server for AIX V5 . . . . .	202
Configuring your node . . . . .	202
Configuring connectivity to the network . . . . .	203
Defining a local LU . . . . .	205
Defining a transaction program . . . . .	206
Establishing a TCP connection. . . . .	209
What next? . . . . .	209
Establishing a UDP connection . . . . .	209
What next? . . . . .	209
MQSeries for AIX configuration . . . . .	209
Basic configuration . . . . .	210
Channel configuration . . . . .	210
MQSeries for AIX sender-channel definitions using SNA . . . . .	213
MQSeries for AIX receiver-channel definitions using SNA . . . . .	213
MQSeries for AIX TPN setup . . . . .	213
MQSeries for AIX sender-channel definitions using TCP . . . . .	213





## DQM in distributed platforms

### Chapter 19. Setting up communication in Digital

<b>OpenVMS systems</b> . . . . .	277
Deciding on a connection . . . . .	277
Defining a TCP connection . . . . .	278
Sending end. . . . .	278
Receiving channels using Compaq (DIGITAL)	
TCP/IP services (UCX) for OpenVMS . . . . .	278
Using the TCP/IP SO_KEEPALIVE option	279
Receiving channels using Cisco MultiNet for	
OpenVMS . . . . .	279
Receiving channels using Attachmate PathWay	
for OpenVMS . . . . .	280
Receiving channels using Process Software	
Corporation TCPware . . . . .	280
Defining an LU 6.2 connection . . . . .	281
SNA configuration. . . . .	281
Defining access names . . . . .	282
Specifying SNA configuration parameters to	
MQSeries. . . . .	283
Passing parameters to sender and requester	
channel pairs . . . . .	283
Running senders and requesters . . . . .	283
Passing parameters to servers and receivers	283
Running servers and receivers. . . . .	284
Ending the SNA Listener process. . . . .	284
Sample MQSeries configuration . . . . .	284
Problem solving . . . . .	285
Defining a DECnet Phase IV connection . . . . .	285
Sending end. . . . .	286
Receiving on DECnet Phase IV . . . . .	286
Defining a DECnet Phase V connection. . . . .	286
<b>Chapter 20. Setting up communication in</b>	
<b>Tandem NSK</b> . . . . .	289
Deciding on a connection . . . . .	289

SNA channels . . . . .	289
LU 6.2 responder processes. . . . .	291
TCP channels . . . . .	291
Communications examples . . . . .	292
SNAX communications example . . . . .	292
SCF SNA line configuration file . . . . .	292
SYSGEN parameters . . . . .	294
SNAX/APC process configuration . . . . .	295
Channel definitions . . . . .	299
ICE communications example . . . . .	299
Configuring the ICE process . . . . .	299
Defining the line and APC information. . . . .	300
Channel definitions for ICE. . . . .	303
TCP/IP communications example . . . . .	303
TCPConfig stanza in QMINI . . . . .	303
Defining a TCP sender channel . . . . .	303
Defining a TCP receiver channel . . . . .	304
Defining a TCP/IP sender channel on the	
remote system . . . . .	304

### Chapter 21. Message channel planning example

<b>for distributed platforms</b> . . . . .	305
What the example shows . . . . .	305
Queue manager QM1 example . . . . .	307
Queue manager QM2 example . . . . .	308
Running the example. . . . .	309
Expanding this example. . . . .	309

### Chapter 22. Example SINIX and DC/OSx

<b>configuration files</b> . . . . .	311
Configuration file on bight . . . . .	312
Configuration file on forties . . . . .	313
Working configuration files for Pyramid DC/OSx	313
Output of dbd command . . . . .	314

This part of the book describes the MQSeries distributed queue management function for MQSeries for OS/2 Warp, Windows NT, Digital OpenVMS, Tandem NSK, and UNIX systems. The information given may not all apply to MQSeries for Windows. You should refer to the *MQSeries for Windows User's Guide* for information about that product. For information about the MQSeries distributed queue management function for MQSeries for OS/390, see "Part 4. DQM in MQSeries for OS/390" on page 319. For information about the MQSeries distributed queue management function for MQSeries for AS/400, see "Part 5. DQM in MQSeries for AS/400" on page 421.

---

## Chapter 8. Monitoring and controlling channels on distributed platforms

For DQM you need to create, monitor, and control the channels to remote queue managers. You can use the following types of command to do this:

### The MQSeries commands (MQSC)

You can use the MQSC as single commands in an MQSC session in OS/2, Windows NT, Digital OpenVMS, Tandem NSK, and UNIX systems. To issue more complicated, or multiple, commands the MQSC can be built into a file that you then run from the command line. For full details see the *MQSeries Command Reference* book. This chapter gives some simple examples of using MQSC for distributed queuing.

### Control commands

You can also issue *control commands* at the command line for some of these functions. Reference material for these commands is contained in the *MQSeries System Administration* book for V5.1 of MQSeries for AIX, HP-UX, OS/2 Warp, Sun Solaris, and Windows NT, or in the *MQSeries System Management Guide* for your platform.

### Programmable command format commands

See the *MQSeries Programmable System Management* book for information about using these commands.

### Message Queue Management facility

On Tandem NSK, you can use the Message Management facility. See the *MQSeries for Tandem NonStop Kernel System Management Guide* for information about this facility.

### IBM MQSeries Explorer

On Windows NT, you can use an MMC snap-in called the MQSeries Explorer. This provides a graphical administration interface to perform administrative tasks as an alternative to using control commands or MQSC commands.

Each queue manager has a DQM component for controlling interconnections to compatible remote queue managers.

For a list of the functions available to you when setting up and controlling message channels, using the two types of commands, see Table 7 on page 106.

---

## The DQM channel control function

The channel control function provides the interface and function for administration and control of message channels between systems.

It consists of commands, programs, a file for the channel definitions, and a storage area for synchronization information. The following is a brief description of the components.

- The channel commands are a subset of the MQSeries Commands (MQSC).
- You use MQSC and the control commands to:
  - Create, copy, display, change, and delete channel definitions

## Channel control function

- Start and stop channels, ping, reset channel sequence numbers, and resolve in-doubt messages when links cannot be re-established
- Display status information about channels
- The channel definition file (CDF), amqrfcda.dat:
  - Is indexed on channel name
  - Holds channel definitions
- A storage area holds sequence numbers and *logical unit of work (LUW)* identifiers. These are used for channel synchronization purposes.

## Functions available

Table 7 shows the full list of MQSeries functions that you may need when setting up and controlling channels. The channel functions are explained in this chapter.

For more details of the control commands that you issue at the command line, see the *MQSeries System Administration* book for V5.1 of MQSeries for AIX, HP-UX, OS/2 Warp, Sun Solaris, and Windows NT, or the *MQSeries System Management Guide* for your platform.

The MQSC commands are fully described in the *MQSeries Command Reference* book.

Table 7. Functions available in OS/2, Windows NT, Digital OpenVMS, Tandem NSK, and UNIX systems

Function	Control commands	MQSC	MQSeries Explorer equivalent?	MQSeries Service snap-in equivalent?
Queue manager functions				
Change queue manager		ALTER QMGR	Yes	No
Create queue manager	crtmqm		Yes	Yes
Delete queue manager	dltmqm		Yes	Yes
Display queue manager		DISPLAY QMGR	Yes	No
End queue manager	endmqm		Yes	Yes
Ping queue manager		PING QMGR	No	No
Start queue manager	strmqm		Yes	Yes
Add a queue manager to Windows NT Service Control Manager			No	Yes
Command server functions				
Display command server	dspmqcsv		No	Yes
End command server	endmqcsv		No	Yes
Start command server	strmqcsv		No	Yes
Queue functions				
Change queue		ALTER QALIAS ALTER QLOCAL ALTER QMODEL ALTER QREMOTE	Yes	No
Clear queue		CLEAR QLOCAL CLEAR QUEUE	Yes	No



## Functions available

Table 7. Functions available in OS/2, Windows NT, Digital OpenVMS, Tandem NSK, and UNIX systems (continued)

Function	Control commands	MQSC	MQSeries Explorer equivalent?	MQSeries Service snap-in equivalent?
Create queue		DEFINE QALIAS DEFINE QLOCAL DEFINE QMODEL DEFINE QREMOTE	Yes	No
Delete queue		DELETE QALIAS DELETE QLOCAL DELETE QMODEL DELETE QREMOTE	Yes	No
Display queue		DISPLAY QUEUE	Yes	No
Process functions				
Change process		ALTER PROCESS	Yes	No
Create process		DEFINE PROCESS	Yes	No
Delete process		DELETE PROCESS	Yes	No
Display process		DISPLAY PROCESS	Yes	No
Channel functions				
Change channel		ALTER CHANNEL	Yes	No
Create channel		DEFINE CHANNEL	Yes	No
Delete channel		DELETE CHANNEL	Yes	No
Display channel		DISPLAY CHANNEL	Yes	No
Display channel status		DISPLAY CHSTATUS	Yes	No
End channel		STOP CHANNEL	Yes	Yes
Ping channel		PING CHANNEL	Yes	No
Reset channel		RESET CHANNEL	Yes	No
Resolve channel		RESOLVE CHANNEL	Yes	No
Run channel	runmqchl	START CHANNEL	Yes	Yes
Run channel initiator	runmqchi	START CHINIT (not Tandem NSK)	No	Yes

## Functions available

Table 7. Functions available in OS/2, Windows NT, Digital OpenVMS, Tandem NSK, and UNIX systems (continued)

Function	Control commands	MQSC	MQSeries Explorer equivalent?	MQSeries Service snap-in equivalent?
Run listener	runmqslr (not AT&T GIS UNIX and Digital UNIX)	START LISTENER (not Tandem NSK)	No	Yes
End listener	endmqslr (OS/2, Windows NT, AIX, HP-UX, Sun Solaris, and SINIX and DC/OSx only)		No	Yes

---

## Getting started with objects

Use the MQSeries commands (MQSC) or the MQSeries Explorer on Windows NT to:

1. Define message channels and associated objects
2. Monitor and control message channels

The objects you may need to define are:

- Transmission queues
- Remote queue definitions
- Queue manager alias definitions
- Reply-to queue alias definitions
- Reply-to local queues
- Processes for triggering (MCAs)
- Message channel definitions

Channels must be completely defined, and their associated objects must exist and be available for use, before a channel can be started. This chapter shows you how to do this.

In addition, the particular communication link for each channel must be defined and available before a channel can be run. For a description of how LU 6.2, TCP/IP, NetBIOS, SPX, and DECnet links are defined, see the particular communication guide for your installation. See also the example configuration chapters in this book.

## Creating objects

Use MQSC to create the queue and alias objects: transmission queues, remote queue definitions, queue manager alias definitions, reply-to queue alias definitions, and reply-to local queues.

Also create the definitions of processes for triggering (MCAs) in a similar way.

For an example showing how to create all the required objects see “Chapter 21. Message channel planning example for distributed platforms” on page 305.

## Creating default objects

In V5.1 of MQSeries for AIX, HP-UX, OS/2 Warp, Sun Solaris, and Windows NT, default objects are created automatically when a queue manager is created. These objects are queues, channels, a process definition, and administration queues. They

correspond to the objects that are created when you run the amqscoma.tst sample command file on earlier releases of these products and on other MQSeries products.

### How are default objects created?

When you use the CRTMQM command to create a queue manager, the command also initiates a program to create a set of default objects.

1. Each default object is created in turn. The program keeps a count of how many objects are successfully defined, how many already existed and were replaced, and how many unsuccessful attempts there were.
2. The program displays the results to you and if any errors occurred, directs you to the appropriate error log for details.

When the program has finished running, you can use the STRMQM command to start the queue manager.

See the *MQSeries System Administration* book for information about the CRTMQM and STRMQM commands and a list of default objects.

### Changing the default objects

Once the default objects have been created, you can replace them at any time by running the STRMQM command with the -c option. When you specify the -c option, the queue manager is started temporarily while the objects are created and is then shut down again. You must use the STRMQM command again, without the -c option, if you want to start the queue manager.

If you wish to make any changes to the default objects, you can create your own version of the old amqscoma.tst file and edit it.

## Creating a channel

To create a new channel you have to create **two** channel definitions, one at each end of the connection. You create the first channel definition at the first queue manager. Then you create the second channel definition at the second queue manager, on the other end of the link.

Both ends must be defined using the **same** channel name. The two ends must have **compatible** channel types, for example: Sender and Receiver.

To create a channel definition for one end of the link use the MQSC command DEFINE CHANNEL. Include the name of the channel, the channel type for this end of the connection, a connection name, a description (if required), the name of the transmission queue (if required), and the transmission protocol. Also include any other attributes that you want to be different from the system default values for the required channel type, using the information you have gathered previously.

You are provided with help in deciding on the values of the channel attributes in “Chapter 6. Channel attributes” on page 77.

**Note:** You are very strongly recommended to name all the channels in your network uniquely. Including the source and target queue manager names in the channel name is a good way to do this.

### Create channel example

```
DEFINE CHANNEL(QM1.TO.QM2) CHLTYPE(SDR) +
DESCR('Sender channel to QM2') +
CONNAME(QM2) TRPTYPE(TCP) XMITQ(QM2) CONVERT(YES)
```

## Getting started

In all the examples of MQSC the command is shown as it would appear in a file of commands, and as it would be typed in OS/2, Windows NT, UNIX systems, Digital OpenVMS, or Tandem NSK. The two methods look identical, except that to issue a command interactively, you must first start an MQSC session. Type `runmqsc`, for the default queue manager, or `runmqsc qmname` where *QMNAME* is the name of the required queue manager. Then type any number of commands, as shown in the examples.

For portability, you should restrict the line length of your commands to 72 characters. Use a concatenation character as shown to continue over more than one line. On Tandem NSK use Ctrl-y to end the input at the command line, or enter `exit` or `quit`. On OS/2, Windows NT, or Digital OpenVMS use Ctrl-z. On UNIX systems, use Ctrl-d. Alternatively, on V5.1 of MQSeries for AIX, HP-UX, OS/2 Warp, Sun Solaris, and Windows NT, use the **end** command.

## Displaying a channel

Use the MQSC command `DISPLAY CHANNEL`, specifying the channel name, the channel type (optional), and the attributes you want to see, or specifying that all attributes are to be displayed. In V5.1 of MQSeries for AIX, HP-UX, OS/2 Warp, Sun Solaris, and Windows NT the `ALL` parameter of the `DISPLAY CHANNEL` command is assumed by default if no specific attributes are requested and the channel name specified is not generic.

The attributes are described in “Chapter 6. Channel attributes” on page 77.

### Display channel examples

```
DISPLAY CHANNEL(QM1.TO.QM2) TRPTYPE,CONVERT
```

```
DISPLAY CHANNEL(QM1.TO.*) TRPTYPE,CONVERT
```

```
DISPLAY CHANNEL(*) TRPTYPE,CONVERT
```

```
DISPLAY CHANNEL(QM1.TO.QMR34) ALL
```

## Displaying channel status

Use the MQSC command `DISPLAY CHSTATUS`, specifying the channel name and whether you want the current status of channels or the status of saved information.

### Display channel status examples

```
DISPLAY CHSTATUS(*) CURRENT
```

```
DISPLAY CHSTATUS(QM1.TO.*) SAVED
```

Note that the saved status does not apply until at least one batch of messages has been transmitted on the channel. In V5.1 of MQSeries for AIX, HP-UX, OS/2 Warp, Sun Solaris, and Windows NT status is also saved when a channel is stopped (using the `STOP CHL` command) and when the queue manager is ended.

## Starting a channel

For applications to be able to exchange messages you must start a listener program for inbound connections (or, in the case of UNIX systems, create a listener attachment). In OS/2, Windows NT, and Tandem NSK, use the `runmqslsr` command to start the MQSeries listener process. Any inbound requests for channel

attachment start MCAs as threads of this listener process. In Digital OpenVMS, each receiver or server channel requires a listener process that then starts a channel process.

```
runmq1sr -t tcp -m QM2
```

For outbound connections you must start the channel in one of the following three ways:

1. Use the MQSC command `START CHANNEL`, specifying the channel name, to start the channel as a process or a thread, depending on the `MCATYPE` parameter. (If channels are started as threads, they are threads of a channel initiator, which must have been started previously using the `runmqchi` command.)

```
START CHANNEL(QM1.TO.QM2)
```

2. Use the control command `runmqchl` to start the channel as a process.

```
runmqchl -c QM1.TO.QM2 -m QM1
```

3. Use the channel initiator to trigger the channel.

## Renaming a channel

To rename a message channel, use MQSC to carry out the following steps:

1. Use `STOP CHANNEL` to stop the channel.
2. Use `DEFINE CHANNEL` to create a duplicate channel definition with the new name.
3. Use `DISPLAY CHANNEL` to check that it has been created correctly.
4. Use `DELETE CHANNEL` to delete the original channel definition.

If you decide to rename a message channel, remember that a channel has *two* channel definitions, one at each end. Make sure you rename the channel at both ends at the same time.

---

## Channel attributes and channel types

The channel attributes for each type of channel are shown in Table 8. The channel attributes are described in detail in “Chapter 6. Channel attributes” on page 77. Client-connection channels and server-connection channels are described in the *MQSeries Clients* book.

Table 8. Channel attributes for the channel types in OS/2, Windows NT, Digital OpenVMS, Tandem NSK, and UNIX systems

Attribute field	SDR	SVR	RCVR	RQSTR	CLNT-CONN	SVR-CONN	CLUS-SDR	CLUS-RCVR
Batch interval	✓	✓					✓	✓
Batch size	✓	✓	✓	✓			✓	✓
Channel name	✓	✓	✓	✓	✓	✓	✓	✓
Cluster							✓	✓
Cluster namelist							✓	✓
Channel type	✓	✓	✓	✓	✓	✓	✓	✓
Connection name	✓	✓		✓	✓		✓	✓
Convert message	✓	✓					✓	✓
Description	✓	✓	✓	✓	✓	✓	✓	✓
Disconnect interval	✓	✓					✓	✓
Heartbeat interval	✓	✓	✓	✓	✓	✓	✓	✓

## Channel attributes and types

Table 8. Channel attributes for the channel types in OS/2, Windows NT, Digital OpenVMS, Tandem NSK, and UNIX systems (continued)

Attribute field	SDR	SVR	RCVR	RQSTR	CLNT-CONN	SVR-CONN	CLUS-SDR	CLUS-RCVR
Long retry count	✓	✓					✓	✓
Long retry interval	✓	✓					✓	✓
LU 6.2 Transaction program name	✓	✓		✓	✓		✓	✓
Maximum message length	✓	✓	✓	✓			✓	✓
Message channel agent type	✓	✓		✓	✓		✓	✓
Message channel agent user	✓	✓	✓	✓	✓	✓	✓	✓
Message exit name	✓	✓	✓	✓			✓	✓
Message exit user data	✓	✓	✓	✓			✓	✓
Message-retry exit name			✓	✓			✓	✓
Message-retry exit user data			✓	✓			✓	✓
Message retry count			✓	✓			✓	✓
Message retry interval			✓	✓			✓	✓
Mode name	✓	✓		✓	✓		✓	✓
Network-connection priority							✓	✓
Nonpersistent message speed	✓	✓	✓	✓			✓	✓
Password	✓	✓		✓	✓		✓	
PUT authority			✓	✓				✓
Queue manager name					✓			
Receive exit	✓	✓	✓	✓	✓	✓	✓	✓
Receive exit user data	✓	✓	✓	✓	✓	✓	✓	✓
Security exit	✓	✓	✓	✓	✓	✓	✓	✓
Security exit user data	✓	✓	✓	✓	✓	✓	✓	✓
Send exit	✓	✓	✓	✓	✓	✓		✓
Send exit user data	✓	✓	✓	✓	✓	✓	✓	✓
Sequence number wrap	✓	✓	✓	✓			✓	✓
Short retry interval	✓	✓					✓	✓
Short retry count	✓	✓					✓	✓
Transport type	✓	✓		✓	✓		✓	✓
Transmission queue	✓	✓						
User ID	✓	✓		✓	✓		✓	

## Channel functions

The channel functions available are shown in Table 7 on page 106. Here some more detail is given about the channel functions.

### Create

You can create a new channel definition using the default values supplied by MQSeries, specifying the name of the channel, the type of channel you are creating, the communication method to be used, the transmission queue name and the connection name.

The channel name must be the same at both ends of the channel, and unique within the network. However, you should restrict the characters used to those that are valid for MQSeries object names.

### Change

Use the MQSC command ALTER CHANNEL to change an existing channel definition, except for the channel name, or channel type.

### Delete

Use the MQSC command DELETE CHANNEL to delete a named channel.

### Display

Use the MQSC command DISPLAY CHANNEL to display the current definition for the channel.

### Display Status

The MQSC command DISPLAY CHSTATUS displays the status of a channel whether the channel is active or inactive. It applies to all message channels. It does not apply to MQI channels other than server-connection channels on V5.1 of MQSeries for AIX, HP-UX, OS/2 Warp, Sun Solaris, and Windows NT. See “Displaying channel status” on page 110.

Information displayed includes:

- Channel name
- Communication connection name
- In-doubt status of channel (where appropriate)
- Last sequence number
- Transmission queue name (where appropriate)
- The in-doubt identifier (where appropriate)
- The last committed sequence number
- Logical unit of work identifier
- Process ID
- Thread ID (OS/2 and Windows NT only)

### Ping

Use the MQSC command PING CHANNEL to exchange a fixed data message with the remote end. This gives some confidence to the system supervisor that the link is available and functioning.

Ping does not involve the use of transmission queues and target queues. It uses channel definitions, the related communication link, and the network setup. It can only be used if the channel is not currently active.

It is available from sender and server channels only. The corresponding channel is started at the far side of the link, and performs the startup parameter negotiation. Errors are notified normally.

The result of the message exchange is presented as Ping complete or an error message.

## Channel functions

**Ping with LU 6.2:** When Ping is invoked, by default no USERID or password flows to the receiving end. If USERID and password are required, they can be created at the initiating end in the channel definition. If a password is entered into the channel definition, it is encrypted by MQSeries before being saved. It is then decrypted before flowing across the conversation.

### Start

Use the MQSC command `START CHANNEL` for sender, server, and requester channels. It should not be necessary where a channel has been set up with queue manager triggering.

Also use the `START CHANNEL` command for receiver channels that have a disabled status, and on V5.1 of MQSeries for AIX, HP-UX, OS/2 Warp, Sun Solaris, and Windows NT, for server-connection channels that have a disabled status. Starting a receiver or server-connection channel that is in disabled status resets the channel and allows it to be started from the remote channel.

When started, the sending MCA reads the channel definition file and opens the transmission queue. A channel start-up sequence is executed, which remotely starts the corresponding MCA of the receiver or server channel. When they have been started, the sender and server processes await messages arriving on the transmission queue and transmit them as they arrive.

When you use triggering or run channels as threads, you will need to start the channel initiator to monitor the initiation queue. Use the **`runmqchi`** command for this.

However, TCP and LU 6.2 do provide other capabilities:

- For TCP on OS/2, Digital OpenVMS, and UNIX systems, `inetd` (or an equivalent TCP/IP service on OpenVMS) can be configured to start a channel. This will be started as a separate process.
- For LU 6.2 in OS/2, using Communications Manager/2 it is possible to configure the Attach Manager to start a channel. This will be started as a separate process.
- For LU 6.2 in UNIX systems, configure your SNA product to start the LU 6.2 responder process.
- For LU 6.2 in Windows NT, using SNA Server you can use `TpStart` (a utility provided with SNA Server) to start a channel. This will be started as a separate process.
- For LU 6.2 in Digital OpenVMS systems, use the **`runmqslr`** command to start the LU 6.2 responder process.
- For LU 6.2 in Tandem NSK, the **`strmqm`** command normally starts the LU 6.2 responder process if your channel is defined `AUTOSTART (ENABLED)`. To start the process manually, use the **`runmqsc`** or **`runmqchl`** command.

Use of the `Start` option always causes the channel to re-synchronize, where necessary.

For the start to succeed:

- Channel definitions, local and remote, must exist. If there is no appropriate channel definition for a receiver or server-connection channel, a default one is created automatically if the channel is auto-defined. See “Channel auto-definition exit program” on page 516.
- Transmission queue must exist, and have no other channels using it.



- MCAs, local and remote, must exist.
- Communication link must be available.
- Queue managers must be running, local and remote.
- Message channel must not be already running.

A message is returned to the screen confirming that the request to start a channel has been accepted. For confirmation that the start command has succeeded, check the error log, or use DISPLAY CHSTATUS. The error logs are:

### OS/2 and Windows NT

\mqm\qmgrs\qmname\errors\AMQERR01.LOG (for each queue manager called qmname)

\mqm\qmgrs\@SYSTEM\errors\AMQERR01.LOG (for general errors)

**Note:** On Windows NT, you still also get a message in the Windows NT application event log.

### Digital OpenVMS

MQS\_ROOT:[MQM.QMGRS.QMNAME.ERRORS]AMQERR01.LOG (for each queue manager called qmname)

MQS\_ROOT:[MQM.QMGRS.\$SYSTEM.ERRORS]AMQERR01.LOG (for general errors)

### Tandem NSK

The location of the error logs depends on whether the queue manager name is known and whether the error is associated with a client.

- If the queue manager name is known and the queue manager is available:

<QMVOL>.<SUBVOL>.L.MQERRLG1

- If the queue manager is not available:

<MQSVOL>.ZMQSSYS.MQERRLG1

### UNIX systems

/var/mqm/qmgrs/qmname/errors/AMQERR01.LOG (for each queue manager called qmname)

/var/mqm/qmgrs/@SYSTEM/errors/AMQERR01.LOG (for general errors)

## Stop

Use the MQSC command STOP CHANNEL to request the channel to stop activity. Any channel type is disabled by this command. The channel will not start a new batch of messages until the operator starts the channel again. (For information about restarting stopped channels, see “Restarting stopped channels” on page 69.)

You can select the type of stop you require:

### Stop quiesce example:

```
STOP CHANNEL(QM1.TO.QM2) MODE(QUIESCE)
```

This command requests the channel to close down in an orderly way. The current batch of messages is completed and the syncpoint procedure is carried out with the other end of the channel.

**Note:** If the channel is idle this command will not terminate a receiving channel.

### Stop force example:

```
STOP CHANNEL(QM1.TO.QM2) MODE(FORCE)
```

## Channel functions

Normally, this option should not be used. It terminates the channel process or thread. The channel does not complete processing the current batch of messages, and can, therefore, leave the channel in doubt. In general, it is recommended that operators use the quiesce stop option.

### Reset

Use the MQSC command `RESET CHANNEL` to change the message sequence number. This command is available for any message channel, but not for MQI channels (client-connection or server-connection). The first message starts the new sequence the next time the channel is started.

If the command is issued on a sender or server channel, it informs the other side of the change when the channel is restarted.

### Resolve

Use the MQSC command `RESOLVE CHANNEL` when messages are held in-doubt by a sender or server, for example because one end of the link has terminated, and there is no prospect of it recovering. The `RESOLVE CHANNEL` command accepts one of two parameters: `BACKOUT` or `COMMIT`. Backout restores messages to the transmission queue, while Commit discards them.

The channel program does not try to establish a session with a partner. Instead, it determines the logical unit of work identifier (LUWID) which represents the in-doubt messages. It then issues, as requested, either:

- `BACKOUT` to restore the messages to the transmission queue; or
- `COMMIT` to delete the messages from the transmission queue.

For the resolution to succeed:

- The channel must be inactive
- The channel must be in doubt
- The channel type must be sender or server
- A local channel definition must exist
- The local queue manager must be running

---

## Chapter 9. Preparing MQSeries for distributed platforms

This chapter describes the MQSeries preparations required before DQM can be used in OS/2, Windows NT, Digital OpenVMS, Tandem NSK, and UNIX systems. It includes “Transmission queues and triggering” and “Channel programs” on page 119.

---

### Transmission queues and triggering

Before a channel (other than a requester channel) can be started, the transmission queue must be defined as described in this chapter, and must be included in the message channel definition.

In addition, where needed, the triggering arrangement must be prepared with the definition of the necessary processes and queues.

#### Creating a transmission queue

Define a local queue with the USAGE attribute set to XMITQ for each sending message channel. If you want to make use of a specific transmission queue in your remote queue definitions, create a remote queue as shown below.

To create a transmission queue, use the MQSeries Commands (MQSC), as shown in the following examples:

##### Create transmission queue example

```
DEFINE QLOCAL(QM2) DESCR('Transmission queue to QM2') USAGE(XMITQ)
```

##### Create remote queue example

```
DEFINE QREMOTE(PAYROLL) DESCR('Remote queue for QM2') +  
XMITQ(QM2) RNAME(PAYROLL) RQMNAME(QM2)
```

The recommended name for the transmission queue is the queue manager name on the remote system, as shown in the examples above.

#### Triggering channels

An overview of triggering is given in “Triggering channels” on page 20, while it is described in depth in the *MQSeries Application Programming Guide*. This description provides you with information specific to MQSeries for OS/2 Warp, Windows NT, Digital OpenVMS, Tandem NSK, and UNIX systems.

You can create a process definition in MQSeries, defining processes to be triggered. Use the MQSC command DEFINE PROCESS to create a process definition naming the process to be triggered when messages arrive on a transmission queue. The USERDATA attribute of the process definition should contain the name of the channel being served by the transmission queue.

Alternatively, for V5.1 of MQSeries for AIX, HP-UX, OS/2 Warp, Sun Solaris, and Windows NT, you can eliminate the need for a process definition by specifying the channel name in the TRIGGERDATA attribute of the transmission queue.

If you do not specify a channel name, the channel initiator searches the channel definition files until it finds a channel that is associated with the named transmission queue.

## Transmission queues and triggering

### Example definitions for triggering

Define the local queue (Q3), specifying that trigger messages are to be written to the default initiation queue SYSTEM.CHANNEL.INITQ, to trigger the application (process P1) that starts channel (QM3.TO.QM4):

```
DEFINE QLOCAL(QM4) TRIGGER INITQ(SYSTEM.CHANNEL.INITQ) PROCESS(P1) USAGE (XMITQ)
```

Define the application (process P1) to be started:

```
DEFINE PROCESS(P1) USERDATA(QM3.TO.QM4)
```

### Examples for V5.1 of MQSeries for AIX, HP-UX, OS/2 Warp, Sun Solaris, and Windows NT

Define the local queue (Q3), specifying that trigger messages are to be written to the initiation queue (IQ) to trigger the application that starts channel (QM3.TO.QM4):

```
DEFINE QLOCAL(QM4) TRIGGER INITQ(SYSTEM.CHANNEL.INITQ) USAGE (XMITQ)
```

### Starting the channel initiator

Triggering is implemented using the channel initiator process. On MQSeries for AT&T, Digital OpenVMS, SINIX and DC/OSx, and Tandem NSK, this process is started with the run channel initiator command, **runmqchi**, or (on distributed platforms except Tandem NSK) with the MQSC command START CHINIT. For example, to use the **runmqchi** command to start the default initiation queue for the default queue manager, enter:

```
runmqchi
```

Whichever command you use, specify the name of the initiation queue on the command, unless you are using the default initiation queue. For example, to use the **runmqchi** command to start queue IQ for the default queue manager, enter:

```
runmqchi -q IQ
```

To use the START CHINIT command (not on Tandem NSK), enter:

```
START CHINIT INITQ(IQ)
```

**Note:** Tandem NSK also allows control of the channel initiator from the PATHWAY environment. This is the recommended method. For more information about this, see the *MQSeries for Tandem NonStop Kernel System Management Guide*.

In V5.1 of MQSeries for AIX, HP-UX, OS/2 Warp, Sun Solaris, and Windows NT, a channel initiator is started automatically and the number of channel initiators that you can start is limited. The default limit is 3. You can change this using MAXINITIATORS in the qm.ini file for AIX, HP-UX, OS/2 Warp, and Sun Solaris, and in the registry for Windows NT.

See the *MQSeries System Administration* book for V5.1 of MQSeries for AIX, HP-UX, OS/2 Warp, Sun Solaris, and Windows NT, or the *MQSeries System Management Guide* for your platform, for details of the run channel initiator command, and the other control commands.

### Stopping the channel initiator

The default channel initiator is started automatically when you start a queue manager. Similarly, it is stopped automatically when a queue manager is stopped.

However, if you need to stop a channel initiator but **not** the queue manager, you should inhibit the queue that the initiator queue is reading from. To do this, you disable the GET attribute of the initiation queue. To restart the channel initiator, simply use the runmqchi command.

The consequences of stopping a channel initiator are:

- If you stop the only channel initiator running, no channels that you have attempted to start will be retried.
- If you have more than one channel initiator running, channels that have a transmission queue configured with this initiation queue are not automatically started. However, those channels configured for connection retries will continue to be retried.

---

## Channel programs

There are different types of channel programs (MCAs) available for use at the channels. The names are shown in the following tables.

*Table 9. Channel programs for OS/2 and Windows NT*

Program name	Direction of connection	Communication
RUNMQLSR	Inbound	Any
ENDMQLSR		Any
AMQCRS6A	Inbound	LU 6.2
AMQCRSTA	Inbound	TCP
RUNMQCHL	Outbound	Any
RUNMQCHI	Outbound	Any

*Table 10. Channel programs for UNIX systems, Digital OpenVMS, and Tandem NSK*

Program name	Direction of connection	Communication
amqcrs6a (MQLU6RES on Tandem NSK only)	Inbound	LU 6.2
amqcrsta (MQTCPRES (on Tandem NSK only)	Inbound	TCP and DECnet for Digital OpenVMS
runmqchl	Outbound	TCP for UNIX systems
runmqslr	Inbound	LU 6.2 for Digital OpenVMS and Tandem NSK and TCP for UNIX systems
runmqchi	Outbound	Any

RUNMQLSR (Run MQSeries listener), ENDMQLSR (End MQSeries listener), and RUNMQCHL (Run MQSeries channel) are control commands that you can enter at the command line. AMQCRS6A and AMQCRSTA are programs that, if you are using SNA, you define as transaction programs, or, if you are using TCP, you define in the INETD.LST file for OS/2 or Windows NT or the inetd.conf file for UNIX systems. Examples of the use of these channel programs are given in the following chapters.

---

## Other things to consider

Here are some other topics that you should consider when preparing MQSeries for distributed queue management.

### Undelivered-message queue

A DLQ handler is provided with MQSeries for OS/2 Warp and Windows NT, and with MQSeries on UNIX systems, Digital OpenVMS, and Tandem NSK. See the

## Other things to consider

*MQSeries System Administration* book for V5.1 of MQSeries for AIX, HP-UX, OS/2 Warp, Sun Solaris, and Windows NT, or the *MQSeries System Management Guide* for your platform, for information about this.

## Queues in use

MCAs for receiver channels may keep the destination queues open even when messages are not being transmitted; this results in the queues appearing to be “in use”.

## Multiple message channels per transmission queue

It is possible to define more than one channel per transmission queue, but only one of these channels can be active at any one time. This is recommended for the provision of alternative routes between queue managers for traffic balancing and link failure corrective action.

## Security of MQSeries objects

This section deals with remote messaging aspects of security.

You need to provide users with authority to make use of the MQSeries facilities, and this is organized according to actions to be taken with respect to objects and definitions. For example:

- Queue managers can be started and stopped by authorized users
- Applications need to connect to the queue manager, and have authority to make use of queues
- Message channels need to be created and controlled by authorized users
- Objects are kept in libraries, and access to these libraries may be restricted

The message channel agent at a remote site needs to check that the message being delivered originated from a user with authority to do so at this remote site. In addition, as MCAs can be started remotely, it may be necessary to verify that the remote processes trying to start your MCAs are authorized to do so. There are three possible ways for you to deal with this:

1. Specify `PUTAUT=CTX` in the channel definition to indicate that messages must contain acceptable *context* authority, otherwise they will be discarded.
2. Implement *user exit* security checking to ensure that the corresponding message channel is authorized. The security of the installation hosting the corresponding channel ensures that all users are properly authorized, so that you do not need to check individual messages.
3. Implement *user exit* message processing to ensure that individual messages are vetted for authorization.

### **On UNIX systems, Digital OpenVMS, and Tandem NSK**

Administration users must be part of the `mqm` group on your system (including root) if this ID is going to use MQSeries administration commands. In Digital OpenVMS, the user must hold the `mqm` identifier.

You should always run `amqcrsta` as the “mqm” user ID.

**User IDs on UNIX systems, Digital OpenVMS:** In Digital OpenVMS, all user IDs are displayed in uppercase. The queue manager converts all uppercase or mixed case user identifiers into lowercase, before inserting them into the context part of a message, or checking their authorization. All authorizations should therefore be based only on lowercase identifiers.

### On Windows NT

Administration users must be part of both the mqm group and the administrators group on your Windows NT system if this ID is going to use MQSeries administration commands.

**User IDs on Windows NT systems:** On Windows NT, *if there is no message exit installed*, the queue manager converts any uppercase or mixed case user identifiers into lowercase, before inserting them into the context part of a message, or checking their authorization. All authorizations should therefore be based only on lowercase identifiers.

### User IDs across systems

Platforms other than Windows NT and UNIX systems use uppercase characters for user IDs. To allow Windows NT and UNIX systems to use lowercase user IDs, the following conversions are carried out by the message channel agent (MCA) on these platforms:

#### At the sending end

The alpha characters in all user IDs are converted to uppercase, *if there is no message exit installed*.

#### At the receiving end

The alpha characters in all user IDs are converted to lowercase, *if there is no message exit installed*.

Note that the automatic conversions are **not** carried out if you provide a message exit on UNIX systems and Windows NT for any other reason.

### User IDs on OS/2

The user identifier service enables queue managers running under OS/2 to obtain a user-defined user ID. This is described in the *MQSeries Programmable System Management* book.

## System extensions and user-exit programs

A facility is provided in the channel definition to allow extra programs to be run at defined times during the processing of messages. These programs are not supplied with MQSeries, but may be provided by each installation according to local requirements.

In order to run, these user-exit programs must have predefined names and be available on call to the channel programs. The names of the user-exit programs are included in the message channel definitions.

There is a defined control block interface for handing over control to these programs, and for handling the return of control from these programs.

The precise places where these programs are called, and details of control blocks and names, are to be found in “Part 7. Further intercommunication considerations” on page 503.

## Running channels and listeners as trusted applications

If performance is an important consideration in your environment and your environment is stable, you can choose to run your channels and listeners as trusted, that is, using the fastpath binding. There are two factors that influence whether or not channels and listeners run as trusted.



## Other things to consider

- The environment variable MQ\_CONNECT\_TYPE=FASTPATH or MQ\_CONNECT\_TYPE=STANDARD. This is case sensitive. If you specify a value that is not valid it is ignored.
- MQIBindType in the Channels stanza of the qm.ini or registry file. You can set this to FASTPATH or STANDARD and it is not case sensitive. The default is STANDARD.

You can use MQIBindType in association with the environment variable to achieve the desired affect as follows:

MQIBindType	Environment variable	Result
STANDARD	UNDEFINED	STANDARD
FASTPATH	UNDEFINED	FASTPATH
STANDARD	STANDARD	STANDARD
FASTPATH	STANDARD	STANDARD
STANDARD	FASTPATH	STANDARD
FASTPATH	FASTPATH	FASTPATH

In summary, there are only two ways of actually making channels and listeners run as trusted:

1. By specifying MQIBindType=FASTPATH in qm.ini or registry and not specifying the environment variable.
2. By specifying MQIBindType=FASTPATH in qm.ini or registry and setting the environment variable to FASTPATH.

You are recommended to run channels and listeners as trusted only in a stable environment in which you are not, for example, testing applications or user exits that may abend or need to be cancelled. An errant application could compromise the integrity of your queue manager. However, if your environment is stable and if performance is an important issue, you may choose to run channels and listeners as trusted.

**Note:** If you are using MQSeries for Compaq (DIGITAL) OpenVMS the option on the MQ\_CONNECT\_TYPE is FAST, not FASTPATH.

---

## What next?

When you have made the preparations described in this chapter you are ready to set up communications. Proceed to one of the following chapters, depending on what platform you are using:

- “Chapter 10. Setting up communication for OS/2 and Windows NT” on page 123
- “Chapter 13. Setting up communication in UNIX systems” on page 191
- “Chapter 19. Setting up communication in Digital OpenVMS systems” on page 277
- “Chapter 20. Setting up communication in Tandem NSK” on page 289



---

## Chapter 10. Setting up communication for OS/2 and Windows NT

DQM is a remote queuing facility for MQSeries. It provides channel control programs for the queue manager which form the interface to communication links, controllable by the system operator. The channel definitions held by distributed-queuing management use these connections.

When a distributed-queuing management channel is started, it tries to use the connection specified in the channel definition. For this to succeed, it is necessary for the connection to be defined and available. This chapter explains how to do this. You may also find it helpful to refer to “Chapter 11. Example configuration - IBM MQSeries for OS/2 Warp” on page 137 or “Chapter 12. Example configuration - IBM MQSeries for Windows NT” on page 169.

For UNIX systems see “Chapter 13. Setting up communication in UNIX systems” on page 191. For Digital OpenVMS, see “Chapter 19. Setting up communication in Digital OpenVMS systems” on page 277.

---

### Deciding on a connection

There are four forms of communication for MQSeries for OS/2 Warp and Windows NT:

- TCP
- LU 6.2
- NetBIOS
- SPX

Each channel definition must specify only one protocol as the Transmission protocol (Transport Type) attribute. One or more protocols may be used by a queue manager.

For MQSeries clients, it may be useful to have alternative channels using different transmission protocols. See the *MQSeries Clients* book.

### Defining a TCP connection

The channel definition at the sending end specifies the address of the target. A listener program must be run at the receiving end.

#### Sending end

Specify the host name, or the TCP address of the target machine, in the Connection name field of the channel definition. The port to connect to will default to 1414. Port number 1414 is assigned by the Internet Assigned Numbers Authority to MQSeries.

To use a port number other than the default, change the connection name field thus:

```
Connection Name OS2R0G3(1822)
```

where 1822 is the port required. (This must be the port that the listener at the receiving end is listening on.)

You can change the default port number by specifying it in the queue manager configuration file (qm.ini) for MQSeries for OS/2 Warp and the registry for MQSeries for Windows NT:

```
TCP:  
  Port=1822
```

For more information about the values you set using qm.ini, see “Appendix D. Configuration file stanzas for distributed queuing” on page 637.

#### Receiving on TCP

Receiving channel programs are started in response to a startup request from the sending channel. To do this, a listener program has to be started to detect incoming network requests and start the associated channel.

You should use either the TCP/IP listener (INETD) (not for Windows NT) or the MQSeries listener.

#### Using the TCP/IP listener

To use INETD to start channels on OS/2, two files must be configured:

1. Add a line in the TCPIP\ETC\SERVICES file:

```
MQSeries      1414/tcp
```

where 1414 is the port number required for MQSeries. You can change this but it must match the port number specified at the sending end.

2. Add a line to the TCPIP\ETC\INETD.LST file:

```
MQSeries      tcp C:\MQM\BIN\AMQCRSTA [-m QMName]
```

The last part in square brackets is optional and is not required for the default queue manager. If your MQSeries for OS/2 Warp is installed on a different drive, replace the C: above with the correct drive letter.

It is possible to have more than one queue manager on the machine. You must add a line to each of the two files, as above, for each of the queue managers. For example:

```
MQSeries2     1822/tcp
```

Now stop, and then start the inetd program, before continuing.

### Using the TCP listener backlog option

When receiving on TCP, a maximum number of outstanding connection requests is set. This can be considered a *backlog* of requests waiting on the TCP port for the listener to accept the request. The default listener backlog values are shown in Table 11.

Table 11. Default outstanding connection requests on OS/2 and Windows NT

Platform	Default listener backlog value
OS/2 Warp	10
Windows NT Server	100
Windows NT Workstation	5

If the backlog reaches the values shown in Table 11, the TCP/IP connection is rejected and the channel will not be able to start.

For MCA channels, this results in the channel going into a RETRY state and retrying the connection at a later time.

For client connections, the client receives an MQRC\_Q\_MGR\_NOT\_AVAILABLE reason code from MQCONN and should retry the connection at a later time.

However, to avoid this error, you can add an entry in the qm.ini file or in the registry for Windows NT:

```
TCP:
ListenerBacklog = n
```

This overrides the default maximum number of outstanding requests (see Table 11) for the TCP/IP listener.

**Note:** Some operating systems support a larger value than the default. If necessary, this can be used to avoid reaching the connection limit.

To run the listener with the backlog option switched on, use the RUNMQLSR -B command. For information about the RUNMQLSR command, see the *MQSeries System Administration* book.

### Using the MQSeries listener

To run the Listener supplied with MQSeries, that starts new channels as threads, use the RUNMQLSR command. For example:

```
RUNMQLSR -t tcp [-m QMNAME] [-p 1822]
```

The square brackets indicate optional parameters; QMNAME is not required for the default queue manager, and the port number is not required if you are using the default (1414).

For the best performance, run the MQSeries listener as a trusted application as described in “Running channels and listeners as trusted applications” on page 121. See the *MQSeries Application Programming Guide* for information about trusted applications.

You can stop all MQSeries listeners running on a queue manager that is inactive, using the command:

## Defining a TCP connection

```
ENDMQLSR [-m QMNAME]
```

If you do not specify a queue manager name, the default queue manager is assumed.

### Using the TCP/IP SO\_KEEPALIVE option

If you want to use the SO\_KEEPALIVE option (as discussed in “Checking that the other end of the channel is still available” on page 66) you need to add the following entry to your queue manager configuration file (qm.ini):

```
TCP:
  KeepAlive=yes
```

If you are using OS/2, you must then issue the following command:

```
inetcfg keepalive=value
```

where *value* is the time interval in minutes.

On Windows NT, the TCP configuration registry value for KeepAliveTime controls the interval that elapses before the connection will be checked. The default is two hours. For information about changing this value, see the Microsoft article *TCP/IP and NBT Configuration Parameters for Windows NT 3.5* (PSS ID number Q120642).

---

## Defining an LU 6.2 connection

SNA must be configured so that an LU 6.2 conversation can be established between the two machines. Then proceed as follows.

See the *Multiplatform APPC Configuration Guide* for OS/2 examples, and the following table for information.

Table 12. Settings on the local OS/2 or Windows NT system for a remote queue manager platform

Remote platform	TPNAME	TPPATH
OS/390 or MVS/ESA without CICS	The same as in the corresponding side information on the remote queue manager.	-
OS/390 or MVS/ESA using CICS	CKRC (sender) CKSV (requester) CKRC (server)	-
OS/400	The same as the compare value in the routing entry on the OS/400 system.	-
OS/2	As specified in the OS/2 Run Listener command, or defaulted from the OS/2 queue manager configuration file.	<drive>:\mqm\bin\amqcrs6a
UNIX systems	The same as in the corresponding side information on the remote queue manager.	mqmtop/bin/amqcrs6a
Windows NT	As specified in the Windows NT Run Listener command, or the invokable Transaction Program that was defined using TpSetup on Windows NT.	<drive>:\mqm\bin\amqcrs6a

If you have more than one queue manager on the same machine, ensure that the TPnames in the channel definitions are unique.

### Sending end for OS/2

Establish a valid session between the two machines. The local LU that MQSeries uses is decided in the following order:

1. Specify the LU that will be used. In the queue manager configuration file (qm.ini), under the LU 6.2 section add the line:

```
LOCALLU = Your_LU_Name
```

For more information about the values you set using qm.ini, see “Appendix D. Configuration file stanzas for distributed queuing” on page 637.

2. Specify the environment variable:

```
APPNLLU = Your_LU_Name
```

3. If this has not been specified, your default LU will be used.

When you define an MQSeries channel that will use the LU 6.2 connection, the Connection name (CONNNAME) channel attribute specifies the fully-qualified name of the partner LU, as defined in the local Communications Manager/2 profile.

SECURITY PROGRAM is always used when MQSeries attempts to establish an SNA session.

### Sending end for Windows NT

Create a CPI-C side object (symbolic destination) from the administration application of the LU 6.2 product you are using, and enter this name in the Connection name field in the channel definition. Also create an LU 6.2 link to the partner.

In the CPI-C side object enter the partner LU Name at the receiving machine, the TP Name and the Mode Name. For example:

```
Partner LU Name      OS2R0G2
Partner TP Name     recv
Mode Name           #INTER
```

### Receiving on LU 6.2

Receiving channel programs are started in response to a startup request from the sending channel. To do this, a listener program has to be started to detect incoming network requests and start the associated channel. You start this listener program with the RUNMQLSR command, giving the TpName to listen on. Alternatively, you can use Attach Manager in Communications Manager/2 for OS/2, or TpStart under SNA Server for Windows NT.

#### Using the RUNMQLSR command

Example of the command to start the listener:

```
RUNMQLSR -t LU62 -n RECV [-m QMNAME]
```

where RECV is the TpName that is specified at the other (sending) end as the “TpName to start on the remote side”. The last part in square brackets is optional and is not required for the default queue manager.

It is possible to have more than one queue manager running on one machine. You must assign a different TpName to each queue manager, and then start a listener program for each one. For example:

## Defining an LU 6.2 connection

```
RUNMQLSR -t LU62 -m QM1 -n TpName1  
RUNMQLSR -t LU62 -m QM2 -n TpName2
```

For the best performance, run the MQSeries listener as a trusted application as described in “Running channels and listeners as trusted applications” on page 121. See the *MQSeries Application Programming Guide* for information about trusted applications.

You can stop all MQSeries listeners running on a queue manager that is inactive, using the command:

```
ENDMQLSR [-m QMNAME]
```

If you do not specify a queue manager name, the default queue manager is assumed.

### Using Communications Manager/2 on OS/2

If you are going to use Attach Manager in Communications Manager/2 to start the listener program, you must specify the *Program parameter string* or *parm\_string* in addition to the TPNAME and TPPATH.

You can do this using the panel configuration in Communications Manager/2 or, alternatively, you can edit your NDF file directly (see the heading “Define Transaction Programs” in the *Multiplatform APPC Configuration Guide*).

**Panel configuration:** These are the entries required on the TP definition panel:

```
Transaction Program (TP) name : AMQCRS6A  
OS/2 program path and file name: c:\mqm\bin\amqcrs6a.exe  
Program parameter string      : -n AMQCRS6A
```

**NDF file configuration:** Your node definitions file (.ndf) must contain a **define\_tp** command. The following example shows what must be included:

```
define_tp  
  tp_name(AMQCRS6A)  
  filespec(c:\mqm\bin\amqcrs6a.exe)  
  parm_string(-n AMQCRS6A -m QM1)
```

### Using Microsoft SNA Server on Windows NT

You can use TpSetup (from the SNA Server SDK) to define an invokable TP that then drives amqcrs6a.exe, or you can set various registry values manually. The parameters that should be passed to amqcrs6a.exe are:

```
-m QM -n TpName
```

where *QM* is the Queue Manager name and *TpName* is the TP Name. See the *Microsoft SNA Server APPC Programmers Guide* or the *Microsoft SNA Server CPI-C Programmers Guide* for more information.

---

## Defining a NetBIOS connection

MQSeries uses three types of NetBIOS resource when establishing a NetBIOS connection to another MQSeries product: sessions, commands, and names. Each of these resources has a limit, which is established either by default or by choice during the installation of NetBIOS.

Each running channel, regardless of type, uses one NetBIOS session and one NetBIOS command. The IBM NetBIOS implementation allows multiple processes to use the same local NetBIOS name. Therefore, only one NetBIOS name needs to be available for use by MQSeries. Other vendors’ implementations, for example

## Defining a NetBIOS connection

Novell's NetBIOS emulation, require a different local name per process. Verify your requirements from the documentation for the NetBIOS product you are using.

In all cases, ensure that sufficient resources of each type are already available, or increase the maximums specified in the configuration. Any changes to the values will require a system restart.

During system startup, the NetBIOS device driver displays the number of sessions, commands, and names available for use by applications. These resources are available to any NetBIOS-based application that is running on the same system. Therefore, it is possible for other applications to consume these resources before MQSeries needs to acquire them. Your LAN network administrator should be able to clarify this for you.

### Defining the MQSeries local NetBIOS name

The local NetBIOS name used by MQSeries channel processes can be specified in three ways. In order of precedence they are:

1. The value specified in the `-l` parameter of the `RUNMQLSR` command, for example:

```
RUNMQLSR -t NETBIOS -l my_station
```

2. The `MQNAME` environment variable whose value is established by the command:

```
SET MQNAME=my_station
```

You can set the `MQNAME` value for each process. Alternatively, you may set it at a system level — in the `CONFIG.SYS` file on OS/2 or in the Windows NT registry.

If you are using a NetBIOS implementation that requires unique names, you must issue a `SET MQNAME` command in each window in which an MQSeries process is started. The `MQNAME` value is arbitrary but it must be unique for each process.

3. The `NETBIOS` stanza in the queue manager configuration file `qm.ini` or in the Windows NT registry. For example:

```
NETBIOS:
```

```
LocalName=my_station
```

#### Notes:

1. Due to the variations in implementation of the NetBIOS products supported, you are advised to make each NetBIOS name unique in the network. If you do not, unpredictable results may occur. If you have problems establishing a NetBIOS channel and there are error messages in the queue-manager error log showing a NetBIOS return code of `X'15'`, review your use of NetBIOS names.
2. On Windows NT you cannot use your machine name as the NetBIOS name because Windows NT already uses it.
3. Sender channel initiation requires that a NetBIOS name be specified either via the `MQNAME` environment variable or the `LocalName` in the `qm.ini` file or in the Windows NT registry.

## Defining a NetBIOS connection

### Establishing the queue manager NetBIOS session, command, and name limits

The queue manager limits for NetBIOS sessions, commands, and names can be specified in two ways. In order of precedence they are:

1. The values specified in the RUNMQLSR command:

```
-s Sessions  
-e Names  
-o Commands
```

If the `-m` operand is not specified in the command, the values will apply only to the default queue manager.

2. The NETBIOS stanza in the queue manager configuration file `qm.ini` or in the Windows NT registry. For example:

```
NETBIOS:  
  
NumSess=Qmgr_max_ses  
NumCmds=Qmgr_max_cmds  
NumNames=Qmgr_max_names
```

### Establishing the LAN adapter number

For channels to work successfully across NetBIOS, the adapter support at each end must be compatible. MQSeries allows you to control the choice of adapter number (`lana`) by using the `AdapterNum` value in the NETBIOS stanza of your `qm.ini` file or the Windows NT registry and by specifying the `-a` parameter on the `runmqsr` command.

The default LAN adapter number used by MQSeries for NetBIOS connections is 0. Verify the adapter number being used on your system as follows:

On OS/2 the adapter number used by NetBIOS on your system can be viewed in the `PROTOCOL.INI` file or the `LANTRAN.LOG` file found in the `\IBMCOM` directory.

On Windows NT view the information displayed in the NetBIOS Interface pop-up window. This is accessible by selecting the Network option, which is one of many options displayed when opening the Control icon from the Main Window. Windows NT can assign multiple 'logical' adapter numbers to one physical LAN adapter. The installation default for 'logical' adapter number 0 is NetBIOS running over a TCP network, not a Token-Ring network. This is not necessary for MQSeries. You should select logical adapter number 1, which is native NetBIOS. MQSeries for Windows NT uses the 'logical' adapter number for communication.

Specify the correct value in the NETBIOS stanza of the queue manager configuration file, `qm.ini`, or the Windows NT registry:

```
NETBIOS:  
AdapterNum=n
```

where `n` is the correct LAN adapter number for this system.

### Initiating the connection

To initiate the connection, follow these steps at the sending end:

1. Define the NetBIOS station name using the `MQNAME` or `LocalName` value as described above.



## Defining a NetBIOS connection

2. Verify the LAN adapter number being used on your system and specify the correct file using the AdapterNum as described above.
3. In the ConnectionName field of the channel definition, specify the NetBIOS name being used by the target listener program. On Windows NT, NetBIOS channels **must** be run as threads. Do this by specifying MCATYPE(THREAD) in the channel definition.

```
DEFINE CHANNEL (cname) CHLTYPE(SDR) +  
  TRPTYPE(NETBIOS) +  
  CONNAME(your_station) +  
  XMITQ(xmitq) +  
  MCATYPE(THREAD) +  
  REPLACE
```

## Target listener

At the receiving end, follow these steps:

1. Define the NetBIOS station name using the MQNAME or LocalName value as described above.
2. Verify the LAN adapter number being used on your system and specify the correct file using the AdapterNum as described above.
3. Define the receiver channel:

```
DEFINE CHANNEL (cname) CHLTYPE(RCVR) +  
  TRPTYPE(NETBIOS) +  
  REPLACE
```

4. Start the MQSeries listener program to establish the station and make it possible to contact it. For example:

```
RUNMQLSR -t NETBIOS -l your_station [-m qmgr]
```

This command establishes your\_station as a NetBIOS station waiting to be contacted. The NetBIOS station name must be unique throughout your NetBIOS network.

For the best performance, run the MQSeries listener as a trusted application as described in “Running channels and listeners as trusted applications” on page 121. See the *MQSeries Application Programming Guide* for information about trusted applications.

You can stop all MQSeries listeners running on a queue manager that is inactive, using the command:

```
ENDMQLSR [-m QMNAME]
```

If you do not specify a queue manager name, the default queue manager is assumed.

---

## Defining an SPX connection

The channel definition at the sending end specifies the address of the target. A listener program must be run at the receiving end.

### Sending end

If the target machine is remote, specify the SPX address of the target machine in the Connection name field of the channel definition.

The SPX address is specified in the following form:

```
network.node(socket)
```

## Defining an SPX connection

where:

*network*

Is the 4-byte network address of the network on which the remote machine resides,

*node* Is the 6-byte node address, which is the LAN address of the LAN adapter in the remote machine

*socket* Is the 2-byte socket number on which the remote machine will listen.

If the local and remote machines are on the same network then the network address need not be specified. If the remote end is listening on the default socket (5E86) then the socket need not be specified.

An example of a fully specified SPX address specified in the CONNAME parameter of an MQSC command is:

```
CONNAME('00000001.08005A7161E5(5E87)')
```

In the default case, where the machines are both on the same network, this becomes:

```
CONNAME(08005A7161E5)
```

The default socket number may be changed by specifying it in the queue manager configuration file (qm.ini) or the Windows NT registry:

SPX:

```
Socket=5E87
```

For more information about the values you set using qm.ini or the Windows NT registry, see “Appendix D. Configuration file stanzas for distributed queuing” on page 637.

### Using the SPX KEEPALIVE option (OS/2 only)

If you want to use the KEEPALIVE option (as discussed in “Checking that the other end of the channel is still available” on page 66) you need to add the following entry to your queue manager configuration file (qm.ini):

SPX:

```
KeepAlive=yes
```

You can use the timeouts described in “IPX/SPX parameters” on page 133 to adjust the behavior of KEEPALIVE.

## Receiving on SPX

Receiving channel programs are started in response to a startup request from the sending channel. To do this, a listener program has to be started to detect incoming network requests and start the associated channel.

You should use the MQSeries listener.

### Using the TCP listener backlog option

When receiving on TCP/IP, a maximum number of outstanding connection requests is set. This can be considered a *backlog* of requests waiting on the TCP/IP port for the listener to accept the request. The default listener backlog values are shown in Table 13.

Table 13. Default outstanding connection requests on OS/2 and Windows NT

Platform	Default listener backlog value
OS/2 Warp	10

Table 13. Default outstanding connection requests on OS/2 and Windows NT (continued)

Platform	Default listener backlog value
Windows NT Server	100
Windows NT Workstation	5

If the backlog reaches the values in Table 13 on page 132, the reason code, MQRC\_Q\_MGR\_NOT\_AVAILABLE is received when trying to connect to the queue manager using MQCONN or MQCONN. If this happens, it is possible to try to connect again.

However, to avoid this error, you can add an entry in the qm.ini file or in the registry for Windows NT:

```
TCP:
ListenerBacklog = n
```

This overrides the default maximum number of outstanding requests (see Table 13 on page 132) for the TCP/IP listener.

**Note:** Some operating systems support a larger value than the default. If necessary, this can be used to avoid reaching the connection limit.

To run the listener with the backlog option switched on, use the RUNMQLSR -B command. For information about the RUNMQLSR command, see the *MQSeries System Administration* book.

### Using the MQSeries listener

To run the Listener supplied with MQSeries, that starts new channels as threads, use the RUNMQLSR command. For example:

```
RUNMQLSR -t spx [-m QMNAME] [-x 5E87]
```

The square brackets indicate optional parameters; QMNAME is not required for the default queue manager, and the socket number is not required if you are using the default (5E86).

For the best performance, run the MQSeries listener as a trusted application as described in “Running channels and listeners as trusted applications” on page 121. See the *MQSeries Application Programming Guide* for information about trusted applications.

You can stop all MQSeries listeners running on a queue manager that is inactive, using the command:

```
ENDMQLSR [-m QMNAME]
```

If you do not specify a queue manager name, the default queue manager is assumed.

## IPX/SPX parameters

In most cases the default settings for the IPX/SPX parameters will suit your needs. However, you may need to modify some of them in your environment to tune its use for MQSeries. The actual parameters and the method of changing them varies according to the platform and provider of SPX communications support. The following sections describe some of these parameters, particularly those that may influence the operation of MQSeries channels and client connections.

## Defining an SPX connection

### OS/2

Please refer to the Novell Client for OS/2 documentation for full details of the use and setting of NET.CFG parameters.

The following IPX/SPX parameters can be added to the Novell NET.CFG file, and can affect MQSeries SPX channels and client connections.

#### IPX:

##### **sockets (range = 9 - 128, default 64)**

This specifies the total number of IPX sockets available. MQSeries channels use this resource, so depending on the number of channels and the requirements of other IPX/SPX applications, you may need to increase this value.

#### SPX:

##### **sessions (default 16)**

This specifies the total number of simultaneous SPX connections. Each MQSeries channel or client connection uses one session. You may need to increase this value depending on the number of MQSeries channels or client connections you need to run.

##### **retry count (default = 12)**

This controls the number of times an SPX session will resend unacknowledged packets. MQSeries does not override this value.

##### **verify timeout, listen timeout, and abort timeout (milliseconds)**

These timeouts adjust the 'Keepalive' behavior. If an SPX sending end does not receive anything within the 'verify timeout' period, it sends a packet to the receiving end. It then waits for the duration of the 'listen timeout' for a response. If it still does not receive a response, it sends another packet and expects a response within the 'abort timeout' period.

## DOS and Windows 3.1 client

Please refer to the Novell Client for DOS and MS Windows documentation for full details of the use and setting of NET.CFG parameters.

The following IPX/SPX parameters can be added to the Novell NET.CFG file, and can affect MQSeries SPX channels and client connections.

#### IPX:

##### **sockets (default = 20)**

This specifies the total number of IPX sockets available. MQSeries channels use this resource, so depending on the number of channels and the requirements of other IPX/SPX applications, you may need to increase this value.

##### **retry count**

This controls the number of times unacknowledged packets will be resent. MQSeries does not override this value.

#### SPX:

##### **connections (default 15)**

This specifies the total number of simultaneous SPX connections. Each MQSeries channel or client connection uses one session. You may need to increase this value depending on the number of MQSeries channels or client connections you need to run.

### Windows NT

Please refer to the Microsoft documentation for full details of the use and setting of the NWLink IPX and SPX parameters. The IPX/SPX parameters are in the following paths in the registry:

```
HKEY_LOCAL_MACHINE\SYSTEM\CurrentControlSet\Service\NWLinkSPX\Parameters  
HKEY_LOCAL_MACHINE\SYSTEM\CurrentControlSet\Service\NWLinkIPX\Parameters
```

### Windows 95 and Windows 98

Please refer to the Microsoft documentation for full details of the use and setting of the IPX and SPX parameters. You access them by selecting Network option in the control panel, then double-clicking on **IPX/SPX Compatible Transport**.

## DQM in distributed platforms

---

## Chapter 11. Example configuration - IBM MQSeries for OS/2 Warp

This chapter gives an example of how to set up communication links from MQSeries for OS/2 Warp to MQSeries products on the following platforms:

- Windows NT
- AIX
- Digital UNIX
- HP-UX
- AT&T GIS UNIX<sup>1</sup>
- Sun Solaris
- OS/400
- OS/390 or MVS/ESA without CICS
- VSE/ESA

First it describes the parameters needed for an LU 6.2 connection, then it guides you through the following tasks:

- “Establishing an LU 6.2 connection” on page 142
- “Establishing a TCP connection” on page 158
- “Establishing a NetBIOS connection” on page 160
- “Establishing an SPX connection” on page 160

Once the connection is established, you need to define some channels to complete the configuration. This is described in “MQSeries for OS/2 Warp configuration” on page 162.

See “Chapter 7. Example configuration chapters in this book” on page 97 for background information about this chapter and how to use it.

---

### Configuration parameters for an LU 6.2 connection

Table 14 on page 138 presents a worksheet listing all the parameters needed to set up communication from OS/2 to one of the other MQSeries platforms. The worksheet shows examples of the parameters, which have been tested in a working environment, and leaves space for you to fill in your own values. An explanation of the parameter names follows the worksheet. Use the worksheet in this chapter in conjunction with the worksheet in the chapter for the platform to which you are connecting.

This chapter shows how to use the values on the worksheet for:

- “Defining local node characteristics” on page 142
- “Connecting to a peer system” on page 150
- “Connecting to a host system” on page 153
- “Verifying the configuration” on page 157

### Configuration worksheet

Use the following worksheet to record the values you will use for this configuration. Where numbers appear in the Reference column they indicate that the value must match that in the appropriate worksheet elsewhere in this book.

---

1. This platform has become NCR UNIX SVR4 MP-RAS, R3.0

## OS/2 and LU 6.2

The examples that follow in this chapter refer back to the values in the ID column of this table. The entries in the Parameter Name column are explained in “Explanation of terms” on page 140.

Table 14. Configuration worksheet for Communications Manager/2

ID	Parameter Name	Reference	Example Used	User Value
<b>Definition for local node</b>				
<b>1</b>	Configuration name		EXAMPLE	
<b>2</b>	Network ID		NETID	
<b>3</b>	Local node name		OS2PU	
<b>4</b>	Local node ID (hex)		05D 12345	
<b>5</b>	Local node alias name		OS2PU	
<b>6</b>	LU name (local)		OS2LU	
<b>7</b>	Alias (for local LU name)		OS2QMGR	
<b>8</b>	Local transaction program (TP) name		MQSERIES	
<b>9</b>	OS/2 program path and file name		c:\mqm\bin\amqcrs6a.exe	
<b>10</b>	LAN adapter address		10005AFC5D83	
<b>Connection to a Windows NT system</b>				
The values in this section of the table must match those used in Table 16 on page 170, as indicated.				
<b>11</b>	Link name		WINNT	
<b>12</b>	LAN destination address (hex)	<b>9</b>	08005AA5FAB9	
<b>13</b>	Partner network ID	<b>2</b>	NETID	
<b>14</b>	Partner node name	<b>3</b>	WINNTCP	
<b>15</b>	LU name	<b>5</b>	WINNTLU	
<b>16</b>	Alias (for remote LU name)		NTQMGR	
<b>17</b>	Mode	<b>17</b>	#INTER	
<b>18</b>	Remote transaction program name	<b>7</b>	MQSERIES	
<b>Connection to an AIX system</b>				
The values in this section of the table must match those used in Table 20 on page 197, as indicated.				
<b>11</b>	Link name		RS6000	
<b>12</b>	LAN destination address (hex)	<b>8</b>	123456789012	
<b>13</b>	Partner network ID	<b>1</b>	NETID	
<b>14</b>	Partner node name	<b>2</b>	AIXPU	
<b>15</b>	LU name	<b>4</b>	AIXLU	
<b>16</b>	Alias (for remote LU name)		AIXQMGR	
<b>17</b>	Mode	<b>17</b>	#INTER	
<b>18</b>	Remote transaction program name	<b>6</b>	MQSERIES	
<b>Connection to an HP-UX system</b>				
The values in this section of the table must match those used in Table 23 on page 219, as indicated.				
<b>11</b>	Link name		HPUX	
<b>12</b>	LAN destination address (hex)	<b>8</b>	100090DC2C7C	
<b>13</b>	Partner network ID	<b>4</b>	NETID	
<b>14</b>	Partner node name	<b>2</b>	HPUXPU	
<b>15</b>	LU name	<b>5</b>	HPUXLU	
<b>16</b>	Alias (for remote LU name)		HPUXQMGR	
<b>17</b>	Mode	<b>6</b>	#INTER	
<b>18</b>	Remote transaction program name	<b>7</b>	MQSERIES	



Table 14. Configuration worksheet for Communications Manager/2 (continued)

ID	Parameter Name	Reference	Example Used	User Value
<b>Connection to an AT&amp;T GIS UNIX system</b>				
The values in this section of the table must match those used in Table 25 on page 243, as indicated.				
<b>11</b>	Link name		GIS	
<b>12</b>	LAN destination address (hex)	<b>8</b>	10007038E86B	
<b>13</b>	Partner network ID	<b>2</b>	NETID	
<b>14</b>	Partner node name	<b>3</b>	GISPU	
<b>15</b>	LU name	<b>4</b>	GISLU	
<b>16</b>	Alias (for remote LU name)		GISQMGR	
<b>17</b>	Mode	<b>15</b>	#INTER	
<b>18</b>	Remote transaction program name	<b>5</b>	MQSERIES	
<b>Connection to a Sun Solaris system</b>				
The values in this section of the table must match those used in Table 27 on page 257, as indicated.				
<b>11</b>	Link name		SOLARIS	
<b>12</b>	LAN destination address (hex)	<b>5</b>	08002071CC8A	
<b>13</b>	Partner network ID	<b>2</b>	NETID	
<b>14</b>	Partner node name	<b>3</b>	SOLARPU	
<b>15</b>	LU name	<b>7</b>	SOLARLU	
<b>16</b>	Alias (for remote LU name)		SOLQMGR	
<b>17</b>	Mode	<b>17</b>	#INTER	
<b>18</b>	Remote transaction program name	<b>8</b>	MQSERIES	
<b>Connection to an AS/400 system</b>				
The values in this section of the table must match those used in Table 42 on page 460, as indicated.				
<b>11</b>	Link name		AS400	
<b>12</b>	LAN destination address (hex)	<b>4</b>	10005A5962EF	
<b>13</b>	Partner network ID	<b>1</b>	NETID	
<b>14</b>	Partner node name	<b>2</b>	AS400PU	
<b>15</b>	LU name	<b>3</b>	AS400LU	
<b>16</b>	Alias (for remote LU name)		AS4QMGR	
<b>17</b>	Mode	<b>17</b>	#INTER	
<b>18</b>	Remote transaction program name	<b>8</b>	MQSERIES	
<b>Connection to an OS/390 or MVS/ESA system without CICS</b>				
The values in this section of the table must match those used in Table 36 on page 396, as indicated.				
<b>11</b>	Link name		HOST0001	
<b>12</b>	LAN destination address (hex)	<b>8</b>	400074511092	
<b>13</b>	Partner network ID	<b>2</b>	NETID	
<b>14</b>	Partner node name	<b>3</b>	MVSPU	
<b>15</b>	LU name	<b>4</b>	MVSLU	
<b>16</b>	Alias (for remote LU name)		MVSMGR	
<b>17</b>	Mode	<b>10</b>	#INTER	
<b>18</b>	Remote transaction program name	<b>7</b>	MQSERIES	
<b>Connection to a VSE/ESA system</b>				
The values in this section of the table must match those used in Table 44 on page 485, as indicated.				
<b>11</b>	Link name		HOST0001	

## OS/2 and LU 6.2

Table 14. Configuration worksheet for Communications Manager/2 (continued)

ID	Parameter Name	Reference	Example Used	User Value
<b>12</b>	LAN destination address (hex)	<b>5</b>	400074511092	
<b>13</b>	Partner network ID	<b>1</b>	NETID	
<b>14</b>	Partner node name	<b>2</b>	VSEPU	
<b>15</b>	LU name	<b>3</b>	VSELU	
<b>16</b>	Alias (for remote LU name)		VSEQMGR	
<b>17</b>	Mode		#INTER	
<b>18</b>	Remote transaction program name	<b>4</b>	MQ01	MQ01

### Explanation of terms

#### **1 Configuration name**

This is the name of the OS/2 file that will hold the configuration.

If you are adding to or modifying an existing configuration it will be the name previously specified.

If you are creating a new configuration then you can specify any 8-character name that obeys the normal rules for file naming.

#### **2 Network ID**

This is the unique ID of the network to which you are connected. It is an alphanumeric value and can be 1-8 characters long. The network ID works with the local node name to uniquely identify a system. Your network administrator will tell you the value.

#### **3 Local node name**

This is the unique Control Point name for this workstation. Your network administrator will assign this to you.

#### **4 Local node ID (hex)**

This is a unique identifier for this workstation. On other platforms it is often referred to as the exchange ID (XID). Your network administrator will assign this to you.

#### **5 Local node alias name**

This is the name by which your local node will be known within this workstation. This value is not used elsewhere, but it is recommended that it be the same as **3**, the local node name.

#### **6 LU name (local)**

An LU manages the exchange of data between systems. The local LU name is the name of the LU on your system. Your network administrator will assign this to you.

#### **7 Alias (for local LU name)**

The name by which your local LU will be known to your applications. You choose this name yourself. It can be 1-8 characters long. This value is used during MQSeries configuration, when entries are added to the qm.ini file.

#### **8 Local transaction program (TP) name**

MQSeries applications trying to converse with this workstation will specify a symbolic name for the program to be run at the receiving end. This will have been defined on the channel definition at the sender. The TP name is also used during MQSeries configuration, when entries are added to the qm.ini file. For simplicity, wherever possible use a transaction program

name of MQSERIES, or in the case of a connection to VSE/ESA, where the length is limited to 4 bytes, use MQTP.

See Table 12 on page 126 for more information.

**9 OS/2 program path and file name**

This is the path and name of the actual program to be run when a conversation has been initiated with this workstation. The example shown on the worksheet assumes that MQSeries is installed in the default directory, c:\mqm. The configuration pairs this name with the symbolic name **8**.

**10 LAN adapter address**

This is the address of your token-ring card. When using the default address, the exact value can be found in the LANTRAN.LOG file found in the \IBMCOM directory.

For example:

Adapter 0 is using node address 10005AFC5D83

**11 Link name**

This is a meaningful symbolic name by which the connection to a partner node is known. It is used only inside Communications Manager/2 setup and is specified by you. It can be 1-8 characters in length.

**16 Alias (for remote LU name)**

This is a value known only on this workstation and is used to represent the fully qualified partner LU name. You supply the value.

**17 Mode**

This is the name given to the set of parameters that control the APPC conversation. This name must be defined at each point in the network between the local and partner LUs. Your network administrator will assign this to you.

### Establishing an LU 6.2 connection

This section describes how to establish an LU 6.2 connection using Communications Manager/2 Version 1.11. You may use any of the supported LU 6.2 products for this platform. The panels would look different from those shown but most of their content would be similar.

#### Defining local node characteristics

To set up the local node you need to perform these tasks:

1. Configure a DLC.
2. Configure the local node.
3. Add a local LU.
4. Add a transaction program definition.
5. Configure a mode.

To define the local node characteristics:

1. Start the Communications Manager/2 Installation and Setup program by typing CMSETUP on an OS/2 command line, and pressing Enter.



2. Press **OK** to continue.



3. Press **Setup** to create or modify a configuration.



4. Specify a name (up to 8-characters) for a new configuration file **1**, or select the one that you wish to update. The following examples guide you through the creation of a new configuration file. Treat them as a guide if you are modifying an existing configuration.



5. Press **Yes**.



6. Press **Yes**.

In this example we set up connections using APPC over Token-ring. The following screen appears in two stages. When you first see it, highlight the line:  
 APPC APIs through Token-ring

The complete screen appears as shown below.

## Using Communications Manager/2

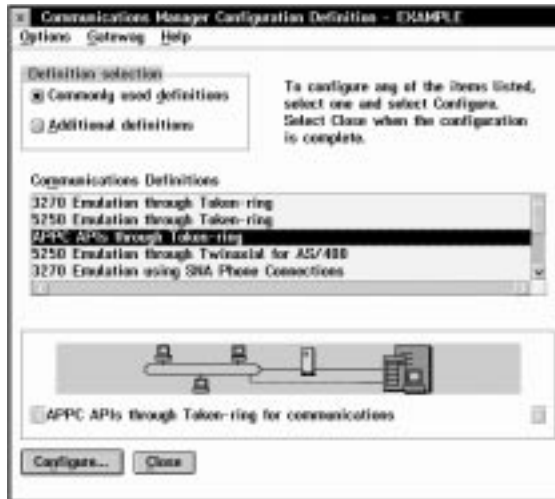

7. Press **Configure...**

### Configuring a DLC



1. Complete the values for **Network ID** ( **2** ) and **Local node name** ( **3** ).
  - a.
  - b. Select **End node - no network node server**.
  - c. Click on **Advanced**.



- d. Select **DLC - Token-ring or other LAN types** and press **Configure...**



- e. Enter the value for **C&SM LAN ID**. This should be the same value as the Network ID entered earlier ( **2** ).
- f. Leave the remaining default values and press **OK**.

### Configuring the local node



1. Select **SNA local node characteristics** and press **Configure....**

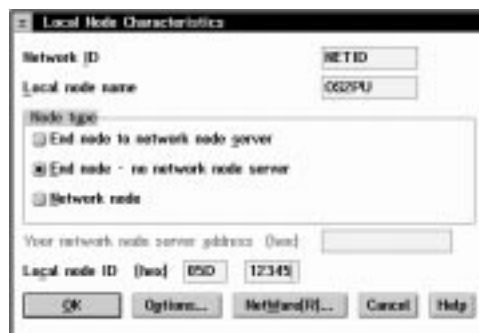

2. Complete the value for **Local node ID (hex)** ( **4** ) using the values in your configuration worksheet.

## Using Communications Manager/2

3. Press Options...

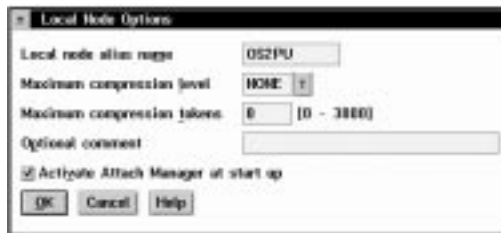

4. Complete the value for Local node alias name (5) and press OK.



5. Press OK.

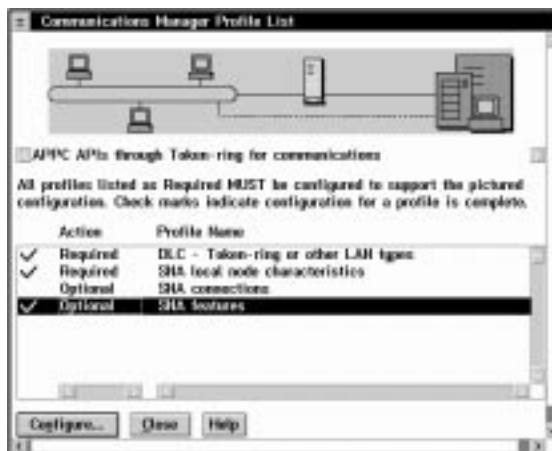

6. Select SNA features and press Configure....



## Adding a local LU

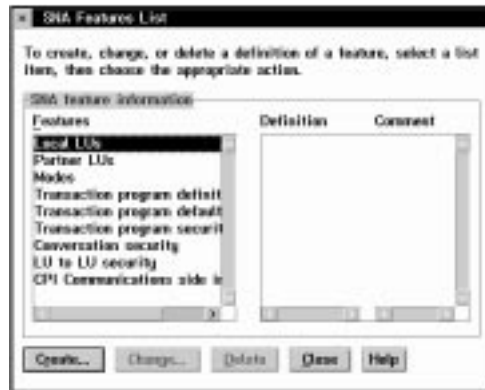

1. Select **Local LUs** and press **Create...**

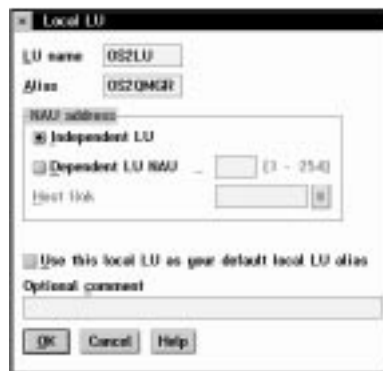

2. Complete the fields **LU name** ( **6** ) and **Alias** ( **7** ).
3. Press **OK**.

## Adding a transaction program definition



1. Select **Transaction program definitions** and press **Create...**

## Using Communications Manager/2



2. Complete the values for **Transaction program (TP) name** ( 8 ) and **OS/2 program path and file name** ( 9 ). If you are going to use Attach Manager to start the listener program, specify the **Program parameter string**, for example -m OS2 -n MQSERIES.
3. Press **Continue...**



4. Specify that the program is to be run in the **Background** and that it is to be **Non-queued, Attach Manager started**.
5. Press **OK**.

## Configuring a mode



1. Select **Modes** and **#INTER** and press **Change...**



2. Ensure that the default values match those shown above and press **Cancel**.



3. Press **Close** to close the SNA Features List window.

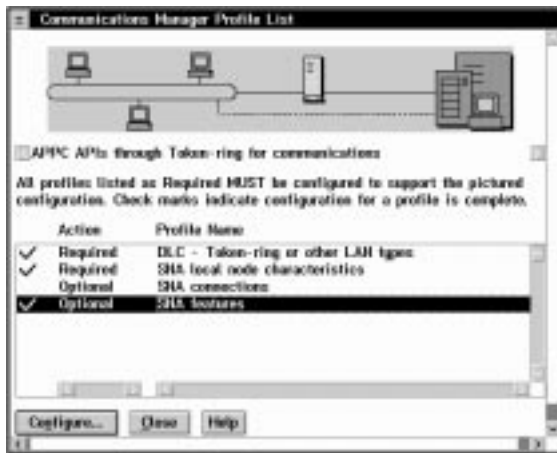

Local configuration is complete.

The following sections describe how to create connections to other nodes.

## Using Communications Manager/2

### Connecting to a peer system

To set up a connection to a peer system the steps are:

1. Adding a peer connection
2. Defining a partner LU

Start from the Communications Manager Profile List panel.

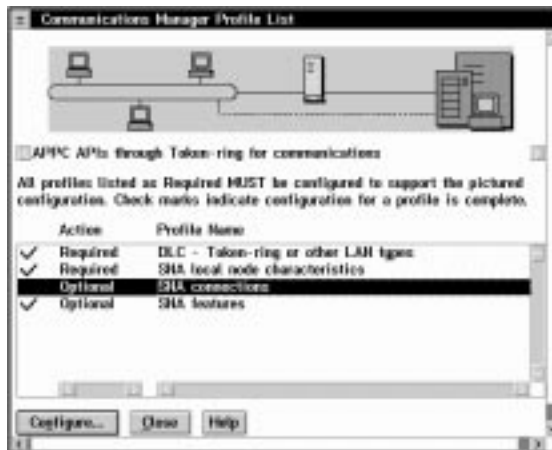

Select **SNA connections** and press **Configure...**

### Adding a peer connection



1. Select **To peer node** and press **Create...**



2. Select **Token-ring** or other LAN types and press **Continue**....



3. Specify a **Link name** ( **11** ) and check **Activate at startup**.
4. Complete the fields **LAN destination address (hex)** ( **12** ), **Partner network ID** ( **13** ), and **Partner node name** ( **14** ).



5. Press **Define Partner LUs**....

### Defining a partner LU

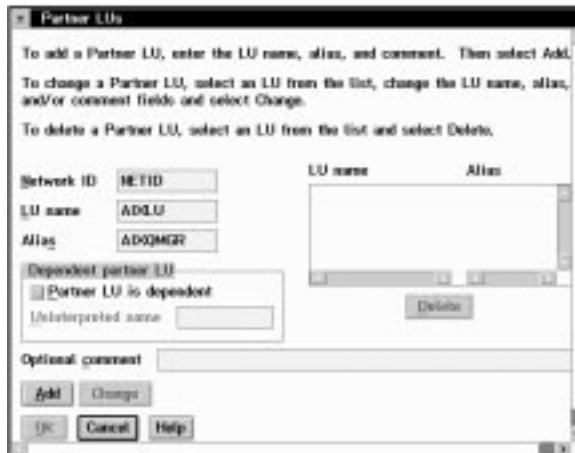

1. Complete the fields **Network ID** ( **13** ), **LU name** ( **15** ), and **Alias** ( **16** ).
2. Press **Add**.

## Using Communications Manager/2

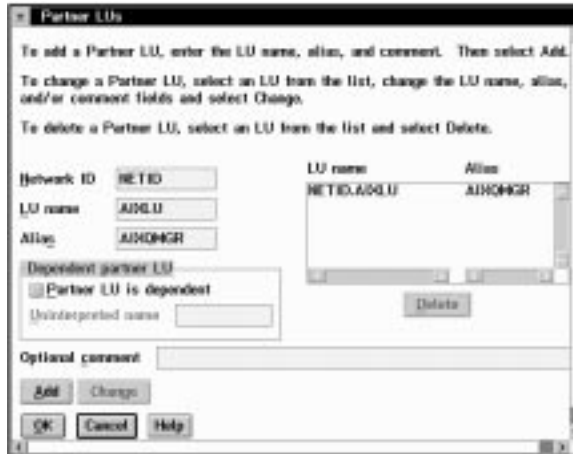

The 'Partner LU' dialog box contains the following fields and controls:

- Network ID: RETID
- LU name: AINLU
- Alias: AINQGR
- Dependent partner LU:  Partner LU is dependent
- Optional comment: (empty)
- Buttons: Add, Change, OK, Cancel, Help

LU name	Alias
RETID.AINLU	AINQGR

Buttons: Delete

3. Press **OK**.



The 'Connection to a Peer Node' dialog box contains the following fields and controls:

- Link name: RS000
- LAN destination address (hex): 123456789012
- Address format: Token Ring
- Remote SAP (hex): 04
- Partner network ID: RETID
- Partner node name: AINLU
- Optional comment: (empty)
- Buttons: OK, Define Partner LU..., Cancel, Help

4. Press **OK**.



The 'Connections List' dialog box contains the following fields and controls:

- Partner type:  To network node,  To peer node,  To host
- Table with columns: Link Name, Adapter, Adapter Number
- Table content: RS000, Token-ring or other LAN types, 0
- Buttons: Create..., Change..., Delete, Close, Help

Link Name	Adapter	Adapter Number
RS000	Token-ring or other LAN types	0

5. Press **Close**.

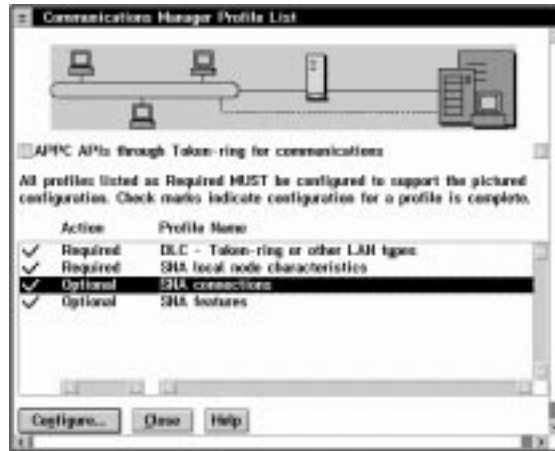

If you have connections to make to other platforms repeat this section as appropriate.

If you have made all the connections you require proceed to “Verifying the configuration” on page 157 to complete Communications Manager/2 configuration.

## Connecting to a host system

To set up a connection to a host system, for example OS/390 or VSE/ESA, the steps are:

1. Adding a host connection
2. Defining a partner LU

Start from the Communications Manager Profile List panel.



Select **SNA connections** and press **Configure...**

## Using Communications Manager/2

### Adding a host connection



1. Select **To host** and press **Create...**



2. Select **Token-ring or other LAN types** and press **Continue...**



3. Specify a **Link name** (**11**) and check **Activate at startup**.
4. Complete the fields **LAN destination address (hex)** (**12**), **Partner network ID** (**13**), and **Partner node name** (**14**).



5. Press Define Partner LUs....

### Defining a partner LU

1. Complete the fields Network ID ( **13** ), LU name ( **15** ), and Alias ( **16** ).
2. Press Add

3. Press OK.

## Using Communications Manager/2

Connection to a Host

Link name: HOST0001  Activate at startup

Local PU name: 012345  APPN support

Node ID (hex): 05D 12345

LAN destination address (hex): 40074510002 Address format: Token Ring Remote SAP (hex): 04

Adjacent node ID (hex):

Partner network ID: NETID

Partner node name: MVSPU (Required for partner LU definition)

Use this host connection as your local point support

Optional comment:

OK Define Partner LU... Cancel Help

4. Press OK.

Connection List

Choose the type of node to change or create connections to nodes of that type. Selecting a partner type will display connections to nodes of that type in the list.

Partner type:

To network node  To peer node  To host

Link Name	Adapter	Adapter Number
HOST0001	Token-ring or other LAN types	0

Comment:

Create... Change... Delete Close Help

5. Press Close.

Communications Manager Profile List

APPN APIs through Token-ring for communications

All profiles listed as Required MUST be configured to support the pictured configuration. Check marks indicate configuration for a profile is complete.

Action	Profile Name
<input checked="" type="checkbox"/> Required	DLC - Token-ring or other LAN types
<input checked="" type="checkbox"/> Required	SNA local node characteristics
<input checked="" type="checkbox"/> Optional	SNA connections
<input checked="" type="checkbox"/> Optional	SNA features

Configure... Close Help

If you have connections to make to other platforms, proceed to the appropriate section.

If you have made all the connections you require proceed to “Verifying the configuration” on page 157 to complete Communications Manager/2 configuration.

## Verifying the configuration

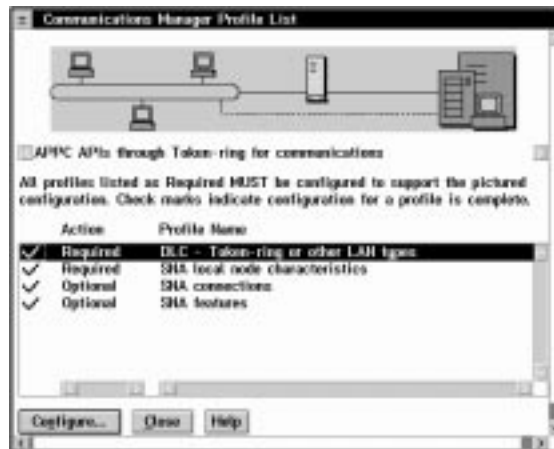

1. Press **Close** to close the Communications Manager Profile List panel.



2. Press **Close**.



3. Press **Yes**.

## Using Communications Manager/2

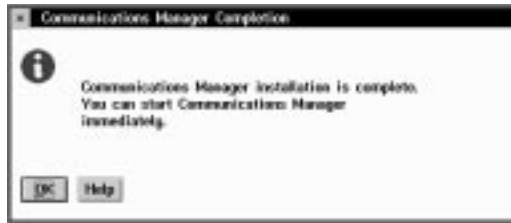

4. Press **OK**.



5. Press **Close**.

### What next?

The LU 6.2 connection is now established. You are ready to complete the configuration. Go to "MQSeries for OS/2 Warp configuration" on page 162.

---

## Establishing a TCP connection

1. From your desktop, open the TCP Icon View.

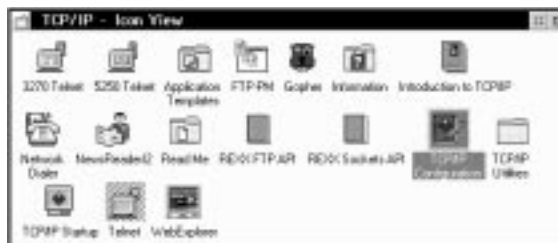

The icons you see may vary from those shown above, depending on how you have installed the product.

2. Start the TCP Configuration program.
3. On the Network page, ensure that the **IP Address** and **Subnet Mask** fields have been completed.
4. Select the **Autostart** tab.

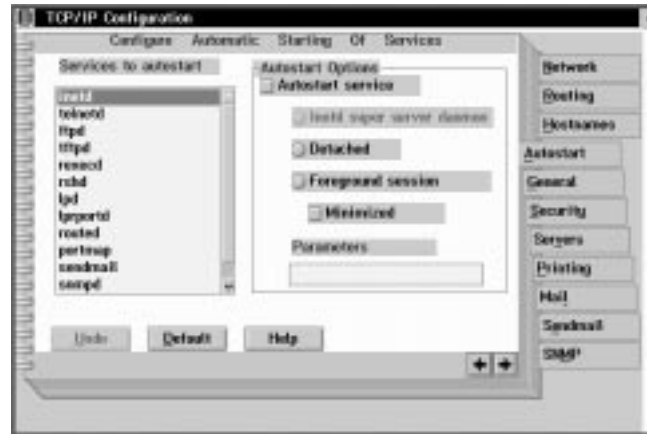

5. Ensure that **inetd** is selected.
6. Select the **Hostnames** tab.
7. Ensure that **This machine's hostname**, **Local domain name**, and **Nameserver address** have been completed.
8. Close the configuration notebook.

**Note:** You may see a panel warning that the inetd superserver has been selected without selecting servers. Press **No** to indicate that you do not wish to correct this.

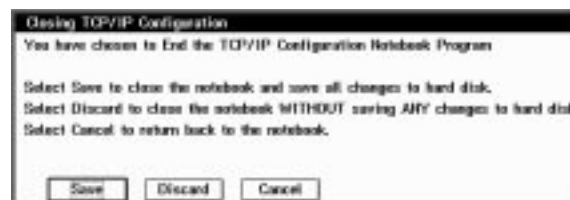

9. Press **Save** to save the changes made.
10. Verify that the `\MPTN\ETC\SERVICES` file, which is located on the drive where you installed IBM Multi-Protocol Transport Services (MPTS), contains the following line:

```
MQSeries 1414/tcp # MQSeries Chan'1 Listener
```

If this line is not present, add it.

11. Verify that the file `\MPTN\ETC\INETD.LST`, located on the same drive contains the following line:

```
MQSeries tcp c:\mqm\bin\amqcrsta [-m QMName]
```

If this line is not present, add it. Note that this assumes you have installed MQSeries on the default drive and in the default directories.

12. (Re)start the inetd superserver, either by rebooting OS/2 or by stopping any existing inetd superserver and then entering `start inetd` on the command line.

## What next?

The TCP connection is now established. You are ready to complete the configuration. Go to “MQSeries for OS/2 Warp configuration” on page 162.

---

## Establishing a NetBIOS connection

A NetBIOS connection is initiated from a queue manager that uses the `ConnectionName` parameter on its channel definition to connect to a target listener. To set up a NetBIOS connection, follow these steps:

1. At each end of the channel specify the local NetBIOS name to be used by the MQSeries channel processes, in the queue manager configuration file `qm.ini` or in the registry for Windows NT. For example, the NETBIOS stanza in `qm.ini` at the sending end might look like this:

```
NETBIOS:
  LocalName=02NETB1
```

and at the receiving end:

```
NETBIOS:
  LocalName=02NETB2
```

2. At each end of the channel, look at the `LANTRAN.LOG` file in the `\IBMC` directory to see what LAN adapter number is used by NetBIOS on your system. If it is not 0, which MQSeries uses by default, specify the correct value in the NETBIOS stanza of the `qm.ini` file or of the registry for Windows NT. For example:

```
NETBIOS:
  AdapterNum=1
```

3. At the sending end, define a channel specifying the NetBIOS name being used at the other end of the channel. For example:

```
DEFINE CHANNEL (OS2.WINNT.NET) CHLTYPE(SDR) +
  TRPTYPE(NETBIOS) +
  CONNAME(02NETB2) +
  XMITQ(WINNT) +
  REPLACE
```

4. At the receiving end, define the corresponding receiver channel. For example:

```
DEFINE CHANNEL (OS2.WINNT.NET) CHLTYPE(RCVR) +
  TRPTYPE(NETBIOS) +
  REPLACE
```

5. At the receiving end, start the MQSeries listener:

```
runmqlsr -t netbios
```

Optionally you may specify values for the queue manager name, NetBIOS local name, number of sessions, number of names, and number of commands. See “Defining a NetBIOS connection” on page 128 for more information about setting up NetBIOS connections.

---

## Establishing an SPX connection

This section discusses the following topics:

- IPX/SPX parameters
- SPX addressing
- Using the SPX `KEEPALIVE` option
- Receiving on SPX

### IPX/SPX parameters

In most cases the default settings for the IPX/SPX parameters will suit your needs. However, you may need to modify some of them in your environment to tune its use for MQSeries. The actual parameters and the method of changing them varies according to the platform and provider of SPX communications support. The

following sections describe some of these parameters, particularly those that may influence the operation of MQSeries channels and client connections.

Please refer to the Novell Client for OS/2 documentation for full details of the use and setting of NET.CFG parameters.

The following IPX/SPX parameters can be added to the Novell NET.CFG file, and can affect MQSeries SPX channels and client connections.

## IPX

### sockets (range = 9 - 128, default 64)

This specifies the total number of IPX sockets available. MQSeries channels use this resource, so depending on the number of channels and the requirements of other IPX/SPX applications, you may need to increase this value.

## SPX

### sessions (default 16)

This specifies the total number of simultaneous SPX connections. Each MQSeries channel or client connection uses one session. You may need to increase this value depending on the number of MQSeries channels or client connections you need to run.

### retry count (default = 12)

This controls the number of times an SPX session will resend unacknowledged packets. MQSeries does not override this value.

### verify timeout, listen timeout, and abort timeout (milliseconds)

These timeouts adjust the 'Keepalive' behavior. If an SPX sending end does not receive anything within the 'verify timeout' period, it sends a packet to the receiving end. It then waits for the duration of the 'listen timeout' for a response. If it still does not receive a response, it sends another packet and expects a response within the 'abort timeout' period.

## SPX addressing

MQSeries uses the SPX address of each machine to establish connectivity. The SPX address is specified in the following form:

*network.node(socket)*

where

*network*

Is the 4-byte network address of the network on which the remote machine resides,

*node* Is the 6-byte node address, which is the LAN address of the LAN adapter in the remote machine

*socket* Is the 2-byte socket number on which the remote machine will listen.

The default socket number used by MQSeries is 5E86. You can change the default socket number by specifying it in the queue manager configuration file qm.ini or the Windows NT registry. If you have taken the default options for installation, the qm.ini file for queue manager OS2 is found in c:\mqm\qmgs\os2. The lines in qm.ini might read:

```
SPX:
  SOCKET=n
```

## OS/2 and SPX

For more information about values you can set in `qm.ini`, see “Appendix D. Configuration file stanzas for distributed queuing” on page 637.

The SPX address is later specified in the `CONNNAME` parameter of the sender channel definition. If the MQSeries systems being connected reside on the same network, the network address need not be specified. Similarly, if the remote system is listening on the default socket number (5E86), it need not be specified. A fully qualified SPX address in the `CONNNAME` parameter would be:

```
CONNNAME('network.node(socket)')
```

but if the systems reside on the same network and the default socket number is used, the parameter would be:

```
CONNNAME(node)
```

A detailed example of the channel configuration parameters is given in “MQSeries for OS/2 Warp configuration”.

## Using the SPX KEEPALIVE option

If you want to use the `KEEPAIVE` option you need to add the following entry to your queue manager configuration file (`qm.ini`) or the Windows NT registry:

```
SPX:  
KeepAlive=yes
```

You can use the timeout parameters described above to adjust the behavior of `KEEPAIVE`.

## Receiving on SPX

Receiving channel programs are started in response to a startup request from the sending channel. To do this, a listener program has to be started to detect incoming network requests and start the associated channel.

You should use the MQSeries listener.

### Using the MQSeries listener

To run the Listener supplied with MQSeries, that starts new channels as threads, use the `RUNMQLSR` command. For example:

```
RUNMQLSR -t spx
```

Optionally you may specify the queue manager name or the socket number if you are not using the defaults.

---

## MQSeries for OS/2 Warp configuration

### Notes:

1. You can use the sample program `AMQSBCG` to display, to the stdout spool, the contents and headers of all the messages in a queue. For example:

```
AMQSBCG q_name qmgr_name
```

displays the contents of the queue `q_name` defined in queue manager `qmgr_name`.

2. The MQSeries command used to start the TCP listener is:

```
runmqlsr -t tcp
```

The listener enables receiver channels to start automatically in response to a start request from an inbound sender channel.



3. You can start any channel from the command prompt using the command  
`runmqchl -c channel.name`
4. Error logs can be found in the directories `\mqm\qmgrs\qmgrname\errors`, `\mqm\qmgrs\@system\errors`, and `\mqm\errors`. In all cases, the most recent messages are at the end of `amqerr01.log`.
5. When you are using the command interpreter **runmqsc** to enter administration commands, a `+` at the end of a line indicates that the next line is a continuation. Ensure that there is a space between the last parameter and the continuation character.

## Basic configuration

1. Create the queue manager from the OS/2 command line using the command:

```
crtmqm -u dlqname -q os2
```

where:

`os2` Is the name of the queue manager

`-q` Indicates that this is to become the default queue manager

`-u dlqname`

Specifies the name of the undeliverable message queue

This command creates a queue manager and a set of default objects, and sets the `DEADQ` attribute of the queue manager.

2. For SNA channels add an LU 6.2 stanza to the queue manager's `qm.ini` file:

```
LU62:
```

```
TPName=MQSERIES 8
```

```
LocalLU=OS2QMGR 7
```

If you have taken the default options for installation, the `qm.ini` file for queue manager `os2` is found in `c:\mqm\qmgrs\os2`.

3. Start the queue manager from the OS/2 command line using the command:

```
strmqm os2
```

where `os2` is the name given to the queue manager when it was created.

## Channel configuration

The following sections detail the configuration to be performed on the OS/2 queue manager to implement the channel described in Figure 32 on page 97. In each case the `MQSC` command is shown.

Examples are given for connecting MQSeries for OS/2 Warp and MQSeries for Windows NT. If you wish connect to another MQSeries product use the appropriate set of values from the table in place of those for Windows NT.

**Note:** The words in **bold** are user-specified and reflect the names of MQSeries objects used throughout these examples. If you change the names used here, ensure that you also change the other references made to these objects throughout this book. All others are keywords and should be entered as shown.

## OS/2 configuration

Table 15. Configuration worksheet for MQSeries for OS/2 Warp

	Parameter Name	Reference	Example Used	User Value
<b>Definition for local node</b>				
<b>A</b>	Queue Manager Name		OS2	
<b>B</b>	Local queue name		OS2.LOCALQ	
<b>Connection to MQSeries for Windows NT</b>				
The values in this section of the table must match those used in Table 17 on page 185, as indicated.				
<b>C</b>	Remote queue manager name	<b>A</b>	WINNT	
<b>D</b>	Remote queue name		WINNT.REMOTEQ	
<b>E</b>	Queue name at remote system	<b>B</b>	WINNT.LOCALQ	
<b>F</b>	Transmission queue name		WINNT	
<b>G</b>	Sender (SNA) channel name		OS2.WINNT.SNA	
<b>H</b>	Sender (TCP/IP) channel name		OS2.WINNT.TCP	
<b>I</b>	Receiver (SNA) channel name	<b>G</b>	WINNT.OS2.SNA	
<b>J</b>	Receiver (TCP/IP) channel name	<b>H</b>	WINNT.OS2.TCP	
<b>K</b>	Sender (NetBIOS) channel name		OS2.WINNT.NET	
<b>L</b>	Sender (SPX) channel name		OS2.WINNT.SPX	
<b>M</b>	Receiver (NetBIOS) channel name	<b>K</b>	WINNT.OS2.NET	
<b>N</b>	Receiver (SPX) channel name	<b>L</b>	WINNT.OS2.SPX	
<b>Connection to MQSeries for AIX</b>				
The values in this section of the table must match those used in Table 21 on page 211, as indicated.				
<b>C</b>	Remote queue manager name	<b>A</b>	AIX	
<b>D</b>	Remote queue name		AIX.REMOTEQ	
<b>E</b>	Queue name at remote system	<b>B</b>	AIX.LOCALQ	
<b>F</b>	Transmission queue name		AIX	
<b>G</b>	Sender (SNA) channel name		OS2.AIX.SNA	
<b>H</b>	Sender (TCP/IP) channel name		OS2.AIX.TCP	
<b>I</b>	Receiver (SNA) channel name	<b>G</b>	AIX.OS2.SNA	
<b>J</b>	Receiver (TCP) channel name	<b>H</b>	AIX.OS2.TCP	
<b>Connection to MQSeries for DIGITAL UNIX (Compaq Tru64 UNIX)</b>				
The values in this section of the table must match those used in Table 22 on page 216, as indicated.				
<b>C</b>	Remote queue manager name	<b>A</b>	DECUX	
<b>D</b>	Remote queue name		DECUX.REMOTEQ	
<b>E</b>	Queue name at remote system	<b>B</b>	DECUX.LOCALQ	
<b>F</b>	Transmission queue name		DECUX	
<b>H</b>	Sender (TCP) channel name		DECUX.OS2.TCP	
<b>J</b>	Receiver (TCP) channel name	<b>H</b>	OS2.DECUX.TCP	
<b>Connection to MQSeries for HP-UX</b>				
The values in this section of the table must match those used in Table 24 on page 239, as indicated.				
<b>C</b>	Remote queue manager name	<b>A</b>	HPUX	
<b>D</b>	Remote queue name		HPUX.REMOTEQ	
<b>E</b>	Queue name at remote system	<b>B</b>	HPUX.LOCALQ	
<b>F</b>	Transmission queue name		HPUX	
<b>G</b>	Sender (SNA) channel name		OS2.HPUX.SNA	
<b>H</b>	Sender (TCP) channel name		OS2.HPUX.TCP	
<b>I</b>	Receiver (SNA) channel name	<b>G</b>	HPUX.OS2.SNA	

Table 15. Configuration worksheet for MQSeries for OS/2 Warp (continued)

	Parameter Name	Reference	Example Used	User Value
<b>J</b>	Receiver (TCP) channel name	<b>H</b>	HPUX.OS2.TCP	
<b>Connection to MQSeries for AT&amp;T GIS UNIX</b>				
The values in this section of the table must match those used in Table 26 on page 253, as indicated.				
<b>C</b>	Remote queue manager name	<b>A</b>	GIS	
<b>D</b>	Remote queue name		GIS.REMOTEQ	
<b>E</b>	Queue name at remote system	<b>B</b>	GIS.LOCALQ	
<b>F</b>	Transmission queue name		GIS	
<b>G</b>	Sender (SNA) channel name		OS2.GIS.SNA	
<b>H</b>	Sender (TCP) channel name		OS2.GIS.TCP	
<b>I</b>	Receiver (SNA) channel name	<b>G</b>	GIS.OS2.SNA	
<b>J</b>	Receiver (TCP) channel name	<b>H</b>	GIS.OS2.TCP	
<b>Connection to MQSeries for Sun Solaris</b>				
The values in this section of the table must match those used in Table 28 on page 272, as indicated.				
<b>C</b>	Remote queue manager name		SOLARIS	
<b>D</b>	Remote queue name		SOLARIS.REMOTEQ	
<b>E</b>	Queue name at remote system	<b>B</b>	SOLARIS.LOCALQ	
<b>F</b>	Transmission queue name		SOLARIS	
<b>G</b>	Sender (SNA) channel name		OS2.SOLARIS.SNA	
<b>H</b>	Sender (TCP/IP) channel name		OS2.SOLARIS.TCP	
<b>I</b>	Receiver (SNA) channel name	<b>G</b>	SOLARIS.OS2.SNA	
<b>J</b>	Receiver (TCP/IP) channel name	<b>H</b>	SOLARIS.OS2.TCP	
<b>Connection to MQSeries for AS/400</b>				
The values in this section of the table must match those used in Table 43 on page 472, as indicated.				
<b>C</b>	Remote queue manager name		AS400	
<b>D</b>	Remote queue name		AS400.REMOTEQ	
<b>E</b>	Queue name at remote system	<b>B</b>	AS400.LOCALQ	
<b>F</b>	Transmission queue name		AS400	
<b>G</b>	Sender (SNA) channel name		OS2.AS400.SNA	
<b>H</b>	Sender (TCP/IP) channel name		OS2.AS400.TCP	
<b>I</b>	Receiver (SNA) channel name	<b>G</b>	AS400.OS2.SNA	
<b>J</b>	Receiver (TCP) channel name	<b>H</b>	AS400.OS2.TCP	
<b>Connection to MQSeries for OS/390 or MVS/ESA without CICS</b>				
The values in this section of the table must match those used in Table 37 on page 406, as indicated.				
<b>C</b>	Remote queue manager name		MVS	
<b>D</b>	Remote queue name		MVS.REMOTEQ	
<b>E</b>	Queue name at remote system	<b>B</b>	MVS.LOCALQ	
<b>F</b>	Transmission queue name		MVS	
<b>G</b>	Sender (SNA) channel name		OS2.MVS.SNA	
<b>H</b>	Sender (TCP) channel name		OS2.MVS.TCP	
<b>I</b>	Receiver (SNA) channel name	<b>G</b>	MVS.OS2.SNA	
<b>J</b>	Receiver (TCP) channel name	<b>H</b>	MVS.OS2.TCP	
<b>Connection to MQSeries for VSE/ESA</b>				
The values in this section of the table must match those used in Table 45 on page 490, as indicated.				

## OS/2 configuration

Table 15. Configuration worksheet for MQSeries for OS/2 Warp (continued)

	Parameter Name	Reference	Example Used	User Value
<b>C</b>	Remote queue manager name		VSE	
<b>D</b>	Remote queue name		VSE.REMOTEQ	
<b>E</b>	Queue name at remote system	<b>B</b>	VSE.LOCALQ	
<b>F</b>	Transmission queue name		VSE	
<b>G</b>	Sender channel name		OS2.VSE.SNA	
<b>I</b>	Receiver channel name	<b>G</b>	VSE.OS2.SNA	

### MQSeries for OS/2 Warp sender-channel definitions using SNA

```
def ql (WINNT)                                     F
  usage(xmitq) +
  replace

def qr (WINNT.REMOTEQ) +                          D
  rname(WINNT.LOCALQ) +                          E
  rqmname(WINNT) +                                C
  xmitq(WINNT) +                                  F
  replace

def chl (OS2.WINNT.SNA) chltype(sdr) +           G
  trptype(lu62) +
  conname('NETID.WINNTLU') +                     13 . 15
  xmitq(WINNT) +                                  F
  modename('#INTER') +                            17
  tpname('MQSERIES') +                           18
  replace
```

### MQSeries for OS/2 Warp receiver-channel definitions using SNA

```
def ql (OS2.LOCALQ) replace                       B

def chl (WINNT.OS2.SNA) chltype(rcvr) +          I
  trptype(lu62) +
  replace
```

### MQSeries for OS/2 Warp sender-channel definitions using TCP

```
def ql (WINNT) +                                  F
  usage(xmitq) +
  replace

def qr (WINNT.REMOTEQ) +                          D
  rname(WINNT.LOCALQ) +                          E
  rqmname(WINNT) +                                C
  xmitq(WINNT) +                                  F
  replace

def chl (OS2.WINNT.TCP) chltype(sdr) +           H
  trptype(tcp) +
  conname(remote_tcpip_hostname) +               F
  xmitq(WINNT) +
  replace
```

### MQSeries for OS/2 Warp receiver-channel definitions using TCP/IP

```
def ql (OS2.LOCALQ) replace                       B

def chl (WINNT.OS2.TCP) chltype(rcvr) +          J
  trptype(tcp) +
  replace
```

## MQSeries for OS/2 Warp sender-channel definitions using NetBIOS

```
def ql (WINNT) + F
  usage(xmitq) +
  replace
```

```
def qr (WINNT.REMOTEQ) + D
  rname(WINNT.LOCALQ) + E
  rqmname(WINNT) + C
  xmitq(WINNT) + F
  replace
```

```
def chl (OS2.WINNT.NET) chltype(sdr) + K
  trptype(netbios) +
  conname(remote NetBIOS name) +
  xmitq(WINNT) + F
  replace
```

## MQSeries for OS/2 Warp receiver-channel definitions using NetBIOS

```
def ql (OS2.LOCALQ) replace B
```

```
def chl (WINNT.OS2.NET) chltype(rcvr) + M
  trptype(netbios) +
  replace
```

## MQSeries for OS/2 Warp sender-channel definitions using IPX/SPX

```
def ql (WINNT) + F
  usage(xmitq) +
  replace
```

```
def qr (WINNT.REMOTEQ) + D
  rname(WINNT.LOCALQ) + E
  rqmname(WINNT) + C
  xmitq(WINNT) + F
  replace
```

```
def chl (OS2.WINNT.SPX) chltype(sdr) + L
  trptype(spx) +
  conname('network.node(socket)') +
  xmitq(WINNT) + F
  replace
```

## MQSeries for OS/2 Warp receiver-channel definitions using IPX/SPX

```
def ql (OS2.LOCALQ) replace B
```

```
def chl (WINNT.OS2.SPX) chltype(rcvr) + N
  trptype(spx) +
  replace
```

## Running channels as processes or threads

MQSeries for OS/2 Warp provides the flexibility to run sender channels as OS/2 processes or OS/2 threads. This is specified in the MCATYPE parameter on the sender channel definition. Each installation should select the type appropriate for their application and configuration. Factors affecting this choice are discussed below.

Most installations will select to run their sender channels as threads, because the virtual and real memory required to support a large number of concurrent channel connections will be reduced. When the MQSeries listener process (started via the

## OS/2 configuration

RUNMQLSR command) exhausts the available private memory needed, an additional listener process will need to be started to support more channel connections. When each channel runs as a process, additional processes are automatically started, avoiding the out-of-memory condition.

If all channels are run as threads under one MQSeries listener, a failure of the listener for any reason will cause all channel connections to be temporarily lost. This can be prevented by balancing the threaded channel connections across two or more listener processes, thus enabling other connections to keep running. If each sender channel is run as a separate process, the failure of the listener for that process will affect only that specific channel connection.

A NetBIOS connection needs a separate process for the Message Channel Agent. Therefore, before you can issue a START CHANNEL command, you must start the channel initiator, or you may start a channel using the RUNMQCHL command.

---

## Chapter 12. Example configuration - IBM MQSeries for Windows NT

This chapter gives an example of how to set up communication links from MQSeries for Windows NT to MQSeries products on the following platforms:

- OS/2
- AIX
- Digital UNIX
- HP-UX
- AT&T GIS UNIX<sup>2</sup>
- Sun Solaris
- OS/400
- OS/390 or MVS/ESA without CICS
- VSE/ESA

This chapter first describes the parameters needed for an LU 6.2 connection, then it guides you through the following tasks:

- “Establishing an LU 6.2 connection” on page 174
- “Establishing a TCP connection” on page 181
- “Establishing a NetBIOS connection” on page 181
- “Establishing an SPX connection” on page 182

Once the connection is established, you need to define some channels to complete the configuration. This is described in “MQSeries for Windows NT configuration” on page 184.

See “Chapter 7. Example configuration chapters in this book” on page 97 for background information about this chapter and how to use it.

---

### Configuration parameters for an LU 6.2 connection

Table 16 on page 170 presents a worksheet listing all the parameters needed to set up communication from Windows NT to one of the other MQSeries platforms. The worksheet shows examples of the parameters, which have been tested in a working environment, and leaves space for you to fill in your own values. An explanation of the parameter names follows the worksheet. Use the worksheet in this chapter in conjunction with the worksheet in the chapter for the platform to which you are connecting.

The steps required to set up an LU 6.2 connection are described, with numbered cross references to the parameters on the worksheet. These steps are:

- “Configuring the local node” on page 174
- “Adding a connection” on page 176
- “Adding a partner” on page 178
- “Adding a CPI-C entry” on page 179
- “Configuring an invocable TP” on page 179

---

2. This platform has become NCR UNIX SVR4 MP-RAS, R3.0

## Windows NT and LU 6.2

### Configuration worksheet

Use this worksheet to record the values you use for your configuration. Where numbers appear in the Reference column they indicate that the value must match that in the appropriate worksheet elsewhere in this book. The examples that follow in this chapter refer back to the values in the ID column. The entries in the Parameter Name column are explained in “Explanation of terms” on page 172.

Table 16. Configuration worksheet for IBM Communications Server for Windows NT

ID	Parameter Name	Reference	Example Used	User Value
<b>Definition for local node</b>				
<b>1</b>	Configuration name		NTCONFIG	
<b>2</b>	Network Name		NETID	
<b>3</b>	Control Point Name		WINNTCP	
<b>4</b>	Local Node ID (hex)		05D 30F65	
<b>5</b>	LU Name (local)		WINNTLU	
<b>6</b>	LU Alias (local)		NTQMGR	
<b>7</b>	TP Name		MQSERIES	
<b>8</b>	Command line		c:\mqm\bin\amqcrs6a.exe	
<b>9</b>	LAN adapter address		08005AA5FAB9	
<b>Connection to an OS/2 system</b>				
The values in this section of the table must match those used in Table 14 on page 138, as indicated.				
<b>10</b>	Connection		OS2	
<b>11</b>	Remote Network Address	<b>10</b>	10005AFC5D83	
<b>12</b>	Network Name	<b>2</b>	NETID	
<b>13</b>	Control Point Name	<b>3</b>	OS2PU	
<b>14</b>	Remote Node ID	<b>4</b>	05D 12345	
<b>15</b>	LU Alias (remote)		OS2QMGR	
<b>16</b>	LU Name	<b>6</b>	OS2LU	
<b>17</b>	Mode	<b>17</b>	#INTER	
<b>18</b>	CPI-C Name		OS2CPIC	
<b>19</b>	Partner TP Name	<b>8</b>	MQSERIES	
<b>Connection to an AIX system</b>				
The values in this section of the table must match those used in Table 20 on page 197, as indicated.				
<b>10</b>	Connection		AIX	
<b>11</b>	Remote Network Address	<b>8</b>	123456789012	
<b>12</b>	Network Name	<b>1</b>	NETID	
<b>13</b>	Control Point Name	<b>2</b>	AIXPU	
<b>14</b>	Remote Node ID	<b>3</b>	071 23456	
<b>15</b>	LU Alias (remote)		AIXQMGR	
<b>16</b>	LU Name	<b>4</b>	AIXLU	
<b>17</b>	Mode	<b>14</b>	#INTER	
<b>18</b>	CPI-C Name		AIXCPIC	
<b>19</b>	Partner TP Name	<b>6</b>	MQSERIES	
<b>Connection to an HP-UX system</b>				
The values in this section of the table must match those used in Table 23 on page 219, as indicated.				
<b>10</b>	Connection		HPUX	
<b>11</b>	Remote Network Address	<b>8</b>	100090DC2C7C	



Table 16. Configuration worksheet for IBM Communications Server for Windows NT (continued)

ID	Parameter Name	Reference	Example Used	User Value
12	Network Name	4	NETID	
13	Control Point Name	2	HPUXPU	
14	Remote Node ID	3	05D 54321	
15	LU Alias (remote)		HPUXQMGR	
16	LU Name	5	HPUXLU	
17	Mode	17	#INTER	
18	CPI-C Name		HPUXCPIC	
19	Partner TP Name	7	MQSERIES	
<b>Connection to an AT&amp;T GIS UNIX system</b>				
The values in this section of the table must match those used in Table 25 on page 243, as indicated.				
10	Connection		GIS	
11	Remote Network Address	8	10007038E86B	
12	Network Name	2	NETID	
13	Control Point Name	3	GISPU	
14	Remote Node ID	9	03E 00018	
15	LU Alias (remote)		GISQMGR	
16	LU Name	4	GISLU	
17	Mode	15	#INTER	
18	CPI-C Name		GISCPIC	
19	Partner TP Name	5	MQSERIES	
<b>Connection to a Sun Solaris system</b>				
The values in this section of the table must match those used in Table 27 on page 257, as indicated.				
10	Connection		SOLARIS	
11	Remote Network Address	5	08002071CC8A	
12	Network Name	2	NETID	
13	Control Point Name	3	SOLARPU	
14	Remote Node ID	6	05D 310D6	
15	LU Alias (remote)		SOLARQMGR	
16	LU Name	7	SOLARLU	
17	Mode	17	#INTER	
18	CPI-C Name		SOLCPIC	
19	Partner TP Name	8	MQSERIES	
<b>Connection to an AS/400 system</b>				
The values in this section of the table must match those used in Table 42 on page 460, as indicated.				
10	Connection		AS400	
11	Remote Network Address	4	10005A5962EF	
12	Network Name	1	NETID	
13	Control Point Name	2	AS400PU	
14	Remote Node ID			
15	LU Alias (remote)		AS400QMGR	
16	LU Name	3	AS400LU	
17	Mode	17	#INTER	
18	CPI-C Name		AS4CPIC	
19	Partner TP Name	8	MQSERIES	

## Windows NT and LU 6.2

Table 16. Configuration worksheet for IBM Communications Server for Windows NT (continued)

ID	Parameter Name	Reference	Example Used	User Value
<b>Connection to an OS/390 or MVS/ESA system without CICS</b>				
The values in this section of the table must match those used in Table 36 on page 396, as indicated.				
<b>10</b>	Connection		MVS	
<b>11</b>	Remote Network Address	<b>8</b>	400074511092	
<b>12</b>	Network Name	<b>2</b>	NETID	
<b>13</b>	Control Point Name	<b>3</b>	MVSPU	
<b>14</b>	Remote Node ID			
<b>15</b>	LU Alias (remote)		MVSQMGR	
<b>16</b>	LU Name	<b>4</b>	MVSLU	
<b>17</b>	Mode	<b>10</b>	#INTER	
<b>18</b>	CPI-C Name		MVSCPIC	
<b>19</b>	Partner TP Name	<b>7</b>	MQSERIES	
<b>Connection to a VSE/ESA system</b>				
The values in this section of the table must match those used in Table 44 on page 485, as indicated.				
<b>10</b>	Connection		MVS	
<b>11</b>	Remote Network Address	<b>5</b>	400074511092	
<b>12</b>	Network Name	<b>1</b>	NETID	
<b>13</b>	Control Point Name	<b>2</b>	VSEPU	
<b>14</b>	Remote Node ID			
<b>15</b>	LU Alias (remote)		VSEQMGR	
<b>16</b>	LU Name	<b>3</b>	VSELU	
<b>17</b>	Mode		#INTER	
<b>18</b>	CPI-C Name		VSECPIC	
<b>19</b>	Partner TP Name	<b>4</b>	MQ01	MQ01

## Explanation of terms

### **1 Configuration Name**

This is the name of the file in which the Communications Server configuration is saved.

### **2 Network Name**

This is the unique ID of the network to which you are connected. It is an alphanumeric value and can be 1-8 characters long. The network name works with the Control Point Name to uniquely identify a system. Your network administrator will tell you the value.

### **3 Control Point Name**

In Advanced Peer-to-Peer® Networking (APPN)®, a control point is responsible for managing a node and its resources. A control point is also a logical unit (LU). The Control Point Name is the name of the LU and is assigned to your system by the network administrator.

### **4 Local Node ID (hex)**

Some SNA products require partner systems to specify a node identifier that uniquely identifies their workstation. The two systems exchange this node identifier in a message unit called the exchange identifier (XID). Your network administrator will assign this ID for you.

**5 LU Name (local)**

A logical unit (LU) is software that serves as an interface or translator between a transaction program and the network. An LU manages the exchange of data between transaction programs. The local LU Name is the name of the LU on your workstation. Your network administrator will assign this to you.

**6 LU Alias (local)**

The name by which your local LU will be known to your applications. You choose this name yourself. It can be 1-8 characters long.

**7 TP Name**

MQSeries applications trying to converse with your workstation specify a symbolic name for the program that is to start running. This will have been defined on the channel definition at the sender. For simplicity, wherever possible use a transaction program name of MQSERIES, or in the case of a connection to VSE/ESA, where the length is limited to 4 bytes, use MQTP.

See Table 12 on page 126 for more information.

**8 Command line**

This is the path and name of the actual program to be run when a conversation has been initiated with your workstation. The example shown on the worksheet assumes that MQSeries is installed in the default directory, c:\mqm. The configuration pairs this name with the symbolic name **7** when you use TPSETUP (which is part of the SNA Server software developers kit).

**9 LAN adapter address**

This is the address of your token-ring card. To discover this type **net config server** at a command prompt. The address appears in the output. For example:

```
Server is active on 08005AA5FAB9
```

**10 Connection**

This is a meaningful symbolic name by which the connection to a partner node is known. It is used only within SNA Server administration and is specified by you.

**15 LU Alias (remote)**

This is a value known only in this server and is used to represent the fully qualified partner LU name. You supply the value.

**17 Mode**

This is the name given to the set of parameters that control the APPC conversation. An entry with this name and a similar set of parameters must be defined at each partner system. Your network administrator will tell you this name.

**18 CPI-C Name**

This is the name given to a locally held definition of a partner application. You supply the name and it must be unique within this server. The name is specified in the CONNAME attribute of the MQSeries sender channel definition.

### Establishing an LU 6.2 connection

This section describes how to establish an LU 6.2 connection using IBM Communications Server for Windows NT, Version 5.0. You may use any of the supported LU 6.2 products for this platform. The panels of other products will not be identical to those shown here, but most of their content will be similar.

#### Configuring the local node

To configure the local node, follow these steps:

1. From the **Scenarios** pull-down of the Communications Server SNA Node Configuration window, select the **CPI-C, APPC or 5250 Emulation** scenario.

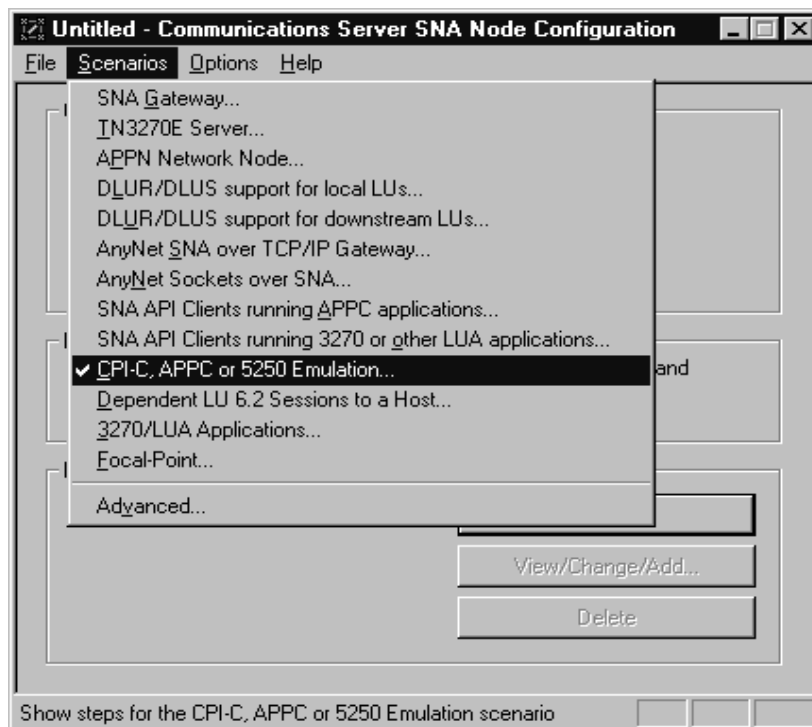

The CPI-C, APPC or 5250 Emulation scenario window is displayed.

2. Click on **Configure Node**, then click on **New**. The Define the Node property sheet is displayed.

The screenshot shows the 'Define the Node' dialog box with the 'Basic' tab selected. The 'Control Point (CP)' section contains a 'Fully qualified CP name' field with 'NETID' and 'WINNTCP' entered, and an empty 'CP alias' field. The 'Local Node ID' section has 'Block ID' set to '05D' and 'Physical Unit ID' set to '00000'. Under 'Node Type', 'End Node' is selected with a radio button, and 'Network Node' is unselected. At the bottom are 'OK', 'Cancel', 'Apply', and 'Help' buttons.

3. In the **Fully qualified CP name** field on the Basic page, enter the unique ID of the network to which you are connected (**2**) and the control point name (**3**). Click on **OK** to continue.
4. From the SNA Node Configuration window, click on **Configure Local LU 6.2**, then click on **New**. The Define a Local LU 6.2 window is displayed.

The screenshot shows the 'Define a Local LU 6.2' dialog box with the 'Basic' tab selected. The 'Local LU name' field contains 'WINNTLU'. There are two unselected checkboxes: 'Dependent LU' and 'SNA API client use'. The 'Local LU alias' field contains 'NTQMGR'. The 'PU name' field is a dropdown menu, currently empty. The 'NAU address' field is a dropdown menu, also empty. The 'LU session limit' field contains '0'. At the bottom are 'OK', 'Cancel', 'Apply', and 'Help' buttons.

## Using IBM Communications Server

5. In the **Local LU name** field on the Basic page, enter the name of the LU on your workstation ( **5** ). In the **Local LU alias** field, enter the name by which your local LU will be known to your applications ( **6** ). Click on **OK** to continue.

## Adding a connection

To add a connection, follow these steps:

1. From the SNA Node Configuration window, select **Configure Devices**, select **LAN** as the DLC type, then click on **New**. The Define a LAN Device property sheet is displayed.

The screenshot shows a dialog box titled "Define a LAN Device" with a close button (X) in the top right corner. It has three tabs: "Basic", "Advanced", and "Performance". The "Basic" tab is active. The "Port name" field contains the text "LAND\_04". Below it, there is a group box containing two fields: "Adapter number" with a dropdown menu showing a network card icon, and "Local SAP" with a dropdown menu showing the value "04". At the bottom of the dialog are four buttons: "OK", "Cancel", "Apply", and "Help".

2. If you have the LLC2 protocol installed with Communications Server for Windows NT, the Adapter number list box lists the available LAN adapters. See the help file INLLC40.HLP (Windows NT 4.0) or INLLC35.HLP (Windows NT 3.51) in the Communications Server installation directory for LLC2 installation instructions.
3. The default values displayed on the Define a LAN Device Basic page may be accepted. Click on **OK** to continue.
4. From the SNA Node Configuration window, select **Configure Connections**, select **LAN** as the DLC type, then click on **New**. The Define a LAN Connection property sheet is displayed.

**Define a LAN Connection**

Basic | Advanced | Security

Link station name: LINK0000

Device name: LAN0\_04

Discover network addresses...

Destination address: 100054FC6D83

Remote SAP: 04

OK Cancel Apply Help

5. In the **Destination address** field on the Basic page, enter the LAN address of the system to which you are connecting ( **11** ). Select the Advanced page.

**Define a LAN Connection**

Basic | Advanced | Security

Activate link at start

HPR support

APPN support

Auto-activate support

Link to preferred NN server

Solicit SSCP sessions

PU name: LINK0000

Local Node ID

Block ID: 05D Physical Unit ID: 12345

OK Cancel Apply Help

6. In the **Block ID** field on the Advanced page, enter the local node ID (hex) ( **4** ). Select the Security page.

## Using IBM Communications Server

The screenshot shows the 'Define a LAN Connection' dialog box with the 'Security' tab selected. The 'Adjacent CP name' field contains 'NETID' and 'OS2PU'. The 'Adjacent CP type' dropdown is set to 'APPN Node'. The 'TG number' dropdown is set to '0'. The 'Adjacent node ID' section contains two empty fields for 'Block ID' and 'Physical Unit ID'. At the bottom are buttons for 'OK', 'Cancel', 'Apply', and 'Help'.

7. In the **Adjacent CP name** field on the Security page, enter the network name and control point name of the remote node ( **12** and **13** ). In the **Adjacent CP type** field, enter APPN Node. You do not need to complete the **Adjacent node ID** field for a peer-to-peer connection. Click on **OK** to continue. Take note of the default link name used to identify this new definition (for example, LINK0000).

## Adding a partner

To add a partner LU definition, follow these steps:

1. From the SNA Node Configuration window, select **Configure Partner LU 6.2**, then click on **New**. The Define a Partner LU 6.2 property sheet is displayed.

The screenshot shows the 'Define a Partner LU 6.2' dialog box with the 'Basic' tab selected. The 'Partner LU name' field contains 'NETID' and 'OS2LU'. The 'Partner LU alias' field contains 'OS2QMGR'. The 'Fully qualified CP name' field contains 'NETID' and 'OS2PU'. At the bottom are buttons for 'OK', 'Cancel', 'Apply', and 'Help'.

2. In the **Partner LU name** field on the Basic page, enter the network name ( **12** ) and LU name of the remote system ( **16** ). In the **Partner LU alias** field, enter the remote LU alias ( **15** ). In the **Fully qualified CP name** fields, enter the network name and control point name of the remote system ( **12** and **13** ). Click on **OK** to continue.



## Adding a CPI-C entry

To add a CPI-C Side information entry, follow these steps:

1. From the SNA Node Configuration window, select **Configure CPI-C Side Information**, then click on **New**. The Define a CPI-C Side Information property sheet is displayed.

The screenshot shows the 'Define CPI-C Side Information' dialog box with the following fields and values:

- Symbolic destination name:** OS2CPIC
- Mode name:** #INTER
- Use partner LU name:**  (unchecked)
- Partner LU name:** [ ] . [ ]
- Use partner LU alias:**  (checked)
- Partner LU alias:** OS2QMGR
- TP name:** MQSERIES
- Service TP:**  (unchecked)

Buttons at the bottom: OK, Cancel, Apply, Help.

2. In the **Symbolic destination name** field of the Basic page, enter the CPI-C name ( **18** ). In the **Mode name** field, enter the mode value ( **17** ). Enter either a **fully qualified partner LU name** ( **12 . 16** ) or a **partner LU alias** ( **15** ) depending on what you choose in the CPI-C Side Information property sheet. In the **TP name** field, enter the partner TP name ( **19** ). Click on **OK** to continue.

## Configuring an invokable TP

To add a Transaction Program (TP) definition, follow these steps:

1. From the SNA Node Configuration window, select **Configure Transaction Programs**, then click on **New**. The Define a Transaction Program property sheet is displayed.

## Using IBM Communications Server

The screenshot shows a dialog box titled "Define a Transaction Program" with a close button (X) in the top right corner. It has two tabs: "Basic" (selected) and "Advanced". The "Basic" tab contains the following fields and options:

- TP name:** A text box containing "MQSERIES".
- Service TP:** An unchecked checkbox.
- Complete pathname:** A text box containing "c:\mwm\bin\amqcr6a.exe".
- Program parameters:** An empty text box.
- Conversation type:** A dropdown menu with "Either" selected.
- Synchronization level:** A dropdown menu with "Any" selected.
- Conversation security required:** A checked checkbox.

At the bottom of the dialog box are four buttons: "OK", "Cancel", "Apply", and "Help".

2. In the **TP name** field on the Basic page, enter the transaction program name ( **7** ). In the **Complete pathname** field, enter the actual path and name of the the program that will be run when a conversation is initiated with your workstation ( **8** ). When you are happy with the settings, click on **OK** to continue.
3. In order to be able to stop the MQSeries Transaction Program, you need to start it in one of the following ways:
  - a. Check **Service TP** on the Basic page. This starts the TP programs at Windows NT startup and will run the programs under the system user ID.
  - b. Check **Dynamically loaded** on the Advanced page. This dynamically loads and starts the programs as and when incoming SNA conversation requests arrive. It will run the programs under the same user ID as the rest of MQSeries.

**Note:** To use dynamic loading, it is necessary to vary the user ID under which the MQSeries SNA Transaction program runs. To do this, set the Attach Manager to run under the desired user context by modifying the startup parameters within the Control Panel in the Services applet for the AppnNode service.

- c. Issue the MQSeries command, runmqslr, to run the channel listener process.

Communications Server has a tuning parameter called the Receive\_Allocate timeout parameter that is set in the Transaction Program. The default value of this parameter is 3600 and this indicates that the listener will only remain active for 3600 seconds, that is, 1 hour. You can make your listener run for longer than this by increasing the value of the Receive\_Allocate timeout parameter. You can also make it run 'forever' by specifying zero.

## What next?

The SNA configuration task is complete. From the **File** pull-down, select **Save** and specify a file name under which to save your SNA configuration information, for example, NTCONFIG ( **1** ). When prompted, select this configuration as the default.

From the SNA Node Operations application, start the node by clicking the **Start node** button on the toolbar. Specify the file name of the configuration you just saved. (It should appear in the file-name box by default, because you identified it as your default configuration.) When the node startup is complete, ensure that your link to the remote node has been established by selecting the **Connections** button on the toolbar, then find the link name you configured (for example, LINK0000). The link should be active if the remote node is active waiting for the link to be established.

A complementary SNA setup process is required on the node to which you are connecting before you can attempt MQSeries server-to-server message transmissions.

The LU 6.2 connection is now established. You are ready to complete the configuration. Go to “MQSeries for Windows NT configuration” on page 184.

## Establishing a TCP connection

The TCP stack that is shipped with Windows NT does not include an *inet* daemon or equivalent.

The MQSeries command used to start a TCP listener is:

```
runmq1sr -t tcp
```

The listener must be started explicitly before any channels are started.

## What next?

When the TCP/IP connection is established, you are ready to complete the configuration. Go to “MQSeries for Windows NT configuration” on page 184.

## Establishing a NetBIOS connection

A NetBIOS connection is initiated from a queue manager that uses the `ConnectionName` parameter on its channel definition to connect to a target listener. To set up a NetBIOS connection, follow these steps:

1. At each end of the channel specify the local NetBIOS name to be used by the MQSeries channel processes, in the Windows NT registry or in the queue manager configuration file `qm.ini`. For example, the NETBIOS stanza in the Windows NT registry at the sending end might look like this:

```
NETBIOS:
LocalName=WNTNETB1
```

and at the receiving end:

```
NETBIOS:
LocalName=WNTNETB2
```

Each MQSeries process must use a different local NetBIOS name. Do not use your machine name as the NetBIOS name because Windows NT already uses it.

## Windows NT and NetBIOS

- At each end of the channel, verify the LAN adapter number being used on your system. The MQSeries for Windows NT default for logical adapter number 0 is NetBIOS running over a TCP/IP network. To use native NetBIOS you need to select logical adapter number 1. See “Establishing the LAN adapter number” on page 130.

Specify the correct LAN adapter number in the NETBIOS stanza of the the Windows NT registry. For example:

```
NETBIOS:  
AdapterNum=1
```

- So that sender channel initiation will work, specify the local NetBIOS name via the MQNAME environment variable:

```
SET MQNAME=WNTNETB1I
```

This name must be unique.

- At the sending end, define a channel specifying the NetBIOS name being used at the other end of the channel. For example:

```
DEFINE CHANNEL (WINNT.OS2.NET) CHLTYPE(SDR) +  
TRPTYPE(NETBIOS) +  
CONNNAME(WNTNETB2) +  
XMITQ(OS2) +  
MCATYPE(THREAD) +  
REPLACE
```

You must specify the option MCATYPE(THREAD) because, on Windows NT, sender channels must be run as threads.

- At the receiving end, define the corresponding receiver channel. For example:

```
DEFINE CHANNEL (WINNT.OS2.NET) CHLTYPE(RCVR) +  
TRPTYPE(NETBIOS) +  
REPLACE
```

- Start the channel initiator because each new channel is started as a thread rather than as a new process.

```
runmqchi
```

- At the receiving end, start the MQSeries listener:

```
runmqlsr -t netbios
```

Optionally you may specify values for the queue manager name, NetBIOS local name, number of sessions, number of names, and number of commands. See “Defining a NetBIOS connection” on page 128 for more information about setting up NetBIOS connections.

---

## Establishing an SPX connection

This section discusses the following topics:

- IPX/SPX parameters
- SPX addressing
- Receiving on SPX

### IPX/SPX parameters

Please refer to the Microsoft documentation for full details of the use and setting of the NWLink IPX and SPX parameters. The IPX/SPX parameters are in the following paths in the registry:

```
HKEY_LOCAL_MACHINE\SYSTEM\CurrentControlSet\Service\NWLinkSPX\Parameters  
HKEY_LOCAL_MACHINE\SYSTEM\CurrentControlSet\Service\NWLinkIPX\Parameters
```

## SPX addressing

MQSeries uses the SPX address of each machine to establish connectivity. The SPX address is specified in the following form:

```
network.node(socket)
```

where

*network*

Is the 4-byte network address of the network on which the remote machine resides,

*node* Is the 6-byte node address, which is the LAN address of the LAN adapter in the remote machine

*socket* Is the 2-byte socket number on which the remote machine will listen.

The default socket number used by MQSeries is 5E86. You can change the default socket number by specifying it in the the Windows NT registry or in the queue manager configuration file `qm.ini`. If you have taken the default options for installation, the `qm.ini` file for queue manager OS2 is found in `c:\mqm\qmgs\os2`. The lines in the Windows NT registry might read:

```
SPX:
  SOCKET=n
```

For more information about values you can set in `qm.ini`, see “Appendix D. Configuration file stanzas for distributed queuing” on page 637.

The SPX address is later specified in the `CONNNAME` parameter of the sender channel definition. If the MQSeries systems being connected reside on the same network, the network address need not be specified. Similarly, if the remote system is listening on the default socket number (5E86), it need not be specified. A fully qualified SPX address in the `CONNNAME` parameter would be:

```
CONNNAME('network.node(socket)')
```

but if the systems reside on the same network and the default socket number is used, the parameter would be:

```
CONNNAME(node)
```

A detailed example of the channel configuration parameters is given in “MQSeries for Windows NT configuration” on page 184.

## Receiving on SPX

Receiving channel programs are started in response to a startup request from the sending channel. To do this, a listener program has to be started to detect incoming network requests and start the associated channel.

You should use the MQSeries listener.

### Using the MQSeries listener

To run the Listener supplied with MQSeries, that starts new channels as threads, use the `RUNMQLSR` command. For example:

```
RUNMQLSR -t spx
```

Optionally you may specify the queue manager name or the socket number if you are not using the defaults.

### MQSeries for Windows NT configuration

#### Notes:

1. You can use the sample program, AMQSBCG, to display the contents and headers of all the messages in a queue. For example:

```
AMQSBCG q_name qmgr_name
```

displays the contents of the queue *q\_name* defined in queue manager *qmgr\_name*.

Alternatively, you can use the message browser in the MQSeries Explorer.

2. The MQSeries command used to start the TCP/IP listener is:

```
runmqtsr -t tcp
```

The listener enables receiver channels to start automatically in response to a start request from an inbound sender channel.

3. You can start any channel from the command prompt using the command  

```
runmqchl -c channel.name
```
4. Error logs can be found in the directories `\mqm\qmgrs\qmgrname\errors` and `\mqm\qmgrs\@system\errors`. In both cases, the most recent messages are at the end of `amqerr01.log`.
5. When you are using the command interpreter **runmqsc** to enter administration commands, a + at the end of a line indicates that the next line is a continuation. Ensure that there is a space between the last parameter and the continuation character.

### Default configuration

You can create a default configuration by using either the First Steps application or the MQSeries Postcard application to guide you through the process. For information about this, see the *MQSeries System Administration* book.

### Basic configuration

You can create and start a queue manager from the MQSeries Explorer or from the command prompt.

If you choose the command prompt:

1. Create the queue manager using the command:

```
crtmqm -u dlqname -q winnt
```

where:

*winnt* Is the name of the queue manager

**-q** Indicates that this is to become the default queue manager

**-u dlqname**

Specifies the name of the undeliverable message queue

This command creates a queue manager and a set of default objects.

2. Start the queue manager using the command:

```
strmqm winnt
```

where *winnt* is the name given to the queue manager when it was created.

## Channel configuration

The following sections detail the configuration to be performed on the Windows NT queue manager to implement the channel described in Figure 32 on page 97.

In each case the MQSC command is shown. Either start **runmqsc** from a command prompt and enter each command in turn, or build the commands into a command file.

Examples are given for connecting MQSeries for Windows NT and MQSeries for OS/2 Warp. If you wish to connect to another MQSeries product use the appropriate set of values from the table in place of those for OS/2.

**Note:** The words in **bold** are user-specified and reflect the names of MQSeries objects used throughout these examples. If you change the names used here, ensure that you also change the other references made to these objects throughout this book. All others are keywords and should be entered as shown.

Table 17. Configuration worksheet for MQSeries for Windows NT

	Parameter Name	Reference	Example Used	User Value
<b>Definition for local node</b>				
<b>A</b>	Queue Manager Name		WINNT	
<b>B</b>	Local queue name		WINNT.LOCALQ	
<b>Connection to MQSeries for OS/2 Warp</b>				
The values in this section of the table must match those used in Table 15 on page 164, as indicated.				
<b>C</b>	Remote queue manager name	<b>A</b>	OS2	
<b>D</b>	Remote queue name		OS2.REMOTEQ	
<b>E</b>	Queue name at remote system	<b>B</b>	OS2.LOCALQ	
<b>F</b>	Transmission queue name		OS2	
<b>G</b>	Sender (SNA) channel name		WINNT.OS2.SNA	
<b>H</b>	Sender (TCP/IP) channel name		WINNT.OS2.TCP	
<b>I</b>	Receiver (SNA) channel name	<b>G</b>	OS2.WINNT.SNA	
<b>J</b>	Receiver (TCP) channel name	<b>H</b>	OS2.WINNT.TCP	
<b>K</b>	Sender (NetBIOS) channel name		WINNT.OS2.NET	
<b>L</b>	Sender (SPX) channel name		WINNT.OS2.SPX	
<b>M</b>	Receiver (NetBIOS) channel name	<b>K</b>	OS2.WINNT.NET	
<b>N</b>	Receiver (SPX) channel name	<b>L</b>	OS2.WINNT.SPX	
<b>Connection to MQSeries for AIX</b>				
The values in this section of the table must match those used in Table 21 on page 211, as indicated.				
<b>C</b>	Remote queue manager name	<b>A</b>	AIX	
<b>D</b>	Remote queue name		AIX.REMOTEQ	
<b>E</b>	Queue name at remote system	<b>B</b>	AIX.LOCALQ	
<b>F</b>	Transmission queue name		AIX	
<b>G</b>	Sender (SNA) channel name		WINNT.AIX.SNA	
<b>H</b>	Sender (TCP) channel name		WINNT.AIX.TCP	
<b>I</b>	Receiver (SNA) channel name	<b>G</b>	AIX.WINNT.SNA	
<b>J</b>	Receiver (TCP) channel name	<b>H</b>	AIX.WINNT.TCP	
<b>Connection to MQSeries for DIGITAL UNIX (Compaq Tru64 UNIX)</b>				
The values in this section of the table must match those used in Table 22 on page 216, as indicated.				

## Windows NT configuration

Table 17. Configuration worksheet for MQSeries for Windows NT (continued)

	Parameter Name	Reference	Example Used	User Value
<b>C</b>	Remote queue manager name	<b>A</b>	DECUX	
<b>D</b>	Remote queue name		DECUX.REMOTEQ	
<b>E</b>	Queue name at remote system	<b>B</b>	DECUX.LOCALQ	
<b>F</b>	Transmission queue name		DECUX	
<b>H</b>	Sender (TCP) channel name		DECUX.WINNT.TCP	
<b>J</b>	Receiver (TCP) channel name	<b>H</b>	WINNT.DECUX.TCP	
<b>Connection to MQSeries for HP-UX</b>				
The values in this section of the table must match those used in Table 24 on page 239, as indicated.				
<b>C</b>	Remote queue manager name	<b>A</b>	HPUX	
<b>D</b>	Remote queue name		HPUX.REMOTEQ	
<b>E</b>	Queue name at remote system	<b>B</b>	HPUX.LOCALQ	
<b>F</b>	Transmission queue name		HPUX	
<b>G</b>	Sender (SNA) channel name		WINNT.HPUX.SNA	
<b>H</b>	Sender (TCP) channel name		WINNT.HPUX.TCP	
<b>I</b>	Receiver (SNA) channel name	<b>G</b>	HPUX.WINNT.SNA	
<b>J</b>	Receiver (TCP/IP) channel name	<b>H</b>	HPUX.WINNT.TCP	
<b>Connection to MQSeries for AT&amp;T GIS UNIX</b>				
The values in this section of the table must match those used in Table 26 on page 253, as indicated.				
<b>C</b>	Remote queue manager name	<b>A</b>	GIS	
<b>D</b>	Remote queue name		GIS.REMOTEQ	
<b>E</b>	Queue name at remote system	<b>B</b>	GIS.LOCALQ	
<b>F</b>	Transmission queue name		GIS	
<b>G</b>	Sender (SNA) channel name		WINNT.GIS.SNA	
<b>H</b>	Sender (TCP/IP) channel name		WINNT.GIS.TCP	
<b>I</b>	Receiver (SNA) channel name	<b>G</b>	GIS.WINNT.SNA	
<b>J</b>	Receiver (TCP/IP) channel name	<b>H</b>	GIS.WINNT.TCP	
<b>Connection to MQSeries for Sun Solaris</b>				
The values in this section of the table must match those used in Table 28 on page 272, as indicated.				
<b>C</b>	Remote queue manager name		SOLARIS	
<b>D</b>	Remote queue name		SOLARIS.REMOTEQ	
<b>E</b>	Queue name at remote system	<b>B</b>	SOLARIS.LOCALQ	
<b>F</b>	Transmission queue name		SOLARIS	
<b>G</b>	Sender (SNA) channel name		WINNT.SOLARIS.SNA	
<b>H</b>	Sender (TCP) channel name		WINNT.SOLARIS.TCP	
<b>I</b>	Receiver (SNA) channel name	<b>G</b>	SOLARIS.WINNT.SNA	
<b>J</b>	Receiver (TCP) channel name	<b>H</b>	SOLARIS.WINNT.TCP	
<b>Connection to MQSeries for AS/400</b>				
The values in this section of the table must match those used in Table 43 on page 472, as indicated.				
<b>C</b>	Remote queue manager name		AS400	
<b>D</b>	Remote queue name		AS400.REMOTEQ	
<b>E</b>	Queue name at remote system	<b>B</b>	AS400.LOCALQ	
<b>F</b>	Transmission queue name		AS400	
<b>G</b>	Sender (SNA) channel name		WINNT.AS400.SNA	
<b>H</b>	Sender (TCP) channel name		WINNT.AS400.TCP	



Table 17. Configuration worksheet for MQSeries for Windows NT (continued)

	Parameter Name	Reference	Example Used	User Value
<b>I</b>	Receiver (SNA) channel name	<b>G</b>	AS400.WINNT.SNA	
<b>J</b>	Receiver (TCP) channel name	<b>H</b>	AS400.WINNT.TCP	
<b>Connection to MQSeries for OS/390 or MVS/ESA without CICS</b>				
The values in this section of the table must match those used in Table 37 on page 406, as indicated.				
<b>C</b>	Remote queue manager name		MVS	
<b>D</b>	Remote queue name		MVS.REMOTEQ	
<b>E</b>	Queue name at remote system	<b>B</b>	MVS.LOCALQ	
<b>F</b>	Transmission queue name		MVS	
<b>G</b>	Sender (SNA) channel name		WINNT.MVS.SNA	
<b>H</b>	Sender (TCP) channel name		WINNT.MVS.TCP	
<b>I</b>	Receiver (SNA) channel name	<b>G</b>	MVS.WINNT.SNA	
<b>J</b>	Receiver (TCP/IP) channel name	<b>H</b>	MVS.WINNT.TCP	
<b>Connection to MQSeries for VSE/ESA</b>				
The values in this section of the table must match those used in Table 45 on page 490, as indicated.				
<b>C</b>	Remote queue manager name		VSE	
<b>D</b>	Remote queue name		VSE.REMOTEQ	
<b>E</b>	Queue name at remote system	<b>B</b>	VSE.LOCALQ	
<b>F</b>	Transmission queue name		VSE	
<b>G</b>	Sender channel name		WINNT.VSE.SNA	
<b>I</b>	Receiver channel name	<b>G</b>	VSE.WINNT.SNA	

**MQSeries for Windows NT sender-channel definitions using SNA**

```
def ql (OS2) + F
    usage(xmitq) +
    replace

def qr (OS2.REMOTEQ) + D
    rname(OS2.LOCALQ) + E
    rqmname(OS2) + C
    xmitq(OS2) + F
    replace

def chl (WINNT.OS2.SNA) chltype(sdr) + G
    trptype(lu62) +
    conname(OS2CPIC) + 18
    xmitq(OS2) + F
    replace
```

**MQSeries for Windows NT receiver-channel definitions using SNA**

```
def ql (WINNT.LOCALQ) replace B

def chl (OS2.WINNT.SNA) chltype(rcvr) + I
    trptype(lu62) +
    replace
```

## Windows NT configuration

### MQSeries for Windows NT sender-channel definitions using TCP/IP

```
def ql (OS2) +                                     F  
    usage(xmitq) +  
    replace
```

```
def qr (OS2.REMOTEQ) +                             D  
    rname(OS2.LOCALQ) +                             E  
    rqmname(OS2) +                                  C  
    xmitq(OS2) +                                     F  
    replace
```

```
def chl (WINNT.OS2.TCP) chltype(sdr) +             H  
    trptype(tcp) +  
    conname(remote_tcpip_hostname) +  
    xmitq(OS2) +                                     F  
    replace
```

### MQSeries for Windows NT receiver-channel definitions using TCP

```
def ql (WINNT.LOCALQ) replace                       B
```

```
def chl (OS2.WINNT.TCP) chltype(rcvr) +           J  
    trptype(tcp) +  
    replace
```

### MQSeries for Windows NT sender-channel definitions using NetBIOS

```
def ql (OS2) +                                     F  
    usage(xmitq) +  
    replace
```

```
def qr (OS2.REMOTEQ) +                             D  
    rname(OS2.LOCALQ) +                             E  
    rqmname(OS2) +                                  C  
    xmitq(OS2) +                                     F  
    replace
```

```
def chl (WINNT.OS2.NET) chltype(sdr) +           K  
    trptype(netbios) +  
    conname(remote_system_NetBIOS_name) +  
    xmitq(OS2) +                                     F  
    replace
```

### MQSeries for Windows NT receiver-channel definitions using NetBIOS

```
def ql (WINNT.LOCALQ) replace                       B
```

```
def chl (OS2.WINNT.NET) chltype(rcvr) +           M  
    trptype(tcp) +  
    replace
```

### MQSeries for Windows NT sender-channel definitions using SPX

```
def ql (OS2) +                                     F  
    usage(xmitq) +  
    replace
```

```
def qr (OS2.REMOTEQ) +                             D  
    rname(OS2.LOCALQ) +                             E  
    rqmname(OS2) +                                  C  
    xmitq(OS2) +                                     F  
    replace
```

```
def chl (WINNT.OS2.SPX) chltype(sdr) +           L
```

```
trptype(spx) +
conname('network.node(socket)') +
xmitq(OS2) +
replace
```

F

## MQSeries for Windows NT receiver-channel definitions using SPX

```
def ql (WINNT.LOCALQ) replace
```

B

```
def chl (OS2.WINNT.SPX) chltype(rcvr) +
trptype(tcp) +
replace
```

N

## Automatic startup

MQSeries for Windows NT allows you to automate the startup of a queue manager and its channel initiator, channels, listeners, and command servers. Use the IBM MQSeries Services snap-in to define the services for the queue manager. When you have successfully completed testing of your communications setup, set the relevant services to **automatic** within the snap-in. This file can be read by the supplied MQSeries service when the system is started.

For more information about this, see the *MQSeries System Administration* book.

## Running channels as processes or threads

MQSeries for Windows NT provides the flexibility to run sender channels as Windows NT processes or Windows NT threads. This is specified in the MCATYPE parameter on the sender channel definition. Each installation should select the type appropriate for their application and configuration. Factors affecting this choice are discussed below.

Most installations will select to run their sender channels as threads, because the virtual and real memory required to support a large number of concurrent channel connections will be reduced. When the MQSeries listener process (started via the RUNMQLSR command) exhausts the available private memory needed, an additional listener process will need to be started to support more channel connections. When each channel runs as a process, additional processes are automatically started, avoiding the out-of-memory condition.

If all channels are run as threads under one MQSeries listener, a failure of the listener for any reason will cause all channel connections to be temporarily lost. This can be prevented by balancing the threaded channel connections across two or more listener processes, thus enabling other connections to keep running. If each sender channel is run as a separate process, the failure of the listener for that process will affect only that specific channel connection.

A NetBIOS connection needs a separate process for the Message Channel Agent. Therefore, before you can issue a START CHANNEL command, you must start the channel initiator, or you may start a channel using the RUNMQCHL command.

## DQM in distributed platforms

---

## Chapter 13. Setting up communication in UNIX systems

DQM is a remote queuing facility for MQSeries. It provides channel control programs for the queue manager which form the interface to communication links, controllable by the system operator. The channel definitions held by distributed-queuing management use these connections.

When a distributed-queuing management channel is started, it tries to use the connection specified in the channel definition. For this to succeed, it is necessary for the connection to be defined and available. This chapter explains how to do this. You may also find it helpful to refer to the following chapters:

- “Chapter 14. Example configuration - IBM MQSeries for AIX” on page 197
- “Chapter 15. Example configuration - IBM MQSeries for DIGITAL UNIX (Compaq Tru64 UNIX)” on page 215
- “Chapter 16. Example configuration - IBM MQSeries for HP-UX” on page 219
- “Chapter 17. Example configuration - IBM MQSeries for AT&T GIS UNIX Version 2.2” on page 243
- “Chapter 18. Example configuration - IBM MQSeries for Sun Solaris” on page 257

For OS/2 and Windows NT, see “Chapter 10. Setting up communication for OS/2 and Windows NT” on page 123. For Digital OpenVMS, see “Chapter 19. Setting up communication in Digital OpenVMS systems” on page 277. For Tandem NSK, see “Chapter 20. Setting up communication in Tandem NSK” on page 289.

---

### Deciding on a connection

There are three forms of communication for MQSeries on UNIX systems:

- TCP
- LU 6.2
- UDP (MQSeries for AIX only)

Each channel definition must specify one only as the transmission protocol (Transport Type) attribute. One or more protocols may be used by a queue manager.

For MQSeries clients, it may be useful to have alternative channels using different transmission protocols. See the *MQSeries Clients* book.

---

### Defining a TCP connection

The channel definition at the sending end specifies the address of the target. The inetd daemon is configured for the connection at the receiving end.

#### Sending end

Specify the host name, or the TCP address of the target machine, in the Connection Name field of the channel definition. The port to connect to will default to 1414. Port number 1414 is assigned by the Internet Assigned Numbers Authority to MQSeries.

## Defining a TCP connection

To use a port number other than the default, change the connection name field thus:

```
Connection Name REMHOST(1822)
```

where REMHOST is the hostname of the remote machine and 1822 is the port number required. (This must be the port that the listener at the receiving end is listening on.)

Alternatively you can change the port number by specifying it in the queue manager configuration file (qm.ini):

```
TCP:
  Port=1822
```

For more information about the values you set using QM.INI, see “Appendix D. Configuration file stanzas for distributed queuing” on page 637.

## Receiving on TCP

You should use either the TCP/IP listener (INETD) or the MQSeries listener.

### Using the TCP/IP listener

To use INETD to start channels on UNIX, two files must be configured:

1. Add a line in the /etc/services file:

```
MQSeries 1414/tcp
```

where 1414 is the port number required by MQSeries.

**Note:** To edit the /etc/services file, you must be logged in as a superuser or root. You can change this, but it must match the port number specified at the sending end.

2. Add a line in the inetd.conf file to call the program amqcrsta:

```
MQSeries stream tcp nowait mqm /mqmtop/bin/amqcrsta amqcrsta
[-m Queue_Man_Name]
```

The updates are active after inetd has reread the configuration files. To do this, issue the following commands from the root user ID:

- On AIX:  
refresh -s inetd
- On HP-UX:  
inetd -c
- On other UNIX systems:  
kill -1 <process number>

When the listener program started by INETD inherits the locale from INETD, it is possible that the MQMDE will not be honored and will be placed on the queue as message data. To ensure that the MQMDE is honored (merged), you must set the locale correctly. The locale set by INETD may not match that chosen for other locales used by MQSeries processes. To set the locale:

1. Create a shell script which sets the locale environment variables LANG, LC\_COLLATE, LC\_CTYPE, LC\_MONETARY, LC\_NUMERIC, LC\_TIME, and LC\_MESSAGES to the locale used for other MQSeries process.
2. In the same shell script, call the listener program.
3. Modify the inetd.conf file to call your shell script in place of the listener program.

## Defining a TCP connection

It is possible to have more than one queue manager on the server machine. You must add a line to each of the two files, as above, for each of the queue managers. For example:

```
MQSeries1    1414/tcp
MQSeries2    1822/tcp
MQSeries2 stream tcp nowait mqm /mqmtop/bin/amqcrsta amqcrsta -m QM2
```

This avoids error messages being generated if there is a limitation on the number of outstanding connection requests queued at a single TCP port. For information about the number of outstanding connection requests, see “Using the TCP listener backlog option”.

### Using the TCP listener backlog option

When receiving on TCP, a maximum number of outstanding connection requests is set. This can be considered a *backlog* of requests waiting on the TCP port for the listener to accept the request. The default listener backlog values are shown in Table 18.

Table 18. Default outstanding connection requests

Platform	Default listener backlog value
AIX V4.2 or later	100
AIX V4.1	10
HP-UX	20
Sun Solaris	100
All others	5

If the backlog reaches the values shown in Table 18, the TCP/IP connection is rejected and the channel will not be able to start.

For MCA channels, this results in the channel going into a RETRY state and retrying the connection at a later time.

For client connections, the client receives an MQRC\_Q\_MGR\_NOT\_AVAILABLE reason code from MQCONN and should retry the connection at a later time.

However, to avoid this error, you can add an entry in the qm.ini file:

```
TCP:
ListenerBacklog = n
```

This overrides the default maximum number of outstanding requests (see Table 18) for the TCP/IP listener.

**Note:** Some operating systems support a larger value than the default. If necessary, this can be used to avoid reaching the connection limit.

To run the listener with the backlog option switched on, use the RUNMQLSR -B command. For information about the RUNMQLSR command, see the *MQSeries System Administration* book.

### Using the MQSeries listener

To run the listener supplied with MQSeries, which starts new channels as threads, use the runmq1sr command. For example:

```
runmq1sr -t tcp [-m QMNAME] [-p 1822]
```

## Defining a TCP connection

The square brackets indicate optional parameters; QMNAME is not required for the default queue manager, and the port number is not required if you are using the default (1414).

For the best performance, run the MQSeries listener as a trusted application as described in “Running channels and listeners as trusted applications” on page 121. See the *MQSeries Application Programming Guide* for information about trusted applications.

You can stop all MQSeries listeners running on a queue manager that is inactive, using the command:

```
endmq1sr [-m QMNAME]
```

If you do not specify a queue manager name, the default queue manager is assumed.

### Using the TCP/IP SO\_KEEPALIVE option

If you want to use the SO\_KEEPALIVE option (as discussed in “Checking that the other end of the channel is still available” on page 66) you must add the following entry to your queue manager configuration file (QM.INI) or the Windows NT registry:

```
TCP:  
  KeepAlive=yes
```

On some UNIX systems, you can define how long TCP waits before checking that the connection is still available, and how frequently it retries the connection if the first check fails. This is either a kernel tunable parameter, or can be entered at the command line. See the documentation for your UNIX system for more information.

On MQSeries for SINIX and DC/OSx you can set the TCP keepalive parameters by using the `id tune` and `id build` commands to modify the `TCP_KEEPCNT` and `TCP_KEEPI` values for the kernel configuration. The default configuration is to retry 7 times at 7200 second (2 hourly) intervals.

---

## Defining an LU 6.2 connection

SNA must be configured so that an LU 6.2 conversation can be established between the two machines.

See the *Multiplatform APPC Configuration Guide* and the following table for information.

Table 19. Settings on the local UNIX system for a remote queue manager platform

Remote platform	TPNAME	TPPATH
OS/390 or MVS/ESA without CICS	The same as the corresponding TPName in the side information on the remote queue manager.	-
OS/390 or MVS/ESA using CICS	CKRC (sender) CKSV (requester) CKRC (server)	-
OS/400	The same as the compare value in the routing entry on the OS/400 system.	-



## Defining an LU 6.2 connection

Table 19. Settings on the local UNIX system for a remote queue manager platform (continued)

Remote platform	TPNAME	TPPATH
OS/2	As specified in the OS/2 Run Listener command, or defaulted from the OS/2 queue manager configuration file.	<drive>:\mqm\bin\amqcrs6a
UNIX systems	The same as the corresponding TPName in the side information on the remote queue manager.	mqmtop/bin/amqcrs6a
Windows NT	As specified in the Windows NT Run Listener command, or the invokable Transaction Program that was defined using TpSetup on Windows NT.	<drive>:\mqm\bin\amqcrs6a

If you have more than one queue manager on the same machine, ensure that the TPnames in the channel definitions are unique.

### Sending end

- On UNIX systems other than SINIX, and DC/OSx, create a CPI-C side object (symbolic destination) and enter this name in the Connection name field in the channel definition. Also create an LU 6.2 link to the partner.

In the CPI-C side object enter the partner LU name at the receiving machine, the transaction program name and the mode name. For example:

```
Partner LU Name      REMHOST
Remote TP Name       recv
Service Transaction Program no
Mode Name            #INTER
```

On HP-UX, use the APPCLLU environment variable to name the local LU that the sender should use. On Sun Solaris, set the APPC\_LOCAL\_LU environment variable to be the local LU name.

SECURITY PROGRAM is used, where supported by CPI-C, when MQSeries attempts to establish an SNA session.

- On SINIX, create an XSYMDEST entry in SNA configuration file (the TRANSIT KOGS file), for example:

```
XSYMDEST sendMP01,
          RLU      = forties,
          MODE     = MODE1,
          TP       = recvMP01,
          TP-TYP  = USER,
          SEC-TYP  = NONE
```

See the *MQSeries for SINIX and DC/OSx System Management Guide* for more information about the TRANSIT KOGS file.

- On DC/OSx, create an entry in the `/etc/opt/lu62/cpic_cfg` file, for example:  
sendMP01 <local LU name> <remote LU name> <mode name> <remote TP name>

### Receiving on LU 6.2

- On UNIX systems other than SINIX, and DC/OSx, create a listening attachment at the receiving end, an LU 6.2 logical connection profile, and a TPN profile.

## Defining an LU 6.2 connection

In the TPN profile, enter the full path to the executable and the Transaction Program name:

```
Full path to TPN executable  mqmtop/bin/amqcrs6a
Transaction Program name    recv
User ID                     0
```

On systems where you can set the User ID, you should specify a user who is a member of the mqm group. On HP-UX, set the APPCTPN (transaction name) and APPCLLU (local LU name) environment variables (you can use the configuration panels for the invoked transaction program). On Sun Solaris, set the APPC\_LOCAL\_LU environment variable to be the local LU name.

On Sun Solaris, amqcrs6a requires the option `-n tp_name`, where `tp_name` is the TP name on the receiving end of the SNA connection. It is the value of the `tp_path` variable in the SunLink configuration file.

You may need to use a queue manager other than the default queue manager. If so, define a command file that calls:

```
amqcrs6a -m Queue_Man_Name
```

then call the command file. On AIX, this only applies up to version 3.2.5; for later versions, use the TPN profile parameters as follows:

```
Use Command Line Parameters ?    yes
Command Line Parameters          -m Queue_Man_Name
```

- On SINIX, create an XTP entry in the SNA configuration file (the TRANSIT KOGS file), for example:

```
XTP      recvMP01,
          UID          = abcdefgh,
          TYP          = USER,
          PATH         = /home/abcdefgh/recvMP01.sh,
          SECURE       = NO
```

Where `/home/abcdefgh/recvMP01.sh` is a file that contains:

```
#!/bin/sh
#
# script to start the receiving side for the qmgr MP01
#
exec /opt/mqm/bin/amqcrs6a -m <queue manager>
```

See the *MQSeries for SINIX and DC/OSx System Management Guide* for more information about the TRANSIT KOGS file.

- On DC/OSx, add a Transaction Program entry to the SNA configuration file, including the following information:

```
TRANSACTION PROGRAM
  transaction programname (ebcdic): recvMP04
  transaction program execute name:
    'home/abcdefgh/recvMP04.sh
  tp is enabled
  tp supports basic conversations
  tp supports mapped conversations
  tp supports confirm synchronization
  tp supports no synchronization
  no verification is required
  number of pip fields required: 0
  privilege mask (hex): 0
    (no privileges)
```

---

## Chapter 14. Example configuration - IBM MQSeries for AIX

This chapter gives an example of how to set up communication links from MQSeries for AIX to MQSeries products on the following platforms:

- OS/2
- Windows NT
- Digital UNIX
- HP-UX
- AT&T GIS UNIX<sup>3</sup>
- Sun Solaris
- OS/400
- OS/390 or MVS/ESA without CICS
- VSE/ESA

First it describes the parameters needed for an LU 6.2 connection, then it describes “Establishing a TCP connection” on page 209 and “Establishing a UDP connection” on page 209.

Once the connection is established, you need to define some channels to complete the configuration. This is described in “MQSeries for AIX configuration” on page 209.

See “Chapter 7. Example configuration chapters in this book” on page 97 for background information about this chapter and how to use it.

---

### Configuration parameters for an LU 6.2 connection

Table 20 presents a worksheet listing all the parameters needed to set up communication from AIX to one of the other MQSeries platforms. The worksheet shows examples of the parameters, which have been tested in a working environment, and leaves space for you to fill in your own values. An explanation of the parameter names follows the worksheet. Use the worksheet in this chapter in conjunction with the worksheet in the chapter for the platform to which you are connecting.

#### Configuration worksheet

Use the following worksheet to record the values you will use for this configuration. Where numbers appear in the Reference column they indicate that the value must match that in the appropriate worksheet elsewhere in this book. The examples that follow in this chapter refer back to the values in the ID column of this table. The entries in the Parameter Name column are explained in “Explanation of terms” on page 200.

Table 20. Configuration worksheet for Communications Server for AIX

ID	Parameter Name	Reference	Example	User Value
<i>Parameters for local node</i>				
<b>1</b>	Network name		NETID	
<b>2</b>	Control Point name		AIXPU	
<b>3</b>	Node ID		07123456	

---

3. This platform has become NCR UNIX SVR4 MP-RAS, R3.0

## AIX and LU 6.2

Table 20. Configuration worksheet for Communications Server for AIX (continued)

ID	Parameter Name	Reference	Example	User Value
4	Local LU name		AIXLU	
5	Local LU alias		AIXQMGR	
6	TP Name		MQSERIES	
7	Full path to TP executable		usr/lpp/mqm/bin/amqcrs6a	
8	Token-ring adapter address		123456789012	
9	Mode name		#INTER	
<b>Connection to an OS/2 system</b>				
The values in this section of the table must match those used in Table 14 on page 138, as indicated.				
10	Network name	2	NETID	
11	Remote LU name	6	OS2LU	
12	Remote Transaction Program name	8	MQSERIES	
13	LU 6.2 CPI-C Side Information profile name		OS2CPIC	
14	Mode name	17	#INTER	
15	LAN destination address	10	10005AFC5D83	
16	Token-Ring Link Station profile name		OS2PRO	
17	CP name of adjacent node	3	OS2PU	
18	LU 6.2 partner location profile name		OS2LOCPRO	
<b>Connection to a Windows NT system</b>				
The values in this section of the table must match those used in Table 16 on page 170, as indicated.				
10	Network name	2	NETID	
11	Remote LU name	5	WINNTLU	
12	Remote Transaction Program name	7	MQSERIES	
13	LU 6.2 CPI-C Side Information profile name		NTCPIC	
14	Mode name	17	#INTER	
15	LAN destination address	9	08005AA5FAB9	
16	Token-Ring Link Station profile name		NTPRO	
17	CP name of adjacent node	3	WINNTCP	
18	LU 6.2 partner LU profile name		NTLUPRO	
<b>Connection to an HP-UX system</b>				
The values in this section of the table must match those used in Table 23 on page 219, as indicated.				
10	Network name	4	NETID	
11	Remote LU name	5	HPUXLU	
12	Remote Transaction Program name	7	MQSERIES	
13	LU 6.2 CPI-C Side Information profile name		HPUXCPIC	
14	Mode name	6	#INTER	
15	LAN destination address	8	100090DC2C7C	
16	Token-Ring Link Station profile name		HPUXPRO	
17	CP name of adjacent node	2	HPUXPU	
18	LU 6.2 partner LU profile name		HPUXLUPRO	
<b>Connection to an AT&amp;T GIS UNIX system</b>				
The values in this section of the table must match those used in Table 25 on page 243, as indicated.				

Table 20. Configuration worksheet for Communications Server for AIX (continued)

ID	Parameter Name	Reference	Example	User Value
10	Network name	2	NETID	
11	Remote LU name	4	GISLU	
12	Remote Transaction Program name	5	MQSERIES	
13	LU 6.2 CPI-C Side Information profile name		GISCPIC	
14	Mode name	7	#INTER	
15	LAN destination address	8	10007038E86B	
16	Token-Ring Link Station profile name		GISPRO	
17	CP name of adjacent node	3	GISPU	
18	LU 6.2 partner LU profile name		GISLUPRO	
<b>Connection to a Sun Solaris system</b>				
The values in this section of the table must match those used in Table 27 on page 257, as indicated.				
10	Network name	2	NETID	
11	Remote LU name	7	SOLARLU	
12	Remote Transaction Program name	8	MQSERIES	
17	LU 6.2 CPI-C Side Information profile name		SOLCPIC	
14	Mode name	17	#INTER	
5	LAN destination address	5	08002071CC8A	
16	Token-Ring Link Station profile name		SOLPRO	
17	CP name of adjacent node	3	SOLARPU	
18	LU 6.2 partner LU profile name		SOLLUPRO	
<b>Connection to an AS/400 system</b>				
The values in this section of the table must match those used in Table 42 on page 460, as indicated.				
10	Network name	1	NETID	
11	Remote LU name	3	AS400LU	
12	Remote Transaction Program name	8	MQSERIES	
13	LU 6.2 CPI-C Side Information profile name		AS4CPIC	
14	Mode name	17	#INTER	
15	LAN destination address	4	10005A5962EF	
16	Token-Ring Link Station profile name		AS4PRO	
17	CP name of adjacent node	2	AS400PU	
18	LU 6.2 partner LU profile name		AS4LUPRO	
<b>Connection to an OS/390 or MVS/ESA system without CICS</b>				
The values in this section of the table must match those used in Table 36 on page 396, as indicated.				
10	Network name	2	NETID	
11	Remote LU name	3	MVSLU	
12	Remote Transaction Program name	7	MQSERIES	
13	LU 6.2 CPI-C Side Information profile name		MVSCPIC	
14	Mode name	10	#INTER	
15	LAN destination address	8	400074511092	
16	Token-Ring Link Station profile name		MVSPRO	
17	CP name of adjacent node	3	MVSPU	

## AIX and LU 6.2

Table 20. Configuration worksheet for Communications Server for AIX (continued)

ID	Parameter Name	Reference	Example	User Value
<b>18</b>	LU 6.2 partner LU profile name		MVSLUPRO	
<b>Connection to a VSE/ESA system</b>				
The values in this section of the table must match those used in Table 44 on page 485, as indicated.				
<b>10</b>	Network name	<b>1</b>	NETID	
<b>11</b>	Remote LU name	<b>3</b>	VSELU	
<b>12</b>	Remote Transaction Program name	<b>4</b>	MQ01	
<b>13</b>	LU 6.2 CPI-C Side Information profile name		VSECPIC	
<b>14</b>	Mode name		#INTER	
<b>15</b>	LAN destination address	<b>5</b>	400074511092	
<b>16</b>	Token-Ring Link Station profile name		VSEPRO	
<b>17</b>	CP name of adjacent node	<b>2</b>	VSEPU	
<b>18</b>	LU 6.2 partner LU profile name		VSELUPRO	

## Explanation of terms

### **1 Network name**

This is the unique ID of the network to which you are connected. Your network administrator will tell you this value.

### **2 Control Point name**

This is a unique control point name for this workstation. Your network administrator will assign this to you.

### **3 XID node ID**

This is a unique identifier for this workstation. On other platforms it is often referred to as the exchange ID (XID). Your network administrator will assign this to you.

### **4 Local LU name**

A logical unit (LU) manages the exchange of data between systems. The local LU name is the name of the LU on your system. Your network administrator will assign this to you.

### **5 Local LU alias**

The local LU alias is the name by which your local LU is known to your applications. You can choose this name yourself. It need be unique only on this machine.

### **6 TP Name**

MQSeries applications trying to converse with this workstation will specify a symbolic name for the program to be run at the receiving end. This will have been defined on the channel definition at the sender. It is recommended that when AIX is the receiver a Transaction Program Name of MQSERIES is used, or in the case of a connection to VSE/ESA, where the length is limited to 4 bytes, use MQTP.

See Table 19 on page 194 for more information.

### **7 Full path to TP executable**

This is the path and name of a shell script file that invokes the actual program to be run when a conversation is initiated with this workstation. You can choose the path and name of the script file. The contents of the file are illustrated in “MQSeries for AIX TPN setup” on page 213.

**8 Token-ring adapter address**

This is the 12-character hex address of the token-ring card. It can be found by entering the AIX command:

```
lsfg -v -l tokn
```

where n is the number assigned to the token-ring adapter you are using. The **Network Address** field of the Token-Ring section indicates the adapter's address.

**9 Mode name**

This is the name of a configuration profile used by Communications Server for AIX. The profile contains the set of parameters that control the APPC conversation. The mode name specified in the profile will be assigned to you by your network administrator. You supply the name to be used for the profile.

**13 LU 6.2 CPI-C Side Information profile name**

This is a name given to the Side Information profile defining a partner node. You supply the name. It needs to be unique only on this machine. You will later use the name in the MQSeries sender channel definition.

**16 Token-Ring Link Station profile name**

This is the name of a configuration profile used by Communications Server for AIX. You supply the name to be used for the profile. The link station profile associates the link station with the SNA DLC profile, which has been used to define the hardware adapter and link characteristics, and the node control point.

**17 CP name of adjacent node**

This is the unique control point name of the partner system which which you are establishing communication. Your network administrator will assign this to you.

**18 LU 6.2 partner LU profile name**

This is the name of a configuration profile used by Communications Server for AIX. You supply the name to be used for the profile. It needs to be unique only on this machine. The profile defines parameters for establishing a session with a specific partner LU. In some scenarios, this profile may not be required but it is shown here to reduce the likelihood of error. See the *SNA Server for AIX Configuration Reference* manual for details.

## Establishing a session using Communications Server for AIX V5

Verify the level of Communications Server software you have installed by entering the AIX command:

```
lslpp -h sna.rte
```

The level displayed in the response needs to be at least Version 5.0.

To update the SNA configuration profile, you need root authority. (Without root authority you can display options and appear to modify them, but cannot actually make any changes.) You can make configuration changes when SNA is either active or inactive.

The configuration scenario that follows was accomplished using the graphical interface.

**Note:** The setup used is APPN using independent LUs.

If you are an experienced user of AIX, you may choose to circumvent the panels and use the command-line interface. Refer to the *SNA Server for AIX Configuration Reference* manual to see the commands that correspond to the panels illustrated.

Throughout the following example, only the panels for profiles that must be added or updated are shown.

### Configuring your node

This configuration uses a token ring setup. To define the end node to connect to the network node (assuming that a network node already exists), you need to:

1. Click on **Services** from the main menu on the main window.
2. Select **Configuration node parameters ...** from the drop-down list. A windows entitled **Node parameters** appears:

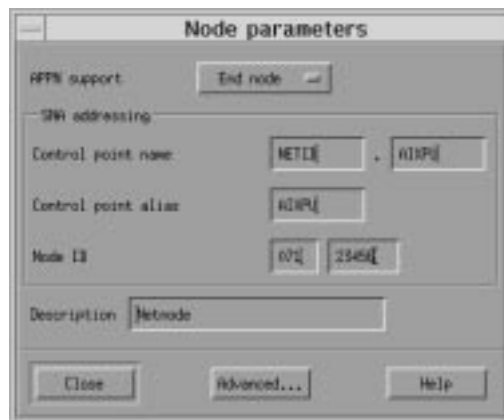

3. Click on **End node for APPN support**.
4. In the **SNA addressing** box, enter a name and alias for the Control point. The Control point name consists of a Network name (**1**) and a Control point name (**2**).
5. Enter the Node ID (**3**) of your local machine.
6. Click on **OK**.

You have now configured your node to connect to the network node.



## Configuring connectivity to the network

1. Defining your port:
  - a. From the main menu of the main window, click on **Services, Connectivity,** and **New port ...** A window entitled **Add to *machine name*** screen appears.
  - b. Select the default card for connecting to the network (**Token ring card**).
  - c. Click on **OK**. A window entitled **Token ring SAP** appears:



- d. Enter a port name in the **SNA port name** box, for example, MQPORT.
- e. Check **Initially Active**.
- f. Click on **OK**.

## Using Communications Server for AIX

2. Defining your connection to the network node:
  - a. From the main menu on the main window, click on **Services, Connectivity, and New link station ...**
  - b. Click on **OK** to link your station to the chosen port (MQPORT). A window entitled **Token ring link station** appears:



- c. Enter a name for your link station ( **4** ), for example, NETNODE.
- d. Enter the port name to which you want to connect the link station. In this case, the port name would be MQPORT.
- e. Check **Any** in the **LU traffic** box.
- f. Define where the remote node is by entering the control point on the network node in the **Independent LU traffic** box. The control point consists of a **Network name** ( **10** ) and a **CP name of adjacent node** ( **17** ).

**Note:** The network node does not have to be on the remote system that you are connecting to.

- g. Ensure the **Remote node type** is **Network node**.
- h. In the **Contact information**, enter the **MAC address** ( **15** ) of the token ring card on the network node.

**Note:** The network node does not have to be on the remote system that you are connecting to.

- i. Click on **Advanced ...**. A window entitled **Token ring parameters** appears:



- j. Check **Remote node is network node server**.
- k. Click on **OK**. The **Token ring link station** window remains on the screen.
- l. Click on **OK** on the **Token ring link station** window.

## Defining a local LU

To define a local LU:

1. From the main menu on the main window, click on **Services, APPC, and New independent local LU ...**. A window entitled **Local LU** appears:



Figure 33. Local LU window

2. Enter an LU name ( **4** ) and alias ( **5** ).
3. Click on **OK**.

You have now set up a basic SNA system.

To define the mode controlling the SNA session limits:

1. From the main menu in the main window, click on **Services, APPC, and Modes ...**. A **Modes** window appears.

## Using Communications Server for AIX

2. Select the **New ...** button. A window entitled **Mode** appears:

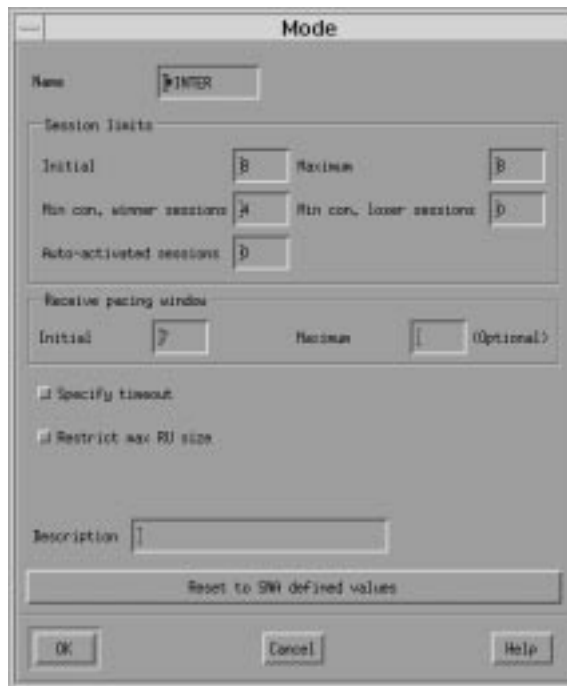

Figure 34. Mode window

3. Enter a **Name** (**9**) for your mode.
4. When you are happy with the session limits, click on **OK**. The **Modes** window remains on the screen.
5. Click on **Done** in the **Modes** window.

## Defining a transaction program

This section describes how to define a transaction program. To do this, use the command line rather than the graphical interface.

1. Defining a transaction program for the receiver end of the channel:
  - a. Name your transaction program (**6**):

```
snaadmin define_tp, tp_name=MQSERIES
```

where MQSERIES can be any name that matches the name used on the CPI-C side information at the sender end of the channel.

- b. Define the program your transaction program (MQSERIES) relates to, that is, the receiving MQSeries channel:

```
snaadmin define_tp_load_info,  
tp_name=MQSERIES, userid=mqm, group=mqm,  
type=NON-QUEUED, style=COMPATIBLE,  
path=/usr/lpp/mqm/bin/amqcrs6a,  
arguments=-m AIX -n MQSERIES
```

where AIX and MQSERIES can be upper or lower case but must be the same throughout.

## Using Communications Server for AIX

- c. View the definition you have just created through the graphical interface:
  - 1) From the main window, click on **Services, APPC, and Transaction programs ...** A window entitled **TP invocation** appears for you to view your configuration:

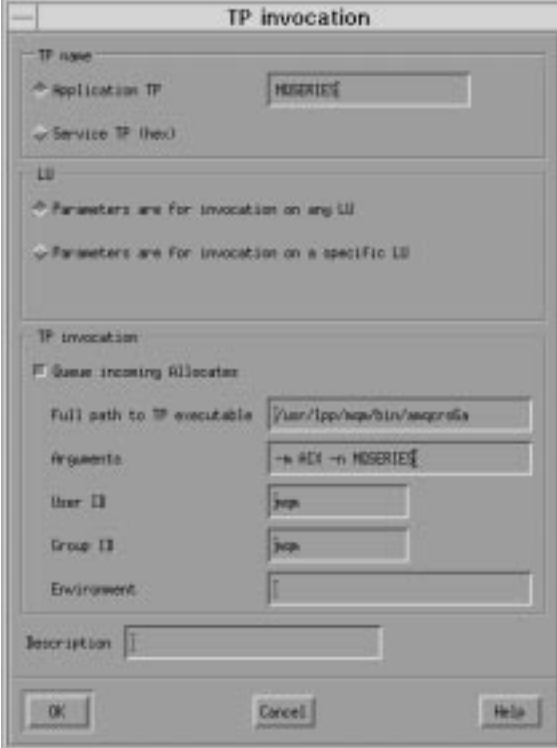

The screenshot shows a graphical user interface window titled "TP invocation". The window is divided into several sections:

- TP name:** Contains a dropdown menu for "Application TP" with "MSERIE" selected, and a disabled "Service TP (hex)" dropdown.
- LI:** Contains two radio buttons: "Parameters are for invocation on any LI" (selected) and "Parameters are for invocation on a specific LI".
- TP invocation:** Contains a checked checkbox "Same incoming Allocates". Below it are several text input fields:
  - "Full path to TP executable" with the value "/usr/lpp/mqs/bin/mqsrofs".
  - "Arguments" with the value "-s RC4 -n MSERIE".
  - "User ID" with the value "jcp".
  - "Group ID" with the value "jcp".
  - "Environment" with an empty field.
- Description:** A text input field at the bottom.
- Buttons:** "OK", "Cancel", and "Help" buttons at the bottom.

- 2) Verify the **Application TP** ( **6** ).
- 3) Verify the **Full path to TP executable** ( **7** ).

## Using Communications Server for AIX

2. Defining the CPI-C side information for the sender channel: You can define the CPI-C side information for the sender channel using the graphical interface:
  - a. From the main menu on the main window, click on **Services, APPC, and CPI-C ... A CPI-C destination names** window appears.
  - b. Click on the **New ...** button. A window entitled **CPI-C destination** appears:

The screenshot shows the 'CPI-C destination' dialog box. The 'Name' field is '052EPD'. Under 'Local LU', 'Specify local LU alias' is selected with 'N1R0R' in the text field. Under 'Partner LU and mode', 'Use PLU full name' is selected with 'NETE' and '052LU' in the respective fields, and 'MODE' in the 'Mode' field. Under 'Partner TP', 'Application TP' is selected with 'R0SERIES' in the text field. The 'Security' section has 'Program strong' selected. There are also 'User ID' and 'Password' fields, and a 'Description' field at the bottom. 'OK', 'Cancel', and 'Help' buttons are at the very bottom.

This window lets you define the LU that you want to connect to and the transaction program you want to start:

- c. Enter a **Name**, ( **13** ). You must specify this name in the CONNAME parameter of the channel.
- d. Check **Specify local LU alias** and enter the **LU alias** value ( **5** ).
- e. In the **Partner LU and mode** box, check **Use PLU full name** and enter the name of the remote machine to which you are connecting. This consists of a **Network name** ( **10** ) and a **Remote LU name** ( **11** ).
- f. Enter the **Mode** ( **14** ).

To start the transaction program on the remote machine:

- a. Check **Application TP** in the **Partner TP** box.
- b. Enter the name of the transaction program ( **12** ).
- c. Click on **OK**.

---

## Establishing a TCP connection

1. Edit the file `/etc/services`.

**Note:** To edit the `/etc/services` file, you must be logged in as a superuser or root. If you do not have the following line in that file, add it as shown:

```
MQSeries      1414/tcp      # MQSeries channel listener
```

2. Edit the file `/etc/inetd.conf`. If you do not have the following line in that file, add it as shown:

```
MQSeries stream tcp nowait root /usr/mqm/bin/amqcrsta amqcrsta
[-m queue.manager.name]
```

3. Enter the command `refresh -s inetd`.

### What next?

The connection is now established. You are ready to complete the configuration. Go to “MQSeries for AIX configuration”.

---

## Establishing a UDP connection

To establish a UDP connection, ensure a listener is started by issuing the following MQSC command:

```
runmqtsr -m QMgrName -t UDP -p 1414
```

#### Notes:

1. You cannot start a listener channel on AIX using the START LISTENER MQSC command.
2. Using the `runmqtsr` command implies that you **must not** add entries to the `/etc/services` and `/etc/inetd.conf` file for UDP on MQSeries for AIX.

### What next?

The connection is now established. You are ready to complete the configuration. Go to “MQSeries for AIX configuration”.

---

## MQSeries for AIX configuration

#### Notes:

1. Before beginning the installation process ensure that you have first created the `mqm` user and group, and set the password.
2. If installation fails as a result of insufficient space in the file system you can increase the size as follows, using the command `smit C sna`. (Use `df` to display the current status of the file system. This will indicate the logical volume that is full.)

```
-- Physical and Logical Storage
-- File Systems
-- Add / Change / Show / Delete File Systems
-- Journalled File Systems
-- Change/Show Characteristics of a Journalled File System
```

3. Start any channel using the command:

```
runmqchl -c channel.name
```

4. Sample programs are installed in `/usr/mqm/samp`.
5. Error logs are stored in `/var/mqm/qmgrs/qmgrname/errors`.
6. You can start an AIX trace of the MQSeries components using the command:

```
trace -a -j30D,30E -o trace.file
```

## AIX configuration

You can stop AIX trace by entering:

```
trcstop
```

Format the trace report using the command:

```
trcrpt -t /usr/mqm/samp/amqtrc.fmt trace.file > trace.report
```

7. When you are using the command interpreter **runmqsc** to enter administration commands, a + at the end of a line indicates that the next line is a continuation. Ensure that there is a space between the last parameter and the continuation character.

## Basic configuration

1. Create the queue manager from the AIX command line using the command:

```
crtmqm -u dlqname -q aix
```

where:

*aix* Is the name of the queue manager

**-q** Indicates that this is to become the default queue manager

**-u** *dlqname*

Specifies the name of the undeliverable message queue

This command creates a queue manager and a set of default objects.

2. Start the queue manager from the AIX command line using the command:

```
strmqm aix
```

where *aix* is the name given to the queue manager when it was created.

3. Start **runmqsc** from the AIX command line and use it to create the undeliverable message queue by entering the command:

```
def ql (dlqname)
```

where *dlqname* is the name given to the undeliverable message queue when the queue manager was created.

## Channel configuration

The following section details the configuration to be performed on the AIX queue manager to implement the channel described in Figure 32 on page 97.

In each case the MQSC command is shown. Either start **runmqsc** from an AIX command line and enter each command in turn, or build the commands into a command file.

Examples are given for connecting MQSeries for AIX and MQSeries for OS/2 Warp. If you wish to connect to another MQSeries product use the appropriate set of values from the table in place of those for OS/2.

**Note:** The words in **bold** are user-specified and reflect the names of MQSeries objects used throughout these examples. If you change the names used here, ensure that you also change the other references made to these objects throughout this book. All others are keywords and should be entered as shown.



Table 21. Configuration worksheet for MQSeries for AIX

ID	Parameter Name	Reference	Example Used	User Value
<b>Definition for local node</b>				
<b>A</b>	Queue Manager Name		AIX	
<b>B</b>	Local queue name		AIX.LOCALQ	
<b>Connection to MQSeries for OS/2 Warp</b>				
The values in this section of the table must match those used in Table 15 on page 164, as indicated.				
<b>C</b>	Remote queue manager name	<b>A</b>	OS2	
<b>D</b>	Remote queue name		OS2.REMOTEQ	
<b>E</b>	Queue name at remote system	<b>B</b>	OS2.LOCALQ	
<b>F</b>	Transmission queue name		OS2	
<b>G</b>	Sender (SNA) channel name		AIX.OS2.SNA	
<b>H</b>	Sender (TCP/IP) channel name		AIX.OS2.TCP	
<b>I</b>	Receiver (SNA) channel name	<b>G</b>	OS2.AIX.SNA	
<b>J</b>	Receiver (TCP/IP) channel name	<b>H</b>	OS2.AIX.TCP	
<b>Connection to MQSeries for Windows NT</b>				
The values in this section of the table must match those used in Table 17 on page 185, as indicated.				
<b>C</b>	Remote queue manager name	<b>A</b>	WINNT	
<b>D</b>	Remote queue name		WINNT.REMOTEQ	
<b>E</b>	Queue name at remote system	<b>B</b>	WINNT.LOCALQ	
<b>F</b>	Transmission queue name		WINNT	
<b>G</b>	Sender (SNA) channel name		AIX.WINNT.SNA	
<b>H</b>	Sender (TCP/IP) channel name		AIX.WINNT.TCP	
<b>I</b>	Receiver (SNA) channel name	<b>G</b>	WINNT.AIX.SNA	
<b>J</b>	Receiver (TCP) channel name	<b>H</b>	WINNT.AIX.TCP	
<b>Connection to MQSeries for DIGITAL UNIX (Compaq Tru64 UNIX)</b>				
The values in this section of the table must match those used in Table 22 on page 216, as indicated.				
<b>C</b>	Remote queue manager name	<b>A</b>	DECUX	
<b>D</b>	Remote queue name		DECUX.REMOTEQ	
<b>E</b>	Queue name at remote system	<b>B</b>	DECUX.LOCALQ	
<b>F</b>	Transmission queue name		DECUX	
<b>H</b>	Sender (TCP) channel name		DECUX.AIX.TCP	
<b>J</b>	Receiver (TCP) channel name	<b>H</b>	AIX.DECUX.TCP	
<b>Connection to MQSeries for HP-UX</b>				
The values in this section of the table must match those used in Table 24 on page 239, as indicated.				
<b>C</b>	Remote queue manager name	<b>A</b>	HPUX	
<b>D</b>	Remote queue name		HPUX.REMOTEQ	
<b>E</b>	Queue name at remote system	<b>B</b>	HPUX.LOCALQ	
<b>F</b>	Transmission queue name		HPUX	
<b>G</b>	Sender (SNA) channel name		AIX.HPUX.SNA	
<b>H</b>	Sender (TCP) channel name		AIX.HPUX.TCP	
<b>I</b>	Receiver (SNA) channel name	<b>G</b>	HPUX.AIX.SNA	
<b>J</b>	Receiver (TCP) channel name	<b>H</b>	HPUX.AIX.TCP	
<b>Connection to MQSeries for AT&amp;T GIS UNIX</b>				
The values in this section of the table must match those used in Table 26 on page 253, as indicated.				

## AIX configuration

Table 21. Configuration worksheet for MQSeries for AIX (continued)

ID	Parameter Name	Reference	Example Used	User Value
<b>C</b>	Remote queue manager name	<b>A</b>	GIS	
<b>D</b>	Remote queue name		GIS.REMOTEQ	
<b>E</b>	Queue name at remote system	<b>B</b>	GIS.LOCALQ	
<b>F</b>	Transmission queue name		GIS	
<b>G</b>	Sender (SNA) channel name		AIX.GIS.SNA	
<b>H</b>	Sender (TCP) channel name		AIX.GIS.TCP	
<b>I</b>	Receiver (SNA) channel name	<b>G</b>	GIS.AIX.SNA	
<b>J</b>	Receiver (TCP/IP) channel name	<b>H</b>	GIS.AIX.TCP	
<b>Connection to MQSeries for Sun Solaris</b>				
The values in this section of the table must match those used in Table 28 on page 272, as indicated.				
<b>C</b>	Remote queue manager name		SOLARIS	
<b>D</b>	Remote queue name		SOLARIS.REMOTEQ	
<b>E</b>	Queue name at remote system	<b>B</b>	SOLARIS.LOCALQ	
<b>F</b>	Transmission queue name		SOLARIS	
<b>G</b>	Sender (SNA) channel name		AIX.SOLARIS.SNA	
<b>H</b>	Sender (TCP/IP) channel name		AIX.SOLARIS.TCP	
<b>I</b>	Receiver (SNA) channel name	<b>G</b>	SOLARIS.AIX.SNA	
<b>J</b>	Receiver (TCP/IP) channel name	<b>H</b>	SOLARIS.AIX.TCP	
<b>Connection to MQSeries for AS/400</b>				
The values in this section of the table must match those used in Table 43 on page 472, as indicated.				
<b>C</b>	Remote queue manager name		AS400	
<b>D</b>	Remote queue name		AS400.REMOTEQ	
<b>E</b>	Queue name at remote system	<b>B</b>	AS400.LOCALQ	
<b>F</b>	Transmission queue name		AS400	
<b>G</b>	Sender (SNA) channel name		AIX.AS400.SNA	
<b>H</b>	Sender (TCP) channel name		AIX.AS400.TCP	
<b>I</b>	Receiver (SNA) channel name	<b>G</b>	AS400.AIX.SNA	
<b>J</b>	Receiver (TCP) channel name	<b>H</b>	AS400.AIX.TCP	
<b>Connection to MQSeries for OS/390 or MVS/ESA without CICS</b>				
The values in this section of the table must match those used in Table 37 on page 406, as indicated.				
<b>C</b>	Remote queue manager name		MVS	
<b>D</b>	Remote queue name		MVS.REMOTEQ	
<b>E</b>	Queue name at remote system	<b>B</b>	MVS.LOCALQ	
<b>F</b>	Transmission queue name		MVS	
<b>G</b>	Sender (SNA) channel name		AIX.MVS.SNA	
<b>H</b>	Sender (TCP) channel name		AIX.MVS.TCP	
<b>I</b>	Receiver (SNA) channel name	<b>G</b>	MVS.AIX.SNA	
<b>J</b>	Receiver (TCP) channel name	<b>H</b>	MVS.AIX.TCP	
<b>Connection to MQSeries for VSE/ESA</b>				
The values in this section of the table must match those used in Table 45 on page 490, as indicated.				
<b>C</b>	Remote queue manager name		VSE	
<b>D</b>	Remote queue name		VSE.REMOTEQ	
<b>E</b>	Queue name at remote system	<b>B</b>	VSE.LOCALQ	
<b>F</b>	Transmission queue name		VSE	

Table 21. Configuration worksheet for MQSeries for AIX (continued)

ID	Parameter Name	Reference	Example Used	User Value
<b>G</b>	Sender channel name		AIX.VSE.SNA	
<b>I</b>	Receiver channel name	<b>G</b>	VSE.AIX.SNA	

### MQSeries for AIX sender-channel definitions using SNA

```
def ql (OS2) + F
  usage(xmitq) +
  replace
```

```
def qr (OS2.REMOTEQ) + D
  rname(OS2.LOCALQ) + E
  rqmname(OS2) + C
  xmitq(OS2) + F
  replace
```

```
def chl (AIX.OS2.SNA) chltype(sdr) + G
  trptype(lu62) +
  conname('OS2CPIC') + 17
  xmitq(OS2) + F
  replace
```

### MQSeries for AIX receiver-channel definitions using SNA

```
def ql (AIX.LOCALQ) replace B
```

```
def chl (OS2.AIX.SNA) chltype(rcvr) + I
  trptype(lu62) +
  replace
```

### MQSeries for AIX TPN setup

During the AIX Communications Server configuration process, an LU 6.2 TPN profile was created, which contained the full path to a TP executable. In the example the file was called `u/interops/AIX.crs6a`. You can choose a name, but you are recommended to include the name of your queue manager in it. The contents of the executable file must be:

```
#!/bin/sh
/opt/mqm/bin/amqcrs6a -m aix
```

where `aix` is the queue manager name (**A**). After creating this file, enable it for execution by running the command:

```
chmod 755 /u/interops/AIX.crs6a
```

As an alternative to creating an executable file, you can specify the path on the Add LU 6.2 TPN Profile panel, using command line parameters.

Specifying a path in one of these two ways ensures that SNA receiver channels activate correctly when a sender channel initiates a conversation.

### MQSeries for AIX sender-channel definitions using TCP

```
def ql (OS2) + F
  usage(xmitq) +
  replace
```

```
def qr (OS2.REMOTEQ) + D
  rname(OS2.LOCALQ) + E
  rqmname(OS2) + C
  xmitq(OS2) + F
  replace
```

## AIX configuration

```
def chl (AIX.OS2.TCP) chltype(sdr) + H  
  trptype(tcp) +  
  conname(remote_tcpip_hostname) + F  
  xmitq(OS2) +  
  replace
```

### MQSeries for AIX receiver-channel definitions using TCP

```
def ql (AIX.LOCALQ) replace B
```

```
def chl (OS2.AIX.TCP) chltype(rcvr) + J  
  trptype(tcp) +  
  replace
```

### MQSeries for AIX sender-channel definitions using UDP

```
def ql (OS2) + F  
  usage(xmitq) +  
  replace
```

```
def qr (OS2.REMOTEQ) + D  
  rname(OS2.LOCALQ) + E  
  rqmname(OS2) + C  
  xmitq(OS2) + F  
  replace
```

```
def chl (AIX.OS2.UDP) chltype(sdr) + H  
  trptype(udp) +  
  conname(remote_udpip_hostname) + F  
  xmitq(OS2) +  
  replace
```

### MQSeries for AIX receiver-channel definitions using UDP

```
def ql (AIX.LOCALQ) replace B
```

```
def chl (OS2.AIX.UDP) chltype(rcvr) + J  
  trptype(udp) +  
  replace
```

---

## Chapter 15. Example configuration - IBM MQSeries for DIGITAL UNIX (Compaq Tru64 UNIX)

This chapter shows how to set up TCP communication links from MQSeries for DIGITAL UNIX (Compaq Tru64 UNIX) to MQSeries products on other platforms.

**Note:** MQSeries for DIGITAL UNIX (Compaq Tru64 UNIX), V2.2.1 supports the TCP communication protocol only.

Once the connection is established, you need to define some channels to complete the configuration. This process is described in “MQSeries for DIGITAL UNIX (Compaq Tru64 UNIX) configuration”.

See “Chapter 7. Example configuration chapters in this book” on page 97 for background information about this chapter and how to use it.

---

### Establishing a TCP connection

1. Edit the file `/etc/services`.

**Note:** To edit the `/etc/services` file, you must be logged in as a superuser or root. If you do not have the following line in that file, add it as shown:

```
MQSeries      1414/tcp      # MQSeries channel listener
```

2. Edit the file `/etc/inetd.conf`. If you do not have the following line in that file, add it as shown:

```
MQSeries stream tcp nowait root /opt/mqm/bin/amqcrsta amqcrsta  
[-m queue.manager.name]
```

3. Find the process ID of the `inetd` with the command:

```
ps -ef | grep inetd
```

4. Run the command:

```
kill -1 inetd processid
```

### What next?

Inetd is now ready to listen for incoming requests and pass them to MQSeries. You are ready to complete the configuration as described in the next section.

---

### MQSeries for DIGITAL UNIX (Compaq Tru64 UNIX) configuration

Before beginning the installation process ensure that you have first created the `mqm` user and group, and set the password.

Start any channel using the command:

```
runmqchl -c channel.name -m qmname
```

**Notes:**

1. Sample programs are installed in `/opt/mqm/samp`.
2. Error logs are stored in `/var/mqm/qmgrs/qmname/errors`.

## Digital UNIX configuration

- When you are using the command interpreter **runmqsc** to enter administration commands, a + at the end of a line indicates that the next line is a continuation. Ensure that there is a space between the last parameter and the continuation character.

## Basic configuration

- Create the queue manager from the UNIX prompt using the command:

```
crtmqm -u dlqname -q qmname
```

where:

*qmname* Is the name of the queue manager

**-q** Indicates that this is to become the default queue manager

**-u dlqname**

Specifies the name of the undeliverable message queue

This command creates a queue manager and sets the DEADQ attribute of the queue manager, but does not create the undeliverable message queue.

- Start the queue manager from the UNIX prompt using the command:

```
strmqm qmname
```

where *qmname* is the name given to the queue manager when it was created.

## Channel configuration

This section describes the configuration to be performed on the Digital UNIX queue manager to implement the single channel, and the MQSeries objects associated with it.

Examples are given at the end of this chapter for connecting MQSeries for DIGITAL UNIX (Compaq Tru64 UNIX) and MQSeries for OS/2 Warp. If you wish to connect to another MQSeries product use the appropriate set of values from the table in place of those for OS/2.

In each example, the MQSC command is shown. Either start **runmqsc** from a UNIX prompt and enter each command in turn, or build the commands into a command file.

**Note:** The words in **bold** are user-specified and reflect the names of MQSeries objects used throughout these examples. All others are keywords and should be entered as shown.

Table 22. Configuration worksheet for MQSeries for DIGITAL UNIX (Compaq Tru64 UNIX)

ID	Parameter Name	Reference	Example Used	User Value
<b>Definition for local node</b>				
<b>A</b>	Queue Manager Name		DECUX	
<b>B</b>	Local queue name		DECUX.LOCALQ	
<b>Connection to MQSeries for OS/2 Warp</b>				
The values in this section of the table must match those used in Table 15 on page 164.				
<b>C</b>	Remote queue manager name	<b>A</b>	OS2	
<b>D</b>	Remote queue name		OS2.REMOTEQ	
<b>E</b>	Queue name at remote system	<b>B</b>	OS2.LOCALQ	
<b>F</b>	Transmission queue name		OS2	

Table 22. Configuration worksheet for MQSeries for DIGITAL UNIX (Compaq Tru64 UNIX) (continued)

ID	Parameter Name	Reference	Example Used	User Value
<b>H</b>	Sender (TCP) channel name		DECUX.OS2.TCP	
<b>J</b>	Receiver (TCP) channel name	<b>H</b>	OS2.DECUX.TCP	
<b>Connection to MQSeries for Windows NT</b>				
The values in this section of the table must match those used in Table 17 on page 185.				
<b>C</b>	Remote queue manager name	<b>A</b>	WINNT	
<b>D</b>	Remote queue name		WINNT.REMOTEQ	
<b>E</b>	Queue name at remote system	<b>B</b>	WINNT.LOCALQ	
<b>F</b>	Transmission queue name		WINNT	
<b>H</b>	Sender (TCP) channel name		DECUX.WINNT.TCP	
<b>J</b>	Receiver (TCP) channel name	<b>H</b>	WINNT.DECUX.TCP	
<b>Connection to MQSeries for AIX</b>				
The values in this section of the table must match those used in Table 21 on page 211.				
<b>C</b>	Remote queue manager name	<b>A</b>	AIX	
<b>D</b>	Remote queue name		AIX.REMOTEQ	
<b>E</b>	Queue name at remote system	<b>B</b>	AIX.LOCALQ	
<b>F</b>	Transmission queue name		AIX	
<b>H</b>	Sender (TCP) channel name		DECUX.AIX.TCP	
<b>J</b>	Receiver (TCP) channel name	<b>H</b>	AIX.DECUX.TCP	
<b>Connection to MQSeries for AT&amp;T GIS UNIX</b>				
The values in this section of the table must match those used in Table 26 on page 253.				
<b>C</b>	Remote queue manager name	<b>A</b>	GIS	
<b>D</b>	Remote queue name		GIS.REMOTEQ	
<b>E</b>	Queue name at remote system	<b>B</b>	GIS.LOCALQ	
<b>F</b>	Transmission queue name		GIS	
<b>H</b>	Sender (TCP) channel name		DECUX.GIS.TCP	
<b>J</b>	Receiver (TCP) channel name	<b>H</b>	GIS.DECUX.TCP	
<b>Connection to MQSeries for Sun Solaris</b>				
The values in this section of the table must match those used in Table 28 on page 272.				
<b>C</b>	Remote queue manager name	<b>A</b>	SOLARIS	
<b>D</b>	Remote queue name		SOLARIS.REMOTEQ	
<b>E</b>	Queue name at remote system	<b>B</b>	SOLARIS.LOCALQ	
<b>F</b>	Transmission queue name		SOLARIS	
<b>H</b>	Sender (TCP) channel name		DECUX.SOLARIS.TCP	
<b>J</b>	Receiver (TCP) channel name	<b>H</b>	SOLARIS.DECUX.TCP	
<b>Connection to MQSeries for AS/400.</b>				
The values in this section of the table must match those used in Table 43 on page 472.				
<b>C</b>	Remote queue manager name	<b>A</b>	AS400	
<b>D</b>	Remote queue name		AS400.REMOTEQ	
<b>E</b>	Queue name at remote system	<b>B</b>	AS400.LOCALQ	
<b>F</b>	Transmission queue name		AS400	
<b>H</b>	Sender (TCP) channel name		DECUX.AS400.TCP	
<b>J</b>	Receiver (TCP) channel name	<b>H</b>	AS400.DECUX.TCP	

## Digital UNIX configuration

Table 22. Configuration worksheet for MQSeries for DIGITAL UNIX (Compaq Tru64 UNIX) (continued)

ID	Parameter Name	Reference	Example Used	User Value
<b>Connection to MQSeries for OS/390 without CICS</b>				
The values in this section of the table must match those used in Table 37 on page 406.				
<b>C</b>	Remote queue manager name	<b>A</b>	MVS	
<b>D</b>	Remote queue name		MVS.REMOTEQ	
<b>E</b>	Queue name at remote system	<b>B</b>	MVS.LOCALQ	
<b>F</b>	Transmission queue name		MVS	
<b>H</b>	Sender (TCP) channel name		DECUX.MVS.TCP	
<b>J</b>	Receiver (TCP) channel name	<b>H</b>	MVS.DECUX.TCP	
<b>Connection to MQSeries for VSE/ESA</b>				
The values in this section of the table must match those used in Table 45 on page 490.				
<b>C</b>	Remote queue manager name	<b>A</b>	VSE	
<b>D</b>	Remote queue name		VSE.REMOTEQ	
<b>E</b>	Queue name at remote system	<b>B</b>	VSE.LOCALQ	
<b>F</b>	Transmission queue name		VSE	
<b>G</b>	Sender (SNA) channel name		DECUX.VSE.SNA	
<b>I</b>	Receiver (SNA) channel name	<b>G</b>	VSE.DECUX.SNA	

### MQSeries for DIGITAL UNIX (Compaq Tru64 UNIX) sender-channel definitions using TCP/IP

```

def ql (OS2) +                                     F
    usage(xmitq) +
    replace

def qr (OS2.REMOTEQ) +                             D
    rname(OS2.LOCALQ) +                             E
    rqmname(OS2) +                                  C
    xmitq(OS2) +                                     F
    replace

def chl (DECUX.OS2.TCP) chltype(sdr) +             H
    trptype(tcp) +
    conname(remote_tcpip_hostname) +
    xmitq(OS2) +                                     F
    replace

```

### MQSeries for DIGITAL UNIX (Compaq Tru64 UNIX) receiver-channel definitions using TCP/IP

```

def ql (DECUX.LOCALQ) replace                       B

def chl (OS2.DECUX.TCP) chltype(rcvr) +           J
    trptype(tcp) +
    replace

```



---

## Chapter 16. Example configuration - IBM MQSeries for HP-UX

This chapter gives an example of how to set up communication links from MQSeries for HP-UX to MQSeries products on the following platforms:

- OS/2
- Windows NT
- AIX
- Digital UNIX
- AT&T GIS UNIX<sup>4</sup>
- Sun Solaris
- OS/400
- OS/390 or MVS/ESA without CICS
- VSE/ESA

First it describes the parameters needed for an LU 6.2 connection, then it describes “Establishing a session using HP SNAplus2” on page 223 and “Establishing a TCP connection” on page 237.

Once the connection is established, you need to define some channels to complete the configuration. This is described in “MQSeries for HP-UX configuration” on page 238.

See “Chapter 7. Example configuration chapters in this book” on page 97 for background information about this chapter and how to use it.

---

### Configuration parameters for an LU 6.2 connection

Table 23 presents a worksheet listing all the parameters needed to set up communication from HP-UX to one of the other MQSeries platforms. The worksheet shows examples of the parameters, which have been tested in a working environment, and leaves space for you to fill in your own values. An explanation of the parameter names follows the worksheet. Use the worksheet in this chapter in conjunction with the worksheet in the chapter for the platform to which you are connecting.

### Configuration worksheet

Use this worksheet to record the values you use for your configuration. Where numbers appear in the Reference column they indicate that the value must match that in the appropriate worksheet elsewhere in this book. The examples that follow in this chapter refer back to the values in the ID column. The entries in the Parameter Name column are explained in “Explanation of terms” on page 222.

Table 23. Configuration worksheet for HP SNAplus2

ID	Parameter Name	Reference	Example	User Value
<i>Parameters for local node</i>				
<b>1</b>	Configuration file name		sna_node.cfg	
<b>2</b>	Control point name		HPUXPU	
<b>3</b>	Node ID to send		05D 54321	
<b>4</b>	Network name		NETID	

---

4. This platform has become NCR UNIX SVR4 MP-RAS, R3.0

## HP-UX and LU 6.2

Table 23. Configuration worksheet for HP SNAplus2 (continued)

ID	Parameter Name	Reference	Example	User Value
5	Local APPC LU		HPUXLU	
6	APPC mode		#INTER	
7	Invokable TP		MQSERIES	
8	Token-Ring adapter address		100090DC2C7C	
9	Port name		MQPORT	
10	Full path to executable		/opt/mqm/bin/amqcrs6a	
11	Local queue manager		hpux	
<b>Connection to an OS/2 system</b>				
The values in this section of the table must match those used in Table 14 on page 138, as indicated.				
12	Link station name		OS2CONN	
13	Network name	2	NETID	
14	CP name	3	OS2PU	
15	Remote LU	6	OS2LU	
16	Application TP	8	MQSERIES	
17	Mode name	17	#INTER	
18	CPI-C symbolic destination name		OS2CPIC	
19	Remote network address	10	10005AFC5D83	
20	Node ID to receive	4	05D 12345	
<b>Connection to a Windows NT system</b>				
The values in this section of the table must match those used in Table 16 on page 170, as indicated.				
12	Link station name		NTCONN	
13	Network name	2	NETID	
14	CP name	3	WINNTCP	
15	Remote LU	5	WINNTLU	
16	Application TP	7	MQSERIES	
17	Mode name	17	#INTER	
18	CPI-C symbolic destination name		NTCPIC	
19	Remote network address	9	08005AA5FAB9	
20	Node ID to receive	4	05D 30F65	
<b>Connection to an AIX system</b>				
The values in this section of the table must match those used in Table 20 on page 197, as indicated.				
12	Link station name		AIXCONN	
13	Network name	1	NETID	
14	CP name	2	AIXPU	
15	Remote LU	4	AIXLU	
16	Application TP	6	MQSERIES	
17	Mode name	14	#INTER	
18	CPI-C symbolic destination name		AIXCPIC	
19	Remote network address	8	123456789012	
20	Node ID to receive	3	071 23456	
<b>Connection to an AT&amp;T GIS UNIX system</b>				
The values in this section of the table must match those used in the table Table 25 on page 243, as indicated.				
12	Link station name		GISCONN	
13	Network name	2	NETID	

Table 23. Configuration worksheet for HP SNAplus2 (continued)

ID	Parameter Name	Reference	Example	User Value
14	CP name	3	GISPU	
15	Remote LU		GISLU	
16	Application TP	5	MQSERIES	
17	Mode name	7	#INTER	
18	CPI-C symbolic destination name		GISCPIC	
19	Remote network address	8	10007038E86B	
20	Node ID to receive	9	03E 00018	
<b>Connection to a Sun Solaris system</b>				
The values in this section of the table must match those used in Table 27 on page 257, as indicated.				
12	Link station name		SOLCONN	
13	Network name	2	NETID	
14	CP name	3	SOLARPU	
15	Remote LU	7	SOLARLU	
16	Application TP	8	MQSERIES	
17	Mode name	17	#INTER	
18	CPI-C symbolic destination name		SOLCPIC	
19	Remote network address	5	08002071CC8A	
20	node ID to receive	6	05D 310D6	
<b>Connection to an AS/400 system</b>				
The values in this section of the table must match those used in Table 42 on page 460, as indicated.				
12	Link station name		AS4CONN	
13	Network name	1	NETID	
14	CP name	2	AS400PU	
15	Remote LU	3	AS400LU	
16	Application TP	8	MQSERIES	
17	Mode name	17	#INTER	
18	CPI-C symbolic destination name		AS4CPIC	
19	Remote network address	4	10005A5962EF	
<b>Connection to an OS/390 or MVS/ESA system without CICS</b>				
The values in this section of the table must match those used in Table 36 on page 396, as indicated.				
12	Link station name		MVSCONN	
13	Network name	2	NETID	
14	CP name	3	MVSPU	
15	Remote LU	4	MVSLU	
16	Application TP	7	MQSERIES	
17	Mode name	10	#INTER	
18	CPI-C symbolic destination name		MVSCPIC	
19	Remote network address	8	400074511092	
<b>Connection to a VSE/ESA system</b>				
The values in this section of the table must match those used in Table 44 on page 485, as indicated.				
12	Link station name		VSECONN	
13	Network name	1	NETID	
14	CP name	2	VSEPU	
15	Remote LU	3	VSELU	

## HP-UX and LU 6.2

Table 23. Configuration worksheet for HP SNAplus2 (continued)

ID	Parameter Name	Reference	Example	User Value
16	Application TP	4	MQ01	MQ01
17	Mode name		#INTER	
18	CPI-C symbolic destination name		VSECPIC	
19	Remote network address	5	400074511092	

### Explanation of terms

#### 1 Configuration file name

This is the unique name of the SNAplus2 configuration file. The default for this name is `sna_node.cfg`.

**Although it is possible to edit this file it is strongly recommended that configuration is done using `xsnapadmin`.**

#### 2 Control point name

This is the unique Control point name for this workstation. In the SNA network, the Control point is an addressable location (PU type 2.1). Your network administrator will assign this to you.

#### 3 Node ID to send

This is the unique ID of this workstation. On other platforms this is often referred to as the *Exchange ID* or *XID*. Your network administrator will assign this ID for you.

#### 4 Network name

This is the unique ID of the network to which you are connected. It is an alphanumeric value and can be 1-8 characters long. The network name works with the Control point name to uniquely identify a system. Your network administrator will tell you the value.

#### 5 Local APPC LU

An LU manages the exchange of data between transactions. The local APPC LU name is the name of the LU on your system. Your network administrator will assign this to you.

#### 6 APPC mode

This is the name given to the set of parameters that control the APPC conversation. This name must be defined at each partner system. Your network administrator will assign this to you.

#### 7 Invokable TP

MQSeries applications trying to converse with this workstation will specify a symbolic name for the program to be run at the receiving end. This will have been defined on the channel definition at the sender. For simplicity, wherever possible use a transaction program name of MQSERIES, or in the case of a connection to VSE/ESA, where the length is limited to 4 bytes, use MQTP.

See Table 19 on page 194 for more information.

#### 8 Token-ring adapter address

Use the HP-UX System Administration Manager (SAM) to discover the adapter address for this workstation. You need root authority to use SAM. From the initial menu, select **Networking and Communications**, then select **Network Interface cards** followed by **LAN 0** (or whichever LAN you are using). The adapter address is displayed under the heading Station

Address (hex). The card name represents the appropriate card type. If you do not have root level authority, your HP-UX system administrator can tell you the value.

**9 Port name**

This is a meaningful symbolic name that is used to associate the definitions with a network interface (in this case, a Token-Ring adapter). A separate Port must be defined for each physical device attached to the workstation.

**10 Full path to executable**

On HP SNAplus2 Release 5, this is the path and name of a shell script file that invokes the actual program to be run when a conversation is initiated with this workstation. You can choose the path and name of the script file. The contents of the file are illustrated in “MQSeries for HP-UX invocable TP setup” on page 241. On HP SNAplus2 Release 6, this is the path and name of the program to be run when a conversation is initiated with this workstation. You enter the path in the **TP invocation** screen (see “Adding a TP definition using HP SNAplus2 Release 6” on page 235).

**11 Local queue manager**

This is the name of the queue manager on your local system.

**10 Link station name**

This is a meaningful symbolic name by which the connection to a peer or host node is known. It defines a logical path to the remote system. Its name is used only inside SNAplus2 and is specified by you. The connection must be associated with an existing Link and owned by one local node. You must define one connection for each partner or host system.

**18 CPI-C symbolic destination name**

This is a name given to the definition of a partner node. You choose the name. It need be unique only on this machine. Later you can use this name in the MQSeries sender channel definition.

**20 Node ID to receive**

This is the unique ID of the partner workstation with which you will be communicating. On other platforms this is often referred to as the *Exchange ID* or *XID*. For a connection to a host system any values except 000 FFFFF and FFF FFFFF may be specified. Your network administrator will assign this ID for you.

---

## Establishing a session using HP SNAplus2

The following information guides you through the tasks you must perform to create the SNA infrastructure that MQSeries requires. This example creates the definitions for a partner node and LU on OS/2.

Use **snap start** followed by **xsnapadmin** to enter the HP SNAplus2 configuration panels. You need root authority to use **xsnapadmin**.

### SNAplus2 configuration

SNAplus2 configuration involves the following steps:

1. Defining a local node
2. Adding a Token Ring Port
3. Defining a local LU

## Using HP SNAplus2

The SNAplus2 main menu, from which you will start, is shown below:

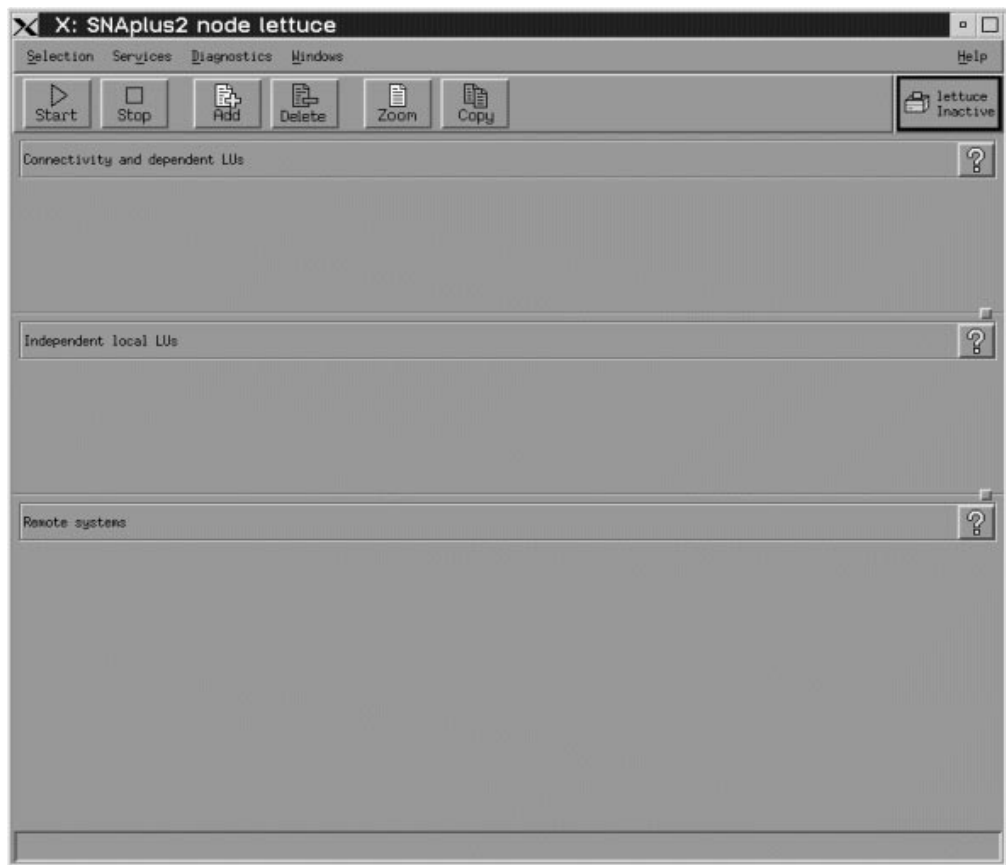

## Defining a local node

1. From the SNAplus2 main menu, select the **Services** pull-down:

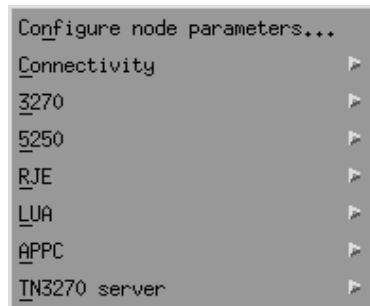

2. Select **Configure node parameters...**. The following panel is displayed:

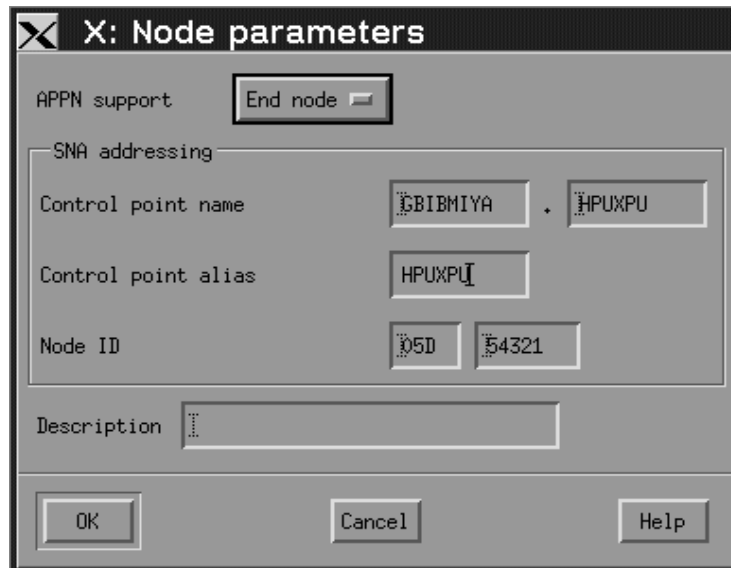

3. Complete the **Control point name** with the values **Network name (4)** and **Control point name (2)**.
4. Enter the **Control point name (2)** in the **Control point alias** field.
5. Enter the **Node ID (3)**.
6. Select **End node**.
7. Press **OK**.

A default independent local LU is defined.

## Adding a Token Ring Port

1. From the main SNAplus2 menu, select the Connectivity and dependent LUs panel.
2. Press **Add**. The following panel is displayed:

## Using HP SNAplus2



3. Select a Token Ring Card port and press **OK**. The following panel is displayed:



4. Enter the **SNA port name** ( **9** ).
5. Enter a **Description** and press **OK** to take the default values.

### Defining a local LU

1. From the main SNAplus2 menu, select the Independent local LUs panel.
2. Press **Add**. The following panel is displayed:



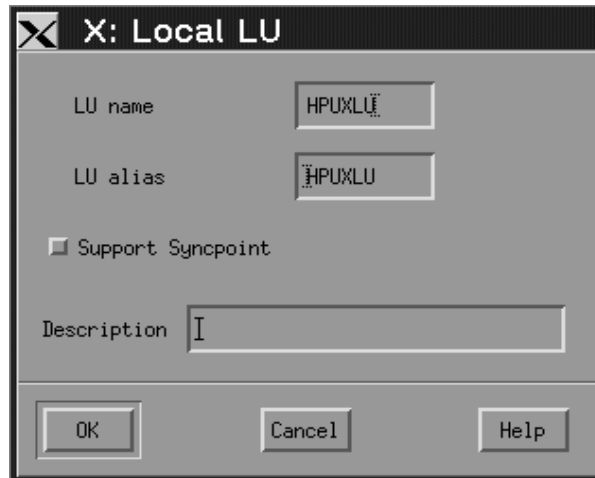

3. Enter the **LU name** ( **5** ) and press **OK**.

## APPC configuration

APPC configuration involves the following steps:

1. Defining a remote node
2. Defining a partner LU
3. Defining a link station
4. Defining a mode
5. Adding CPI-C information
6. Adding a TP definition

### Defining a remote node

1. From the main SNAplus2 menu, select the Remote systems panel.
2. Press **Add**. The following panel is displayed:

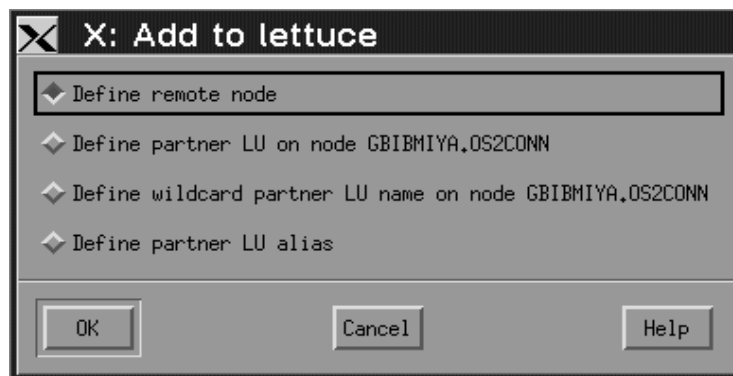

3. Select **Define remote node** and press **OK**. The following panel is displayed:

## Using HP SNAplus2

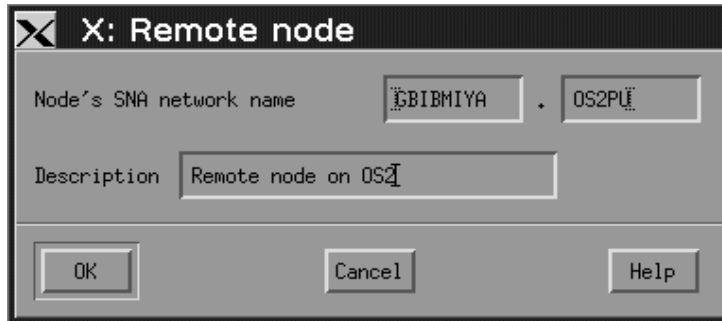

4. Enter the **Node's SNA network name** ( **13** ) and a **Description**.
5. Press **OK**.
6. A default partner LU with the same name is generated and a message is displayed.
7. Press **OK**.

### Defining a partner LU

1. From the main SNAplus2 menu, select the remote node in the Remote systems panel.
2. Press **Add**. The following panel is displayed:

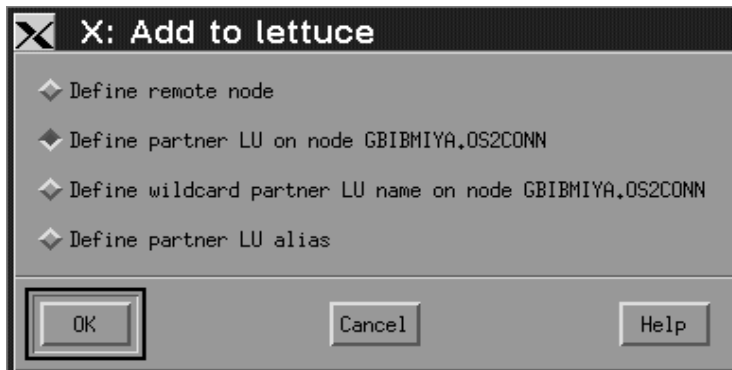

3. Select **Define partner LU on node node name**.
4. Press **OK**. The following panel is displayed:

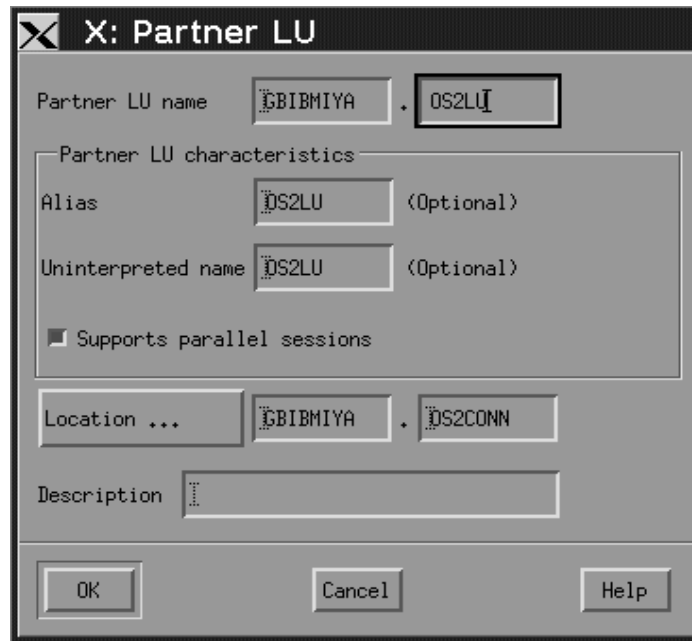

5. Enter the **partner LU name** ( **15** ) and press **OK**.

### Defining a link station

1. From the main SNAplus2 menu, select the Connectivity and dependent LUs panel.
2. Select the MQPORT port.
3. Press **Add**. The following panel is displayed:



4. Select **Add link station to port MQPORT**.
5. Press **OK**. The following panel is displayed:



6. Enter the **Name** of the link station ( **12** ).
7. Set the value of **Activation** to “On demand”.
8. Select **Independent only**.
9. Press **Remote node...** and select the value of the remote node ( **14** ).
10. Press **OK**.
11. Set the value of **Remote node type** to “End or LEN node”.
12. Enter the value for **MAC address** ( **19** ) and press **Advanced...**. The following panel is displayed:



13. Select **Reactivate link station after failure**.
14. Press **OK** to exit the Advanced... panel.
15. Press **OK** again.

### Defining a mode

1. From the SNAplus2 main menu, select the **Services** pull-down: The following panel is displayed:

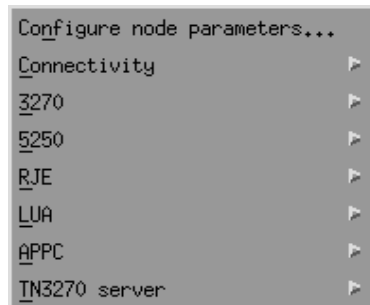

2. Select **APPC**. The following panel is displayed:

## Using HP SNAplus2



3. Select **Modes...**. The following panel is displayed:

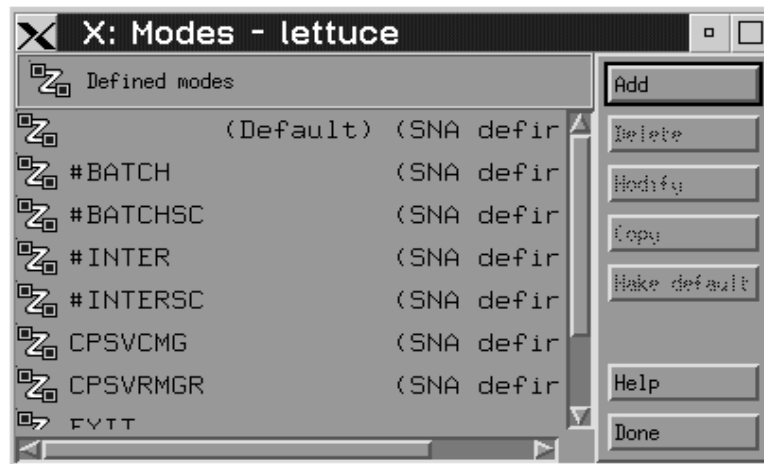

4. Press **Add**. The following panel is displayed:

5. Enter the **Name** to be given to the mode ( **17** ).
6. Set the values of **Initial session limit** to 8, **Min con. winner sessions** to 4, and **Auto-activated sessions** to 0.
7. Press **OK**.
8. Press **Done**.

### Adding CPI-C information

1. From the SNAplus2 main menu, select the **Services** pull-down:

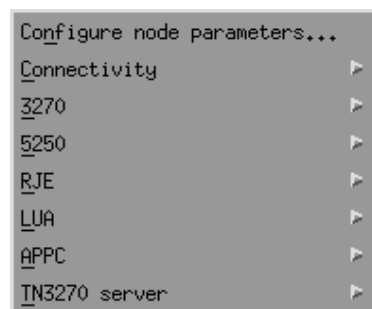

2. Select **APPC**. The following panel is displayed:

## Using HP SNAplus2



3. Select **CPI-C...**. The following panel is displayed:

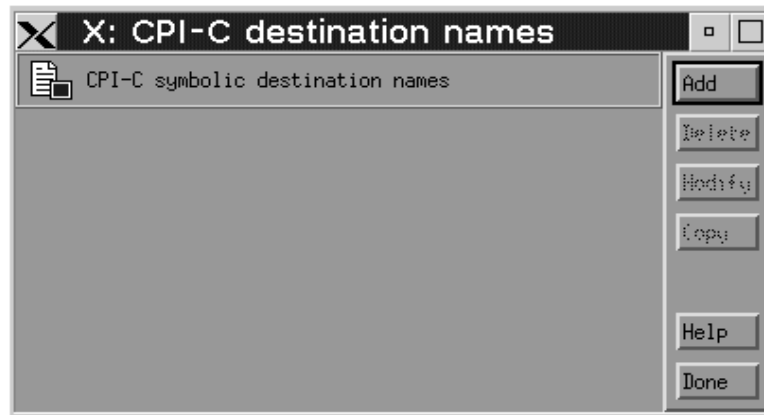

4. Press **Add**. The following panel is displayed:



5. Enter the **Name** ( **18** ). Select **Application TP** and enter the value ( **16** ). Select **Use PLU alias** and enter the name ( **15** ). Enter the **Mode** name ( **17** ).
6. Press **OK**.

### Adding a TP definition using HP SNAplus2 Release 5

Invokable TP definitions are kept in the file `/etc/opt/sna/sna_tps`. This should be edited to add a TP definition. Add the following lines:

```
[MQSERIES]
  PATH = /users/interops/HPUX.crs6a
  TYPE = NON-QUEUED
  USERID = mqm
  ENV = APPCLLU=HPUXLU
  ENV = APPCTPN=MQSERIES
```

See “MQSeries for HP-UX invokable TP setup” on page 241 for more information about TP definitions.

### Adding a TP definition using HP SNAplus2 Release 6

To add a TP definition:

1. Select **Services** pulldown and select **APPC** as for CPI-C information.
2. Select **Transaction Programs**. The following panel is displayed:

## Using HP SNAplus2

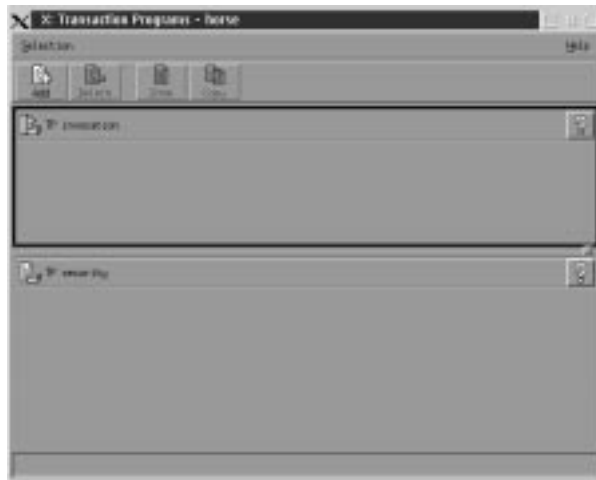

3. Select **Add**. The following panel is displayed:

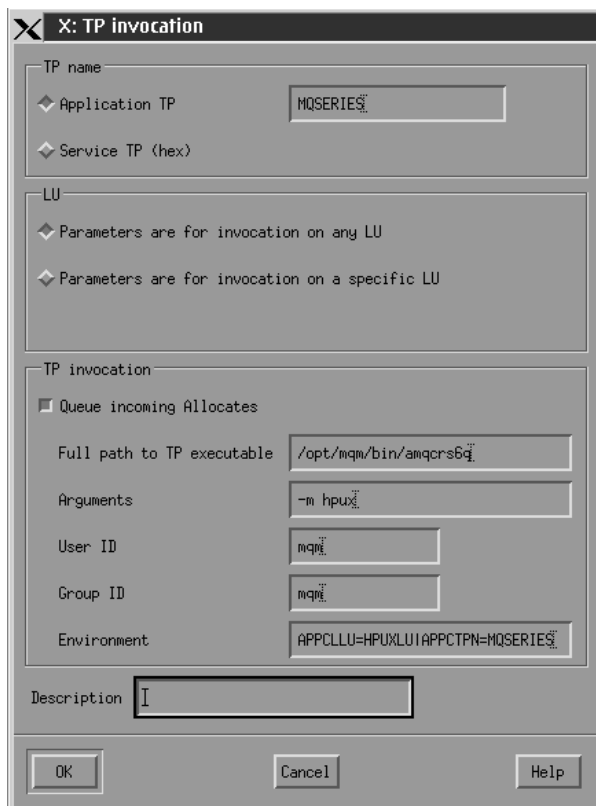

4. Enter **TP name** ( **7** ) in the **Application TP** field.
5. Mark **Incoming Allocates** as non-queued.
6. Enter **Full path to executable** ( **10** ).
7. Enter **-m Local queue manager** ( **11** ) in the **Arguments** field.
8. Enter **mqm** in the **User ID** and **Group ID** fields.
9. Enter environment variables **APPCLU=local LU** ( **5** ) and **APPCTPN=Invokable TP** ( **7** ) separated by the pipe character in the **Environment** field.
10. Press **OK** to save your definition.

## HP-UX operation

The SNAplus2 control daemon is started with the **snap start** command. Depending on the options selected at installation, it may already be running.

The **xsnapadmin** utility controls SNAplus2 resources.

Logging and tracing are controlled from here. Log and trace files can be found in the `/var/opt/sna` directory. The logging files `sna.aud` and `sna.err` can be read using a standard editor such as `vi`.

In order to read the trace files **sna1.trc** and **sna2.trc** they must first be formatted by running the command **snaptrcfmt -f sna1.trc -o sna1** which produces a `sna1.dmp` file which can be read using a normal editor.

The configuration file itself is editable but this is not a recommended method of configuring SNAplus2.

The APPCLU environment variables must be set before starting a sender channel from the HP-UX system. The command can be either entered interactively or added to the logon profile. Depending on the level of BOURNE shell or KORN shell program being used, the command will be:

```
export APPCLU=HPUXLU 5 newer level
```

or

```
APPCLU=HPUXLU 5 older level
export
```

## What next?

The connection is now established. You are ready to complete the configuration. Go to “MQSeries for HP-UX configuration” on page 238.

---

## Establishing a TCP connection

1. Edit the file `/etc/services`.

**Note:** To edit the `/etc/services` file, you must be logged in as a superuser or root. If you do not have the following line in that file, add it as shown:

```
MQSeries      1414/tcp      # MQSeries channel listener
```

2. Edit the file `/etc/inetd.conf`. If you do not have the following line in that file, add it as shown:

```
MQSeries stream tcp nowait root /opt/mqm/bin/amqcrsta amqcrsta
[-m queue.manager.name]
```

3. Find the process ID of the `inetd` with the command:

```
ps -ef | grep inetd
```

4. Run the command:

```
kill -1 inetd processid
```

## What next?

The connection is now established. You are ready to complete the configuration. Go to “MQSeries for HP-UX configuration” on page 238.

### MQSeries for HP-UX configuration

Before beginning the installation process ensure that you have first created the *mqm* user and group, and set the password.

Start any channel using the command:

```
runmqchl -c channel.name
```

#### Notes:

1. Sample programs are installed in `/opt/mqm/samp`.
2. Error logs are stored in `/var/mqm/qmgrs/qmgrname/errors`.
3. When you are using the command interpreter **runmqsc** to enter administration commands, a `+` at the end of a line indicates that the next line is a continuation. Ensure that there is a space between the last parameter and the continuation character.

### Basic configuration

1. Create the queue manager from the UNIX prompt using the command:

```
crtmqm -u dlqname -q hpux
```

where:

*hpux* Is the name of the queue manager

**-q** Indicates that this is to become the default queue manager

**-u *dlqname***

Specifies the name of the undeliverable message queue

This command creates a queue manager and a set of default objects. It sets the DEADQ attribute of the queue manager but does not create the undeliverable message queue.

2. Start the queue manager from the UNIX prompt using the command:

```
strmqm hpux
```

where *hpux* is the name given to the queue manager when it was created.

### Channel configuration

The following section details the configuration to be performed on the HP-UX queue manager to implement the channel described in Figure 32 on page 97.

In each case the MQSC command is shown. Either start **runmqsc** from a UNIX prompt and enter each command in turn, or build the commands into a command file.

Examples are given for connecting MQSeries for HP-UX and MQSeries for OS/2 Warp. If you wish connect to another MQSeries product use the appropriate set of values from the table in place of those for OS/2.

**Note:** The words in **bold** are user-specified and reflect the names of MQSeries objects used throughout these examples. If you change the names used here, ensure that you also change the other references made to these objects throughout this book. All others are keywords and should be entered as shown.

Table 24. Configuration worksheet for MQSeries for HP-UX

ID	Parameter Name	Reference	Example Used	User Value
<b>Definition for local node</b>				
<b>A</b>	Queue Manager Name		HPUX	
<b>B</b>	Local queue name		HPUX.LOCALQ	
<b>Connection to MQSeries for OS/2 Warp</b>				
The values in this section of the table must match those used in Table 15 on page 164, as indicated.				
<b>C</b>	Remote queue manager name	<b>A</b>	OS2	
<b>D</b>	Remote queue name		OS2.REMOTEQ	
<b>E</b>	Queue name at remote system	<b>B</b>	OS2.LOCALQ	
<b>F</b>	Transmission queue name		OS2	
<b>G</b>	Sender (SNA) channel name		HPUX.OS2.SNA	
<b>H</b>	Sender (TCP/IP) channel name		HPUX.OS2.TCP	
<b>I</b>	Receiver (SNA) channel name	<b>G</b>	OS2.HPUX.SNA	
<b>J</b>	Receiver (TCP/IP) channel name	<b>H</b>	OS2.HPUX.TCP	
<b>Connection to MQSeries for Windows NT</b>				
The values in this section of the table must match those used in Table 17 on page 185, as indicated.				
<b>C</b>	Remote queue manager name	<b>A</b>	WINNT	
<b>D</b>	Remote queue name		WINNT.REMOTEQ	
<b>E</b>	Queue name at remote system	<b>B</b>	WINNT.LOCALQ	
<b>F</b>	Transmission queue name		WINNT	
<b>G</b>	Sender (SNA) channel name		HPUX.WINNT.SNA	
<b>H</b>	Sender (TCP/IP) channel name		HPUX.WINNT.TCP	
<b>I</b>	Receiver (SNA) channel name	<b>G</b>	WINNT.HPUX.SNA	
<b>J</b>	Receiver (TCP) channel name	<b>H</b>	WINNT.HPUX.TCP	
<b>Connection to MQSeries for AIX</b>				
The values in this section of the table must match those used in Table 21 on page 211, as indicated.				
<b>C</b>	Remote queue manager name	<b>A</b>	AIX	
<b>D</b>	Remote queue name		AIX.REMOTEQ	
<b>E</b>	Queue name at remote system	<b>B</b>	AIX.LOCALQ	
<b>F</b>	Transmission queue name		AIX	
<b>G</b>	Sender (SNA) channel name		HPUX.AIX.SNA	
<b>H</b>	Sender (TCP) channel name		HPUX.AIX.TCP	
<b>I</b>	Receiver (SNA) channel name	<b>G</b>	AIX.HPUX.SNA	
<b>J</b>	Receiver (TCP) channel name	<b>H</b>	AIX.HPUX.TCP	
<b>Connection to MQSeries for DIGITAL UNIX (Compaq Tru64 UNIX)</b>				
The values in this section of the table must match those used in Table 22 on page 216, as indicated.				
<b>C</b>	Remote queue manager name	<b>A</b>	DECUX	
<b>D</b>	Remote queue name		DECUX.REMOTEQ	
<b>E</b>	Queue name at remote system	<b>B</b>	DECUX.LOCALQ	
<b>F</b>	Transmission queue name		DECUX	
<b>H</b>	Sender (TCP) channel name		DECUX.HPUX.TCP	
<b>J</b>	Receiver (TCP) channel name	<b>H</b>	HPUX.DECUX.TCP	
<b>Connection to MQSeries for OS/390 or MVS/ESA without CICS</b>				
The values in this section of the table must match those used in Table 26 on page 253, as indicated.				

## HP-UX configuration

Table 24. Configuration worksheet for MQSeries for HP-UX (continued)

ID	Parameter Name	Reference	Example Used	User Value
<b>C</b>	Remote queue manager name	<b>A</b>	GIS	
<b>D</b>	Remote queue name		GIS.REMOTEQ	
<b>E</b>	Queue name at remote system	<b>B</b>	GIS.LOCALQ	
<b>F</b>	Transmission queue name		GIS	
<b>G</b>	Sender (SNA) channel name		HPUX.GIS.SNA	
<b>H</b>	Sender (TCP) channel name		HPUX.GIS.TCP	
<b>I</b>	Receiver (SNA) channel name	<b>G</b>	GIS.HPUX.SNA	
<b>J</b>	Receiver (TCP) channel name	<b>H</b>	GIS.HPUX.TCP	
<b>Connection to MQSeries for Sun Solaris</b>				
The values in this section of the table must match those used in Table 28 on page 272, as indicated.				
<b>C</b>	Remote queue manager name		SOLARIS	
<b>D</b>	Remote queue name		SOLARIS.REMOTEQ	
<b>E</b>	Queue name at remote system	<b>B</b>	SOLARIS.LOCALQ	
<b>F</b>	Transmission queue name		SOLARIS	
<b>G</b>	Sender (SNA) channel name		HPUX.SOLARIS.SNA	
<b>H</b>	Sender (TCP/IP) channel name		HPUX.SOLARIS.TCP	
<b>I</b>	Receiver (SNA) channel name	<b>G</b>	SOLARIS.HPUX.SNA	
<b>J</b>	Receiver (TCP/IP) channel name	<b>H</b>	SOLARIS.HPUX.TCP	
<b>Connection to MQSeries for AS/400</b>				
The values in this section of the table must match those used in Table 43 on page 472, as indicated.				
<b>C</b>	Remote queue manager name		AS400	
<b>D</b>	Remote queue name		AS400.REMOTEQ	
<b>E</b>	Queue name at remote system	<b>B</b>	AS400.LOCALQ	
<b>F</b>	Transmission queue name		AS400	
<b>G</b>	Sender (SNA) channel name		HPUX.AS400.SNA	
<b>H</b>	Sender (TCP/IP) channel name		HPUX.AS400.TCP	
<b>I</b>	Receiver (SNA) channel name	<b>G</b>	AS400.HPUX.SNA	
<b>J</b>	Receiver (TCP) channel name	<b>H</b>	AS400.HPUX.TCP	
<b>Connection to MQSeries for OS/390 or MVS/ESA without CICS</b>				
The values in this section of the table must match those used in Table 37 on page 406, as indicated.				
<b>C</b>	Remote queue manager name		MVS	
<b>D</b>	Remote queue name		MVS.REMOTEQ	
<b>E</b>	Queue name at remote system	<b>B</b>	MVS.LOCALQ	
<b>F</b>	Transmission queue name		MVS	
<b>G</b>	Sender (SNA) channel name		HPUX.MVS.SNA	
<b>H</b>	Sender (TCP) channel name		HPUX.MVS.TCP	
<b>I</b>	Receiver (SNA) channel name	<b>G</b>	MVS.HPUX.SNA	
<b>J</b>	Receiver (TCP) channel name	<b>H</b>	MVS.HPUX.TCP	
<b>Connection to MQSeries for VSE/ESA</b>				
The values in this section of the table must match those used in Table 45 on page 490, as indicated.				
<b>C</b>	Remote queue manager name		VSE	
<b>D</b>	Remote queue name		VSE.REMOTEQ	
<b>E</b>	Queue name at remote system	<b>B</b>	VSE.LOCALQ	
<b>F</b>	Transmission queue name		VSE	

Table 24. Configuration worksheet for MQSeries for HP-UX (continued)

ID	Parameter Name	Reference	Example Used	User Value
<b>G</b>	Sender channel name		HPUX.VSE.SNA	
<b>I</b>	Receiver channel name	<b>G</b>	VSE.HPUX.SNA	

### MQSeries for HP-UX sender-channel definitions using SNA

```
def ql (OS2) + F
    usage(xmitq) +
    replace
```

```
def qr (OS2.REMOTEQ) + D
    rname(OS2.LOCALQ) + E
    rqmname(OS2) + C
    xmitq(OS2) + F
    replace
```

```
def chl (HPUX.OS2.SNA) chltype(sdr) + G
    trptype(lu62) +
    conname('OS2CPIC') + 16
    xmitq(OS2) + F
    replace
```

### MQSeries for HP-UX receiver-channel definitions using SNA

```
def ql (HPUX.LOCALQ) replace B
```

```
def chl (OS2.HPUX.SNA) chltype(rcvr) + I
    trptype(lu62) +
    replace
```

### MQSeries for HP-UX invokable TP setup

This is not required for HP SNAplus2 Release 6.

During the HP SNAplus2 configuration process, you created an invokable TP definition, which points to an executable file. In the example, the file was called /users/interop/HPUX.crs6a. You can choose what you call this file, but you are recommended to include the name of your queue manager in the name. The contents of the executable file must be:

```
#!/bin/sh
/opt/mqm/bin/amqcrs6a -m hpux
```

where *hpux* is the name of your queue manager **A**.

This ensures that SNA receiver channels activate correctly when a sender channel initiates a conversation.

### MQSeries for HP-UX sender-channel definitions using TCP

```
def ql (OS2) + F
    usage(xmitq) +
    replace
```

```
def qr (OS2.REMOTEQ) + D
    rname(OS2.LOCALQ) + E
    rqmname(OS2) + C
    xmitq(OS2) + F
    replace
```

```
def chl (HPUX.OS2.TCP) chltype(sdr) + H
```

## HP-UX configuration

```
trptype(tcp) +  
conname(remote_tcpip_hostname) +  
xmitq(OS2) +  
replace
```

**F**

## MQSeries for HP-UX receiver-channel definitions using TCP/IP

```
def ql (HPUX.LOCALQ) replace
```

**B**

```
def chl (OS2.HPUX.TCP) ch1type(rcvr) +  
trptype(tcp) +  
replace
```

**J**



---

## Chapter 17. Example configuration - IBM MQSeries for AT&T GIS UNIX Version 2.2

This chapter gives an example of how to set up communication links from MQSeries for AT&T GIS UNIX to MQSeries products on the following platforms:

- OS/2
- Windows NT
- AIX
- Digital UNIX
- HP-UX
- Sun Solaris
- OS/400
- OS/390 or MVS/ESA without CICS
- VSE/ESA

First it describes the parameters needed for an LU 6.2 connection, then it describes “Establishing a connection using AT&T GIS SNA Server” on page 246 and “Establishing a TCP connection” on page 251.

Once the connection is established, you need to define some channels to complete the configuration. This is described in “Channel configuration” on page 252.

See “Chapter 7. Example configuration chapters in this book” on page 97 for background information about this chapter and how to use it.

---

### Configuration parameters for an LU 6.2 connection

Table 25 presents a worksheet listing all the parameters needed to set up communication from AT&T GIS UNIX<sup>5</sup> to one of the other MQSeries platforms. The worksheet shows examples of the parameters, which have been tested in a working environment, and leaves space for you to fill in your own values. An explanation of the parameter names follows the worksheet. Use the worksheet in this chapter in conjunction with the worksheet in the chapter for the platform to which you are connecting.

### Configuration worksheet

Use the following worksheet to record the values you will use for this configuration. Where numbers appear in the Reference column they indicate that the value must match that in the appropriate worksheet elsewhere in this book. The examples that follow in this chapter refer back to the values in the ID column of this table. The entries in the Parameter Name column are explained in “Explanation of terms” on page 246.

*Table 25. Configuration worksheet for AT&T GIS SNA Services*

ID	Parameter Name	Reference	Example	User Value
<i>Parameters for local node</i>				
<b>1</b>	Configuration		<b>010</b>	
<b>2</b>	Network name		<b>NETID</b>	

---

5. This platform has become NCR UNIX SVR4 MP-RAS, R3.0

## AT&T GIS UNIX and LU 6.2

Table 25. Configuration worksheet for AT&T GIS SNA Services (continued)

ID	Parameter Name	Reference	Example	User Value
<b>3</b>	Control Point name		GISPU	
<b>4</b>	Local LU name		GISLU	
<b>5</b>	LU 6.2 Transaction Program name		MQSERIES	
<b>6</b>	Local PU name		GISPU	
<b>7</b>	Mode name		#INTER	
<b>8</b>	Token-Ring adapter address		10007038E86B	
<b>9</b>	Local XID		03E 00018	
<b>Connection to an OS/2 system</b>				
The values in this section of the table must match those used in Table 14 on page 138, as indicated.				
<b>10</b>	Remote Node name	<b>3</b>	OS2PU	
<b>11</b>	Network name	<b>2</b>	NETID	
<b>12</b>	Remote LU name	<b>6</b>	OS2LU	
<b>13</b>	Remote Transaction Program name	<b>8</b>	MQSERIES	
<b>14</b>	LU 6.2 CPI-C side information symbolic destination		OS2CPIC	
<b>15</b>	Mode name	<b>17</b>	#INTER	
<b>16</b>	LAN destination address	<b>10</b>	10005AFC5D83	
<b>Connection to a Windows NT system</b>				
The values in this section of the table must match those used in Table 16 on page 170, as indicated.				
<b>10</b>	Remote Node name	<b>3</b>	WINNTCP	
<b>11</b>	Network name	<b>2</b>	NETID	
<b>12</b>	Remote LU name	<b>5</b>	WINNTLU	
<b>13</b>	Remote Transaction Program name	<b>7</b>	MQSERIES	
<b>14</b>	LU 6.2 CPI-C side information symbolic destination		NTCPIC	
<b>15</b>	Mode name	<b>17</b>	#INTER	
<b>16</b>	LAN destination address	<b>9</b>	08005AA5FAB9	
<b>Connection to an AIX system</b>				
The values in this section of the table must match those used in Table 20 on page 197, as indicated.				
<b>10</b>	Remote Node name	<b>2</b>	AIXPU	
<b>11</b>	Network name	<b>1</b>	NETID	
<b>12</b>	Remote LU name	<b>4</b>	AIXLU	
<b>13</b>	Remote Transaction Program name	<b>6</b>	MQSERIES	
<b>14</b>	LU 6.2 CPI-C side information symbolic destination		AIXCPIC	
<b>15</b>	Mode name	<b>14</b>	#INTER	
<b>16</b>	LAN destination address	<b>8</b>	123456789012	
<b>Connection to an HP-UX system</b>				
The values in this section of the table must match those used in Table 23 on page 219, as indicated.				
<b>10</b>	Remote Node name	<b>2</b>	HPUXPU	
<b>11</b>	Network name	<b>4</b>	NETID	
<b>12</b>	Remote LU name	<b>5</b>	HPUXLU	
<b>13</b>	Remote Transaction Program name	<b>7</b>	MQSERIES	
<b>14</b>	LU 6.2 CPI-C side information symbolic destination		HPUXCPIC	

Table 25. Configuration worksheet for AT&T GIS SNA Services (continued)

ID	Parameter Name	Reference	Example	User Value
15	Mode name	6	#INTER	
16	LAN destination address	8	100090DC2C7C	
<b>Connection to a Sun Solaris system</b>				
The values in this section of the table must match those used in Table 27 on page 257, as indicated.				
10	Remote Node name	3	SOLARPU	
11	Network name	2	NETID	
12	Remote LU name	7	SOLARLU	
13	Remote Transaction Program name	8	MQSERIES	
14	LU 6.2 CPI-C side information symbolic destination		SOLCPIC	
15	Mode name	17	#INTER	
16	LAN destination address	5	08002071CC8A	
<b>Connection to an AS/400 system</b>				
The values in this section of the table must match those used in Table 42 on page 460, as indicated.				
10	Remote Node name	2	AS400PU	
11	Network name	1	NETID	
12	Remote LU name	3	AS400LU	
13	Remote Transaction Program name	8	MQSERIES	
14	LU 6.2 CPI-C side information symbolic destination		AS4CPIC	
15	Mode name	17	#INTER	
16	LAN destination address	4	10005A5962EF	
<b>Connection to an OS/390 or MVS/ESA system without CICS</b>				
The values in this section of the table must match those used in Table 36 on page 396, as indicated.				
10	Remote Node name	3	MVSPU	
11	Network name	2	NETID	
12	Remote LU name	4	MVSLU	
13	Remote Transaction Program name	7	MQSERIES	
14	LU 6.2 CPI-C side information symbolic destination		MVSCPIC	
15	Mode name	10	#INTER	
16	LAN destination address	8	400074511092	
<b>Connection to a VSE/ESA system</b>				
The values in this section of the table must match those used in Table 44 on page 485, as indicated.				
10	Remote Node name	2	VSEPU	
11	Network name	1	NETID	
12	Remote LU name	3	VSELU	
13	Remote Transaction Program name	4	MQ01	
14	LU 6.2 CPI-C side information symbolic destination		VSECPIC	
15	Mode name		#INTER	
16	LAN destination address	5	400074511092	

## Explanation of terms

**1 Configuration**

This is the unique ID of the SNA Server configuration you are creating or modifying. Valid values are between 0 and 255.

**2 Network name**

This is the unique ID of the network to which you are connected. Your network administrator will tell you this value.

**3 Control Point name**

This is a unique Control Point name for this workstation. Your network administrator will assign this to you.

**4 Local LU name**

A logical unit (LU) manages the exchange of data between systems. The local LU name is the name of the LU on your system. Your network administrator will assign this to you.

**5 LU 6.2 Transaction Program name**

MQSeries applications trying to converse with this workstation will specify a symbolic name for the program to be run at the receiving end. This will have been defined on the channel definition at the sender. Wherever possible we use a transaction program name of MQSERIES, or in the case of a connection to VSE/ESA, where the length is limited to 4 bytes, use MQTP.

See Table 19 on page 194 for more information.

**6 Local PU name**

This is a unique PU name for this workstation. Your network administrator will assign this to you.

**7 Mode name**

This is the name given to the set of parameters that control the APPC conversation. This name must be defined at each partner system. Your network administrator will assign this to you.

**8 Token-ring adapter address**

This is the 12-character hex address of the token-ring card.

**10 Remote Node name**

This is a meaningful symbolic name by which the connection to a partner node is known. It is used only inside SNA Server setup and is specified by you.

**14 LU 6.2 CPI-C Side Information Symbolic Destination**

This is a name given to the definition of a partner node. You supply the name. It need be unique only on this machine. You will later use the name in the MQSeries sender channel definition.

---

## Establishing a connection using AT&T GIS SNA Server

The following information guides you through the tasks you must perform to create the SNA infrastructure that MQSeries requires. This example creates the definitions for a new partner node and LU on OS/2.

Use **snamgr** to enter the AT&T GIS SNA Server configuration panels. You need root authority to use **snamgr**.

Throughout the following example, only the panels containing information that must be added or updated are shown. Preceding each panel is a list of the sequence of panels that you must invoke to proceed from the initial menu to the relevant customization panel.

**Note:** SNA Server works better in an Xterm session than it does in an ASCII session such as TELNET.

### Defining local node characteristics

Setting up the local node involves the following steps:

1. Configuring the SNA subsystem
2. Defining a mode
3. Defining a local Transaction Program

#### Configuring the SNA subsystem

Proceed through these panels:

- 1 SNA Manager
  - 2 Configuration
    - 3 SNA Subsystem Configuration
      - 4 SNA Subsystem Configuration Creation

```
5          Create a Configuration
Enter a unique configuration identifier (0-255) 010
```

Enter the **configuration identifier (1)**.

```
6          Parameter File Configuration
Will LU 6.2 be used?          Y
```

Enter Y.

```
1          SNA Configuration of the Local Node

Node Parameters:
Node ID of Local Node          00
PU Resource Name (optional)    GISPU
Network Identifier (optional)  NETID
Control Point (CP) Name (optional) GISPU

Local LU 6.2 Parameters:
LU 6.2 Logical Unit Name      GISLU
Max Number of LU 6.2 Sessions 0100
```

Enter the values for **Node ID of Local Node**, **PU Resource Name (6)**, **Network Identifier (2)**, **CP Name (3)**, **LU 6.2 Logical Unit Name (4)**, and **Max Number of LU 6.2 Sessions**.

## Using AT&T GIS SNA Server

### Defining a mode

Proceed through these panels:

2 Local Configuration

Select **Define a mode**.

3 Conversation Mode Definition	
Mode Name	#INTER
Maximum Number of Sessions	008
Number of Locally Controlled Sessions	004
Honor Pending Conversation Requests Before an Existing Session is Terminated?	N
Number of Automatically Established Sessions	004
Code Set to be Used During Transmission of TP Data	E

Enter the values for **Mode Name (7)**, **Maximum Number of Sessions**, and **Number of Locally Controlled Sessions**.

4 Conversation Mode Definition for Max RU	
Send Max RU Size Upper Bound	03840
Send Max RU Size Lower Bound	00128
Receive Max RU Size Upper Bound	03840
Receive Max RU Size Lower Bound	00128

### Defining a local Transaction Program

2 Local Configuration

Select **Define a RECEIVE\_ALLOCATE local TP**.

3 Receive_Allocate Transaction Program Definition	
TP name	MQSERIES _____
TP start type	A (M = Manual, A = Automatic)
receive_allocate timer (seconds)	-1__ (0 - 9999, -1)
Incoming allocate timer (seconds)	-1__ (0 - 9999, -1)
Max number of auto-started TP instances	1_ (1 - 99)

Enter the values for **TP name (5)**, and set the **TP start type** to A.

**Note:** Before this will work you need to associate the TP name with an executable program. You do this outside **snamgr** by creating a symbolic link entry in the directory **/usr/lbin** either before or after you configure SNA Server.

Enter the following commands:

```
cd /usr/lbin  
ln -s /opt/mqm/bin/amqcrs6a MQSeries 5
```

## Connecting to a partner node

To connect to a partner node you need to:

1. Configure a remote node
2. Define a partner LU
3. Add a CPI-C Side Entry

## Configuring a remote node

Proceed through these panels:

2 Local Configuration

Select **End Local Configuration**.

1 Remote Node Definition

Select **Peer Node Definition**.

```

2 Remote Node Configuration
Remote Node Name      0S2PU
Type of Link Connection  TR
SNA Logical Connection ID  00
Link to Backup (Optional)  ___
  
```

Enter the values for **Remote Node Name** (**10**), **Type of Link Connection**, and **SNA Logical Connection ID**.

```

3 SNA/TR Configuration for Connection 01
Token Ring Adapter ID  01
Maximum Send BTU Length  1033
Local XID              03E00018
Data link role of local system  NEG_
Remote DLSAP          04
Remote MAC Address    10005AFC5D83
Route Discovery Command  T
Broadcast Timer       1_
  
```

Enter the values for **Token Ring Adapter ID**, **Local XID** (**9**), and **Remote MAC address** (**16**).

```

4 Configuration of TR Adapter 01 for Connection 01
Local DLSAP          04
Adapter Type        i1d_
  
```

## Using AT&T GIS SNA Server

### Defining a partner LU

Proceed through these panels:

1 LU 6.2 Logical Unit Definition

To complete the definition of Remote Peer Node, OS2, you need to define at least one Remote LU 6.2 Logical Unit.

Press CONT to Continue.

2 Partner LU 6.2 Definition

Locally Known Name OS2LU

Network Identifier NETID

Network Name (LUNAME) OS2LU

Uninterpreted Name OS2LU

Session Capability P

Enter the values for **Locally Known Name** ( **12** ), **Network Identifier** ( **11** ), **Network Name (LUNAME)** ( **12** ), and **Uninterpreted Name** ( **12** ),

3 Automatic Activation

Auto Activate at Start of Day? N

4 LU 6.2 Partner Definition

Do you want to define another remote LU 6.2 Logical Unit in the remote node, OS2? N

### Adding a CPI-C Side Entry

Proceed through these panels:

1 SNA MANAGER

2 Configuration

3 CPI-C Side Information

4 Add a CPI-C Side Information File

Enter the CPI-C Side Information File Name OS2CPIC

(This name is the Symbolic Destination Name used by the CPI-C program to reference side information.)

Enter the name of the **CPI-C Side Information File** ( **14** ).



```

5                               Add CPI-C Side Information

Symbolic destination name: OS2CPIC

Partner LU name OS2LU

Mode name #INTER

TP name MQSERIES

Conversation security type NONE___

Security user ID _____

Security password _____

```

Enter the values for **Partner LU name** ( **12** ), **Mode name** ( **15** ), and **TP name** ( **13** ).

### What next?

The LU 6.2 connection is now established. You are ready to complete the configuration. Go to “MQSeries for AT&T GIS UNIX configuration”.

---

## Establishing a TCP connection

1. Edit the file `/etc/services`.

**Note:** To edit the `/etc/services` file, you must be logged in as a superuser or root. If you do not have the following line in that file, add it as shown:

```
MQSeries      1414/tcp      # MQSeries channel listener
```

2. Edit the file `/usr/etc/inetd.conf`. If you do not have the following line in that file, add it as shown:

```
MQSeries stream tcp nowait root /opt/mqm/bin/amqcrsta amqcrsta
[-m queue.manager.name]
```

3. Find the process ID of the `inetd` with the command:

```
ps -ef | grep inetd
```

4. Run the command:

```
kill -1 inetd processid
```

The command `kill -1` can be unreliable. If it doesn't work, use the command `kill -9` and then restart `/usr/etc/inetd` manually.

### What next?

The LU 6.2 connection is now established. You are ready to complete the configuration. Go to “MQSeries for AT&T GIS UNIX configuration”.

---

## MQSeries for AT&T GIS UNIX configuration

Before beginning the installation process ensure that you have first created the `mqm` user and group, and set the password.

Start any channel using the command:

```
runmqchl -c channel.name
```

## AT&T GIS UNIX configuration

### Notes:

1. Sample programs are installed in `/opt/mqm/samp`.
2. Error logs are stored in `/var/mqm/qmgrs/qmgrname/errors`.
3. When you are using the command interpreter **runmqsc** to enter administration commands, a `+` at the end of a line indicates that the next line is a continuation. Ensure that there is a space between the last parameter and the continuation character.

## Basic configuration

1. Create the queue manager from the UNIX prompt using the command:

```
crtmqm -u dlqname -q gis
```

where:

*gis* Is the name of the queue manager

`-q` Indicates that this is to become the default queue manager

`-u dlqname`

Specifies the name of the undeliverable message queue

2. Start the queue manager from the UNIX prompt using the command:

```
strmqm gis
```

where *gis* is the name given to the queue manager when it was created.

3. Before creating your own objects you must first create the system default objects. These are a number of definitions for required objects and templates on which user definitions will be modelled.

Create the default objects from the UNIX prompt using the command:

```
runmqsc gis < /opt/mqm/samp/amqscoma.tst > defobj.out
```

where *gis* is the name of the queue manager. Display the file `defobj.out` and ensure that all objects were created successfully. There is a report at the end of the file.

## Channel configuration

The following section details the configuration to be performed on the AT&T GIS UNIX queue manager to implement the channel described in Figure 32 on page 97.

In each case the MQSC command is shown. Either start **runmqsc** from a UNIX prompt and enter each command in turn, or build a command file of the same format as `amqscoma.tst` and use it as before to create the objects.

Examples are given for connecting MQSeries for AT&T GIS UNIX and MQSeries for OS/2 Warp. If you wish to connect to another MQSeries product use the appropriate set of values from the table in place of those for OS/2.

**Note:** The words in **bold** are user-specified and reflect the names of MQSeries objects used throughout these examples. If you change the names used here, ensure that you also change the other references made to these objects throughout this book. All others are keywords and should be entered as shown.

Table 26. Configuration worksheet for MQSeries for AT&T GIS UNIX

ID	Parameter Name	Reference	Example Used	User Value
<b>Definition for local node</b>				
<b>A</b>	Queue Manager Name		GIS	
<b>B</b>	Local queue name		GIS.LOCALQ	
<b>Connection to MQSeries for OS/2 Warp</b>				
The values in this section of the table must match those used in Table 15 on page 164, as indicated.				
<b>C</b>	Remote queue manager name	<b>A</b>	OS2	
<b>D</b>	Remote queue name		OS2.REMOTEQ	
<b>E</b>	Queue name at remote system	<b>B</b>	OS2.LOCALQ	
<b>F</b>	Transmission queue name		OS2	
<b>G</b>	Sender (SNA) channel name		GIS.OS2.SNA	
<b>H</b>	Sender (TCP/IP) channel name		GIS.OS2.TCP	
<b>I</b>	Receiver (SNA) channel name	<b>G</b>	OS2.GIS.SNA	
<b>J</b>	Receiver (TCP/IP) channel name	<b>H</b>	OS2.GIS.TCP	
<b>Connection to MQSeries for Windows NT</b>				
The values in this section of the table must match those used in Table 17 on page 185, as indicated.				
<b>C</b>	Remote queue manager name	<b>A</b>	WINNT	
<b>D</b>	Remote queue name		WINNT.REMOTEQ	
<b>E</b>	Queue name at remote system	<b>B</b>	WINNT.LOCALQ	
<b>F</b>	Transmission queue name		WINNT	
<b>G</b>	Sender (SNA) channel name		GIS.WINNT.SNA	
<b>H</b>	Sender (TCP/IP) channel name		GIS.WINNT.TCP	
<b>I</b>	Receiver (SNA) channel name	<b>G</b>	WINNT.GIS.SNA	
<b>J</b>	Receiver (TCP) channel name	<b>H</b>	WINNT.GIS.TCP	
<b>Connection to MQSeries for AIX</b>				
The values in this section of the table must match those used in Table 21 on page 211, as indicated.				
<b>C</b>	Remote queue manager name	<b>A</b>	AIX	
<b>D</b>	Remote queue name		AIX.REMOTEQ	
<b>E</b>	Queue name at remote system	<b>B</b>	AIX.LOCALQ	
<b>F</b>	Transmission queue name		AIX	
<b>G</b>	Sender (SNA) channel name		GIS.AIX.SNA	
<b>H</b>	Sender (TCP) channel name		GIS.AIX.TCP	
<b>I</b>	Receiver (SNA) channel name	<b>G</b>	AIX.GIS.SNA	
<b>J</b>	Receiver (TCP) channel name	<b>H</b>	AIX.GIS.TCP	
<b>Connection to MQSeries for DIGITAL UNIX (Compaq Tru64 UNIX)</b>				
The values in this section of the table must match those used in Table 22 on page 216, as indicated.				
<b>C</b>	Remote queue manager name	<b>A</b>	DECUX	
<b>D</b>	Remote queue name		DECUX.REMOTEQ	
<b>E</b>	Queue name at remote system	<b>B</b>	DECUX.LOCALQ	
<b>F</b>	Transmission queue name		DECUX	
<b>H</b>	Sender (TCP) channel name		DECUX.GIS.TCP	
<b>J</b>	Receiver (TCP) channel name	<b>H</b>	GIS.DECUX.TCP	
<b>Connection to MQSeries for HP-UX</b>				
The values in this section of the table must match those used in Table 24 on page 239, as indicated.				

## AT&T GIS UNIX configuration

Table 26. Configuration worksheet for MQSeries for AT&T GIS UNIX (continued)

ID	Parameter Name	Reference	Example Used	User Value
<b>C</b>	Remote queue manager name	<b>A</b>	HPUX	
<b>D</b>	Remote queue name		HPUX.REMOTEQ	
<b>E</b>	Queue name at remote system	<b>B</b>	HPUX.LOCALQ	
<b>F</b>	Transmission queue name		HPUX	
<b>G</b>	Sender (SNA) channel name		GIS.HPUX.SNA	
<b>H</b>	Sender (TCP) channel name		GIS.HPUX.TCP	
<b>I</b>	Receiver (SNA) channel name	<b>G</b>	HPUX.GIS.SNA	
<b>J</b>	Receiver (TCP) channel name	<b>H</b>	HPUX.GIS.TCP	
<b>Connection to MQSeries for Sun Solaris</b>				
The values in this section of the table must match those used in Table 28 on page 272, as indicated.				
<b>C</b>	Remote queue manager name		SOLARIS	
<b>D</b>	Remote queue name		SOLARIS.REMOTEQ	
<b>E</b>	Queue name at remote system	<b>B</b>	SOLARIS.LOCALQ	
<b>F</b>	Transmission queue name		SOLARIS	
<b>G</b>	Sender (SNA) channel name		GIS.SOLARIS.SNA	
<b>H</b>	Sender (TCP/IP) channel name		GIS.SOLARIS.TCP	
<b>I</b>	Receiver (SNA) channel name	<b>G</b>	SOLARIS.GIS.SNA	
<b>J</b>	Receiver (TCP/IP) channel name	<b>H</b>	SOLARIS.GIS.TCP	
<b>Connection to MQSeries for AS/400</b>				
The values in this section of the table must match those used in Table 43 on page 472, as indicated.				
<b>C</b>	Remote queue manager name		AS400	
<b>D</b>	Remote queue name		AS400.REMOTEQ	
<b>E</b>	Queue name at remote system	<b>B</b>	AS400.LOCALQ	
<b>F</b>	Transmission queue name		AS400	
<b>G</b>	Sender (SNA) channel name		GIS.AS400.SNA	
<b>H</b>	Sender (TCP/IP) channel name		GIS.AS400.TCP	
<b>I</b>	Receiver (SNA) channel name	<b>G</b>	AS400.GIS.SNA	
<b>J</b>	Receiver (TCP) channel name	<b>H</b>	AS400.GIS.TCP	
<b>Connection to MQSeries for OS/390 or MVS/ESA without CICS</b>				
The values in this section of the table must match those used in Table 37 on page 406, as indicated.				
<b>C</b>	Remote queue manager name		MVS	
<b>D</b>	Remote queue name		MVS.REMOTEQ	
<b>E</b>	Queue name at remote system	<b>B</b>	MVS.LOCALQ	
<b>F</b>	Transmission queue name		MVS	
<b>G</b>	Sender (SNA) channel name		GIS.MVS.SNA	
<b>H</b>	Sender (TCP) channel name		GIS.MVS.TCP	
<b>I</b>	Receiver (SNA) channel name	<b>G</b>	MVS.GIS.SNA	
<b>J</b>	Receiver (TCP) channel name	<b>H</b>	MVS.GIS.TCP	
<b>Connection to MQSeries for VSE/ESA</b>				
The values in this section of the table must match those used in Table 45 on page 490, as indicated.				
<b>C</b>	Remote queue manager name		VSE	
<b>D</b>	Remote queue name		VSE.REMOTEQ	
<b>E</b>	Queue name at remote system	<b>B</b>	VSE.LOCALQ	
<b>F</b>	Transmission queue name		VSE	

Table 26. Configuration worksheet for MQSeries for AT&T GIS UNIX (continued)

ID	Parameter Name	Reference	Example Used	User Value
<b>G</b>	Sender channel name		GIS.VSE.SNA	
<b>I</b>	Receiver channel name	<b>G</b>	VSE.GIS.SNA	

**MQSeries for AT&T GIS UNIX sender-channel definitions using SNA**

```
def ql (OS2) + F
  usage(xmitq) +
  replace
```

```
def qr (OS2.REMOTEQ) + D
  rname(OS2.LOCALQ) + E
  rqmname(OS2) + C
  xmitq(OS2) + F
  replace
```

```
def chl (GIS.OS2.SNA) chltype(sdr) + G
  trptype(lu62) +
  conname('OS2CPIC') + 14
  xmitq(OS2) + F
  replace
```

**MQSeries for AT&T GIS UNIX receiver-channel definitions using SNA**

```
def ql (GIS.LOCALQ) replace B
```

```
def chl (OS2.GIS.SNA) chltype(rcvr) + I
  trptype(lu62) +
  replace
```

**MQSeries for AT&T GIS UNIX sender-channel definitions using TCP**

```
def ql (OS2) + F
  usage(xmitq) +
  replace
```

```
def qr (OS2.REMOTEQ) + D
  rname(OS2.LOCALQ) + E
  rqmname(OS2) + C
  xmitq(OS2) + F
  replace
```

```
def chl (GIS.OS2.TCP) chltype(sdr) + H
  trptype(tcp) +
  conname(remote_tcpip_hostname) +
  xmitq(OS2) + F
  replace
```

**MQSeries for AT&T GIS UNIX receiver-channel definitions using TCP/IP**

```
def ql (GIS.LOCALQ) replace B
```

```
def chl (OS2.GIS.TCP) chltype(rcvr) + J
  trptype(tcp) +
  replace
```

## AT&T GIS UNIX configuration

---

## Chapter 18. Example configuration - IBM MQSeries for Sun Solaris

This chapter gives an example of how to set up communication links from MQSeries for Sun Solaris to MQSeries products on the following platforms:

- OS/2
- Windows NT
- AIX
- Digital UNIX
- HP-UX
- AT&T GIS UNIX<sup>6</sup>
- OS/400
- OS/390 or MVS/ESA without CICS
- VSE/ESA

First it describes the parameters needed for an LU 6.2 connection, then it describes “Establishing a connection using SunLink Version 9.1” on page 261 and “Establishing a TCP connection” on page 271.

Once the connection is established, you need to define some channels to complete the configuration. This is described in “MQSeries for Sun Solaris configuration” on page 271.

See “Chapter 7. Example configuration chapters in this book” on page 97 for background information about this chapter and how to use it.

---

### Configuration parameters for an LU 6.2 connection

Table 27 presents a worksheet listing all the parameters needed to set up communication from Sun Solaris to one of the other MQSeries platforms. The worksheet shows examples of the parameters, which have been tested in a working environment, and leaves space for you to fill in your own values. An explanation of the parameter names follows the worksheet. Use the worksheet in this chapter in conjunction with the worksheet in the chapter for the platform to which you are connecting.

### Configuration worksheet

Use this worksheet to record the values you use for your configuration. Where numbers appear in the Reference column they indicate that the value must match that in the appropriate worksheet elsewhere in this book. The examples that follow in this chapter refer back to the values in the ID column. The entries in the Parameter Name column are explained in “Explanation of terms” on page 260.

Table 27. Configuration worksheet for SunLink Version 9.1

ID	Parameter Name	Reference	Example	User Value
<i>Parameters for local node</i>				
<b>1</b>	PU 2.1 server name		SOLSERV	
<b>2</b>	Network name		NETID	

---

6. This platform has become NCR UNIX SVR4 MP-RAS, R3.0

## Sun Solaris and LU 6.2

Table 27. Configuration worksheet for SunLink Version 9.1 (continued)

ID	Parameter Name	Reference	Example	User Value
<b>3</b>	CP name		SOLARPU	
<b>4</b>	Line name		MQLINE	
<b>5</b>	Local MAC address		08002071CC8A	
<b>6</b>	Local terminal ID		05D 310D6	
<b>7</b>	Local LU name		SOLARLU	
<b>8</b>	TP name		MQSERIES	
<b>9</b>	Command Path		home/interops/crs6a	
<b>Connection to an OS/2 system</b>				
The values in this section of the table must match those used in Table 14 on page 138, as indicated.				
<b>10</b>	Unique session name		OS2SESS	
<b>11</b>	Network name	<b>2</b>	NETID	
<b>12</b>	DLC name		OS2QMGR	
<b>13</b>	Remote CP name		OS2PU	
<b>14</b>	Local LSAP		x'04', x'08', x'0C', ...	
<b>15</b>	Partner LU	<b>6</b>	OS2LU	
<b>16</b>	TP name	<b>8</b>	MQSERIES	
<b>17</b>	Mode name	<b>17</b>	#INTER	
<b>18</b>	CPI-C file name		/home/mqstart/OS2CPIC	
<b>19</b>	Remote MAC address	<b>10</b>	10005AFC5D83	
<b>Connection to a Windows NT system</b>				
The values in this section of the table must match those used in Table 16 on page 170, as indicated.				
<b>10</b>	Unique session name		WINNTSESS	
<b>11</b>	Network name	<b>2</b>	NETID	
<b>12</b>	DLC name		NTQMGR	
<b>13</b>	Remote CP name		WINNTPU	
<b>14</b>	Local LSAP		x'04', x'08', x'0C', ...	
<b>15</b>	Partner LU	<b>6</b>	WINNTLU	
<b>16</b>	TP name	<b>8</b>	MQSERIES	
<b>17</b>	Mode name	<b>17</b>	#INTER	
<b>18</b>	CPI-C file name		/home/mqstart/NTCPIC	
<b>19</b>	Remote MAC address	<b>10</b>	10005AFC5D83	
<b>Connection to an AIX system</b>				
The values in this section of the table must match those used in Table 20 on page 197, as indicated.				
<b>10</b>	Unique session name		AIXSESS	
<b>11</b>	Network name	<b>1</b>	NETID	
<b>12</b>	DLC name		AIXQMGR	
<b>13</b>	Remote CP name	<b>2</b>	AIXPU	
<b>14</b>	Local LSAP		x'04', x'08', x'0C', ...	
<b>15</b>	Partner LU	<b>4</b>	AIXLU	
<b>16</b>	TP name	<b>6</b>	MQSERIES	
<b>17</b>	Mode name	<b>14</b>	#INTER	
<b>18</b>	CPI-C file name		/home/mqstart/AIXCPIC	
<b>19</b>	Remote MAC address	<b>15</b>	10005AFC5D83	



Table 27. Configuration worksheet for SunLink Version 9.1 (continued)

ID	Parameter Name	Reference	Example	User Value
<b>Connection to an HP-UX system</b>				
The values in this section of the table must match those used in Table 23 on page 219, as indicated.				
10	Unique session name		HPUXSESS	
11	Network name	4	NETID	
12	DLC name		HPUXQMGR	
13	Remote CP name		HPUXPU	
14	Local LSAP		x'04', x'08', x'0C', ...	
15	Partner LU	5	HPUXLU	
16	TP name	7	MQSERIES	
17	Mode name	17	#INTER	
18	CPI-C file name		/home/mqstart/HPCPIC	
19	Remote MAC address	19	10005AFC5D83	
<b>Connection to an AT&amp;T GIS UNIX system</b>				
The values in this section of the table must match those used in the Table 25 on page 243, as indicated.				
10	Unique session name		GISSESS	
11	Network name	2	NETID	
12	DLC name		GISQMGR	
13	Remote CP name		GISPU	
14	Local LSAP		x'04', x'08', x'0C', ...	
15	Partner LU	6	GISLU	
16	TP name	8	MQSERIES	
17	Mode name	17	#INTER	
18	CPI-C file name		/home/mqstart/ATTCPIC	
19	Remote MAC address	10	10005AFC5D83	
<b>Connection to an AS/400 system</b>				
The values in this section of the table must match those used in Table 42 on page 460, as indicated.				
10	Unique session name		AS400SESS	
11	Network name	2	NETID	
12	DLC name		ASQMGR	
13	Remote CP name		AS400PU	
14	Local LSAP		x'04', x'08', x'0C', ...	
15	Partner LU	6	AS400LU	
16	TP name	8	MQSERIES	
17	Mode name	17	#INTER	
18	CPI-C file name		/home/mqstart/400CPIC	
19	Remote MAC address	10	10005AFC5D83	
<b>Connection to an OS/390 or MVS/ESA system without CICS</b>				
The values in this section of the table must match those used in Table 36 on page 396, as indicated.				
10	Unique session name		MVSESS	
11	Network name	2	NETID	
12	DLC name		MVSMGR	
13	Remote CP name		MVSPU	
14	Local LSAP		x'04', x'08', x'0C', ...	
15	Partner LU	6	MVSLU	

## Sun Solaris and LU 6.2

Table 27. Configuration worksheet for SunLink Version 9.1 (continued)

ID	Parameter Name	Reference	Example	User Value
16	TP name	8	MQSERIES	
17	Mode name	17	#INTER	
18	CPI-C file name		/home/mqstart/MVSCPIC	
19	Remote MAC address	10	10005AFC5D83	
<b>Connection to a VSE/ESA system</b>				
The values in this section of the table must match those used in Table 44 on page 485, as indicated.				
10	Unique session name		VSESESS	
11	Network name	2	NETID	
12	DLC name		VSEQMGR	
13	Remote CP name		VSEPU	
14	Local LSAP		x'04', x'08', x'0C', ...	
15	Partner LU	6	VSELU	
16	TP name	8	MQSERIES	
17	Mode name	17	#INTER	
18	CPI-C file name		/home/mqstart/VSECPIC	
19	Remote MAC address	10	10005AFC5D83	

## Explanation of terms

### 1 PU2.1 server name

This is the name of the PU2.1 server for the local control point.

### 2 Network name

This is the unique ID of the network to which you are connected. It is an alphanumeric value and can be 1-8 characters long. The network name works with the Control Point name to uniquely identify a system. Your network administrator will tell you the value.

### 3 CP name

This is the unique Control Point name for this workstation. Your network administrator will assign this to you.

### 4 Line name

This is the name that identifies the connection to the LAN.

### 5 Local MAC address

This is the network address of the token-ring card. The address to be specified is found in the ether value displayed in response to the `ifconfig tr0` command issued at a root level of authority. (Tr0 is the name of the machine's token-ring interface.) If you do not have the necessary level of authority, your Sun Solaris system administrator can tell you the value.

### 6 Local terminal ID

This is the unique ID of this workstation. On other platforms this is often referred to as the *Exchange ID* or *XID*. Your network administrator will assign this ID for you.

### 7 Local LU name

An LU manages the exchange of data between transactions. The local LU name is the name of the LU on your system. Your network administrator will assign this to you.

**8 TP name**

MQSeries applications trying to converse with this workstation will specify a symbolic name for the program to be run at the receiving end. This will have been defined on the channel definition at the sender. For simplicity, wherever possible use a transaction program name of MQSERIES, or in the case of a connection to VSE/ESA, where the length is limited to 4 bytes, use MQ01.

See Table 19 on page 194 for more information.

**9 TP path**

This is the path and name of the script file that invokes the MQSeries program to run.

**10 Unique session name**

This is the unique name of the Partner LU/Mode definition.

**12 DLC name**

This is the name of the link to the remote system.

**13 Remote CP name**

This is the name of the control point on the remote system.

**18 CPI-C file name**

This is the full path and name of the file which holds CPI-C side information for a partner system. There must be a separate CPI-C file for each partner. For increased flexibility, include the full path and file name in the MQSeries sender channel definition.

---

## Establishing a connection using SunLink Version 9.1

This section describes how to establish a connection using SunLink Version 9.1 The topics discussed are:

- SunLink 9.0 base configuration
- Invokable TPs
- CPI-C side information

### SunLink 9.1 base configuration

To start the SunLink 9.1 graphical interface:

1. Enter **sungmi** at the command line.

It is assumed that the domain, manager systems, and default system were defined during installation.

2. On the main screen, highlight **Config1** in the resource tree and select **File** and **Open**. A window entitled **Connect to domain** appears:

## Using SunLink

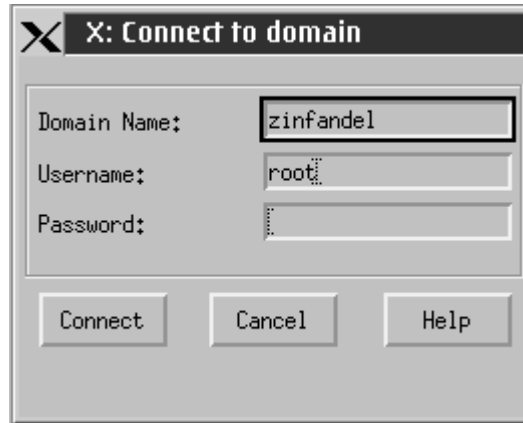

3. Enter required details to connect to the required domain.

## Configuring a PU 2.1 server

1. Double click on **Systems** in the resource tree to display a list of systems.
2. Double click on **System name** in the resource tree to open its subordinate entries.
3. Using the right mouse button, highlight **PU2.1 Servers** in the resource tree and select **New** and **PU2.1 Server** from the pop-up menu. A window entitled **Create PU2.1 Server** appears:

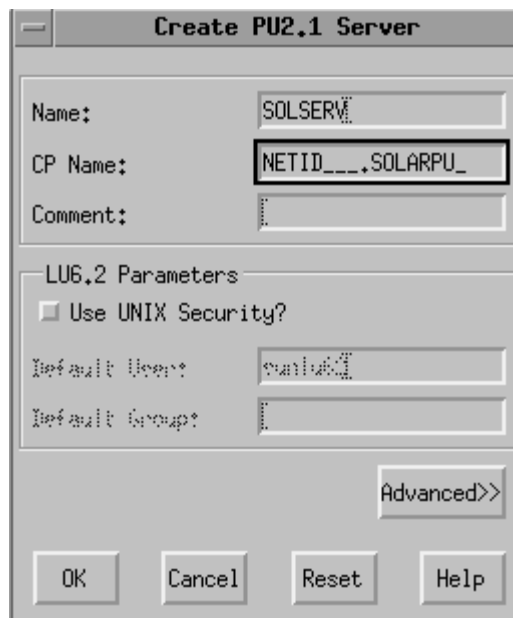

4. Enter the **PU2.1 Name** ( **1** ).
5. Enter the **CP Name**. This consists of the **Network Name** ( **2** ) and the **CP Name** ( **3** ).
6. Click on **Advanced >>**. The advanced window appears:

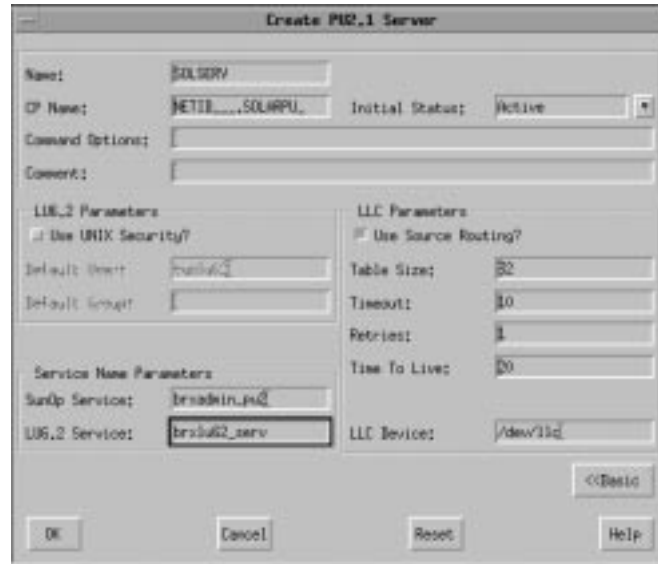

7. Enter the **SunOp Service** and **LU6.2 Service**
8. Click on **OK** when you are happy with the settings.

## Adding a LAN connection

1. Double click on **PU2.1 Servers** in the resource tree to display the name of the PU2.1 server.
2. Using the right mouse button, highlight the server name in the resource tree and select **New** and **LAN Connection** from the pop-up menu. A window entitled **Create LAN Connection** appears:



3. Enter a **Line Name** ( **4** ) and **Local MAC Address** ( **5** ).
4. Click on **Advanced>>** The advanced window appears:

## Using SunLink

**Create LAN Connection**

Line Name: MQLINE

Comment:

Device Information

Type: Token-Ring (802,5)

Device: /dev/trp

Interface:

PPA: 0

Addressing

Local MAC Address: X'08002071CC8A'

Functional Address: X'-----'

Group Address: X'-----'

Parameters

LAN Speed: 16Mbps

Maximum data size: 4472

<<Basic

OK Cancel Reset Help

5. Check the **LAN Speed** is correct.
6. Click on **OK** when you are happy with the settings.

## Configuring a connection to a remote PU

1. Double click the **PU2.1 server name** in the resource tree to open its subordinate entries.
2. Double click on **LAN Connections**.
3. Using the right mouse button, highlight the LAN connection name in the resource tree and select **New** and **DLC** from the pop-up menu. A window entitled **Create DLC** appears:

**Create DLC**

DLC Name: OS2QMGR

Comment:

Addresses

Remote MAC Address: X'10005AFC5D83

Advanced>>

OK Cancel Reset Help

4. Enter the **DLC Name** ( **12** ) and **Remote MAC Address** ( **19** ).
5. Click on **Advanced>>**. A window entitled **Create DLC (advanced)** appears:

**Create DLC**

DLC Name: OS2QMGR Initial Status: Active

Comment:

Addresses

Group LSAP for PU: X'05' Local LSAP for PU: X'04'

Remote MAC Address: X'10005AFC5D83' Remote LSAP: X'04'

Identification

Local Terminal ID: X'05331006' Remote Terminal ID: X'00000000'

Local CP Name: NETIE.....SPOU#PU Remote CP Name: NETIE.....05CP

Link Parameters

Automatic connect?  Suppress NCTPU?  Limited Resource Link?

Max data: 4096 Role: Negotiable Response Count: 7

Send window: 7 Receive Window: 7 Response Timer: 100 ms

Error Handling

Inactivity timeout: 30 s Reply timeout: 1 s T-Ext timeout: 10 s

Maximum retries: 3

Dynamic Windowing Parameters

Ack count: 7 Window Increment: 1

<<Basic

OK Cancel Reset Help

6. Enter the **Local LSAP** for this DLC ( **14** ), **Local Terminal ID** ( **6** ), and **Remote CP Name** ( **13** ).
7. When you are happy with the settings, click on **OK**.

## Configuring an independent LU

1. Double click on **Systems** in the resource tree to display a list of systems.
2. Double click on the system name to open its subordinate entries.
3. Double click on **PU2.1 Servers** to display a list of servers.
4. Double click on the PU2.1 server name to open its subordinate entries.

## Using SunLink

- From the main window, select **Edit, New, and Independent LU** to display the **Create Independent LU** window:

The screenshot shows a dialog box titled "Create Independent LU". It has a "Name:" field containing "SOLARLU" and a "Comment:" field. Below these is an "Access Control" section with two empty boxes and labels "Click to Add" and "Click to Remove". At the bottom right is an "Advanced>>" button. At the bottom are "OK", "Cancel", "Reset", and "Help" buttons.

- Enter the **Local LU Name** (**7**).
- Click on **Advanced>>**. An advanced **Create Independent LU** window appears:



**Create Independent LU**

Name: SOLARLU

Network Qual Name: NETID\_...,SOLARLU\_

Comment:

Session Parameters:

Session Limit: 1024

Allow Partner LU to queue BIND Rsp?

Sync level SYNCPT Supported?

Access Control

Click to Add      Click to Remove

<<Basic

OK    Cancel    Reset    Help

8. Enter the **Network Qual Name**. This consists of the **Network Name** ( **2** ) and the **Local LU** ( **7** ).
9. Click on **OK**

## Configuring a partner LU

1. Double click on the PU2.1 server name in the resource tree to open its subordinate entries.
2. From the main window, select **Edit**, **New**, and **Partner LU** to display the **Create Partner LU** window:

## Using SunLink

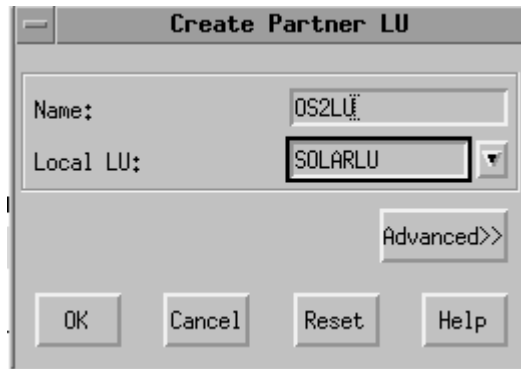

3. Enter the **Partner LU** ( **15** ) and the **Local LU Name** ( **7** ).
4. Click on **Advanced>>**. The advanced **Create Partner LU** window appears:

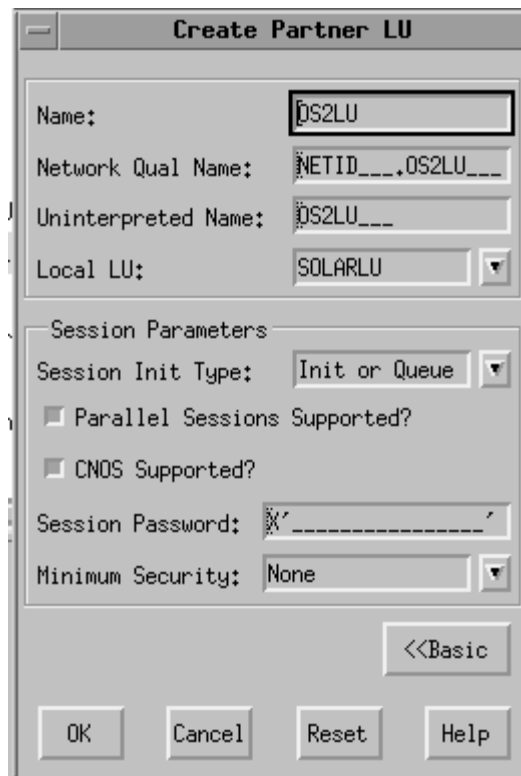

5. Choose a **Local LU** from the drop-down list.
6. Click on **OK**.

## Configuring the session mode

1. Double click on the PU2.1 server name to open its subordinate entries.
2. Double click on **Partner LU** in the resource tree to display a list of partner LUs.
3. Click on the partner LU to select it.
4. From the main window, select **Edit, New, and Mode** to display the **Create Mode** window:

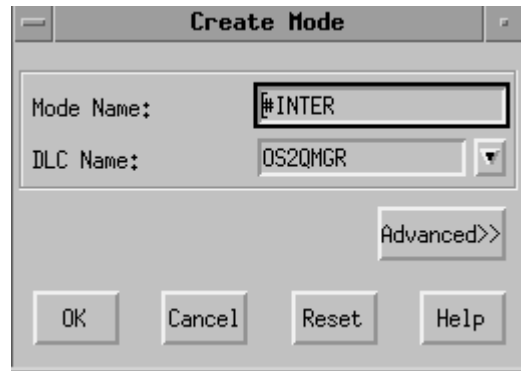

5. Enter the **Mode Name** ( **17** ) and **DLC Name** ( **12** ).
6. Click on **Advanced>>**. The advanced **Create Mode** window appears:

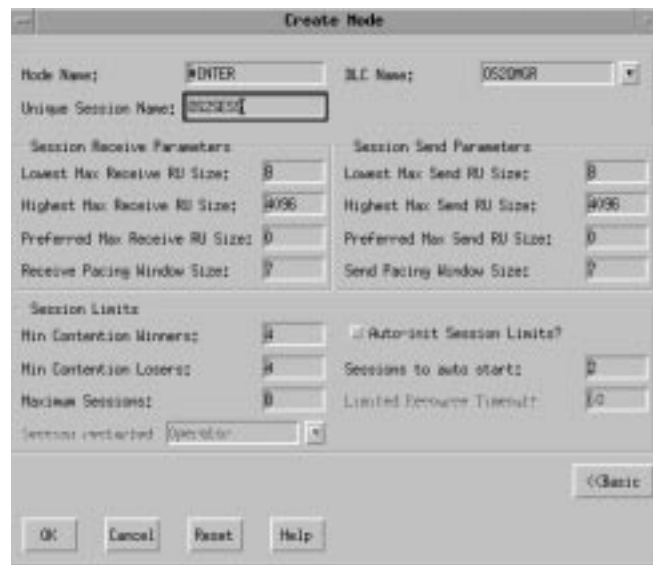

7. Enter the **Unique Session Name** ( **10** ).
8. When you are happy with the settings, click on **OK**.

## Configuring a transaction program

1. Double click on the PU2.1 server name to open its subordinate entries.
2. Click on **Transaction Programs** in the resource tree to select it.
3. From the main window, select **Edit, New, and Transaction Program** to display the **Create Transaction Program** window:

## Using SunLink

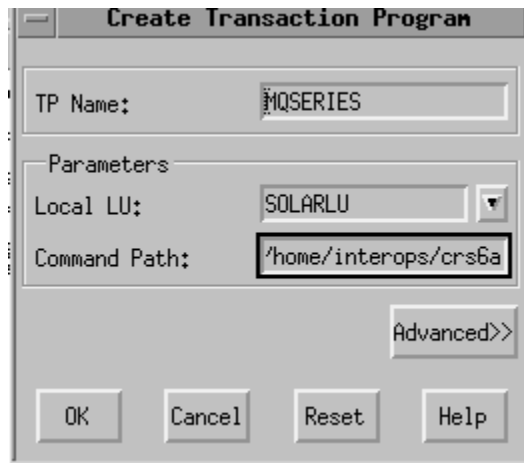

4. Enter the **TP Name** ( **8** ) and **Local LU** ( **7** ).
5. Enter a path to the invocable TP in the **Command Path** ( **9** ) field:
6. Click on **Advanced>>**. The advanced **Create Transaction Program** window appears:

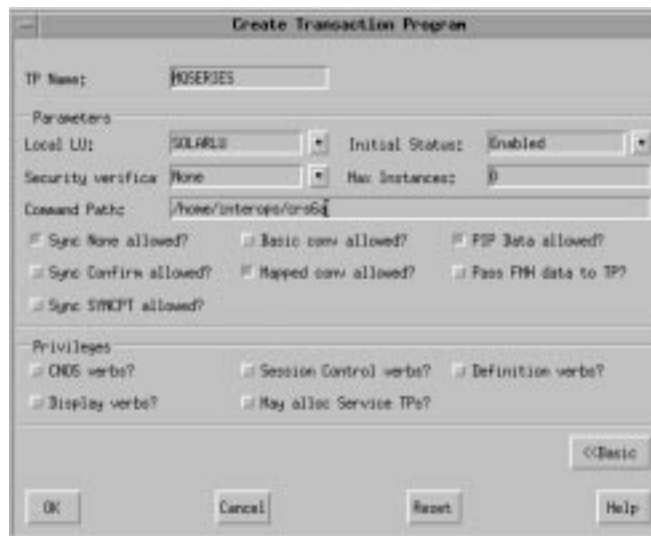

7. When you are happy with the settings, click on **OK**.

### Invokable TP path

In order to set required environment variables a script file should be defined for each invocable TP containing the following:

```
#!/bin/ksh
export APPC_GATEWAY=zinfandel
export APPC_LOCAL_LU=SOLARLU
/opt/mqm/bin/amqcrs6a -m SOLARIS -n MQSERIES
```

### CPI-C side information

In common with most other platforms, MQSeries for Sun Solaris Version 5.1 uses CPI-C side information files ( **18** ) to hold information about its partner systems. In SunLink 9.1, these are ASCII files (one per partner).

```
PTNR_LU_NAME = OS2LU
MODE_NAME = #INTER
TP_NAME = MQSERIES
SECURITY = NONE
```

```
15
17
16
```

Figure 35. CPI-C side information file for SunLink Version 9.0

The location of the file must be specified either explicitly in the `conname` parameter of the sender channel definition or in the search path. It is better to specify it fully in the `conname` parameter because the value of the `PATH` environment variable can vary from user to user.

## What next?

The connection is now established. You are ready to complete the configuration. Go to “MQSeries for Sun Solaris configuration”.

---

## Establishing a TCP connection

To establish a TCP connection, follow these steps.

1. Edit the file `/etc/services`.

**Note:** To edit the `/etc/services` file, you must be logged in as a superuser or root. If you do not have the following line in that file, add it as shown:

```
MQSeries      1414/tcp      # MQSeries channel listener
```

2. Edit the file `/etc/inetd.conf`. If you do not have the following line in that file, add it as shown:

```
MQSeries stream tcp nowait mqm /opt/mqm/bin/amqcrsta amqcrsta
[-m queue.manager.name]
```

3. Find the process ID of the `inetd` with the command:

```
ps -ef | grep inetd
```

4. Run the command:

```
kill -1 inetd processid
```

## What next?

The TCP/IP connection is now established. You are ready to complete the configuration. Go to “MQSeries for Sun Solaris configuration”.

---

## MQSeries for Sun Solaris configuration

Before beginning the installation process ensure that you have first created the `mqm` user and group, and set the password.

Start any channel using the command:

```
runmqchl -c channel.name
```

### Notes:

1. Sample programs are installed in `/opt/mqm/samp`.
2. Error logs are stored in `/var/mqm/qmgrs/qmgrname/errors`.
3. When you are using the command interpreter `runmqsc` to enter administration commands, a `+` at the end of a line indicates that the next line is a continuation. Ensure that there is a space between the last parameter and the continuation character.

## Sun Solaris configuration

- For an SNA or LU6.2 channel, if you experience an error when you try to load the communications library, probably file `liblu62.so` cannot be found. A likely solution to this problem is to add its location, which is probably `/opt/SUNWlu62`, to `LD_LIBRARY_PATH`.

## Basic configuration

- Create the queue manager from the UNIX prompt using the command:

```
crtmqm -u dlqname -q solaris
```

where:

*solaris*

Is the name of the queue manager

**-q** Indicates that this is to become the default queue manager

**-u *dlqname***

Specifies the name of the undeliverable message queue

This command creates a queue manager and a set of default objects.

- Start the queue manager from the UNIX prompt using the command:

```
strmqm solaris
```

where *solaris* is the name given to the queue manager when it was created.

## Channel configuration

The following section details the configuration to be performed on the Sun Solaris queue manager to implement the channel described in Figure 32 on page 97.

The MQSC command to create each object is shown. Either start **runmqsc** from a UNIX prompt and enter each command in turn, or build the commands into a command file.

Examples are given for connecting MQSeries for Sun Solaris and MQSeries for OS/2 Warp. If you wish to connect to another MQSeries product use the appropriate set of values from the table in place of those for OS/2.

**Note:** The words in **bold** are user-specified and reflect the names of MQSeries objects used throughout these examples. If you change the names used here, ensure that you also change the other references made to these objects throughout this book. All others are keywords and should be entered as shown.

Table 28. Configuration worksheet for MQSeries for Sun Solaris

ID	Parameter Name	Reference	Example Used	User Value
<b>Definition for local node</b>				
<b>A</b>	Queue Manager Name		SOLARIS	
<b>B</b>	Local queue name		SOLARIS.LOCALQ	
<b>Connection to MQSeries for OS/2 Warp</b>				
The values in this section of the table must match those used in Table 15 on page 164, as indicated.				
<b>C</b>	Remote queue manager name	<b>A</b>	OS2	
<b>D</b>	Remote queue name		OS2.REMOTEQ	
<b>E</b>	Queue name at remote system	<b>B</b>	OS2.LOCALQ	
<b>F</b>	Transmission queue name		OS2	
<b>G</b>	Sender (SNA) channel name		SOLARIS.OS2.SNA	

Table 28. Configuration worksheet for MQSeries for Sun Solaris (continued)

ID	Parameter Name	Reference	Example Used	User Value
<b>H</b>	Sender (TCP/IP) channel name		SOLARIS.OS2.TCP	
<b>I</b>	Receiver (SNA) channel name	<b>G</b>	OS2.SOLARIS.SNA	
<b>J</b>	Receiver (TCP/IP) channel name	<b>H</b>	OS2.SOLARIS.TCP	
<b>Connection to MQSeries for Windows NT</b>				
The values in this section of the table must match those used in Table 17 on page 185, as indicated.				
<b>C</b>	Remote queue manager name	<b>A</b>	WINNT	
<b>D</b>	Remote queue name		WINNT.REMOTEQ	
<b>E</b>	Queue name at remote system	<b>B</b>	WINNT.LOCALQ	
<b>F</b>	Transmission queue name		WINNT	
<b>G</b>	Sender (SNA) channel name		SOLARIS.WINNT.SNA	
<b>H</b>	Sender (TCP/IP) channel name		SOLARIS.WINNT.TCP	
<b>I</b>	Receiver (SNA) channel name	<b>G</b>	WINNT.SOLARIS.SNA	
<b>J</b>	Receiver (TCP) channel name	<b>H</b>	WINNT.SOLARIS.TCP	
<b>Connection to MQSeries for AIX</b>				
The values in this section of the table must match those used in Table 21 on page 211, as indicated.				
<b>C</b>	Remote queue manager name	<b>A</b>	AIX	
<b>D</b>	Remote queue name		AIX.REMOTEQ	
<b>E</b>	Queue name at remote system	<b>B</b>	AIX.LOCALQ	
<b>F</b>	Transmission queue name		AIX	
<b>G</b>	Sender (SNA) channel name		SOLARIS.AIX.SNA	
<b>H</b>	Sender (TCP) channel name		SOLARIS.AIX.TCP	
<b>I</b>	Receiver (SNA) channel name	<b>G</b>	AIX.SOLARIS.SNA	
<b>J</b>	Receiver (TCP) channel name	<b>H</b>	AIX.SOLARIS.TCP	
<b>Connection to MQSeries for DIGITAL UNIX (Compaq Tru64 UNIX)</b>				
The values in this section of the table must match those used in Table 22 on page 216, as indicated.				
<b>C</b>	Remote queue manager name	<b>A</b>	DECUX	
<b>D</b>	Remote queue name		DECUX.REMOTEQ	
<b>E</b>	Queue name at remote system	<b>B</b>	DECUX.LOCALQ	
<b>F</b>	Transmission queue name		DECUX	
<b>H</b>	Sender (TCP) channel name		DECUX.SOLARIS.TCP	
<b>J</b>	Receiver (TCP) channel name	<b>H</b>	SOLARIS.DECUX.TCP	
<b>Connection to MQSeries for HP-UX</b>				
The values in this section of the table must match those used in Table 24 on page 239, as indicated.				
<b>C</b>	Remote queue manager name	<b>A</b>	HPUX	
<b>D</b>	Remote queue name		HPUX.REMOTEQ	
<b>E</b>	Queue name at remote system	<b>B</b>	HPUX.LOCALQ	
<b>F</b>	Transmission queue name		HPUX	
<b>G</b>	Sender (SNA) channel name		SOLARIS.HPUX.SNA	
<b>H</b>	Sender (TCP) channel name		SOLARIS.HPUX.TCP	
<b>I</b>	Receiver (SNA) channel name	<b>G</b>	HPUX.SOLARIS.SNA	
<b>J</b>	Receiver (TCP/IP) channel name	<b>H</b>	HPUX.SOLARIS.TCP	
<b>Connection to MQSeries for AT&amp;T GIS UNIX</b>				
The values in this section of the table must match those used in Table 26 on page 253, as indicated.				

## Sun Solaris configuration

Table 28. Configuration worksheet for MQSeries for Sun Solaris (continued)

ID	Parameter Name	Reference	Example Used	User Value
<b>C</b>	Remote queue manager name	<b>A</b>	GIS	
<b>D</b>	Remote queue name		GIS.REMOTEQ	
<b>E</b>	Queue name at remote system	<b>B</b>	GIS.LOCALQ	
<b>F</b>	Transmission queue name		GIS	
<b>G</b>	Sender (SNA) channel name		SOLARIS.GIS.SNA	
<b>H</b>	Sender (TCP/IP) channel name		SOLARIS.GIS.TCP	
<b>I</b>	Receiver (SNA) channel name	<b>G</b>	GIS.SOLARIS.SNA	
<b>J</b>	Receiver (TCP/IP) channel name	<b>H</b>	GIS.SOLARIS.TCP	
<b>Connection to MQSeries for AS/400</b>				
The values in this section of the table must match those used in Table 43 on page 472, as indicated.				
<b>C</b>	Remote queue manager name		AS400	
<b>D</b>	Remote queue name		AS400.REMOTEQ	
<b>E</b>	Queue name at remote system	<b>B</b>	AS400.LOCALQ	
<b>F</b>	Transmission queue name		AS400	
<b>G</b>	Sender (SNA) channel name		SOLARIS.AS400.SNA	
<b>H</b>	Sender (TCP) channel name		SOLARIS.AS400.TCP	
<b>I</b>	Receiver (SNA) channel name	<b>G</b>	AS400.SOLARIS.SNA	
<b>J</b>	Receiver (TCP) channel name	<b>H</b>	AS400.SOLARIS.TCP	
<b>Connection to MQSeries for OS/390 or MVS/ESA without CICS</b>				
The values in this section of the table must match those used in Table 37 on page 406, as indicated.				
<b>C</b>	Remote queue manager name		MVS	
<b>D</b>	Remote queue name		MVS.REMOTEQ	
<b>E</b>	Queue name at remote system	<b>B</b>	MVS.LOCALQ	
<b>F</b>	Transmission queue name		MVS	
<b>G</b>	Sender (SNA) channel name		SOLARIS.MVS.SNA	
<b>H</b>	Sender (TCP) channel name		SOLARIS.MVS.TCP	
<b>I</b>	Receiver (SNA) channel name	<b>G</b>	MVS.SOLARIS.SNA	
<b>J</b>	Receiver (TCP) channel name	<b>H</b>	MVS.SOLARIS.TCP	
<b>Connection to MQSeries for VSE/ESA</b>				
The values in this section of the table must match those used in Table 45 on page 490, as indicated.				
<b>C</b>	Remote queue manager name		VSE	
<b>D</b>	Remote queue name		VSE.REMOTEQ	
<b>E</b>	Queue name at remote system	<b>B</b>	VSE.LOCALQ	
<b>F</b>	Transmission queue name		VSE	
<b>G</b>	Sender channel name		SOLARIS.VSE.SNA	
<b>I</b>	Receiver channel name	<b>G</b>	VSE.SOLARIS.SNA	



**MQSeries for Sun Solaris sender-channel definitions using SNA**

```
def ql (OS2) +
  usage(xmitq) +
  replace
```

**F**

```
def qr (OS2.REMOTEQ) +
  rname(OS2.LOCALQ) +
  rqmname(OS2) +
  xmitq(OS2) +
  replace
```

**D****E****C****F**

```
def chl (SOLARIS.OS2.SNA) chltype(sdr) +
  trptype(lu62) +
  conname('/home/mqstart/OS2CPIC') +
  xmitq(OS2) +
  replace
```

**G****14****F****MQSeries for Sun Solaris receiver-channel definitions using SNA**

```
def ql (SOLARIS.LOCALQ) replace
```

**B**

```
def chl (OS2.SOLARIS.SNA) chltype(rcvr) +
  trptype(lu62) +
  replace
```

**I****MQSeries for Sun Solaris sender-channel definitions using TCP**

```
def ql (OS2) +
  usage(xmitq) +
  replace
```

**F**

```
def qr (OS2.REMOTEQ) +
  rname(OS2.LOCALQ) +
  rqmname(OS2) +
  xmitq(OS2) +
  replace
```

**D****E****C****F**

```
def chl (SOLARIS.OS2.TCP) chltype(sdr) +
  trptype(tcp) +
  conname(remote_tcpip_hostname) +
  xmitq(OS2) +
  replace
```

**H****F****MQSeries for Sun Solaris receiver-channel definitions using TCP/IP**

```
def ql (SOLARIS.LOCALQ) replace
```

**B**

```
def chl (OS2.SOLARIS.TCP) chltype(rcvr) +
  trptype(tcp) +
  replace
```

**J**

## Sun Solaris configuration

---

## Chapter 19. Setting up communication in Digital OpenVMS systems

Distributed queue management (DQM) is a remote queuing facility for MQSeries. It provides channel control programs for the queue manager that form the interface to communication links, controllable by the system operator. The channel definitions held by distributed-queuing management use these connections.

When a distributed-queuing management channel is started, it tries to use the connection specified in the channel definition. For this to succeed, it is necessary for the connection to be defined and available. This chapter explains how to do this.

For OS/2 and Windows NT, see “Chapter 10. Setting up communication for OS/2 and Windows NT” on page 123. For UNIX systems, see “Chapter 13. Setting up communication in UNIX systems” on page 191. For Tandem NSK, see “Chapter 20. Setting up communication in Tandem NSK” on page 289.

---

### Deciding on a connection

There are four forms of communication for MQSeries on Digital OpenVMS systems:

- TCP
- LU 6.2
- DECnet Phase IV
- DECnet Phase V

Each channel definition must specify one only as the transmission protocol (Transport Type) attribute. One or more protocols may be used by a queue manager.

For MQSeries clients, it may be useful to have alternative channels using different transmission protocols. See the *MQSeries Clients* book.

---

### Defining a TCP connection

The channel definition at the sending end specifies the address of the target. The TCP service is configured for the connection at the receiving end.

#### Sending end

Specify the host name, or the TCP address of the target machine, in the Connection Name field of the channel definition. Port number 1414 is assigned by the Internet Assigned Numbers Authority to MQSeries.

To use a port number other than the default, change the connection name field thus:

```
Connection Name REMHOST(1822)
```

where REMHOST is the hostname of the remote machine and 1822 is the port number required. (This must be the port that the listener at the receiving end is listening on.)

Alternatively you can change the default sending port number by specifying it in the queue manager configuration file (qm.ini):

```
TCP:  
  Port=1822
```

For more information about the values you set using qm.ini, see “Appendix D. Configuration file stanzas for distributed queuing” on page 637.

### Receiving channels using Compaq (DIGITAL) TCP/IP services (UCX) for OpenVMS

To use Compaq (DIGITAL) TCP/IP Services (UCX) for OpenVMS, you must configure a UCX service as follows:

1. Create a file consisting of one line and containing the DCL command to start the TCP/IP receiver program, amqcrsta.exe:

```
$ mcr amqcrsta [-m Queue_Man_Name]
```

Place this file in the SYSS\$MANAGER directory. In this example the name of the file is MQRECV.COM.

#### Notes:

- a. If you have multiple queue managers you must make a new file and UCX service for each queue manager.
  - b. Ensure that the protection on the file and its parent directory allow it to be executable, that is, the protection is /PROT=W:RE.
2. Create a UCX service to start the receiving channel program automatically:

```
$ UCX  
UCX> set service <p1>/port=<p2>/protocol=TCP/user_name=MQM -  
UCX> /process=<p3>/file=<p4>/limit=<p5>
```

where:

- |           |  |
|-----------|--|
| <b>p1</b> | Is the service name, for example MQSERIES01. A unique name is required for each queue manager defined. |
| <b>p2</b> | Is the TCP/IP port number in the range 1 to 65 535. The default value for MQSeries is 1414.            |

- p3** Is the process name. This consists of a string up to 15 characters long.
- p4** Is the name of the startup command file, for example, SYS\$MANAGER:MQRECV.COM.
- p5** Is the process limit. This is the maximum number of connections allowed using the port number. If this limit is reached, subsequent requests are rejected.

**Note:** Each channel represents a single connection to the queue manager.

If a receiving channel does not start when the sending end starts, it is probably due to the permissions on the file being incorrect.

3. To enable the service upon every system IPL (reboot), issue the command

```
$ UCX SET CONFIGURATION ENABLE SERVICE MQSERIES
```

### Using the TCP/IP SO\_KEEPALIVE option

If you want to use the SO\_KEEPALIVE option (as discussed in “Checking that the other end of the channel is still available” on page 66) you must add the following entry to your queue manager configuration file (qm.ini) or the Windows NT registry:

```
TCP:
  KeepAlive=yes
```

## Receiving channels using Cisco MultiNet for OpenVMS

To use Cisco MultiNet for OpenVMS, you must configure a MultiNet service as follows:

1. Create a file consisting of one line and containing the DCL command to start the TCP receiver program, amqcrsta.exe:

```
$ mcr amqcrsta.exe [-m Queue_Man_Name]
```

Place this file in the SYSSMANAGER directory.

#### Notes:

- a. If you have multiple queue managers you must make a new file and MultiNet service for each queue manager.
  - b. Ensure that the protection on the file and its parent directory allow it to be executable, that is, the protection is /PROT=W:RE.
2. Create a MultiNet service to start the receiving channel program automatically:

```
$ multinet configure/server
MultiNet Server Configuration Utility 3.5 (101)
[Reading in configuration from MULTINET:SERVICES.MASTER_SERVER]
SERVER-CONFIG> add MQSeries
[Adding new configuration entry for service "MQSERIES"]
Protocol: [TCP]
TCP Port number: 1414
Program to run: sys$manager:mqrecv.com
[Added service MQSERIES to configuration]
[Selected service is now MQSERIES]
SERVER-CONFIG> set flags UCX_SERVER
MQSERIES flags set to <UCX_SERVER>]
SERVER-CONFIG> set username MQM
[Username for service MQSERIES set to MQM]
SERVER-CONFIG> exit
[Writing configuration to MULTINET_COMMON_ROOT:SERVICES.MASTER_SERVER]
$
```

## Defining a TCP connection

The service is enabled automatically after the next system IPL (reboot). To enable the service immediately, issue the command:

```
'MULTINET  
CONFIGURE /SERVER RESTART'.
```

## Receiving channels using Attachmate PathWay for OpenVMS

To use Attachmate PathWay for OpenVMS to start channels, you *must* configure a PathWay service as follows:

1. Create a file consisting of one line and containing the DCL command to start the TCP/IP receiver program, amqcrsta.exe:

```
$ mcr amqcrsta [-m Queue_Manager_Name]
```

Place this file in the SYSSMANAGER directory. In this example the name mqrecv.com is used.

2. Create an Attachmate service to start the receiving channel program automatically.

You do this by adding the following lines to the file TWG\$COMMON:[NETDIST.ETC]SERVERS.DAT.

```
# MQSeries  
service-name    MQSeries  
program         SYS$MANAGER:MQRECV.COM  
socket-type     SOCK_STREAM  
socket-options  SO_ACCEPTCONN | SO_KEEPA  
socket-address  AF_INET , 1414  
working-set     512  
priority        4  
INIT            TCP_Init  
LISTEN          TCP_Listen  
CONNECTED      TCP_Connected  
SERVICE        Run_Program  
username        MQM  
device-type     UCX
```

## Receiving channels using Process Software Corporation TCPware

To use Process Software Corporation TCPware, you must configure a TCPware service as follows:

1. Create a file consisting of one line and containing the DCL command to start the TCP receiver program amqcrsta.exe:

```
$ mcr amqcrsta (-m Queue_Manager_Name)
```

Place this file in the SYSSMANAGER directory. In this example the name of the file is MQRECV.COM.

### Notes:

- a. If you have multiple queue managers you must make a new file and TCPware service for each queue manager.
  - b. Ensure that the protection on the file and its parent directory allow it to be executable, that is, the protection is /PROT=W:RE.
2. Create a TCPware service to start the receiving channel program automatically:
    - a. Edit the TCPWARE:SERVICES. file and add an entry for the service you want to use:

```
MQSeries 1414/tcp # MQSeries port
```

## Defining a TCP connection

- b. Edit the TCPWARE:SERVERS.COM file and add an entry for the service defined in the previous step:

```
#! SERVERS.COM
#!
$ RUN TCPWARE:NETCU
ADD SERVICE MQSeries BG_TCP -

    /INPUT=SYS$MANAGER:MQRECV.COM -
    /LIMIT=6 -
    /OPTION=KEEPALIVE -
    /USERNAME=MQM

EXIT
```

3. The service is enabled automatically after the next system IPL. To enable the service immediately issue the command:

```
@TCPWARE:SERVERS.COM
```

---

## Defining an LU 6.2 connection

MQSeries for Digital OpenVMS uses the DECnet SNA APPC/LU 6.2 Programming Interface. This interface requires access through DECnet to a suitably configured SNA Gateway, for example, the SNA Gateway-ST, or SNA Gateway-CT.

### SNA configuration

To enable MQSeries to work with DECnet APPC/LU 6.2 you **must** complete your Gateway SNA configuration first. The Digital SNA configuration **must** be in agreement with the Host SNA configuration.

#### Notes:

1. When configuring your host system, be aware that the DECnet SNA Gateway supports PU 2.0 and **not** node type 2.1. This means that the LUs on the Digital SNA node must be dependent LUs. They reside on the Digital SNA node and so must be defined and configured there. However, because they are dependent LUs, they have to be activated by VTAM, by means of an ACTLU command, and so they also need to be defined to VTAM as dependent LUs.
2. Ensure that the SNA libraries are installed as shared images upon each system IPL by running the command @SYS\$STARTUP:SNALU62\$STARTUP.COM in the system startup procedure.

To configure your SNA Gateway, set up the SNAGATEWAY\_<node>\_SNA.COM file,

where <node> is replaced with the node name of your DECnet SNA gateway.

Do this by responding to the configuration prompts in the Gateway installation procedure, or by directly editing the file.

The SNA Gateway installation procedure creates the file in the directory SYSSCOMMON:[SNA\$CSV].

The configuration information in this file is downloaded to the Gateway when you run the NCP LOAD NODE command.

#### Notes:

1. Online changes to the current Gateway configuration can be made using the utility SNANCP.
2. SNA resources can be monitored using the SNAP utility.

## Defining an LU 6.2 connection

A sample SNA Gateway Configuration file follows:

```
#!+--+--+--+--+--+--+--+--+--+--+--+--+--+--+--+--+--+--+--+--+--+--+--+--+--+--+--+--+--+
$! Start of file: SYS$COMMON:[SNA$CSV]SNAGATEWAY_SNAGWY_SNA.COM
$! DECnet SNA Gateway-ST SNA configuration file
$! Created: 23-FEB-1996 19:10:43.68 by SNACST$CONFIGURE V1.2
$! Host node: CREAMP User$ CHO
#!+--+--+--+--+--+--+--+--+--+--+--+--+--+--+--+--+--+--+--+--+--+--+--+--+--+--+--+--+
$ v = f$verify(1)
$ RUN SYS$SYSTEM:SNANCP
SET LINE SYN-0 - // Line definition
  DUPLEX FULL -
  PROTOCOL SDLC POINT -
  SIGNALLING NORMAL -
  CLOCK EXTERNAL -
  MODEM TYPE NORMAL -
  RECEIVE BUFFERS 34 -
  LOGGING INFORMATIONAL -
  BUFFER SIZE 265
SET CIRCUIT SDLC-0 - // Circuit definition
  LINE SYN-0 -
  DUPLEX FULL -
  RESPONSE MODE NORMAL -
  STATION ADDRESS C1 -
  LOGGING INFORMATIONAL -
  STATION ID 0714002A // XID
SET PU SNA-0 CIRCUIT SDLC-0 -
  LU LIST 1-32 -
  SEGMENT SIZE 265 - // must equal MAXDATA on Host PU definition
  LOGGING WARNING
SET CIRCUIT SDLC-0 STATE ON
SET LINE SYN-0 STATE ON
SET SERVER SNA-ACCESS -
  LOGGING WARNING -
  NOTE "Gateway Access Server" -
  STATE ON
SET ACCESS NAME VTAMSDR PU SNA-0 LU 2 APPL MVSLU LOGON LU62SS
SET ACCESS NAME VTAMRCVR PU SNA-0 LU 3 APPL MVSLU LOGON LU62SS
$ EXIT $STATUS + (0 * 'f$verify(v)')
#!+--+--+--+--+--+--+--+--+--+--+--+--+--+--+--+--+--+--+--+--+--+--+--+--+--+--+--+--+
$! End of file: SYS$COMMON:[SNA$CSV]SNAGATEWAY_SNAGWY_SNA.COM
#!+--+--+--+--+--+--+--+--+--+--+--+--+--+--+--+--+--+--+--+--+--+--+--+--+--+--+--+--+
```

### Defining access names

You should set up a separate Access name for each MQSeries channel. This ensures that the VMS system and the remote system agree on the LU used for the channel.

**Note:** If you use a single access name, with a range of LUs specified, the Gateway selects the LUs in a circular order. Therefore the LU selected by the Gateway may not correspond with the LU used by the Host channel, because the Host associates a specific LU with a channel.

The access name is used only to communicate between the DECnet SNA APPC program and the Gateway. It has no network meaning.

#### Notes:

1. The LUs are single session. You **must** define a separate LU for each channel if they are to run simultaneously.
2. You are advised to use names that associate the access name to the corresponding channel, but you can choose any name.
3. The APPL in the ACCESS name definition must match the remote (in this case MVSLU) APPL in VTAM.
4. The LU number must correspond to the LOCADDR in the LU definition statement in VTAM. Here is an example VTAM line and LU definitions:

```
IYA8L007 LINE ADDRESS=(007,FULL),
           ISTATUS=ACTIVE
IYA8P307 PU ADDR=C2,
           ISTATUS=ACTIVE,
           IRETRY=NO,
```



```

MAXDATA=521,
MAXOUT=7,
PASSLIM=7,
PUTYPE=2
IYA83071 LU LOCADDR=2,PACING=1,DLOGMOD=LU62CP1
IYA83072 LU LOCADDR=3

```

- The LOGON must specify the logmode entry on the VTAM host that specifies parameters acceptable to the SNA Gateway. Here is an example of a single session logmode entry:

```

LU62SS  MODEENT LOGMODE=LU62SS,
        TYPE=0,                ONLY TYPE RECOGNIZED
        FMPROF=X'13',          SNA
        TSPROF=X'07',          SNA
        PRIPROT=X'B0',          PRIMARY PROTOCOL
        SECPROT=X'B0',          SECONDARY PROTOCOL
        COMPROT=X'50B1',        COMMON PROTOCOL
        SSNDPAC=X'00',
        SRCVPAC=X'00',
        RUSIZES=X'8989',        RUSIZES  IN-4096 OUT-4096
        PSNDPAC=X'00',
        PSERVIC=X'0602000000000000000002C00',

```

The *DECnet SNA Gateway Guide to IBM Parameters* details the parameters expected by the Gateway.

## Specifying SNA configuration parameters to MQSeries

MQSeries obtains knowledge of the SNA resources by passing the Gateway Node name and the Access name to the channel program.

### Passing parameters to sender and requester channel pairs

For sender and requester channel pairs specify the Gateway Node and Access Name in the CONNAME string in the channel definition.

The CONNAME also includes the TPNAME that is used by the SNA Allocate verb to invoke the remote program.

The format of the CONNAME is: CONNAME(*GatewayNode.AccessName(TpName)*).

For example: CONNAME('SNAGWY.VTAMSDR(MQSERIES) '), where SNAGWY is the Gateway node, VTAMSDR is the access name, and MQSeries is the TPNAME.

**Note:** Do not use the TPNAME field in the channel definition.

### Running senders and requesters

Senders, requesters, and fully qualified servers can be explicitly run by performing a START CHANNEL command in runmqsc.

Senders and requesters on Digital OpenVMS initiate a session by issuing an INIT-SELF to request a BIND from the host. In issuing the Allocate verb, the MQSeries channel program takes the LU name and the Mode Name from the Access Name.

MQSeries then allocates a conversation using the specified TPNAME.

### Passing parameters to servers and receivers

For servers and receivers, specify the Gateway Node, Access Name, and TPNAME as command line parameters to the **runmqslsr** command.

## Defining an LU 6.2 connection

### Running servers and receivers

Servers and receivers are started by running the runmqslsr command.

```
$ RUNMQLSR -m QMname -n TPname -g GatewayNode (AccessName)
```

**Note:** Each server and receiver channel requires its own listener process.

You can include these commands in the MQSeries startup file, SYSSSTARTUP:MQS\_STARTUP.

Receivers and servers issue the ACTIVATE\_SESSION request to the Gateway in passive mode. In passive mode the channel program waits for a BIND from the remote system, which puts the LU into the active-listening state, waiting for a bind from the host.

You can check the LU status using SNANCP to make sure that you are in active-listening state on the correct LU. If a BIND from the host arrives specifying the LU that is in active-listening state, the session will be established. After establishing the session, the host attempts to allocate a conversation.

The TPNAME used by the host sender/requester channel **must** be the same name as that specified on the command line in order to establish the conversation.

**Note:** RUNMQLSR recycles when a remote channel disconnects. There is a finite period of time before the listener is ready to accept further binds from the host.

### Ending the SNA Listener process

To find the batch job number for the SNA listener process, type:

```
$ show queue / all
```

To end the SNA Listener process type:

```
$ delete /entry=<jobnumber>
```

where <jobnumber> is the job number of the listener batch job.

## Sample MQSeries configuration

```
*
*      channel configuration for saturn.queue.manager for LU6.2
*
def ql('HOST_SENDER_TQ') usage(xmitq)

def chl('HOST.TO.VMS') chltype(rcvr) trptype(lu62) +
  seqwrap(999999999)

def chl('VMS.TO.HOST') chltype(sdr) trptype(lu62) +
  conname('SNAGWY.VTAMSDR(MQSERIES)') +
  xmitq('HOST_SENDER_TQ') seqwrap(999999999)
```

In this example two channels, a sender and a receiver, have been set up.

On the remote system you need to configure the corresponding channels. Channels that talk to each other must have the same name.

- The OpenVMS sender, VMS.TO.HOST, talks to a receiver called VMS.TO.HOST on the host system.
- The OpenVMS receiver, HOST.TO.VMS talks to a sender HOST.TO.VMS on the host system.

The commands to start each channel are:

```
// Start sender channel to host system
$ runmqchl -m "saturn.queue.manager" -c "VMS.TO.HOST"
// Set up listener to listen for incoming SNA requests.
$ runmqlsr -m "saturn.queue.manager" -n "TPNAME" -g SNAGWY(VTAMRCVR)
```

**Note:** The TPNAME must match the outbound TPNAME on the MVS sender channel side. This is specified in the MVS side information, for example:

```
SIDELETE
  DESTNAME(ID1)
SIADD
  DESTNAME(ID1)
  MODENAME(LU62SS)
  TPNAME(MQSERIES)
  PARTNER_LU(IYA83072)
```

## Problem solving

### Error PUNOTAVA - PU has not been activated

This error indicates a lack of connectivity between the two machines. Make sure your line and circuit are set to state ON. Use SNATRACE at the circuit level to verify that the Digital OpenVMS machine is polling. If no response is received for the poll, check that the PU on the host is enabled. If the line will not go to the ON STATE check your physical line. If the trace shows the host responding to the poll, but the PU still does not become active, check your setting of the STATION ID.

### Failure to allocate conversation

This error is returned by a sender or requester to indicate that allocate failed. Run trace to verify that the session can be established. Verify that the Digital OpenVMS machine sends the INIT-SELF (010681). If there is no response to the INIT-SELF make sure that the host MQSeries channel is started. If the BIND from the host is rejected by the Digital OpenVMS machine analyze the Digital bind response. Use the *DECnet SNA Gateway Guide to IBM Parameters* to see what is set incorrectly in the mode. If a session is established and the conversation allocate request is rejected verify that the TPNAMES are configured the same on both systems.

For receivers and servers verify that a BIND is sent by the host. If not, enable the Host MQSeries channel. If the BIND is rejected check the reason for rejection. Make sure that the Digital OpenVMS listener LU is the LU with which the host is trying to establish a session.

### MQSeries connection failure

After establishing a conversation the two MQSeries channels engage in a protocol to establish an MQSeries channel connection. If this fails, the reason for failure should be indicated in the error logs on the two systems. Check both logs and correct the indicated problem. For example the connection fails if one system has a SEQWRAP value of 999999999 and the other 999999. In the SNATRACE you will see that the allocate succeeded and that MQ™ is trying to establish a channel connection. At this point the MQSeries logs are the best aid in resolving problems.

---

## Defining a DECnet Phase IV connection

The channel definition at the sending end specifies the address of the target. The DECnet network object is configured for the connection at the receiving end.

## DECnet Phase IV connections

### Sending end

Specify the DECnet node name and the DECNET object name in the Connection Name field of the channel definition. You need a different DECnet object for each separate queue manager that is defined. For example, to specify DECnet object MQSERIES on node FOONT enter the following when defining the channel:

```
CONNAME('FOONT(MQSERIES)')
```

### Receiving on DECnet Phase IV

To use DECnet Phase IV to start channels, you must configure a DECnet object as follows:

1. Create a file consisting of one line and containing the DCL command to start the DECnet receiver program, amqcrsta.exe:

```
$ mcr amqcrsta [-m Queue_Man_Name] -t DECnet
```

Place this file in the SYS\$MANAGER directory. In this example the file is named MQRECVDECNET.COM.

#### Notes:

- a. If you have multiple queue managers you **must** make a new file and DECnet object for each queue manager.
  - b. If a receiving channel does not start when the sending end starts, it is probably due to the permissions on this file being incorrect.
2. Create a DECnet object to start the receiving channel program automatically. You must supply the correct password for MQSeries.

```
$ MCR NCP
NCP> define object MQSERIES
Object number      (0-255): 0
File name          (filename):sys$manager:mqrecvdecnet.com
Privileges (List of VMS privileges):
Outgoing connect privileges (List of VMS privileges):
User ID            (1-39 characters): mqm
Password           (1-39 characters): mqseries
Account            (1-39 characters):
Proxy access (INCOMING, OUTGOING, BOTH, NONE, REQUIRED):
NCP> set known objects all
NCP> exit
```

**Note:** You could use proxy user identifiers rather than actual user identifiers. This will prevent any unauthorized access to the database. Information on how to set up proxy identifiers is given in the *Digital DECnet for OpenVMS Networking Manual*.

3. Ensure that all known objects are set when DECnet is started.

---

## Defining a DECnet Phase V connection

Set up the MQSeries configuration for channel objects:

1. Start the NCL configuration interface by issuing the following command:

```
$ MC NCL
NCL>
```

2. Create a session control application entity by issuing the following commands:

```
NCL> create session control application MQSERIES
NCL> set sess con app MQSERIES address {name=MQSERIES}
NCL> set sess con app MQSERIES image name -
_ SYS$MANAGER:MQRECVDECNET.COM
NCL> set sess con app MQSERIES user name "MQM"
NCL> set sess con app MQSERIES node synonym true
NCL> show sess con app MQSERIES all [characteristics]
```

## DECnet Phase V connections

**Note:** User-defined values are in **uppercase**.

3. Create the command file as for DECnet PhaseIV.
4. The log file for the object is net\$server.log in the sys\$login directory for the application-specified user name.
5. To enable the session control application upon every system IPL (reboot), add the preceding NCL commands to the file  
SYS\$MANAGER:NET\$APPLICATION\_LOCAL.NCL.

## DECnet Phase V connections

---

## Chapter 20. Setting up communication in Tandem NSK

Distributed queue management (DQM) is a remote queuing facility for MQSeries. It provides channel control programs for the queue manager that form the interface to communication links, controllable by the system operator. The channel definitions held by distributed-queuing management use these connections.

When a distributed-queuing management channel is started, it tries to use the connection specified in the channel definition. For this to succeed, it is necessary for the connection to be defined and available. This chapter explains how to do this.

For OS/2 and Windows NT, see “Chapter 10. Setting up communication for OS/2 and Windows NT” on page 123. For UNIX systems, see “Chapter 13. Setting up communication in UNIX systems” on page 191. For Digital OpenVMS, see “Chapter 19. Setting up communication in Digital OpenVMS systems” on page 277.

---

### Deciding on a connection

There are two forms of communication for MQSeries for Tandem NonStop Kernel:

- TCP
- LU 6.2

Each channel definition must specify one only as the transmission protocol (Transport Type) attribute. One or more protocols may be used by a queue manager.

When connecting to MQSeries clients, it may be useful to have alternative channels using different transmission protocols. See the *MQSeries Clients* book for more information. (There is no MQSeries for Tandem NonStop Kernel client.)

---

### SNA channels

The following channel attributes are necessary for SNA channels in MQSeries for Tandem NonStop Kernel:

#### CONNNAME

The value of CONNNAME depends on whether SNAX or ICE is used as the communications protocol:

*If SNAX is used:*

**CONNNAME('SPPPP.LOCALLU.REMOTELU')**

Applies to sender, requester, and fully-qualified server channels, where:

**SPPPP** Is the process name of the SNAX/APC process.

**LOCALLU**

Is the name of the Local LU.

**REMOTELU**

Is the name of the partner LU on the remote machine.

For example:

`CONNNAME(' $BP01.IYAHT080.IYCNVM03')`

## SNA channels

### CONNNAME('SPPPP.LOCALLU')

Applies to receiver and non fully-qualified server channels, where:  
**SPPPP** Is the process name of the SNAX/APC process.

#### LOCALLU

Is the name of the Local LU. This value can be an asterisk (\*), indicating any name.

For example:

```
CONNNAME('$BP01.IYAHT080')
```

*If ICE is used:*

### CONNNAME('SPPPP.#OPEN.LOCALLU.REMOTELU')

Applies to sender, requester, and fully-qualified server channels, where:

**SPPPP** Is the process name of the ICE process.

#### #OPEN

Is the ICE open name.

#### LOCALLU

Is the name of the Local LU.

#### REMOTELU

Is the name of the partner LU on the remote machine.

For example:

```
CONNNAME('$ICE.#IYAHT0C.IYAHT0C0.IYCNVM03')
```

### CONNNAME('SPPPP.#OPEN.LOCALLU')

Applies to receiver and non fully-qualified server channels, where:  
**SPPPP** Is the process name of the SNAX/APC process.

#### #OPEN

Is the ICE open name.

#### LOCALLU

Is the name of the Local LU. This value can be an asterisk (\*), indicating any name.

For example:

```
CONNNAME('$ICE.#IYAHT0C.IYAHT0C0')
```

### MODENAME

Is the SNA mode name. For example, MODENAME(LU62PS).

### TPNAME('LOCALTP[.REMOTETP]')

Is the Transaction Process (TP) name.

#### LOCALTP

Is the local name of the TP.

#### REMOTETP

Is the name of the TP on the remote machine. This value is optional. If it is not specified, and the channel is one that initiates a conversation (that is, a sender, requester, or fully-qualified server channel) the LOCALTP name is used.

Both the LOCALTP and REMOTETP values can be up to 16 characters in length.

#### Notes:

1. If SNAX is being used to facilitate SNA communications, the values in the LOCALTP field in the TPNAME must match TPs defined to SNAX. You are recommended to use uppercase when defining an LU name.



2. If ICE is being used, TPNAMES do not need to be defined to ICE; they need only be present in the MQSeries channel definitions.

## LU 6.2 responder processes

There is no SNA listener process in MQSeries for Tandem NonStop Kernel. Each channel initiated from a remote system (receiver, server, or requester that has a fully-qualified server on the remote system or a requester that has a sender on the remote system) must have its own, unique TP name on which it can listen. This TP name is specified as the LOCALTP value.

Such channels must be defined to MQSC with the attribute AUTOSTART(ENABLED) to ensure that there is an LU 6.2 responder process listening on this TP name whenever the queue manager is started. This LU 6.2 responder process (MQLU6RES) services incoming SNA requests for its particular TP. If the channel is newly defined, or has been recently altered, an LU 6.2 responder process can be started for that channel by issuing either the MQSC command START CHANNEL (using **runmqsc**) or the **runmqchl** control command from the TACL prompt.

SNA channels defined AUTOSTART(DISABLED) do not listen for incoming SNA requests. LU 6.2 responder processes are not started for such channels. A message is logged to MQERRLG1 whenever an LU 6.2 responder process is started.

---

## TCP channels

For information about using a nondefault TCP process for communications via TCP, and information about the TCP ports a queue manager listens on, see the *MQSeries for Tandem NonStop Kernel System Management Guide*.

### Communications examples

This section provides communications setup examples for SNA (SNAX and ICE) and TCP.

#### SNAX communications example

This section provides:

- An example SCF configuration file for the SNA line
- Some example SYSGEN parameters to support the line
- An example SCF configuration file for the SNA process definition
- Some example MQSC channel definitions

#### SCF SNA line configuration file

Here is an example SCF configuration file:

```
==  
== SCF configuration file for defining SNA LINE, PUs, and LUs to VTAM  
== Line is called $SNA02 and SYSGEN'd into the Tandem system  
==
```

```
ALLOW ALL  
ASSUME LINE $SNA02
```

```
ABORT, SUB LU  
ABORT, SUB PU  
ABORT
```

```
DELETE, SUB LU  
DELETE, SUB PU  
DELETE
```

## Communications examples

```
==
== ADD $SNA02 LINE DEFINITION
==

ADD LINE $SNA02, STATION SECONDARY, MAXPUS 5, MAXLUS 1024, RECSIZE 2048, &
      CHARACTERSET ASCII, MAXLOCALLUS 256, &
      PUIDBLK %H05D, PUIDNUM %H312FB

==
== ADD REMOTE PU OBJECT, LOCAL IS IMPLICITLY DEFINED AS #ZNT21
==

ADD PU #PU2, ADDRESS 1, MAXLUS 16, RECSIZE 2046, TYPE (13,21), &
      TRRMTADDR 04400045121088, DYNAMIC ON, &
      ASSOCIATESUBDEV $CHAMB.#p2, &
      TRSSAP %H04, &
      CPNAME IYAQCDRM, SNANETID GBIBMIYA

==
== ADD LOCAL LU OBJECT
==

ADD LU #ZNTLU1, TYPE (14,21), RECSIZE 1024, &
      CHARACTERSET ASCII, PUNAME #ZNT21, SNANAME IYAHT080

==
== ADD PARTNER LU OBJECTS
==

== spinach (HP)
ADD LU #PU2LU1, TYPE(14,21), PUNAME #PU2, SNANAME IYABT0F0

== stingray (AIX)
ADD LU #PU2LU2, TYPE(14,21), PUNAME #PU2, SNANAME IYA3T995

== coop007 (OS/2)
ADD LU #PU2LU3, TYPE(14,21), PUNAME #PU2, SNANAME IYAFT170

== MVS CICS
ADD LU #PU2LU4, TYPE(14,21), PUNAME #PU2, SNANAME IYCMVM03

== MVS Non-CICS
ADD LU #PU2LU5, TYPE(14,21), PUNAME #PU2, SNANAME IYCNVM03

== finnr100 (NT)
ADD LU #PU2LU6, TYPE(14,21), PUNAME #PU2, SNANAME IYAFT080

== winas18 (AS400)
```

## Communications examples

```
ADD LU #PU2LU7, TYPE(14,21), PUNAME #PU2, SNANAME IYAFT110
== MQ-Portuguese (0S/2)
ADD LU #PU2LU8, TYPE(14,21), PUNAME #PU2, SNANAME IYAHT090
== VSE
ADD LU #PU2LU10, TYPE(14,21), PUNAME #PU2, SNANAME IYZMZSI2

== START UP TOKEN RING ASSOCIATE SUB DEVICE $CHAMB.#P2
== then start the line, pu's, and lu's

START LINE $CHAMB, SUB ALL

START
START, SUB PU

STATUS
STATUS, SUB PU
STATUS, SUB LU
```

## SYSGEN parameters

The following are CONFTEXT file entries for a SYSGEN to support the SNA and token ring lines:

```
!*****
!                               LAN MACRO
!*****
! This macro is used for all 361x LAN controllers
! REQUIRES T9375 SOFTWARE PACKAGE

C3613^MLAM          = MLAM
                    TYPE 56,          SUBTYPE 0,
                    PROGRAM            C9376P00,
                    INTERRUPT          IOP^INTERRUPT^HANDLER,
                    MAXREQUESTSIZE    32000,
                    RSIZE              32000,
                    BURSTSIZE         16,
                    LINEBUFFERSIZE    32,
                    STARTDOWN #;

!*****
!                               SNAX macro for Token ring lines
!*****
TOKEN^RING^SNAX^MACRO = SNATS
                    TYPE 58,
                    SUBTYPE 4,
                    RSIZE 1024,
                    SUBTYPE 4,
                    FRAMESIZE 1036 # ;
```

## Communications examples

```
!*****
!                               SNAX MANAGER
!*****
SSCP^MACRO          = SNASVM
                    TYPE 13,          SUBTYPE 5,
                    RSIZE              256 #;

!*****
!                               LAN CONTROLLER
!*****
LAN1      3616    0,1    %130    ;

!*****      Service manager
SNAX      6999    0,1    %370    ;

!*****      SNAX/Token Ring Pseudocontroller
RING      6997    0,1    %360    ;

!*****      Token Ring Line
$CHAMB    LAN1.0, LAN1.1          C3613^MLAM, NAME #LAN1;

!*****      Configure the SSCP
$SSCP     SNAX.0, SNAX.1 SSCP^MACRO;

!*****      Sna lines for Dummy Controller over Token Ring
$SNA01    RING.0, RING.1 TOKEN^RING^SNAX^MACRO;
$SNA02    RING.2, RING.3 TOKEN^RING^SNAX^MACRO;
```

### SNAX/APC process configuration

The following definitions configure the example APC process (process name \$BP01) via SCF for the SNA line.

**Note:** The pathway process \$BP01 is created using the Tandem utility APCRUN.

```
==
== SCF Configuration file for SNAX/APC Lus
==

ALLOW ERRORS

ASSUME PROCESS $BP01

ABORT SESSION *
ABORT TPN *
ABORT PTNR-MODE *
ABORT PTNR-LU *
ABORT LU *

DELETE TPN *
DELETE PTNR-MODE *
DELETE PTNR-LU *
DELETE LU *

==
== ADD LOCAL LU
==
ADD LU IYAHT080, SNAME GBIBMIYA.IYAHT080, SNAXFILENAME $SNA02.#ZNTLU1, &
MAXSESSION 256, AUTOSTART YES
```

## Communications examples

== TPnames for MQSeries

```
ADD TPN IYAHT080.INTCRS6A
ADD TPN IYAHT080.DUMMY, GENERALTPREADY yes, SESSIONCONTROL yes, &
    REMOTEATTACHTIMER -1, REMOTEATTACH queue
```

=== Spinach (HP) Partner LU

```
ADD PTNR-LU IYAHT080.IYABT0F0, SNANAME GBIBMIYA.IYABT0F0, &
    PERIPHERAL-NODE NO, PARALLEL-SESSION-LU YES

ADD PTNR-MODE IYAHT080.IYABT0F0.LU62PS, MODENAME LU62PS, &
    DEFAULTMAXSESSION 8, DEFAULTMINCONWINNER 4, &
    DEFAULTMINCONLOSER 3, MAXAUTOACT 1, RCVWINDOW 4, &
    DEFAULTMAXINRUSIZE 1024, DEFAULTMAXOUTRUSIZE 1024, &
    SENDWINDOW 4

ADD TPN IYAHT080.MH01SDRCSDR
ADD TPN IYAHT080.MH01RQSDSDR
ADD TPN IYAHT080.MH01RQSVSVR
ADD TPN IYAHT080.MH01SDRRCRCVR
ADD TPN IYAHT080.MH01RQSVRQSTR
ADD TPN IYAHT080.MH01RQSDRQSTR
```

==

== Winas18 (AS400) Partner LU

==

```
ADD PTNR-LU IYAHT080.IYAFT110, SNANAME GBIBMIYA.IYAFT110, &
    PERIPHERAL-NODE NO, PARALLEL-SESSION-LU YES

ADD PTNR-MODE IYAHT080.IYAFT110.LU62PS, MODENAME LU62PS, &
    DEFAULTMAXSESSION 8, DEFAULTMINCONWINNER 4, &
    DEFAULTMINCONLOSER 3, MAXAUTOACT 1, RCVWINDOW 4, &
    DEFAULTMAXINRUSIZE 1024, DEFAULTMAXOUTRUSIZE 1024, &
    SENDWINDOW 4

ADD TPN IYAHT080.M401SDRCSDR
ADD TPN IYAHT080.M401RQSDSDR
ADD TPN IYAHT080.M401RQSVSVR
ADD TPN IYAHT080.M401SDRRCRCVR
ADD TPN IYAHT080.M401RQSVRQSTR
ADD TPN IYAHT080.M401RQSDRQSTR
```

==  
 ==  
 ==

== Stingray (AIX) Partner LU

```
ADD PTNR-LU   IYAHT080.IYA3T995, SNANAME GBIBMIYA.IYA3T995, &
              PERIPHERAL-NODE NO, PARALLEL-SESSION-LU YES

ADD PTNR-MODE IYAHT080.IYA3T995.LU62PS, MODENAME LU62PS, &
              DEFAULTMAXSESSION 8, DEFAULTMINCONWINNER 4, &
              DEFAULTMINCONLOSER 3, MAXAUTOACT 1, RCVWINDOW 4, &
              DEFAULTMAXINRUSIZE 1024, DEFAULTMAXOUTRUSIZE 1024, &
              SENDWINDOW 4

ADD TPN       IYAHT080.MA02SDRCSDR
ADD TPN       IYAHT080.MA02RQSDSDR
ADD TPN       IYAHT080.MA02RQSVSVR
ADD TPN       IYAHT080.MA02SDRCRCVR
ADD TPN       IYAHT080.MA02RQSVRQSTR
ADD TPN       IYAHT080.MA02RQSDRQSTR
```

==  
 ==  
 ==

== coop007 (OS/2) Partner LU

```
ADD PTNR-LU   IYAHT080.IYAFT170, SNANAME GBIBMIYA.IYAFT170, &
              PERIPHERAL-NODE NO, PARALLEL-SESSION-LU YES

ADD PTNR-MODE IYAHT080.IYAFT170.LU62PS, MODENAME LU62PS, &
              DEFAULTMAXSESSION 8, DEFAULTMINCONWINNER 4, &
              DEFAULTMINCONLOSER 3, MAXAUTOACT 1, RCVWINDOW 4, &
              DEFAULTMAXINRUSIZE 1024, DEFAULTMAXOUTRUSIZE 1024, &
              SENDWINDOW 4

ADD TPN       IYAHT080.M002SDRCSDR
ADD TPN       IYAHT080.M002RQSDSDR
ADD TPN       IYAHT080.M002RQSVSVR
ADD TPN       IYAHT080.M002SDRCRCVR
ADD TPN       IYAHT080.M002RQSVRQSTR
ADD TPN       IYAHT080.M002RQSDRQSTR
```

==  
 ==  
 ==

== MQ-Portuguese (OS/2) Partner LU

```
ADD PTNR-LU   IYAHT080.IYAHT090, SNANAME GBIBMIYA.IYAHT090, &
              PERIPHERAL-NODE NO, PARALLEL-SESSION-LU YES

ADD PTNR-MODE IYAHT080.IYAHT090.LU62PS, MODENAME LU62PS, &
              DEFAULTMAXSESSION 8, DEFAULTMINCONWINNER 4, &
              DEFAULTMINCONLOSER 3, MAXAUTOACT 1, RCVWINDOW 4, &
              DEFAULTMAXINRUSIZE 1024, DEFAULTMAXOUTRUSIZE 1024, &
              SENDWINDOW 4
```

## Communications examples

==

== finnr100 (NT) Partner LU

==

ADD PTNR-LU IYAHT080.IYAFT080, SNANAME GBIBMIYA.IYAFT080, &  
PERIPHERAL-NODE NO, PARALLEL-SESSION-LU YES

ADD PTNR-MODE IYAHT080.IYAFT080.LU62PS, MODENAME LU62PS, &  
DEFAULTMAXSESSION 8, DEFAULTMINCONWINNER 4, &  
DEFAULTMINCONLOSER 3, MAXAUTOACT 1, RCVWINDOW 4, &  
DEFAULTMAXINRUSIZE 1024, DEFAULTMAXOUTRUSIZE 1024, &  
SENDWINDOW 4

ADD TPN IYAHT080.MW01SDRCSDR  
ADD TPN IYAHT080.MW01RQSDSDR  
ADD TPN IYAHT080.MW01RQSVSVR  
ADD TPN IYAHT080.MW01SDRCRCVR  
ADD TPN IYAHT080.MW01RQSVRQSTR  
ADD TPN IYAHT080.MW01RQSDRQSTR

==

== MVS CICS Partner LU

==

ADD PTNR-LU IYAHT080.IYCMVM03, SNANAME GBIBMIYA.IYCMVM03, &  
PERIPHERAL-NODE NO, PARALLEL-SESSION-LU YES

ADD PTNR-MODE IYAHT080.IYCMVM03.LU62PS, MODENAME LU62PS, &  
DEFAULTMAXSESSION 8, DEFAULTMINCONWINNER 4, &  
DEFAULTMINCONLOSER 3, MAXAUTOACT 1, RCVWINDOW 4, &  
DEFAULTMAXINRUSIZE 1024, DEFAULTMAXOUTRUSIZE 1024, &  
SENDWINDOW 4

ADD TPN IYAHT080.VM03SDRCSDR  
ADD TPN IYAHT080.VM03RQSDSDR  
ADD TPN IYAHT080.VM03RQSVSVR  
ADD TPN IYAHT080.VM03SDRCRCVR  
ADD TPN IYAHT080.VM03RQSVRQSTR  
ADD TPN IYAHT080.VM03RQSDRQSTR

==

== MVS Non CICS Partner LU

==

ADD PTNR-LU IYAHT080.IYCNVM03, SNANAME GBIBMIYA.IYCNVM03, &  
PERIPHERAL-NODE NO, PARALLEL-SESSION-LU YES

ADD PTNR-MODE IYAHT080.IYCNVM03.LU62PS, MODENAME LU62PS, &  
DEFAULTMAXSESSION 8, DEFAULTMINCONWINNER 4, &  
DEFAULTMINCONLOSER 3, MAXAUTOACT 1, RCVWINDOW 4, &  
DEFAULTMAXINRUSIZE 1024, DEFAULTMAXOUTRUSIZE 1024, &  
SENDWINDOW 4

ADD TPN IYAHT080.VM03NCMSDRCSDR  
ADD TPN IYAHT080.VM03NCMRQSDSDR  
ADD TPN IYAHT080.VM03NCMRQSVSVR  
ADD TPN IYAHT080.VM03NCMSDRRCVR  
ADD TPN IYAHT080.VM03NCMRQSVRQSTR  
ADD TPN IYAHT080.VM03NCMRQSDRQSTR



```

==
== VSE Partner LU
==

ADD PTNR-LU IYAHT080.IYZMZSI2, SNANAME GBIBMIYA.IYZMZSI2, &
PERIPHERAL-NODE NO, PARALLEL-SESSION-LU YES

ADD PTNR-MODE IYAHT080.IYZMZSI2.LU62PS, MODENAME LU62PS, &
DEFAULTMAXSESSION 8, DEFAULTMINCONWINNER 4, &
DEFAULTMINCONLOSER 3, MAXAUTOACT 1, RCVWINDOW 4, &
DEFAULTMAXINRUSIZE 1024, DEFAULTMAXOUTRUSIZE 1024, &
SENDWINDOW 4

==
== Start the LUs
==

START LU IYAHT080, SUB ALL
START TPN *
```

### Channel definitions

Here are some example MQSeries channel definitions that support the SNAX configuration:

- A sender channel to MQSeries on OS/390 (not using CICS):

```

DEFINE CHANNEL(MT01.VM03.SDRC.0002) CHLTYPE(SDR) +
TRPTYPE(LU62) +
SEQWRAP(9999999) MAXMSGL(2048) +
XMITQ('VM03NCM.TQ.SDRC.0001') +
CONNAME('$BP01.IYAHT080.IYCNVM03') +
MODENAME('LU62PS') TPNAME(DUMMY)
```
- A receiver channel from MQSeries on OS/390:

```

DEFINE CHANNEL(VM03.MT01.SDRC.0002) CHLTYPE(RCVR) +
TRPTYPE(LU62) REPLACE DESCR('Receiver channel from VM03NCM') +
SEQWRAP(9999999) +
MAXMSGL(2048) AUTOSTART(ENABLED) +
CONNAME('$BP01.IYAHT080') TPNAME(VM03NCMSDRRCVR)
```
- A server channel to MQSeries on OS/390 which is capable of initiating a conversation, or being initiated by a remote requester channel:

```

DEFINE CHANNEL(MT01.VM03.RQSV.0002) CHLTYPE(SVR) +
TRPTYPE(LU62) +
SEQWRAP(9999999) MAXMSGL(2048) +
XMITQ('VM03NCM.TQ.RQSV.0001') +
CONNAME('$BP01.IYAHT080.IYCNVM03') +
MODENAME('LU62PS') TPNAME(VM03NCMRQSVSVR.DUMMY) +
AUTOSTART(ENABLED)
```

where DUMMY is the TPNAME the MVS queue manager is listening on.

### ICE communications example

There are two stages in configuring ICE for MQSeries:

1. The ICE process itself must be configured.
2. Line (\$ICE01, in the following example) and SNA information must be input to the ICE process.

#### Configuring the ICE process

Here is an example ICE process configuration. This configuration is located by default in a file called GOICE:

## Communications examples

```
?tacl macro
clear all
param backupcpu 1
param cinittimer 120
param collector $0
param config icectl
param idblk 05d
param idnum 312FF
param cpname IYHR00C
param datapages 64
param dynamicrlu yes
param genesis $gen
param maxrcv 4096
param loglevel info
param netname GBIBMIYA
param password xxxxxxxxxxxxxxxxxxxxxxxx
param retrysl 5
param secuserid super.super
param startup %1%
param timer1 20
param timer2 300
param usstable default
run $system.ice.ice/name $ICE,nowait,cpu 0,pri 180,highpin off/
```

**Note:** The password param has been replaced by xxxxxxxxxxxxxxxxxxxxxxxx.

### Defining the line and APC information

Once the ICE process has been started with this configuration, the following information is input to the ICE process using the Node Operator Facility (NOF\*\*). This example defines a line called \$ICE01 running on the token ring port \$CHAMB.#ICE:

```
==
== ICE definitions for PU IYHR00C.
== Local LU for this PU is IYAHT0C0.
==

ALLOW ERRORS

OPEN $ICE

ABORT LINE $ICE01, SUB ALL

DELETE LINE $ICE01, SUB ALL

==
== ADD TOKEN RING LINE
==

ADD LINE $ICE01, TNDM $CHAMB.#ICE, &
      IDBLK %H05D, &
      PROTOCOL TOKENRING, WRITEBUFFERSIZE 8192
```

```
==  
== ADD PU OBJECT  
==
```

```
ADD PU IYHR00C, LINE $ICE01, MULTIRoute YES, &  
    DMAC 400045121088, DSAP %H04, &  
    NETNAME GBIBMIYA, IDNUM %H312FF, IDBLK %H05D, &  
    RCPNAME GBIBMIYA.IYAQCDRM, SSAP %H08
```

```
==  
== Add Local APPL Object  
==
```

```
DELETE APPL IYAHT0C0  
ADD APPL IYAHT0C0, ALIAS IYAHT0C0, LLU IYAHT0C0, PROTOCOL CPIC, &  
    OPENNAME #IYAHT0C
```

```
==  
== Add Mode LU62PS  
==
```

```
DELETE MODE LU62PS  
ADD MODE LU62PS, MAXSESS 8, MINCONWIN 4, MINCONLOS 3
```

```
==  
== Add Partner LU Objects  
==
```

```
== spinach (HP)
```

```
ABORT RLU IYABT0F0  
DELETE RLU IYABT0F0  
ADD RLU IYABT0F0, MODE LU62PS, PARSESS YES
```

```
== stingray (AIX)
```

```
ABORT RLU IYA3T995  
DELETE RLU IYA3T995  
ADD RLU IYA3T995, MODE LU62PS, PARSESS YES
```

```
== coop007 (OS/2)
```

```
ABORT RLU IYAFT170  
DELETE RLU IYAFT170  
ADD RLU IYAFT170, MODE LU62PS, PARSESS YES
```

## Communications examples

== MVS CICS

```
ABORT RLU IYCMVM03
DELETE RLU IYCMVM03
ADD RLU IYCMVM03, MODE LU62PS, PARSESS YES
```

== MVS Non-CICS

```
ABORT RLU IYCNVM03
DELETE RLU IYCNVM03
ADD RLU IYCNVM03, MODE LU62PS, PARSESS YES
```

== finnr100 (NT)

```
ABORT RLU IYAFT080
DELETE RLU IYAFT080
ADD RLU IYAFT080, MODE LU62PS, PARSESS YES
```

== winas18 (AS400)

```
ABORT RLU IYAFT110
DELETE RLU IYAFT110
ADD RLU IYAFT110, MODE LU62PS, PARSESS YES
```

```
ABORT RLU IYAHT080
DELETE RLU IYAHT080
ADD RLU IYAHT080, MODE LU62PS, PARSESS YES
```

==

```
== START UP ICE LINE $ICE01 AND SUB DEVICE
==
```

```
START LINE $ICE01, SUB ALL
```

**Note:** In order for this configuration to work, the port #ICE must have been defined to the token ring line. For example, these commands could be entered into SCF:

```
add port $chamb.#ice, type tr8025, address %H08
start port $chamb.#ice
```

where \$chamb is a token-ring controller, and the SAP of the port is %08.

## Channel definitions for ICE

Here are some MQSeries channel definitions that would support this ICE configuration:

- A sender channel to MQSeries on OS/390 (not using CICS):

```
DEFINE CHANNEL(MT01.VM03.SDRC.ICE) CHLTYPE(SDR) +
  TRPTYPE(LU62) +
  SEQWRAP(9999999) MAXMSGL(2048) +
  XMITQ('VM03NCM.TQ.SDRC.ICE') +
  CONNAME('$ICE.#IYAHT0C.IYAHT0C0.IYCNVM03') +
  MODENAME('LU62PS') TPNAME(DUMMY)
```

- A receiver channel from MQSeries on OS/390:

```
DEFINE CHANNEL(VM03.MT01.SDRC.ICE) CHLTYPE(RCVR) +
  TRPTYPE(LU62) REPLACE DESCR('Receiver channel from VM03NCM') +
  SEQWRAP(9999999) +
  MAXMSGL(2048) AUTOSTART(ENABLED) +
  CONNAME('$ICE.#IYAHT0C.IYAHT0C0') TPNAME(VM03NCMSDRRCVR)
```

- A server channel to MQSeries on OS/390 that is capable of initiating a conversation, or being initiated by a remote requester channel:

```
DEFINE CHANNEL(MT01.VM03.RQSV.ICE) CHLTYPE(SVR) +
  TRPTYPE(LU62) +
  SEQWRAP(9999999) MAXMSGL(2048) +
  XMITQ('VM03NCM.TQ.RQSV.ICE') +
  CONNAME('$ICE.#IYAHT0C.IYAHT0C0.IYCNVM03') +
  MODENAME('LU62PS') TPNAME(VM03NCMRQSVSVR.DUMMY) +
  AUTOSTART(ENABLED)
```

where DUMMY is the TPNAME the MVS queue manager is listening on.

## TCP/IP communications example

This example shows how to establish communications with a remote MQSeries system over TCP/IP.

### TCPCfg stanza in QMINI

The QMINI file must contain an appropriate TCPCfg stanza. For example:

```
TCPCfg:
  TCPPort=1414
  TCPNumListenerPorts=1
  TCPListenerPort=1996
  TCPKeepAlive=1
```

The TCPPort value is the default outbound port for channels without a port value in the CONNAME field. TCPListenerPort identifies the port on which the TCP listener will listen.

A queue manager can have multiple TCP/IP listeners. If this is the case, the QMINI file must have a TCPListenerPort entry for each listener, and TCPNumListenerPort must be updated to match. For example, the TCPCfg stanza above would be changed as follows:

```
TCPCfg:
  TCPPort=1414
  TCPNumListenerPorts=2
  TCPListenerPort=1997
  TCPKeepAlive=1
```

### Defining a TCP sender channel

A TCP sender channel must be defined. In this example, the queue manager is MH01 on a host called SPINACH:

## Communications examples

```
DEFINE CHANNEL(MT01_MH01_SDR_0001) CHLTYPE(SDR) +
  TRPTYPE(TCP) +
  SEQWRAP(9999999) MAXMSGL(4194304) +
  XMITQ('MH01_TQ_SDR_0001') +
  CONNAME('SPINACH.HURSLEY.IBM.COM(2000)')
```

This channel would try to attach to a TCP/IP port number 2000 on the host SPINACH.

The following example shows a TCP/IP sender channel definition for a queue manager MH01 on the host SPINACH using the *default* outbound TCP/IP port:

```
DEFINE CHANNEL(MT01_MH01_SDR_0001) CHLTYPE(SDR) +
  TRPTYPE(TCP) +
  SEQWRAP(9999999) MAXMSGL(4194304) +
  XMITQ('MH01_TQ_SDR_0001') +
  CONNAME('SPINACH.HURSLEY.IBM.COM')
```

No port number is specified in the CONNAME. Therefore, the value specified on the TCPPort entry in the QMINI file (1414) is used.

### Defining a TCP receiver channel

An example TCP receiver channel:

```
DEFINE CHANNEL(MH01_MT01_SDR_0001) CHLTYPE(RCVR) +
  TRPTYPE(TCP)
```

A TCP receiver channel requires no CONNAME value, but a TCP listener must be running. There are two ways of starting a TCP listener. Either:

1. Go into the queue manager's pathway using pathcom, and enter:

```
start server mqs-tcplis00
```

or

2. From the TACL prompt, enter

```
runmqtsr -m QMgrName
```

**Note:** If problems are encountered with the TACL from which the **runmqtsr** is running, the listener will be unable to access its home terminal and out file. **runmqtsr** is useful for testing, but you are recommended to use the listener from within the queue manager's pathway as shown in step 1.

A TCP/IP listener, which will listen on the port defined in the QMINI file (in this example, 1996), is started.

**Note:** This port number can be overridden by the **-p Port** flag on **runmqtsr**.

### Defining a TCP/IP sender channel on the remote system

The sender channel definition on the remote system to connect to this receiver channel could look like:

```
DEFINE CHANNEL(MH01_MT01_SDR_0001) CHLTYPE(SDR) +
  TRPTYPE(TCP) +
  XMITQ('MT01_TQ_SDR_0001') +
  CONNAME('TANDEM.ISC.UK.IBM.COM(1996)')
```

---

## Chapter 21. Message channel planning example for distributed platforms

This chapter provides a detailed example of how to connect two queue managers together so that messages can be sent between them. The example illustrates the preparations needed to allow an application using queue manager QM1 to put messages on a queue at queue manager QM2. An application running on QM2 can retrieve these messages, and send responses to a reply queue on QM1.

The example illustrates the use of TCP/IP connections. The example assumes that channels are to be triggered to start when the first message arrives on the transmission queue they are servicing. You must start the channel initiator in order for triggering to work.

This example uses SYSTEM.CHANNEL.INITQ as the initiation queue. This queue is already defined by MQSeries. You can use a different initiation queue, but you will have to define it yourself and specify the name of the queue when you start the channel initiator.

---

### What the example shows

The example shows the MQSeries commands (MQSC) that you can use.

In all the examples, the MQSC commands are shown as they would appear in a file of commands, and as they would be typed at the command line. The two methods look identical, but, to issue a command at the command line, you must first type `runmqsc`, for the default queue manager, or `runmqsc qmname` where *qmname* is the name of the required queue manager. Then type any number of commands, as shown in the examples.

An alternative method is to create a file containing these commands. Any errors in the commands are then easy to correct. If you called your file `mqsc.in` then to run it on queue manager QMNAME use:

```
runmqsc QMNAME < mqsc.in > mqsc.out
```

You could verify the commands in your file before running it using:

```
runmqsc -v QMNAME < mqsc.in > mqsc.out
```

For portability, you should restrict the line length of your commands to 72 characters. Use a concatenation character to continue over more than one line. On Tandem NSK use Ctrl-y to end the input at the command line, or enter the `exit` or `quit` command. On OS/2, Windows NT, or Digital OpenVMS use Ctrl-z. On UNIX systems use Ctrl-d. Alternatively, on V5.1 of MQSeries for AIX, HP-UX, OS/2 Warp, Sun Solaris, and Windows NT, use the **end** command.

Figure 36 on page 306 shows the example scenario.

## Planning example for distributed platforms

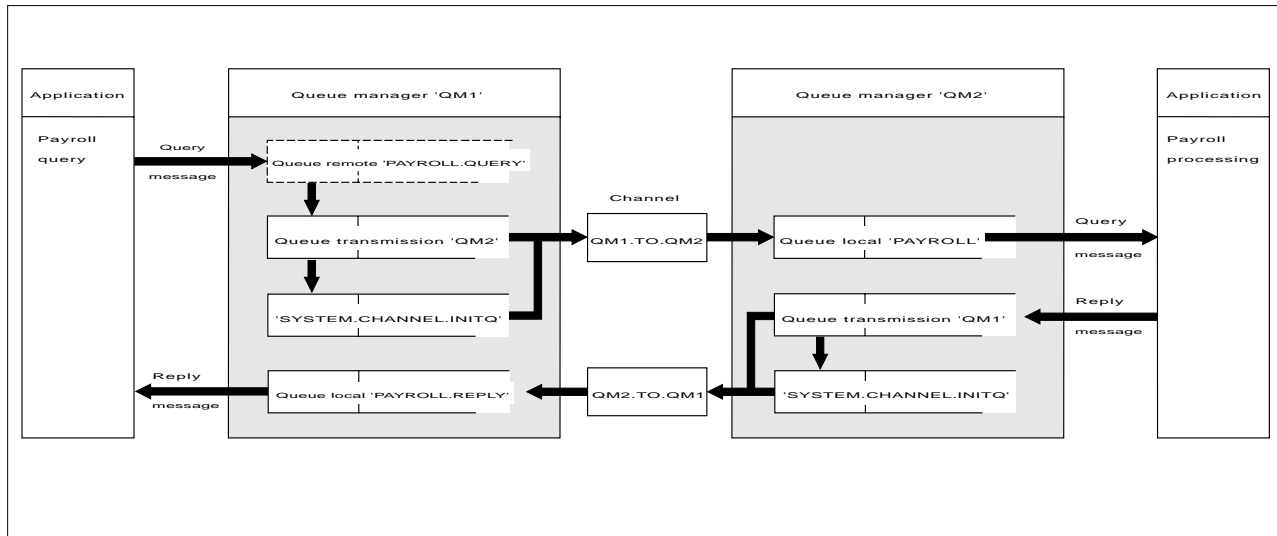

Figure 36. The message channel example for OS/2, Windows NT, and UNIX systems

The example involves a payroll query application connected to queue manager QM1 that sends payroll query messages to a payroll processing application running on queue manager QM2. The payroll query application needs the replies to its queries sent back to QM1. The payroll query messages are sent from QM1 to QM2 on a sender-receiver channel called QM1.TO.QM2, and the reply messages are sent back from QM2 to QM1 on another sender-receiver channel called QM2.TO.QM1. Both of these channels are triggered to start as soon as they have a message to send to the other queue manager.

The payroll query application puts a query message to the remote queue “PAYROLL.QUERY” defined on QM1. This remote queue definition resolves to the local queue “PAYROLL” on QM2. In addition, the payroll query application specifies that the reply to the query is sent to the local queue “PAYROLL.REPLY” on QM1. The payroll processing application gets messages from the local queue “PAYROLL” on QM2, and sends the replies to wherever they are required; in this case, local queue “PAYROLL.REPLY” on QM1.

In the example definitions for TCP/IP, QM1 has a host address of 9.20.9.31 and is listening on port 1411, and QM2 has a host address of 9.20.9.32 and is listening on port 1412. The example assumes that these are already defined on your system and available for use.

The object definitions that need to be created on QM1 are:

- Remote queue definition, PAYROLL.QUERY
- Transmission queue definition, QM2 (default=remote queue manager name)
- Process definition, QM1.TO.QM2.PROCESS (not needed for V5.1 of MQSeries for AIX, HP-UX, OS/2 Warp, Sun Solaris, and Windows NT)
- Sender channel definition, QM1.TO.QM2
- Receiver channel definition, QM2.TO.QM1
- Reply-to queue definition, PAYROLL.REPLY



## Planning example for distributed platforms

The object definitions that need to be created on QM2 are:

- Local queue definition, PAYROLL
- Transmission queue definition, QM1 (default=remote queue manager name)
- Process definition, QM2.TO.QM1.PROCESS (not needed for V5.1 of MQSeries for AIX, HP-UX, OS/2 Warp, Sun Solaris, and Windows NT)
- Sender channel definition, QM2.TO.QM1
- Receiver channel definition, QM1.TO.QM2

The connection details are supplied in the CONNAME attribute of the sender channel definitions.

You can see a diagram of the arrangement in Figure 36 on page 306.

### Queue manager QM1 example

The following object definitions allow applications connected to queue manager QM1 to send request messages to a queue called PAYROLL on QM2, and to receive replies on a queue called PAYROLL.REPLY on QM1.

All the object definitions have been provided with the DESCR and REPLACE attributes. The other attributes supplied are the minimum required to make the example work. The attributes that are not supplied take the default values for queue manager QM1.

Run the following commands on queue manager QM1.

#### Remote queue definition

```
DEFINE QREMOTE(PAYROLL.QUERY) DESCR('Remote queue for QM2') REPLACE +  
PUT(ENABLED) XMITQ(QM2) RNAME(PAYROLL) RQMNAME(QM2)
```

**Note:** The remote queue definition is not a physical queue, but a means of directing messages to the transmission queue, QM2, so that they can be sent to queue manager QM2.

#### Transmission queue definition

```
DEFINE QLOCAL(QM2) DESCR('Transmission queue to QM2') REPLACE +  
USAGE(XMITQ) PUT(ENABLED) GET(ENABLED) TRIGGER TRIGTYPE(FIRST) +  
INITQ(SYSTEM.CHANNEL.INITQ) PROCESS(QM1.TO.QM2.PROCESS)
```

When the first message is put on this transmission queue, a trigger message is sent to the initiation queue, SYSTEM.CHANNEL.INITQ. The channel initiator gets the message from the initiation queue and starts the channel identified in the named process.

#### Process definition

```
DEFINE PROCESS(QM1.TO.QM2.PROCESS) DESCR('Process for starting channel') +  
REPLACE APPLTYPE(OS2) USERDATA(QM1.TO.QM2)
```

The channel initiator uses this process information to start channel QM1.TO.QM2. (This sample definition uses OS2 as the application type).

**Note:** For V5.1 of MQSeries for AIX, HP-UX, OS/2 Warp, Sun Solaris, and Windows NT the need for a process definition can be eliminated by specifying the channel name in the *TRIGGERDATA* attribute of the transmission queue.

## Planning example for distributed platforms

### Sender channel definition

```
DEFINE CHANNEL(QM1.TO.QM2) CHLTYPE(SDR) TRPTYPE(TCP) +  
REPLACE DESCR('Sender channel to QM2') XMITQ(QM2) +  
CONNAME('9.20.9.32(1412)')
```

### Receiver channel definition

```
DEFINE CHANNEL(QM2.TO.QM1) CHLTYPE(RCVR) TRPTYPE(TCP) +  
REPLACE DESCR('Receiver channel from QM2')
```

### Reply-to queue definition

```
DEFINE QLOCAL(PAYROLL.REPLY) REPLACE PUT(ENABLED) GET(ENABLED) +  
DESCR('Reply queue for replies to query messages sent to QM2')
```

The reply-to queue is defined as PUT(ENABLED). This ensures that reply messages can be put to the queue. If the replies cannot be put to the reply-to queue, they are sent to the dead-letter queue on QM1 or, if this queue is not available, remain on transmission queue QM1 on queue manager QM2. The queue has been defined as GET(ENABLED) to allow the reply messages to be retrieved.

## Queue manager QM2 example

The following object definitions allow applications connected to queue manager QM2 to retrieve request messages from a local queue called PAYROLL, and to put replies to these request messages to a queue called PAYROLL.REPLY on queue manager QM1.

You do not need to provide a remote queue definition to enable the replies to be returned to QM1. The message descriptor of the message retrieved from local queue PAYROLL contains both the reply-to queue and the reply-to queue manager names. Therefore, as long as QM2 can resolve the reply-to queue manager name to that of a transmission queue on queue manager QM2, the reply message can be sent. In this example, the reply-to queue manager name is QM1 and so queue manager QM2 simply requires a transmission queue of the same name.

All the object definitions have been provided with the DESCR and REPLACE attributes and are the minimum required to make the example work. The attributes that are not supplied take the default values for queue manager QM2.

Run the following commands on queue manager QM2.

### Local queue definition

```
DEFINE QLOCAL(PAYROLL) REPLACE PUT(ENABLED) GET(ENABLED) +  
DESCR('Local queue for QM1 payroll details')
```

This queue is defined as PUT(ENABLED) and GET(ENABLED) for the same reason as the reply-to queue definition on queue manager QM1.

### Transmission queue definition

```
DEFINE QLOCAL(QM1) DESCR('Transmission queue to QM1') REPLACE +  
USAGE(XMITQ) PUT(ENABLED) GET(ENABLED) TRIGGER TRIGTYPE(FIRST) +  
INITQ(SYSTEM.CHANNEL.INITQ) PROCESS(QM2.TO.QM1.PROCESS)
```

When the first message is put on this transmission queue, a trigger message is sent to the initiation queue, SYSTEM.CHANNEL.INITQ. The channel initiator gets the message from the initiation queue and starts the channel identified in the named process.

### Process definition

```
DEFINE PROCESS(QM2.TO.QM1.PROCESS) DESCR('Process for starting channel') +  
REPLACE APPLTYPE(OS2) USERDATA(QM2.TO.QM1)
```

The channel initiator uses this process information to start channel QM2.TO.QM1. (This sample definition uses OS2 as the application type.)

**Note:** For V5.1 of MQSeries for AIX, HP-UX, OS/2 Warp, Sun Solaris, and Windows NT the need for a process definition can be eliminated by specifying the channel name in the *TRIGGERDATA* attribute of the transmission queue.

### Sender channel definition

```
DEFINE CHANNEL(QM2.TO.QM1) CHLTYPE(SDR) TRPTYPE(TCP) +  
REPLACE DESCR('Sender channel to QM1') XMITQ(QM1) +  
CONNAME('9.20.9.31(1411)')
```

### Receiver channel definition

```
DEFINE CHANNEL(QM1.TO.QM2) CHLTYPE(RCVR) TRPTYPE(TCP) +  
REPLACE DESCR('Receiver channel from QM1')
```

---

## Running the example

Once these definitions have been created, you need to:

- Start the channel initiator on each queue manager.
- Start the INETD daemon for each queue manager. On OS/2, Windows NT, and Tandem NSK, you can use the MQSeries listener in place of INETD.

For information about starting the channel initiator and listener, see “Chapter 10. Setting up communication for OS/2 and Windows NT” on page 123 and “Chapter 13. Setting up communication in UNIX systems” on page 191.

**Note:** On OS/2 and Windows NT, you can also run the channel as a thread; see the *MQSeries Command Reference* book for information about how to define a channel as a threaded channel.

## Expanding this example

This simple example could be expanded with:

- The use of LU 6.2 communications for interconnection with CICS systems, and transaction processing.
- Adding more queue, process, and channel definitions to allow other applications to send messages between the two queue managers.
- Adding user-exit programs on the channels to allow for link encryption, security checking, or additional message processing.
- Using queue-manager aliases and reply-to queue aliases to understand more about how these can be used in the organization of your queue manager network.

## Planning example for distributed platforms

---

## Chapter 22. Example SINIX and DC/OSx configuration files

This chapter contains working examples of SNA LU 6.2 configuration files for SINIX and DC/OSx.

### Notes:

1. The TCP/IP names for the SINIX machines involved are *forties*, which is an RM400, and *bight*, which is an RM200.
2. The name of the queue manager on *forties* is MP01, and the name of the queue manager on *bight* is MP02.
3. Both machines are running the SINIX-N operating system.
4. The LU names have a resemblance to the TCP/IP names.
5. The XIDs have been arbitrarily chosen to reflect the RM model numbers.
6. The machine *rameses* is a DC/OSx MIS-2ES/2 machine using the DC/OSx operating system. The configuration for *rameses* is different because the operating system SNA software on DC/OSx is different.
7. The name of the queue manager on *rameses* is MP04.

The preceding information can be summarized as follows:

Machine name	Machine model	Operating system	Queue manager
<i>forties</i>	RM400	SINIX-N	MP01
<i>bight</i>	RM200	SINIX-N	MP02
<i>rameses</i>	MIS-2ES/2	DC/OSx	MP04

You should use these examples as a basis for your system. You need to generate configuration files that are appropriate to your SNA network.

For a further description on the contents of KOGS files and Transit (SINIX LU6.2) setup, see the *Transit SINIX Version 3.2 Administration of Transit* manual.

The KOGS files can be found in the directory `/opt/lib/transit/KOGS`.

“Working configuration files for Pyramid DC/OSx” on page 313 shows example working configuration files from the DC/OSx machine *rameses*. The file is `/etc/opt/lu62/cpic_cfg`. For further information on the format of this file see the Pyramid Technology publications *OpenNet LU 6.2, System Administrator’s Guide*, and *OpenNet SNA Engine, System Administrator’s Guide*.

“Output of `dbd` command” on page 314 is the output of the `dbd` command on `cfg.ncpram`, which is a binary configuration file created by the `cm` command.

## Configuration file on bight

```

* Transit config file for bight (RM200).
* Versionen und Korrekturstaende
*      TRANSIT-SERVER V 3.3  confnuc.h K1
*      SNA_Kgen K1

XLINK      lforties,
           ACT          = AUTO,
           TYP          = LAN,
           XID          = 00000400,
           CPNAME       = CP.FORTIES,
           CONFSTR      = /opt/lib/llc2/conf.str,
           DEVICE       = tr0,
           SSAP         = 04

XPU        pbight,
           TYP          = PEER,
           CONNECT      = AUTO,
*          DISCNT       = AUTO,
           LINK         = lforties,
           NVSCONNECT   = PARTNER,
           MAXDATA      = 1033,
           XID          = 00000200,
           CPNAME       = CP.BIGHT,
           ROLE         = NEG,
           PAUSE        = 3,
           RETRIES      = 10,
           DMAC         = 000F01626436,
           DSAP         = 04,
           RWINDOW     = 7

XLU        forties,
           TYP          = 6,
           PUCONNECT   = APHSTART,
           CTYP        = PUBLIC,
           SESS-LMT     = 130,
           SESS-CTR     = IND,
           NETNAME      = SNI.FORTIES,
           PAIR         = bight MODE1

XRLU       bight,
           NETNAME     = SNI.BIGHT,
           PU          = pbight

XMODE      MODE1,
           SESS-MAX    = 13,
           SESS-LOS    = 6,
           SESS-WIN    = 7,
           SESS-AUTO   = 7,
           SRU-MAX     = 87,
           RRU-MAX     = 87,
           PAC-SEND    = 0,
           PAC-RCV     = 0

XSYMDEST   sendMP02,
           RLU         = bight,
           MODE        = MODE1,
           TP          = recvMP02,
           TP-TYP      = USER,
           SEC-TYP     = NONE

XTP        recvMP01,
           UID         = guenther,
           TYP        = USER,
           PATH        = /home/guenther/recvMP01.sh,
           SECURE      = NO

XEND

```

## Configuration file on forties

```

* Transit config file for forties (RM 400).
* Versionen und Korrekturstaende
*   TRANSIT-SERVER V 3.3  confnuc.h K1
*   SNA_Kgen K1

XLINK      lbight,
           ACT       = AUTO,
           TYP       = LAN,
           XID       = 00000200,
           CPNAME    = CP.BIGHT,
           CONFSTR   = /opt/lib/llc2/conf.str,
           DEVICE    = tr0,
           SSAP      = 04

XPU        pforties,
           TYP       = PEER,
           CONNECT   = AUTO,
           DISCNT    = AUTO,
           LINK      = lbight,
           NVSCONNECT = PARTNER,
           MAXDATA   = 1033,
           XID       = 00000400,
           CPNAME    = CP.FORTIES,
           ROLE      = NEG,
           PAUSE     = 3,
           RETRIES   = 10,
           DMAC      = 00006f106935,
           DSAP      = 04,
           RWINDOW   = 7

XLU        bight,
           TYP       = 6,
           PUCONNECT = APHSTART,
           CTYP      = PUBLIC,
           SESS-LMT  = 15,
           SESS-CTR  = IND,
           NETNAME   = SNI.BIGHT,
           PAIR      = forties MODE1

XRLU       forties,
           NETNAME   = SNI.FORTIES,
           PU        = pforties

XMODE      MODE1,
           SESS-MAX  = 13,
           SESS-LOS  = 7,
           SESS-WIN  = 6,
           SESS-AUTO = 6,
           SRU-MAX   = 87,
           RRU-MAX   = 87,
           PAC-SEND  = 0,
           PAC-RCV   = 0

XSYMDEST   sendMP01,
           RLU       = forties,
           MODE      = MODE1,
           TP        = recvMP01,
           TP-TYP    = USER,
           SEC-TYP   = NONE

XTP        recvMP02,
           UID       = guenther,
           TYP       = USER,
           PATH      = /home/guenther/recvMP02.sh,
           SECURE    = NO

XEND

```

## Working configuration files for Pyramid DC/OSx

```

#
# This is the side information file for CPI-C.
#
# The default file name is /etc/opt/lu62/cpic_cfg, use set environmental
# variable CPIC_CFG to change the default.
#
#
# The lines starting with # are for comments; no blank lines are allowed.
# The format of each line is "1 2 3 4 5 6 7 8 9" all in one line.

```

## SINIX and DC/OSx configuration

```
#      1 - symbolic destination name
#      2 - local LU name (locally known name)
#      3 - remote LU name (locally known name)
#      4 - mode name
#      5 - remote TP name
#      6 - trace flag (1 if you want the trace on, 0 otherwise)
#      7 - security type (0 for none, 2 for program)
#      8 - user id (omit if security type is 0)
#      9 - password (omit if security type is 0)
#
# The following are some examples:
#
#sendMP02  LRAMESES      BIGHT  MODE1  recvMP02      1      0
sendMP02  IYAFT1F0      IYAFT000  LU62PS  recvMP02      1  0
sendMP03  IYAFT1F0      IYAFT010  LU62PS  recvMP03      1  0
sendMP01  IYAFT1F0      IYAET120  LU62PS  recvMP01      1  0
sdEH01rc  IYAFT1F0      IYABT0F0  LU62PS  MP04RCV       1  0
sdEH01sv  IYAFT1F0      IYABT0F0  LU62PS  MP04SVR       1  0
sendM401  IYAFT1F0      IYAFT110  LU62PS  INTCRS6A     1  0
sendvm02  IYAFT1F0      IYCNVM02  LU62PS  DUMMY        1  0
sndvm2rc  IYAFT1F0      IYCMVM02  LU62PS  CKRC         1  0
sndvm2sd  IYAFT1F0      IYCMVM02  LU62PS  CKSD         1  0
sndvm2sv  IYAFT1F0      IYCMVM02  LU62PS  CKSV         1  0
```

## Output of dbd command

```
****      COMMUNICATIONS MANAGER DATABASE      ****
Database version number 80

SNA CONTROLLER
  controller name: SNA
  controller execute name:
    'startsna62 -c 24'

62 MANAGER
  62 manager name: LU62MGR
  62 manager execute name:
    'lu62mgr'

LOCAL PU
  local pu name: IYAFT1F0
  controller name: SNA
  non-specific type pu
  unsolicited recfms is NOT supported
  xid format (0/3): 3

LOCAL LU
  fully qualified local lu name (hex): c7 c2 c9 c2 d4 c9 e8 c1 4b c9 e8 c1 c6 e3 f1 c6 f0
  fully qualified local lu name (ebcdic): GBIBMIYA.IYAFT1F0
  locally known local lu name: IYAFT1F0
  local pu name: IYAFT1F0
  lu number at the pu: 1
  lu6.2 type lu
  62 manager name: LU62MGR
  lu session limit: 100
  share limit: 2
  send window size: 7
  LU configuration options:
    is NOT the default lu
    will NOT terminate on disconnect
    printer can NOT be used in system mode
    independent LU on BF connections

REMOTE PU
  remote pu name: CPPG

REMOTE LU
  fully qualified remote lu name (hex): c7 c2 c9 c2 d4 c9 e8 c1 4b c9 e8 c1 c6 e3 f0 f0 f0
  fully qualified remote lu name (ebcdic): GBIBMIYA.IYAFT000
  locally known remote lu name: IYAFT000
  fully qualified local lu name (hex): c7 c2 c9 c2 d4 c9 e8 c1 4b c9 e8 c1 c6 e3 f1 c6 f0
  fully qualified local lu name (ebcdic): GBIBMIYA.IYAFT1F0
  uninterpreted remote lu name (hex): c9 e8 c1 c6 e3 f0 f0 f0
  uninterpreted remote lu name (ebcdic): IYAFT000
  remote pu name: CPPG
  session initiation requests are initiate or queue
  parallel sessions supported
```



## SINIX and DC/OSx configuration

no security information accepted  
lu-lu verification NOT required  
lu-lu password not displayed for security reasons

### REMOTE LU

fully qualified remote lu name (hex): c7 c2 c9 c2 d4 c9 e8 c1 4b c9 e8 c1 c6 e3 f0 f1 f0  
fully qualified remote lu name (ebcdic): GBIBMIYA.IYAFT010  
locally known remote lu name: IYAFT010  
fully qualified local lu name (hex): c7 c2 c9 c2 d4 c9 e8 c1 4b c9 e8 c1 c6 e3 f1 c6 f0  
fully qualified local lu name (ebcdic): GBIBMIYA.IYAFT1F0  
uninterpreted remote lu name (hex): c9 e8 c1 c6 e3 f0 f1 f0  
uninterpreted remote lu name (ebcdic): IYAFT010  
remote pu name: CPPG  
session initiation requests are initiate or queue  
parallel sessions supported  
no security information accepted  
lu-lu verification NOT required  
lu-lu password not displayed for security reasons

### REMOTE LU

fully qualified remote lu name (hex): c7 c2 c9 c2 d4 c9 e8 c1 4b c9 e8 c1 c5 e3 f1 f2 f0  
fully qualified remote lu name (ebcdic): GBIBMIYA.IYAET120  
locally known remote lu name: IYAET120  
fully qualified local lu name (hex): c7 c2 c9 c2 d4 c9 e8 c1 4b c9 e8 c1 c6 e3 f1 c6 f0  
fully qualified local lu name (ebcdic): GBIBMIYA.IYAFT1F0  
uninterpreted remote lu name (hex): c9 e8 c1 c5 e3 f1 f2 f0  
uninterpreted remote lu name (ebcdic): IYAET120  
remote pu name: CPPG  
session initiation requests are initiate or queue  
parallel sessions supported  
no security information accepted  
lu-lu verification NOT required  
lu-lu password not displayed for security reasons

### MODE

mode name (hex): e2 d5 c1 e2 e5 c3 d4 c7  
mode name (ebcdic): SNASVCMG  
fully qualified local lu name (hex): c7 c2 c9 c2 d4 c9 e8 c1 4b c9 e8 c1 c6 e3 f1 c6 f0  
fully qualified local lu name (ebcdic): GBIBMIYA.IYAFT1F0  
fully qualified remote lu name (hex): c7 c2 c9 c2 d4 c9 e8 c1 4b c9 e8 c1 c6 e3 f0 f0 f0  
fully qualified remote lu name (ebcdic): GBIBMIYA.IYAFT000  
line class name: leased  
send pacing window: 7  
receive pacing window: 7  
lower bound max RU size, send: 128  
upper bound max RU size, send: 896  
lower bound max RU size, receive: 128  
upper bound max RU size, receive: 896  
synchronization level of none or confirm  
either lu may attempt to reinitiate the session  
cryptography not supported  
contention-winner automatic initiation limit: 1

### MODE

mode name (hex): d3 e4 f6 f2 d7 e2  
mode name (ebcdic): LU62PS  
fully qualified local lu name (hex): c7 c2 c9 c2 d4 c9 e8 c1 4b c9 e8 c1 c6 e3 f1 c6 f0  
fully qualified local lu name (ebcdic): GBIBMIYA.IYAFT1F0  
fully qualified remote lu name (hex): c7 c2 c9 c2 d4 c9 e8 c1 4b c9 e8 c1 c6 e3 f0 f0 f0  
fully qualified remote lu name (ebcdic): GBIBMIYA.IYAFT000  
line class name: leased  
send pacing window: 7  
receive pacing window: 7  
lower bound max RU size, send: 128  
upper bound max RU size, send: 896  
lower bound max RU size, receive: 128  
upper bound max RU size, receive: 896  
synchronization level of none or confirm  
either lu may attempt to reinitiate the session  
cryptography not supported  
contention-winner automatic initiation limit: 5

### MODE

mode name (hex): e2 d5 c1 e2 e5 c3 d4 c7  
mode name (ebcdic): SNASVCMG  
fully qualified local lu name (hex): c7 c2 c9 c2 d4 c9 e8 c1 4b c9 e8 c1 c6 e3 f1 c6 f0  
fully qualified local lu name (ebcdic): GBIBMIYA.IYAFT1F0  
fully qualified remote lu name (hex): c7 c2 c9 c2 d4 c9 e8 c1 4b c9 e8 c1 c6 e3 f0 f1 f0  
fully qualified remote lu name (ebcdic): GBIBMIYA.IYAFT010  
line class name: leased

## SINIX and DC/OSx configuration

```
send pacing window: 7
receive pacing window: 7
lower bound max RU size, send: 128
upper bound max RU size, send: 896
lower bound max RU size, receive: 128
upper bound max RU size, receive: 896
synchronization level of none or confirm
either lu may attempt to reinitiate the session
cryptography not supported
contention-winner automatic initiation limit: 1
```

MODE

```
mode name (hex): d3 e4 f6 f2 d7 e2
mode name (ebcdic): LU62PS
fully qualified local lu name (hex): c7 c2 c9 c2 d4 c9 e8 c1 4b c9 e8 c1 c6 e3 f1 c6 f0
fully qualified local lu name (ebcdic): GBIBMIYA.IYAFT1F0
fully qualified remote lu name (hex): c7 c2 c9 c2 d4 c9 e8 c1 4b c9 e8 c1 c6 e3 f0 f1 f0
fully qualified remote lu name (ebcdic): GBIBMIYA.IYAFT010
line class name: leased
send pacing window: 7
receive pacing window: 7
lower bound max RU size, send: 128
upper bound max RU size, send: 896
lower bound max RU size, receive: 128
upper bound max RU size, receive: 896
synchronization level of none or confirm
either lu may attempt to reinitiate the session
cryptography not supported
contention-winner automatic initiation limit: 5
```

MODE

```
mode name (hex): e2 d5 c1 e2 e5 c3 d4 c7
mode name (ebcdic): SNASVCMG
fully qualified local lu name (hex): c7 c2 c9 c2 d4 c9 e8 c1 4b c9 e8 c1 c6 e3 f1 c6 f0
fully qualified local lu name (ebcdic): GBIBMIYA.IYAFT1F0
fully qualified remote lu name (hex): c7 c2 c9 c2 d4 c9 e8 c1 4b c9 e8 c1 c5 e3 f1 f2 f0
fully qualified remote lu name (ebcdic): GBIBMIYA.IYAET120
line class name: leased
send pacing window: 7
receive pacing window: 7
lower bound max RU size, send: 128
upper bound max RU size, send: 896
lower bound max RU size, receive: 128
upper bound max RU size, receive: 896
synchronization level of none or confirm
either lu may attempt to reinitiate the session
cryptography not supported
contention-winner automatic initiation limit: 1
```

MODE

```
mode name (hex): d3 e4 f6 f2 d7 e2
mode name (ebcdic): LU62PS
fully qualified local lu name (hex): c7 c2 c9 c2 d4 c9 e8 c1 4b c9 e8 c1 c6 e3 f1 c6 f0
fully qualified local lu name (ebcdic): GBIBMIYA.IYAFT1F0
fully qualified remote lu name (hex): c7 c2 c9 c2 d4 c9 e8 c1 4b c9 e8 c1 c5 e3 f1 f2 f0
fully qualified remote lu name (ebcdic): GBIBMIYA.IYAET120
line class name: leased
send pacing window: 7
receive pacing window: 7
lower bound max RU size, send: 128
upper bound max RU size, send: 896
lower bound max RU size, receive: 128
upper bound max RU size, receive: 896
synchronization level of none or confirm
either lu may attempt to reinitiate the session
cryptography not supported
contention-winner automatic initiation limit: 5
```

TRANSACTION PROGRAM

```
transaction program name (hex): 99 85 83 a5 d4 d7 f0 f4
transaction program name (ebcdic): recvMP04
transaction program execute name:
'/home/guenther/recvMP04.sh'
tp is enabled
tp supports basic conversations
tp supports mapped conversations
tp supports confirm synchronization
tp supports no synchronization
no verification is required
number of pip fields required: 0
```

## SINIX and DC/OSx configuration

```
privilege mask (hex): 0
(no privileges)

TRANSACTION PROGRAM
transaction program name (hex): 06 f1
transaction program name (ebcdic): ?1
transaction program execute name:
'06f1'
tp is enabled
tp supports basic conversations
tp supports confirm synchronization
tp supports no synchronization
no verification is required
number of pip fields required: 0
privilege mask (hex): 82
(cnos - allocate_service_tp privileges)

TOKEN RING COMMUNICATIONS MEDIA
line name: LINE0
line number: 0
controller name: SNA
line class: leased

LOCAL LINK STATION
link station name: LYAFT1F0
pu name: IYAFT1F0
line name: LINE0
secondary station
LSAP address (in hex): 04
i-field size: 1033
Acknowledgement delay window size : 7
Acknowledgement delay timeout in tenth of seconds : 3
Retry count : 20
Retry timeout in seconds : 3
send xid block number: 0 5d
send xid id number: 3 0f 5c
send xid control vector:

REMOTE LINK STATION
link station name: LCPPG
pu name: CPPG
line name: LINE0
primary station
MAC address: 40 00 45 12 10 88
LSAP address (in hex): 04
i-field size: 1033
Remote station type : BF
send xid block number:
send xid id number:
send xid control vector:
```

## SINIX and DC/OSx configuration

---

## Part 4. DQM in MQSeries for OS/390

<b>Chapter 23. Monitoring and controlling channels on OS/390</b> . . . . .	321
The DQM channel control function . . . . .	321
Using the panels and the commands . . . . .	322
Using the initial panel . . . . .	322
Managing your channels . . . . .	324
Defining a channel . . . . .	324
Altering a channel definition . . . . .	325
Displaying a channel definition . . . . .	325
Displaying information about DQM . . . . .	326
Deleting a channel definition . . . . .	326
Starting a channel initiator . . . . .	327
Stopping a channel initiator . . . . .	328
Starting a channel listener . . . . .	329
Stopping a channel listener . . . . .	329
Starting a channel . . . . .	330
Testing a channel . . . . .	331
Resetting message sequence numbers for a channel . . . . .	332
Resolving in-doubt messages on a channel . . . . .	333
Stopping a channel . . . . .	334
Displaying channel status . . . . .	335
Displaying cluster channels. . . . .	337
<b>Chapter 24. Preparing MQSeries for OS/390</b> . . . . .	339
Setting up communication . . . . .	339
TCP setup . . . . .	339
Connecting to TCP . . . . .	340
Receiving on TCP . . . . .	340
Using the TCP listener backlog option . . . . .	340
APPC/MVS setup. . . . .	341
Connecting to APPC/MVS (LU 6.2) . . . . .	342
Receiving on LU 6.2 . . . . .	342
Defining DQM requirements to MQSeries . . . . .	342
Defining MQSeries objects . . . . .	342
Synchronization queue . . . . .	343
Channel command queues . . . . .	343
Channel operation considerations . . . . .	344
OS/390 Automatic Restart Management (ARM) . . . . .	344
<b>Chapter 25. Message channel planning example for OS/390</b> . . . . .	345
What the example shows . . . . .	345
Queue manager QM1 example . . . . .	346
Remote queue definition . . . . .	346
Transmission queue definition. . . . .	347
Process definition . . . . .	347
Sender channel definition . . . . .	347
Receiver channel definition. . . . .	347
Reply-to queue definition . . . . .	347
Queue manager QM2 example . . . . .	347
Local queue definition . . . . .	348
Transmission queue definition. . . . .	348
Process definition . . . . .	348
Sender channel definition . . . . .	348
Receiver channel definition. . . . .	348
Running the example. . . . .	349
Expanding this example. . . . .	349
<b>Chapter 26. Monitoring and controlling channels in OS/390 with CICS</b> . . . . .	351
The DQM channel control function . . . . .	351
CICS regions . . . . .	352
Starting DQM panels. . . . .	352
The Message Channel List panel . . . . .	353
Keyboard functions . . . . .	353
Function keys . . . . .	353
Enter key. . . . .	354
Clear key. . . . .	354
Unassigned keys and unavailable choices . . . . .	354
Selecting a channel . . . . .	354
Working with channels . . . . .	354
Creating a channel . . . . .	356
Altering a channel. . . . .	356
Browsing a channel . . . . .	356
Renaming a channel . . . . .	357
Selected menu-bar choice . . . . .	357
Start . . . . .	357
Stop . . . . .	359
Resync . . . . .	361
Reset . . . . .	362
Resolve . . . . .	363
Display status . . . . .	364
Display settings . . . . .	365
Ping . . . . .	366
Exit. . . . .	366
Edit menu-bar choice. . . . .	367
Copy . . . . .	367
Create. . . . .	368
Alter . . . . .	370
Delete. . . . .	370
Find . . . . .	370
View menu-bar choice . . . . .	371
Help menu-bar choice . . . . .	372
The channel definition panels . . . . .	372
Channel menu-bar choice . . . . .	373
Saving changes. . . . .	373
Exit from the panel . . . . .	373
Help menu-bar choice . . . . .	373
Channel settings panel fields . . . . .	374
Details of sender channel settings panel . . . . .	376
Details of receiver channel settings panel . . . . .	377
Details of server channel settings panel. . . . .	378
Details of requester channel settings panel. . . . .	379
<b>Chapter 27. Preparing MQSeries for OS/390 when using CICS</b> . . . . .	381
Setting up CICS communication for MQSeries for OS/390 . . . . .	381
Connecting CICS systems . . . . .	381
Communication between queue managers . . . . .	381
Intersystem communication . . . . .	382

## DQM in MQSeries for OS/390

Defining an LU 6.2 connection . . . . .	382
Installing the connection. . . . .	383
Communications between CICS systems attached to one queue manager . . . . .	383
Connection names for function shipping . . .	383
Defining DQM requirements to MQSeries . . . .	384
Defining MQSeries objects . . . . .	384
Multiple message channels per transmission queue . . . . .	384
Channel operation considerations . . . . .	385

<b>Chapter 28. Message channel planning example for OS/390 using CICS.</b> . . . . .	387
--	-----

<b>Chapter 29. Example configuration - IBM MQSeries for OS/390</b> . . . . .	395
Configuration parameters for an LU 6.2 connection	395
Configuration worksheet . . . . .	396
Explanation of terms . . . . .	398
Establishing an LU 6.2 connection . . . . .	400
Defining yourself to the network . . . . .	400
Defining a connection to a partner . . . . .	402
What next? . . . . .	402
Establishing an LU 6.2 connection using CICS . .	402
Defining a connection . . . . .	402
Defining the sessions. . . . .	403

Installing the new group definition . . . . .	404
What next? . . . . .	404
Establishing a TCP connection. . . . .	404
What next? . . . . .	405
MQSeries for OS/390 configuration . . . . .	405
Channel configuration . . . . .	405
MQSeries for OS/390 sender-channel definitions using non-CICS LU 6.2 . . . .	408
MQSeries for OS/390 receiver-channel definitions using non-CICS LU 6.2 . . . .	408
MQSeries for OS/390 sender-channel definitions using TCP . . . . .	409
MQSeries for OS/390 receiver-channel definitions using TCP . . . . .	409
MQSeries for OS/390 sender-channel definitions using CICS . . . . .	409
MQSeries for OS/390 receiver-channel definitions using CICS . . . . .	409
Defining a local queue . . . . .	409
Defining a remote queue . . . . .	412
Defining a sender channel when not using CICS	413
Defining a receiver channel when not using CICS . . . . .	415
Defining a sender channel using CICS . . . .	417
Defining a receiver channel using CICS . . .	418

This part of the book describes the MQSeries distributed queue management function for MQSeries for OS/390 using native OS/390 communication protocols (SNA LU 6.2 and TCP/IP). You can also use CICS ISC for distributed queuing.

**Note:** You can use distributed queuing both with CICS and without CICS simultaneously on the same MQSeries instance, but they will have no knowledge of each other, or of each other's channels. It is up to you to ensure that they have distinct sets of channel names. Most of the information here applies equally to MQSeries for MVS/ESA.

---

## Chapter 23. Monitoring and controlling channels on OS/390

Use the DQM commands and panels to create, monitor, and control the channels to remote queue managers. Each OS/390 queue manager has a DQM program (the *channel initiator*) for controlling interconnections to compatible remote queue managers using native OS/390 facilities.

The implementation of these panels and commands on OS/390 is integrated into the operations and control panels and the MQSC commands. No differentiation is made in the organization of these two sets of panels and commands.

If you are using CICS for DQM, see “Chapter 26. Monitoring and controlling channels in OS/390 with CICS” on page 351. Most of the information here applies equally to MQSeries for MVS/ESA.

---

### The DQM channel control function

The channel control function provides the administration and control of message channels between MQSeries for OS/390 and compatible systems. See Figure 28 on page 58 for a conceptual picture.

The channel control function consists of panels, commands and programs, a synchronization queue, channel command queues, and the channel definitions. The following is a brief description of the components of the channel control function.

- The channel definitions are held as objects in page set zero, like other MQSeries objects in OS/390.
- You use the operations and control panels or MQSC commands to:
  - Create, copy, display, alter, and delete channel definitions
  - Start and stop channel initiators and listeners
  - Start, stop, and ping channels, reset channel sequence numbers, and resolve in-doubt messages when links cannot be re-established
  - Display status information about channels
  - Display information about DQM

In particular, you can use the CSQINPX initialization input data set to issue your MQSC commands. This can be processed every time you start the channel initiator. See the *MQSeries for OS/390 System Management Guide* for information about this.

- There is a queue (SYSTEM.CHANNEL.SYNCQ) used for channel re-synchronization purposes. You should define this with INDXTYPE(MSGID) for performance reasons.
- Channel command queues (SYSTEM.CHANNEL.INITQ and SYSTEM.CHANNEL.REPLY.INFO) are used to hold commands for channel initiators, channels, and listeners, and replies from them.
- The channel control function program runs in its own address space, separate from the queue manager, and comprises the channel initiator, listeners, MCAs, trigger monitor, and command handler.

## Using the panels and the commands

You can use either the MQSC commands or the operations and control panels to manage DQM. For information about the syntax of the MQSC commands, see the *MQSeries Command Reference* book.

### Using the initial panel

For an introduction to invoking the operations and control panels, using the function keys, and getting help, see the *MQSeries for OS/390 System Management Guide*.

**Note:** To use the operations and control panels, you must have the correct security authorization; see the *MQSeries for OS/390 System Management Guide* for information. Figure 37 shows the panel that is displayed when you start a panel session.

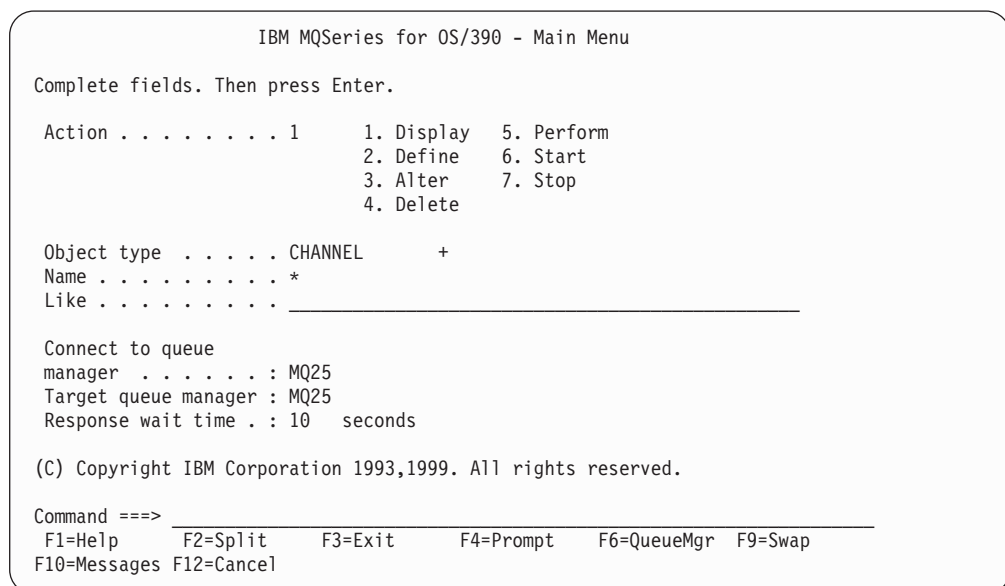

Figure 37. The operations and controls initial panel

From this panel you can:

- Select the action you want to perform by typing in the appropriate number in the **Action** field.
- Specify the object type that you want to work with. Press F4 for a list of object types if you are not sure what they are.
- Display a list of objects of the type specified. Type in an asterisk (\*) in the **Name** field and press Enter to display a list of objects (of the type specified) that have already been defined on this subsystem. You can then select one or more objects to work with in sequence. Figure 38 on page 323 shows a list of channels produced in this way.
- Define an object with the same attributes as an existing object. See “Defining a channel” on page 324.
- Choose the local queue manager you want, and whether you want the commands issued on that queue manager or on some remote queue manager.
- Choose the wait time for responses to be received.



```

List Channels                                     Row 1 of 8

Type action codes. Then press Enter.
1=Display  2=Define like  3=Alter  4=Delete  5=Perform
6=Start    7=Stop

Name                                               Type      Status
- SYSTEM.DEF.CLNTCONN                             CHLCLNTCONN
- SYSTEM.DEF.CLUSRCVR                             CHLCLUSRCVR
- SYSTEM.DEF.CLUSSDR                              CHLCLUSSDR
- SYSTEM.DEF.RECEIVER                             CHLRECEIVER
- SYSTEM.DEF.REQUESTER                           CHLREQUESTER
- SYSTEM.DEF.SENDER                              CHLSENDER
- SYSTEM.DEF.SERVER                              CHLSERVER
- SYSTEM.DEF.SVRCONN                             CHLSVRCONN
***** End of list *****

Command ==> _____
F1=Help    F2=Split  F3=Exit   F5=Refresh F7=Bkwd   F8=Fwd
F9=Swap    F10=Messages F11=Status F12=Cancel

```

Figure 38. Listing channels

## Managing your channels

Table 29 lists the tasks that you can perform to manage your channels, channel initiators, and listeners. It also gives the name of the relevant MQSC command, and points to the page where each task is discussed.

Table 29. Channel tasks

Task to be performed	MQSC command	See page
Define a channel	DEFINE CHANNEL	324
Alter a channel definition	ALTER CHANNEL	325
Display a channel definition	DISPLAY CHANNEL	325
Delete a channel definition	DELETE CHANNEL	326
Start a channel initiator	START CHINIT	327
Stop a channel initiator	STOP CHINIT	328
Display channel initiator information	DISPLAY DQM	326
Start a channel listener	START LISTENER	329
Stop a channel listener	STOP LISTENER	329
Start a channel	START CHANNEL	330
Test a channel	PING CHANNEL	331
Reset message sequence numbers for a channel	RESET CHANNEL	332
Resolve in-doubt messages on a channel	RESOLVE CHANNEL	333
Stop a channel	STOP CHANNEL	334
Display channel status	DISPLAY CHSTATUS	335
Display cluster channels	DISPLAY CLUSQMGR	337

## Defining a channel

To define a channel using the MQSC commands, use DEFINE CHANNEL.

Using the operations and control panels, starting from the initial panel, complete these fields and press Enter:

Field	Value
Action	2 (Define)
Object type	CHLtype (for example CHLSENDER) or CHANNEL
Name	CHANNEL.TO.DEFINE

You are presented with some panels to complete with information about the attributes you want for the channel you are defining. These panels are shown on page 415.

**Note:** If you entered CHANNEL in the **object type** field, you are presented with the Select a Valid Channel Type panel first.

If you want to define a channel with the same attributes as an existing channel, put the name of the channel you want to copy in the **Like** field on the initial panel. The subsequent panels will already contain these attribute values, but you can change any that you want to before pressing Enter.

## Defining a channel

If you have not used the **Like** field, the panels will contain the system default attribute values. Change any that you want to, and then press Enter to create the channel definition.

For information about the channel attributes, see “Chapter 6. Channel attributes” on page 77.

### Notes:

1. If you are using distributed queuing with CICS as well, don't use any of the same channel names.
2. You are strongly recommended to name all the channels in your network uniquely. As shown in Table 1 on page 30, including the source and target queue manager names in the channel name is a good way to do this.

## Altering a channel definition

To alter a channel definition using the MQSC commands, use ALTER CHANNEL.

Using the operations and control panels, starting from the initial panel, complete these fields and press Enter:

Field	Value
Action	3 (Alter)
Object type	CHLtype (for example CHLSENDER) or CHANNEL
Name	CHANNEL.TO.ALTER

You are presented with some panels containing information about the current attributes of the channel. Change any of the unprotected fields that you want by overtyping the new value, and then press Enter to change the channel definition.

For information about the channel attributes, see “Chapter 6. Channel attributes” on page 77.

## Displaying a channel definition

To display a channel definition using the MQSC commands, use DISPLAY CHANNEL.

Using the operations and control panels, starting from the initial panel, complete these fields and press Enter:

Field	Value
Action	1 (Display)
Object type	CHLtype (for example CHLSENDER) or CHANNEL
Name	CHANNEL.TO.DISPLAY

You are presented with some panels displaying information about the current attributes of the channel.

For information about the channel attributes, see “Chapter 6. Channel attributes” on page 77. For information about channel status, press F11 (Connects). See “Displaying channel status” on page 335 for information about this.

## Displaying information about DQM

### Displaying information about DQM

To display information about the channel initiator using the MQSC commands, use DISPLAY DQM.

Using the operations and control panels, starting from the initial panel, complete these fields and press Enter:

Field	Value
Action	1 (Display)
Object type	SYSTEM
Name	Blank

You are presented with another panel. Select control type 1 on this panel.

**Notes:**

1. Displaying distributed queuing information may take some time if you have lots of channels.
2. Channel status is not available for client-connection channels.

### Deleting a channel definition

To delete a channel definition using the MQSC commands, use DELETE CHANNEL.

Using the operations and control panels, starting from the initial panel, complete these fields and press Enter:

Field	Value
Action	4 (Delete)
Object type	CHLtype (for example CHLSENDER) or CHANNEL
Name	CHANNEL.TO.DELETE

You are presented with some panels containing information about the current attributes of the channel. If required, you can scroll through these panels to verify that you are deleting the correct channel definition. Press Enter to delete the channel definition; you will be asked to confirm that you want to delete the channel definition by pressing Enter again.

**Note:** The channel initiator has to be running before a channel definition can be deleted (except for client-connection channels).

For information about the channel attributes, see “Chapter 6. Channel attributes” on page 77.

## Starting a channel initiator

To start a channel initiator using the MQSC commands, use `START CHINIT`.

Using the operations and control panels, starting from the initial panel, complete these fields and press Enter:

Field	Value
Action	6 (Start)
Object type	SYSTEM
Name	Blank

The Start a System Function panel is displayed:

```

                                Start a System Function
Select function type, complete fields, then press Enter to start system
function.

Function type . . . . . -      1. Channel initiator
                                2. Channel listener for LU 6.2
                                3. Channel listener for TCP

Channel initiator
Parameter module name . . _____
JCL substitution . . . . _____

Listener for LU6.2
LU name . . . . . _____

Listener for TCP
Port number . . . . . 1414

Command ==> _____
F1=Help   F2=Split   F3=Exit   F9=Swap   F10=Messages F12=Cancel

```

Figure 39. Starting a system function

Select function type 1 (channel initiator), and press Enter. The channel initiator parameter module name defaults to `CSQXPARM`. If you want to use a different parameter module, enter the name on the panel.

**Note:** If you are using Interlink TCP, this must be started before you start the channel initiator. If you are using IBM TCP, you can start the channel initiator first but, unless you are using OE sockets, you will need to restart the channel initiator after you have started TCP, in order to establish communication. If you are using LU 6.2, this can be started before or after the channel initiator.



## Starting a channel listener

To start a channel listener using the MQSC commands, use `START LISTENER`.

Using the operations and control panels, starting from the initial panel, complete these fields and press Enter:

Field	Value
Action	6 (Start)
Object type	SYSTEM
Name	Blank

The Start a System Function panel is displayed (see Figure 39 on page 327).

Select function type 2 or 3 (channel listener for LU 6.2 or TCP respectively), complete any other fields required (LU name or port number respectively), and press Enter.

## Stopping a channel listener

To stop a channel listener using the MQSC commands, use `STOP LISTENER`.

Using the operations and control panels, starting from the initial panel, complete these fields and press Enter:

Field	Value
Action	7 (Stop)
Object type	SYSTEM
Name	Blank

The Stop a System Function panel is displayed (see Figure 40 on page 328).

Select control type 2 or 3 (channel listener for LU 6.2 or TCP respectively) and press Enter.

## Starting a channel

### Starting a channel

To start a channel using the MQSC commands, use `START CHANNEL`.

Using the operations and control panels, starting from the initial panel, complete these fields and press Enter:

Field	Value
Action	6 (Start)
Object type	CHLtype (for example CHLSENDER) or CHANNEL
Name	CHANNEL.TO.USE

The Start a Channel panel is displayed:

Start a Channel

Press Enter to confirm that the channel is to be started.

Channel name . . . . . : CHANNEL.TO.USE  
Channel type . . . . . : CHLSENDER  
Description . . . . . : Description of CHANNEL.TO.USE

Command ==> \_\_\_\_\_  
F1=Help      F2=Split      F3=Exit      F9=Swap      F10=Messages      F12=Cancel

*Figure 41. Starting a channel*

Press Enter to start the channel.





## Resetting message sequence numbers

### Resetting message sequence numbers for a channel

To reset channel sequence numbers using the MQSC commands, use RESET CHANNEL.

Using the operations and control panels, starting from the initial panel, complete these fields and press Enter:

Field	Value
Action	5 (Perform)
Object type	CHLtype (for example CHLSENDER) or CHANNEL
Name	CHANNEL.TO.USE

The Perform a Channel Function panel is displayed:

```

                                Perform a Channel Function
Select function type, complete fields, then press Enter.

Function type . . . . . _      1. Reset sequence number
                                2. Ping
                                3. Resolve with commit
                                4. Resolve with backout

Channel name . . . . . : CHANNEL.TO.USE
Channel type . . . . . : CHLSENDER
Description . . . . . : Description of CHANNEL.TO.USE

Reset
  Sequence number . . . . . 1      1 - 999999999

Ping
  Data length . . . . . 16      16 - 32768

Command ==> _____
F1=Help   F2=Split   F3=Exit   F9=Swap   F10=Messages F12=Cancel
```

Figure 43. Resetting channel sequence numbers

The **sequence number** field is initially set to one. Change this if you want, select Function type 1 (reset), and press Enter.

## Resolving in-doubt messages on a channel

To resolve in-doubt messages on a channel using the MQSC commands, use RESOLVE CHANNEL.

Using the operations and control panels, starting from the initial panel, complete these fields and press Enter:

Field	Value
Action	9 (Perform)
Object type	CHLSENDER, CHLSERVER, or CHANNEL
Name	CHANNEL.TO.USE

The Perform a Channel Function panel is displayed:

```

                                Perform a Channel Function
Select function type, complete fields, then press Enter.

Function type . . . . . _      1. Reset sequence number
                                2. Ping
                                3. Resolve with commit
                                4. Resolve with backout

Channel name . . . . . : CHANNEL.TO.USE
Channel type . . . . . : CHLSENDER
Description . . . . . : Description of CHANNEL.TO.USE

Reset
  Sequence number . . . . . 1      1 - 999999999

Ping
  Data length . . . . . 16      16 - 32768

Command ==> _____
F1=Help   F2=Split   F3=Exit   F9=Swap   F10=Messages F12=Cancel
  
```

Figure 44. Resolving in-doubt messages

Select Function type 3 or 4 (resolve with commit or backout), and press Enter. (See “In-doubt channels” on page 69 for more information.)



## Displaying channel status

To display the status of a channel or a set of channels using the MQSC commands, use DISPLAY CHSTATUS.

**Note:** Displaying channel status information may take some time if you have lots of channels.

Using the operations and control panels on the List Channel panel (see Figure 38 on page 323), a summary of the channel status is shown for each channel as follows:

INACTIVE	No connections are active
<i>status</i>	One connection is active
<i>nnn status</i>	More than one connection is current and all current connections have the same status
<i>nnn</i> CURRENT	More than one connection is current and the current connections do not all have the same status
Blank	MQSeries is unable to determine how many connections are active (for example, because the channel initiator is not running)

where *nnn* is the number of active connections, and *status* is one of the following:

INIT	INITIALIZING
BIND	BINDING
START	STARTING
RUN	RUNNING
STOP	STOPPING or STOPPED
RETRY	RETRYING
REQST	REQUESTING

To display more information about the channel status, press the Status key (F11) on the List Channel or the Display, Alter, or Delete channel panels to display the List Channels - Current Status panel (see Figure 46 on page 336).

## Displaying channel status

```

List Channels - Current Status                               Row 1 of 16

Use '/' to select one or more connections, then press Enter to display current
connection status.

Channel name      Connection name      State
Type      Messages  Last message time  Start time      Retry/Stop
- RMA0.CIRCUIT.ACL.F  RMA1                STOP
- CHLSENDER  557735  1997-03-24 09.51.11  1997-03-21 10.22.36
- RMA0.CIRCUIT.ACL.N  RMA1
- CHLSENDER  378675  1997-03-24 09.51.10  1997-03-21 10.23.09
- RMA0.CIRCUIT.CL.F  RMA2
- CHLSENDER  45544   1997-03-24 09.51.08  1997-03-24 01.12.51
- RMA0.CIRCUIT.CL.N  RMA2
- CHLSENDER  45560   1997-03-24 09.51.11  1997-03-24 01.13.55
- RMA1.CIRCUIT.CL.F  RMA1
- CHLRECEIVER 360757  1997-03-24 09.51.11  1997-03-21 10.24.12
- RMA1.CIRCUIT.CL.N  RMA1
- CHLRECEIVER 302870  1997-03-24 09.51.09  1997-03-21 10.23.40
***** End of list *****

Command ==>
F1=Help      F2=Split      F3=Exit      F5=Refresh   F7=Bkwd      F8=Fwd
F9=Swap      F10=Messages  F11=Saved    F12=Cancel

```

Figure 46. Listing channel connections

The values for status are as follows:

INIT	INITIALIZING
BIND	BINDING
START	STARTING
RUN	RUNNING
STOP	STOPPING or STOPPED
RETRY	RETRYING
REQST	REQUESTING
DOUBT	STOPPED and INDOUBT(YES)

See “Channel states” on page 62 for more information about these.

You can press F11 to see a similar list of channel connections with saved status; press F11 to get back to the **current** list.

Use a slash (/) to select a connection and press Enter. Note that the saved status does not apply until at least one batch of messages has been transmitted on the channel. The Display Channel Connection Current Status panels are displayed:

## Displaying channel status

```
Display Channel Connection Current Status

More: +

Channel name . . . . . : CSQ1.TO.CSQ2
Channel type . . . . . : CHLSENDER

Connection name . . . . . : CSQ2
Transmission queue . . . . . : CSQ1.TO.CSQ2.XMITQ

Status . . . . . : RUN
Last sequence number . . . : 6
Last LUW ID . . . . . : F2F6F1F2F2F6F2F8
Indoubt . . . . . : NO
Current messages . . . . . : 0
Current sequence number . . : 6
Current LUW ID . . . . . : F2F6F1F3F3F9F0F1

Command ==>
F1=Help      F2=Split    F3=Exit     F7=Bkwd     F8=Fwd      F9=Swap
F10=Messages F12=Cancel
```

Figure 47. Displaying channel connections - first panel

```
Display Channel Connection Current Status

Press F7 to see previous fields.

More: -

Channel start time . . . . . : 1998-08-10 14.33.26
Last message/call time . . . :
Batches completed . . . . . : 0
Messages/calls . . . . . : 0
Bytes sent . . . . . : 0
Bytes received . . . . . : 0
Transmissions sent . . . . . : 0
Transmissions received . . . : 0
Short retry attempts left . . : 10
Long retry attempts left . . . : 999999999
Stop request outstanding . . . : N Y=Yes,N=No
Maximum message length . . . : 4194304
Batch size . . . . . : 50
Heartbeat interval . . . . . : 300 seconds
Nonpersistent messages . . . : F F=Fast,N=Normal

Command ==>
F1=Help      F2=Split    F3=Exit     F7=Bkwd     F8=Fwd      F9=Swap
F10=Messages F12=Cancel
```

Figure 48. Displaying channel connections - second panel

## Displaying cluster channels

To display all the cluster channels that have been defined (explicitly or using auto-definition), use the MQSC command, DISPLAY CLUSQMGR.

Using the operations and control panels, starting from the initial panel, complete these fields and press Enter:





---

## Chapter 24. Preparing MQSeries for OS/390

This chapter describes the MQSeries for OS/390 preparations you need to make before you can start to use distributed queuing. (If you want to use CICS ISC for distributed queuing, see “Chapter 27. Preparing MQSeries for OS/390 when using CICS” on page 381.) Most of the information here applies equally to MQSeries for MVS/ESA.

To enable distributed queuing, you must perform the following three tasks:

- Customize the distributed queuing facility and define the MQSeries objects required; this is described in the *MQSeries for OS/390 System Management Guide*.
- Define access security; this is described in the *MQSeries for OS/390 System Management Guide*.
- Set up your communications; this is described in this chapter.

---

### Setting up communication

When a distributed-queuing management channel is started, it tries to use the connection specified in the channel definition. For this to succeed, it is necessary for the connection to be defined and available. This section explains how to do this.

There are two forms of communication protocol that can be used:

- TCP
- LU 6.2 through APPC/MVS

#### TCP setup

The TCP address space name must be specified in the TCP system parameters data set, *tcpip.TCPIP.DATA*. In the data set, a “*TCPIPJOBNAME TCP\_IP\_proc*” statement must be included.

The channel initiator address space must have authority to read the data set. The following techniques can be used to access your *TCPIP.DATA* data set, depending on which TCP/IP product and interface you are using:

- Environment variable, *RESOLVER\_CONFIG*
- HFS file, */etc/resolv.conf*
- *//SYSTCPD* DD statement
- *//SYSTCPDD* DD statement
- *jobname/userid.TCPIP.DATA*
- *SYS1.TCPPARMS(TCPDATA)*
- *zapname.TCPIP.DATA*

You must also be careful to specify the high-level qualifier for TCP/IP correctly.

For more information, see the following:

- *TCP/IP OpenEdition: Planning and Release Guide*, SC31-8303
- *OS/390 OpenEdition Planning*, SC28-1890
- Your TCPAccess documentation

## Setting up communication

Each TCP channel when started will use TCP resources; you may need to adjust the following parameters in your PROFILE.TCPIP configuration data set:

### **ACBPOOLSIZE**

Add one per started TCP channel, plus one

### **CCBPOOLSIZE**

Add one per started TCP channel, plus one per DQM dispatcher, plus one

### **DATABUFFERPOOLSIZE**

Add two per started TCP channel, plus one

### **MAXFILEPROC**

Controls how many channels each dispatcher in the channel initiator can handle.

This parameter is specified in the BPXPRMxx member of SYSI.PARMLIB. If you are using OpenEdition sockets, ensure that you specify a value large enough for your needs.

## **Connecting to TCP**

The connection name (CONNNAME) field in the channel definition should be set to either the TCP network address of the target, in dotted decimal form (for example 9.20.9.30) or the host name (for example MVSHUR1). If the connection name is a host name, a TCP name server is required to convert the host name into a TCP host address. (This is a function of TCP, not MQSeries.)

On the initiating end of a connection (sender, requester, and server channel types) it is possible to provide an optional port number for the connection, for example:

### **Connection name**

9.20.9.30(1555)

In this case the initiating end will attempt to connect to a receiving program listening on port 1555.

## **Receiving on TCP**

Receiving channel programs are started in response to a startup request from the sending channel. To do this, a listener program has to be started to detect incoming network requests and start the associated channel. You start this listener program with the START LISTENER command, or using the operations and control panels.

By default, the TCP Listener program uses port 1414.

## **Using the TCP listener backlog option**

When receiving on TCP/IP, a maximum number of outstanding connection requests is set. This can be considered a *backlog* of requests waiting on the TCP/IP port for the listener to accept the request.

The default listener backlog value on OS/390 is 255. If the backlog reaches this value, the TCP/IP connection is rejected and the channel will not be able to start.

For MCA channels, this results in the channel going into a RETRY state and retrying the connection at a later time.

For client connections, the client receives an MQRC\_Q\_MGR\_NOT\_AVAILABLE reason code from MQCONN and should retry the connection at a later time.

However, to avoid this error, you can add an entry in the qm.ini file:

TCP:  
ListenerBacklog = n

This overrides the default maximum number of outstanding requests (255) for the TCP/IP listener.

**Note:** Some operating systems support a larger value than the default. If necessary, this can be used to avoid reaching the connection limit.

To run the listener with the backlog option switched on, use the `RUNMQLSR -B` command. For information about the `RUNMQLSR` command, see the *MQSeries System Administration* book.

### APPC/MVS setup

Each instance of the channel initiator must have the name of the LU that it is to use defined to APPC/MVS, in the APPCPMxx member of SYS1.PARMLIB, as in the following example:

```
LUADD ACBNAME(luname) NOSCHED TPDATA(CSQ.APPCTP)
```

*luname* is the name of the logical unit to be used. NOSCHED is required; TPDATA is not used. No additions are necessary to the ASCHPMxx member, or to the APPC/MVS TP profile data set.

The side information data set must be extended to define the connections used by DQM. See the supplied sample CSQ4SIDE for details of how to do this using the APPC utility program ATBSDFMU. For details of the TPNAME values to use, see the *Multiplatform APPC Configuration Guide* (“Red Book”) and the following table for information:

Table 30. Settings on the local OS/390 system for a remote queue manager platform

Remote platform	TPNAME
OS/390 or MVS/ESA	The same as TPNAME in the corresponding side information on the remote queue manager.
OS/390 or MVS/ESA using CICS	CKRC (sender) CKSV (requester) CKRC (server)
OS/400	The same as the compare value in the routing entry on the OS/400 system.
OS/2	As specified in the OS/2 Run Listener command, or defaulted from the OS/2 queue manager configuration file.
Digital OVMS	As specified in the Digital OVMS Run Listener command.
Tandem NSK	The same as the TPNAME specified in the receiver-channel definition.
Other UNIX systems	The same as TPNAME in the corresponding side information on the remote queue manager.
Windows NT	As specified in the Windows NT Run Listener command, or the invocable Transaction Program that was defined using TpSetup on Windows NT.

If you have more than one queue manager on the same machine, ensure that the TPnames in the channel definitions are unique.

See the *Multiplatform APPC Configuration Guide* also for information about the VTAM definitions that may be required.

## Setting up communication

In an environment where the queue manager is communicating via APPC with a queue manager on the same or another OS/390 system, ensure that either the VTAM definition for the communicating LU specifies SECACPT(ALREADYV), or that there is a RACF® APPCLU profile for the connection between LUs, which specifies CONVSEC(ALREADYV).

The OS/390 command VARY ACTIVE must be issued against both base and listener LUs before attempting to start either inbound or outbound communications.

### Connecting to APPC/MVS (LU 6.2)

The connection name (CONNNAME) field in the channel definition should be set to the symbolic destination name, as specified in the side information data set for APPC/MVS.

The LU name to use (defined to APPC/MVS as described above) must also be specified in the channel initiator parameters. It must be set to the same LU that will be used for receiving by the listener.

The channel initiator uses the “SECURITY(SAME)” APPC/MVS option, so it is the user ID of the channel initiator address space that is used for outbound transmissions, and will be presented to the receiver.

### Receiving on LU 6.2

Receiving MCAs are started in response to a startup request from the sending channel. To do this, a listener program has to be started to detect incoming network requests and start the associated channel. The listener program is an APPC/MVS server. You start it with the START LISTENER command, or using the operations and control panels. You must specify the LU name to use by means of a symbolic destination name defined in the side information data set. The local LU so identified must be the same as that used for outbound transmissions, as set in the channel initiator parameters.

---

## Defining DQM requirements to MQSeries

In order to define your distributed-queuing requirements, you have to:

- Define the channel initiator procedures and data sets
- Define the channel definitions
- Define the queues and other objects
- Define access security

See the *MQSeries for OS/390 System Management Guide* for information about these tasks.

---

## Defining MQSeries objects

Use one of the MQSeries command input methods to define MQSeries objects. Refer to “Chapter 23. Monitoring and controlling channels on OS/390” on page 321 for information about defining objects.

You define:

- A local queue with the usage of XMITQ for each sending message channel.
- Remote queue definitions.

A remote queue object has three distinct uses, depending upon the way the name and content are specified:

- Remote queue definition
- Queue manager alias definition
- Reply-to queue alias definition

This is shown in Table 2 on page 37.

- A process specifying the trigger data for a channel that is triggered by messages appearing on the transmission queue. The transmission queue must name SYSTEM.CHANNEL.INITQ as the initiation queue.
  - The process definition parameter, USERDATA, must contain the name of the channel to be started by this process
  - The application identifier (APPLICID) must be CSQX START
  - The application type (APPLTYPE) must be set to MVS

For example:

```
DEFINE QLOCAL(MYXMITQ) USAGE(XMITQ) TRIGGER(YES) +
    INITQ(SYSTEM.CHANNEL.INITQ) PROCESS(MYPROCESS)
DEFINE PROCESS(MYPROCESS) APPLTYPE(MVS) APPLICID('CSQX START') +
    USERDATA(MYCHANNEL)
DEFINE CHL(MYCHANNEL) CHLTYPE(SDR) TRTYPE(TCP) +
    XMITQ(MYXMITQ) CONNAME('9.20.9.30(1555)')
```

**Note:** The trigger monitor program is actually the channel initiator itself; no separate program needs to be started.

The supplied sample CSQ4INXD gives additional examples of the necessary definitions.

## Synchronization queue

DQM requires a queue for use with sequence numbers and logical units of work identifiers (LUWID). You must ensure that a queue is available with the name SYSTEM.CHANNEL.SYNCQ (see the *MQSeries for OS/390 System Management Guide*).

Make sure that you define this queue using INDXTYPE(MSGID). This will improve the speed at which it can be accessed.

## Channel command queues

You need to ensure that channel command queues exist for your system with the names SYSTEM.CHANNEL.INITQ and SYSTEM.CHANNEL.REPLY.INFO.

If the channel initiator detects a problem with the SYSTEM.CHANNEL.INITQ, it will be unable to continue normally until the problem is corrected. The problem could be one of the following:

- The queue is full
- The queue is not enabled for put
- The page set that the queue is on is full
- The channel initiator does not have the correct security authorization to the queue

## Defining MQSeries objects

If the definition of the queue is changed to GET(DISABLED) while the channel initiator is running, it will not be able to get messages from the queue, and will terminate.

---

## Channel operation considerations

1. Because the channel initiator uses a number of asynchronously operating dispatchers, the order in which operator messages appear on the log may be out of chronological sequence.
2. MCAs for receiver channels may keep the destination queues open even when messages are not being transmitted; this results in the queues appearing to be 'in use'.
3. If you change security access for a user ID, the change may not take effect immediately. See the *MQSeries for OS/390 System Management Guide* for more information.
4. If TCP is stopped for some reason and then restarted, the MQSeries for OS/390 TCP listener waiting on a TCP port is stopped.

If you are using the OpenEdition sockets interface, (for example, if you are using the IUCV interface or the Interlink SNSTCPAccess interface,) the channel initiator must be stopped and manually restarted when TCP returns. Then, the listener must also be manually restarted to resume communications.

If you are using the OpenEdition sockets interface, automatic channel reconnect allows the channel initiator to detect that TCP/IP is not available and to automatically restart the TCP/IP listener when TCP/IP returns. This alleviates the need for operations staff to notice the problem with TCP/IP and manually restart the listener. While the listener is out of action, the channel initiator can also be used to retry the listener at the interval specified by LSTRTMR in the channel initiator parameter module. These attempts can continue until TCP/IP returns and the listener successfully restarts automatically. For information about LSTRTMR, see the *MQSeries for OS/390 System Management Guide*.

5. If APPC is stopped, the listener is also stopped. Again, in this case, the listener automatically retries at the LSTRTMR interval so that, if APPC restarts, the listener can restart too.

---

## OS/390 Automatic Restart Management (ARM)

Automatic restart management (ARM) is an OS/390 recovery function that can improve the availability of specific batch jobs or started tasks (for example, subsystems), and therefore result in a faster resumption of productive work.

To use ARM, you must set up your queue managers and channel initiators in a particular way to make them restart automatically. For information about this, see the *MQSeries for OS/390 System Management Guide*.

## Chapter 25. Message channel planning example for OS/390

This chapter provides a detailed example of how to connect two OS/390 or MVS/ESA queue managers together so that messages can be sent between them. The example illustrates the preparations needed to allow an application using queue manager QM1 to put messages on a queue at queue manager QM2. An application running on QM2 can retrieve these messages, and send responses to a reply queue on QM1.

The example illustrates the use of both TCP/IP and LU 6.2 connections. The example assumes that channels are to be triggered to start when the first message arrives on the transmission queue they are servicing.

### What the example shows

The example shows the MQSeries commands (MQSC) that you can use in MQSeries for OS/390 for DQM.

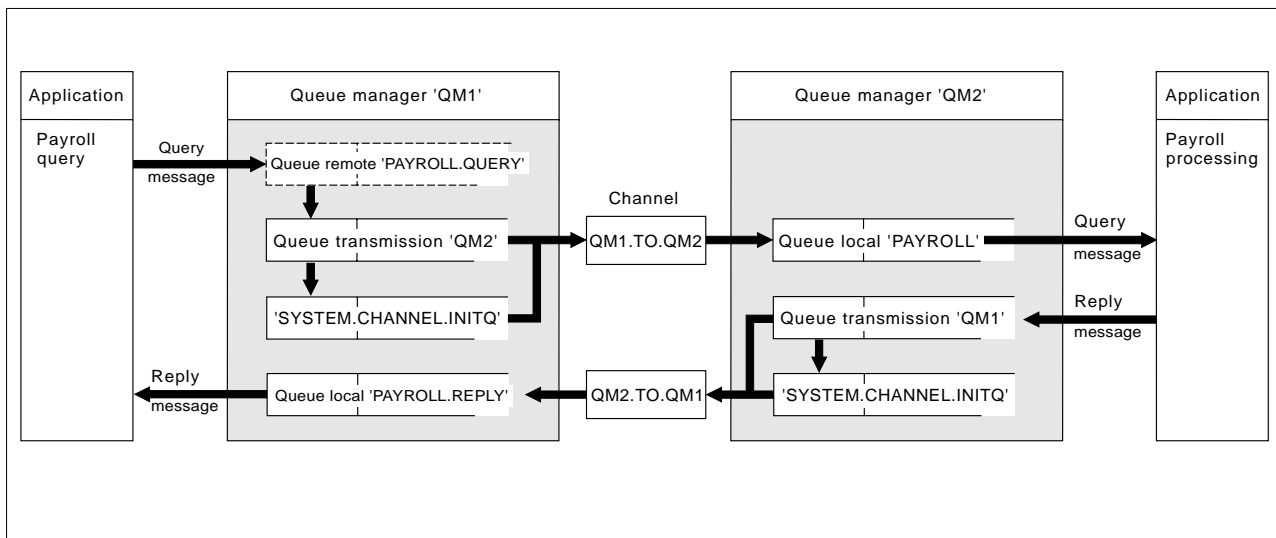

Figure 50. The message channel example for MQSeries for OS/390

It involves a payroll query application connected to queue manager QM1 that sends payroll query messages to a payroll processing application running on queue manager QM2. The payroll query application needs the replies to its queries sent back to QM1. The payroll query messages are sent from QM1 to QM2 on a sender-receiver channel called QM1.TO.QM2, and the reply messages are sent back from QM2 to QM1 on another sender-receiver channel called QM2.TO.QM1. Both of these channels are triggered to start as soon as they have a message to send to the other queue manager.

The payroll query application puts a query message to the remote queue "PAYROLL.QUERY" defined on QM1. This remote queue definition resolves to the local queue "PAYROLL" on QM2. In addition, the payroll query application specifies that the reply to the query is sent to the local queue "PAYROLL.REPLY" on QM1. The payroll processing application gets messages from the local queue



## Planning example for OS/390

“PAYROLL” on QM2, and sends the replies to wherever they are required; in this case, local queue “PAYROLL.REPLY” on QM1.

Both queue managers are assumed to be running on OS/390. In the example definitions for TCP/IP, QM1 has a host address of 9.20.9.31 and is listening on port 1411, and QM2 has a host address of 9.20.9.32 and is listening on port 1412. In the definitions for LU 6.2, QM1 is listening on a symbolic luname called LUNAME1 and QM2 is listening on a symbolic luname called LUNAME2. The example assumes that these are already defined on your OS/390 system and available for use.

The object definitions that need to be created on QM1 are:

- Remote queue definition, PAYROLL.QUERY
- Transmission queue definition, QM2 (default=remote queue manager name)
- Process definition, QM1.TO.QM2.PROCESS
- Sender channel definition, QM1.TO.QM2
- Receiver channel definition, QM2.TO.QM1
- Reply-to queue definition, PAYROLL.REPLY

The object definitions that need to be created on QM2 are:

- Local queue definition, PAYROLL
- Transmission queue definition, QM1 (default=remote queue manager name)
- Process definition, QM2.TO.QM1.PROCESS
- Sender channel definition, QM2.TO.QM1
- Receiver channel definition, QM1.TO.QM2

The example assumes that all the SYSTEM.COMMAND.\* and SYSTEM.CHANNEL.\* queues required to run DQM have been defined as shown in the supplied sample definitions, CSQ4INSG and CSQ4INSX.

The connection details are supplied in the CONNAME attribute of the sender channel definitions.

You can see a diagram of the arrangement in Figure 50 on page 345.

## Queue manager QM1 example

The following object definitions allow applications connected to queue manager QM1 to send request messages to a queue called PAYROLL on QM2, and to receive replies on a queue called PAYROLL.REPLY on QM1.

All the object definitions have been provided with the DESCR and REPLACE attributes. The other attributes supplied are the minimum required to make the example work. The attributes that are not supplied take the default values for queue manager QM1.

Run the following commands on queue manager QM1.

### Remote queue definition

```
DEFINE QREMOTE(PAYROLL.QUERY) DESCR('Remote queue for QM2') REPLACE +  
PUT(ENABLED) XMITQ(QM2) RNAME(PAYROLL) RQMNAME(QM2)
```

**Note:** The remote queue definition is not a physical queue, but a means of directing messages to the transmission queue, QM2, so that they can be sent to queue manager QM2.



**Transmission queue definition**

```
DEFINE QLOCAL(QM2) DESCR('Transmission queue to QM2') REPLACE +
USAGE(XMITQ) PUT(ENABLED) GET(ENABLED) TRIGGER TRIGTYPE(FIRST) +
INITQ(SYSTEM.CHANNEL.INITQ) PROCESS(QM1.TO.QM2.PROCESS)
```

When the first message is put on this transmission queue, a trigger message is sent to the initiation queue, SYSTEM.CHANNEL.INITQ. The channel initiator gets the message from the initiation queue and starts the channel identified in the named process. The channel initiator can only get trigger messages from the SYSTEM.CHANNEL.INITQ queue, so you should not use any other queue as the initiation queue.

**Process definition**

```
DEFINE PROCESS(QM1.TO.QM2.PROCESS) DESCR('Process for starting channel') +
REPLACE APPLTYPE(MVS) APPLICID('CSQX START') USERDATA(QM1.TO.QM2)
```

The channel initiator uses this process information to start channel QM1.TO.QM2.

**Sender channel definition**

For a TCP/IP connection:

```
DEFINE CHANNEL(QM1.TO.QM2) CHLTYPE(SDR) TRPTYPE(TCP) +
REPLACE DESCR('Sender channel to QM2') XMITQ(QM2) +
CONNAME('9.20.9.32(1412)')
```

For an LU 6.2 connection:

```
DEFINE CHANNEL(QM1.TO.QM2) CHLTYPE(SDR) TRPTYPE(LU62) +
REPLACE DESCR('Sender channel to QM2') XMITQ(QM2) +
CONNAME('LUNAME2')
```

**Receiver channel definition**

For a TCP/IP connection:

```
DEFINE CHANNEL(QM2.TO.QM1) CHLTYPE(RCVR) TRPTYPE(TCP) +
REPLACE DESCR('Receiver channel from QM2')
```

For an LU 6.2 connection:

```
DEFINE CHANNEL(QM2.TO.QM1) CHLTYPE(RCVR) TRPTYPE(LU62) +
REPLACE DESCR('Receiver channel from QM2')
```

**Reply-to queue definition**

```
DEFINE QLOCAL(PAYROLL.REPLY) REPLACE PUT(ENABLED) GET(ENABLED) +
DESCR('Reply queue for replies to query messages sent to QM2')
```

The reply-to queue is defined as PUT(ENABLED). This ensures that reply messages can be put to the queue. If the replies cannot be put to the reply-to queue, they are sent to the dead-letter queue on QM1 or, if this queue is not available, remain on transmission queue QM1 on queue manager QM2. The queue has been defined as GET(ENABLED) to allow the reply messages to be retrieved.

**Queue manager QM2 example**

The following object definitions allow applications connected to queue manager QM2 to retrieve request messages from a local queue called PAYROLL, and to put replies to these request messages to a queue called PAYROLL.REPLY on queue manager QM1.

You do not need to provide a remote queue definition to enable the replies to be returned to QM1. The message descriptor of the message retrieved from local queue PAYROLL contains both the reply-to queue and the reply-to queue manager

## Planning example for OS/390

names. Therefore, as long as QM2 can resolve the reply-to queue manager name to that of a transmission queue on queue manager QM2, the reply message can be sent. In this example, the reply-to queue manager name is QM1 and so queue manager QM2 simply requires a transmission queue of the same name.

All the object definitions have been provided with the DESCR and REPLACE attributes and are the minimum required to make the example work. The attributes that are not supplied take the default values for queue manager QM2.

Run the following commands on queue manager QM2.

### Local queue definition

```
DEFINE QLOCAL(PAYROLL) REPLACE PUT(ENABLED) GET(ENABLED) +  
DESCR('Local queue for QM1 payroll details')
```

This queue is defined as PUT(ENABLED) and GET(ENABLED) for the same reason as the reply-to queue definition on queue manager QM1.

### Transmission queue definition

```
DEFINE QLOCAL(QM1) DESCR('Transmission queue to QM1') REPLACE +  
USAGE(XMITQ) PUT(ENABLED) GET(ENABLED) TRIGGER TRIGTYPE(FIRST) +  
INITQ(SYSTEM.CHANNEL.INITQ) PROCESS(QM2.TO.QM1.PROCESS)
```

When the first message is put on this transmission queue, a trigger message is sent to the initiation queue, SYSTEM.CHANNEL.INITQ. The channel initiator gets the message from the initiation queue and starts the channel identified in the named process. The channel initiator can only get trigger messages from SYSTEM.CHANNEL.INITQ so you should not use any other queue as the initiation queue.

### Process definition

```
DEFINE PROCESS(QM2.TO.QM1.PROCESS) DESCR('Process for starting channel') +  
REPLACE APPLTYPE(MVS) APPLICID('CSQX START') USERDATA(QM2.TO.QM1)
```

The channel initiator uses this process information to start channel QM2.TO.QM1.

### Sender channel definition

For a TCP/IP connection:

```
DEFINE CHANNEL(QM2.TO.QM1) CHLTYPE(SDR) TRPTYPE(TCP) +  
REPLACE DESCR('Sender channel to QM1') XMITQ(QM1) +  
CONNNAME('9.20.9.31(1411)')
```

For an LU 6.2 connection:

```
DEFINE CHANNEL(QM2.TO.QM1) CHLTYPE(SDR) TRPTYPE(LU62) +  
REPLACE DESCR('Sender channel to QM1') XMITQ(QM1) +  
CONNNAME('LUNAME1')
```

### Receiver channel definition

For a TCP/IP connection:

```
DEFINE CHANNEL(QM1.TO.QM2) CHLTYPE(RCVR) TRPTYPE(TCP) +  
REPLACE DESCR('Receiver channel from QM1')
```

For an LU 6.2 connection:

```
DEFINE CHANNEL(QM1.TO.QM2) CHLTYPE(RCVR) TRPTYPE(LU62) +  
REPLACE DESCR('Receiver channel from QM1')
```

## Running the example

When you have created the required objects, you must:

- Start the channel initiator for both queue managers
- Start the listener for both queue managers

The applications can then send messages to each other. Because the channels are triggered to start by the arrival of the first message on each transmission queue, you do not need to issue the `START CHANNEL MQSC` command.

For details about starting a channel initiator see “Starting a channel initiator” on page 327, and for details about starting a listener see “Starting a channel listener” on page 329.

## Expanding this example

This example can be expanded by:

- Adding more queue, process, and channel definitions to allow other applications to send messages between the two queue managers.
- Adding user exit programs on the channels to allow for link encryption, security checking, or additional message processing.
- Using queue manager aliases and reply-to queue aliases to understand more about how these can be used in the organization of your queue manager network.

## Planning example for OS/390

---

## Chapter 26. Monitoring and controlling channels in OS/390 with CICS

You monitor and control the channels to remote queue managers from the distributed queue management (DQM) panels. Each OS/390 queue manager has a set of DQM CICS transactions for controlling interconnections to compatible remote queue managers using CICS intersystem communication (ISC) facilities.

---

### The DQM channel control function

The channel control function provides the administration and control of message channels using CICS between MQSeries for OS/390 and compatible systems. See Figure 28 on page 58 for a conceptual picture.

The channel control function consists of CICS panels and programs, a sequence number queue, a channel command queue, and a VSAM file for the channel definitions. The following is a brief description of the components of the channel control function.

- The channel definition file (CDF):
  - Is a VSAM file
  - Is indexed on channel name
  - Holds channel definitions
  - Must be available to the CICS regions in which the channel control program runs, and where the message channel agent (MCA) programs run
- You use channel definition panels to:
  - Create, copy, display, alter, find, and delete channel definitions
  - Start channels, reset channel sequence numbers, stop channels, ping channels, resync channels, and resolve in-doubt messages when links cannot be re-established
  - Display status information about channels

The panels are CICS basic-mapping support maps.

- Sequence numbers and logical unit of work IDs (LUWIDs) are stored in the sequence number queue, SYSTEM.CHANNEL.SEQNO, and are used for channel re-synchronization purposes.
- A channel command queue, SYSTEM.CHANNEL.COMMAND, is used to hold certain commands for channels.
- The programs are a series of CICS transactions, which include transactions for the MCAs. There are different MCAs available for each type of channel. The names are contained in the following table. Other transactions provide channel control, command handling, and trigger monitoring.

Table 31. Program and transaction names

Program name	Channel type	CICS transaction ID
CSQKMSG S	Sender	CKSG
CSQKMSG R	Receiver	CKRC
CSQKMSG Q	Requester	CKRQ
CSQKMSG V	Server	CKSV

## Channel control function

- A transient data queue CKMQ for error messages.

## CICS regions

Figure 51 shows a configuration of two CICS regions, connected to a single queue manager. The regions have multiregion operation (MRO) links to one another, for function shipping of EXEC CICS START commands from the channel control program.

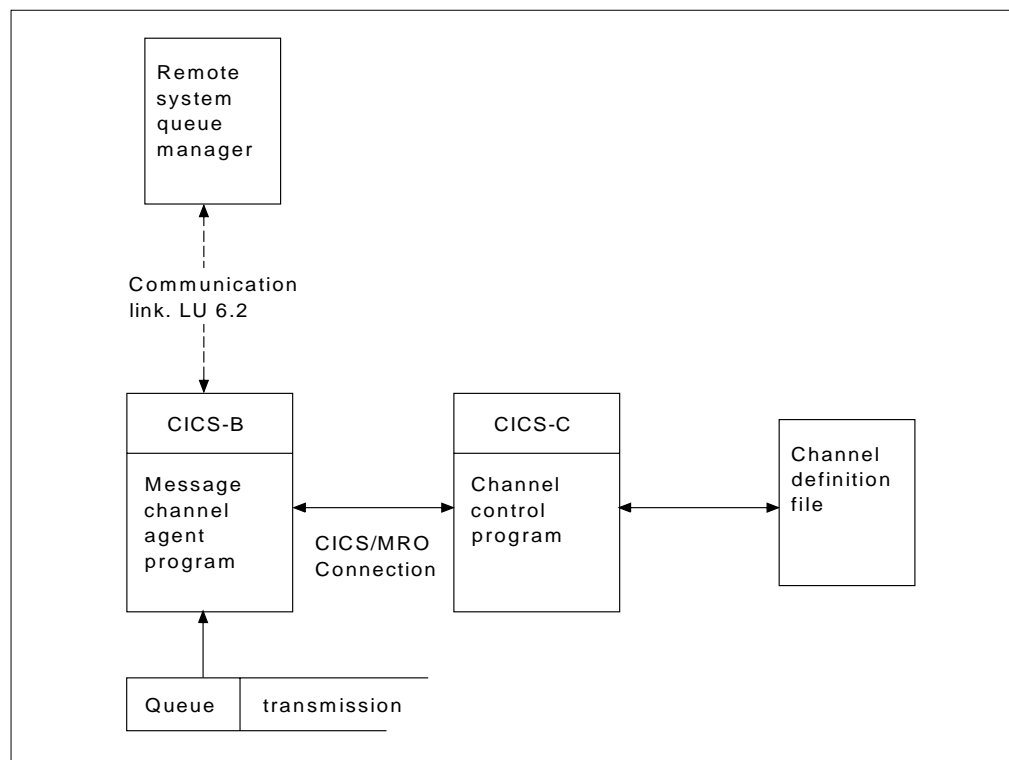

Figure 51. Sample configuration of channel control and MCA. MRO is used for an EXEC CICS START of the MCA, and for an EXEC CICS READ of the channel definition file by the MCA. Communication with the remote queue manager is through CICS ISC, not MRO.

## Starting DQM panels

You invoke DQM panels with the CKMC CICS transaction. On invocation, DQM presents you with the main Message Channel List panel. All activity with the other panels follows from selections made on this panel.

## The Message Channel List panel

The main panel is called the Message Channel List panel; for an example of it, see Figure 52. It has a menu bar with choices you can pull down to reveal the various options you can select for these choices. The work area of the panel is used to present a selection column, and three other columns showing the:

- Full name of each channel
- Type of channel
- CICS system identifier

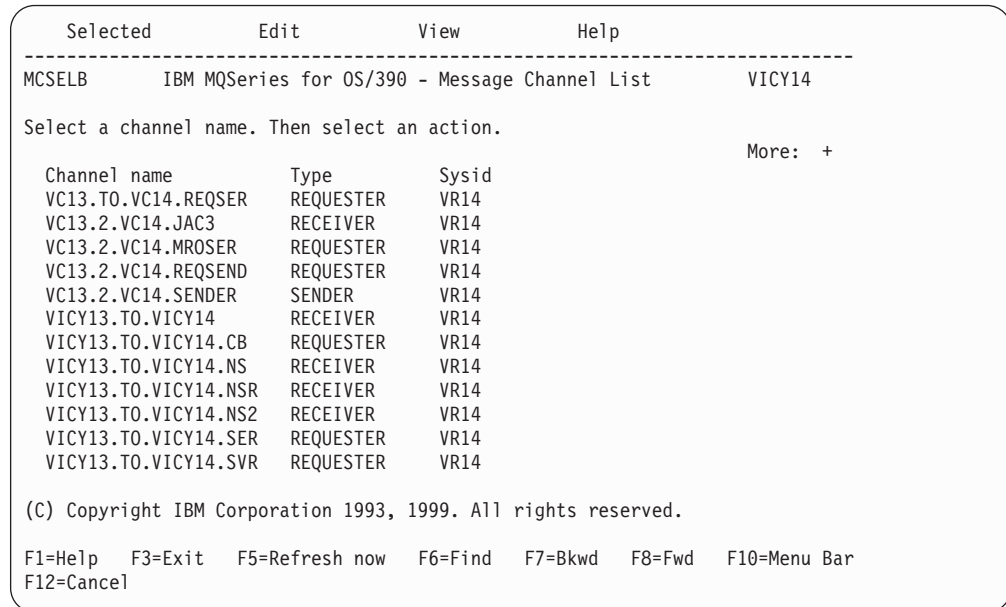

Figure 52. The Message Channel List panel

## Keyboard functions

The following sections describe the function, Enter, and Clear keys, as well as what happens if you press any unassigned keys associated with this panel.

### Function keys

The function keys control the use of the panel. They are listed below, together with their purpose.

- F1 Call help panels
- F3 Exit from the panel and the program
- F5 Refresh the screen fields with current data
- F6 Find a particular channel name
- F7 Scroll the panel backward to display more channels
- F8 Scroll the panel forward to display more channels
- F10 Move the cursor to the menu bar
- F12 Cancel pull-down menus or secondary windows, if any, otherwise as F3

**Note:** Function keys 13 to 24 have the same functions as functions keys 1 to 12, respectively.

## Message Channel List panel

### Enter key

Pressing the Enter key while the cursor is on a menu-bar choice results in the pull-down menu for that choice appearing.

Pressing the Enter key while the cursor is not on a menu-bar choice and a channel selection has been made selects the default option, Display Settings.

Pressing the Enter key while the cursor is not on a menu-bar choice and no channel selection has been made results in the panel being redisplayed.

### Clear key

If you find while typing that what you have typed is not correct, press the Clear key on your terminal to revert all the input fields to their previous state.

For individual fields, use the 'Erase EOF', or 'Ctrl Delete', depending upon the type of terminal you are using.

### Unassigned keys and unavailable choices

If you press a function key, or an attention key that has not been assigned an action, a warning message is displayed that states that the key is invalid.

## Selecting a channel

To select a channel, begin at the Message Channel List panel:

1. Move the cursor to the left of the required channel name.
2. Type a slash (/) character.
3. Press F10 to move the cursor to the menu bar, or press the Enter key to browse the channel settings.

If you try to select more than one channel, only the first one you select is valid.

## Working with channels

When a channel has been selected, function key F10 moves the cursor to the menu bar (see Table 32). The menu-bar choices are:

Table 32. Message Channel List menu-bar choices

Selected	Edit	View	Help
----------	------	------	------

Selecting each of these choices causes its pull-down menu to be displayed (see Figure 53 on page 355).

When you select an option that requires further information, such as a channel name, an action window appears with an entry field for the data.

In general, any incorrect input from the keyboard results in a warning message being issued.



## Message Channel List panel

Selected	Edit	View	Help
1. Start		r OS/390 - Message Channel List	VICY14
2. Stop...			
3. Resync		select an action.	
4. Reset...			More: - +
5. Resolve...	e	Sysid	
6. Display Status	UESTER	VR14	
7. Display Settings	EIVER	VR14	
8. Ping...	UESTER	VR14	
9. Exit	F3	UESTER VR14	
		+DER VR14	

Selected	Edit	View	Help
MCSELB IBM M	1. Copy...		Channel List VICY14
Select a channel n	2. Create...		
Channel name	3. Alter		More: - +
VC13.TO.VC14.SEQ	4. Delete...		
VC13.2.VC14.JAC3	5. Find...	F6	
VC13.2.VC14.MROSER	RECEIVER	VR14	
VC13.2.VC14.REQSEND	REQUESTER	VR14	
VC13.2.VC14.SENDER	SENDER	VR14	

Selected	Edit	View	Help
MCSELB IBM MQSeries for MVS	1. Include all		VICY14
Select a channel name. Then select	2. Include...		
Channel name	3. Refresh now	F5	More: - +
VC13.TO.VC14.SEQSER	REQUESTER	VR14	
VC13.2.VC14.JAC3	RECEIVER	VR14	
VC13.2.VC14.MROSER	REQUESTER	VR14	
VC13.2.VC14.REQSEND	REQUESTER	VR14	
VC13.2.VC14.SENDER	SENDER	VR14	

Selected	Edit	View	Help
MCSELB IBM MQSeries for OS/390 - Message	1. Using help		
Select a channel name. Then select an action.	2. General help		
Channel name	3. Keys help		
VC13.TO.VC14.SEQSER	4. Tutorial		
VC13.2.VC14.JAC3	5. Product Info		
VC13.2.VC14.MROSER	REQUESTER	VR14	
VC13.2.VC14.REQSEND	REQUESTER	VR14	
VC13.2.VC14.SENDER	SENDER	VR14	

Figure 53. The Message Channel List panel pull-down menus

## Message Channel List panel

### Creating a channel

To create a new channel, begin at the Message Channel List panel:

1. Press function key F10 and move the cursor to the **Edit** choice on the menu bar.
2. Press the Enter key to display the Edit pull-down menu, and select the **Create** option.
3. Press the Enter key to display the Create action window.
4. Type the name of the channel in the field provided.
5. Select the channel type for this end of the link.
6. Press the Enter key.

#### Notes:

1. If you are using distributed queuing without CICS as well, don't use any of the same channel names.
2. You are recommended to name all the channels in your network uniquely. As shown in Table 1 on page 30, including the source and target queue manager names in the channel name is a good way to do this.

You are presented with the appropriate Settings panel for the type of channel you have chosen. Fill in the fields with the information you have gathered previously, and select the **Save** option from the Channel pull-down menu.

You are provided with help in deciding on the content of the various fields in the descriptions of the channel definition panels in the following sections of this chapter.

### Altering a channel

To alter an existing channel, begin at the Message Channel List panel:

1. Select a channel.
2. Press function key F10 and move the cursor to the **Edit** choice on the menu bar.
3. Press the Enter key to display the Edit pull-down menu, and select the **Alter** option.

You are presented with the appropriate Settings panel for the channel you have chosen. Alter the fields with the information you have gathered previously, and select the **Save** option from the Channel pull-down menu.

You are provided with help in deciding on the content of the various fields in the descriptions of the channel definition panels in the following sections of this chapter, and in the contextual help panels.

### Browsing a channel

To browse the settings of a channel, begin at the Message Channel List panel:

1. Select a channel.
2. Press the Enter key.

If you try to select more than one channel, only the first one you select is valid.

This results in the respective Settings panel being displayed with details of the current settings for the channel, but with the fields protected against user input.

## Message Channel List panel

If the Channel pull-down menu is selected from the menu bar, the Save option is unavailable and this is indicated by an asterisk (\*) in place of the first letter, as shown in Figure 54.

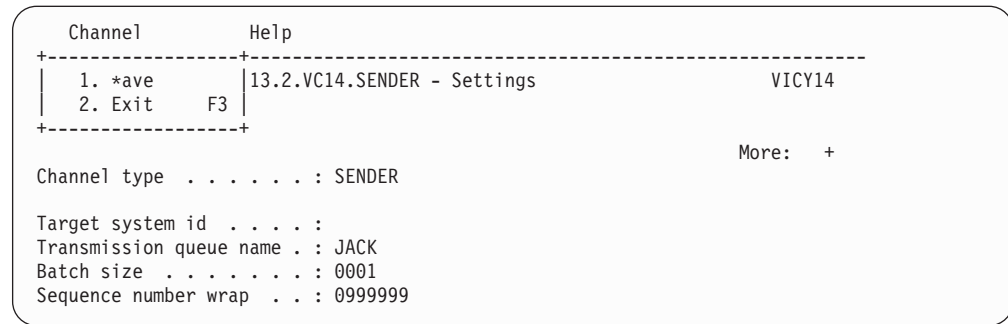

Figure 54. The Channel pull-down menu

## Renaming a channel

To rename a message channel, begin at the Message Channel List panel:

1. Ensure that the channel is inactive.
2. Select the channel.
3. Use **Copy** to create a duplicate with the new name.
4. Use **Delete** to delete the original channel.

If you decide to rename a message channel, ensure that both ends of the channel are renamed at the same time.

## Selected menu-bar choice

The options available in the Selected pull-down menu are:

Menu option	Description
Start	Starts the selected channel.
Stop	Requests the channel to close down, immediately, or controlled.
Resync	Requests the channel to re-synchronize with the remote end, and then close. No messages are sent.
Reset	Requests the channel to reset the sequence numbers on this end of the link. The numbers must be equal at both ends for the channel to start.
Resolve	Requests the channel to resolve in doubt messages without establishing connection to the other end.
Display Status	Displays the current status of the channel.
Display Settings	Displays the current settings for the channel.
Ping	Exchanges a data message with the remote end.
Exit	Exits from the program.

### Start

The **Start** option is available for sender and requester channels, and moreover should not be necessary where a sender channel has been set up with queue manager triggering. For the method of setting up triggering, see “How to trigger channels” on page 358.

## Message Channel List panel

When a server channel has been fully defined as a sender, then the same applies as for sender channels.

When you choose the **Start** option, an EXEC CICS START call is issued to the MCA, which reads the channel definition file and opens the transmission queue. A channel startup sequence is executed which remotely starts the corresponding MCA of the receiver or server channel. When they are running, the sender and server processes await messages arriving on the transmission queue and transmit them as they arrive.

Using the **Start** option always causes re-synchronization where necessary.

For the start to succeed:

- Channel definitions, local and remote must exist.
- The associated transmission queue must exist and it must be enabled for GETs. If sequential numbering is required, then no other process can have the transmission queue open for input.
- CICS transactions, local (and remote if it is OS/390 using CICS) must exist.
- CICS communication must be running.
- The queue managers must be running, local and remote.
- Channel must be inactive.
- Sequence number queue must exist on the receiving system (if it is OS/390 using CICS).

It is not necessary that:

- Messages be available
- Remote queue definitions be used
- Remote destination queues be available

A message is returned to the panel confirming that the request to start a channel has been accepted. For confirmation that the start command has succeeded, check the system console for the CICS system hosting the MCA, or the transient data queue.

The sender, server, and requester channel transactions can be started automatically by CICS, if necessary. This is achieved by arranging for the MCA CICS transaction to be started by the CICS system in the required way. This is similar to the triggering startup in that the MCA is passed the required information in a trigger message. For example, it can be customized to start at a certain time every day, or at regular intervals. When started, it retrieves its channel definition and responds accordingly.

**How to trigger channels:** If triggering is to be used to start a channel when messages arrive on the associated transmission queue, use MQSeries for OS/390 operations and control panels or MQSC commands to set it up in accordance with the details on triggering in the *MQSeries Application Programming Guide*, after having collected all the planning data.

Trigger control is exercised by means of the trigger control parameter in the transmission queue definition. You need to set up the transmission queue for the channel, specifying TRIGGER, define an initiation queue, and define a process. For example:

## Message Channel List panel

```
DEFINE QLOCAL(MYXMITQ) USAGE(XMITQ) TRIGGER INITQ(MYINITQ) +  
      TRIGTYPE(FIRST) PROCESS(MYPROCESS)
```

```
DEFINE QLOCAL(MYINITQ)
```

```
DEFINE PROCESS(MYPROCESS) APPLTYPE(CICS) APPLICID(CKSG) +  
      USERDATA(MYCHANNEL)
```

On the process definition:

### **APPLICID**

Names the application that is to be triggered. If you have a fully defined server channel (see “Message channels” on page 7), this ID should be CKSG rather than CKSV. CKSV should be used only for requester-server channels that are to be initiated only by the requester.

### **APPLTYPE**

Specifies that this is a CICS application.

### **USERDATA**

Specifies the name of the sender channel to be started.

Following the definitions, the long-running trigger process, CKTI, must be started to monitor the initiation queue:

```
CKQC STARTCKTI MYINITQ
```

CKTI waits for trigger messages from the initiation queue, and starts an instance of CKSG for the sender channel in response to the trigger messages. If the channel experiences problems, the trigger control parameter on the transmission queue definition is set to NOTRIGGER by the MCA, and the transmission queue is set to GET(DISABLED). After diagnosis and correction and before you can restart triggering, you must reset the TRIGGER parameter, for example with the MQSeries for OS/390 operations and control panels, and must reset the transmission queue to GET(ENABLED).

### **Stop**

Use the **Stop** option to request the channel to stop activity.

The **Stop** option presents an action window to allow you to confirm your intention to stop the channel, for all four types of channel. For sender and server channels only, you can select the type of stop you require: IMMEDIATE, or QUIESCE. See Figure 55 on page 360 and Figure 56 on page 361.

## Message Channel List panel

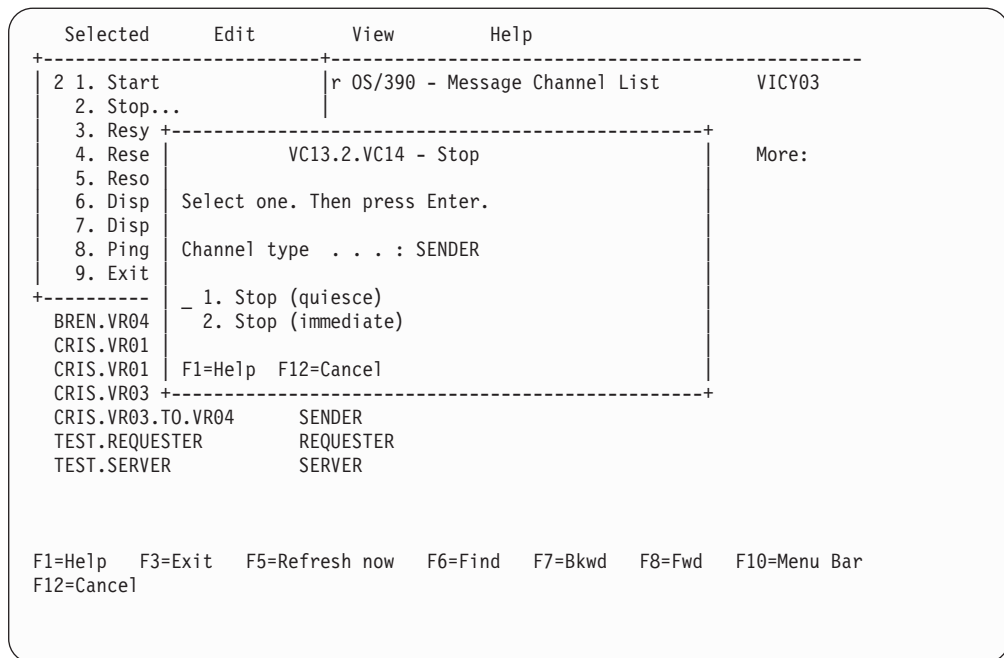

Figure 55. Sender/server Stop action window

**Stop immediate:** This choice forces the channel to close down immediately, if necessary, without completing the current batch of messages, but an attempt is made to syncpoint with the other end of the channel.

Stop immediate is implemented by setting the channel's transmission queue to GET DISABLED. This means that if multiple channels are active against a transmission queue, issuing a stop immediate against one of the channels causes all channels to be stopped. You need to reset this queue to GET ENABLED using the MQSeries for OS/390 operations and control panels or MQSC commands before you attempt to restart the channels.

For more information, see the "Stopping and quiescing channels (not MQSeries for Windows)" on page 67.

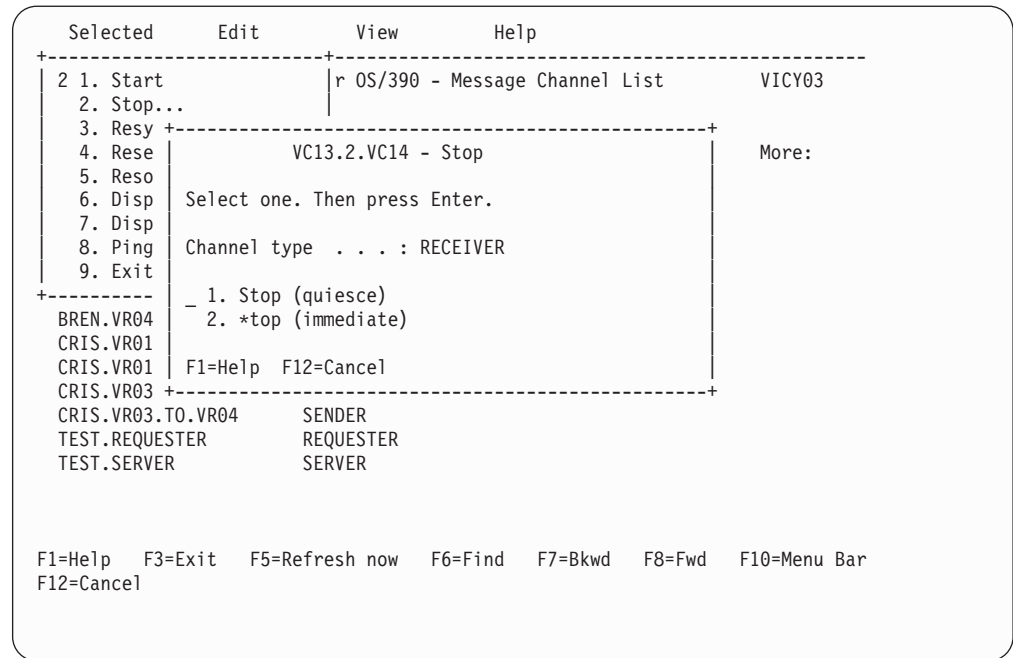

Figure 56. Requester/receiver Stop action window

**Stop quiesce:** This choice requests the channel to close down in an orderly way; the current batch of messages is completed, and the syncpoint procedure is carried out with the other end of the channel.

For more information, see “Stopping and quiescing channels (not MQSeries for Windows)” on page 67. For information about restarting stopped channels, see “Restarting stopped channels” on page 69.

### Resync

A message channel is *synchronized* when there are no in-doubt messages. That is, the sending channel and the receiving channel are agreed on the current unit of work number. The **Resync** option is valid for sender and server channels, but server channels must be fully defined. The option allows the operator to request the channel to re-synchronize with the remote end by resolving any in-doubt messages.

There is no panel associated with this option.

It is to be used only where the channel is currently inactive and in-doubt messages exist. The channel starts up, resolves the in-doubt messages, and then terminates. It is not intended that the channel should send messages after the resolution has been completed.

If the re-synchronization of a channel is not successful, you may need to examine the content of the system sequence number queue, using the **Display Status** option from the Selected pull-down menu on the Message Channel List panel. Compare the sequence numbers, or LUWIDs, at the sending and receiving ends of the channel in order to ascertain what needs to be done to restore synchronization.

It may be necessary to reset sequence numbers, or resolve in-doubt message status, if a channel remains out of synchronization.

## Message Channel List panel

If a channel terminates abnormally, the sender may be left in doubt as to whether the receiver has received and committed one message, or a batch of messages. When the channel is restarted, the channel program automatically re-synchronizes before sending any new messages.

However, there are times when you may want to re-synchronize the in-doubt messages, but not send any new ones. For example:

- You may want to reset sequence numbers before sending the next batch of messages.
- You may want to close out a batch, but hold the remaining messages for later transmission.

The channel program started by this option establishes a session with a partner. It then exchanges the re-synchronization flows. Then, instead of starting new message traffic, it sends a disconnect flow. The result is that the channel terminates normally, without any in-doubt messages. It is ready to be restarted or reset, as required.

For the re-synchronization to succeed:

- Channel definitions, local and remote must exist
- Transmission queue is available and usable
- CICS transactions, local (and remote if using OS/390 with CICS) must exist
- CICS communication must be running
- Queue managers must be running, local and remote
- Sequence number queue must exist on the receiving system (if using OS/390 with CICS)
- The channel must be inactive

A message is returned to the panel indicating whether the request to re-synchronize a channel has succeeded. If the Resync process was not successful, check the system console, or transient data queue (TDQ), for the CICS system hosting the MCA for error messages.

### Reset

Use the **Reset** option to request the channel to reset the sequence number. For a view of the Reset Channel Sequence Number action window, see Figure 57 on page 363. The change must be made separately on each end of the link, with care, and can be done only on inactive channels that have no in-doubt units of work outstanding.

The current sequence number is retrieved and changed to the value requested by the user.

For the reset to succeed:

- The channel sequence number record must exist
- The channel must be inactive
- The channel must not be in doubt
- The channel definition, local, must exist
- CICS transactions, local, must exist
- The CICS system hosting the MCA must be connected to the queue manager

### Notes:

1. To be effective, the sequence number must be reset in both the sender and the receiver channel definitions. The starting sequence number is not negotiated when a channel starts up, nor is there a default provided. Both ends of a channel definition must have the same sequence number value.



## Message Channel List panel

2. In MQSeries for OS/390 using CICS, DQM saves the last sequence number sent, which means that to start the next message with sequence number 100, for example, you need to reset the sequence number to 99.
3. If you delete the channel definition at the partner end of the channel (by deleting and recreating the partner queue manager), you must reset the channel sequence number to 0 at the OS/390 end and to 1 at the partner end.

Selected	Edit	View	Help
4 1. Start		r OS/390 - Message Channel List	VICY14
2. Stop...			
3. Resy			
4. Rese		Reset Channel Sequence Number	More: +
5. Reso			
6. Disp		Type new sequence number. Then press Enter.	
7. Disp			
8. Ping		Channel name . . . : VC13.2.VC14.SENDER	
9. Exit		Channel type . . . : SENDER	
		Sequence number . . . _____	
VC13.2.VC		F1=Help F12=Cancel	
VC13.2.VC			
VC13.2.VC			
/ VC13.2.VC			
VC14.2.VC13	SENDER	VR14	

Figure 57. The Reset Channel Sequence Number action window

### Resolve

Use the **Resolve** option to request a channel to commit or back out in-doubt messages. This may be used when the other end of the link has terminated, and there is no prospect of it returning. Any outstanding units of work need to be resolved with either backout or commit. Backout restores messages to the transmission queue, while Commit discards them.

The **Resolve** option is needed when the **Resync** option is not available, or not effective, and messages are held in doubt by a sender or server. The option accepts one of two parameters: Backout or Commit. See Figure 58 on page 364.

The channel program does not try to establish a session with a partner. Instead, it determines the logical unit of work identifier (LUWID) which represents the in-doubt messages. It then issues, as requested, either:

- Backout to restore the messages to the transmission queue; or
- Commit to delete the messages from the transmission queue

For the resolution to succeed:

- The channel must be inactive
- The channel must be in doubt
- The channel type must be sender or server
- The channel definition, local, must exist
- CICS transactions, local, must exist
- Queue manager must be running, local
- The CICS system hosting the MCA must be connected to the queue manager

See “In-doubt channels” on page 69 for more information.

## Message Channel List panel

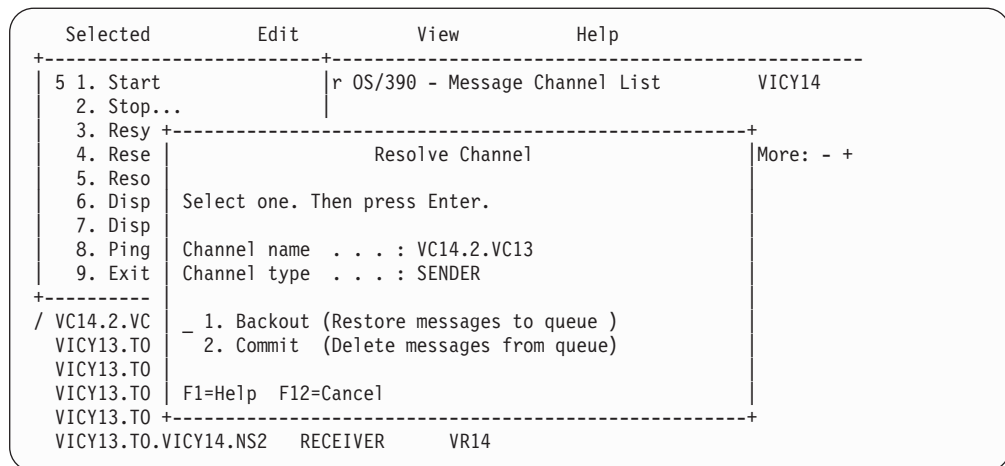

Figure 58. The Resolve Channel action window

### Display status

Use the **Display Status** option to display the current status of the channel. The following information is displayed:

- Whether the channel is active or inactive
- The in-doubt status of sender and server channels
- The sequence number last sent, if sequence numbering is in effect
- The last LUWID number, if available. Available means:
  - Always available for receiver and requester channels
  - Available for sender and server channels when:
    - Sequence numbering is in effect
    - No sequence numbering in effect, but the channel is in doubt

That is, the LUWID number is not available for sender and server channels when sequence numbering is not in effect and the channel is not in doubt

For an example of sender and server status panels, see Figure 59 on page 365, and for an example of receiver and requester status panels, see Figure 60 on page 365.

'Not available' status is acceptable when:

- Shown for a sequence number, if the channel is active
- Shown for an LUWID when the channel is not in doubt

Otherwise, if a 'Not available' status is shown in any of the fields, this indicates that an error has occurred, and you should refer to the console log to find the error messages associated with this problem.

## Message Channel List panel

```

Selected          Edit          View          Help
-----
+-----+-----+-----+-----+
6 1. Start          |r OS/390 - Message Channel List      VICY13
2. Stop...
3. Resy +-----+-----+-----+-----+
4. Rese |          Display Channel Status          | More: - +
5. Reso |
6. Disp | Channel name . . . : VICY13.TO.VICY14
7. Disp | Channel type . . . : SENDER
8. Ping |
9. Exit | Status . . . . . : Inactive
-----+-----+-----+-----+
VICY13.TO | Sequence Number
VICY13.TO | Last sent . . . . : 0001046
VICY13.TO | Last LUWID . . . . : A81D750042ECAD05
VICY13.TO | F1=Help F12=Cancel
VICY13.TO +-----+-----+-----+-----+
VICY13.TO.VICY15      SERVER      VR13

F1=Help F3=Exit F5=Refresh now F6=Find F7=Bkwd F8=Fwd F10=Menu Bar
F12=Cancel

```

Figure 59. An example of a sender channel Display Channel Status window. The server channel Display Channel Status panel looks the same, except that the **Channel type** field is changed to SERVER.

```

Selected          Edit          View          Help
-----
+-----+-----+-----+-----+
6 1. Start          |r OS/390 - Message Channel List      VICY13
2. Stop...
3. Resy +-----+-----+-----+-----+
4. Rese |          Display Channel Status          | More: - +
5. Reso |
6. Disp | Channel name . . . : VC14.2.VC13
7. Disp | Channel type . . . : RECEIVER
8. Ping |
9. Exit | Status . . . . . : Inactive
-----+-----+-----+-----+
VICY13.TO | Sequence Number
VICY13.TO | Last sent . . . . : Not in effect
VICY13.TO | Last LUWID . . . . : A81D750042ECAD05
VICY13.TO | F1=Help F12=Cancel
VICY13.TO +-----+-----+-----+-----+
VICY13.TO.VICY14      REQUESTER      VR13
VICY13.TO.VICY15      SERVER          VR13

F1=Help F3=Exit F5=Refresh now F6=Find F7=Bkwd F8=Fwd F10=Menu Bar
F12=Cancel

```

Figure 60. An example of a receiver channel Display Channel Status window. The requester channel Display Channel Status window looks the same, except that the **Channel type** field is changed to REQUESTER.

### Display settings

Use the **Display Settings** option to display the current definitions for the channel. This choice displays the appropriate panel for the type of channel with the fields displaying the current values of the parameters, and protected against user input:

- Sender: see Figure 71 on page 376
- Receiver: see Figure 73 on page 377

## Message Channel List panel

- Server: see Figure 75 on page 378
- Requester: see Figure 77 on page 379

Protected input is shown with colon characters (:) at the end of field descriptions, and the **Save** option is not available on the Channel pull-down menu.

You can select this choice from the Message Channel List panel by choosing a channel and pressing Enter, without using the menu bar, ensuring that the cursor is not on the menu bar.

### Ping

Use the **Ping** option to exchange a data message with the remote end. This gives you some confidence that the link is available and functioning. It can be issued from sender and server channels only, but server channels must be fully defined.

Ping does not involve the use of transmission queues and target queues. It uses channel definitions, the related CICS communication link, the network setup, and the queue managers at both ends.

The corresponding channel is started at the far side of the link, and performs the startup parameter negotiation.

If an error occurs, an error message is displayed on the panel, and additional messages may be written to the console, or the CICS transient data queue.

The Ping panel offers you the opportunity to enter a message of up to 20 characters to be exchanged across the link. If you do not make use of this, a default message is used.

The result of the message exchange is presented in the Ping panel for you, and this is the returned message text, together with the time the message was sent, and the time the reply was received.

Installations may supply their own applications to exchange particular information, such as system identifiers. Figure 61 shows a view of the Ping action window.

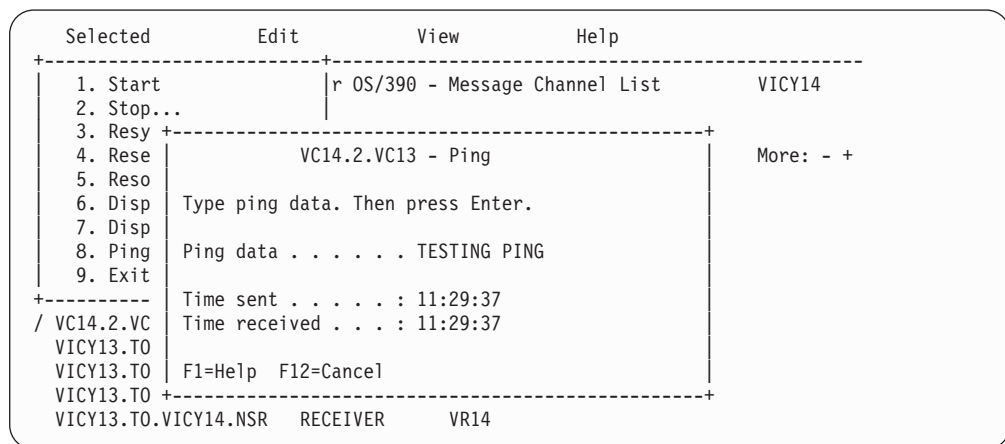

Figure 61. The Ping action window

### Exit

Use the **Exit** option to exit the current function: channel settings, help, or message channel list.

## Message Channel List panel

A secondary window appears when you try to exit a channel settings panel without first saving any changed definitions. This is a safe exit to prevent inadvertent loss of data. The secondary window is shown in Figure 62.

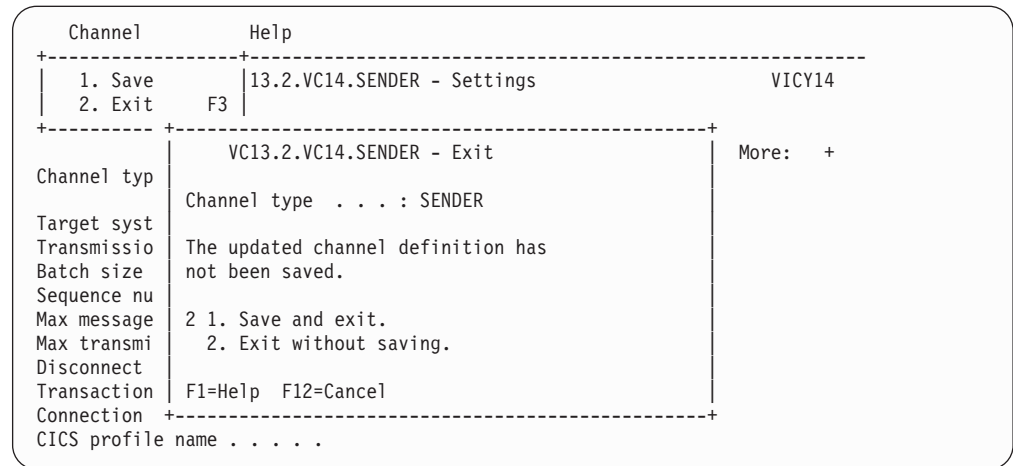

Figure 62. The Exit confirmation secondary window

## Edit menu-bar choice

The options available in the Edit pull-down menu are:

- Copy
- Create
- Alter
- Delete
- Find

In any of the action windows and settings panels associated with Edit, you can type the channel name in uppercase or lowercase, but it may be converted to uppercase when you press the Enter key, depending upon your Typeterm definition.

### Copy

Use the **Copy** option to copy an existing channel. The Copy action window (see Figure 63 on page 368) enables you to define the new channel name. You can use the characters shown in “Create” on page 368 in the name.

Press the Enter key on the Copy action window to display the channel settings panel with details of current system values. You can change any of the new channel settings. You save the new channel definition by selecting **Channel** from the menu bar, and selecting the **Save** option from the pull-down menu.

## Message Channel List panel

Selected	Edit	View	Help
MCSELB	IBM M	1 1. Copy... 2. Create...	Channel List VICY14
Select a ch	VC13.2.VC14.SENDER - Copy		More: - +
Channel n	Type name of new channel. Then press Enter.		
VC13.TO.V			
VC13.2.VC	Channel type . . . : SENDER		
VC13.2.VC			
/ VC13.2.VC	Channel name . . . . _____		
VC14.2.VC			
VICY13.TO	F1=Help F12=Cancel		
VICY13.TO			
VICY13.TO.VICY14.NS	RECEIVER	VR14	

Figure 63. The Copy action window

### Create

Use the **Create** option to create a new channel definition from a screen of fields filled with default values supplied by MQSeries for OS/390. Figure 64 on page 369 shows you where to type the name of the channel, and how to select the type of channel you are creating.

When you press the Enter key, the appropriate channel settings panel is displayed. Type information in all the necessary fields in this panel and then save the definition by selecting **Channel** from the menu bar, and selecting the **Save** option from the pull-down menu.

The channel name must be the same at both ends of the channel, and unique within the network. You can use the following characters in the name:

Uppercase	A-Z
Lowercase	a-z
Numerics	0-9
Period	'.'
Forward slash	'/'
Underscore	'_'
Percentage sign	'%'

## Message Channel List panel

Selected	Edit	View	Help
MCSELB	IBM M	2 1. Copy... 2. Create...	Channel List VICY14
Select a ch +-----+ +-----+ Channel n Create More: - + VC13.TO.V Type name of channel. Select channel type. VC13.2.VC Then press Enter. VC13.2.VC Channel name . . . . _____ / VC13.2.VC Channel type . . . . _ 1. Sender VC14.2.VC 2. Server VICY13.TO 3. Receiver VICY13.TO 4. Requester VICY13.TO F1=Help F12=Cancel VICY13.TO +-----+			

Figure 64. The Create action window

All panels have default values supplied for some fields. You can change the values when you are creating or copying channels. For examples of the channel definition panels showing the default values, see Figure 65.

Press the Enter key on the Create action window to display the channel settings panel with details of default values.

You can create your own set of channel default values by setting up dummy channels with the required defaults for each channel type, and copying them each time you want to create new channel definitions.

Channel	Help
MCATTB1	TEST.CHANNEL - Settings VICY13
More: +	
Channel type . . . . .	SENDER
Target system id . . . . .	_____
Transmission queue name . .	_____
Batch size . . . . .	0001
Sequence number wrap . . .	0999999
Max message size . . . . .	0032000
Max transmission . . . . .	32000
Disconnect interval . . . .	0001
Transaction id . . . . .	CKSG
Connection name . . . . .	_____
CICS profile name . . . . .	_____
LU 6.2 TP name . . . . .	_____
F1=Help F3=Exit F5=Refresh now F7=Bkwd F8=Fwd F10=Menu Bar F12=Cancel	

Figure 65. Example of default values during Create for a channel. The values supplied cannot be customized.

## Message Channel List panel

### Alter

Use the **Alter** option to change an existing channel definition, except for the channel name. Simply type over the fields to be changed in the channel definition panel, and then save the updated definition by selecting **Channel** from the menu bar, and selecting the **Save** option from the pull-down menu.

### Delete

Use the **Delete** option to delete the selected channel. For the secondary window requesting confirmation of your intention, see Figure 66.

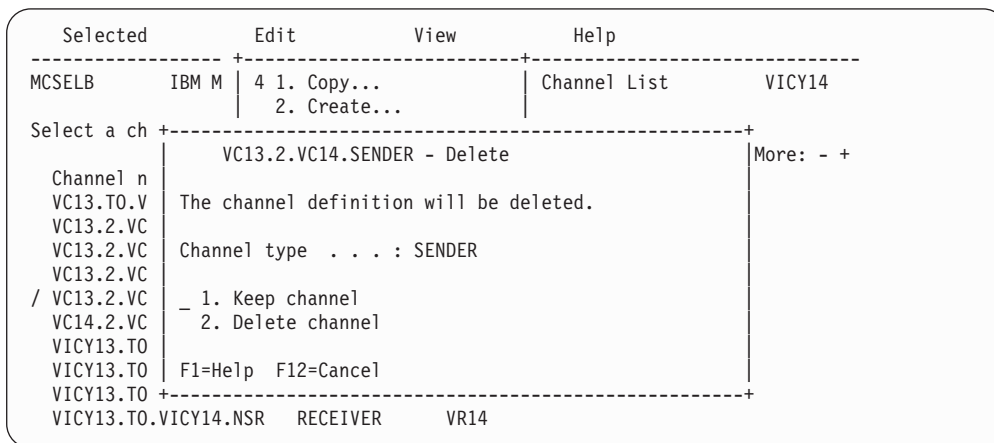

Figure 66. The Delete action window

### Find

Use the **Find** option to locate a particular channel name from the list of available channels. If the name of the channel you want is found, it is placed at the top of the list on the Message Channel List panel. The Find a Channel action window is shown in Figure 67.

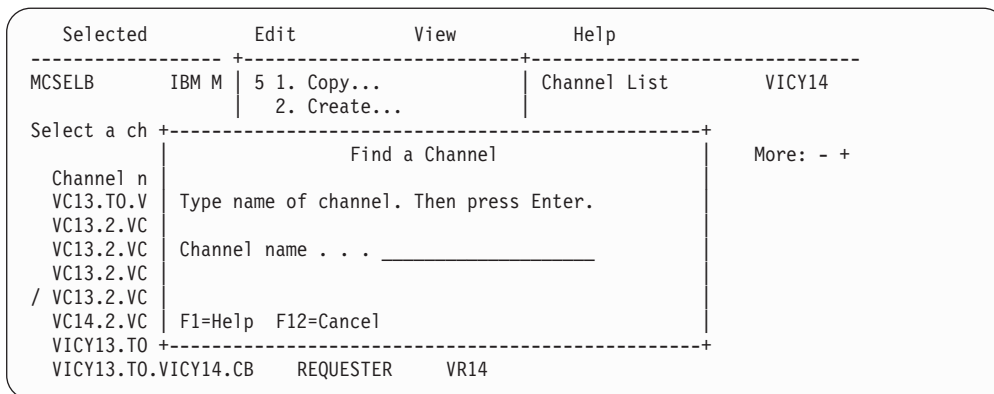

Figure 67. The Find a Channel action window

You can partially define the channel name using a terminating asterisk, for example, `channel.lon*`. This results in the first channel name to be found with these initial letters being placed at the top of the list.



## View menu-bar choice

The options available in the View pull-down menu change the current view of the list shown on the Message Channel List panel; see Figure 68.

### Menu option Description

#### Include all

All channels are included in the list.

#### Include...

Select the channels to be included in the list, by means of an action window.

You can partially define the channel name using a terminating asterisk, for example, channel.lon\*. This results in channel names found with these initial letters being included in the list.

Also in the action window is a field to allow you to specify a channel type, or all types of channel.

#### Refresh now F5

Updates the panel with fresh data from the system.

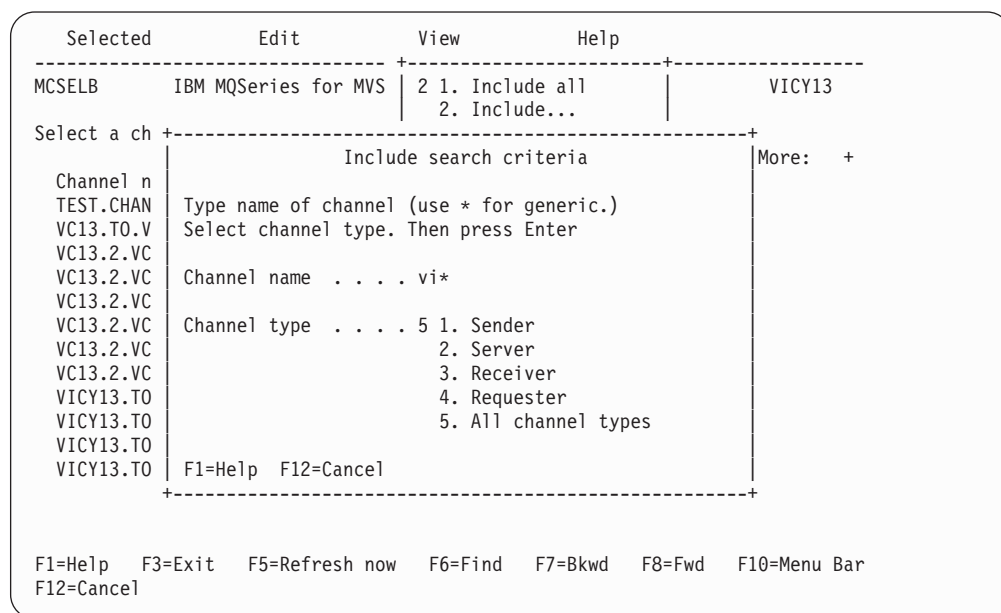

Figure 68. The Include search criteria action window

## Message Channel List panel

### Help menu-bar choice

The Help pull-down menu is shown in Figure 69.

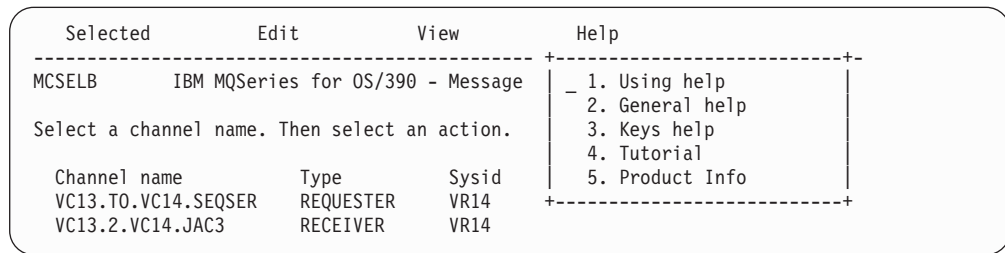

Figure 69. The Help pull-down menu

## The channel definition panels

The four channel Settings panels for defining channels (one for each of sender, receiver, server, and requester) have a menu bar with choices you can pull down to reveal various options you can select for these choices. See Table 33.

The menu-bar choices are:

Table 33. Menu-bar choices on channel panels

Channel	Help
---------	------

The work area of the panels is used to present the fields of attributes or settings for the channel.

The function keys control the use of the panels to:

- Call help panels
- Move the cursor to the menu bar
- Refresh the panel
- Cancel a pull-down menu or a secondary window
- Exit from the panel
- Scroll forward and backward through settings

The method of using the panels is:

- For new channels, fill in the data fields, then select **Channel** from the menu bar, and select the **Save** option from the pull-down menu.

**Note:** Default values supplied by MQSeries for OS/390 are presented in some fields. The defaults cannot be changed, but the values presented can be changed.

- For existing channels, type over the data presented in the fields with new data. Then select **Channel** from the menu bar, and select the **Save** option from the pull-down menu.

## Channel menu-bar choice

The **Channel** menu-bar choice enables you to save any changes you have made to channel definitions, and to return to the Message Channel List panel.

### Saving changes

If there are no errors, selecting the **Save** option from the Channel pull-down menu saves any changes you have made to channel definitions. You are returned to the Message Channel List panel.

If there are errors, you are returned to the Settings panel with an error message, and all fields containing errors are highlighted. The cursor is positioned on the first field in error. The changes are not saved.

### Exit from the panel

Selecting the **Save** option from the Channel pull-down menu saves the changes you have made and returns you to the Message Channel List panel.

Selecting the **Exit** option from the Channel pull-down menu, or pressing F3 or F12, returns you to the Message Channel List panel.

However, if you have not saved the changes you made, a secondary window requesting confirmation of your intention to exit without saving the data is presented; see Figure 62 on page 367. If you want to save the changes you have made, select **Save and exit**. If you have had second thoughts about the changes you have made, select **Exit without saving**.

## Help menu-bar choice

The Help pull-down menu is shown in Figure 70.

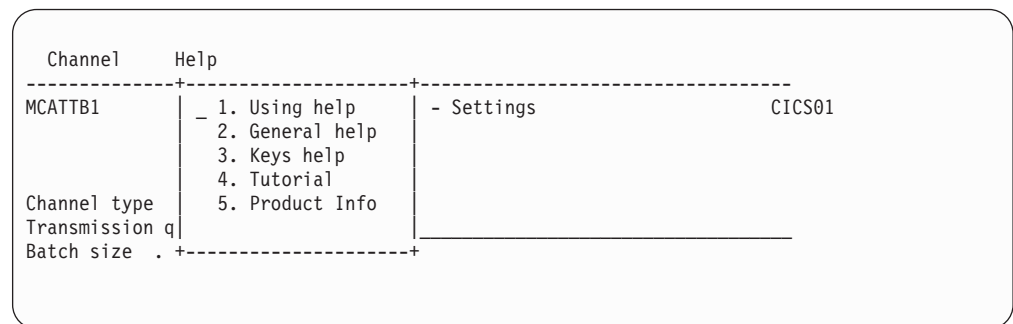

Figure 70. The Help choice pull-down menu

## Channel settings panel fields

The fields in these panels define the attributes of the channels. The channel settings panel fields that you can change are shown in Table 34. You can find details for each field in “Chapter 6. Channel attributes” on page 77.

A “✓” signifies that the field is available for use with the indicated type of channel, while an “O” means that these fields are only needed for server channels when they are to be used as sender channels.

Table 34. Channel attribute fields per channel type

Attribute field	Sender	Server	Receiver	Requester
Batch size	✓	✓	✓	✓
CICS profile name	✓	O		✓
Connection name	✓	O		✓
Disconnect interval	✓	✓		
LU62 TP name (see Note)	✓	O		✓
Maximum message size	✓	✓	✓	✓
Maximum transmission size	✓	✓	✓	✓
Message exit	✓	✓	✓	✓
PUT authority			✓	✓
Retry count	✓	O		✓
Retry fast interval	✓	O		✓
Retry slow interval	✓	O		✓
Receive exit	✓	✓	✓	✓
Sequence number wrap	✓	✓	✓	✓
Sequential delivery	✓	✓	✓	✓
Security exit	✓	✓	✓	✓
Send exit	✓	✓	✓	✓
Target system identifier	✓	✓	✓	✓
Transmission queue name	✓	✓		
Transaction identifier	✓	O		✓
<b>Note:</b> See also the <i>Multiplatform APPC Configuration Guide</i> (“Red Book”) and Table 35 for information.				

Table 35. Settings for LU 6.2 TP name on the local OS/390 system for a remote queue manager platform

Remote platform	Sender/server	Requester
OS/390 using CICS	CKRC	CKSV <sup>1</sup>
OS/390 without CICS and UNIX systems	As specified in the side information on remote queue manager system	As specified in the side information on remote queue manager system
OS/2	As specified in the OS/2 Run Listener command, or defaulted from the OS/2 queue manager configuration file	As specified in the OS/2 Run Listener command, or defaulted from the OS/2 queue manager configuration file

## Channel settings panel fields

Table 35. Settings for LU 6.2 TP name on the local OS/390 system for a remote queue manager platform (continued)

Remote platform	Sender/server	Requester
OS/400	The same as the compare value in the routing entry on the OS/400 system	The same as the compare value in the routing entry on the OS/400 system
Digital OVMS	As specified in the Digital OVMS Run Listener command	As specified in the Digital OVMS Run Listener command
Tandem NSK	The same as the TPNAME specified in the receiver-channel definition	The same as the TPNAME specified in the receiver-channel definition
Windows NT	As specified in the Windows NT Run Listener command, or the invocable Transaction Program that was defined using TpSetup on Windows NT	As specified in the Windows NT Run Listener command, or the invocable Transaction Program that was defined using TpSetup on Windows NT
<b>Note:</b> <sup>1</sup> If you have a fully defined server channel, (see “Message channels” on page 7), its definition should specify a transaction ID of CKSG.		

If you have more than one queue manager on the same machine, ensure that the TPnames in the channel definitions are unique. To modify a TPname, use CSQ4SIDE or CKMC.

## Channel settings panel fields

### Details of sender channel settings panel

This section provides details of the sender channel settings panel, as shown in Figures 71 and 72.

Channel	Help
MCATTB1	HURSLEY.TO.SYDNEY - Settings
	VIC14
	More: +
Channel type . . . . .	: SENDER
Target system id . . . . .	:
Transmission queue name . . . . .	: TX1
Batch size . . . . .	: 0001
Sequence number wrap . . . . .	: 0999999
Max message size . . . . .	: 0032000
Max transmission . . . . .	: 32000
Disconnect interval . . . . .	: 0001
Transaction id . . . . .	: CKSG
Connection name . . . . .	: HtoH
CICS profile name . . . . .	:
LU 6.2 TP name . . . . .	: CKRC
F1=Help F3=Exit F5=Refresh now F7=Bkwd F8=Fwd F10=Menu Bar	
F12=Cancel	

Figure 71. The sender channel settings panel

Channel	Help
MCATTC1	HURSLEY.TO.SYDNEY - Settings
	VIC14
	More: -
Channel type . . . . .	: SENDER
Sequential delivery . . . . .	: 0 (0=No or 1=Yes)
Retry	
Count . . . . .	: 005
Fast interval . . . . .	: 005
Slow interval . . . . .	: 030
Exit routines	
Security . . . . .	:
Message . . . . .	:
Send . . . . .	:
Receive . . . . .	:
F1=Help F3=Exit F5=Refresh now F7=Bkwd F8=Fwd F10=Menu Bar	
F12=Cancel	

Figure 72. The sender channel settings panel - screen 2

## Details of receiver channel settings panel

This section provides details of the receiver channel settings panels, as shown in Figures 73 and 74.

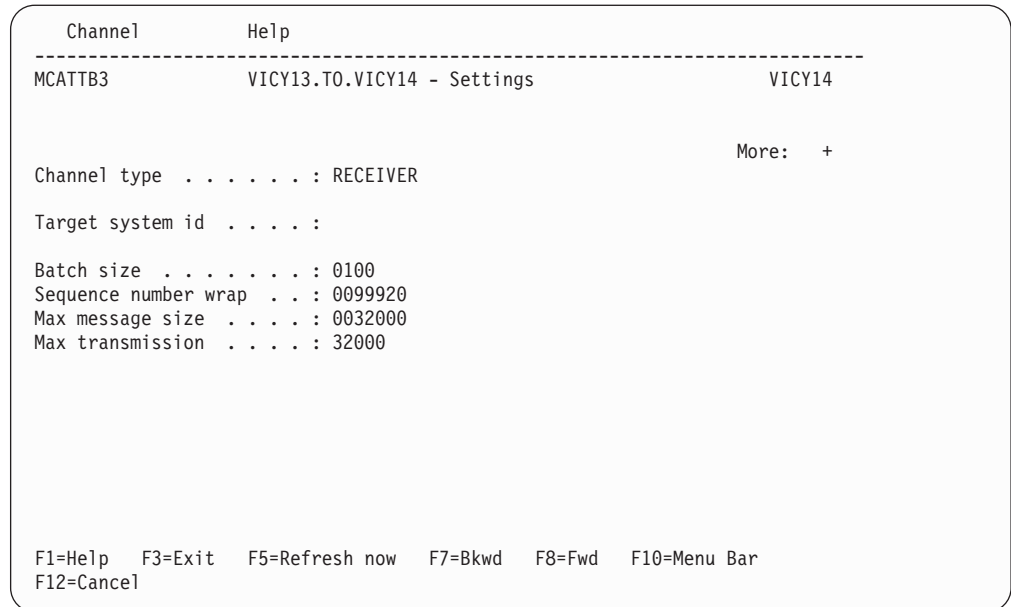

Figure 73. The receiver channel settings panel

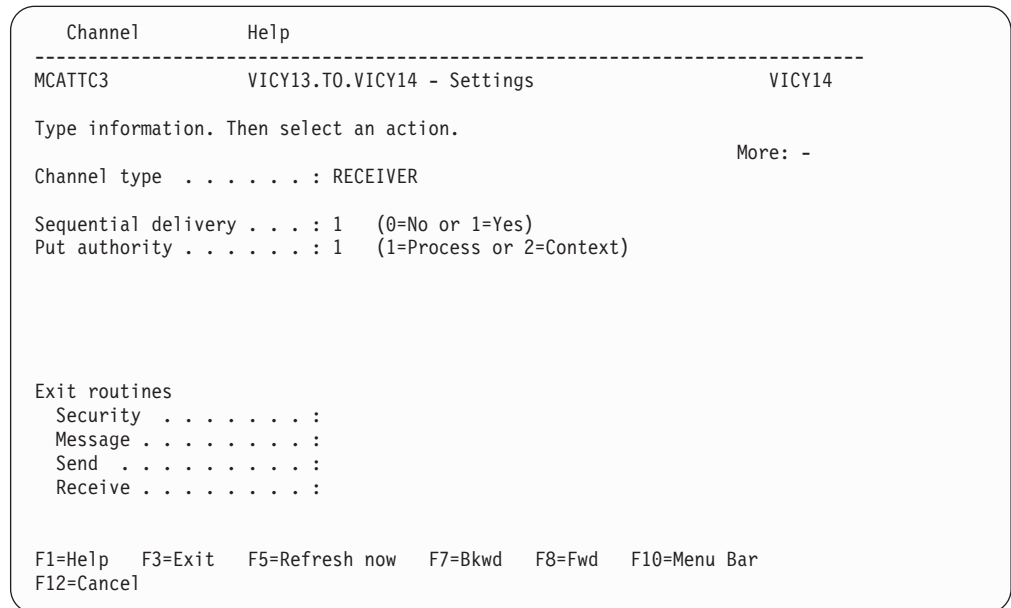

Figure 74. The receiver channel settings panel - screen 2

## Channel settings panel fields

### Details of server channel settings panel

This section provides details of the server channel settings panels, as shown in Figures 75 and 76.

Channel	Help	
MCATTB1	HURSLEY.TO.SYDNEY - Settings	VICY14
		More: +
Channel type . . . . .	: SERVER	
Target system id . . . . .	:	
Transmission queue name . . . . .	: TX1	
Batch size . . . . .	: 0001	
Sequence number wrap . . . . .	: 0999999	
Max message size . . . . .	: 0032000	
Max transmission . . . . .	: 32000	
Disconnect interval . . . . .	: 0001	
Transaction id . . . . .	:	
Connection name . . . . .	:	
CICS profile name . . . . .	:	
LU 6.2 TP name . . . . .	:	
F1=Help F3=Exit F5=Refresh now F7=Bkwd F8=Fwd F10=Menu Bar F12=Cancel		

Figure 75. The server channel settings panel

Channel	Help	
MCATTC1	HURSLEY.TO.SYDNEY - Settings	VICY14
		More: -
Channel type . . . . .	: SERVER	
Sequential delivery . . . . .	: 0 (0=No or 1=Yes)	
Retry		
Count . . . . .	: 005	
Fast interval . . . . .	: 005	
Slow interval . . . . .	: 030	
Exit routines		
Security . . . . .	:	
Message . . . . .	:	
Send . . . . .	:	
Receive . . . . .	:	
F1=Help F3=Exit F5=Refresh now F7=Bkwd F8=Fwd F10=Menu Bar F12=Cancel		

Figure 76. The server channel settings panel - screen 2



## Details of requester channel settings panel

This section provides details of each field in the requester channel settings panels, as shown in Figures 77 and 78.

Channel	Help
MCATTB4	VICY13.TO.VICY14.CB - Settings <span style="float: right;">VICY14</span>
More: +	
Channel type . . . . .	: REQUESTER
Target system id . . . . .	:
Batch size . . . . .	: 0001
Sequence number wrap . . . . .	: 0999999
Max message size . . . . .	: 0032000
Max transmission . . . . .	: 32000
Transaction id . . . . .	: CKRQ
Connection name . . . . .	: VC13
CICS profile name . . . . .	: LU6PROF
LU 6.2 TP name . . . . .	: CKSV
F1=Help F3=Exit F5=Refresh now F7=Bkwd F8=Fwd F10=Menu Bar F12=Cancel	

Figure 77. The requester channel settings panel

Channel	Help
MCATT4	VICY13.TO.VICY14.CB - Settings <span style="float: right;">VICY14</span>
More: -	
Channel type . . . . .	: REQUESTER
Sequential delivery . . . . .	: 0 (0=No or 1=Yes)
Put authority . . . . .	: 1 (1=Process or 2=Context)
Retry	
Count . . . . .	: 005
Fast interval . . . . .	: 005
Slow interval . . . . .	: 030
Exit routines	
Security . . . . .	:
Message . . . . .	:
Send . . . . .	:
Receive . . . . .	:
F1=Help F3=Exit F5=Refresh now F7=Bkwd F8=Fwd F10=Menu Bar F12=Cancel	

Figure 78. The requester channel settings panel - screen 2

## Channel settings panel fields

---

## Chapter 27. Preparing MQSeries for OS/390 when using CICS

This chapter describes the MQSeries for OS/390 and CICS preparations you need to make before you can start to use CICS for distributed queuing.

To enable distributed queuing, you must perform the following three tasks:

- Customize the distributed queuing facility and define the MQSeries objects required; this is described in the *MQSeries for OS/390 System Management Guide*.
- Define access security; this is described in the *MQSeries for OS/390 System Management Guide*.
- Set up your communications; this is described in this chapter.

---

### Setting up CICS communication for MQSeries for OS/390

Distributed queue management (DQM) provides channel control programs which form the interface to CICS communication links, controllable by the system operator. The channel definitions held by DQM use these CICS connections.

When a channel is started, it tries to use the CICS connection specified in the channel definition. For this to succeed, it is necessary for the CICS connection to be defined and available. This section explains how to do this.

If more than one CICS system is associated with any one MQSeries for OS/390, and each CICS system is running some DQM functions, you need to define connections between the CICS systems. This chapter also explains how to do this.

### Connecting CICS systems

Part of the installation of DQM requires the definition and installation of CICS logical unit type 6.2 (LU 6.2) connections that provide the physical link between the CICS systems serving the local queue manager, and the systems serving the remote queue managers. To set up these connections, use the *CICS Intercommunication Guide*.

One OS/390 system can be host to a number of CICS systems at the same time, and each CICS system is able to connect to one queue manager at any one time.

You provide communication links so that queue managers may use these links, through CICS intersystem communication (ISC) to reach other queue managers on OS/390 systems (using CICS or not), and on other non-OS/390 systems, provided they are using the standard queue manager intercommunication protocol, MQSeries Message Channel Protocol.

### Communication between queue managers

There are two forms of communication between CICS systems:

- Intersystem communication (ISC): communication between a CICS system and other systems in a data communication network that support the logical unit type 6.1 or logical unit type 6.2 protocols of IBM Systems Network Architecture (SNA).
- Multiregion operation (MRO): communication between CICS systems running in different address spaces of the same OS/390 system.

## CICS communication

Only ISC LU 6.2 protocols are used for connecting two queue managers over a DQM channel, even where they both reside in the same OS/390 system.

**Note:** CICS for MVS/ESA Version 4 Release 1.0 or higher is required for MQSeries distributed queue management.

### Intersystem communication

The connection type must be ISC LU 6.2, but can be defined as one of the following:

- LU 6.2 single-session terminal
- LU 6.2 single-session connection
- LU 6.2 parallel-session connection

Before deciding the type of connection to be defined, you should consider the following points:

- The number of channels to be defined between the two systems
- The maximum number of channels that are to be active at any one time
- How often the connection is used
- The number of channels per transmission queue
- The number of channels that can be active per connection

**Note:** Multiple channels can be active on the same connection.

To define an LU 6.2 link between the two CICS systems, you should refer to the following books:

- *CICS Intercommunication Guide*, SC33-1695.
- *CICS Resource Definition Guide*, SC33-1684.

paying particular attention to the sections discussing communication resources.

## Defining an LU 6.2 connection

When you decide which type of LU 6.2 connection is to be established between the local and remote CICS systems, the process of definition can take place.

Only one ISC connection can be active between any two CICS systems at the same time. However, a single CICS system can have connections to multiple remote CICS systems at the same time.

The sender and requester channel definitions require the provision of the LU 6.2 connection name and, optionally, the CICS profile name to be used.

The relationship between CICS profiles and connections is shown in Figure 79 . The uppercase fields are the names of the CEDA transaction entry, and the lowercase values are fields within those definitions that are relevant to the example.

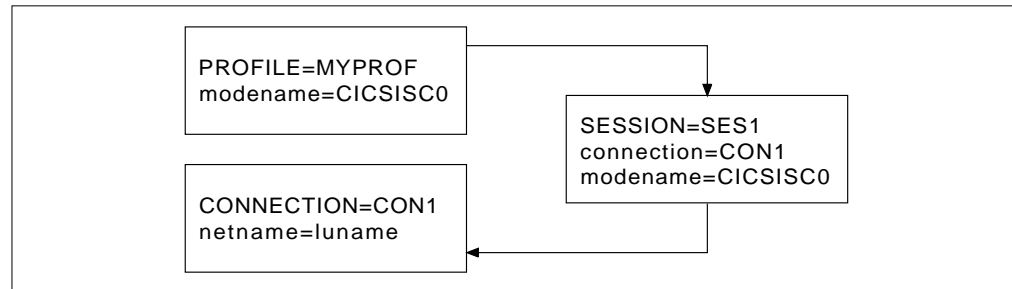

Figure 79. CICS LU 6.2 connection definition

If a sender channel is defined with the following characteristics, it causes a session to be allocated using a SES1 session on connection CON1:

- CHANNEL=MY.CHANNEL
- CONNECTION NAME=CON1
- CICS PROFILE NAME=MYPROF

If no CICS profile name is specified in the channel definition, DQM does not specify a profile when allocating a session.

## Installing the connection

When you have defined the connection definitions on your CICS system definitions (CSDs), these can be installed using the CICS CEDA INSTALL command.

If you want to install these connections as part of the CICS initialization process, you can add the group that contains the connection definitions to the CICS startup list that is specified in the GRPLIST= parameter. You then need to cold start your CICS system for the entries to become effective.

## Communications between CICS systems attached to one queue manager

DQM functions may be shared between more than one CICS system. When these CICS systems are connected to, or associated with, the same queue manager, then these CICS systems need to be set up correctly so that function shipping of EXEC CICS commands and program invocation occur correctly.

### Connection names for function shipping

Although CICS does not require that a connection name is the same as the DFHSIT SYSIDNT name of the target CICS system, DQM requires that they are the same.

The type of connection can be either MRO or ISC.

### Defining DQM requirements to MQSeries

In order to define your distributed-queuing requirements, you need to:

- Define MQSeries programs and data sets as CICS resources
- Define the channel definitions
- Define the CKMQ transient data queue
- Define MQSeries queues triggers and processes
- Define CICS resources used by distributed queuing
- Define access security

See the *MQSeries for OS/390 System Management Guide* for information about these tasks.

---

### Defining MQSeries objects

Use the MQSeries for OS/390 operations and control panels, or one of the other MQSeries for OS/390 command input methods, to define MQSeries for OS/390 objects. Refer to the *MQSeries Command Reference* book for details of defining objects.

You define:

- A local queue with the usage of (XMITQ) for each sending message channel.
- Remote queue definitions.

A remote queue object has three distinct uses, depending upon the way the name and content are specified:

- Remote queue definition
- Queue manager alias definition
- Reply-to queue alias definition

This is shown in Table 2 on page 37.

- A process naming the MCA sender transaction, CKSG, as the application to be triggered by messages appearing on the transmission queue. The process definition parameter, USERDATA, must contain the name of the channel to be started by this process. See “How to trigger channels” on page 358.

The supplied sample CSQ4DISQ gives examples of the necessary definitions.

### Multiple message channels per transmission queue

It is possible to define more than one channel per transmission queue, but only one of these channels needs to be active at any one time. The provision of multiple channels is recommended to provide alternative routes between queue managers for traffic balancing and link failure recovery.

You may start more than one channel to serve a transmission queue to increase message throughput, but when doing so, ensure that the queue has a SHARE attribute, and that there is not a need for sequential delivery of messages.

---

## Channel operation considerations

Channels are designed to be active only when there is work for them to process. This mechanism allows for conservation of limited system resources such as active transactions and LU 6.2 sessions while at the same time delivering messages in a timely fashion determined by the application. The mechanisms which are used to determine when a channel is started and stopped are triggering and the disconnect interval respectively.

This mechanism works well unless the operator wishes to terminate a channel before the disconnect time interval expires. This can occur in the following situations:

- System quiesce
- Resource conservation
- Unilateral action at one end of a channel

In these cases it is necessary to stop the channel using the STOP option from the Message Channel List panel of the CKMC transaction. For information about what happens when a channel is stopped in this way, and how to restart the channel, see “Stopping and quiescing channels (not MQSeries for Windows)” on page 67.





## Chapter 28. Message channel planning example for OS/390 using CICS

This chapter provides a detailed example of how to connect queue managers together to send messages from one to the other. The example gives you a step-by-step implementation of a unidirectional interconnection of two queue managers.

Figure 80 illustrates the interaction between all the system components used for transferring messages between queue managers.

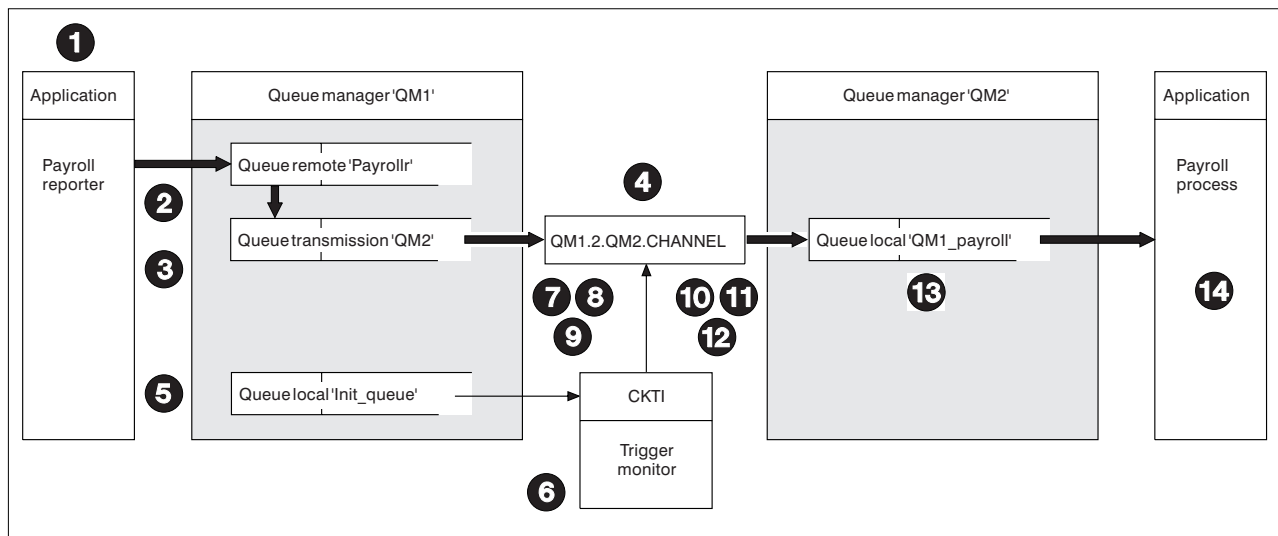

Figure 80. Connecting two queue managers in MQSeries for OS/390 using CICS

In the following list, the numbered items refer to the boxed index numbers in the figure.

1. The “Payroll reporter” application connects to queue manager “QM1”, opens a queue called “Payrollr”, and places messages on the queue.
2. The attributes of Payrollr in queue manager QM1 are:

QUEUE	Payrollr
TYPE	QREMOTE
DESCR	PAYROLL QUEUE ON QM2 QUEUE MANAGER
PUT	ENABLED
DEFPRTY	0
DEFPSIST	YES
RNAME	QM1_payroll
RQMNAME	QM2

From this information, the local queue manager QM1 determines that messages for this queue have to be transmitted to a remote queue manager QM2.

## Planning example for OS/390 using CICS

For QM1, QM2 is just a transmission queue on which messages have to be placed. A transmission queue is a local queue with its *usage* parameter set to XMITQ.

3. The attributes of the transmission queue, QM2, in queue manager QM1 are:

QUEUE	QM2
TYPE	LOCAL
DESCR	QUEUE MANAGER QM2 TRANSMISSION QUEUE
PUT	ENABLED
DEFPRTY	0
DEFPSIST	YES
OPPROCS	0
IPPROCS	0
CURDEPTH	0
MAXDEPTH	100000
PROCESS	QM2.PROCESS
TRIGGER	
MAXMSGL	4194304
BOTHRESH	0
BOQNAME	
STGCLASS	DEFAULT
INITQ	Init_queue
USAGE	XMITQ
SHARE	
DEFSOPT	EXCL
MSGDLVSQ	FIFO
RETINTVL	0
TRIGTYPE	FIRST
TRIGDPTH	1
TRIGMPRI	0
TRIGGERDATA	0
DEFTYPE	PREDEFINED
NOHARDENBO	
GET	ENABLED

Messages that the application puts to Payrollr are actually placed on the transmission queue QM2.

4. In this example, assume that the payroll message is the first message to be placed on the empty transmission queue, and because of the triggering attributes of the transmission queue, the queue manager determines that a trigger message is to be issued.

The transmission queue definition refers to an initiation queue called *Init\_queue*, and the queue manager places a trigger message on this queue. The transmission queue definition also refers to the trigger process definition, and information from this definition is included in the trigger message.

## Planning example for OS/390 using CICS

The definition of the process in queue manager QM1 is:

```
PROCESS          QM2.PROCESS
DESCR            PROCESS DEFINITION - TO TRIGGER CHANNEL
                 QM1.2.QM2.CHANNEL
APPLTYPE        CICS
APPLICID        CKSG
USERDATA        QM1.2.QM2.CHANNEL
ENVRDATA        environment information
```

The result of this trigger processing is that a trigger message is placed on the initiation queue, Init\_queue.

5. If you experience trigger messages failing to appear when expected, refer to the *MQSeries Application Programming Guide*.
6. The CKTI transaction is a long-running task that monitors the initiation queue, Init\_queue. CKTI processes the trigger message, an MQTM structure, to find that it must start CKSG. CKSG is the CICS name of the sender channel MCA transaction.
7. CKTI starts CKSG, passing the MQTM structure. The CKSG transaction starts processing, receives the MQTM structure, and extracts the name of the channel.
8. The channel name is used by CKSG to get the channel definition from the channel definition file on QM1. The DQM display settings panel of the channel in QM1.2.QM2.CHANNEL, is:

```
Channel          Help
-----
MCATTB1         QM1.2.QM2.CHANNEL - Settings          CICSTQM2

More:  +

Channel type . . . . . : SENDER
Target system id . . . . . :
Transmission queue name . . : QM2
Batch size . . . . . : 0100
Sequence number wrap . . . : 9999999
Max message size . . . . . : 0031000
Max transmission . . . . . : 32000
Disconnect interval . . . . : 0015
Transaction id . . . . . : CKSG
Connection name . . . . . : QM2C
CICS profile name . . . . . :
LU 6.2 TP name . . . . . : CKRC

F1=Help  F3=Exit  F5=Refresh now  F7=Bkwd  F8=Fwd  F10=Menu Bar
F12=Cancel
```

Figure 81. Sender settings (1)

## Planning example for OS/390 using CICS

```

Channel          Help
-----
MCATTC1          QM1.2.QM2.CHANNEL - Settings          CICSTQM2

More: -

Channel type . . . . . : SENDER

Sequential delivery . . . . : 0  (0=No or 1=Yes)

Retry
  Count . . . . . : 005
  Fast interval . . . . . : 005
  Slow interval . . . . . : 030

Exit routines
  Security . . . . . :
  Message . . . . . :
  Send . . . . . :
  Receive . . . . . :

F1=Help  F3=Exit  F5=Refresh now  F7=Bkwd  F8=Fwd  F10=Menu Bar
F12=Cancel

```

Figure 82. Sender settings (2)

The channel definition shows that CKSG must allocate a session on the CICS QM2C connection and invoke the CKRC transaction at the destination CICS system.

- The QM2C connection definition provides a communications link to the CICS system at the remote installation. The definition is as follows:

```

OBJECT CHARACTERISTICS
CEDA View
  Connection      : QM2C
  Group           : QM2CCONN
  Description     : LU 6.2 PARALLEL CONNECTION TO CICSTQM1
CONNECTION IDENTIFIERS
  Netname        : CICSTQM1
  INDSys         :
REMOTE ATTRIBUTES
  REMOTESystem   :
  REMOTENAME     :
CONNECTION PROPERTIES
  Accessmethod   : Vtam          Vtam | IRc | INdirect | Xm
  Protocol       : Appc          Appc | Lu61
  Singlesex      : No           No | Yes
  DATAstream    : User         User | 3270 | SCs | STRfield | Lms
  RECORDformat   : U           U | Vb
OPERATIONAL PROPERTIES
+ Autoconnect    : Yes         No | Yes | All

APPLID=CICSTQM2

PF 1 HELP      3 END      6 CRSR 7 SBH 8 SFH 9 MSG 10 SB 11 SF 12 CNCL

```

Figure 83. Connection definition (1)

## Planning example for OS/390 using CICS

```

OBJECT CHARACTERISTICS
CEDA View
+ INService      : Yes          Yes | No
SECURITY
  SEcurityname   :
  ATTachsec      : Local       Local | Identify | Verify | Persistent
                                     | Mixidpe
  BINDPassword   :             PASSWORD NOT SPECIFIED
  BINDSecurity   : No         No | Yes

APPLID=CICSTQM2

PF 1 HELP      3 END          6 CRSR 7 SBH 8 SFH 9 MSG 10 SB 11 SF 12 CNCL

```

Figure 84. Connection definition (2)

10. The connection definition on the remote installation CICS system is called QM1C, and is defined as follows:

```

OBJECT CHARACTERISTICS
CEDA View
  Connection      : QM1C
  Group           : QM1CONN
  DEscription     : LU 6.2 PARALLEL CONNECTION TO CICSTQM2
CONNECTION IDENTIFIERS
  Netname         : CICSTQM2
  INdsys          :
REMOTE ATTRIBUTES
  REMOTESystem    :
  REMOTENAME      :
CONNECTION PROPERTIES
  ACcessmethod    : Vtam       Vtam | IRc | INdirect | Xm
  Protocol        : Appc       Appc | Lu61
  SInglesess      : No         No | Yes
  DATAstream     : User       User | 3270 | SCs | STRfield | Lms
  REcordformat    : U          U | Vb
OPERATIONAL PROPERTIES
+ AUTOconnect     : Yes       No | Yes | All

APPLID=CICSTQM1

PF 1 HELP      3 END          6 CRSR 7 SBH 8 SFH 9 MSG 10 SB 11 SF 12 CNCL

```

Figure 85. Connection definition (1)

## Planning example for OS/390 using CICS

```

OBJECT CHARACTERISTICS
CEDA View
+ INService      : Yes           Yes | No
SECURITY
  SEcurityname   :
  ATTachsec      : Local        Local | Identify | Verify | Persistent
                                     | Mixidpe
  BINDPassword   :              PASSWORD NOT SPECIFIED
  BINDSecurity   : No           No | Yes

APPLID=CICSTQM1

PF 1 HELP      3 END          6 CRSR 7 SBH 8 SFH 9 MSG 10 SB 11 SF 12 CNCL
  
```

Figure 86. Connection definition (2)

11. CKRC is started by CICS on the remote system, and is passed the channel name during the initial data flows.
12. The transaction CKRC reads the definition for the receiver channel QM1.2.QM2.CHANNEL from the channel definition file, which contains:

```

Channel      Help
-----
MCATTB3     QM1.2.QM2.CHANNEL - Settings          CICSTQM1

More:  +

Channel type . . . . . : RECEIVER
Target system id . . . . :
Batch size . . . . . : 0100
Sequence number wrap . . : 9999999
Max message size . . . . : 0031000
Max transmission . . . . : 32000

F1=Help  F3=Exit  F5=Refresh now  F7=Bkwd  F8=Fwd  F10=Menu Bar
F12=Cancel
  
```

Figure 87. Receiver channel settings (1)

```

Channel          Help
-----
MCATTC3          QM1.2.QM2.CHANNEL- Settings          CICSTQM1

More: -

Channel type . . . . . : RECEIVER

Sequential delivery . . . : 0 (0=No or 1=Yes)
Put authority . . . . . : 1 (1=Process or 2=Context)

Exit routines
Security . . . . . :
Message . . . . . :
Send . . . . . :
Receive . . . . . :

F1=Help  F3=Exit  F5=Refresh now  F7=Bkwd  F8=Fwd  F10=Menu Bar
F12=Cancel
    
```

Figure 88. Receiver channel settings (2)

13. Once the message channel has completed the startup negotiation, the sender channel passes messages to the receiver channel. The receiver channel takes the name of the queue manager, queue name and message descriptor from the transmission header, and issues an MQPUT1 call to put the message on the local queue, QM1\_payroll.  
When the batch limit of 100 is reached, or when the transmission queue is empty, the sender and receiver channels issue a syncpoint to commit the changes through the queue managers.
14. The commit action by the QM2 queue manager makes the messages available to the “Payroll process” application.

## Planning example for OS/390 using CICS



---

## Chapter 29. Example configuration - IBM MQSeries for OS/390

This chapter gives an example of how to set up communication links from MQSeries for OS/390 or MVS/ESA to MQSeries products on the following platforms:

- OS/2
- Windows NT
- AIX
- Digital UNIX
- HP-UX
- AT&T GIS UNIX<sup>7</sup>
- Sun Solaris
- OS/400
- VSE/ESA

(You can also connect any of the following:

- OS/390 to OS/390
- OS/390 to MVS/ESA
- MVS/ESA to MVS/ESA

with or without CICS.)

First it describes the parameters needed for an LU 6.2 connection; then it describes:

- “Establishing an LU 6.2 connection” on page 400
- “Establishing an LU 6.2 connection using CICS” on page 402
- “Establishing a TCP connection” on page 404

Once the connection is established, you need to define some channels to complete the configuration. This is described in “MQSeries for OS/390 configuration” on page 405.

See “Chapter 7. Example configuration chapters in this book” on page 97 for background information about this chapter and how to use it.

---

### Configuration parameters for an LU 6.2 connection

Table 36 on page 396 presents a worksheet listing all the parameters needed to set up communication from OS/390 to one of the other MQSeries platforms. The worksheet shows examples of the parameters, which have been tested in a working environment, and leaves space for you to fill in your own values. An explanation of the parameter names follows the worksheet. Use the worksheet in this chapter in conjunction with the worksheet in the chapter for the platform to which you are connecting.

---

7. This platform has become NCR UNIX SVR4 MP-RAS, R3.0

## OS/390 and LU 6.2

The steps required to set up an LU 6.2 connection are described in “Establishing an LU 6.2 connection” on page 400 and “Establishing an LU 6.2 connection using CICS” on page 402, with numbered cross references to the parameters on the worksheet.

### Configuration worksheet

Use this worksheet to record the values you use for your configuration. Where numbers appear in the Reference column they indicate that the value must match that in the appropriate worksheet elsewhere in this book. The examples that follow in this chapter refer back to the values in the ID column. The entries in the Parameter Name column are explained in “Explanation of terms” on page 398.

Table 36. Configuration worksheet for OS/390 using LU 6.2

ID	Parameter Name	Reference	Example Used	User Value
<b>Definition for local node</b>				
<b>1</b>	Command prefix		+cpf	
<b>2</b>	Network ID		NETID	
<b>3</b>	Node name		MVSPU	
<b>4</b>	Local LU name		MVSLU	
<b>5</b>	Symbolic destination		M1	
<b>6</b>	Modename		#INTER	
<b>7</b>	Local Transaction Program name		MQSERIES	
<b>8</b>	LAN destination address		400074511092	
<b>Connection to an OS/2 system without using CICS</b>				
The values in this section of the table must match those used in Table 14 on page 138, as indicated.				
<b>9</b>	Symbolic destination		M2	
<b>10</b>	Modename	<b>17</b>	#INTER	
<b>11</b>	Remote Transaction Program name	<b>8</b>	MQSERIES	
<b>12</b>	Partner LU name	<b>6</b>	OS2LU	
<b>Connection to an OS/2 system using CICS</b>				
The values in this section of the table must match those used in Table 14 on page 138, as indicated.				
<b>13</b>	Connection name		OS2	
<b>14</b>	Group name		EXAMPLE	
<b>15</b>	Session name		OS2SESS	
<b>16</b>	Netname	<b>6</b>	OS2LU	
<b>Connection to a Windows NT system without using CICS</b>				
The values in this section of the table must match those used in Table 16 on page 170, as indicated.				
<b>9</b>	Symbolic destination		M3	
<b>10</b>	Modename	<b>17</b>	#INTER	
<b>11</b>	Remote Transaction Program name	<b>7</b>	MQSERIES	
<b>12</b>	Partner LU name	<b>5</b>	WINNTLU	
<b>17</b>	Remote node ID	<b>4</b>	05D 30F65	
<b>Connection to a Windows NT system using CICS</b>				
The values in this section of the table must match those used in Table 16 on page 170, as indicated.				
<b>13</b>	Connection name		WNT	
<b>14</b>	Group name		EXAMPLE	
<b>15</b>	Session name		WNTSESS	

Table 36. Configuration worksheet for OS/390 using LU 6.2 (continued)

ID	Parameter Name	Reference	Example Used	User Value
<b>16</b>	Netname	<b>6</b>	WINNTLU	
<b>Connection to an AIX system without using CICS</b>				
The values in this section of the table must match those used in Table 20 on page 197, as indicated.				
<b>9</b>	Symbolic Destination		<b>M4</b>	
<b>10</b>	Modename	<b>14</b>	#INTER	
<b>11</b>	Remote Transaction Program name	<b>6</b>	MQSERIES	
<b>12</b>	Partner LU name	<b>4</b>	AIXLU	
<b>Connection to an AIX system using CICS</b>				
The values in this section of the table must match those used in Table 20 on page 197, as indicated.				
<b>13</b>	Connection name		<b>AIX</b>	
<b>14</b>	Group name		<b>EXAMPLE</b>	
<b>15</b>	Session name		<b>AIXSESS</b>	
<b>16</b>	Netname	<b>4</b>	AIXLU	
<b>Connection to an HP-UX system without using CICS</b>				
The values in this section of the table must match those used in Table 23 on page 219, as indicated.				
<b>9</b>	Symbolic Destination		<b>M5</b>	
<b>10</b>	Modename	<b>6</b>	#INTER	
<b>11</b>	Remote Transaction Program name	<b>7</b>	MQSERIES	
<b>12</b>	Partner LU name	<b>5</b>	HPUXLU	
<b>Connection to an HP-UX system using CICS</b>				
The values in this section of the table must match those used in Table 23 on page 219, as indicated.				
<b>13</b>	Connection name		<b>HPUX</b>	
<b>14</b>	Group name		<b>EXAMPLE</b>	
<b>15</b>	Session name		<b>HPUXSESS</b>	
<b>16</b>	Netname	<b>5</b>	HPUXLU	
<b>Connection to an AT&amp;T GIS UNIX system without using CICS</b>				
The values in this section of the table must match those used in Table 25 on page 243, as indicated.				
<b>9</b>	Symbolic Destination		<b>M6</b>	
<b>10</b>	Modename	<b>15</b>	#INTER	
<b>11</b>	Remote Transaction Program name	<b>5</b>	MQSERIES	
<b>12</b>	Partner LU name	<b>4</b>	GISLU	
<b>Connection to an AT&amp;T GIS UNIX system using CICS</b>				
The values in this section of the table must match those used in Table 25 on page 243, as indicated.				
<b>13</b>	Connection name		<b>GIS</b>	
<b>14</b>	Group name		<b>EXAMPLE</b>	
<b>15</b>	Session name		<b>GISSESS</b>	
<b>16</b>	Netname	<b>4</b>	GISLU	
<b>Connection to a Sun Solaris system without using CICS</b>				
The values in this section of the table must match those used in Table 27 on page 257, as indicated.				
<b>9</b>	Symbolic destination		<b>M7</b>	
<b>10</b>	Modename	<b>17</b>	#INTER	
<b>11</b>	Remote Transaction Program name	<b>8</b>	MQSERIES	
<b>12</b>	Partner LU name	<b>7</b>	SOLARLU	

## OS/390 and LU 6.2

Table 36. Configuration worksheet for OS/390 using LU 6.2 (continued)

ID	Parameter Name	Reference	Example Used	User Value
<b>Connection to a Sun Solaris system using CICS</b>				
The values in this section of the table must match those used in Table 27 on page 257, as indicated.				
<b>13</b>	Connection name		SOL	
<b>14</b>	Group name		EXAMPLE	
<b>15</b>	Session name		SOLSESS	
<b>16</b>	Netname	<b>7</b>	SOLARLU	
<b>Connection to an AS/400 system without using CICS</b>				
The values in this section of the table must match those used in Table 42 on page 460, as indicated.				
<b>9</b>	Symbolic Destination		M8	
<b>10</b>	Modename	<b>17</b>	#INTER	
<b>11</b>	Remote Transaction Program name	<b>8</b>	MQSERIES	
<b>12</b>	Partner LU name	<b>3</b>	AS400LU	
<b>Connection to an AS/400 system using CICS</b>				
The values in this section of the table must match those used in Table 42 on page 460, as indicated.				
<b>13</b>	Connection name		AS4	
<b>14</b>	Group name		EXAMPLE	
<b>15</b>	Session name		AS4SESS	
<b>16</b>	Netname	<b>3</b>	AS400LU	
<b>Connection to a VSE/ESA system without using CICS</b>				
The values in this section of the table must match those used in Table 44 on page 485, as indicated.				
<b>9</b>	Symbolic destination		M9	
<b>10</b>	Modename		#INTER	
<b>11</b>	Remote Transaction Program name	<b>4</b>	MQ01	
<b>12</b>	Partner LU name	<b>3</b>	VSELU	
<b>Connection to a VSE/ESA system using CICS</b>				
The values in this section of the table must match those used in Table 44 on page 485, as indicated.				
<b>13</b>	Connection name		VSE	
<b>14</b>	Group name		EXAMPLE	
<b>15</b>	Session name		VSESESS	
<b>16</b>	Netname	<b>3</b>	VSELU	

## Explanation of terms

### **1** Command prefix

This is the unique command prefix of your MQSeries for OS/390 queue-manager subsystem. The OS/390 systems programmer defines this at installation time, in SYS1.PARMLIB(IEFSSNss), and will be able to tell you the value.

### **2** Network ID

The VTAM startup procedure in your installation is partly customized by the ATCSTRxx member of the data set referenced by the DDNAME VTAMLST. The Network ID is the value specified for the NETID parameter in this member. For Network ID you must specify the name of the NETID

that owns the MQSeries communications subsystem (MQSeries channel initiator or CICS for OS/390 as the case may be). Your network administrator will tell you the value.

**3 Node name**

VTAM, being a low-entry network node, does not have a Control Point name for Advanced Peer-to-Peer Networking (APPN) use. It does however have a system services control point name (SSCPNAME). For node name, you must specify the name of the SSCP that owns the MQSeries communications subsystem (MQSeries channel initiator or CICS for OS/390 as the case may be). This is defined in the same ATCSTRxx member as the Network ID. Your network administrator will tell you the value.

**4 Local LU name**

A logical unit (LU) is software that serves as an interface or translator between a transaction program and the network. It manages the exchange of data between transaction programs. The local LU name is the unique VTAM APPLID of this MQSeries subsystem. Your network administrator will tell you this value.

**5 9 Symbolic destination**

This is the name you give to the CPI-C side information profile. You need a side information entry for each LU 6.2 listener.

**6 10 Modename**

This is the name given to the set of parameters that control the LU 6.2 conversation. An entry with this name and similar attributes must be defined at each end of the session. In VTAM, this corresponds to a mode table entry. Your network administrator will assign this to you.

**7 11 Transaction Program name**

MQSeries applications trying to converse with this queue manager will specify a symbolic name for the program to be run at the receiving end. This will have been specified in the TPNAME attribute on the channel definition at the sender. For simplicity, wherever possible use a transaction program name of MQSERIES, or in the case of a connection to VSE/ESA, where the length is limited to 4 bytes, use MQTP.

See Table 30 on page 341 for more information. If the receiving end is OS/390 using CICS, special values are required.

**8 LAN destination address**

This is the LAN destination address that your partner nodes will use to communicate with this host. When you are using a 3745 network controller, it will be the value specified in the LOCADD parameter for the line definition to which your partner is physically connected. If your partner nodes use other devices such as 317X or 6611 devices, the address will have been set during the customization of those devices. Your network administrator will tell you this value.

**12 Partner LU name**

This is the LU name of the MQSeries queue manager on the system with which you are setting up communication. This value is specified in the side information entry for the remote partner.

**13 Connection name**

(CICS only) This is a 4-character name by which each connection will be individually known in CICS RDO.

**14 Group name**

(CICS only) You choose your own 8-character name for this value. Your system may already have a group defined for connections to partner nodes. Your CICS administrator will give you a value to use.

**15 Session name**

(CICS only) This is an 8-character name by which each group of sessions will be individually known. For clarity we use the connection name, concatenated with 'SESS'.

**16 Netname**

(CICS only) This is the LU name of the MQSeries queue manager on the system with which you are setting up communication.

**17 Remote node ID**

For a connection to Windows NT, this is the ID of the local node on the Windows NT system with which you are setting up communication.

## Establishing an LU 6.2 connection

To establish an LU 6.2 connection, there are two steps:

1. Define yourself to the network.
2. Define a connection to the partner.

### Defining yourself to the network

1. SYS1.PARMLIB(APPCPMxx) contains the startup parameters for APPC. You must add a line to this file to define the local LU name you intend to use for the MQSeries LU 6.2 listener. The line you add should take the form

```
LUADD ACBNAME(mvs lu)
      NOSCHED
      TPDATA(csq.appctp)
```

Specify values for ACBNAME( **4** ) and TPDATA.

The NOSCHED parameter tells APPC that our new LU will not be using the LU 6.2 scheduler (ASCH), but has one of its own. TPDATA refers to the Transaction Program data set in which LU 6.2 stores information about transaction programs. Again, MQSeries will not use this, but it is required by the syntax of the LUADD command.

2. Start the APPC subsystem with the command:

```
START APPC,SUB=MSTR,APPC=xx
```

where *xx* is the suffix of the PARMLIB member in which you added the LU in step 1.

**Note:** If APPC is already running, it can be refreshed with the command:

```
SET APPC=xx
```

The effect of this is cumulative, that is, APPC will not lose its knowledge of objects already defined to it in this or another PARMLIB member.

3. Add the new LU to a suitable VTAM major node definition. These are typically in SYS1.VTAMLST. The APPL definition will look similar to the sample shown in Figure 89 on page 401.

```

MVSLU APPL ACBNAME=MVSLU,      4
          APPC=YES,
          AUTOSES=0,
          DDRAIN=NALLOW,
          DLOGMOD=#INTER,      6
          DMINWNL=10,
          DMINWNR=10,
          DRESPL=NALLOW,
          DSESLIM=60,
          LMDENT=19,
          MODETAB=MTCICS,
          PARSESS=YES,
          VERIFY=NONE,
          SECACPT=ALREADYV,
          SRBEXIT=YES

```

Figure 89. Channel Initiator APPL definition

4. Activate the major node. This can be done with the command:  
`V,NET,ACT,majornode`
5. Add an entry defining your LU to the CPI-C side information data set. Use the APPC utility program ATBSDFMU to do this. Sample JCL is in `thlqual.SCSQPROC(CSQ4SIDE)` (where `thlqual` is the target library high-level qualifier for MQSeries data sets in your installation.)

The entry you add will look like this:

```

SIADD
  DESTNAME(M1)      5
  MODENAME(#INTER) 6
  TPNAME(MQSERIES) 7
  PARTNER_LU(MVSLU) 4

```

6. Create the channel-initiator parameter module for your queue manager. Sample JCL to do this is in `thlqual.SCSQPROC(CSQ4XPRM)`. You must specify the local LU (4) assigned to your queue manager in the `LUNAME=` parameter of the `CSQ6CHIP` macro.

```

//SYSIN DD *
        CSQ6CHIP ADAPS=8,           X
          ACTCHL=200,              X
          CURRCHL=200,            X
          DISPS=5,                 X
          LUNAME=MVSLU,           X
          LU62CHL=200,            X
          TCPCHL=200,             X
          TCPKEEP=NO,             X
          TCPNAME=TCPIP,          X
          TCPTYPE=0ESOCKET,       X
          TRAXSTR=YES,            X
          TRAXTBL=2
        END
/*

```

Figure 90. Channel Initiator initialization parameters

7. Modify the job to assemble and link-edit the tailored version of the initiator macro to produce a new load module.
8. Submit the job and verify that it completes successfully.

## LU 6.2 without CICS

- Put the new initialization-parameters module in an APF-authorized user library. Include this library in the STEPLIB concatenation for the channel initiator's started-task procedure, ensuring that it precedes the library *thlqual.SCSQAUTH*.

### Defining a connection to a partner

**Note:** This example is for a connection to an OS/2 system but the task is the same for other platforms.

Add an entry to the CPI-C side information data set to define the connection. Sample JCL to do this is in *thlqual.SCSQPROC(CSQ4SIDE)*.

The entry you add will look like this:

```
SIADD
  DESTNAME(M2)           9
  MODENAME(#INTER)      10
  TPNAME(MQSERIES)      11
  PARTNER_LU(OS2LU)     12
```

### What next?

The connection is now established. You are ready to complete the configuration. Go to "MQSeries for OS/390 configuration" on page 405.

---

## Establishing an LU 6.2 connection using CICS

**Note:** This example is for a connection to an OS/2 system. The steps are the same whatever platform you are using; change the values as appropriate.

### Defining a connection

- At a CICS command line type:  
CEDA DEF CONN(*connection name*) 13  
GROUP(*group name*) 14

For example:

```
CEDA DEF CONN(OS2) GROUP(EXAMPLE)
```

- Press Enter to define the connection to CICS.  
A panel is displayed, as shown below.



```

DEF CONN(OS2) GROUP(EXAMPLE)
OVERTYPE TO MODIFY
CEDA DEFINE
Connection      : OS2
Group           : EXAMPLE
DEscription    ==>
CONNECTION IDENTIFIERS
Netname        ==> OS2LU
INDsys         ==>
REMOTE ATTRIBUTES
REMOTESystem   ==>
REMOTENAME     ==>
CONNECTION PROPERTIES
ACcessmethod   ==> Vtam      Vtam | IRc | INdirect | Xm
Protocol       ==> Appc      Appc | Lu61
SInglesess     ==> No        No | Yes
DATAstream     ==> User      User | 3270 | SCs | STRfield | Lms
RECORDformat   ==> U         U | Vb
OPERATIONAL PROPERTIES
+ Autoconnect  ==> No        No | Yes | All
I New group EXAMPLE created.

APPLID=MVSLU

DEFINE SUCCESSFUL
PF 1 HELP 2 COM 3 END
TIME: 16.49.30 DATE: 95.065
6 CRSR 7 SBH 8 SFH 9 MSG 10 SB 11 SF 12 CNCL

```

- On this panel, change the **Netname** field in the CONNECTION IDENTIFIERS section to be the LU name (**16**) of the target system. In the CONNECTION PROPERTIES section set the **ACcessmethod** field to Vtam and the **Protocol** to Appc.
- Press Enter to make the change.

## Defining the sessions

- At a CICS command line type:

```

CEDA DEF SESS(session name) 15
      GROUP(group name) 14

```

For example:

```

CEDA DEF SESS(OS2SESS) GROUP(EXAMPLE)

```

- Press Enter to define the group of sessions for the connection. A panel is displayed, as shown below.

```

DEF SESS(OS2SESS) GROUP(EXAMPLE)
OVERTYPE TO MODIFY
CEDA DEFINE
Sessions ==> OS2SESS
Group ==> EXAMPLE
DEscription ==>
SESSION IDENTIFIERS
Connection ==> OS2
SESSName ==>
NETnameq ==>
MOfename ==> #INTER
SESSION PROPERTIES
Protocol ==> Appc Appc | Lu61
MAximum ==> 008 , 004 0-999
RECEIVEPfx ==>
RECEIVECount ==> 1-999
SENDPfx ==>
SENDCount ==> 1-999
SENDSize ==> 04096 1-30720
+ RECEIVESize ==> 04096 1-30720
S CONNECTION MUST BE SPECIFIED.
APPLID=MVSLU

PF 1 HELP 2 COM 3 END 6 CRSR 7 SBH 8 SFH 9 MSG 10 SB 11 SF 12 CNCL

```

3. On this panel, in the SESSION IDENTIFIERS section, specify the Connection name ( **13** ) in the **Connection** field and set the **MOfename** to #INTER. In the SESSION PROPERTIES section set the **Protocol** to Appc and the **MAximum** field to 008 , 004.
4. Press Enter to make the change.

### Installing the new group definition

To install the new group definition, type:  
 CEDA INS GROUP(*group name*) **14**

at a CICS command line, and press Enter.

**Note:** If this connection group is already in use, severe errors will be reported. If this occurs you must take the existing connections out of service, retry the group installation, and then set the connections in service again using the following commands:

1. CEMT I CONN
2. CEMT S CONN(\*) OUTS
3. CEDA INS GROUP(*Group name*)
4. CEMT S CONN(\*) INS

### What next?

The connection is now established. You are ready to complete the configuration. Go to “MQSeries for OS/390 configuration” on page 405.

---

## Establishing a TCP connection

Edit the channel initiator initialization parameters. Sample JCL to do this is in *thlqual.SCSQPROC(CSQ4XPRM)*. You must add the name of the TCP address space to the TCPNAME= parameter.

```
//SYSIN DD *
        CSQ6CHIP ADAPS=8,           X
          ACTCHL=200,             X
          CURRCHL=200,           X
          DISPS=5,                X
          LUNAME=MVSLU,          X
          LU62CHL=200,           X
          TCPCHL=200,            X
          TCPKEEP=NO,            X
          TCPNAME=TCPIP,         X
          TCPTYPE=OESOCKET,      X
          TRAXSTR=YES,           X
          TRAXTBL=2
        END
/*
```

Figure 91. Channel Initiator initialization parameters

## What next?

The TCP connection is now established. You are ready to complete the configuration. Go to “MQSeries for OS/390 configuration”.

---

## MQSeries for OS/390 configuration

If you are not using CICS:

1. Start the channel initiator using the command:

```
+cpf START CHINIT PARM(xparms) 1
```

where *xparms* is the name of the channel-initiator parameter module that you created.

2. Start an LU 6.2 listener using the command:

```
+cpf START LSTR LUNAME(M1) TRPTYPE(LU62)
```

The LUNAME of M1 refers to the symbolic name you gave your LU (**5**). You must specify TRPTYPE(LU62), otherwise the listener will assume you want TCP.

3. Start a TCP listener using the command:

```
+cpf START LSTR
```

If you wish to use a port other than 1414 (the default MQSeries port), use the command:

```
+cpf START LSTR PORT(1555)
```

MQSeries channels will not initialize successfully if the channel negotiation detects that the message sequence number is different at each end. You may need to reset this manually.

Note that the OS/390 product with CICS uses the message sequence number of the message it last sent, while all other platforms use the sequence number of the next message to be sent. This means you must reset the message sequence number to 0 at the OS/390 (with CICS) end of a channel and to 1 everywhere else.

## Channel configuration

The following sections detail the configuration to be performed on the OS/390 queue manager to implement the channel described in Figure 32 on page 97.

## OS/390 configuration

Examples are given for connecting MQSeries for OS/390 and MQSeries for OS/2 Warp. If you wish to connect to another MQSeries product use the appropriate set of values from the table in place of those for OS/2.

**Note:** The words in **bold** are user-specified and reflect the names of MQSeries objects used throughout these examples. If you change the names used here, ensure that you also change the other references made to these objects throughout this book. All others are keywords and should be entered as shown.

Table 37. Configuration worksheet for MQSeries for OS/390

ID	Parameter Name	Reference	Example Used	User Value
<b>Definition for local node</b>				
<b>A</b>	Queue Manager Name		MVS	
<b>B</b>	Local queue name		MVS.LOCALQ	
<b>Connection to MQSeries for OS/2 Warp</b>				
The values in this section of the table must match those used in Table 15 on page 164, as indicated.				
<b>C</b>	Remote queue manager name	<b>A</b>	OS2	
<b>D</b>	Remote queue name		OS2.REMOTEQ	
<b>E</b>	Queue name at remote system	<b>B</b>	OS2.LOCALQ	
<b>F</b>	Transmission queue name		OS2	
<b>G</b>	Sender (LU 6.2) channel name		MVS.OS2.SNA	
<b>H</b>	Sender (TCP) channel name		MVS.OS2.TCP	
<b>I</b>	Receiver (LU 6.2) channel name	<b>G</b>	OS2.MVS.SNA	
<b>J</b>	Receiver (TCP) channel name	<b>H</b>	OS2.MVS.TCP	
<b>K</b>	Sender (LU 6.2 using CICS) channel name		MVS.OS2.CICS	
<b>L</b>	Receiver (LU 6.2 using CICS) channel name		OS2.MVS.CICS	
<b>Connection to MQSeries for Windows NT</b>				
The values in this section of the table must match those used in Table 17 on page 185, as indicated.				
<b>C</b>	Remote queue manager name	<b>A</b>	WINNT	
<b>D</b>	Remote queue name		WINNT.REMOTEQ	
<b>E</b>	Queue name at remote system	<b>B</b>	WINNT.LOCALQ	
<b>F</b>	Transmission queue name		WINNT	
<b>G</b>	Sender (LU 6.2) channel name		MVS.WINNT.SNA	
<b>H</b>	Sender (TCP) channel name		MVS.WINNT.TCP	
<b>I</b>	Receiver (LU 6.2) channel name	<b>G</b>	WINNT.MVS.SNA	
<b>J</b>	Receiver (TCP/IP) channel name	<b>H</b>	WINNT.MVS.TCP	
<b>K</b>	Sender (LU 6.2 using CICS) channel name		MVS.WINNT.CICS	
<b>L</b>	Receiver (LU 6.2 using CICS) channel name		WINNT.MVS.CICS	
<b>Connection to MQSeries for AIX</b>				
The values in this section of the table must match those used in Table 21 on page 211, as indicated.				
<b>C</b>	Remote queue manager name		AIX	
<b>D</b>	Remote queue name		AIX.REMOTEQ	
<b>E</b>	Queue name at remote system	<b>B</b>	AIX.LOCALQ	
<b>F</b>	Transmission queue name		AIX	
<b>G</b>	Sender (LU 6.2) channel name		MVS.AIX.SNA	
<b>H</b>	Sender (TCP/IP) channel name		MVS.AIX.TCP	
<b>I</b>	Receiver (LU 6.2) channel name	<b>G</b>	AIX.MVS.SNA	

Table 37. Configuration worksheet for MQSeries for OS/390 (continued)

ID	Parameter Name	Reference	Example Used	User Value
<b>J</b>	Receiver (TCP/IP) channel name	<b>H</b>	AIX.MVS.TCP	
<b>K</b>	Sender (LU 6.2 using CICS) channel name		MVS.AIX.CICS	
<b>L</b>	Receiver (LU 6.2 using CICS) channel name		AIX.MVS.CICS	
<b>Connection to MQSeries for DIGITAL UNIX (Compaq Tru64 UNIX)</b>				
The values in this section of the table must match those used in Table 22 on page 216, as indicated.				
<b>C</b>	Remote queue manager name		DECUX	
<b>D</b>	Remote queue name		DECUX.REMOTEQ	
<b>E</b>	Queue name at remote system	<b>B</b>	DECUX.LOCALQ	
<b>F</b>	Transmission queue name		DECUX	
<b>H</b>	Sender (TCP) channel name		DECUX.MVS.TCP	
<b>J</b>	Receiver (TCP) channel name	<b>H</b>	MVS.DECUX.TCP	
<b>Connection to MQSeries for HP-UX</b>				
The values in this section of the table must match those used in Table 24 on page 239, as indicated.				
<b>C</b>	Remote queue manager name		HPUX	
<b>D</b>	Remote queue name		HPUX.REMOTEQ	
<b>E</b>	Queue name at remote system	<b>B</b>	HPUX.LOCALQ	
<b>F</b>	Transmission queue name		HPUX	
<b>G</b>	Sender (LU 6.2) channel name		MVS.HPUX.SNA	
<b>H</b>	Sender (TCP) channel name		MVS.HPUX.TCP	
<b>I</b>	Receiver (LU 6.2) channel name	<b>G</b>	HPUX.MVS.SNA	
<b>J</b>	Receiver (TCP) channel name	<b>H</b>	HPUX.MVS.TCP	
<b>K</b>	Sender (LU 6.2 using CICS) channel name		MVS.HPUX.CICS	
<b>L</b>	Receiver (LU 6.2 using CICS) channel name		HPUX.MVS.CICS	
<b>Connection to MQSeries for AT&amp;T GIS UNIX</b>				
The values in this section of the table must match those used in Table 26 on page 253, as indicated.				
<b>C</b>	Remote queue manager name		GIS	
<b>D</b>	Remote queue name		GIS.REMOTEQ	
<b>E</b>	Queue name at remote system	<b>B</b>	GIS.LOCALQ	
<b>F</b>	Transmission queue name		GIS	
<b>G</b>	Sender (LU 6.2) channel name		MVS.GIS.SNA	
<b>H</b>	Sender (TCP) channel name		MVS.GIS.TCP	
<b>I</b>	Receiver (LU 6.2) channel name	<b>G</b>	GIS.MVS.SNA	
<b>J</b>	Receiver (TCP) channel name	<b>H</b>	GIS.MVS.TCP	
<b>K</b>	Sender (LU 6.2 using CICS) channel name		MVS.GIS.CICS	
<b>L</b>	Receiver (LU 6.2 using CICS) channel name		GIS.MVS.CICS	
<b>Connection to MQSeries for Sun Solaris</b>				
The values in this section of the table must match those used in Table 28 on page 272, as indicated.				
<b>C</b>	Remote queue manager name		SOLARIS	
<b>D</b>	Remote queue name		SOLARIS.REMOTEQ	
<b>E</b>	Queue name at remote system	<b>B</b>	SOLARIS.LOCALQ	
<b>F</b>	Transmission queue name		SOLARIS	
<b>G</b>	Sender (LU 6.2) channel name		MVS.SOLARIS.SNA	
<b>H</b>	Sender (TCP) channel name		MVS.SOLARIS.TCP	
<b>I</b>	Receiver (LU 6.2) channel name	<b>G</b>	SOLARIS.MVS.SNA	

## OS/390 configuration

Table 37. Configuration worksheet for MQSeries for OS/390 (continued)

ID	Parameter Name	Reference	Example Used	User Value
<b>J</b>	Receiver (TCP/IP) channel name	<b>H</b>	SOLARIS.MVS.TCP	
<b>Connection to MQSeries for AS/400</b>				
The values in this section of the table must match those used in Table 43 on page 472, as indicated.				
<b>C</b>	Remote queue manager name		AS400	
<b>D</b>	Remote queue name		AS400.REMOTEQ	
<b>E</b>	Queue name at remote system	<b>B</b>	AS400.LOCALQ	
<b>F</b>	Transmission queue name		AS400	
<b>G</b>	Sender (LU 6.2) channel name		MVS.AS400.SNA	
<b>H</b>	Sender (TCP/IP) channel name		MVS.AS400.TCP	
<b>I</b>	Receiver (LU 6.2) channel name	<b>G</b>	AS400.MVS.SNA	
<b>J</b>	Receiver (TCP/IP) channel name	<b>H</b>	AS400.MVS.TCP	
<b>K</b>	Sender (LU 6.2 using CICS) channel name		MVS.AS400.CICS	
<b>L</b>	Receiver (LU 6.2 using CICS) channel name		AS400.MVS.CICS	
<b>Connection to MQSeries for VSE/ESA</b>				
The values in this section of the table must match those used in Table 45 on page 490, as indicated.				
<b>C</b>	Remote queue manager name		VSE	
<b>D</b>	Remote queue name		VSE.REMOTEQ	
<b>E</b>	Queue name at remote system	<b>B</b>	VSE.LOCALQ	
<b>F</b>	Transmission queue name		VSE	
<b>G</b>	Sender channel name		MVS.VSE.SNA	
<b>I</b>	Receiver channel name	<b>G</b>	VSE.MVS.SNA	

### MQSeries for OS/390 sender-channel definitions using non-CICS LU 6.2

```

Local Queue
  Object type : QLOCAL
  Name : OS2 F
  Usage : X (XmitQ)

Remote Queue
  Object type : QREMOTE
  Name : OS2.REMOTEQ D
  Name on remote system : OS2.LOCALQ E
  Remote system name : OS2 C
  Transmission queue : OS2 F

Sender Channel
  Channel name : MVS.OS2.SNA G
  Transport type : L (LU6.2)
  Transmission queue name : OS2 F
  Connection name : M2 9

```

### MQSeries for OS/390 receiver-channel definitions using non-CICS LU 6.2

```

Local Queue
  Object type : QLOCAL
  Name : MVS.LOCALQ B
  Usage : N (Normal)

Receiver Channel
  Channel name : OS2.MVS.SNA I

```

**MQSeries for OS/390 sender-channel definitions using TCP**

```

Local Queue
  Object type : QLOCAL
  Name : OS2 F
  Usage : X (XmitQ)

Remote Queue
  Object type : QREMOTE
  Name : OS2.REMOTEQ D
Name on remote system : OS2.LOCALQ E
Remote system name : OS2 C
Transmission queue : OS2 F

Sender Channel
  Channel name : MVS.OS2.TCP H
  Transport type : T (TCP)
Transmission queue name : OS2 F
  Connection name : os2.tcpip.hostname

```

**MQSeries for OS/390 receiver-channel definitions using TCP**

```

Local Queue
  Object type : QLOCAL
  Name : MVS.LOCALQ B
  Usage : N (Normal)

Receiver Channel
  Channel name : OS2.MVS.TCP J

```

**MQSeries for OS/390 sender-channel definitions using CICS**

```

Local Queue
  Object type : QLOCAL
  Name : OS2 F
  Usage : X (XmitQ)

Remote Queue
  Object type : QREMOTE
  Name : OS2.REMOTEQ D
Name on remote system : OS2.LOCALQ E
Remote system name : OS2 C
Transmission queue : OS2 F

Sender Channel
  Channel name : MVS.OS2.CICS K
  Channel type : 1 (Sender)
  Target system id : <blank>
Transmission queue name : OS2 F
  Transaction id : CKSG
  Connection name : OS2 13
  LU62 TP name : MQSERIES

```

**MQSeries for OS/390 receiver-channel definitions using CICS**

```

Local Queue
  Object type : QLOCAL
  Name : MVS.LOCALQ B
  Usage : N (Normal)

Receiver Channel
  Channel name : OS2.MVS.CICS L
  Channel type : 3 (Receiver)
  Target system id : <blank>

```

**Defining a local queue**

1. From ISPF, access the MQSeries main menu.

## OS/390 configuration

```

IBM MQSeries for OS/390 - Main Menu

Complete fields. Then press Enter.

Action . . . . . 1      1. Display  5. Perform
                          2. Define   6. Start
                          3. Alter    7. Stop
                          4. Delete

Object type . . . . . QLOCAL      +
Name . . . . . MVS.LOCALQ
Like . . . . . _____

Connect to queue
manager . . . . . : MQ25
Target queue manager : MQ25
Response wait time . : 10  seconds

(C) Copyright IBM Corporation 1993,1999. All rights reserved.

Command ==> _____
F1=Help      F2=Split   F3=Exit     F4=Prompt   F6=QueueMgr F9=Swap
F10=Messages F12=Cancel

```

2. Specify an **Action** of 2, enter an **Object type** of QLOCAL, and specify a **Name** for the queue.
3. Press Enter.  
The first Define a Local Queue panel is displayed. There are several panels in all.
4. Use F7 and F8 to move backwards and forwards through the panels of attributes and set each attribute as required.  
Specifically, you should check the values for **Usage** and **Trigger type**.

```

Define a Local Queue

Complete fields, then press F8 for further fields, or Enter to define queue.

More:      +

Queue name . . . . . MVS.LOCALQ
Description . . . . . _____
                          _____

Put enabled . . . . . Y  Y=Yes,N=No
Get enabled . . . . . Y  Y=Yes,N=No
Usage . . . . . N    N=Normal,X=XmitQ
Storage class . . . . . DEFAULT

Command ==> _____
F1=Help      F2=Split   F3=Exit     F7=Bkwd    F8=Fwd     F9=Swap
F10=Messages F12=Cancel

```



Define a Local Queue

Press F7 or F8 to see other fields, or Enter to define queue.

More: - +

```

Default persistence . . . . . N Y=Yes,N=No
Default priority . . . . . 0 0 - 9
Message delivery sequence . . P P=Priority,F=FIFO
Permit shared access . . . . . N Y=Yes,N=No
Default share option . . . . . E E=Exclusive,S=Shared
Index type . . . . . N N=None,M=MsgId,C=CorrelId,T=MsgToken
Maximum queue depth . . . . . 999999999 0 - 999999999
Maximum message length . . . 4194304 0 - 4194304
Retention interval . . . . . 999999999 0 - 999999999 hours

Cluster name . . . . . _____
Cluster namelist name . . . . . _____
Default bind . . . . . 0 0=Open,N=Notfixed

Command ==> _____
F1=Help F2=Split F3=Exit F7=Bkwd F8=Fwd F9=Swap
F10=Messages F12=Cancel
    
```

Define a Local Queue

Press F7 or F8 to see other fields, or Enter to define queue.

More: - +

Trigger Definition

```

Trigger type . . . . . F F=First,E=Every,D=Depth,N=None

Trigger set . . . . . N Y=Yes,N=No
Trigger message priority . 0 0 - 9
Trigger depth . . . . . 1 1 - 999999999
Trigger data . . . . . _____

Process name . . . . . _____
Initiation queue . . . . . _____

Command ==> _____
F1=Help F2=Split F3=Exit F7=Bkwd F8=Fwd F9=Swap
F10=Messages F12=Cancel
    
```

## OS/390 configuration

```
Define a Local Queue
Press F7 or F8 to see other fields, or Enter to define queue.

More: - +

Event Control

Queue full . . . . . E E=Enabled,D=Disabled

Upper queue depth . . . . D E=Enabled,D=Disabled
Threshold . . . . . 80 0 - 100 %

Lower queue depth . . . . D E=Enabled,D=Disabled
Threshold . . . . . 40 0 - 100 %

Service interval . . . . N H=High,0=OK,N=None
Interval . . . . . 999999999 0 - 999999999 milliseconds

Command ==> _____
F1=Help      F2=Split    F3=Exit     F7=Bkwd     F8=Fwd      F9=Swap
F10=Messages F12=Cancel
```

```
Define a Local Queue
Press F7 to see previous fields, or Enter to define queue.

More: -

Backout Reporting

Backout threshold . . . . 0 0=No backout reporting

Harden backout counter . . N Y=Yes,N=No
Backout requeue name . . . _____

Command ==> _____
F1=Help      F2=Split    F3=Exit     F7=Bkwd     F8=Fwd      F9=Swap
F10=Messages F12=Cancel
```

## Defining a remote queue

1. From ISPF, access the MQSeries main menu.
2. Specify an **Action** of 2, enter an **Object type** of QREMOTE, and specify a **Name** for the queue.
3. Press Enter. The Define a Remote Queue panels are displayed.

```

Define a Remote Queue

Complete fields, then press F8 for further fields, or Enter to define queue.

More: +

Queue name . . . . . OS2.REMOTEQ
Description . . . . . _____
                                     _____

Put enabled . . . . . Y Y=Yes,N=No
Default persistence . . . . N Y=Yes,N=No
Default priority . . . . . 0 0 - 9
Remote name . . . . . _____
Remote queue manager . . . . _____
Transmission queue . . . . . _____

Command ==> _____
F1=Help      F2=Split    F3=Exit      F7=Bkwd      F8=Fwd      F9=Swap
F10=Messages F12=Cancel

```

```

Define a Remote Queue

Press F7 to see previous fields, or Enter to define queue.

More: -

Cluster name . . . . . _____
Cluster namelist name . . . . _____
Default bind . . . . . 0 0=Open,N=Notfixed

Command ==> _____
F1=Help      F2=Split    F3=Exit      F7=Bkwd      F8=Fwd      F9=Swap
F10=Messages F12=Cancel

```

- Set each parameter as required. Specifically, you should set the values for **Remote name**, **Remote queue manager**, and **Transmission queue**.

## Defining a sender channel when not using CICS

- From ISPF, access the MQSeries main menu.
- Specify an **Action** of 2, enter an **Object type** of CHLSENDER, and specify a **Name** for the channel.
- Press Enter.  
The first Define a Sender Channel panel is displayed. There are three panels in all.
- Complete the parameter fields as indicated. In particular, specify the fields **Transport type**, **Connection name**( **9** ), and **Transmission queue name**.

## OS/390 configuration

Define a Sender Channel

Complete fields, then press F8 for further fields, or Enter to define channel.

More: +

Channel name . . . . . MVS.OS2.SNA  
 Description . . . . . \_\_\_\_\_  
 \_\_\_\_\_

Transport type . . . . . L L=LU6.2,T=TCP  
 Connection name . . . . . \_\_\_\_\_  
 Transmission queue . . . . . \_\_\_\_\_  
 LU6.2 mode name . . . . . \_\_\_\_\_  
 LU6.2 TP name . . . . . \_\_\_\_\_

Command ==> \_\_\_\_\_  
 F1=Help    F2=Split    F3=Exit    F7=Bkwd    F8=Fwd    F9=Swap  
 F10=Messages F12=Cancel

Define a Sender Channel

Press F7 or F8 to see other fields, or Enter to define channel.

More: - +

MCA user ID . . . . . \_\_\_\_\_

Nonpersistent messages . . . F F=Fast,N=Normal  
 Maximum message length . . . 4194304    0 - 4194304  
 Batch size . . . . . 50    1 - 9999  
 Sequence number wrap . . . . 999999999    100 - 999999999  
 Heartbeat interval . . . . . 300    0 - 999999 seconds

Command ==> \_\_\_\_\_  
 F1=Help    F2=Split    F3=Exit    F7=Bkwd    F8=Fwd    F9=Swap  
 F10=Messages F12=Cancel

```

Define a Sender Channel

Press F7 or F8 to see other fields, or Enter to define channel.

More: - +

Disconnect interval . . . . . 6000          0 - 999999 seconds
Batch interval . . . . . 0                0 - 999999999 milliseconds
Short retry interval . . . . . 60         0 - 999999999 seconds
Short retry count . . . . . 10           0 - 999999999
Long retry interval . . . . . 1200       0 - 999999999 seconds
Long retry count . . . . . 999999999    0 - 999999999

Conversion by sender . . . . . N Y=Yes,N=No

Command ==> _____
F1=Help   F2=Split   F3=Exit   F7=Bkwd   F8=Fwd   F9=Swap
F10=Messages F12=Cancel

```

```

Define a Sender Channel

Press F7 to see previous fields, or Enter to define channel.

More: -

Security exit name . . . . . _____
User data . . . . . _____

Send exit name . . . . . _____
User data . . . . . _____

Receive exit name . . . . . _____
User data . . . . . _____

Message exit name . . . . . _____
User data . . . . . _____

Command ==> _____
F1=Help   F2=Split   F3=Exit   F7=Bkwd   F8=Fwd   F9=Swap
F10=Messages F12=Cancel

```

## Defining a receiver channel when not using CICS

1. From ISPF, access the MQSeries main menu.
2. Specify an **Action** of 2, an **Object type** of CHLRECEIVER, and specify a **Name** for the channel.
3. Press Enter.

The first Define a Receiver Channel panel is displayed. There are two panels in all. Set the parameter values as indicated.

## OS/390 configuration

```

Define a Receiver Channel

Complete fields, then press F8 for further fields, or Enter to define channel.

More: +

Channel name . . . . . OS2.MVS.SNA
Description . . . . . _____
                                     _____

Put authority . . . . . D D=Default,C=Context,M=MCAuser

Command ==> _____
F1=Help      F2=Split    F3=Exit      F7=Bkwd      F8=Fwd      F9=Swap
F10=Messages F12=Cancel

```

```

Define a Receiver Channel

Press F7 or F8 to see other fields, or Enter to define channel.

More: - +

MCA user ID . . . . . _____

Nonpersistent messages . . . F F=Fast,N=Normal
Maximum message length . . . 4194304      0 - 4194304
Batch size . . . . . 50                  1 - 9999
Sequence number wrap . . . 999999999      100 - 999999999
Heartbeat interval . . . . 300            0 - 999999 seconds

Command ==> _____
F1=Help      F2=Split    F3=Exit      F7=Bkwd      F8=Fwd      F9=Swap
F10=Messages F12=Cancel

```

```

Define a Receiver Channel

Press F7 to see previous fields, or Enter to define channel.

More: -

Security exit name . . . . . _____
User data . . . . . _____

Send exit name . . . . . _____
User data . . . . . _____

Receive exit name . . . . . _____
User data . . . . . _____

Message exit name . . . . . _____
User data . . . . . _____

Command ==> _____
F1=Help    F2=Split  F3=Exit    F7=Bkwd   F8=Fwd    F9=Swap
F10=Messages F12=Cancel

```

## Defining a sender channel using CICS

1. Run the CICS transaction CKMC. Select **Edit** and then **Create**. A pop-up window appears.
2. Specify a **Channel name** and a **Channel type**.
3. Press Enter.  
The Settings panel, which spans two screens, is displayed.
4. Complete the parameter fields as indicated. In particular, specify the **Transmission queue name**, **Connection name**, and **LU62 TP name**. Allow the other fields to default.

```

Channel          Help
-----
MCATTB1          MVS.OS2.CICS - Settings          MVSLU

More: +

Channel type . . . . . : SENDER

Target system id . . . . . :
Transmission queue name . . : OS2
Batch size . . . . . : 0001
Sequence number wrap . . . : 0999999999
Max message size . . . . . : 0032000
Max transmission . . . . . : 32000
Disconnect interval . . . . : 0001
Transaction id . . . . . : CKSG
Connection name . . . . . : <CICS connection to target, defined in CEDA>
CICS profile name . . . . . :
LU62 TP name . . . . . : MQSERIES

F1=Help  F3=Exit  F5=Refresh now  F7=Bkwd  F8=Fwd  F10=Menu Bar
F12=Cancel

```

## OS/390 configuration

```

Channel          Help
-----
MCATTC1          MVS.OS2.CICS - Settings          MVSLU

More: -

Channel type . . . . . : SENDER

Sequential delivery . . . : 0 (0=No or 1=Yes)

Retry
Count . . . . . : 005
Fast interval . . . . . : 005
Slow interval . . . . . : 030

Exit routines
Security . . . . . :
Message . . . . . :
Send . . . . . :
Receive . . . . . :

F1=Help  F3=Exit  F5=Refresh now  F7=Bkwd  F8=Fwd  F10=Menu Bar
F12=Cancel

```

## Defining a receiver channel using CICS

1. Run the CICS transaction CKMC. Select **Edit** and then **Create**. A pop-up window appears.

```

Selected        Edit          View          Help
-----
MCSELB          IBM MQSeries for OS/390 Message Channel List          MVSLU

Select a channel name. Then select an action.

More:

Channel name    Type      Sysid
MVS.OS2.CICS   SENDER   HUR1

(C) Copyright IBM Corporation 1993, 1999. All rights reserved.

F1=Help  F3=Exit  F5=Refresh now  F6=Find  F7=Bkwd  F8=Fwd  F10=Menu Bar
F12=Cancel

```

2. Specify a **Channel name** and a **Channel type**.
3. Press Enter.  
The Settings panel, which spans two screens, is displayed.
4. Set the parameter values as indicated. In particular, if translation is required, set the **Message** field of the Exit routines section.



```

Channel          Help
-----
MCATTB3          OS2.MVS.CICS - Settings          MVSLU

Channel type . . . . . : RECEIVER
Target system id . . . . . :
Batch size . . . . . : 0001
Sequence number wrap . . . : 0999999999
Max message size . . . . . : 0032000
Max transmission . . . . . : 32000

F1=Help  F3=Exit  F5=Refresh now  F7=Bkwd  F8=Fwd  F10=Menu Bar
F12=Cancel
    
```

```

Channel          Help
-----
MCATTC3          OS2.MVS.CICS - Settings          MVSLU

Channel type . . . . . : RECEIVER
Sequential delivery . . . . : 0  (0=No or 1=Yes)
Put authority . . . . . : 1  (1=Process or 2=Context)

Exit routines
Security . . . . . :
Message . . . . . :
Send . . . . . :
Receive . . . . . :

F1=Help  F3=Exit  F5=Refresh now  F7=Bkwd  F8=Fwd  F10=Menu Bar
F12=Cancel
    
```



---

## Part 5. DQM in MQSeries for AS/400

<b>Chapter 30. Monitoring and controlling channels in MQSeries for AS/400</b> . . . . .	423
The DQM channel control function . . . . .	423
Operator commands . . . . .	424
Getting started . . . . .	426
Creating objects . . . . .	426
Creating a channel . . . . .	426
Starting a channel . . . . .	429
Selecting a channel . . . . .	430
Browsing a channel . . . . .	430
Renaming a channel . . . . .	432
Work with channel status . . . . .	432
Work-with-channel choices . . . . .	434
Panel choices . . . . .	435
F6=Create . . . . .	435
2=Change . . . . .	436
3=Copy . . . . .	436
4=Delete . . . . .	437
5=Display . . . . .	437
8=Work with Status . . . . .	437
13=Ping . . . . .	437
Ping with LU 6.2 . . . . .	437
14=Start . . . . .	437
15=End . . . . .	438
Stop immediate . . . . .	439
Stop controlled . . . . .	439
16=Reset . . . . .	439
17=Resolve . . . . .	439
<b>Chapter 31. Preparing MQSeries for AS/400</b> . . . . .	441
Creating a transmission queue . . . . .	441
Triggering channels . . . . .	443
Channel programs . . . . .	445
Channel states on OS/400 . . . . .	446
Other things to consider . . . . .	447
Undelivered-message queue . . . . .	447
Queues in use . . . . .	447
Maximum number of channels . . . . .	447
Multiple message channels per transmission queue . . . . .	447
Security of MQSeries for AS/400 objects . . . . .	447
System extensions and user-exit programs . . . . .	448
<b>Chapter 32. Setting up communication for MQSeries for AS/400</b> . . . . .	449
Deciding on a connection . . . . .	449
Defining a TCP connection . . . . .	449
Receiving on TCP . . . . .	450
Using the TCP SO_KEEPALIVE option . . . . .	450
Using the TCP listener backlog option . . . . .	450
Defining an LU 6.2 connection . . . . .	451
Initiating end (Sending) . . . . .	452
Initiated end (Receiver) . . . . .	455
Note on Work Management . . . . .	457
<b>Chapter 33. Example configuration - IBM MQSeries for AS/400</b> . . . . .	459
Configuration parameters for an LU 6.2 connection . . . . .	459
Configuration worksheet . . . . .	459
Explanation of terms . . . . .	462
How to find network attributes . . . . .	463
How to find the value of Resource name . . . . .	463
Establishing an LU 6.2 connection . . . . .	464
Local node configuration . . . . .	464
Creating a line description . . . . .	464
Adding a routing entry . . . . .	465
Connection to partner node . . . . .	465
Creating a controller description . . . . .	465
Creating a device description . . . . .	466
Creating CPI-C side information . . . . .	467
Adding a communications entry for APPC . . . . .	468
Adding a configuration list entry . . . . .	468
What next? . . . . .	469
Establishing a TCP connection . . . . .	469
Adding a TCP/IP interface . . . . .	469
Adding a TCP/IP loopback interface . . . . .	469
Adding a default route . . . . .	470
What next? . . . . .	470
MQSeries for AS/400 configuration . . . . .	471
Basic configuration . . . . .	471
Channel configuration . . . . .	471
MQSeries for AS/400 sender-channel definitions using SNA . . . . .	474
MQSeries for AS/400 receiver-channel definitions using SNA . . . . .	474
MQSeries for AS/400 sender-channel definitions using TCP . . . . .	475
MQSeries for AS/400 receiver-channel definitions using TCP . . . . .	475
Defining a queue . . . . .	475
Defining a channel . . . . .	476
<b>Chapter 34. Message channel planning example for OS/400</b> . . . . .	477
What the example shows . . . . .	477
Queue manager QM1 example . . . . .	478
Queue manager QM2 example . . . . .	480
Running the example . . . . .	482
Expanding this example . . . . .	482

This part of the book describes the MQSeries distributed queue management function for MQSeries for AS/400.

## DQM in MQSeries for AS/400

---

## Chapter 30. Monitoring and controlling channels in MQSeries for AS/400

Use the DQM commands and panels to create, monitor, and control the channels to remote queue managers. Each queue manager has a DQM program for controlling interconnections to compatible remote queue managers. See “Operator commands” on page 424 for a list of the commands you need when setting up and controlling message channels.

---

### The DQM channel control function

The channel control function provides the interface and function for administration and control of message channels between MQSeries for AS/400 and compatible systems. See Figure 28 on page 58 for a conceptual picture.

The channel control function consists of MQSeries for AS/400 panels, commands, programs, a sequence number file, and a file for the channel definitions. The following is a brief description of the components of the channel control function:

- The channel definition file (CDF):
  - Is indexed on channel name
  - Holds channel definitions
- The channel commands are a subset of the MQSeries for AS/400 set of commands.

Use the command GO CMDMQM to display the full set of MQSeries for AS/400 commands.

- You use channel definition panels, or commands to:
  - Create, copy, display, change, and delete channel definitions
  - Start and stop channels, ping, reset channel sequence numbers, and resolve in-doubt messages when links cannot be re-established
  - Display status information about channels
- Sequence numbers and *logical unit of work (LUW)* identifiers are stored in the synchronization file, and are used for channel synchronization purposes.

### Operator commands

The following table shows the full list of MQSeries for AS/400 commands that you may need when setting up and controlling channels. In general, issuing a command results in the appropriate panel being displayed.

The commands can be grouped as follows:

- Channel commands
  - CHGMQMCHL, Change MQM Channel
  - CPYMQMCHL, Copy MQM Channel
  - CRTMQMCHL, Create MQM Channel
  - DLTMQMCHL, Delete MQM Channel
  - DSPMQMCHL, Display MQM Channel
  - ENDMQMCHL, End MQM Channel
  - ENDMQMLSR, End MQM Listener
  - PNGMQMCHL, Ping MQM Channel
  - RSTMQMCHL, Reset MQM Channel
  - RSVMQMCHL, Resolve MQM Channel
  - STRMQMCHL, Start MQM Channel
  - STRMQMCHLI, Start MQM Channel Initiator
  - STRMQMLSR, Start MQM Listener
  - WRKMQMCHL, Work with MQM Channel
  - WRKMQMCHST, Work with MQM Channel Status
- Cluster commands
  - RFRMQMCL, Refresh Cluster
  - RSMMQMCLQM, Resume Cluster Queue Manager
  - RSTMQMCL, Reset Cluster
  - SPDMQMCLQM, Suspend Cluster Queue Manager
  - WRKMQMCL, Work with Clusters
- Command Server commands
  - DSPMQMCSVR, Display MQM Command Server
  - ENDMQMCSVR, End MQM Command Server
  - STRMQMCSVR, Start MQM Command Server
- Data Type Conversion Command
  - CVTMQMMDTA, Convert MQM Data Type Command
- Dead-Letter Queue Handler Command
  - STRMQMDLQ, Start MQSeries Dead-Letter Queue Handler
- Media Recovery Commands
  - RCDMQMIMG, Record MQM Object Image
  - RCRMQMOBJ, Recreate MQM Object
- MQSeries command
  - STRMQMMQSC, Start MQSC Commands
- Name command
  - DSPMQMOBJN, Display MQM Object Names
- Namelist commands
  - CHGMQMNL, Change MQM Namelist
  - CPYMQMNL, Copy MQM Namelist
  - CRTMQMNL, Create MQM Namelist
  - DLTMQMNL, Delete MQM Namelist
  - DSPMQMNL, Display MQM Namelist
  - WRKMQMNL, Work with MQM Namelists
- Process commands
  - CHGMQMPRC, Change MQM Process

- CPYMQMPCR, Copy MQM Process
- CRTMQMPCR, Create MQM Process
- DLTMQMPCR, Delete MQM Process
- DSPMQMPCR, Display MQM Process
- WRKMQMPCR, Work with MQM Processes
- Queue commands
  - CHGMQM, Change MQM Queue
  - CLRMQM, Clear MQM Queue
  - CPYMQM, Copy MQM Queue
  - CRTMQM, Create MQM Queue
  - DLTMQM, Delete MQM Queue
  - DSPMQM, Display MQM Queue
  - WRKMQMMSG, Work with MQM Messages
  - WRKMQM, Work with MQM Queues
- Queue Manager commands
  - CCTMQM, Connect Message Queue Manager
  - CHGMQM, Change Message Queue Manager
  - CRTMQM, Create Message Queue Manager
  - DLTMQM, Delete Message Queue Manager
  - DSCMQM, Disconnect Message Queue Manager
  - DSPMQM, Display Message Queue Manager
  - ENDMQM, End Message Queue Manager
  - STRMQM, Start Message Queue Manager
  - WRKMQM, Work with Message Queue managers
- Security commands
  - DSPMQMAUT, Display MQM Object Authority
  - GRTMQMAUT, Grant MQM Object Authority
  - RVKMMAUT, Revoke MQM Object Authority
- Trace commands
  - TRCMQM, Trace MQM Job
- Transaction commands
  - RSVMQMTRN, Resolve MQSeries Transaction
  - WRKMQMTRN, Display MQSeries Transaction
- Trigger Monitor commands
  - STRMQMTRM, Start Trigger Monitor

### Getting started

Use these commands and panels to:

1. Define message channels and associated objects
2. Monitor and control message channels

By using the F4=Prompt key, you can specify the relevant queue manager. If you do not use the prompt, the default queue manager is assumed. With F4=Prompt, an additional panel is displayed where you may enter the relevant queue manager name and sometimes other data.

The objects you need to define with the panels are:

- Transmission queues
- Remote queue definitions
- Queue manager alias definitions
- Reply-to queue alias definitions
- Reply-to local queues
- Processes for triggering (MCAs)
- Message channel definitions

See “Chapter 2. Making your applications communicate” on page 17 for more discussion on the concepts involved in the use of these objects.

Channels must be completely defined, and their associated objects must exist and be available for use, before a channel can be started. This chapter shows you how to do this.

In addition, the particular communication link for each channel must be defined and available before a channel can be run. For a description of how LU 6.2 and TCP/IP links are defined, see the particular communication guide for your installation as listed in “Related publications” on page 662.

---

### Creating objects

Use the CRTMQMQ command to create the queue and alias objects, such as: transmission queues, remote queue definitions, queue manager alias definitions, reply-to queue alias definitions, and reply-to local queues.

For a list of default objects, see the *MQSeries for AS/400 V5.1 System Administration* book.

---

### Creating a channel

To create a new channel:

1. Use F6 from the Work with MQM Channels panel (the second panel that displays channel details).

Alternatively, use the CRTMQMCHL command from the command line.

Either way, this displays the Create Channel panel. Type:

- The name of the channel in the field provided
- The channel type for this end of the link

2. Press Enter.

**Note:** You are strongly recommended to name all the channels in your network uniquely. As shown in Table 1 on page 30, including the source and target queue manager names in the channel name is a good way to do this.



## Creating a channel

Your entries are validated and errors are reported immediately. Correct any errors and continue.

You are presented with the appropriate channel settings panel for the type of channel you have chosen. Fill in the fields with the information you have gathered previously. See “Appendix A. Channel planning form” on page 623 for an example of how you might want to gather information. Press Enter to create the channel.

You are provided with help in deciding on the content of the various fields in the descriptions of the channel definition panels in the help panels, and in “Chapter 6. Channel attributes” on page 77.

```

                                Create MQM Channel (CRTMQMCHL)

Type choices, press Enter.

Channel name . . . . . > CHANNAME_____
Channel type . . . . . > *SDR_____ *RCVR, *SDR, *SVR, *RQSTR...
Message Queue Manager name      *DFT_____

Replace . . . . . *NO_____ *NO, *YES
Transport type . . . . . *TCP_____ *LU62, *TCP, *SYSDFTCHL
Text 'description' . . . . . > 'Example Channel Definition'_____

Connection name . . . . . *SYSDFTCHL_____
_____
_____
_____
_____
_____
_____
_____
More...
F3=Exit  F4=Prompt  F5=Refresh  F12=Cancel  F13=How to use this display
F24=More keys
```

Figure 92. Create channel (1)

## Creating a channel

```

Create MQM Channel (CRTMQMCHL)

Type choices, press Enter.

Transmission queue . . . . . 'TRANSMISSION_QUEUE_NAME' _____
Message channel agent . . . . . *NONE_____ Name, *SYSDFTCHL, *NONE
Library . . . . . _____ Name
Message channel agent user ID . . *SYSDFTCHL_ Character value...
Coded Character Set Identifier . *SYSDFTCHL_ 0-9999, *SYSDFTCHL
Batch size . . . . . 50_____ 1-9999, *SYSDFTCHL
Disconnect interval . . . . . 6000_____ 1-999999, *SYSDFTCHL
Short retry interval . . . . . 60_____ 0-999999999, *SYSDFTCHL
Short retry count . . . . . 10_____ 0-999999999, *SYSDFTCHL
Long retry interval . . . . . 1200_____ 0-999999999, *SYSDFTCHL
Long retry count . . . . . 999999999_ 0-999999999, *SYSDFTCHL
Security exit . . . . . *NONE_____ Name, *SYSDFTCHL, *NONE
Library . . . . . _____ Name
Security exit user data . . . . . *SYSDFTCHL_____

More...
F3=Exit F4=Prompt F5=Refresh F12=Cancel F13=How to use this display
F24=More keys

```

Figure 93. Create channel (2)

```

Create MQM Channel (CRTMQMCHL)

Type choices, press Enter.

Send exit . . . . . *NONE_____ Name, *SYSDFTCHL, *NONE
Library . . . . . _____ Name
+ for more values
Send exit user data . . . . . _____
+ for more values
Receive exit . . . . . *NONE_____ Name, *SYSDFTCHL, *NONE
Library . . . . . _____ Name
+ for more values
Receive exit user data . . . . . _____
+ for more values
Message exit . . . . . *NONE_____ Name, *SYSDFTCHL, *NONE
Library . . . . . _____ Name
+ for more values

More...
F3=Exit F4=Prompt F5=Refresh F12=Cancel F13=How to use this display
F24=More keys

```

Figure 94. Create channel (3)

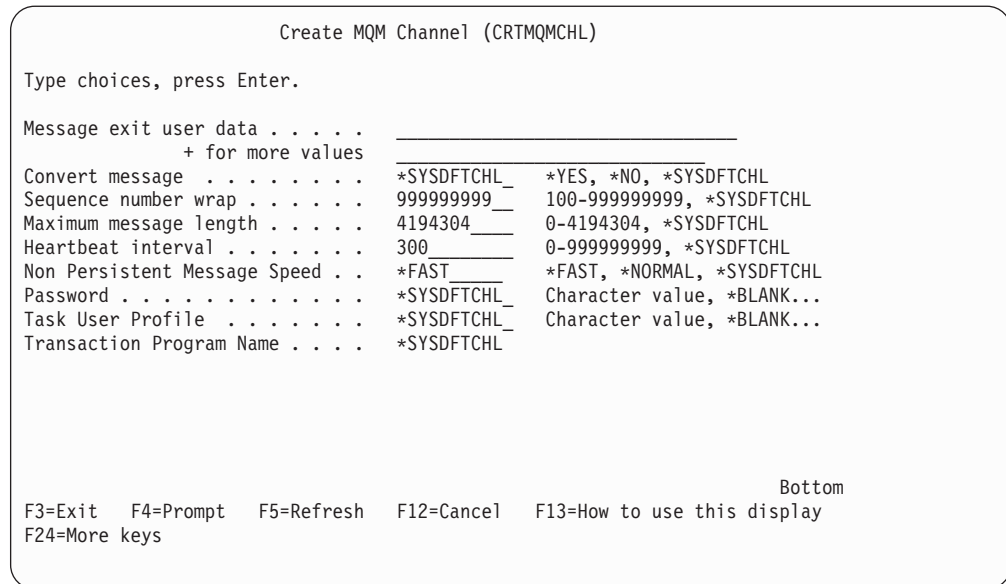

Figure 95. Create channel (4)

## Starting a channel

Listeners are valid for TCP only. For SNA listeners, you must configure your communications subsystem.

For applications to be able to exchange messages you must start a listener program for inbound connections using the STRMQMLSR command.

For outbound connections you must start the channel in one of the following ways:

1. Use the CL command STRMQMCHL, specifying the channel name, to start the channel as a process or a thread, depending on the MCATYPE parameter. (If channels are started as threads, they are threads of a channel initiator.)  
STRMQMCHL CHLNAME(QM1.TO.QM2) MQNAME(MYQMGR)
2. Use a channel initiator to trigger the channel. One channel initiator is started automatically when the queue manager is started. This can be eliminated by changing the chinit stanza in the qm.ini file for that queue manager.
3. Use the WRKMQMCHL command to begin the Work with Channels panel and choose option 14 to start a channel.

## Selecting a channel

### Selecting a channel

To select a channel, use the WRKMQMCHL command to begin at the Work with Channels panel:

1. Move the cursor to the option field at the left of the required channel name.
2. Type an option number.
3. Press Enter to activate your choice.

If you select more than one channel, the options are activated in sequence.

```
Work with MQM Channels

Queue Manager Name . . . : CNX

Type options, press Enter.
  2=Change  3=Copy  4=Delete  5=Display  8=Work with Status  13=Ping
 14=Start 15=End 16=Reset 17=Resolve

Opt   Name                               Type      Transport  Status
-----
CHLNIC                                *RCVR     *TCP       INACTIVE
CORSAIR.TO.MUSTANG                    *SDR      *LU62      INACTIVE
FV.CHANNEL.MC.DJE1                     *RCVR     *TCP       INACTIVE
FV.CHANNEL.MC.DJE2                     *SDR      *TCP       INACTIVE
FV.CHANNEL.MC.DJE3                     *RQSTR    *TCP       INACTIVE
FV.CHANNEL.MC.DJE4                     *SVR      *TCP       INACTIVE
FV.CHANNEL.PETER                       *RCVR     *TCP       INACTIVE
FV.CHANNEL.PETER.LU                    *RCVR     *LU62      INACTIVE
FV.CHANNEL.PETER.LU1                   *RCVR     *LU62      INACTIVE

Parameters or command
===>
F3=Exit  F4=Prompt  F5=Refresh  F6=Create  F9=Retrieve  F12=Cancel
F21=Print
```

Figure 96. Work with channels

### Browsing a channel

To browse the settings of a channel, use the WRKMQMCHL command to begin at the Display Channel panel:

1. Move the cursor to the left of the required channel name.
2. Type option 5 (Display).
3. Press Enter to activate your choice.

If you select more than one channel, they are presented in sequence.

Alternatively, you can use the DSPMQMCHL command from the command line.

This results in the respective Display Channel panel being displayed with details of the current settings for the channel. The fields are described in “Chapter 6. Channel attributes” on page 77.

```

                                Display MQM Channel
Channel name . . . . . : ST.JST.2T01
Queue Manager Name . . . . . : QMREL
Channel type . . . . . : *SDR
Transport type . . . . . : *TCP
Text 'description' . . . . . : John's sender to WINSDOA1

Connection name . . . . . : MUSTANG

Transmission queue . . . . . : WINSDOA1

Message channel agent . . . . . :
  Library . . . . . :
Message channel agent user ID : *NONE
Batch interval . . . . . : 0
Batch size . . . . . : 50
Disconnect interval . . . . . : 6000

F3=Exit  F12=Cancel  F21=Print
  
```

Figure 97. Display a TCP/IP channel (1)

```

                                Display MQM Channel

Short retry interval . . . . . : 60
Short retry count . . . . . : 10
Long retry interval . . . . . : 6000
Long retry count . . . . . : 10
Security exit . . . . . :
  Library . . . . . :
Security exit user data . . . . . :
Send exit . . . . . :
  Library . . . . . :
Send exit user data . . . . . :
Receive exit . . . . . :
  Library . . . . . :
Receive exit user data . . . . . :
Message exit . . . . . :
  Library . . . . . :
Message exit user data . . . . . :

More...

F3=Exit  F12=Cancel  F21=Print
  
```

Figure 98. Display a TCP/IP channel (2)

## Renaming a channel

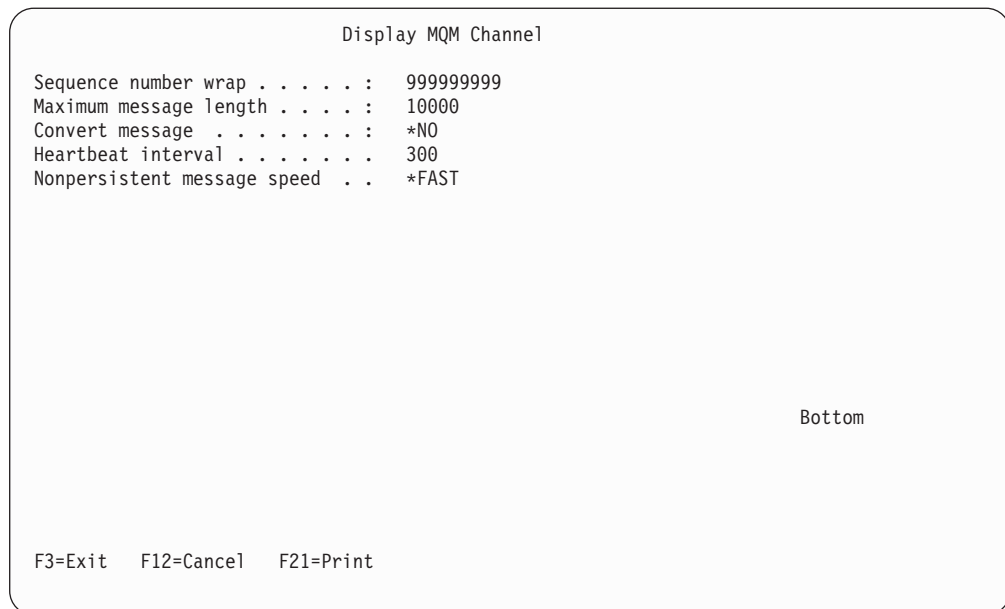

Figure 99. Display a TCP/IP channel (3)

---

## Renaming a channel

To rename a message channel, begin at the Work with Channels panel:

1. End the channel.
2. Use option 3 (Copy) to create a duplicate with the new name.
3. Use option 5 (Display) to check that it has been created correctly.
4. Use option 4 (Delete) to delete the original channel.

If you decide to rename a message channel, ensure that both channel ends are renamed at the same time.

---

## Work with channel status

Use the WRKMQMCHST command to bring up the first of three screens showing the status of your channels. You can view the three status screens in sequence when you select Change-view (F11).

Alternatively, selecting option 8 (Work with Status) from the Work with MQM Channels panel also brings up the first status panel.

Work with channel status applies to all message channels. It does not apply to MQI channels other than server-connection channels on MQSeries for AS/400 V5.1.

**Note:** The Work with Channel Status screens only show channels that are active after messages have been sent through the channel and the sequence number has been incremented.

```

MQSeries Work with Channel Status

Type options, press Enter.
 5=Display 13=Ping 14=Start 15=End 16=Reset 17=Resolve

Opt Name Connection Indoubt Last Seq
CARTS_CORSAIR_CHAN GBIBMIYA.WINSDOA1 NO 1
CHLNIC 9.20.2.213 NO 3
FV.CHANNEL.PETER2 9.20.2.213 NO 6225
JST.1.2 9.20.2.201 NO 28
MP_MUST_TO_CORS 9.20.2.213 NO 100
MUSTANG.TO.CORSAIR GBIBMIYA.WINSDOA1 NO 10
MP_CORS_TO_MUST 9.20.2.213 NO 101
JST.2.3 9.5.7.126 NO 32
PF_WINSDOA1_LU62 GBIBMIYA.IYA80020 NO 54
PF_WINSDOA1_LU62 GBIBMIYA.WINSDOA1 NO 500
ST.JCW.EXIT.2T01.CHL 9.20.2.213 NO 216

Bottom

Parameters or command
===>
F3=Exit F4=Prompt F5=Refresh F6=Create F9=Retrieve F11=Change view
F12=Cancel F21=Print

```

Figure 100. Channel status (1)

Change the view with F11.

```

MQSeries Work with Channel Status

Type options, press Enter.
 5=Display 13=Ping 14=Start 15=End 16=Reset 17=Resolve

Opt Transmission Queue LUWID
7516E58A40C000EC
7515A36C0D800157
7515E790AC8001CA
7516FF2284800009
75147C6629C0009D
7516DDE5778000A8
FV_MKP_TRANS_QUEUE 75147B61A44000FA
JST.3 75170185D0000133
PF.WINSDOA1 7516DA3955C00097
PF.WINSDOA1 7516DE2396C000BC
ST.JCW.EXIT.2T01.XMIT.QUEUE 7516C51291400016

Bottom

Parameters or command
===>
F3=Exit F4=Prompt F5=Refresh F6=Create F9=Retrieve F11=Change view
F12=Cancel F21=Print

```

Figure 101. Channel status (2)

## Work with channel status

```

MQSeries Work with Channel Status

Type options, press Enter.
 5=Display 13=Ping 14=Start 15=End 16=Reset 17=Resolve

Opt      Indoubt      Indoubt      Indoubt
         Msgs        Seq          LUWID
0         0          0          0000000000000000
0         0          0          0000000000000000
0         0          0          0000000000000000
0         0          0          0000000000000000
0         0          0          0000000000000000
0         0          0          0000000000000000
0         0          0          0000000000000000
0         101       75147B61A4400FA
0         0          32          75170185D0000133
0         0          54          7516DA3955C00097
0         0          500        7516DE2396C000BC
0         0          216        7516C51291400016

Parameters or command
===>
F3=Exit  F4=Prompt  F5=Refresh  F6=Create  F9=Retrieve  F11=Change view
F12=Cancel  F21=Print

Bottom

```

Figure 102. Channel status (3)

The options available in the Work with Channel Status panel are:

Menu option	Description
5=Display	Displays the channel settings.
13=Ping	Initiates a Ping action, where appropriate.
14=Start	Starts the channel.
15=End	Stops the channel.
16=Reset	Resets the channel sequence number.
17=Resolve	Resolves an in-doubt channel situation, manually.
F11=Change view	Cycles around the three status panels.

---

## Work-with-channel choices

The Work with Channels panel is reached with the command WRKMQMCHL, and it allows you to monitor the status of all channels listed, and to issue commands against selected channels.



The options available in the Work with Channel panel are:

Menu option	Description
F6=Create	Creates a channel.
2=Change	Changes the attributes of a channel.
3=Copy	Copies the attributes of a channel to a new channel.
4=Delete	Deletes a channel.
5=Display	Displays the current settings for the channel.
8=Work with status	Displays the channel status panels.
13=Ping	Runs the Ping facility to test the connection to the adjacent system by exchanging a fixed data message with the remote end.
14=Start	Starts the selected channel, or resets a disabled receiver channel.
15=End	Requests the channel to close down.
16=Reset	Requests the channel to reset the sequence numbers on this end of the link. The numbers must be equal at both ends for the channel to start.
17=Resolve	Requests the channel to resolve in-doubt messages without establishing connection to the other end.

## Panel choices

The following choices are provided in the Work with MQM channels panel and the Work with Channel Status panel.

### F6=Create

Use the Create option, or enter the CRTMQMCHL command from the command line, to obtain the Create Channel panel. There are examples of Create Channel panels, starting at Figure 92 on page 427.

With this panel, you create a new channel definition from a screen of fields filled with default values supplied by MQSeries for AS/400. Type the name of the channel, select the type of channel you are creating, and the communication method to be used.

When you press Enter, the panel is displayed. Type information in all the required fields in this panel, and the three pages making up the complete panel, and then save the definition by pressing Enter.

The channel name must be the same at both ends of the channel, and unique within the network. However, you should restrict the characters used to those that are valid for MQSeries for AS/400 object names; see “Chapter 6. Channel attributes” on page 77.

All panels have default values supplied by MQSeries for AS/400 for some fields. You can customize these values, or you can change them when you are creating or copying channels. To customize the values, see the *MQSeries for AS/400 System Administration*.

You can create your own set of channel default values by setting up dummy channels with the required defaults for each channel type, and copying them each time you want to create new channel definitions.

Table 38 on page 436 shows the channel attributes for each type of channel. See “Chapter 6. Channel attributes” on page 77 for details about the fields.

## Panel choices

Table 38. Channel attribute fields per message channel type

Attribute field	Sender	Server	Receiver	Requester
Batch size	✓	✓	✓	✓
Channel name	✓	✓	✓	✓
Channel type	✓	✓	✓	✓
Connection name	✓	✓		✓
Context			✓	✓
Disconnect interval	✓	✓		
Heartbeat interval	✓	✓	✓	✓
Long retry wait interval	✓	✓		
Long retry count	✓	✓		
Maximum message length	✓	✓	✓	✓
Message channel agent name				✓
Message exit user data	✓	✓	✓	✓
Message retry exit count			✓	✓
Message retry exit data			✓	✓
Message retry exit interval			✓	✓
Message retry exit name			✓	✓
Nonpersistent message speed	✓	✓	✓	✓
Receive exit	✓	✓	✓	✓
Receive exit user data	✓	✓	✓	✓
Security exit	✓	✓	✓	✓
Security exit user data	✓	✓	✓	✓
Send exit	✓	✓	✓	✓
Send exit user data	✓	✓	✓	✓
Sequence number wrap	✓	✓	✓	✓
Short retry wait interval	✓	✓		
Short retry count	✓	✓		
Transport type	✓	✓	✓	✓
Transmission queue	✓	✓		
Message exit	✓	✓	✓	✓

## 2=Change

Use the Change option, or the CHGMQMCHL command, to change an existing channel definition, except for the channel name. Simply type over the fields to be changed in the channel definition panel, and then save the updated definition by pressing Enter.

## 3=Copy

Use the Copy option, or the CPYMQMCHL command, to copy an existing channel. The Copy panel enables you to define the new channel name. However, you should restrict the characters used to those that are valid for MQSeries for AS/400 object names; see the *MQSeries for AS/400 System Administration*.

Press Enter on the Copy panel to display the details of current settings. You can change any of the new channel settings. Save the new channel definition by pressing Enter.

## 4=Delete

Use the Delete option to delete the selected channel. A panel is displayed to confirm or cancel your request.

## 5=Display

Use the Display option to display the current definitions for the channel. This choice displays the panel with the fields showing the current values of the parameters, and protected against user input.

## 8=Work with Status

The status column tells you whether the channel is active or inactive, and is displayed continuously in the Work with MQM Channels panel. Use option 8 (Work with Status) to see more status information displayed. Alternatively, this can be displayed from the command line with the WRKMQMCHST command. See “Work with channel status” on page 432.

- Channel name
- Communication connection name
- In-doubt status of channel (where appropriate)
- Last sequence number
- Transmission queue name (where appropriate)
- The in-doubt identifier (where appropriate)
- The last committed sequence number
- Logical unit of work identifier

## 13=Ping

Use the Ping option to exchange a fixed data message with the remote end. This gives some confidence to the system supervisor that the link is available and functioning.

Ping does not involve the use of transmission queues and target queues. It uses channel definitions, the related communication link, and the network setup.

It is available from sender and server channels, only. The corresponding channel is started at the far side of the link, and performs the start up parameter negotiation. Errors are notified normally.

The result of the message exchange is presented in the Ping panel for you, and is the returned message text, together with the time the message was sent, and the time the reply was received.

### Ping with LU 6.2

When Ping is invoked in MQSeries for AS/400, it is run with the USERID of the user requesting the function, whereas the normal way that a channel program is run is for the QMQM USERID to be taken for channel programs. The USERID flows to the receiving side and it must be valid on the receiving end for the LU 6.2 conversation to be allocated.

## 14=Start

The Start option is available for sender, server, and requester channels. It should not be necessary where a channel has been set up with queue manager triggering.

The Start option is also used for receiver channels that have a DISABLED or STOPPED status. Starting a receiver channel that is in DISABLED or STOPPED state resets the channel and allows it to be started from the remote channel.

## Panel choices

When started, the sending MCA reads the channel definition file and opens the transmission queue. A channel start-up sequence is executed, which remotely starts the corresponding MCA of the receiver or server channel. When they have been started, the sender and server processes await messages arriving on the transmission queue and transmit them as they arrive.

When you use triggering, you will need to start the continuously running trigger process to monitor the initiation queue. The STRMQMCHLI command can be used for this.

At the far end of a channel, the receiving process may be started in response to a channel startup from the sending end. The method of doing this is different for LU 6.2 and TCP/IP connected channels:

- LU 6.2 connected channels do not require any explicit action at the receiving end of a channel.
- TCP connected channels require a listener process to be running continuously. This process awaits channel startup requests from the remote end of the link and starts the process defined in the channel definitions for that connection. When the remote machine is an AS/400, you can use the STRMQMLSR command for this.

Use of the Start option always causes the channel to re-synchronize, where necessary.

For the start to succeed:

- Channel definitions, local and remote must exist. If there is no appropriate channel definition for a receiver or server-connection channel, a default one is created automatically if the channel is auto-defined. See “Channel auto-definition exit program” on page 516.
- The transmission queue must exist, be enabled for GETs, and have no other channels using it.
- MCAs, local and remote, must exist.
- The communication link must be available.
- The queue managers must be running, local and remote.
- The message channel must be inactive.

To transfer messages, remote queues and remote queue definitions **must** exist.

A message is returned to the panel confirming that the request to start a channel has been accepted. For confirmation that the Start process has succeeded, check the system log, or press F5 (refresh the screen).

## 15=End

Use the End option to request the channel to stop activity. The channel will not send any more messages until the operator starts the channel again. (For information about restarting stopped channels, see “Restarting stopped channels” on page 69.)

You can select the type of stop you require if you press F4 before Enter. You can choose IMMEDIATE, or CONTROLLED.

**Stop immediate**

Normally, this option should not be used. It terminates the channel process. The channel does not complete processing the current batch of messages, and cannot, therefore, leave the channel in doubt. In general, it is recommended that the operators use the controlled stop option.

**Stop controlled**

This choice requests the channel to close down in an orderly way; the current batch of messages is completed, and the syncpoint procedure is carried out with the other end of the channel.

**16=Reset**

The Reset option changes the message sequence number. Use it with care, and only after you have used the Resolve option to resolve any in-doubt situations. This option is available only at the sender or server channel. The first message starts the new sequence the next time the channel is started.

**17=Resolve**

Use the Resolve option when messages are held in-doubt by a sender or server, for example because one end of the link has terminated, and there is no prospect of it recovering. The Resolve option accepts one of two parameters: BACKOUT or COMMIT. Backout restores messages to the transmission queue, while Commit discards them.

The channel program does not try to establish a session with a partner. Instead, it determines the logical unit of work identifier (LUWID) which represents the in-doubt messages. It then issues, as requested, either:

- BACKOUT to restore the messages to the transmission queue; or
- COMMIT to delete the messages from the transmission queue.

For the resolution to succeed:

- The channel must be inactive
- The channel must be in doubt
- The channel type must be sender or server
- The channel definition, local, must exist
- The queue manager must be running, local

## Panel choices

---

## Chapter 31. Preparing MQSeries for AS/400

This chapter describes the MQSeries for AS/400 preparations required before DQM can be used. Communication preparations are described in “Chapter 32. Setting up communication for MQSeries for AS/400” on page 449.

Before a channel can be started, the transmission queue must be defined as described in this chapter, and must be included in the message channel definition.

In addition, where needed, the triggering arrangement must be prepared with the definition of the necessary processes and queues.

---

### Creating a transmission queue

You define a local queue with the Usage field attribute set to \*TMQ, for each sending message channel.

If you want to make use of remote queue definitions, use the same command to create a queue of type \*RMT, and Usage of \*NORMAL.

To create a transmission queue, use the CRTMQMQ command from the command line to present you with the first queue creation panel; see Figure 103.

```
                                Create MQM Queue (CRTMQMQ)
Type choices, press Enter.
Queue name . . . . .
Queue type . . . . . _____ *ALS, *LCL, *MDL, *RMT
Message Queue Manager name . . . *DFT_____
_____

                                                                    Bottom
F3=Exit  F4=Prompt  F5=Refresh  F12=Cancel  F13=How to use this display
F24=More keys                                                                    +
```

Figure 103. Create a queue (1)

Type the name of the queue and specify the type of queue that you wish to create: Local, Remote, or Alias. For a transmission queue, specify Local (\*LCL) on this panel and press Enter.

## Creating a transmission queue

You are presented with the second page of the Create MQM Queue panel; see Figure 104.

```

                                Create MQM Queue (CRTMQMQ)

Type choices, press Enter.

Queue name . . . . . > HURS.2.HURS.PRIORIT

Queue type . . . . . > *LCL          *ALS, *LCL, *MDL, *RMT
Message Queue Manager name . . . *DFT
Replace . . . . . *NO             *NO, *YES
Text 'description' . . . . . '
Put enabled . . . . . *YES        *SYSDFTQ, *NO, *YES
Default message priority . . . . 0          0-9, *SYSDFTQ
Default message persistence . . . *NO    *SYSDFTQ, *NO, *YES
Process name . . . . . '
Triggering enabled . . . . . *NO    *SYSDFTQ, *NO, *YES
Get enabled . . . . . *YES        *SYSDFTQ, *NO, *YES
Sharing enabled . . . . . *YES    *SYSDFTQ, *NO, *YES

More...
F3=Exit  F4=Prompt  F5=Refresh  F12=Cancel  F13=How to use this display
F24=More keys

```

Figure 104. Create a queue (2)

Change any of the default values shown. Press page down to scroll to the next screen; see Figure 105.

```

                                Create MQM Queue (CRTMQMQ)

Type choices, press Enter.

Default share option . . . . . *YES        *SYSDFTQ, *NO, *YES
Message delivery sequence . . . . *PTY    *SYSDFTQ, *PTY, *FIFO
Harden backout count . . . . . *NO        *SYSDFTQ, *NO, *YES
Trigger type . . . . . *FIRST      *SYSDFTQ, *FIRST, *ALL...
Trigger depth . . . . . 1          1-999999999, *SYSDFTQ
Trigger message priority . . . . 0          0-9, *SYSDFTQ
Trigger data . . . . . '
Retention interval . . . . . 999999999 0-999999999, *SYSDFTQ
Maximum queue depth . . . . . 5000    1-24000, *SYSDFTQ
Maximum message length . . . . . 4194304 0-4194304, *SYSDFTQ
Backout threshold . . . . . 0        0-999999999, *SYSDFTQ
Backout requeue queue . . . . . '
Initiation queue . . . . . '

More...
F3=Exit  F4=Prompt  F5=Refresh  F12=Cancel  F13=How to use this display
F24=More keys

```

Figure 105. Create a queue (3)

Type \*TMQ, for transmission queue, in the Usage field of this panel, and change any of the default values shown in the other fields.



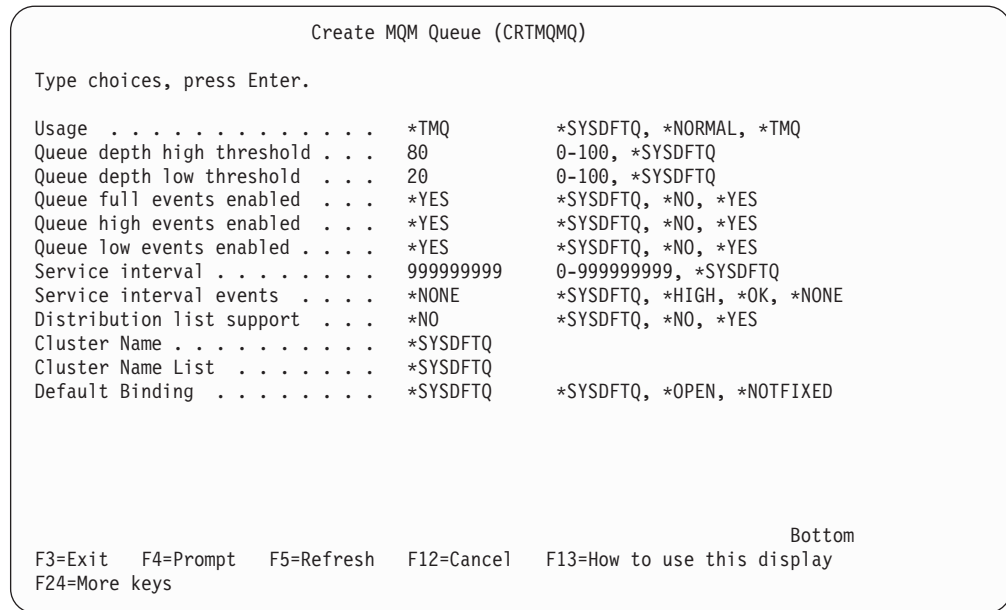

Figure 106. Create a queue (4)

When you are satisfied that the fields contain the correct data, press Enter to create the queue.

## Triggering channels

An overview of triggering is given in “Triggering channels” on page 20, while it is described in depth in the *MQSeries Application Programming Guide*. This section provides you with information specific to MQSeries for AS/400.

Triggering in MQSeries for AS/400 is implemented with the channel initiator process, which is started with the STRMQMCHLI command that specifies the name of the initiation queue. For example:

```
STRMQMCHLI QNAME(MYINITQ)
```

You need to set up the transmission queue for the channel specifying TRIGGER and specifying the channel name in the TRIGDATA field: For example:

```
CRTMQMQ QNAME(MYXMITQ) QTYPE(*LCL) MQMNAME(MYQMGR) +
        PRCNAME(MYPROCESS) TRGENBL(*YES) INITQNAME(MYINITQ) +
        USAGE(*TMQ)
```

Then define an initiation queue.

```
CRTMQMQ QNAME(MYINITQ) MQMNAME(MYQMGR)
```

Next you define a process in MQSeries for AS/400 naming the MCA sender program, as the program to be triggered when messages arrive on the transmission queue. Type CRTMQMPRC on the command line to display the Create Process panel. Alternatively, select F6 (Create) from the Work with MQM Process panel. See Figure 107 on page 444 for the first page of the Create Process panel. The *MQSeries for AS/400 System Administration* book contains details of defining processes to be triggered.

## Triggering channels

```
                                Create MQM Process (CRTMQMPCR)

Type choices, press Enter.

Process Name . . . . . _____

Message Queue Manager name . . . *DFT_____

Replace . . . . . *NO          *NO, *YES
Text 'description' . . . . . > 'Triggers hursley.to.hursley.normal '
Application type . . . . . *OS400
Application identifier . . . . . > 'AMQRMCLA

User data . . . . . > *SYSDFTPRC

F3=Exit  F4=Prompt  F5=Refresh  F12=Cancel  F13=How to use this display  More...
F24=More keys
```

Figure 107. Create process (1)

1. Type the name of the process definition in the field provided.
2. Enter a description in the **Text 'description'** field.
3. Set **Application type** to \*OS400.
4. Set **Application identifier** to AMQRMCLA.
5. Set **User data** to the channel name so as to associate this definition with the transmission queue belonging to the channel.
6. Page down to show the second page (see Figure 108 on page 445) and insert any environment data.

```

                                Create MQM Process (CRTMQMPRC)
Type choices, press Enter.
Environment data . . . . . *SYSDFTPRC _____
_____

                                                                 Bottom
F3=Exit  F4=Prompt  F5=Refresh  F12=Cancel  F13=How to use this display
F24=More keys
    
```

Figure 108. Create process (2)

## Channel programs

There are different types of channel programs (MCAs) available for use at the channels. The names are contained in the following table.

Table 39. Program and transaction names

Program name	Direction of connection	Communication
AMQCRSTA	Inbound	TCP
AMQCRS6A	Inbound	LU 6.2
AMQRMCLA	Outbound	Any

## Channel states on OS/400

Channel states are displayed on the Work with Channels panel (described in Figure 96 on page 430). There are some differences between the names of channel states on different versions of MQSeries for AS/400. In the following table, the state names shown for V4R2 correspond to the channel states described in Figure 30 on page 63. As shown in the table, some of these states have different names, or do not exist for earlier versions.

Table 40. Channel states on OS/400

State name (V3R6)	State name (V3R2, V3R7, V4R2, V5R1)	Meaning
-	STARTING	Channel is ready to begin negotiation with target MCA
BINDING	BINDING	Establishing a session and initial data exchange
REQUESTING	REQUESTING	Requester channel initiating a connection
READY	RUNNING	Transferring or ready to transfer
PAUSED	PAUSED	Waiting for message-retry interval
CLOSING	STOPPING	Establishing whether to retry or stop
RETRYING	RETRYING	Waiting until next retry attempt
DISABLED	STOPPED	Channel stopped because of an error or because an end-channel command is issued
STOPPED	INACTIVE	Channel ended processing normally or channel never started
-	*None	No state (for server-connection channels only)
<b>Note:</b> The state *None applies only to V3R2 and V3R7.		

---

## Other things to consider

Here are some other topics that you should consider when preparing MQSeries for distributed queue management.

### Undelivered-message queue

It is advisable that you have an application available to process the messages arriving on the undelivered-message queue (also known as the dead-letter queue or DLQ). The program could be triggered, or run at regular intervals. For more details, see the *MQSeries for AS/400 System Administration* and the *MQSeries Application Programming Guide*.

### Queues in use

MCAs for receiver channels may keep the destination queues open even when messages are not being transmitted; this results in the queues appearing to be “in use”.

### Maximum number of channels

You can specify the maximum number of channels allowed in your system and the maximum number that can be active at one time. You do this in the `qm.ini` file in directory `QIBM/UserData/mqm/qmgrs/queue manager name`. See “Appendix D. Configuration file stanzas for distributed queuing” on page 637.

### Multiple message channels per transmission queue

It is possible to define more than one channel per transmission queue, but only one of these channels can be active at any one time. This is recommended for the provision of alternative routes between queue managers for traffic balancing and link failure corrective action.

### Security of MQSeries for AS/400 objects

This section deals with remote messaging aspects of security.

You need to provide users with authority to make use of the MQSeries for AS/400 facilities, and this is organized according to actions to be taken with respect to objects and definitions. For example:

- Queue managers can be started and stopped by authorized users
- Applications need to connect to the queue manager, and have authority to make use of queues
- Message channels need to be created and controlled by authorized users

## Other things to consider

The message channel agent at a remote site needs to check that the message being delivered has derived from a user with authority to do so at this remote site. In addition, as MCAs can be started remotely, it may be necessary to verify that the remote processes trying to start your MCAs are authorized to do so. There are three possible ways for you to deal with this:

1. Decree in the channel definition that messages must contain acceptable *context* authority, otherwise they will be discarded.
2. Implement *user exit* security checking to ensure that the corresponding message channel is authorized. The security of the installation hosting the corresponding channel ensures that all users are properly authorized, so that you do not need to check individual messages.
3. Implement *user exit* message processing to ensure that individual messages are vetted for authorization.

Here are some facts about the way MQSeries for AS/400 operates security:

- Users are identified and authenticated by OS/400
- Queue manager services invoked by applications are run with the authority of the queue manager user profile, but in the user's process
- Queue manager services invoked by user commands are run with the authority of the queue manager user profile

## System extensions and user-exit programs

A facility is provided in the channel definition to allow extra programs to be run at defined times during the processing of messages. These programs are not supplied with MQSeries for AS/400, but may be provided by each installation according to local requirements.

In order to run, such programs must have predefined names and be available on call to the channel programs. The names of the exit programs are included in the message channel definitions.

There is a defined control block interface for handing over control to these programs, and for handling the return of control from these programs.

The precise places where these programs are called, and details of control blocks and names, are to be found in "Part 7. Further intercommunication considerations" on page 503.

---

## Chapter 32. Setting up communication for MQSeries for AS/400

DQM is a remote queuing facility for MQSeries for AS/400. It provides channel control programs for the MQSeries for AS/400 queue manager which form the interface to communication links, controllable by the system operator. The channel definitions held by distributed-queuing management use these communication links.

When a distributed-queuing management channel is started, it tries to use the connection specified in the channel definition. For this to succeed, it is necessary for the connection to be defined and available. This chapter explains how to do this.

---

### Deciding on a connection

There are two forms of communication between MQSeries for AS/400 systems:

- AS/400 TCP

For TCP, a host address may be used, and these connections are set up as described in the *OS/400 Communication Configuration Reference*.

In the TCP environment, each distributed service is allocated a unique TCP address which may be used by remote machines to access the service. The TCP address consists of a host name/number and a port number. All queue managers will use such a number to communicate with each other via TCP.

- AS/400 SNA (LU 6.2)

This form of communication requires the definition of an AS/400 SNA logical unit type 6.2 (LU 6.2) that provides the physical link between the AS/400 serving the local queue manager and the system serving the remote queue manager. Refer to the *OS/400 Communication Configuration Reference* for details on configuring communications in OS/400.

---

### Defining a TCP connection

The channel definition contains a field, CONNECTION NAME, that contains either the TCP network address of the target, in dotted decimal form (for example 9.20.9.30) or the host name (for example AS4HUR1). If the CONNECTION NAME is a host name, a name server or the AS/400 host table is used to convert the host name into a TCP host address.

A port number is required for a complete TCP address; if this is not supplied, the default port number 1414 is used. On the initiating end of a connection (sender, requester, and server channel types) it is possible to provide an optional port number for the connection, for example:

```
Connection name 9.20.9.30 (1555)
```

In this case the initiating end will attempt to connect to a receiving program at port 1555.

## Defining a TCP connection

### Receiving on TCP

Receiving channel programs are started in response to a startup request from the sending channel. To do this, a listener program has to be started to detect incoming network requests and start the associated channel. You start this listener program with the STRMQMLSR command.

You can start more than one listener for each queue manager. By default, the STRMQMLSR command uses port 1414 but you can override this. To override the default setting, add the following statements to the qm.ini file of the selected queue manager (in this example, the listener is required to use port 2500):

```
TCP:
  Port=2500
```

The qm.ini file is located in this IFS directory:  
`/QIBM/UserData/mqm/qmgrs/queue manager name`.

This new value is read only when the TCP listener is started. If you have a listener already running, this change is not be seen by that program. To use the new value, stop the listener and issue the STRMQMLSR command again. Now, whenever you use the STRMQMLSR command, the listener defaults to the new port.

Alternatively, you can specify a different port number on the STRMQMLSR command. For example:

```
STRMQMLSR MQMNAME(queue manager name) PORT(2500)
```

This change makes the listener default to the new port for the duration of the listener job.

#### Using the TCP SO\_KEEPALIVE option

If you want to use the SO\_KEEPALIVE option (as discussed in “Checking that the other end of the channel is still available” on page 66) you must add the following entry to your queue manager configuration file (qm.ini in the IFS directory, `/QIBM/UserData/mqm/qmgrs/queue manager name`):

```
TCP:
  KeepAlive=yes
```

You must then issue the following command:

```
CFGTCP
```

Select option 3 (Change TCP Attributes). You can now specify a time interval in minutes. You can specify a value in the range 1 through 40320 minutes; the default is 120.

#### Using the TCP listener backlog option

When receiving on TCP, a maximum number of outstanding connection requests is set. This can be considered a *backlog* of requests waiting on the TCP port for the listener to accept the request.

The default listener backlog value on AS/400 is 255. If the backlog reaches this value, the TCP connection is rejected and the channel will not be TCP: able to start.

For MCA channels, this results in the channel going into a RETRY state and retrying the connection at a later time.

For client connections, the client receives an MQRC\_Q\_MGR\_NOT\_AVAILABLE reason code from MQCONN and should retry the connection at a later time.



However, to avoid this error, you can add an entry in the `qm.ini` file:

```
ListenerBacklog = n
```

This overrides the default maximum number of outstanding requests (255) for the TCP listener.

**Note:** Some operating systems support a larger value than the default. If necessary, this can be used to avoid reaching the connection limit.

## Defining an LU 6.2 connection

In MQSeries for AS/400 V5.1, a mode name, TP name, and connection name of a fully-qualified LU 6.2 connection can be used.

For other versions of MQSeries for AS/400, a communications side information (CSI) object is required to define the LU 6.2 communications details for the sending end of a message channel. It is referred to in the CONNECTION NAME field of the Sender or Server channel definition for LU 6.2 connections. Further information on the communications side object is available in the *AS/400 APPC Communications Programmer's Guide*.

The initiated end of the link must have a routing entry definition to complement this CSI object. Further information on managing work requests from remote LU 6.2 systems is available in the *AS/400 Programming: Work Management Guide*.

See the *Multiplatform APPC Configuration Guide* and the following table for information.

Table 41. Settings on the local OS/400 system for a remote queue manager platform

Remote platform	TPNAME
OS/390 without CICS	The same as in the corresponding side information on the remote queue manager.
OS/390 using CICS	CKRC relates to a sender channel on the OS/400 system. CKSV relates to a requester channel on the OS/400 system. CKRC relates to a server channel on the OS/400 system.
OS/400	The same as the compare value in the routing entry on the OS/400 system.
OS/2	As specified in the OS/2 Run Listener command, or defaulted from the OS/2 queue manager configuration file.
Digital OVMS	As specified in the Digital OVMS Run Listener command.
Tandem NSK	The same as the TPNAME specified in the receiver-channel definition.
Other UNIX systems	The invocable Transaction Program defined in the remote LU 6.2 configuration.
Windows NT	As specified in the Windows NT Run Listener command, or the invocable Transaction Program that was defined using TpSetup on Windows NT.

If you have more than one queue manager on the same machine, ensure that the TPnames in the channel definitions are unique.

## Defining an LU 6.2 connection

### Initiating end (Sending)

Use the CRTMQMCHL command to define a channel of transport type \*LU62. For versions previous to MQSeries for AS/400 V5.1, define the name of the CSI object that this channel will use in the CONNECTION NAME field. (See “Creating a channel” on page 426 for details of how to do this.) Use of the CSI object is optional in MQSeries for AS/400 V5.1.

The initiating end panel is shown in Figure Figure 109. You press F10 from the first panel displayed to obtain the complete panel as shown.

```

                                Create Comm Side Information (CRTCSI)

Type choices, press Enter.

Side information . . . . . > WINSDOA1      Name
Library . . . . . > QSYS                Name, *CURLIB
Remote location . . . . . > WINSDOA1     Name
Transaction program . . . . . > MQSERIES

Text 'description' . . . . . *BLANK

                                Additional Parameters

Device . . . . . *LOC                    Name, *LOC
Local location . . . . . *LOC            Name, *LOC, *NETATR
Mode . . . . . JSTMOD92                  Name, *NETATR
Remote network identifier . . . *LOC     Name, *LOC, *NETATR, *NONE
Authority . . . . . *LIBCRTAUT           Name, *LIBCRTAUT, *CHANGE...

                                Bottom
F3=Exit  F4=Prompt  F5=Refresh  F12=Cancel  F13=How to use this display
F24=More keys
```

Figure 109. LU 6.2 communication setup panel - initiating end

Complete the initiating end fields as follows:

#### Side information

Give this definition a name that will be used to store the side information object to be created, for example, WINSDOA1.

**Note:** For LU 6.2, the link between the message channel definition and the communication connection is the **Connection name** field of the message channel definition at the sending end. This field contains the name of the CSI object.

#### Library

The name of the library where this definition will be stored.

The CSI object must be available in a library accessible to the program serving the message channel, for example, QSYS, QMQM, and QGPL.

If the name is incorrect, missing, or cannot be found then an error will occur on channel start up.

#### Remote location

Specifies the remote location name with which your program communicates.

## Defining an LU 6.2 connection

In short, this required parameter contains the logical unit name of the partner at the remote system, as defined in the device description that is used for the communication link between the two systems.

The **Remote location** name can be found by issuing the command DSPNETA on the remote system and seeing the default local location name.

### Transaction program

Specifies the name (up to 64 characters) of the transaction program on the remote system to be started. It may be a transaction process name, a program name, the channel name, or a character string that matches the **Compare value** in the routing entry.

This is a required parameter.

**Note:** To specify SNA service transaction program names, enter the hexadecimal representation of the service transaction program name. For example, to specify a service transaction program name whose hexadecimal representation is 21F0F0F1, you would enter X'21F0F0F1'.

More information on SNA service transaction program names is in the *SNA Transaction Programmer's Reference* manual for LU Type 6.2.

If the receiving end is another OS/400 system, the **Transaction program** name is used to match the CSI object at the sending end with the routing entry at the receiving end. This should be unique for each queue manager on the target OS/400 system. (See the **Program to call** parameter under "Initiated end (Receiver)" on page 455.) See also the **Comparison data: compare value** parameter in the Add Routing Entry panel.

### Text description

A description (up to 50 characters) to remind you of the intended use of this connection.

### Device

Specifies the name of the device description used for the remote system. The possible values are:

**\*LOC** The device is determined by the system.

#### Device-name

Specify the name of the device that is associated with the remote location.

### Local location

Specifies the local location name. The possible values are:

**\*LOC** The local location name is determined by the system.

#### \*NETATR

The LCLLOCNAME value specified in the system network attributes is used.

#### Local-location-name

Specify the name of your location. Specify the local location if you want to indicate a specific location name for the remote location. The location name can be found by using the DSPNETA command.

## Defining an LU 6.2 connection

**Mode** Specifies the mode used to control the session. This name is the same as the Common Programming Interface (CPI)- Communications Mode\_Name. The possible values are:

**\*NETATR**

The mode in the network attributes is used.

**BLANK**

Eight blank characters are used.

**Mode-name**

Specify a mode name for the remote location.

**Note:** Because the mode determines the transmission priority of the communications session, it may be useful to define different modes depending on the priority of the messages being sent; for example MQMODE\_HI, MQMODE\_MED, and MQMODE\_LOW. (You can have more than one CSI pointing to the same location.)

**Remote network identifier**

Specifies the remote network identifier used with the remote location. The possible values are:

**\*LOC** The remote network ID for the remote location is used.

**\*NETATR**

The remote network identifier specified in the network attributes is used.

**\*NONE**

The remote network has no name.

**Remote-network-id**

Specify a remote network ID. Use the DSPNETA command at the remote location to find the name of this network ID. It is the 'local network ID' at the remote location.

**Authority**

Specifies the authority you are giving to users who do not have specific authority to the object, who are not on an authorization list, and whose group profile has no specific authority to the object. The possible values are:

**\*LIBCRTAUT**

Public authority for the object is taken from the CRTAUT parameter of the specified library. This value is determined at create time. If the CRTAUT value for the library changes after the object is created, the new value does not affect existing objects.

**\*CHANGE**

Change authority allows the user to perform basic functions on the object, however, the user cannot change the object. Change authority provides object operational authority and all data authority.

**\*ALL**

The user can perform all operations except those limited to the owner or controlled by authorization list management authority. The user can control the object's existence and specify the security for the object, change the object, and perform basic functions on the object. The user can change ownership of the object.

## Defining an LU 6.2 connection

**\*USE** Use authority provides object operational authority and read authority.

**\*EXCLUDE**

Exclude authority prevents the user from accessing the object.

**Authorization-list**

Specify the name of the authorization list whose authority is used for the side information.

### Initiated end (Receiver)

Use the CRTMQMCHL command to define the receiving end of the message channel link with transport type \*LU62. Leave the CONNECTION NAME field blank and ensure that the corresponding details match the sending end of the channel. (See “Creating a channel” on page 426 for details of how to do this.)

To enable the initiating end to start the receiving channel, add a routing entry to a subsystem at the initiated end. The subsystem must be the one that allocates the APPC device used in the LU 6.2 sessions and, therefore, it must have a valid communications entry for that device. The routing entry calls the program that starts the receiving end of the message channel.

Use the OS/400 commands (for example, ADDRTGE) to define the end of the link that is initiated by a communication session.

The initiated end panel is shown in Figure Figure 110.

```

                                Add Routing Entry (ADDRTGE)

Type choices, press Enter.

Subsystem description . . . . . QCMN           Name
Library . . . . . *LIBL           Name, *LIBL, *CURLIB
Routing entry sequence number . 1           1-9999
Comparison data:
Compare value . . . . . MQSERIES

Starting position . . . . . 37           1-80
Program to call . . . . . AMQCRC6A       Name, *RTGDTA
Library . . . . . QMQMBW           Name, *LIBL, *CURLIB
Class . . . . . *SBSD           Name, *SBSD
Library . . . . . *LIBL           Name, *LIBL, *CURLIB
Maximum active routing steps . . *NOMAX       0-1000, *NOMAX
Storage pool identifier . . . . 1           1-10

                                                    Bottom
F3=Exit  F4=Prompt  F5=Refresh  F12=Cancel  F13=How to use this display
F24=More keys
```

Figure 110. LU 6.2 communication setup panel - initiated end

### Subsystem description

The name of your subsystem where this definition resides. Use the OS/400 WRKSBSD command to view and update the appropriate subsystem description for the routing entry.

## Defining an LU 6.2 connection

### Routing entry sequence number

A unique number in your subsystem to identify this communication definition. You can use values in the range 1 to 9999.

### Comparison data: Compare value

A text string to compare with that received when the session is started by a **Transaction program** parameter, as shown in Figure 109 on page 452. The character string is derived from the Transaction program field of the sender CSI.

### Comparison data: Starting position

The character position in the string where the comparison is to start.

**Note:** The starting position field is the character position in the string for comparison, and this is always 37.

### Program to call

The name of the program that runs the inbound message program to be called to start the session.

The program, AMQCRC6A, is called for the default queue manager. This is a program supplied with MQSeries for AS/400 that sets up the environment and then calls AMQCRS6A.

For additional queue managers:

- Each queue manager has a specific LU 6.2 invocable program located in its library. This program is called AMQCRC6B and is automatically generated when the queue manager is created.
- Each queue manager requires a specific routing entry with unique routing data to be added. This routing data should match the **Transaction program** name supplied by the requesting system (see “Initiating end (Sending)” on page 452).

An example of this is shown in Figure 111:

```
Display Routing Entries
System: MY400
Subsystem description: QCMN      Status: ACTIVE
Type options, press Enter.
5=Display details

Opt  Seq Nbr  Program      Library      Compare Value  Start Pos
 10   10    *RTGDTA      *RTGDTA      'QZSCSRVR'    37
 20   20    *RTGDTA      *RTGDTA      'QZRCSRVR'    37
 30   30    *RTGDTA      *RTGDTA      'QZHQTRG'    37
 50   50    *RTGDTA      *RTGDTA      'QVPPRINT'    37
 60   60    *RTGDTA      *RTGDTA      'QNPSRVR'     37
 70   70    *RTGDTA      *RTGDTA      'QNMAPINGD'   37
 80   80    QNMAREXECD   QSYS         'AREXECD'     37
 90   90    AMQCRC6A     QMQMBW       'MQSERIES'    37
100  100    *RTGDTA      *RTGDTA      'QTFDWNLD'    37
150  150    *RTGDTA      *RTGDTA      'QMFRFCVR'    37

F3=Exit  F9=Display all detailed descriptions  F12=Cancel
```

Figure 111. LU 6.2 communication setup panel - initiated end

## Defining an LU 6.2 connection

In Figure 111 sequence number 90 represents the default queue manager and provides compatibility with configurations from previous releases (that is, V3R2, V3R6, V3R7, and V4R2) of MQSeries for AS/400. These releases allow one queue manager only. Sequence numbers 92 and 94 represent two additional queue managers called ALPHA and BETA that are created with libraries QMALPHA and QMBETA.

**Note:** You can have more than one routing entry for each queue manager by using different routing data. This gives the option of different job priorities depending on the classes used.

**Class** The name and library of the class used for the steps started through this routing entry. The class defines the attributes of the routing step's running environment and specifies the job priority. An appropriate class entry must be specified. Use, for example, the WRKCLS command to display existing classes or to create a new class. Further information on managing work requests from remote LU 6.2 systems is available in the *AS/400 Programming: Work Management Guide*.

### Note on Work Management

The AMQCRS6A job will not be able to take advantage of the normal AS/400 work management features that are documented in the *MQSeries for AS/400 V5.1 System Administration* book because it is not started in the same way as other MQSeries jobs. To change the run-time properties of the LU62 receiver jobs, you can do one of the following:

- Alter the class description that is specified on the routing entry for the AMQCRS6A job
- Change the job description on the communications entry

See the *AS/400 Programming: Work Management Guide* for more information about configuring Communication Jobs.

## DQM in MQSeries for AS/400



---

## Chapter 33. Example configuration - IBM MQSeries for AS/400

This chapter gives an example of how to set up communication links from MQSeries for AS/400 to MQSeries products on the following platforms:

- OS/2
- Windows NT
- AIX
- Digital UNIX
- HP-UX
- AT&T GIS UNIX<sup>8</sup>
- Sun Solaris
- OS/390 or MVS/ESA without CICS
- VSE/ESA

First it describes the parameters needed for an LU 6.2 connection, then it describes “Establishing an LU 6.2 connection” on page 464 and “Establishing a TCP connection” on page 469.

Once the connection is established, you need to define some channels to complete the configuration. This is described in “MQSeries for AS/400 configuration” on page 471.

See “Chapter 7. Example configuration chapters in this book” on page 97 for background information about this chapter and how to use it.

---

### Configuration parameters for an LU 6.2 connection

Table 42 on page 460 presents a worksheet listing all the parameters needed to set up communication from OS/400 to one of the other MQSeries platforms. The worksheet shows examples of the parameters, which have been tested in a working environment, and leaves space for you to fill in your own values. An explanation of the parameter names follows the worksheet. Use the worksheet in this chapter in conjunction with the worksheet in the chapter for the platform to which you are connecting.

#### Configuration worksheet

Use the following worksheet to record the values you will use for this configuration. Where numbers appear in the Reference column they indicate that the value must match that in the appropriate worksheet elsewhere in this book. The examples that follow in this chapter refer back to the values in the ID column of this table. The entries in the Parameter Name column are explained in “Explanation of terms” on page 462.

---

8. This platform has become NCR UNIX SVR4 MP-RAS, R3.0

## OS/400 and LU 6.2

Table 42. Configuration worksheet for SNA on an AS/400 system

ID	Parameter Name	Reference	Example Used	User Value
<b>Definition for local node</b>				
<b>1</b>	Local network ID		NETID	
<b>2</b>	Local control point name		AS400PU	
<b>3</b>	LU name		AS400LU	
<b>4</b>	LAN destination address		10005A5962EF	
<b>5</b>	Subsystem description		QCMN	
<b>6</b>	Line description		TOKENRINGL	
<b>7</b>	Resource name		LIN041	
<b>8</b>	Local Transaction Program name		MQSERIES	
<b>Connection to an OS/2 system</b>				
The values in this section must match those used in Table 14 on page 138, as indicated.				
<b>9</b>	Network ID	<b>2</b>	NETID	
<b>10</b>	Control point name	<b>3</b>	OS2PU	
<b>11</b>	LU name	<b>6</b>	OS2LU	
<b>12</b>	Controller description		OS2PU	
<b>13</b>	Device		OS2LU	
<b>14</b>	Side information		OS2CPIC	
<b>15</b>	Transaction Program	<b>8</b>	MQSERIES	
<b>16</b>	LAN adapter address	<b>10</b>	10005AFC5D83	
<b>17</b>	Mode	<b>17</b>	#INTER	
<b>Connection to a Windows NT system</b>				
The values in this section must match those used in Table 16 on page 170, as indicated.				
<b>9</b>	Network ID	<b>2</b>	NETID	
<b>10</b>	Control point name	<b>3</b>	WINNTCP	
<b>11</b>	LU name	<b>5</b>	WINNTLU	
<b>12</b>	Controller description		WINNTCP	
<b>13</b>	Device		WINNTLU	
<b>14</b>	Side information		NTCPIC	
<b>15</b>	Transaction Program	<b>7</b>	MQSERIES	
<b>16</b>	LAN adapter address	<b>9</b>	08005AA5FAB9	
<b>17</b>	Mode	<b>17</b>	#INTER	
<b>Connection to an AIX system</b>				
The values in this section must match those used in Table 20 on page 197, as indicated.				
<b>9</b>	Network ID	<b>1</b>	NETID	
<b>10</b>	Control point name	<b>2</b>	AIXPU	
<b>11</b>	LU name	<b>4</b>	AIXLU	
<b>12</b>	Controller description		AIXPU	
<b>13</b>	Device		AIXLU	
<b>14</b>	Side information		AIXCPIC	
<b>15</b>	Transaction Program	<b>6</b>	MQSERIES	
<b>16</b>	LAN adapter address	<b>8</b>	123456789012	
<b>17</b>	Mode	<b>14</b>	#INTER	
<b>Connection to an HP-UX system</b>				
The values in this section must match those used in Table 23 on page 219, as indicated.				

Table 42. Configuration worksheet for SNA on an AS/400 system (continued)

ID	Parameter Name	Reference	Example Used	User Value
9	Network ID	4	NETID	
10	Control point name	2	HPUXPU	
11	LU name	5	HPUXLU	
12	Controller description		HPUXPU	
13	Device		HPUXLU	
14	Side information		HPUXCPIC	
15	Transaction Program	7	MQSERIES	
16	LAN adapter address	8	100090DC2C7C	
17	Mode	17	#INTER	
<b>Connection to an AT&amp;T GIS UNIX system</b>				
The values in this section must match those used in Table 25 on page 243, as indicated.				
9	Network ID	2	NETID	
10	Control point name	3	GISPU	
11	LU name	4	GISLU	
12	Controller description		GISPU	
13	Device		GISLU	
14	Side information		GISCPIC	
15	Transaction Program	5	MQSERIES	
16	LAN adapter address	8	10007038E86B	
17	Mode	15	#INTER	
<b>Connection to a Sun Solaris system</b>				
The values in this section must match those used in Table 27 on page 257, as indicated.				
9	Network ID	2	NETID	
10	Control point name	3	SOLARPU	
11	LU name	7	SOLARLU	
12	Controller description		SOLARPU	
13	Device		SOLARLU	
14	Side information		SOLCPIC	
15	Transaction Program	8	MQSERIES	
16	LAN adapter address	5	08002071CC8A	
17	Mode	17	#INTER	
<b>Connection to an OS/390 or MVS/ESA system without CICS</b>				
The values in this section must match those used in Table 36 on page 396, as indicated.				
9	Network ID	2	NETID	
10	Control point name	3	MVSPU	
11	LU name	4	MVSLU	
12	Controller description		MVSPU	
13	Device		MVSLU	
14	Side information		MVSCPIC	
15	Transaction Program	7	MQSERIES	
16	LAN adapter address	8	400074511092	
17	Mode	6	#INTER	
<b>Connection to a VSE/ESA system</b>				
The values in this section must match those used in Table 44 on page 485, as indicated.				

## OS/400 and LU 6.2

Table 42. Configuration worksheet for SNA on an AS/400 system (continued)

ID	Parameter Name	Reference	Example Used	User Value
9	Network ID	1	NETID	
10	Control point name	2	VSEPU	
11	LU name	3	VSELU	
12	Controller description		VSEPU	
13	Device		VSELU	
14	Side information		VSECPIC	
15	Transaction Program	4	MQ01	MQ01
16	LAN adapter address	5	400074511092	
17	Mode		#INTER	

### Explanation of terms

#### 1 2 3

See “How to find network attributes” on page 463 for the details of how to find the configured values.

#### 4 LAN destination address

The hardware address of the AS/400 system token-ring adapter. You can find the value using the command DSPLIND *Line description* (6).

#### 5 Subsystem description

This is the name of any OS/400 subsystem that will be active while using the queue manager. The name QCMN has been used because this is the OS/400 communications subsystem.

#### 6 Line description

If this has been specified it is indicated in the Description field of the resource Resource name. See “How to find the value of Resource name” on page 463 for details. If the value is not specified you will need to create a line description.

#### 7 Resource name

See “How to find the value of Resource name” on page 463 for details of how to find the configured value.

#### 8 Local Transaction Program name

MQSeries applications trying to converse with this workstation will specify a symbolic name for the program to be run at the receiving end. This will have been defined on the channel definition at the sender. For simplicity, wherever possible use a transaction program name of MQSERIES, or in the case of a connection to VSE/ESA, where the length is limited to 4 bytes, use MQTP.

See Table 41 on page 451 for more information.

#### 12 Controller description

This is an alias for the Control Point name (or Node name) of the partner system. For convenience we have used the actual name of the partner in this example.

#### 13 Device

This is an alias for the LU of the partner system. For convenience we have used the LU name of the partner in this example.

**14 Side information**

This is the name given to the CPI-C side information profile. You specify your own 8-character name for this.

**How to find network attributes**

The local node has been partially configured as part of the OS/400 installation. To display the current network attributes enter the command DSPNETA.

If you need to change these values use the command CHGNETA. An IPL may be required to apply your changes.

```

                                Display Network Attributes
                                System:  AS400PU
Current system name . . . . . : AS400PU
  Pending system name . . . . . :
Local network ID . . . . . : NETID
Local control point name . . . . . : AS400PU
Default local location . . . . . : AS400LU
Default mode . . . . . : BLANK
APPN node type . . . . . : *ENDNODE
Data compression . . . . . : *NONE
Intermediate data compression . . . . . : *NONE
Maximum number of intermediate sessions . . . . . : 200
Route addition resistance . . . . . : 128
Server network ID/control point name . . . . . : NETID      NETCP

                                More...

Press Enter to continue.

F3=Exit  F12=Cancel

```

Check that the values for **Local network ID** (**1**), **Local control point name** (**2**), and **Default local location** (**3**), correspond to the values on your worksheet.

**How to find the value of Resource name**

Type WRKHDWRSC TYPE(\*CMN) and press Enter. The Work with Communication Resources panel is displayed. The value for **Resource name** is found as the Token-Ring Port. It is LIN041 in this example.

```

Work with Communication Resources
System: AS400PU
Type options, press Enter.
2=Edit 4=Remove 5=Work with configuration description
7=Add configuration description ...

Opt Resource      Configuration
      Description Type  Description
  CC02                2636 Comm Processor
  LIN04                2636 LAN Adapter
  LIN041  TOKENRINGL 2636 Token-Ring Port

F3=Exit  F5=Refresh  F6=Print  F11=Display resource addresses/statuses
F12=Cancel  F23=More options

Bottom

```

## Establishing an LU 6.2 connection

This section describes how to establish an LU 6.2 connection.

### Local node configuration

To configure the local node, you need to:

1. Create a line description
2. Add a routing entry

### Creating a line description

1. If the line description has not already been created use the command CRTLINTRN.
2. Specify values for **Line description (6)** and **Resource name (7)**.

```

Create Line Desc (Token-Ring) (CRTLINTRN)
Type choices, press Enter.

Line description . . . . . TOKENRINGL  Name
Resource name . . . . . LIN041      Name, *NWID
NWI type . . . . . *FR             *FR, *ATM
Online at IPL . . . . . *YES        *YES, *NO
Vary on wait . . . . . *NOWAIT      *NOWAIT, 15-180 (1 second)
Maximum controllers . . . . . 40     1-256
Attached NWI . . . . . *NONE        Name, *NONE

F3=Exit  F4=Prompt  F5=Refresh  F10=Additional parameters  F12=Cancel
F13=How to use this display  F24=More keys

Parameter LIND required.

Bottom
+

```

## Adding a routing entry

1. Type the command ADDRTGE and press Enter.

```

                                Add Routing Entry (ADDRTGE)

Type choices, press Enter.

Subsystem description . . . . . QCMN           Name
Library . . . . . *LIBL           Name, *LIBL, *CURLIB
Routing entry sequence number . 1           1-9999
Comparison data:
  Compare value . . . . . 'MQSERIES'

  Starting position . . . . . 37           1-80
Program to call . . . . . AMQCRC6A       Name, *RTGDTA
Library . . . . . QMQMBW           Name, *LIBL, *CURLIB
Class . . . . . *SBSD             Name, *SBSD
Library . . . . . *LIBL           Name, *LIBL, *CURLIB
Maximum active routing steps . . *NOMAX   0-1000, *NOMAX
Storage pool identifier . . . . . 1           1-10

                                                                Bottom
F3=Exit  F4=Prompt  F5=Refresh  F12=Cancel  F13=How to use this display
F24=More keys
Parameter SBSDB required.
  
```

2. Specify your value for **Subsystem description** (**5**), and the values shown here for **Routing entry sequence number**, **Compare value** (**8**), **Starting position**, **Program to call**, and the **Library** containing the program to call.
3. Type the command STRSBS *subsystem description* (**5**) and press Enter.

## Connection to partner node

This example is for a connection to an OS/2 system, but the steps are the same for other nodes. The steps are:

1. Create a controller description.
2. Create a device description.
3. Create CPI-C side information.
4. Add a communications entry for APPC.
5. Add a configuration list entry.

### Creating a controller description

1. At a command line type CRTCTLAPPC and press Enter.

```

Create Ctl Desc (APPC) (CRTCTLAPPC)

Type choices, press Enter.

Controller description . . . . . OS2PU      Name
Link type . . . . . *LAN                *FAX, *FR, *IDLC,
*LAN...
Online at IPL . . . . . *NO             *YES, *NO

F3=Exit  F4=Prompt  F5=Refresh  F10=Additional parameters  F12=Cancel
F13=How to use this display  F24=More keys
Parameter CTLD required.
Bottom
+
```

2. Specify a value for **Controller description** ( **12** ), set **Link type** to \*LAN, and set **Online at IPL** to \*NO.
3. Press Enter twice, followed by F10.

```

Create Ctl Desc (APPC) (CRTCTLAPPC)

Type choices, press Enter.

Controller description . . . . . > OS2PU      Name
Link type . . . . . > *LAN                *FAX, *FR, *IDLC, *LAN...
Online at IPL . . . . . > *NO             *YES, *NO
APPN-capable . . . . . *YES             *YES, *NO
Switched line list . . . . . TOKENRINGL    Name
+ for more values
Maximum frame size . . . . . *LINKTYPE    265-16393, 256, 265, 512...
Remote network identifier . . . NETID      Name, *NETATR, *NONE, *ANY
Remote control point . . . . . OS2PU      Name, *ANY
Exchange identifier . . . . . 00000000-FFFFFFF
Initial connection . . . . . *DIAL       *DIAL, *ANS
Dial initiation . . . . . *LINKTYPE     *LINKTYPE, *IMMED, *DELAY
LAN remote adapter address . . . 10005AFC5D83 000000000001-FFFFFFFFFFFF
APPN CP session support . . . *YES      *YES, *NO
APPN node type . . . . . *ENDNODE     *ENDNODE, *LENNODE...
APPN transmission group number  1         1-20, *CALC
More...

F3=Exit  F4=Prompt  F5=Refresh  F12=Cancel  F13=How to use this display
F24=More keys
```

4. Specify values for **Switched line list** ( **6** ), **Remote network identifier** ( **9** ), **Remote control point** ( **10** ), and **LAN remote adapter address** ( **16** ).
5. Press Enter.

### Creating a device description

1. Type the command CRTDEVAPPC and press Enter.



```

Create Device Desc (APPC) (CRTDEVAPPC)

Type choices, press Enter.

Device description . . . . . OS2LU      Name
Remote location . . . . . OS2LU      Name
Online at IPL . . . . . *YES      *YES, *NO
Local location . . . . . AS400LU     Name, *NETATR
Remote network identifier . . . NETID   Name, *NETATR, *NONE
Attached controller . . . . . OS2PU    Name
Mode . . . . . *NETATR             Name, *NETATR
      + for more values
Message queue . . . . . QSYSOPR     Name, QSYSOPR
Library . . . . . *LIBL           Name, *LIBL, *CURLIB
APPN-capable . . . . . *YES       *YES, *NO
Single session:
  Single session capable . . . *NO      *NO, *YES
  Number of conversations . . . 1-512

                                                    Bottom
F3=Exit  F4=Prompt  F5=Refresh  F10=Additional parameters  F12=Cancel
F13=How to use this display  F24=More keys
Parameter DEVD required.
+

```

- Specify values for **Device description** (**13**), **Remote location** (**11**), **Local location** (**3**), **Remote network identifier** (**9**), and **Attached controller** (**12**).

**Note:** You can avoid having to create controller and device descriptions manually by taking advantage of OS/400's auto-configuration service. Consult the OS/400 documentation for details.

## Creating CPI-C side information

- Type CRTCSI and press F10.

```

Create Comm Side Information (CRTCSI)

Type choices, press Enter.

Side information . . . . . OS2CPIC     Name
Library . . . . . *CURLIB          Name, *CURLIB
Remote location . . . . . OS2LU      Name
Transaction program . . . . . MQSERIES

Text 'description' . . . . . *BLANK

Additional Parameters

Device . . . . . *LOC              Name, *LOC
Local location . . . . . AS400LU     Name, *LOC, *NETATR
Mode . . . . . #INTER              Name, *NETATR
Remote network identifier . . . NETID  Name, *LOC, *NETATR, *NONE
Authority . . . . . *LIBCRTAUT       Name, *LIBCRTAUT, *CHANGE...

                                                    Bottom
F3=Exit  F4=Prompt  F5=Refresh  F12=Cancel  F13=How to use this display
F24=More keys
Parameter CSI required.

```

- Specify values for **Side information** (**14**), **Remote location** (**11**), **Transaction program** (**15**), **Local location** (**3**), **Mode**, and **Remote network identifier** (**9**).
- Press Enter.

## Adding a communications entry for APPC

1. At a command line type ADDCMNE and press Enter.

```

                                Add Communications Entry (ADDCMNE)

Type choices, press Enter.

Subsystem description . . . . . QCMN           Name
  Library . . . . . *LIBL           Name, *LIBL, *CURLIB
Device . . . . . OS2LU             Name, generic*, *ALL...
Remote location . . . . .           Name
Job description . . . . . *USRPRF     Name, *USRPRF, *SBSD
  Library . . . . .           Name, *LIBL, *CURLIB
Default user profile . . . . . *NONE   Name, *NONE, *SYS
Mode . . . . . *ANY                Name, *ANY
Maximum active jobs . . . . . *NOMAX   0-1000, *NOMAX

                                                    Bottom
F3=Exit  F4=Prompt  F5=Refresh  F12=Cancel  F13=How to use this display
F24=More keys
Parameter SBSD required.

```

2. Specify values for **Subsystem description** ( **5** ) and **Device** ( **13** ), and press Enter.

## Adding a configuration list entry

1. Type ADDCFGLE \*APPNRMT and press F4.

```

                                Add Configuration List Entries (ADDCFGLE)

Type choices, press Enter.

Configuration list type . . . . > *APPNRMT     *APPNLCL, *APPNRMT...
APPN remote location entry:
Remote location name . . . . . OS2LU           Name, generic*, *ANY
Remote network identifier . . . . NETID        Name, *NETATR, *NONE
Local location name . . . . . AS400LU         Name, *NETATR
Remote control point . . . . . OS2PU          Name, *NONE
Control point net ID . . . . . NETID          Name, *NETATR, *NONE
Location password . . . . . *NONE
Secure location . . . . . *NO                 *YES, *NO
Single session . . . . . *NO                 *YES, *NO
Locally controlled session . . . *NO          *YES, *NO
Pre-established session . . . . *NO          *YES, *NO
Entry 'description' . . . . . *BLANK
Number of conversations . . . . 10            1-512
      + for more values

                                                    Bottom
F3=Exit  F4=Prompt  F5=Refresh  F12=Cancel  F13=How to use this display
F24=More keys

```

2. Specify values for **Remote location name** ( **11** ), **Remote network identifier** ( **9** ), **Local location name** ( **3** ), **Remote control point** ( **10** ), and **Control point net ID** ( **9** ).
3. Press Enter.

## What next?

The LU 6.2 connection is now established. You are ready to complete the configuration. Go to “MQSeries for AS/400 configuration” on page 471.

## Establishing a TCP connection

If TCP is already configured there are no extra configuration tasks. The following panels guide you through the steps that may be required if TCP/IP is not configured.

## Adding a TCP/IP interface

1. At a command line type ADDTCPIFC and press Enter.

```

Add TCP/IP Interface (ADDTCPIFC)

Type choices, press Enter.

Internet address . . . . . 19.22.11.55
Line description . . . . . TOKENRINGL   Name, *LOOPBACK
Subnet mask . . . . . 255.255.0.0
Type of service . . . . . *NORMAL      *MINDELAY, *MAXTHRPUT..
Maximum transmission unit . . . *LIND      576-16388, *LIND
Autostart . . . . . *YES          *YES, *NO
PVC logical channel identifier
      + for more values
X.25 idle circuit timeout . . . 60          1-600
X.25 maximum virtual circuits . 64          0-64
X.25 DDN interface . . . . . *NO         *YES, *NO
TRLAN bit sequencing . . . . . *MSB        *MSB, *LSB

Bottom
F3=Exit  F4=Prompt  F5=Refresh  F12=Cancel  F13=How to use this display
F24=More keys

```

2. Specify this machine's **Internet address** and **Line description**, and a **Subnet mask**.
3. Press Enter.

## Adding a TCP/IP loopback interface

1. At a command line type ADDTCPIFC and press Enter.

```

Add TCP Interface (ADDTCPIFC)

Type choices, press Enter.

Internet address . . . . . 127.0.0.1
Line description . . . . . *LOOPBACK      Name, *LOOPBACK
Subnet mask . . . . . 255.0.0.0
Type of service . . . . . *NORMAL        *MINDELAY, *MAXTHRPUT..
Maximum transmission unit . . . *LIND      576-16388, *LIND
Autostart . . . . . *YES             *YES, *NO
PVC logical channel identifier
    + for more values
X.25 idle circuit timeout . . . 60         1-600
X.25 maximum virtual circuits . 64         0-64
X.25 DDN interface . . . . . *NO        *YES, *NO
TRLAN bit sequencing . . . . . *MSB       *MSB, *LSB

Bottom
F3=Exit  F4=Prompt  F5=Refresh  F12=Cancel  F13=How to use this display
F24=More keys
    
```

2. Specify the values for **Internet address**, **Line description**, and **Subnet mask**.

### Adding a default route

1. At a command line type ADDTCP RTE and press Enter.

```

Add TCP Route (ADDTCP RTE)

Type choices, press Enter.

Route destination . . . . . *DFTRROUTE
Subnet mask . . . . . *NONE
Type of service . . . . . *NORMAL        *MINDELAY, *MAXTHRPUT..
Next hop . . . . . 19.2.3.4
Maximum transmission unit . . . 576         576-16388, *IFC

Bottom
F3=Exit  F4=Prompt  F5=Refresh  F12=Cancel  F13=How to use this display
F24=More keys
Command prompting ended when user pressed F12.
    
```

2. Fill in with values appropriate to your network and press Enter to create a default route entry.

### What next?

The TCP connection is now established. You are ready to complete the configuration. Go to “MQSeries for AS/400 configuration” on page 471.

## MQSeries for AS/400 configuration

Start the TCP channel listener using the command STRMQMLSR.

Start any sender channel using the command STRMQMCHL  
CHLNAME(*channel\_name*).

Use the WRKMQM command to display the MQSeries configuration menu.

**Note:** AMQ\* errors are placed in the log relating to the job that found the error. Use the WRKACTJOB command to display the list of jobs. Under the subsystem name QSYSWRK, locate the job and enter 5 against it to work with that job. MQSeries logs are prefixed 'AMQ'.

### Basic configuration

1. First you need to create a queue manager. To do this, type CRTMQM and press Enter.

```

                                Create Message Queue Manager (CRTMQM)

Type choices, press Enter.
Message Queue Manager name . . .
Text 'description' . . . . . *BLANK
Trigger interval . . . . . 999999999    0-999999999
Undelivered message queue . . . *NONE
Default transmission queue . . . *NONE
Maximum handle limit . . . . . 256      1-999999999
Maximum uncommitted messages . . 1000    1-10000
Default Queue manager . . . . . *NO     *YES, *NO

                                Bottom
F3=Exit  F4=Prompt  F5=Refresh  F12=Cancel  F13=How to use this display
F24=More keys

```

2. In the **Message Queue Manager name** field, type AS400. In the **Undelivered message queue** field, type DEAD.LETTER.QUEUE.
3. Press Enter.
4. Now start the queue manager by entering STRMQM MQMNAME(AS400).
5. Create the undelivered message queue using the following parameters. (For details and an example refer to "Defining a queue" on page 475.)

```

Local Queue
Queue name :  DEAD.LETTER.QUEUE
Queue type :  *LCL

```

### Channel configuration

This section details the configuration to be performed on the OS/400 queue manager to implement the channel described in Figure 32 on page 97.

## OS/400 configuration

Examples are given for connecting MQSeries for AS/400 and MQSeries for OS/2 Warp. If you wish connect to another MQSeries product, use the appropriate values from the table in place of those for OS/2.

### Notes:

1. The words in **bold** are user-specified and reflect the names of MQSeries objects used throughout these examples. If you change the names used here, ensure that you also change the other references made to these objects throughout this book. All others are keywords and should be entered as shown.
2. The MQSeries channel ping command (PNGMQMCHL) runs interactively, whereas starting a channel causes a batch job to be submitted. If a channel ping completes successfully but the channel will not start, this indicates that the network and MQSeries definitions are probably correct, but that the OS/400 environment for the batch job is not. For example, make sure that QSYS2 is included in the system portion of the library list and not just your personal library list.

For details and examples of how to create the objects listed refer to “Defining a queue” on page 475 and “Defining a channel” on page 476.

Table 43. Configuration worksheet for MQSeries for AS/400

ID	Parameter Name	Reference	Example Used	User Value
<b>Definition for local node</b>				
<b>A</b>	Queue Manager Name		<b>AS400</b>	
<b>B</b>	Local queue name		<b>AS400.LOCALQ</b>	
<b>Connection to MQSeries for OS/2 Warp</b>				
The values in this section of the table must match those used in Table 15 on page 164, as indicated.				
<b>C</b>	Remote queue manager name	<b>A</b>	<b>OS2</b>	
<b>D</b>	Remote queue name		<b>OS2.REMOTEQ</b>	
<b>E</b>	Queue name at remote system	<b>B</b>	<b>OS2.LOCALQ</b>	
<b>F</b>	Transmission queue name		<b>OS2</b>	
<b>G</b>	Sender (SNA) channel name		<b>AS400.OS2.SNA</b>	
<b>H</b>	Sender (TCP) channel name		<b>AS400.OS2.TCP</b>	
<b>I</b>	Receiver (SNA) channel name	<b>G</b>	<b>OS2.AS400.SNA</b>	
<b>J</b>	Receiver (TCP) channel name	<b>H</b>	<b>OS2.AS400.TCP</b>	
<b>Connection to MQSeries for Windows NT</b>				
The values in this section of the table must match those used in Table 17 on page 185, as indicated.				
<b>C</b>	Remote queue manager name	<b>A</b>	<b>WINNT</b>	
<b>D</b>	Remote queue name		<b>WINNT.REMOTEQ</b>	
<b>E</b>	Queue name at remote system	<b>B</b>	<b>WINNT.LOCALQ</b>	
<b>F</b>	Transmission queue name		<b>WINNT</b>	
<b>G</b>	Sender (SNA) channel name		<b>AS400.WINNT.SNA</b>	
<b>H</b>	Sender (TCP/IP) channel name		<b>AS400.WINNT.TCP</b>	
<b>I</b>	Receiver (SNA) channel name	<b>G</b>	<b>WINNT.AS400.SNA</b>	
<b>J</b>	Receiver (TCP/IP) channel name	<b>H</b>	<b>WINNT.AS400.TCP</b>	
<b>Connection to MQSeries for AIX</b>				
The values in this section of the table must match those used in Table 21 on page 211, as indicated.				
<b>C</b>	Remote queue manager name		<b>AIX</b>	
<b>D</b>	Remote queue name		<b>AIX.REMOTEQ</b>	

Table 43. Configuration worksheet for MQSeries for AS/400 (continued)

ID	Parameter Name	Reference	Example Used	User Value
<b>E</b>	Queue name at remote system	<b>B</b>	AIX.LOCALQ	
<b>F</b>	Transmission queue name		AIX	
<b>G</b>	Sender (SNA) channel name		AS400.AIX.SNA	
<b>H</b>	Sender (TCP/IP) channel name		AS400.AIX.TCP	
<b>I</b>	Receiver (SNA) channel name	<b>G</b>	AIX.AS400.SNA	
<b>J</b>	Receiver (TCP) channel name	<b>H</b>	AIX.AS400.TCP	
<b>Connection to MQSeries for DIGITAL UNIX (Compaq Tru64 UNIX)</b>				
The values in this section of the table must match those used in Table 22 on page 216, as indicated.				
<b>C</b>	Remote queue manager name		DECUX	
<b>D</b>	Remote queue name		DECUX.REMOTEQ	
<b>E</b>	Queue name at remote system	<b>B</b>	DECUX.LOCALQ	
<b>F</b>	Transmission queue name		DECUX	
<b>H</b>	Sender (TCP) channel name		DECUX.AS400.TCP	
<b>J</b>	Receiver (TCP) channel name	<b>H</b>	AS400.DECUX.TCP	
<b>Connection to MQSeries for HP-UX</b>				
The values in this section of the table must match those used in Table 24 on page 239, as indicated.				
<b>C</b>	Remote queue manager name		HPUX	
<b>D</b>	Remote queue name		HPUX.REMOTEQ	
<b>E</b>	Queue name at remote system	<b>B</b>	HPUX.LOCALQ	
<b>F</b>	Transmission queue name		HPUX	
<b>G</b>	Sender (SNA) channel name		AS400.HPUX.SNA	
<b>H</b>	Sender (TCP) channel name		AS400.HPUX.TCP	
<b>I</b>	Receiver (SNA) channel name	<b>G</b>	HPUX.AS400.SNA	
<b>J</b>	Receiver (TCP) channel name	<b>H</b>	HPUX.AS400.TCP	
<b>Connection to MQSeries for AT&amp;T GIS UNIX</b>				
The values in this section of the table must match those used in Table 26 on page 253, as indicated.				
<b>C</b>	Remote queue manager name		GIS	
<b>D</b>	Remote queue name		GIS.REMOTEQ	
<b>E</b>	Queue name at remote system	<b>B</b>	GIS.LOCALQ	
<b>F</b>	Transmission queue name		GIS	
<b>G</b>	Sender (SNA) channel name		AS400.GIS.SNA	
<b>H</b>	Sender (TCP) channel name		AS400.GIS.TCP	
<b>I</b>	Receiver (SNA) channel name	<b>G</b>	GIS.AS400.SNA	
<b>J</b>	Receiver (TCP/IP) channel name	<b>H</b>	GIS.AS400.TCP	
<b>Connection to MQSeries for Sun Solaris</b>				
The values in this section of the table must match those used in Table 28 on page 272, as indicated.				
<b>C</b>	Remote queue manager name		SOLARIS	
<b>D</b>	Remote queue name		SOLARIS.REMOTEQ	
<b>E</b>	Queue name at remote system	<b>B</b>	SOLARIS.LOCALQ	
<b>F</b>	Transmission queue name		SOLARIS	
<b>G</b>	Sender (SNA) channel name		AS400.SOLARIS.SNA	
<b>H</b>	Sender (TCP/IP) channel name		AS400.SOLARIS.TCP	
<b>I</b>	Receiver (SNA) channel name	<b>G</b>	SOLARIS.AS400.SNA	
<b>J</b>	Receiver (TCP/IP) channel name	<b>H</b>	SOLARIS.AS400.TCP	

## OS/400 configuration

Table 43. Configuration worksheet for MQSeries for AS/400 (continued)

ID	Parameter Name	Reference	Example Used	User Value
<b>Connection to MQSeries for OS/390 without CICS</b>				
The values in this section of the table must match those used in Table 37 on page 406, as indicated.				
<b>C</b>	Remote queue manager name		MVS	
<b>D</b>	Remote queue name		MVS.REMOTEQ	
<b>E</b>	Queue name at remote system	<b>B</b>	MVS.LOCALQ	
<b>F</b>	Transmission queue name		MVS	
<b>G</b>	Sender (SNA) channel name		AS400.MVS.SNA	
<b>H</b>	Sender (TCP) channel name		AS400.MVS.TCP	
<b>I</b>	Receiver (SNA) channel name	<b>G</b>	MVS.AS400.SNA	
<b>J</b>	Receiver (TCP) channel name	<b>H</b>	MVS.AS400.TCP	
<b>Connection to MQSeries for VSE/ESA</b>				
The values in this section of the table must match those used in Table 45 on page 490, as indicated.				
<b>C</b>	Remote queue manager name		VSE	
<b>D</b>	Remote queue name		VSE.REMOTEQ	
<b>E</b>	Queue name at remote system	<b>B</b>	VSE.LOCALQ	
<b>F</b>	Transmission queue name		VSE	
<b>G</b>	Sender channel name		AS400.VSE.SNA	
<b>I</b>	Receiver channel name	<b>G</b>	VSE.AS400.SNA	

### MQSeries for AS/400 sender-channel definitions using SNA

```

Local Queue
  Queue name : OS2
  Queue type : *LCL
  Usage : *TMQ
  F

Remote Queue
  Queue name : OS2.REMOTEQ
  Queue type : *RMT
  Remote queue : OS2.LOCALQ
  Remote Queue Manager : OS2
  Transmission queue : OS2
  D
  E
  C
  F

Sender Channel
  Channel Name : AS400.OS2.SNA
  Channel Type : *SDR
  Transport type : *LU62
  Connection name : OS2CPIC
  Transmission queue : OS2
  G
  14
  F

```

### MQSeries for AS/400 receiver-channel definitions using SNA

```

Local Queue
  Queue name : AS400.LOCALQ
  Queue type : *LCL
  B

Receiver Channel
  Channel Name : OS2.AS400.SNA
  Channel Type : *RCVR
  Transport type : *LU62
  I

```



**MQSeries for AS/400 sender-channel definitions using TCP**

```

Local Queue
  Queue name : OS2
  Queue type : *LCL
  Usage      : *TMQ
                                     F

Remote Queue
  Queue name : OS2.REMOTEQ
  Queue type : *RMT
  Remote queue : OS2.LOCALQ
  Remote Queue Manager : OS2
  Transmission queue : OS2
                                     D
                                     E
                                     C
                                     F

Sender Channel
  Channel Name : AS400.OS2.TCP
  Channel Type : *SDR
  Transport type : *TCP
  Connection name : os2.tcPIP.hostname
  Transmission queue : OS2
                                     H
                                     F

```

**MQSeries for AS/400 receiver-channel definitions using TCP**

```

Local Queue
  Queue name : AS400.LOCALQ
  Queue type : *LCL
                                     B

Receiver Channel
  Channel Name : OS2.AS400.TCP
  Channel Type : *RCVR
  Transport type : *TCP
                                     J

```

**Defining a queue**

Type CRTMQMQ on the command line.

Create MQM Queue (CRTMQMQ)

Type choices, press Enter.

Queue name . . . . .

Queue type . . . . . \*ALS, \*LCL, \*RMT

Bottom

F3=Exit F4=Prompt F5=Refresh F12=Cancel F13=How to use this display  
F24=More keys  
Parameter QNAME required.

Fill in the two fields of this panel and press Enter. This causes another panel to appear, with entry fields for the other parameters you have. Defaults can be taken for all other queue attributes.

## OS/400 configuration

### Defining a channel

Type CRTMQMCHL on the command line.

```
                Create MQM Channel (CRTMQMCHL)

Type choices, press Enter.

Channel name . . . . .
Channel type . . . . .          *RCVR, *SDR, *SVR, *RQSTR

                                                                    Bottom
F3=Exit  F4=Prompt  F5=Refresh  F12=Cancel  F13=How to use this display
F24=More keys
Parameter CHLNAME required.
```

Fill in the two fields of this panel and press Enter. Another panel is displayed on which you can specify the values for the other parameters given earlier. Defaults can be taken for all other channel attributes.

## Chapter 34. Message channel planning example for OS/400

This chapter provides a detailed example of how to connect two OS/400 queue managers together so that messages can be sent between them. The example illustrates the preparations needed to allow an application using queue manager QM1 to put messages on a queue at queue manager QM2. An application running on QM2 can retrieve these messages, and send responses to a reply queue on QM1.

The example illustrates the use of TCP/IP connections. The example assumes that channels are to be triggered to start when the first message arrives on the transmission queue they are servicing. You must start the channel initiator in order for triggering to work. To do this, use the STRMQMCHLI command.

This example uses SYSTEM.CHANNEL.INITQ as the initiation queue. This queue is already defined by MQSeries. You can use a different initiation queue, but you will have to define it yourself and specify the name of the queue when you start the channel initiator.

### What the example shows

The example uses the MQSeries for AS/400 command language.

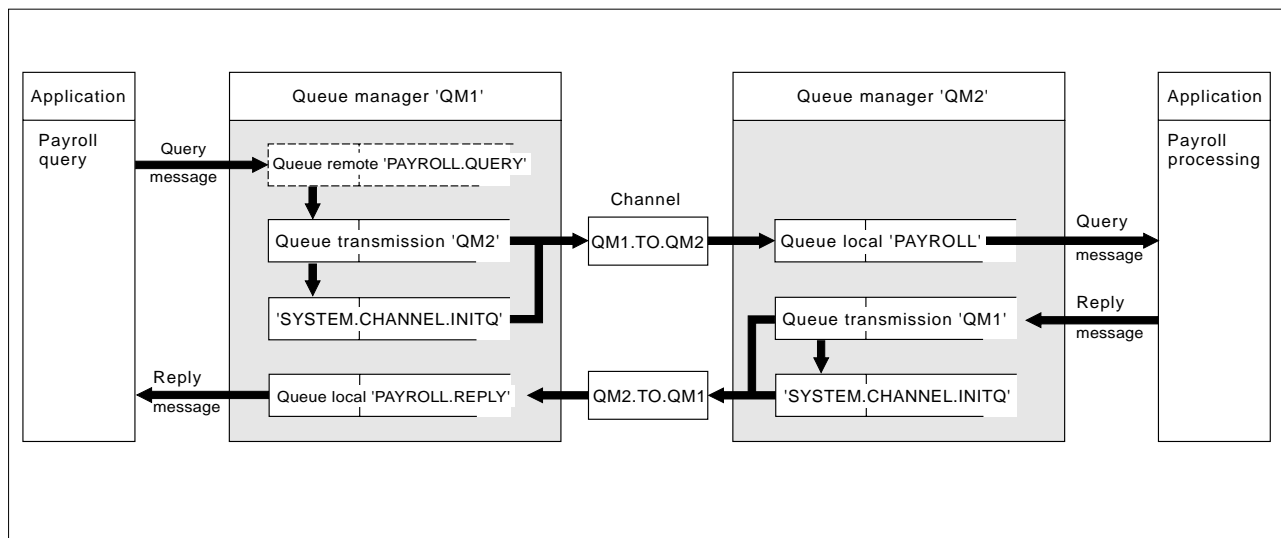

Figure 112. The message channel example for MQSeries for AS/400

It involves a payroll query application connected to queue manager QM1 that sends payroll query messages to a payroll processing application running on queue manager QM2. The payroll query application needs the replies to its queries sent back to QM1. The payroll query messages are sent from QM1 to QM2 on a sender-receiver channel called QM1.TO.QM2, and the reply messages are sent back from QM2 to QM1 on another sender-receiver channel called QM2.TO.QM1. Both of these channels are triggered to start as soon as they have a message to send to the other queue manager.

The payroll query application puts a query message to the remote queue "PAYROLL.QUERY" defined on QM1. This remote queue definition resolves to the

## Planning example for OS/400

local queue “PAYROLL” on QM2. In addition, the payroll query application specifies that the reply to the query is sent to the local queue “PAYROLL.REPLY” on QM1. The payroll processing application gets messages from the local queue “PAYROLL” on QM2, and sends the replies to wherever they are required; in this case, local queue “PAYROLL.REPLY” on QM1.

Both queue managers are assumed to be running on OS/400. In the example definitions, QM1 has a host address of 9.20.9.31 and is listening on port 1411, and QM2 has a host address of 9.20.9.32 and is listening on port 1412. The example assumes that these are already defined on your OS/400 system, and are available for use.

The object definitions that need to be created on QM1 are:

- Remote queue definition, PAYROLL.QUERY
- Transmission queue definition, QM2 (default=remote queue manager name)
- Process definition, QM1.TO.QM2.PROCESS (not needed for MQSeries for AS/400 V5.1)
- Sender channel definition, QM1.TO.QM2
- Receiver channel definition, QM2.TO.QM1
- Reply-to queue definition, PAYROLL.REPLY

The object definitions that need to be created on QM2 are:

- Local queue definition, PAYROLL
- Transmission queue definition, QM1 (default=remote queue manager name)
- Process definition, QM2.TO.QM1.PROCESS (not needed for MQSeries for AS/400 V5.1)
- Sender channel definition, QM2.TO.QM1
- Receiver channel definition, QM1.TO.QM2

The connection details are supplied in the CONNAME attribute of the sender channel definitions.

You can see a diagram of the arrangement in Figure 112 on page 477.

## Queue manager QM1 example

The following object definitions allow applications connected to queue manager QM1 to send request messages to a queue called PAYROLL on QM2, and to receive replies on a queue called PAYROLL.REPLY on QM1.

All the object definitions have been provided with the TEXT attributes. The other attributes supplied are the minimum required to make the example work. The attributes that are not supplied take the default values for queue manager QM1.

Run the following commands on queue manager QM1:

### Remote queue definition

The CRTMQMQ command with the following attributes:

QNAME	'PAYROLL.QUERY'
QTYPE	*RMT
TEXT	'Remote queue for QM2'
PUTENBL	*YES
TMQNAME	'QM2' (default = remote queue manager name)
RMTQNAME	'PAYROLL'
RMTMQMNAME	'QM2'

**Note:** The remote queue definition is not a physical queue, but a means of directing messages to the transmission queue, QM2, so that they can be sent to queue manager QM2.

**Transmission queue definition**

The CRTMQMQ command with the following attributes:

QNAME	QM2
QTYPE	*LCL
TEXT	'Transmission queue to QM2'
USAGE	*TMQ
PUTENBL	*YES
GETENBL	*YES
TRGENBL	*YES
TRGTYPE	*FIRST
INITQNAME	SYSTEM.CHANNEL.INITQ
PRCNAME	QM1.TO.QM2.PROCESS

When the first message is put on this transmission queue, a trigger message is sent to the initiation queue, SYSTEM.CHANNEL.INITQ. The channel initiator gets the message from the initiation queue and starts the channel identified in the named process.

**Process definition**

The CRTMQMPRC command with the following attributes:

PRCNAME	QM1.TO.QM2.PROCESS
TEXT	'Process for starting channel'
APPTYPE	*OS400
APPID	'AMQRMCLA'
USRDATA	QM1.TO.QM2

The channel initiator uses this process information to start channel QM1.TO.QM2.

**Note:** From MQSeries for AS/400 V5.1 onwards, the need for a process definition can be eliminated by specifying the channel name in the TRIGDATA attribute of the transmission queue.

**Sender channel definition**

The CRTMQMCHL command with the following attributes:

CHLNAME	QM1.TO.QM2
CHLTYPE	*SDR
TRPTYPE	*TCP
TEXT	'Sender channel to QM2'
TMQNAME	QM2
CONNAME	'9.20.9.32(1412)'

## Planning example for OS/400

### Receiver channel definition

The CRTMQMCHL command with the following attributes:

CHLNAME	QM2.TO.QM1
CHLTYPE	*RCVR
TRPTYPE	*TCP
TEXT	'Receiver channel from QM2'

### Reply-to queue definition

The CRTMQMQ command with the following attributes:

QNAME	PAYROLL.REPLY
QTYPE	*LCL
TEXT	'Reply queue for replies to query messages sent to QM2'
PUTENBL	*YES
GETENBL	*YES

The reply-to queue is defined as PUT(ENABLED). This ensures that reply messages can be put to the queue. If the replies cannot be put to the reply-to queue, they are sent to the dead-letter queue on QM1 or, if this queue is not available, remain on transmission queue QM1 on queue manager QM2. The queue has been defined as GET(ENABLED) to allow the reply messages to be retrieved.

## Queue manager QM2 example

The following object definitions allow applications connected to queue manager QM2 to retrieve request messages from a local queue called PAYROLL, and to put replies to these request messages to a queue called PAYROLL.REPLY on queue manager QM1.

You do not need to provide a remote queue definition to enable the replies to be returned to QM1. The message descriptor of the message retrieved from local queue PAYROLL contains both the reply-to queue and the reply-to queue manager names. Therefore, as long as QM2 can resolve the reply-to queue manager name to that of a transmission queue on queue manager QM2, the reply message can be sent. In this example, the reply-to queue manager name is QM1 and so queue manager QM2 simply requires a transmission queue of the same name.

All the object definitions have been provided with the TEXT attribute and are the minimum required to make the example work. The attributes that are not supplied take the default values for queue manager QM2.

Run the following commands on queue manager QM2:

### Local queue definition

The CRTMQMQ command with the following attributes:

QNAME	PAYROLL
QTYPE	*LCL
TEXT	'Local queue for QM1 payroll details'
PUTENBL	*YES
GETENBL	*YES

This queue is defined as PUT(ENABLED) and GET(ENABLED) for the same reason as the reply-to queue definition on queue manager QM1.

**Transmission queue definition**

The CRTMQMQ command with the following attributes:

QNAME	QM1
QTYPE	*LCL
TEXT	'Transmission queue to QM1'
USAGE	*TMQ
PUTENBL	*YES
GETENBL	*YES
TRGENBL	*YES
TRGTYPE	*FIRST
INITQNAME	SYSTEM.CHANNEL.INITQ
PRCNAME	QM2.TO.QM1.PROCESS

When the first message is put on this transmission queue, a trigger message is sent to the initiation queue, SYSTEM.CHANNEL.INITQ. The channel initiator gets the message from the initiation queue and starts the channel identified in the named process.

**Process definition**

The CRTMQMPCRC command with the following attributes:

PRCNAME	QM2.TO.QM1.PROCESS
TEXT	'Process for starting channel'
APPTYPE	*OS400
APPID	'AMQRMCLA'
USRDATA	QM2.TO.QM1

The channel initiator uses this process information to start channel QM2.TO.QM1.

**Note:** For MQSeries for AS/400 V5.1, the need for a process definition can be eliminated by specifying the channel name in the TRIGDATA attribute of the transmission queue.

**Sender channel definition**

The CRTMQMCHL command with the following attributes:

CHLNAME	QM2.TO.QM1
CHLTYPE	*SDR
TRPTYPE	*TCP
TEXT	'Sender channel to QM1'
TMQNAME	QM1
CONNAME	'9.20.9.31(1411)'

**Receiver channel definition**

The CRTMQMCHL command with the following attributes:

CHLNAME	QM1.TO.QM2
CHLTYPE	*RCVR
TRPTYPE	*TCP
TEXT	'Receiver channel from QM1'

### Running the example

When you have created the required objects, you must:

- Start the channel initiator for both queue managers
- Start the listener for both queue managers

The applications can then send messages to each other. The channels are triggered to start by the first message arriving on each transmission queue, so you do not need to issue the STRMQMCHL command.

For details about starting a channel initiator and a listener see “Chapter 30. Monitoring and controlling channels in MQSeries for AS/400” on page 423.

### Expanding this example

This example can be expanded by:

- Adding more queue, process, and channel definitions to allow other applications to send messages between the two queue managers.
- Adding user exit programs on the channels to allow for link encryption, security checking, or additional message processing.
- Using queue manager aliases and reply-to queue aliases to understand more about how these can be used in the organization of your queue manager network.

For a version of this example that uses MQSC commands, see “Chapter 25. Message channel planning example for OS/390” on page 345.



---

## Part 6. DQM in MQSeries for VSE/ESA

<b>Chapter 35. Example configuration - MQSeries for VSE/ESA</b> . . . . .	485	Configuring channels. . . . .	490
Configuration parameters for an LU 6.2 connection	485	MQSeries for VSE/ESA sender-channel definitions . . . . .	492
Configuration worksheet . . . . .	485	MQSeries for VSE/ESA receiver-channel definitions . . . . .	493
Explanation of terms . . . . .	487	Defining a local queue . . . . .	493
Establishing an LU 6.2 connection . . . . .	488	Defining a remote queue . . . . .	495
Defining a connection . . . . .	488	Defining a SNA LU 6.2 sender channel . . . . .	497
Defining a session . . . . .	488	Defining a SNA LU6.2 receiver channel. . . . .	498
Installing the new group definition . . . . .	489	Defining a TCP/IP sender channel . . . . .	500
What next? . . . . .	489	Defining a TCP receiver channel . . . . .	501
Establishing a TCP connection. . . . .	490		
MQSeries for VSE/ESA configuration . . . . .	490		

This part of the book describes an example configuration for MQSeries for VSE/ESA.

## DQM in MQSeries for VSE/ESA

---

## Chapter 35. Example configuration - MQSeries for VSE/ESA

This chapter gives an example of how to set up communication links from MQSeries for VSE/ESA to MQSeries products on the following platforms:

- OS/2
- Windows NT
- AIX
- Digital UNIX
- HP-UX
- AT&T GIS UNIX<sup>9</sup>
- Sun Solaris
- OS/400
- OS/390 or MVS/ESA without CICS

It describes the parameters needed for an LU 6.2 and TCP connection. Once the connection is established, you need to define some channels to complete the configuration. This is described in “MQSeries for VSE/ESA configuration” on page 490.

---

### Configuration parameters for an LU 6.2 connection

Table 44 presents a worksheet listing all the parameters needed to set up communication from VSE/ESA to one of the other MQSeries platforms. The worksheet shows examples of the parameters, which have been tested in a working environment, and leaves space for you to fill in your own values. An explanation of the parameter names follows the worksheet. Use the worksheet in this chapter in conjunction with the worksheet in the chapter for the platform to which you are connecting.

### Configuration worksheet

Use the following worksheet to record the values you will use for this configuration. Where numbers appear in the Reference column they indicate that the value must match that in the appropriate worksheet elsewhere in this book. The examples that follow in this chapter refer back to the values in the ID column of this table. The entries in the Parameter Name column are explained in “Explanation of terms” on page 487.

Table 44. Configuration worksheet for VSE/ESA using APPC

ID	Parameter Name	Reference	Example Used	User Value
<b>Definition for local node</b>				
<b>1</b>	Network ID		NETID	
<b>2</b>	Node name		VSEPU	
<b>3</b>	Local LU name		VSELU	
<b>4</b>	Local Transaction Program name		MQ01	MQ01
<b>5</b>	LAN destination address		400074511092	
<b>Connection to an OS/2 system</b>				
The values in this section of the table must match those used in the table for OS/2, as indicated.				

---

9. This platform has become NCR UNIX SVR4 MP-RAS, R3.0

## VSE/ESA and LU 6.2

Table 44. Configuration worksheet for VSE/ESA using APPC (continued)

ID	Parameter Name	Reference	Example Used	User Value
6	Connection name		OS2	
7	Group name		EXAMPLE	
8	Session name		OS2SESS	
9	Netname	6	OS2LU	
<b>Connection to a Windows NT system</b>				
The values in this section of the table must match those used in the table for Windows NT, as indicated.				
6	Connection name		WNT	
7	Group name		EXAMPLE	
8	Session name		WNTSESS	
9	Netname	5	WINNTLU	
<b>Connection to an AIX system</b>				
The values in this section of the table must match those used in the table for AIX, as indicated.				
6	Connection name		AIX	
7	Group name		EXAMPLE	
8	Session name		AIXSESS	
9	Netname	4	AIXLU	
<b>Connection to an HP-UX system</b>				
The values in this section of the table must match those used in the table for HP-UX, as indicated.				
6	Connection name		HPUX	
7	Group name		EXAMPLE	
8	Session name		HPUXSESS	
9	Netname	5	HPUXLU	
<b>Connection to an AT&amp;T GIS UNIX system</b>				
The values in this section of the table must match those used in the table for GIS UNIX, as indicated.				
6	Connection name		GIS	
7	Group name		EXAMPLE	
8	Session name		GISSESS	
9	Netname	4	GISLU	
<b>Connection to a Sun Solaris system</b>				
The values in this section of the table must match those used in the table for Sun Solaris, as indicated.				
6	Connection name		SOL	
7	Group name		EXAMPLE	
8	Session name		SOLSESS	
9	Netname	7	SOLARLU	
<b>Connection to an AS/400 system</b>				
The values in this section of the table must match those used in the table for AS/400, as indicated.				
6	Connection name		AS4	
7	Group name		EXAMPLE	
8	Session name		AS4SESS	
9	Netname	3	AS400LU	
<b>Connection to an OS/390 or MVS/ESA system without CICS</b>				
The values in this section of the table must match those used in the table for OS/390, as indicated.				
6	Connection name		MVS	

Table 44. Configuration worksheet for VSE/ESA using APPC (continued)

ID	Parameter Name	Reference	Example Used	User Value
7	Group name		EXAMPLE	
8	Session name		MVSESS	
9	Netname	4	MVSLU	

## Explanation of terms

### 1 Network ID

This is the unique ID of the network to which you are connected. Your system administrator will tell you this value.

### 2 Node name

This is the name of the SSCP which owns the CICS/VSE region.

### 3 Local LU name

This is the unique VTAM APPLID of this CICS/VSE region.

### 4 Transaction Program name

MQSeries applications trying to converse with this queue manager will specify a transaction name for the program to be run at the receiving end. This will have been defined on the channel definition at the sender. MQSeries for VSE/ESA uses a name of MQ01.

### 5 LAN destination address

This is the LAN destination address that your partner nodes will use to communicate with this host. It is usually the address of the 3745 on the same LAN as the partner node.

### 6 Connection name

This is a 4-character name by which each connection will be individually known in CICS RDO.

### 7 Group name

You choose your own 8-character name for this value. Your system may already have a group defined for connections to partner nodes. Your system administrator will give you a value to use.

### 8 Session name

This is an 8-character name by which each session will be individually known. For clarity we use the connection name, concatenated with 'SESS'.

### 9 Netname

This is the LU name of the MQSeries queue manager on the system with which you are setting up communication.

### Establishing an LU 6.2 connection

This example is for a connection to an OS/2 system. The steps are the same whatever platform you are using; change the values as appropriate.

#### Defining a connection

1. At a CICS command line type CEDA DEF CONN(*connection name*) GROUP(*group name*) (where connection name is **6** and group name is **7**). For example:  
CEDA DEF CONN(OS2) GROUP(EXAMPLE)
2. Press Enter to define a connection to CICS.

```
DEF CONN(OS2) GROUP(EXAMPLE)
OVERTYPE TO MODIFY
CEDA DEFine
  Connection      : OS2
  Group           : EXAMPLE
  Description     ==>
CONNECTION IDENTIFIERS
  Netname        ==> OS2LU
  INDSys         ==>
REMOTE ATTRIBUTES
  REMOTESystem   ==>
  REMOTENAME     ==>
CONNECTION PROPERTIES
  ACcessmethod   ==> Vtam      Vtam | IRc | INdirect | Xm
  Protocol       ==> Appc      Appc | Lu61
  SInglesess     ==> No        No | Yes
  DATAstream    ==> User      User | 3270 | SCs | STRfield | Lms
  RECOrdformat   ==> U         U | Vb
OPERATIONAL PROPERTIES
+ Autoconnect    ==> Yes      No | Yes | All
I New group EXAMPLE created.

DEFINE SUCCESSFUL                      TIME: 16.49.30 DATE: 96.054
PF 1 HELP 2 COM 3 END                   6 CRSR 7 SBH 8 SFH 9 MSG 10 SB 11 SF 12 CNCL
```

3. On the panel change the **Netname** field in the CONNECTION IDENTIFIERS section to be the LU name (**9**) of the target system.
4. In the CONNECTION PROPERTIES section set the **ACcessmethod** field to Vtam and the **Protocol** to Appc.
5. Press Enter to make the change.

#### Defining a session

1. At a CICS command line type CEDA DEF SESS(*session name*) GROUP(*group name*) (where session name is **8** and group name is **7**). For example:  
CEDA DEF SESS(OS2SESS) GROUP(EXAMPLE)
2. Press Enter to define a session for the connection.

```

DEF SESS(OS2SESS) GROUP(EXAMPLE)
OVERTYPE TO MODIFY
CEDA DEFine
Sessions ==> OS2SESS
Group ==> EXAMPLE
DEscription ==>
SESSION IDENTIFIERS
Connection ==> OS2
SESSName ==>
NETnameq ==>
MOdename ==> #INTER
SESSION PROPERTIES
Protocol ==> Appc Appc | Lu61
MAximum ==> 008 , 004 0-999
RECEIVEPfx ==>
RECEIVECount ==> 1-999
SENDPfx ==>
SENDCount ==> 1-999
SENDSize ==> 04096 1-30720
+ RECEIVESize ==> 04096 1-30720
S CONNECTION MUST BE SPECIFIED.

TIME: 14.23.19 DATE: 96.054
PF 1 HELP 2 COM 3 END 6 CRSR 7 SBH 8 SFH 9 MSG 10 SB 11 SF 12 CNCL

```

3. In the SESSION IDENTIFIERS section of the panel specify the Connection name (**6**) in the **Connection** field and set the **MOdename** to #INTER.
4. In the SESSION PROPERTIES section set the **Protocol** to Appc and the **MAximum** field to 008 , 004.

## Installing the new group definition

1. At a CICS command line type CEDA INS GROUP(*group name*) **7**.
2. Press Enter to install the new group definition.

**Note:** If this connection group is already in use you may get severe errors reported. If this happens, take the existing connections out of service, retry the above group installation, and then set the connections in service using the following commands:

- a. CEMT I CONN
- b. CEMT S CONN(\*) OUTS
- c. CEDA INS GROUP(*group name*)
- d. CEMT S CONN(\*) INS

## What next?

The LU 6.2 connection is now established. You are ready to complete the configuration. Go to “MQSeries for VSE/ESA configuration” on page 490.

## Establishing a TCP connection

TCP connections do not require the configuration of additional profiles as does the LU 6.2 protocol. Instead, MQSeries for VSE/ESA processes the MQSeries listener program during MQSeries startup.

The MQSeries listener program waits for remote TCP connection requests. As these are received, the listener starts the receiver MCA to process the remote connection. When the remote connection is received from a client program, the receiver MCA starts the MQSeries server program.

**Note:** There is one MQSeries server process for each client connection.

Provided that the MQSeries listener is active and TCP is active in a VSE partition, TCP connections can be established.

## MQSeries for VSE/ESA configuration

Configuring MQSeries for VSE/ESA involves the following tasks:

- Configuring channels
- Defining a local queue
- Defining a remote queue
- Defining a sender channel
- Defining a receiver channel

### Configuring channels

Examples are given for connecting MQSeries for VSE/ESA and MQSeries for OS/2 Warp. If you wish connect to another MQSeries platform use the appropriate set of values from the table in place of those for OS/2.

**Note:** The words in **bold** are user-specified and reflect the names of MQSeries objects used throughout these examples. If you change the names used here, ensure that you also change the other references made to these objects throughout this book. All others are keywords and should be entered as shown.

Refer to the sections “Defining a local queue” on page 493 and “Defining a remote queue” on page 495 for details of how to create queue definitions, and “Defining a SNA LU 6.2 sender channel” on page 497 and “Defining a SNA LU6.2 receiver channel” on page 498 for details of how to create channels.

Table 45. Configuration worksheet for MQSeries for VSE/ESA

ID	Parameter Name	Reference	Example Used	User Value
<b>Definition for local node</b>				
<b>A</b>	Queue Manager Name		VSE	
<b>B</b>	Local queue name		VSE.LOCALQ	
<b>Connection to MQSeries for OS/2 Warp</b>				
The values in this section of the table must match those used in the worksheet table for OS/2, as indicated.				
<b>C</b>	Remote queue manager name	<b>A</b>	OS2	
<b>D</b>	Remote queue name		OS2.REMOTEQ	
<b>E</b>	Queue name at remote system	<b>B</b>	OS2.LOCALQ	
<b>F</b>	Transmission queue name		OS2	
<b>G</b>	Sender channel name		VSE.OS2.SNA	



Table 45. Configuration worksheet for MQSeries for VSE/ESA (continued)

ID	Parameter Name	Reference	Example Used	User Value
<b>I</b>	Receiver channel name	<b>G</b>	OS2.VSE.SNA	
<b>Connection to MQSeries for Windows NT</b>				
The values in this section of the table must match those used in the worksheet table for Windows NT, as indicated.				
<b>C</b>	Remote queue manager name	<b>A</b>	WINNT	
<b>D</b>	Remote queue name		WINNT.REMOTEQ	
<b>E</b>	Queue name at remote system	<b>B</b>	WINNT.LOCALQ	
<b>F</b>	Transmission queue name		WINNT	
<b>G</b>	Sender channel name		VSE.WINNT.SNA	
<b>I</b>	Receiver channel name	<b>G</b>	WINNT.VSE.SNA	
<b>Connection to MQSeries for AIX</b>				
The values in this section of the table must match those used in the worksheet table for AIX, as indicated.				
<b>C</b>	Remote queue manager name		AIX	
<b>D</b>	Remote queue name		AIX.REMOTEQ	
<b>E</b>	Queue name at remote system	<b>B</b>	AIX.LOCALQ	
<b>F</b>	Transmission queue name		AIX	
<b>G</b>	Sender channel name		VSE.AIX.SNA	
<b>I</b>	Receiver channel name	<b>G</b>	AIX.VSE.SNA	
<b>Connection to MQSeries for DIGITAL UNIX (Compaq Tru64 UNIX)</b>				
The values in this section of the table must match those used in the worksheet table for Digital UNIX, as indicated.				
<b>C</b>	Remote queue manager name		DECUX	
<b>D</b>	Remote queue name		DECUX.REMOTEQ	
<b>E</b>	Queue name at remote system	<b>B</b>	DECUX.LOCALQ	
<b>F</b>	Transmission queue name		DECUX	
<b>H</b>	Sender (TCP) channel name		DECUX.VSE.TCP	
<b>I</b>	Receiver channel name	<b>J</b>	VSE.DECUX.TCP	
<b>Connection to MQSeries for HP-UX</b>				
The values in this section of the table must match those used in the worksheet table for HP-UX, as indicated.				
<b>C</b>	Remote queue manager name		HPUX	
<b>D</b>	Remote queue name		HPUX.REMOTEQ	
<b>E</b>	Queue name at remote system	<b>B</b>	HPUX.LOCALQ	
<b>F</b>	Transmission queue name		HPUX	
<b>G</b>	Sender channel name		VSE.HPUX.SNA	
<b>I</b>	Receiver channel name	<b>G</b>	HPUX.VSE.SNA	
<b>Connection to MQSeries for AT&amp;T GIS UNIX</b>				
The values in this section of the table must match those used in the worksheet table for GIS UNIX, as indicated.				
<b>C</b>	Remote queue manager name		GIS	
<b>D</b>	Remote queue name		GIS.REMOTEQ	
<b>E</b>	Queue name at remote system	<b>B</b>	GIS.LOCALQ	
<b>F</b>	Transmission queue name		GIS	
<b>G</b>	Sender channel name		VSE.GIS.SNA	
<b>I</b>	Receiver channel name	<b>G</b>	GIS.VSE.SNA	
<b>Connection to MQSeries for Sun Solaris</b>				
The values in this section of the table must match those used in the worksheet table for Sun Solaris, as indicated.				

## VSE/ESA configuration

Table 45. Configuration worksheet for MQSeries for VSE/ESA (continued)

ID	Parameter Name	Reference	Example Used	User Value
<b>C</b>	Remote queue manager name		SOLARIS	
<b>D</b>	Remote queue name		SOLARIS.REMOTEQ	
<b>E</b>	Queue name at remote system	<b>B</b>	SOLARIS.LOCALQ	
<b>F</b>	Transmission queue name		SOLARIS	
<b>G</b>	Sender channel name		VSE.SOLARIS.SNA	
<b>I</b>	Receiver channel name	<b>G</b>	SOLARIS.VSE.SNA	
<b>Connection to MQSeries for AS/400</b>				
The values in this section of the table must match those used in the worksheet table for AS/400, as indicated.				
<b>C</b>	Remote queue manager name		AS400	
<b>D</b>	Remote queue name		AS400.REMOTEQ	
<b>E</b>	Queue name at remote system	<b>B</b>	AS400.LOCALQ	
<b>F</b>	Transmission queue name		AS400	
<b>G</b>	Sender channel name		VSE.AS400.SNA	
<b>I</b>	Receiver channel name	<b>G</b>	AS400.VSE.SNA	
<b>Connection to MQSeries for OS/390 or MVS/ESA without CICS</b>				
The values in this section of the table must match those used in the worksheet table for OS/390, as indicated.				
<b>C</b>	Remote queue manager name		MVS	
<b>D</b>	Remote queue name		MVS.REMOTEQ	
<b>E</b>	Queue name at remote system	<b>B</b>	MVS.LOCALQ	
<b>F</b>	Transmission queue name		MVS	
<b>G</b>	Sender channel name		VSE.MVS.SNA	
<b>I</b>	Receiver channel name	<b>G</b>	MVS.VSE.SNA	

For TCP, the sender channel name **G** and the receiver channel name **I**, in the preceding table, can be VSE.sys.tcp and sys.VSE.TCP respectively.

In both cases sys represents the remote system name, for example, OS2. Therefore, in this case, **G** becomes VSE.OS2.TCP and **I** becomes OS2.VSE.TCP.

### MQSeries for VSE/ESA sender-channel definitions

```

Local Queue
  Object Type : L
  Object Name : OS2 F
  Usage Mode : T (Transmission)

Remote Queue
  Object Type : R
  Object Name : OS2.REMOTEQ D
  Remote QUEUE Name : OS2.LOCALQ E
  Remote QM Name : OS2 C
  Transmission Name : OS2 F

Sender Channel
  Channel name : VSE.OS2.SNA G
  Channel type : S (Sender)
  Transmission queue name : OS2 F
  Remote Task ID : MQTP
  Connection name : OS2 G
  
```

**MQSeries for VSE/ESA receiver-channel definitions**

```

Local Queue
  Object type : QLOCAL
  Object Name : VSE.LOCALQ      B
  Usage Mode : N (Normal)

Receiver Channel
  Channel name : OS2.VSE.SNA    I
  Channel type : R (Receiver)

```

**Defining a local queue**

1. Run the MQSeries master terminal transaction MQMT.

```

08/18/1998      IBM MQSeries for VSE/ESA Version 2.1.0      IYBPZS01
19:50:25        *** Master Terminal Main Menu ***          VSE1
MQMMTP                                                  A004

                SYSTEM IS ACTIVE

                1. Configuration
                2. Operations
                3. Monitoring
                4. Browse Queue Records

                Option:

Function completed - please enter a new request.
5686-A06 (C) Copyright IBM Corp. 1999      All Rights Reserved.
CLEAR/PF3 = Exit                          ENTER=Select

```

2. Select option 1 to configure.

```

08/18/1998      IBM MQSeries for VSE/ESA Version 2.1.0      IYBPZS01
19:52:21        *** Configuration Main Menu ***            VSE1
MQMMCFCG                                               A004

                SYSTEM IS ACTIVE

                Maintenance Options :
                1. Global System Definition
                2. Queue Definitions
                3. Channel Definitions

                Display Options   :
                4. Global System Definition
                5. Queue Definitions
                6. Channel Definitions

                Option:

Please enter one of the options listed.
5686-A06 (C) Copyright IBM Corp. 1999      All Rights Reserved.
ENTER = Process                          PF2 = Main Menu      PF3 = Quit

```

## VSE/ESA configuration

3. Select option 2 to work with queue definitions.

```
08/18/1998      IBM MQSeries for VSE/ESA Version 2.1.0      IYBPZS01
19:55:12        Queue Main Options                          VSE1
MQMMQUE                                                A004

                SYSTEM IS ACTIVE

        Default Q Manager : VSEP

        Object Type: L      L=Local Q, R=Remote Q, AQ=Alias Queue,
                               AM=Alias Manager,
                               AR=Alias Reply Q

        Object Name: VSE.LOCALQ

ENTER NEEDED INFORMATION.

PF2=Main Config PF3 = Quit PF4/ENTER = Read  PF5 = Add          PF6 = Update
                  PF9 = List  PF11= Reorg.    PF12= Delete
```

4. Select an Object type of L and specify the name of the queue.
5. Press PF5.

```
08/18/1998      IBM MQSeries for VSE/ESA Version 2.1.0      IYBPZS01
19:56:10        Queue Definition Record              VSE1
MQMMQUE         QM - VSEP                             A004

                LOCAL QUEUE DEFINITION

Object Name. . . . . : VSE.LOCALQ
Description line 1 . . . . . :
Description line 2 . . . . . :

Put Enabled . . . . . : Y      Y=Yes, N=No
Get Enabled . . . . . : Y      Y=Yes, N=No

Default Inbound status . . . : A      Outbound .. : A      A=Active,I=Inactive

Dual Update Queue . . . . . :

Automatic Reorganize (Y/N) : N

Record being added - Press ADD key again.

PF2=Main Config PF3 = Quit PF4/ENTER = Read  PF5 = Add          PF6 = Update
                  PF9 = List  PF10= Queue    PF11= Reorg.    PF12= Delete
```

6. Press PF5 again.

```

08/18/1998      IBM MQSeries for VSE/ESA Version 2.1.0      IYBPZS01
19:57:26        Queue Extended Definition                  VSE1
MQMMQUE         QM - VSEP                                   A004
Object Name. . . . . : VSE.LOCALQ
                  Physical Queue Information
Usage Mode . . . . . : N      N=Normal, T=Transmission
Share Mode . . . . . : Y      Y=Yes, N=No
Physical File Name . . . . . : ** FILE NOT DEFINED

                  Maximum Values
Maximum Q Depth. . . . . : 01000000      Global Lock Entries . : 00001000
Maximum Message Length . . : 01000000      Local Lock Entries. . : 00001000
Maximum Concurrent Accesses: 00000100      Checkpoint Threshold : 1000

                  Trigger Information
Trigger Enable . . . . . : N      Y=yes, N=No
Trigger Type . . . . . : F=First, E=Every
Maximum Trigger Starts . . : 0001
Allow Restart of Trigger : N      Y=Yes, N=No
Trans ID :
Program ID :
                  Term ID:
                  Channel Name:

***** File not found *****
PF2=Main Config PF3 = Quit PF4/ENTER = Read   PF5 = Add           PF6 = Update
                PF9 = List PF10= Queue       PF11= Reorg.        PF12= Delete
    
```

7. Specify the name of a CICS file to store messages for this queue.
8. If you are creating a transmission queue, specify a **Usage Mode** of T, a **Program ID** of MQPSEND, and a **Channel Name**< **G** >.
  - For a normal queue specify a **Usage Mode** of N.
9. Press PF5 again.

## Defining a remote queue

1. Run the MQSeries master terminal transaction MQMT.

```

08/18/1998      IBM MQSeries for VSE/ESA Version 2.1.0      IYBPZS01
19:50:25        *** Master Terminal Main Menu ***          VSE1
MQMMTP                                                 A004

                  SYSTEM IS ACTIVE

                  1. Configuration
                  2. Operations
                  3. Monitoring
                  4. Browse Queue Records

                  Option:

Function completed - please enter a new request.
5686-A06 (C) Copyright IBM Corp. 1999      All Rights Reserved.
CLEAR/PF3 = Exit                            ENTER=Select
    
```

2. Select option 1 to configure.

## VSE/ESA configuration

```
08/18/1998      IBM MQSeries for VSE/ESA Version 2.1.0      IYBPZS01
19:52:21        *** Configuration Main Menu ***      VSE1
MQMMCFG                                               A004

                SYSTEM IS ACTIVE

                Maintenance Options :
                  1. Global System Definition
                  2. Queue Definitions
                  3. Channel Definitions

                Display Options   :
                  4. Global System Definition
                  5. Queue Definitions
                  6. Channel Definitions

                Option:

Please enter one of the options listed.
      5686-A06 (C) Copyright IBM Corp. 1999      All Rights Reserved.
ENTER = Process      PF2 = Main Menu      PF3 = Quit
```

### 3. Select option 2 to work with queue definitions.

```
08/18/1998      IBM MQSeries for VSE/ESA Version 2.1.0      IYBPZS01
19:59:30        Queue Main Options      VSE1
MQMMQUE                                               A004

                SYSTEM IS ACTIVE

                Default Q Manager : VSEP

                Object Type: R      L=Local Q, R=Remote Q, AQ=Alias Queue,
                                     AM=Alias Manager,
                                     AR=Alias Reply Q

                Object Name: OS2.REMOTEQ

ENTER NEEDED INFORMATION.

PF2=Main Config PF3 = Quit PF4/ENTER = Read PF5 = Add PF6 = Update
PF9 = List      PF11= Reorg.      PF12= Delete
```

4. Select an **Object type** of **R** and specify the name of the queue.
5. Press PF5.

```

08/18/1998      IBM MQSeries for VSE/ESA Version 2.1.0      IYBPZS01
20:00:25       Queue Definition Record                    VSE1
MQMMQUE        QM - VSEP                                    A004

                REMOTE QUEUE DEFINITION

Object Name. . . . . : OS2.REMOTEQ
Description line 1 . . . . . :
Description line 2 . . . . . :

Put Enabled . . . . . : Y          Y=Yes, N=No
Get Enabled . . . . . : Y          Y=Yes, N=No

Remote Queue Name . . . . . : OS2.LOCALQ
Remote QM Name. . . . . : OS2
Transmission Q Name . . . . . : OS2

Record being added - Press ADD key again.

PF2=Main Config PF3 = Quit  PF4/ENTER = Read  PF5 = Add          PF6 = Update
                PF9 = List  PF10= Queue    PF11= Reorg.    PF12= Delete
    
```

6. Specify a remote queue name, remote queue manager name, and transmission queue name.
7. Press PF5.

## Defining a SNA LU 6.2 sender channel

1. Run the MQSeries master terminal transaction MQMT.

```

08/18/1998      IBM MQSeries for VSE/ESA Version 2.1.0      IYBPZS01
19:50:25       *** Master Terminal Main Menu ***          VSE1
MQMMTP                                     A004

                SYSTEM IS ACTIVE

                1. Configuration
                2. Operations
                3. Monitoring
                4. Browse Queue Records

                Option:

Function completed - please enter a new request.
5686-A06 (C) Copyright IBM Corp. 1999      All Rights Reserved.
CLEAR/PF3 = Exit                            ENTER=Select
    
```

2. Select option 1 to configure.

## VSE/ESA configuration

```
08/18/1998      IBM MQSeries for VSE/ESA Version 2.1.0      IYBPZS01
19:52:21        *** Configuration Main Menu ***      VSE1
MQMMCFG                                               A004

                SYSTEM IS ACTIVE

                Maintenance Options :
                  1. Global System Definition
                  2. Queue Definitions
                  3. Channel Definitions

                Display Options      :
                  4. Global System Definition
                  5. Queue Definitions
                  6. Channel Definitions

                Option:

Please enter one of the options listed.
5686-A06 (C) Copyright IBM Corp. 1999      All Rights Reserved.
ENTER = Process      PF2 = Main Menu      PF3 = Quit
```

### 3. Select option 3 to work with channel definitions.

```
10/08/1998      IBM MQSeries for VSE/ESA Version 2.1.0      IYBPZR02
14:05:20        Channel Record      DISPLAY      SYSA
MQMMCHN      Last Check Point      Last Update 19981006      SFCA
MSN 00000000 Time 11:28:28 Interv 000000 Create Date 19980616
Name : RB01.DC01.SDRC.5006
Protocol : L (L/T) Port : 0000 Type : R (S/R/C)
Partner : MA02

                Allocation Retries      Get Retries
                Number of Retries: 00000000      Number of Retries : 00000000
                Delay Time - fast: 00000000      Delay Time          : 00000005
                Delay Time - slow: 00000000

                Max Messages per Batch : 000001      Max Transmission Size : 03200
                Message Sequence Wrap : 999999      Max Message Size      : 0010240

                Mess Seq Req(Y/N): Y      Convers Cap (Y/N): Y      Split Msg(Y/N): N

                Transmission Queue Name :
                TP Name:
                Checkpoint Values:      Frequency: 0000      Time Span: 0000
                Enable(Y/N) Y      Dead Letter Store(Y/N) Y
                Channel record displayed.
                PF2 =Menu PF3 =Quit PF4 =Read PF5 =Add PF6=Update PF9 =List PF12 =Delete
```

### 4. Complete the parameter fields as indicated, specifically the fields **Name** < **G** >, **Type**, **Partner**, **Transmission Queue Name** < **F** >, and **TP Name**.

All other parameters can be entered as shown.

Note that the default value for **sequence number wrap** is 999999, whereas for Version 2 MQSeries products, this value defaults to 999999999.

### 5. Press PF5.

## Defining a SNA LU6.2 receiver channel

### 1. Run the MQSeries master terminal transaction MQMT.



```
08/18/1998      IBM MQSeries for VSE/ESA Version 2.1.0      IYBPZS01
19:50:25        *** Master Terminal Main Menu ***      VSE1
MQMMTP                                                  A004

                SYSTEM IS ACTIVE

                1. Configuration
                2. Operations
                3. Monitoring
                4. Browse Queue Records

                Option:

Function completed - please enter a new request.
5686-A06 (C) Copyright IBM Corp. 1999      All Rights Reserved.
CLEAR/PF3 = Exit                          ENTER=Select
```

2. Select option 1 to configure.

```
08/18/1998      IBM MQSeries for VSE/ESA Version 2.1.0      IYBPZS01
19:52:21        *** Configuration Main Menu ***      VSE1
MQMMCFG                                                  A004

                SYSTEM IS ACTIVE

                Maintenance Options :
                1. Global System Definition
                2. Queue Definitions
                3. Channel Definitions

                Display Options      :
                4. Global System Definition
                5. Queue Definitions
                6. Channel Definitions

                Option:

Please enter one of the options listed.
5686-A06 (C) Copyright IBM Corp. 1999      All Rights Reserved.
ENTER = Process                          PF2 = Main Menu                          PF3 = Quit
```

3. Select option 3 to work with channel definitions.

## VSE/ESA configuration

```
08/19/1998          IBM MQSeries for VSE/ESA Version 2.1.0          IYBPZS01
07:29:03           Channel Record          DISPLAY          MCHN
MQMMCHN           Last Check Point          Last Update 19980805  A004
MSN 00000149      Time 17:52:32 Interv 000000          Create Date 19980528
Name : OS2.VSE.SNA
Protocol : L (L/T) Port : 0000          Type : R (S/R/C)
Partner :

      Allocation Retries          Get Retries
Number of Retries: 00000000          Number of Retries : 00000000
Delay Time - fast: 00000000          Delay Time          : 00000000
Delay Time - slow: 00000000

Max Messages per Batch : 000001          Max Transmission Size : 032000
Message Sequence Wrap : 999999          Max Message Size     : 008192

Mess Seq Req(Y/N): Y          Convers Cap (Y/N): Y          Split Msg(Y/N): N

Transmission Queue Name :
TP Name:
Checkpoint Values:          Frequency: 0000          Time Span: 0000
Enable(Y/N) Y          Dead Letter Store(Y/N) Y
Channel record displayed.
PF2 =Menu PF3 =Quit PF4 =Read PF5 =Add PF6=Update PF9 =List PF12 =Delete
```

4. Complete the parameter fields as indicated, specifically the field **Channel name** < **L** >.  
All other parameters can be entered as shown.
5. Press PF5.

## Defining a TCP/IP sender channel

To define a TCP/IP sender channel, carry out the following procedure:

1. Run the MQSeries master terminal transaction MQMT.
2. Select option 1 to configure.
3. Select option 3 to work with channel definitions. The screen shown in Figure 113 on page 501 is displayed:

```

07/16/1998      IBM MQSeries for VSE/ESA Version 2.1.0      IYBPS01
08:03:53              Channel Record      DISPLAY      MCHN
MQMMCHN      Last Check Point      Last Update 00000000      A005
MSN 00000002 Time 07:10:22 Interv 000000      Create Date 19980528
Name : SD01_TCP_VSEP
Protocol : T (L/T) Port : 1414 Type : S (S/R/C)
Partner :

      Allocation Retries      Get Retries
Number of Retries: 00000000      Number of Retries : 00000000
Delay Time - fast: 00000000      Delay Time : 00000000
Delay Time - slow: 00000000

Max Messages per Batch : 000001      Max Transmission Size : 032000
Message Sequence Wrap : 999999      Max Message Size : 008192

Mess Seq Req(Y/N): Y      Convers Cap (Y/N): Y      Split Mssg(Y/N): N

Transmission Queue Name :
TP Name:
Checkpoint Values:      Frequency: 0000      Time Span: 0000
Enable(Y/N) Y      Dead Letter Store(Y/N) N
Channel record displayed.
PF2 =Menu PF3 =Quit PF4 =Read PF5 =Add PF6=Update PF9 =List PF12 =Delete

```

Figure 113. Channel configuration panel

4. Complete the parameter fields as follows:

- Channel name – **G** on the configuration worksheet.
- Partner – should contain the IP address of the remote host, for example, 1.20.33.444.
- Port – the port number must match the port number configured for the remote host. This is configured in the global system definition of the remote host. The default port number for MQSeries for VSE/ESA is 1414.
- Transmission queue name – **F** on the configuration worksheet.
- Protocol – enter T for TCP.
- Channel type – enter S for sender.

**Notes:**

- a. The TP Name is not used by TCP channels.
  - b. Ensure that the parameter field values match the values of the receiver channel definition of the same name on the remote host.
5. Press PF5 (Add) to add the new channel definition.

## Defining a TCP receiver channel

To define a TCP receiver channel, carry out the following procedure:

1. Run the MQSeries master terminal transaction MQMT.
2. Select option 1 to configure.
3. Select option 3 to work with channel definitions. The screen shown in Figure 113 is displayed.
4. Complete the parameter fields as follows:
  - Channel name – **G** on the configuration worksheet.
  - Protocol – enter T for TCP.
  - Channel type – enter R for receiver.

## VSE/ESA configuration

### Notes:

- a. The Partner and Port are not required for a TCP receiver channel.
  - b. The TP Name is not used by TCP channels.
  - c. Ensure that the parameter field values match the values of the sender channel definition of the same name on the remote host.
5. Press PF5 (Add) to add the new channel definition.

## Part 7. Further intercommunication considerations

<b>Chapter 36. Channel-exit programs</b> . . . . .	505	Usage notes . . . . .	551
What are channel-exit programs? . . . . .	505	C invocation. . . . .	552
Processing overview . . . . .	506	COBOL invocation . . . . .	552
Channel security exit programs . . . . .	507	RPG invocation (ILE). . . . .	552
Channel send and receive exit programs . . . . .	512	RPG invocation (OPM) . . . . .	552
Channel message exit programs . . . . .	514	System/390 assembler invocation. . . . .	552
Channel message retry exit program. . . . .	516	MQXWAIT - Wait . . . . .	553
Channel auto-definition exit program . . . . .	516	Syntax. . . . .	553
Transport-retry exit program . . . . .	517	Parameters . . . . .	553
Writing and compiling channel-exit programs . . . . .	518	C invocation. . . . .	554
MQSeries for OS/390 without CICS . . . . .	520	System/390 assembler invocation. . . . .	554
MQSeries for OS/390 using CICS. . . . .	521	MQ_TRANSPORT_EXIT - Transport retry exit . . . . .	555
MQSeries for AS/400. . . . .	521	Syntax. . . . .	555
MQSeries for OS/2 Warp . . . . .	522	Parameters . . . . .	555
Windows 3.1 client . . . . .	524	Usage notes . . . . .	555
MQSeries for Windows NT server, MQSeries client for Windows NT, and MQSeries client for Windows 95 and Windows 98 . . . . .	524	C invocation. . . . .	555
MQSeries for Windows . . . . .	526	MQCD - Channel data structure . . . . .	556
MQSeries for AIX . . . . .	526	Fields . . . . .	558
MQSeries for Compaq (DIGITAL) OpenVMS . . . . .	528	C declaration . . . . .	580
MQSeries for DIGITAL UNIX (Compaq Tru64 UNIX). . . . .	529	COBOL declaration . . . . .	582
MQSeries for HP-UX . . . . .	530	PL/I declaration . . . . .	584
MQSeries for AT&T GIS UNIX . . . . .	531	ILE RPG declaration . . . . .	585
MQSeries for Sun Solaris . . . . .	532	OPM RPG declaration . . . . .	587
MQSeries for SINIX and DC/OSx . . . . .	532	System/390 assembler declaration . . . . .	589
MQSeries for Tandem NonStop Kernel . . . . .	533	MQCXP - Channel exit parameter structure . . . . .	591
Building and using channel exit functions . . . . .	534	Fields . . . . .	591
Supplied channel-exit programs using DCE security services . . . . .	537	C declaration . . . . .	601
What do the DCE channel-exit programs do? . . . . .	537	COBOL declaration . . . . .	601
How do the DCE channel-exit programs work? . . . . .	538	PL/I declaration . . . . .	602
How to use the DCE channel-exit programs . . . . .	540	ILE RPG declaration . . . . .	602
Setup for DCE . . . . .	540	OPM RPG declaration . . . . .	603
The supplied exit code . . . . .	541	System/390 assembler declaration . . . . .	604
Using DCE channel exits with the runmqcls listener program . . . . .	542	MQTXP - Transport-exit data structure . . . . .	605
<b>Chapter 37. Channel-exit calls and data structures</b> . . . . .	543	Fields . . . . .	605
Data definition files . . . . .	544	C declaration . . . . .	608
MQ_CHANNEL_EXIT - Channel exit . . . . .	546	MQXWD - Exit wait descriptor structure . . . . .	609
Syntax. . . . .	546	Fields . . . . .	609
Parameters . . . . .	546	C declaration . . . . .	610
Usage notes . . . . .	548	System/390 assembler declaration . . . . .	610
C invocation. . . . .	549	<b>Chapter 38. Problem determination in DQM</b> . . . . .	611
COBOL invocation . . . . .	549	Error message from channel control . . . . .	611
PL/I invocation . . . . .	549	Ping . . . . .	611
RPG invocation (ILE). . . . .	549	Dead-letter queue considerations . . . . .	612
RPG invocation (OPM) . . . . .	550	Validation checks . . . . .	612
System/390® assembler invocation . . . . .	550	In-doubt relationship . . . . .	613
MQ_CHANNEL_AUTO_DEF_EXIT - Channel auto-definition exit . . . . .	551	Channel startup negotiation errors . . . . .	613
Syntax. . . . .	551	When a channel refuses to run . . . . .	613
Parameters . . . . .	551	Triggered channels . . . . .	614
		Conversion failure. . . . .	615
		Network problems . . . . .	615
		Dial-up problems . . . . .	615
		Retrying the link . . . . .	615
		Retry considerations . . . . .	615
		Data structures . . . . .	616
		User exit problems . . . . .	616

## Further intercommunication considerations

Disaster recovery . . . . .	616	Error logs on UNIX systems . . . . .	618
Channel switching. . . . .	617	Error logs on DOS, Windows 3.1, and Windows	
Connection switching. . . . .	617	95 and Windows 98 clients . . . . .	618
Client problems . . . . .	617	Error logs on OS/390. . . . .	619
Terminating clients . . . . .	617	Error logs on MQSeries for Windows . . . . .	619
Error logs . . . . .	618	Error logs on MQSeries for VSE/ESA . . . . .	619
Error logs for OS/2 and Windows NT . . . . .	618	Error logs on MQSeries for Tandem NSK . . . . .	619

This part of the book is about creating installation-specific user-exit programs, and solving problems with your MQSeries system. The description is not platform-specific. Where some details apply only to certain platforms, this is made clear. Most of the OS/390 information here applies equally to MVS/ESA.

## Chapter 36. Channel-exit programs

This chapter discusses MQSeries channel-exit programs. This is product-sensitive programming interface information. The following topics are covered:

- “What are channel-exit programs?”
- “Writing and compiling channel-exit programs” on page 518
- “Supplied channel-exit programs using DCE security services” on page 537

Message channel agents (MCAs) can also call data-conversion exits; these are discussed in the *MQSeries Application Programming Guide*.

**Note:** Channel exit programs are not supported on DOS or VSE/ESA.

### What are channel-exit programs?

Channel-exit programs are called at defined places in the processing carried out by MCA programs.

Some of these user-exit programs work in complementary pairs. For example, if a user-exit program is called by the sending MCA to encrypt the messages for transmission, the complementary process must be functioning at the receiving end to reverse the process.

The different types of channel-exit program are described below. Table 46 shows the types of channel exit that are available for each channel type.

Table 46. Channel exits available for each channel type

Channel Type	Message exit	Message-retry exit	Receive exit	Security exit	Send exit	Auto-definition exit	Transport-retry exit
Sender channel	✓		✓	✓	✓		✓
Server channel	✓		✓	✓	✓		✓
Cluster-sender channel	✓		✓	✓	✓	✓	
Receiver channel	✓	✓	✓	✓	✓	✓	✓
Requester channel	✓	✓	✓	✓	✓		✓
Cluster-receiver channel	✓	✓	✓	✓	✓	✓	
Client-connection channel			✓	✓	✓		
Server-connection channel			✓	✓	✓	✓	

**Notes:**

1. The message-retry exit does not apply to MQSeries for OS/390 or MQSeries for Windows.
2. The auto-definition exit applies to V5.1 of MQSeries for AIX, AS/400, HP-UX, OS/2 Warp, Sun Solaris, and Windows NT and MQSeries for OS/390 (cluster-sender channels only).
3. The transport-retry exit applies to MQSeries for AIX V5.1 and MQSeries for Windows V2.0 only.

## Channel-exit programs

If you are going to run channel exits on a client, you cannot use the MQSERVER environment variable. Instead, create and reference a client channel definition table as described in the *MQSeries Clients* book.

## Processing overview

On startup, the MCAs exchange a startup dialog to synchronize processing. Then they switch to a data exchange that includes the security exits; these must end successfully for the startup phase to complete and to allow messages to be transferred.

The security check phase is a loop, as shown in Figure 114.

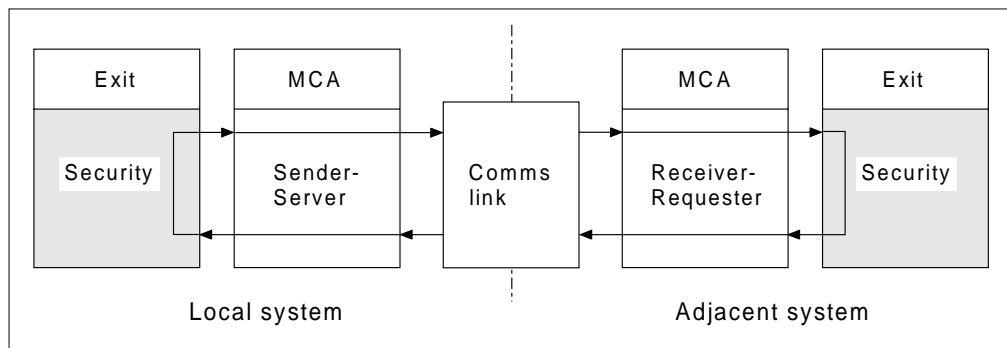

Figure 114. Security exit loop

During the message transfer phase, the sending MCA gets messages from a transmission queue, calls the message exit, calls the send exit, and then sends the message to the receiving MCA, as shown in Figure 115.

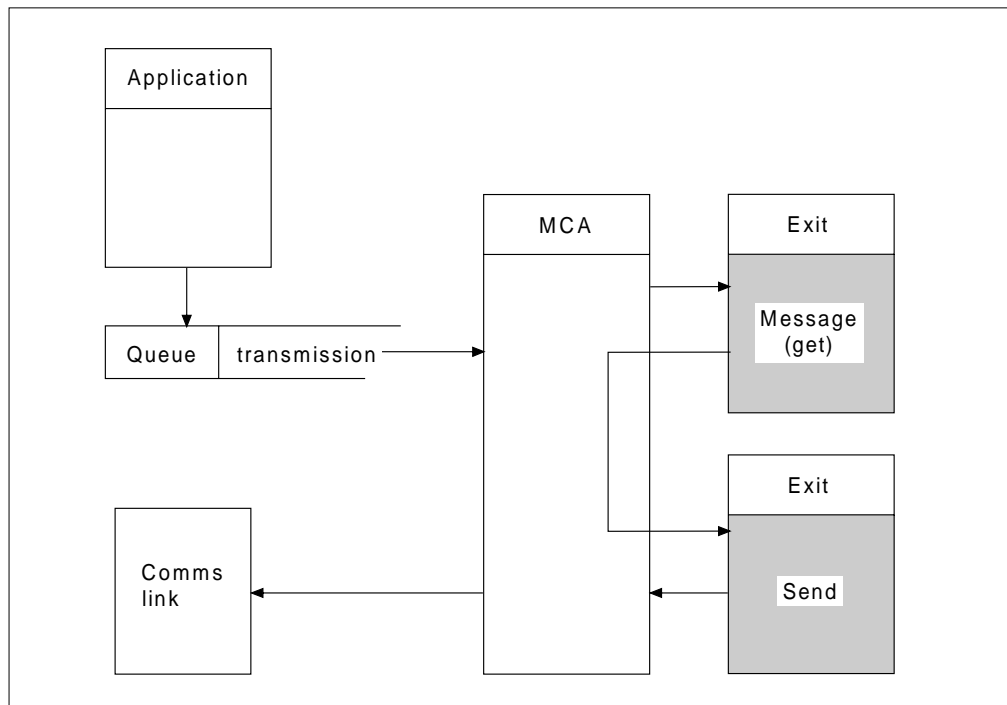

Figure 115. Example of a send exit at the sender end of message channel



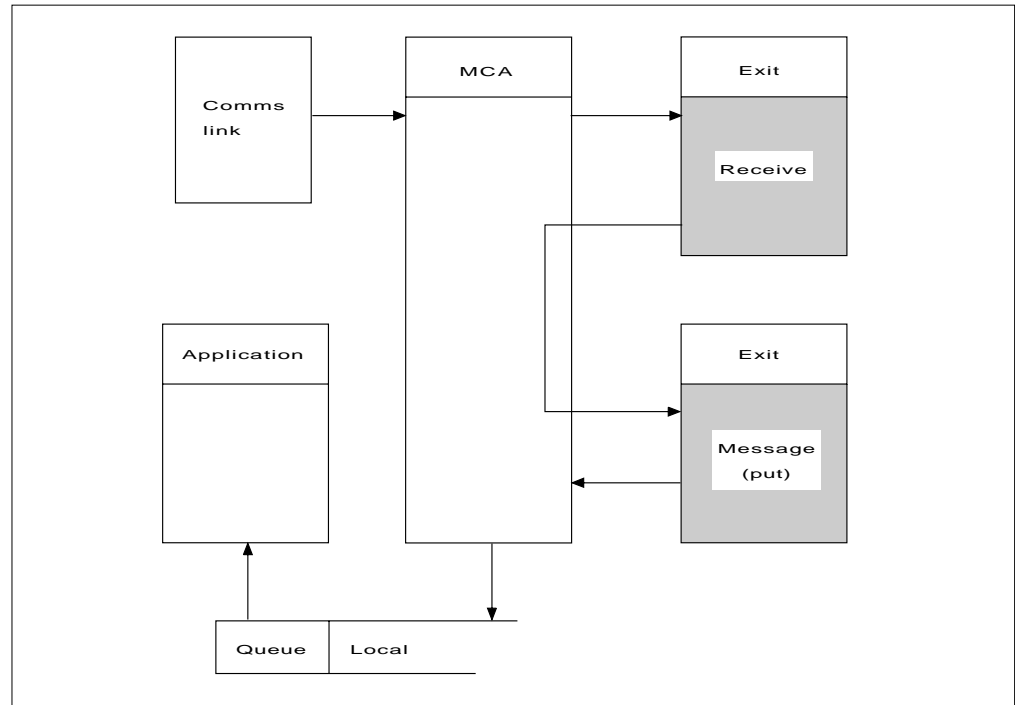

Figure 116. Example of a receive exit at the receiver end of message channel

The receiving MCA receives a message from the communications link, calls the receive exit, calls the message exit, and then puts the message on the local queue, as shown in Figure 116. (The receive exit can be called more than once before the message exit is called.)

## Channel security exit programs

You can use security exit programs to verify that the partner at the other end of a channel is genuine.

Channel security exit programs are called at the following places in an MCA's processing cycle:

- At MCA initiation and termination.
- Immediately after the initial data negotiation is finished on channel startup. The receiver or server end of the channel may initiate a security message exchange with the remote end by providing a message to be delivered to the security exit at the remote end. It may also decline to do so. The exit program is re-invoked to process any security message received from the remote end.
- Immediately after the initial data negotiation is finished on channel startup. The sender or requester end of the channel processes a security message received from the remote end, or initiates a security exchange when the remote end cannot. The exit program is re-invoked to process all subsequent security messages that may be received.

A requester channel never gets called with `MQXCC_INIT_SEC`. The channel notifies the server that it has a security exit program, and the server then has the opportunity to initiate a security exit. If it does not have one, it sends a null security flow to allow the requester to call its exit program.

**Note:** You are recommended to avoid sending zero-length security messages.

## Channel-exit programs

V5.1 of MQSeries for AIX, HP-UX, OS/2 Warp, Sun Solaris, and Windows NT and the MQSeries client for Windows 95 and Windows 98 supply a security exit program that uses the DCE security services. See “Supplied channel-exit programs using DCE security services” on page 537.

Examples of the data exchanged by security-exit programs are illustrated in figures 117 through 120. These examples show the sequence of events that occur involving the receiver’s security exit (left-hand column) and the sender’s security exit (right-hand column). Successive rows in the figures represent the passage of time. In some cases, the events at the receiver and sender are not correlated, and therefore can occur at the same time or at different times. In other cases, an event at one exit program results in a complementary event occurring later at the other exit program. For example, in Figure 117 on page 509:

1. The receiver and sender are each invoked with MQXR\_INIT, but these invocations are not correlated and can therefore occur at the same time or at different times.
2. The receiver is next invoked with MQXR\_INIT\_SEC, but returns MQXCC\_OK which requires no complementary event at the sender exit.
3. The sender is next invoked with MQXR\_INIT\_SEC. This is not correlated with the invocation of the receiver with MQXR\_INIT\_SEC. The sender returns MQXCC\_SEND\_SEC\_MSG, which causes a complementary event at the receiver exit.
4. The receiver is subsequently invoked with MQXR\_SEC\_MSG, and returns MQXCC\_SEND\_SEC\_MSG, which causes a complementary event at the sender exit.
5. The sender is subsequently invoked with MQXR\_SEC\_MSG, and returns MQXCC\_OK which requires no complementary event at the receiver exit.

Receiver exit	Sender exit
Invoked with MQXR_INIT Responds with MQXCC_OK	Invoked with MQXR_INIT Responds with MQXCC_OK
Invoked with MQXR_INIT_SEC Responds with MQXCC_OK	
	Invoked with MQXR_INIT_SEC Responds with MQXCC_SEND_SEC_MSG
Invoked with MQXR_SEC_MSG Responds with MQXCC_SEND_SEC_MSG	
<i>Message transfer begins</i>	Invoked with MQXR_SEC_MSG Responds with MQXCC_OK

Figure 117. Sender-initiated exchange with agreement

## Channel-exit programs

Receiver exit	Sender exit
Invoked with MQXR_INIT Responds with MQXCC_OK	Invoked with MQXR_INIT Responds with MQXCC_OK
Invoked with MQXR_INIT_SEC Responds with MQXCC_OK	
	Invoked with MQXR_INIT_SEC Responds with MQXCC_SEND_SEC_MSG
Invoked with MQXR_SEC_MSG Responds with MQXCC_OK	
	Invoked with MQXR_SEC_MSG Responds with MQXCC_SUPPRESS_FUNCTION  <i>Channel closes</i>
Invoked with MQXR_TERM Responds with MQXCC_OK	Invoked with MQXR_TERM Responds with MQXCC_OK

Figure 118. Sender-initiated exchange with no agreement

Receiver exit	Sender exit
Invoked with MQXR_INIT Responds with MQXCC_OK	Invoked with MQXR_INIT Responds with MQXCC_OK
Invoked with MQXR_INIT_SEC Responds with MQXCC_SEND_SEC_MSG	
	Invoked with MQXR_SEC_MSG Responds with MQXCC_SEND_SEC_MSG
Invoked with MQXR_SEC_MSG Responds with MQXCC_OK	
<i>Message transfer begins</i>	
Invoked with MQXR_TERM Responds with MQXCC_OK	Invoked with MQXR_TERM Responds with MQXCC_OK

Figure 119. Receiver-initiated exchange with agreement

Receiver exit	Sender exit
Invoked with MQXR_INIT Responds with MQXCC_OK	Invoked with MQXR_INIT Responds with MQXCC_OK
Invoked with MQXR_INIT_SEC Responds with MQXCC_SEND_SEC_MSG	
	Invoked with MQXR_SEC_MSG Responds with MQXCC_OK
Invoked with MQXR_SEC_MSG Responds with MQXCC_SUPRESS_FUNCTION	
<i>Channel closes</i>	

Figure 120. Receiver-initiated exchange with no agreement

## Channel-exit programs

The channel security exit program is passed an agent buffer containing the security data, excluding any transmission headers, generated by the security exit. This may be any suitable data so that either end of the channel is able to perform security validation.

The security exit program at both the sending and receiving end of the message channel may return one of four response codes to any call:

- Security exchange ended with no errors
- Suppress the channel and close down
- Send a security message to the corresponding security exit at the remote end
- Send a security message and demand a reply (this does not apply on OS/390 when using CICS)

### Notes:

1. The channel security exits usually work in pairs. When you define the appropriate channels, make sure that compatible exit programs are named for both ends of the channel.
2. In OS/400, security exit programs that have been compiled with “Use adopted authority” (USEADPAUT=\*YES) have the ability to adopt QMQM or QMQMADM authority. Take care that the exit does not exploit this feature to pose a security risk to your system.

## Channel send and receive exit programs

You can use the send and receive exits to perform tasks such as data compression and decompression. In V5.1 of MQSeries for AIX, AS/400, HP-UX, OS/2 Warp, Sun Solaris, and Windows NT, and with MQSeries clients, you can specify a list of send and receive exit programs to be run in succession.

Channel send and receive exit programs are called at the following places in an MCA's processing cycle:

- The send and receive exit programs are called for initialization at MCA initiation and for termination at MCA termination.
- The send exit program is invoked at either end of the channel, immediately before a transmission is sent over the link.
- The receive exit program is invoked at either end of the channel, immediately after a transmission has been taken from the link.

**Note:** For MQSeries for OS/390 using CICS, only the security exit is called at MCA initiation; other exits are called with the *ExitReason* parameter set to MQXR-INIT when the first message is sent across the channel.

There may be many transmissions for one message transfer, and there could be many iterations of the send and receive exit programs before a message reaches the message exit at the receiving end.

The channel send and receive exit programs are passed an agent buffer containing the transmission data as sent or received from the communications link. For send exit programs, the first eight bytes of the buffer are reserved for use by the MCA, and must not be changed. If the program returns a different buffer, then these first eight bytes must exist in the new buffer. The format of data presented to the exit programs is not defined.

A good response code must be returned by send and receive exit programs. Any other response will cause an MCA abnormal end (abend).

**Note:** Do not issue an MQGET, MQPUT, or MQPUT1 call within syncpoint from a send or receive exit.

V5.1 of MQSeries for AIX, HP-UX, OS/2 Warp, Sun Solaris, and Windows NT and the MQSeries client for Windows 95 and Windows 98 supply send and receive exit programs that use the DCE encryption security services. See “Supplied channel-exit programs using DCE security services” on page 537.

### Notes:

1. Send and receive exits usually work in pairs. For example a send exit may compress the data and a receive exit decompress it, or a send exit may encrypt the data and a receive exit decrypt it. When you define the appropriate channels, make sure that compatible exit programs are named for both ends of the channel.
2. Channel send and receive exits may be called for message segments other than for application data, for example, status messages. They are not called during the startup dialog, nor the security check phase.
3. Although message channels send messages in one direction only, channel-control data flows in both directions, and these exits are available in both directions, also. However, some of the initial channel startup data flows are exempt from processing by any of the exits.
4. There are circumstances in which send and receive exits could be invoked out of sequence; for example, if you are running a series of exit programs or if you are also running security exits. Then, when the receive exit is first called upon to process data, it may receive data that has not passed through the corresponding send exit. If the receive exit were just to perform the operation, for example decompression, without first checking that it was really required, the results would be unexpected.

You should code your send and receive exits in such a way that the receive exit can check that the data it is receiving has been processed by the corresponding send exit. The recommended way to do this is to code your exit programs so that:

- The send exit sets the value of the ninth byte of data to 0 and shifts all the data along one byte, before performing the operation. (The first eight bytes are reserved for use by the MCA.)
- If the receive exit receives data that has a 0 in byte 9, it knows that the data has come from the send exit. It removes the 0, performs the complementary operation, and shifts the resulting data back by one byte.
- If the receive exit receives data that has something other than 0 in byte 9, it assumes that the send exit has not run, and sends the data back to the caller unchanged.

When using security exits, if the channel is ended by the security exit it is possible that a send exit may be called without the corresponding receive exit. One way to prevent this from being a problem is to code the security exit to set a flag, in MQCD.SecurityUserData or MQCD.SendUserData, for example, when the exit decides to end the channel. Then the send exit should check this field, and process the data only if the flag is not set. This prevents the send exit from unnecessarily altering the data, and thus prevents any conversion errors that could occur if the security exit received altered data.

5. In the case of MQI channels for clients, byte 10 of message data identifies the API call in use when the send or receive exit is called. This is useful for identifying which channel flows include user data and may require processing such as encryption or digital signing.

## Channel-exit programs

Table 47 shows the data that appears in byte 10 of the channel flow when an API call is being processed.

**Note:** These are not the only values of this byte. There are other *reserved* values.

Table 47. Identifying API calls

API call	Value of byte 10
MQCONN request (5a, 5b)	X'81'
MQCONN reply (5a, 5b)	X'91'
MQDISC request (5a)	X'82'
MQDISC reply (5a)	X'92'
MQOPEN request (5c)	X'83'
MQOPEN reply (5c)	X'93'
MQCLOSE request	X'84'
MQCLOSE reply	X'94'
MQGET request (5d)	X'85'
MQGET reply (5d)	X'95'
MQPUT request (5d)	X'86'
MQPUT reply (5d)	X'96'
MQPUT1 request (5d)	X'87'
MQPUT1 reply (5d)	X'97'
MQSET request	X'88'
MQSET reply	X'98'
MQINQ request	X'89'
MQINQ reply	X'99'
MQCMIT request	X'8A'
MQCMIT reply	X'9A'
MQBACK request	X'8B'
MQBACK reply	X'9B'
<b>Notes:</b>	
a. The connection between the client and server is initiated by the client application using MQCONN. Therefore, for this command in particular, there will be several other network flows. This also applies to MQDISC that terminates the network connection.	
b. MQCONNX is treated in the same way as MQCONN for the purposes of the client-server connection.	
c. If a large distribution list is opened, there may be more than one network flow per MQOPEN call in order to pass all of the required data to the SVRCONN MCA.	
d. If the message data exceeds the transmission segment size, there may be a large number of network flows per single API call.	

## Channel message exit programs

You can use the channel message exit for the following:

- Encryption on the link
- Validation of incoming user IDs
- Substitution of user IDs according to local policy
- Message data conversion



- Journaling
- Reference message handling

In V5.1 of MQSeries for AIX, AS/400, HP-UX, OS/2 Warp, Sun Solaris, and Windows NT, you can specify a list of message exit programs to be run in succession.

Channel message exit programs are called at the following places in an MCA's processing cycle:

- At MCA initiation and termination
- Immediately after a sending MCA has issued an MQGET call
- Before a receiving MCA issues an MQPUT call

The message exit is passed an agent buffer containing the transmission queue header, MQXQH, and the application message text as retrieved from the queue. (The format of MQXQH is given in the *MQSeries Application Programming Reference* book.) If you use reference messages, that is messages that contain only a header which points to some other object that is to be sent, the message exit recognizes the header, MQRMH. It identifies the object, retrieves it in whatever way is appropriate appends it to the header, and passes it to the MCA for transmission to the receiving MCA. At the receiving MCA, another message exit recognizes that this is a reference message, extracts the object, and passes the header on to the destination queue. See the *MQSeries Application Programming Guide* for more information about reference messages and some sample message exits that handle them.

Message exits can return the following responses:

- Send the message (GET exit). The message may have been changed by the exit. (This returns MQXCC\_OK.)
- Put the message on the queue (PUT exit). The message may have been changed by the exit. (This returns MQXCC\_OK.)
- Do not process the message. The message is placed on the dead-letter queue (undelivered message queue) by the MCA.
- Close the channel.
- Bad return code, which causes the MCA to abend.

### Notes:

1. Message exits are called just once for every complete message transferred, even when the message is split into parts.
2. In UNIX systems, if you provide a message exit for any reason the automatic conversion of user IDs to lowercase characters does not operate. See "User IDs on UNIX systems, Digital OpenVMS" on page 120.
3. An exit runs in the same thread as the MCA itself. It also runs inside the same unit of work (UOW) as the MCA because it uses the same connection handle. Therefore, any calls made under syncpoint are committed or backed out by the channel at the end of the batch. For example, one channel message exit program can send notification messages to another and these messages will only be committed to the queue when the batch containing the original message is committed.

Therefore, it is possible to issue syncpoint MQI calls from a channel message exit program.

## Channel-exit programs

V5.1 of MQSeries for AIX, HP-UX, OS/2 Warp, Sun Solaris, and Windows NT supplies a message exit program that uses the DCE security services. See “Supplied channel-exit programs using DCE security services” on page 537.

### Channel message retry exit program

The channel message-retry exit is called when an attempt to open the target queue is unsuccessful. You can use the exit to determine under which circumstances to retry, how many times to retry, and how frequently. (This exit is not available on MQSeries for OS/390 or MQSeries for Windows.)

This exit is also called at the receiving end of the channel at MCA initiation and termination.

The channel message-retry exit is passed an agent buffer containing the transmission queue header, MQXQH, and the application message text as retrieved from the queue. The format of MQXQH is given in the *MQSeries Application Programming Reference* book.

The exit is invoked for all reason codes; the exit determines for which reason codes it wants the MCA to retry, for how many times, and at what intervals. (The value of the message-retry count set when the channel was defined is passed to the exit in the MQCD, but the exit can ignore this.)

The MsgRetryCount field in MQCXP is incremented by the MCA each time the exit is invoked, and the exit returns either MQXCC\_OK with the wait time contained in the MsgRetryInterval field of MQCXP, or MQXCC\_SUPPRESS\_FUNCTION. Retries continue indefinitely until the exit returns MQXCC\_SUPPRESS\_FUNCTION in the ExitResponse field of MQCXP. See “MQCXP - Channel exit parameter structure” on page 591 for information about the action taken by the MCA for these completion codes.

If all the retries are unsuccessful, the message is written to the dead-letter queue. If there is no dead-letter queue available, the channel stops.

If you do not define a message-retry exit for a channel and a failure occurs that is likely to be temporary, for example MQRC\_Q\_FULL, the MCA uses the message-retry count and message-retry intervals set when the channel was defined. If the failure is of a more permanent nature and you have not defined an exit program to handle it, the message is written to the dead-letter queue.

### Channel auto-definition exit program

The channel auto-definition exit can be called when a request is received to start a receiver or server-connection channel but no channel definition exists. The exit applies to V5.1 of MQSeries for AIX, AS/400, HP-UX, OS/2 Warp, Sun Solaris, and Windows NT. You can use it to modify the supplied default definition for an automatically defined receiver or server-connection channel, SYSTEM.AUTO.RECEIVER or SYSTEM.AUTO.SVRCON. See “Auto-definition of channels” on page 60 for a description of how channel definitions can be created automatically.

The channel auto-definition exit can also be called when a request is received to start a cluster-sender channel. It can be called for cluster-sender and cluster-receiver channels to allow definition modification for this instance of the channel. In this case, the exit applies to MQSeries for OS/390 as well as V5.1 of

MQSeries for AIX, AS/400, HP-UX, OS/2 Warp, Sun Solaris, and Windows NT. For more information about this, see the *MQSeries Administration Interface Programming Guide and Reference* book.

As with other channel exits, the parameter list is:

```
MQ_CHANNEL_AUTO_DEF_EXIT (ChannelExitParms, ChannelDefinition)
```

ChannelExitParms are described in “MQCXP - Channel exit parameter structure” on page 591. ChannelDefinition is described in “MQCD - Channel data structure” on page 556.

MQCD contains the values that are used in the default channel definition if they are not altered by the exit. The exit may modify only a subset of the fields; see “MQ\_CHANNEL\_AUTO\_DEF\_EXIT - Channel auto-definition exit” on page 551. However, attempting to change other fields does not cause an error.

The channel auto-definition exit returns a response of either MQXCC\_OK or MQXCC-SUPPRESS\_FUNCTION. If neither of these is returned, the MCA continues processing as though MQXCC-SUPPRESS\_FUNCTION were returned. That is, the auto-definition is abandoned, no new channel definition is created and the channel cannot start.

## Transport-retry exit program

The transport-retry exit applies to MQSeries for AIX, V5.1 and MQSeries for Windows V2.0 and is supported on UDP only. It allows you to write a C-language retry exit. The exit allows your application to suspend data being sent on a channel when communication is not possible (for example, when a mobile user is traveling through a tunnel or is temporarily out of range of a transmitter).

The transport-retry exit can be associated with a monitor program that can assess whether the IP connection is available for sending data. The exit has to be built into a library that is included in the path in which you are operating.

The exit is normally called before a datagram is about to be sent but is also called to provide other useful signals.

The retry exit is called under five different conditions:

- When the MQSeries channel is first initialized; the ExitReason variable is set to a value of MQXR\_INIT.
- When the MQSeries channel is shut down; the ExitReason variable is set to a value of MQXR\_TERM.
- Before each datagram is sent; the ExitReason variable is set to a value of MQXR\_RETRY.
- When the end of a batch of messages occurs; the ExitReason variable is set to a value of MQXR\_END\_BATCH.
- When an information datagram is received from the remote end of the link; the ExitReason variable is set to a value of MQXR\_ACK\_RECEIVED.

If you want to postpone sending a datagram in response to an ExitReason of MQXR\_RETRY, you need to block returning from the exit until it is safe to send the datagram. In all other cases, the return from the exit should be immediate.

There are three possible return codes that can be set when returning from the exit:

- MQXCC\_OK — this is the normal response.

## Channel-exit programs

- `MQXCC_CLOSE_CHANNEL` — in response to an `ExitReason` of `MQXR_RETRY`, this will cause the channel to be closed.
- `MQXCC_REQUEST_ACK` — in response to an `ExitReason` of `MQXR_RETRY`, this will cause the datagram about to be sent to be modified so that it requests the remote end of the link to send an information datagram back to indicate that the node can be reached. If this datagram arrives the exit will be invoked again with an `ExitReason` of `MQXR_ACK_RECEIVED`. You can set this return code on or off by using the `PSEUDO_ACK` parameter in the `qm.ini` file.

**Note:** If the datagram fails to arrive at the remote node, for any reason, you must repeat the request on the next datagram that is sent.

The transport-retry exit name can be defined by the user, who can also change the name of the library that contains the exit. You configure the retry exit by editing the `qm.ini` file. A `qm.ini` file exists on both MQSeries for AIX V5.1 and MQSeries for Windows V2.0. For more information about editing these files, see the *MQSeries System Administration* book.

---

## Writing and compiling channel-exit programs

Channel exits must be named in the channel definition. You can do this when you first define the channels, or you can add the information later using, for example, the MQSC command `ALTER CHANNEL`. You can also give the channel exit names in the MQCD channel data structure. The format of the exit name depends on your MQSeries platform; see “MQCD - Channel data structure” on page 556 or the *MQSeries Command Reference* book for information.

If the channel definition does not contain a user-exit program name, the user exit is not called.

The channel auto-definition exit is the property of the queue manager, not the individual channel. In order for this exit to be called, it must be named in the queue manager definition. To alter a queue manager definition, use the MQSC command `ALTER QMGR`.

User exits and channel-exit programs are able to make use of all MQI calls, except as noted in the sections that follow. To get the connection handle, an `MQCONN` must be issued, even though a warning, `MQRC_ALREADY_CONNECTED`, is returned because the channel itself is connected to the queue manager.

For exits on client-connection channels, the queue manager to which the exit tries to connect, depends on how the exit was linked. If the exit was linked with `MQM.LIB` (or `QMQM/LIBMQM` on OS/400) and you do not specify a queue manager name on the `MQCONN` call, the exit will try to connect to the default queue manager on your system. If the exit was linked with `MQM.LIB` (or `QMQM/LIBMQM` on OS/400) and you specify the name of the queue manager that was passed to the exit through the `QMgrName` field of `MQCD`, the exit tries to connect to that queue manager. If the exit was linked with `MQIC.LIB` or any other library, the `MQCONN` call will fail whether you specify a queue manager name or not.

**Note:** You are recommended to avoid issuing the following MQI calls in channel-exit programs:

- `MQCMIT`
- `MQBACK`
- `MQBEGIN`

## Channel-exit programs

An exit runs in the same thread as the MCA itself and uses the same connection handle. So, it runs inside the same UOW as the MCA and any calls made under syncpoint are committed or backed out by the channel at the end of the batch.

Therefore, a channel message exit could send notification messages that will only be committed to that queue when the batch containing the original message is committed. So, it is possible to issue syncpoint MQI calls from a channel message exit.

Channel-exit programs should not modify the Channel data structure (MQCD). They can actually change the BatchSize parameter and a security exit can set the MCAUserIdentifier parameter, but ChannelType and ChannelName must not be changed.

Also, for programs written in C, non-reentrant C library function should not be used in a channel-exit program.

All exits are called with a channel exit parameter structure (MQCXP), a channel definition structure (MQCD), a prepared data buffer, data length parameter, and buffer length parameter. The buffer length must not be exceeded:

- For message exits, you should allow for the largest message required to be sent across the channel, plus the length of the MQXQH structure.
- For send and receive exits, the largest buffer you should allow for is as follows:

**LU 6.2:**

OS/2 64 KB  
Others 32 KB

**TCP:**

AS/400 16 KB  
Others 32 KB

**UDP:**

32 KB

**NetBIOS:**

DOS 4 KB  
Others 64 KB

**SPX:**

64 KB

**Note:** Receive exits on sender channels and sender exits on receiver channels use 2 KB buffers for TCP.

- For security exits, the distributed queuing facility allocates a buffer of 4000 bytes.
- On OS/390 using CICS, all exits use the maximum transmission length for the channel, defined in the channel definition.

It is permissible for the exit to return an alternate buffer, together with the relevant parameters. See “MQ\_CHANNEL\_EXIT - Channel exit” on page 546 for call details.

**Note:** Before using a channel-exit program for the first time on V5.1 of MQSeries for AIX, AS/400, HP-UX, OS/2 Warp, Sun Solaris, and Windows NT, you should relink it with threaded libraries to make it thread-safe.

## Channel-exit programs

### MQSeries for OS/390 without CICS

The exits are invoked as if by an OS/390 LINK, in:

- Non-authorized problem program state
- Primary address space control mode
- Non-cross-memory mode
- Non-access register mode
- 31-bit addressing mode

The link-edited modules must be placed in the data set specified by the CSQXLIB DD statement of the channel initiator address space procedure; the names of the load modules are specified as the exit names in the channel definition.

When writing channel exits for OS/390 without CICS, the following rules apply:

- Exits must be written in assembler or C; if C is used, it must conform to the C systems programming environment for system exits, described in the *OS/390 C/C++ Programming Guide*.
- Exits are loaded from the non-authorized libraries defined by a CSQXLIB DD statement. Providing CSQXLIB has DISP=SHR, exits can be updated while the channel initiator is running, with the new version used when the channel is restarted.
- Exits must be reentrant, and capable of running anywhere in virtual storage.
- Exits must reset the environment, on return, to that at entry.
- Exits must free any storage obtained, or ensure that it will be freed by a subsequent exit invocation.

For storage that is to persist between invocations, use the OS/390 STORAGE service; there is no suitable service in C.

- All MQI calls except MQCMIT/CSQBCMT and MQBACK/CSQBBAK are allowed. They must be contained between MQCONN (with a blank queue manager name) and MQDISC, although not necessarily in the same exit invocation. If these calls are used, the exit must be link-edited with the stub CSQXSTUB.

The exception to this rule is that security channel exits may issue commit and backout MQI calls. To do this, code the verbs CSQXCMT and CSQXBAK in place of MQCMIT/CSQBCMT and MQBACK/CSQBBAK.

- Exits should not use any system services that could cause a wait, because this would severely impact the handling of some or all of the other channels. Many channels are run under a single TCB typically, if you do something in an exit that causes a wait and you do not use MQXWAIT, it will cause **all** these channels to wait. This will not give any functional problems, but might have an adverse effect on performance. Most SVCs involve waits, so you should avoid them, except for the following:
  - GETMAIN/FREEMAIN/STORAGE
  - LOAD/DELETE

In general, therefore, SVCs, PCs, and I/O should be avoided. Instead, the MQXWAIT call should be used.

- Exits should not issue ESTAEs or SPIEs, apart from in any subtasks they attach. This is because their error handling might interfere with the error handling performed by MQSeries. This means that MQSeries might not be able to recover from an error, or that your exit program might not receive all the error information.



- The MQXWAIT call (see “MQXWAIT - Wait” on page 553) provides a wait service that allows waiting for I/O and other events; if this service is used, exits must not use the linkage stack.  
For I/O and other facilities that do not provide non-blocking facilities or an ECB to wait on, a separate subtask should be ATTACHED, and its completion waited for by MQXWAIT; because of the overhead that this technique incurs, it is recommended that this be used only by the security exit.
- The MQDISC MQI call will not cause an implicit commit to occur within the exit program. A commit of the channel process is performed only when the channel protocol dictates.

The following exit samples are provided with MQSeries for OS/390:

### CSQ4BAX0

This sample is written in assembler, and illustrates the use of MQXWAIT.

### CSQ4BCX1 and CSQ4BCX2

These samples are written in C and illustrate how to access the parameters.

## MQSeries for OS/390 using CICS

In MQSeries for OS/390 using CICS, an exit program must be written in Assembler, C, COBOL, or PL/I. In CICS, the exits are invoked with EXEC CICS LINK with the parameters passed by pointers (addresses) in the CICS communication area (COMMAREA). The exit programs, named in the channel definitions, reside in a library in the DFHRPL concatenation. They must be defined in the CICS system definition file CSD, and must be enabled.

User-exit programs can also make use of CICS API calls, but you should not issue syncpoints because the results could influence units of work declared by the MCA.

Do not update any resources controlled by a resource manager other than MQSeries for OS/390, including those controlled by CICS Transaction Server for OS/390.

Any non-MQSeries for OS/390 resources updated by an exit are committed, or backed out, at the next syncpoint issued by the channel program. If a sender is unable to synchronize with its partner, these CICS Transaction Server for OS/390 resources are backed out even though MQSeries for OS/390 resources are held in-doubt until the next opportunity to re-synchronize.

## MQSeries for AS/400

The exit is a program object written in the C/400<sup>®</sup>, ILE COBOL/400<sup>®</sup> or ILE RPG/400<sup>®</sup> language. The exit program names and their libraries are named in the channel definition.

Observe the following conditions when creating and compiling an exit program:

- The program must be made thread safe and created with the C/400, ILE RPG/400, or ILE COBOL/400 compiler. For ILE RPG you must specify the THREAD(\*SERIALIZE) control specification, and for ILE COBOL you must specify SERIALIZE for the THREAD option of the PROCESS statement. The programs must also be bound to the threaded MQSeries libraries: QMQM/LIBMQM\_R in the case of C/400 and ILE RPG/400, and AMQ0STUB\_R in the case of ILE COBOL/400. For additional information about making RPG or COBOL applications thread safe, refer to the appropriate Programmer's Guide for the language.

## Channel-exit programs

- MQSeries for AS/400 requires that the exit programs are enabled for teraspace support. (Teraspace is a form of shared memory introduced in OS/400 V4R4.) In the case of the ILE RPG and COBOL compilers, any programs compiled on OS/400 V4R4 or later are so enabled. In the case of C, the programs must be compiled with the TERASPACE(\*YES \*TSIFC) options specified on CRTCMOD or CRTBNDC commands.
- An exit returning a pointer to its own buffer space must ensure that the object pointed to exists beyond the timespan of the channel-exit program. In other words, the pointer cannot be the address of a variable on the program stack, nor of a variable in the program heap. Instead, the pointer must be obtained from the system. An example of this is a user space created in the user exit. To ensure that any data area allocated by the channel-exit program is still available for the MCA when the program ends, the channel exit must run in the caller's activation group or a named activation group. Do this by setting the ACTGRP parameter on CRTPGM to a user-defined value or \*CALLER. If the program is created in this way, the channel-exit program can allocate dynamic memory and pass a pointer to this memory back to the MCA.

## MQSeries for OS/2 Warp

The exit is a DLL that must be written in C. To ensure that it can be loaded when required, specify the full path name in the DEFINE CHANNEL command, or if you are using Version 5.1, enter the path name in the ExitPath stanza of the QM.INI file. The value in the ExitPath stanza of the QM.INI file defaults to c:\mqm\exits. You can change this value in QM.INI or you can override it by specifying a full path name on the DEFINE CHANNEL command.

Define a dummy MQStart() routine in the exit and specify MQStart as the entry point in the shared library. Figure 121 shows how to set up entry to your program:

```
#include <cmqc.h>
#include <cmqxc.h>

void MQStart() {;} /* dummy entry point - for consistency only */
void MQENTRY ChannelExit ( PMQVOID pChannelExitParms,
                           PMQVOID pChannelDefinition,
                           PMQLONG pDataLength,
                           PMQLONG pAgentBufferLength,
                           PMQVOID pAgentBuffer,
                           PMQLONG pExitBufferLength,
                           PMQPTR pExitBufferAddr)
{
... Insert code here
}
```

Figure 121. Sample source code for a channel exit on OS/2

Figure 122 on page 523 shows a sample definition file that gives the entry point to the exit program.



```

LIBRARY csqos2it INITINSTANCE TERMINSTANCE
PROTMODE
DESCRIPTION 'channel exit '
CODE SHARED LOADONCALL
DATA NONSHARED MULTIPLE
HEAPSIZE 4096
STACKSIZE 8192
EXPORTS
    csqos2it;

```

Figure 122. Sample DEF file for a channel exit on OS/2

Use a make file like the one shown in Figure 123 to compile and link your program to create the DLL.

```

# MAKE FILE TO CREATE AN MQSERIES EXIT
# Make File Creation run in directory:
# D:\EXIT;

.SUFFIXES:

.SUFFIXES: .c .cpp .cxx

CSQOS2IT.DLL: \
    csqos2it.OBJ \
    MAKEOS2
    ICC.EXE @<<
    /Fe"CSQOS2IT.DLL" mqm.lib csqos2it.def
csqos2it.OBJ
<<
    IMPLIB CSQOS2IT.LIB CSQOS2IT.DLL

{.}.c.obj:
    ICC.EXE /Ge- /G5 /C .\$.c

{.}.cpp.obj:
    ICC.EXE /Ge- /G5 /C .\$.cpp

{.}.cxx.obj:
    ICC.EXE /Ge- /G5 /C .\$.cxx

!include MAKEOS2.DEP

```

Figure 123. Sample make file for a channel exit on OS/2

## Channel-exit programs

### Windows 3.1 client

The exit is a DLL that must be written in C. It must be placed in a directory pointed to by LIBPATH to ensure it can be loaded when required. Define a dummy MQStart() routine in the exit and specify MQStart as the entry point in the shared library. Figure 124 shows how to set up an entry to your program:

```
#include <cmqc.h>
#include <cmqxc.h>

void MQStart() {}; /* dummy entry point - for consistency only */
void MQENTRY ChannelExit ( PMQVOID pChannelExitParms,
                           PMQVOID pChannelDefinition,
                           PMQLONG pDataLength,
                           PMQLONG pAgentBufferLength,
                           PMQVOID pAgentBuffer,
                           PMQLONG pExitBufferLength,
                           PMQPTR pExitBufferAddr)
{
    ... Insert code here
}
```

Figure 124. Sample source code for a channel exit on Windows 3.1

### MQSeries for Windows NT server, MQSeries client for Windows NT, and MQSeries client for Windows 95 and Windows 98

The exit is a DLL that must be written in C.

- On MQSeries for Windows NT server, use the Control Service Manager User Interface snap-in within the Microsoft Management Console (MMC) in order to ensure that the DLL can be loaded when required. Specify the full path name on the DEFINE CHANNEL command or enter the path name in the ExitPath of the registry entry.

If the exit is on a Windows NT client, specify the path name in the ClientExitPath stanza of the registry file.

The default exit path is c:\WINNT\Profiles\All Users\Application Data\MQSeries\EXITS. You can change this value or you can override it by specifying a full path name on the DEFINE CHANNEL command.

- On MQSeries client for Windows 95 and Windows 98, specify the path name in the ExitPath stanza of the MQS.INI file. You can change this value or you can override it by specifying a full path name on the DEFINE CHANNEL command.

Define a dummy MQStart() routine in the exit and specify MQStart as the entry point in the library. Figure 125 on page 525 shows how to set up an entry to your program:

```

#include <cmqc.h>
#include <cmqxc.h>

void MQStart() {} /* dummy entry point - for consistency only */
void MQENTRY ChannelExit ( PMQCXP  pChannelExitParms,
                           PMQCD   pChannelDefinition,
                           PMQLONG pDataLength,
                           PMQLONG pAgentBufferLength,
                           PMQVOID pAgentBuffer,
                           PMQLONG pExitBufferLength,
                           PMQPTR  pExitBufferAddr)
{
... Insert code here
}

```

Figure 125. Sample source code for a channel exit on Windows NT, Windows 95, or Windows 98

In order to access the fields pointed to by pChannelExitParms and pChannelDefinition you need to insert the following lines in your exit program:

```

:
:
/* Variable definitions */
:
    PMQCXP      pParms;
    PMQCD       pChDef;
:
:
/* Code */
:
    pParms = (PMQCXP)pChannelExitParms;
    pChDef = (PMQCD)pChannelDefinition;

```

The pointers pParms and pChDef can then be dereferenced to access individual fields.

When writing channel exits for these products using Visual C++, you should do the following:

- Add MQMVX.LIB to project as a source file<sup>10</sup>.
- Change the box labelled “Use Run-Time Library” from “Multithreaded” to “Multithreaded using DLL” in the project settings under C/C++ code generation.
- Do not change the box labelled “Entry-Point Symbol”. This box can be found in the project settings, under the Link tab, when you select Category and then Output.
- Write your own .DEF file; an example of this is shown in Figure 126 on page 526.

10. MQMVX.LIB is used for data conversion and is not available on client products.

## Channel-exit programs

```
LIBRARY exit
PROTMODE

DESCRIPTION 'Provides Retry and Channel exits'

CODE SHARED    LOADONCALL
DATA NONSHARED MULTIPLE

HEAPSIZE  4096
STACKSIZE 8192

EXPORTS  Retry
```

Figure 126. Sample DEF file for Windows NT, Windows 95, Windows 98, or Windows

## MQSeries for Windows

The exit is a DLL that must be written in C. To ensure that it can be loaded when required, specify the full path name on the DEFINE CHANNEL command. Figure 127 shows how to set up an entry to your program:

```
#include <cmqc.h>
#include <cmqxc.h>

void MQENTRY ChannelExit ( PMQVOID pChannelExitParms,
                           PMQVOID pChannelDefinition,
                           PMQLONG pDataLength,
                           PMQLONG pAgentBufferLength,
                           PMQVOID pAgentBuffer,
                           PMQLONG pExitBufferLength,
                           PMQPTR  pExitBufferAddr)
{
    ... Insert code here
}
```

Figure 127. Sample source code for a channel exit on Windows

When writing channel exits for MQSeries for Windows using Visual C++, you should do the following:

- Change the box labelled “Use Run-Time Library” from “Multithreaded” to “Multithreaded using DLL” in the project settings under C/C++ code generation.
- Do not change the box labelled “Entry-Point Symbol”. This box can be found in the project settings, under the Link tab, when you select Category and then Output.
- Write your own .DEF file; an example of this is shown in Figure 126.

## MQSeries for AIX

**Note:** Before you use an existing user exit for the first time on MQSeries for AIX, V5.1, you must recompile it to enable it to take advantage of thread-safe system calls. If your user exits use thread-unsafe system calls, you will need to modify them before using them on this platform.

The exit is a dynamically loaded object that must be written in C. To ensure that it can be loaded when required, specify the full path name in the DEFINE CHANNEL command or enter the path name in the ExitPath stanza of the QM.INI file. If the exit is on an AIX client, specify the path name in the ClientExitPath

## Channel-exit programs

stanza of the MQS.INI file. The value in the ExitPath stanza of the QM.INI file or the ClientExitPath stanza of the MQS.INI file defaults to /var/mqm/exits. You can change this value or you can override it by specifying a full path name on the DEFINE CHANNEL command.

Define a dummy MQStart() routine in the exit and specify MQStart as the entry point in the module. Figure 128 shows how to set up an entry to your program:

```
#include <cmqc.h>
#include <cmqxc.h>

void MQStart() {} /* dummy entry point - for consistency only */
void MQENTRY ChannelExit ( PMQVOID pChannelExitParms,
                           PMQVOID pChannelDefinition,
                           PMQLONG pDataLength,
                           PMQLONG pAgentBufferLength,
                           PMQVOID pAgentBuffer,
                           PMQLONG pExitBufferLength,
                           PMQPTR pExitBufferAddr)
{
  ... Insert code here
}
```

*Figure 128. Sample source code for a channel exit on AIX*

Figure 129 shows the compiler and loader commands for channel-exit programs on AIX.

```
$ cc -c exit.c
$ ld -o exit exit.o -bE:exit.exp -H512 -T512 -e MQStart -bM:SRE
$ cp exit /usr/xmp/lib # (or wherever you require)
```

*Figure 129. Sample compiler and loader commands for channel exits on AIX*

## Channel-exit programs

Figure 131 shows a sample make file that can be used to build an MQSeries exit program, and Figure 130 shows a sample export file for this make file.

```
#!
csqaixit
MQStart
```

Figure 130. Sample export file for AIX

```
# MAKE FILE TO BUILD AN MQSERIES EXIT ON AIX

MQIDIR    = /usr/mqm
MQILIBDIR = $(MQIDIR)/lib
MQIINCDIR = $(MQIDIR)/inc

LIBEXIT   = -lmqm

CFLAGS    = -g -bloadmap:muck

ALL : CSQAIXIT

csqaixit: csqaixit.o
  xlc -L $(MQILIBDIR) $(LIBEXIT) csqaixit.o -o csqaixit \
    -bE:csqaixit.exp -H512 -T512 -e MQStart -bM:SRE

csqaixit.o : csqaixit.c
  xlc -c csqaixit.c \
    -I $(MQIINCDIR)
```

Figure 131. Sample make file for AIX

## MQSeries for Compaq (DIGITAL) OpenVMS

The user exit is a dynamically loaded image that can be shared, with its name taken from the format of the message. It must be written in C. The object's name must be in uppercase, for example MYFORMAT. The shareable image must be placed in sys\$share or a location defined by a logical name at executive level for it to be loaded.

User exits must be installed as known images. Figure 132 shows how to set up an entry to your program:

```
#include <cmqc.h>
#include <cmqxc.h>

void MQStart() {} /* dummy entry point */
void MQENTRY ChannelExit ( PMQVOID pChannelExitParms,
                           PMQVOID pChannelDefinition,
                           PMQLONG pDataLength,
                           PMQLONG pAgentBufferLength,
                           PMQVOID pAgentBuffer,
                           PMQLONG pExitBufferLength,
                           PMQPTR pExitBufferAddr)
{
  ... Insert code here
}
```

Figure 132. Sample source code for a channel exit on Digital OVMS

## Channel-exit programs

In the example, MQSTART is the initialization routine entry point for the MYFORMAT shareable image. The names of the routines that are called by the exit must be made universal.

```
$ CC /INCLUDE_DIRECTORY=MQS_INCLUDE exitname.C
$ LINK /SHARE=SYS$SHARE:[SYSLIB]MYFORMAT exitname.OBJ,MYFORMAT/OPTIONS
```

The contents of MYFORMAT.OPT vary depending on what platform you are working on:

On AXP:

```
SYSS$SHARE:MQM/SHAREABLE
SYMBOL_VECTOR=(MQSTART=PROCEDURE)
```

On VAX:

```
SYSS$SHARE:MQM/SHAREABLE
UNIVERSAL=MQSTART
```

If you are using threaded applications linked with the pthread library, you must also build a second copy of the exit with the thread options and libraries:

```
$ CC /INCLUDE_DIRECTORY=MQS_INCLUDE exitname.C
$ LINK /SHARE=SYS$SHARE:MYFORMAT exitname.OBJ,MYFORMAT/OPTIONS
```

Again, the contents of MYFORMAT.OPT vary depending on what platform you are working on:

On AXP:

```
SYSS$SHARE:MQM_R/SHAREABLE
SYSS$SHARE:CMA$OPEN_RTL.EXE/SHAREABLE
SYMBOL_VECTOR'-(MQSTART=PROCEDURE)
```

On VAX:

```
SYSS$SHARE:MQM_R/SHAREABLE
SYSS$SHARE:CMA$OPEN_RTL.EXE/SHAREABLE
UNIVERSAL=MQSTART
```

## MQSeries for DIGITAL UNIX (Compaq Tru64 UNIX)

The exit is a dynamically loaded object that must be written in C. To ensure that it can be loaded when required, link and copy the exit to the /usr/lib directory. Define a dummy MQStart() routine in the exit and specify MQStart as the entry point in the module. Figure 133 on page 530 shows how to set up an entry to your program:

## Channel-exit programs

```
#include <cmqc.h>
#include <cmqxc.h>

void MQStart() {} /* dummy entry point - for consistency only */
void MQENTRY ChannelExit ( PMQVOID pChannelExitParms,
                           PMQVOID pChannelDefinition,
                           PMQLONG pDataLength,
                           PMQLONG pAgentBufferLength,
                           PMQVOID pAgentBuffer,
                           PMQLONG pExitBufferLength,
                           PMQPTR pExitBufferAddr)
{
    ... Insert code here
}
```

Figure 133. Sample source code for a channel exit on DIGITAL UNIX

Figure 134 shows the compiler and loader commands for channel-exit programs on DIGITAL UNIX.

```
$ cc -stdl -c -I/opt/mqm/inc exit.c
$ ld -o exit exit.o -shared -L/opt/mqm/lib -lmqm -e MQStart -lc
$ cp exit /usr/lib
```

Figure 134. Sample compiler and loader commands for channel exits on DIGITAL UNIX

## MQSeries for HP-UX

**Note:** Before you use an existing user exit for the first time on MQSeries for HP-UX, V5.1, you must recompile it to enable it to take advantage of thread-safe system calls. If your user exits use thread-unsafe system calls, you will need to modify them before using them on this platform.

The exit is a dynamically loaded object that must be written in C. To ensure that it can be loaded when required, specify the full path name in the DEFINE CHANNEL command or enter the path name in the ExitPath stanza of the QM.INI file. If the exit is on an HP-UX client, specify the path name in the ClientExitPath stanza of the MQS.INI file. The value in the ExitPath stanza of the QM.INI file or the ClientExitPath stanza of the MQS.INI file defaults to /var/mqm/exits. You can change this value or you can override it by specifying a full path name on the DEFINE CHANNEL command.

Define a dummy MQStart() routine in the exit and specify MQStart as the entry point in the module. Figure 135 on page 531 shows how to set up an entry to your program:



```

#include <cmqc.h>
#include <cmqxc.h>

void MQStart() {}; /* dummy entry point - for consistency only */
void MQENTRY ChannelExit ( PMQVOID pChannelExitParms,
                           PMQVOID pChannelDefinition,
                           PMQLONG pDataLength,
                           PMQLONG pAgentBufferLength,
                           PMQVOID pAgentBuffer,
                           PMQLONG pExitBufferLength,
                           PMQPTR pExitBufferAddr)
{
... Insert code here
}

```

Figure 135. Sample source code for a channel exit on HP-UX

Figure 136 shows the compiler and loader commands for channel-exit programs on HP-UX.

```

$ cc -c +z exit.c
$ ld -o exit exit.o +b : -c exit.exp +I MQStart -b
$ cp exit /usr/xmp/lib # (or wherever you require)

```

Figure 136. Sample compiler and loader commands for channel exits on HP-UX

## MQSeries for AT&T GIS UNIX

The exit is a dynamically loaded object that must be written in C. Specify the full path name in the DEFINE CHANNEL command. Define a dummy MQStart() routine in the exit and specify MQStart as the entry point in the module. Figure 137 shows how to set up an entry to your program:

```

#include <cmqc.h>
#include <cmqxc.h>

void MQStart() {}; /* dummy entry point */
void MQENTRY ChannelExit ( PMQVOID pChannelExitParms,
                           PMQVOID pChannelDefinition,
                           PMQLONG pDataLength,
                           PMQLONG pAgentBufferLength,
                           PMQVOID pAgentBuffer,
                           PMQLONG pExitBufferLength,
                           PMQPTR pExitBufferAddr)
{
... Insert code here
}

```

Figure 137. Sample source code for a channel exit on AT&T GIS UNIX

Figure 138 on page 532 shows the compiler and loader commands for channel-exit programs on AT&T GIS UNIX<sup>11</sup>.

11. This platform has become NCR UNIX SVR4 MP-RAS, R3.0

## Channel-exit programs

```
$ cc -c PIC exit.c
$ ld -o exit -G exit.o
$ cp exit /usr/xmp/lib # (or wherever you require)
```

*Figure 138. Sample compiler and loader commands for channel exits on AT&T GIS UNIX*

## MQSeries for Sun Solaris

**Note:** Before you use an existing user exit for the first time on MQSeries for Sun Solaris, V5.1, you must recompile it to enable it to take advantage of thread-safe system calls. If your user exits use thread-unsafe system calls, you will need to modify them before using them on this platform. If you have DCE installed, your channel exits must be threaded with DCE threading. If you do not have DCE installed, your channel exits must be threaded with Posix V10 threading.

The exit is a dynamically loaded object that must be written in C. To ensure that it can be loaded when required, specify the full path name in the DEFINE CHANNEL command or enter the path name in the ExitPath stanza of the QM.INI file. If the exit is on a Sun Solaris client, specify the path name in the ClientExitPath stanza of the MQS.INI file. The value in the ExitPath stanza of the QM.INI file or the ClientExitPath stanza of the MQS.INI file defaults to /var/mqm/exits. You can change this value or you can override it by specifying a full path name on the DEFINE CHANNEL command.

Define a dummy MQStart() routine in the exit and specify MQStart as the entry point in the module. Figure 139 shows how to set up an entry to your program:

```
#include <cmqc.h>
#include <cmqxc.h>

void MQStart() {;} /* dummy entry point */
void MQENTRY ChannelExit ( PMQVOID pChannelExitParms,
                          PMQVOID pChannelDefinition,
                          PMQLONG pDataLength,
                          PMQLONG pAgentBufferLength,
                          PMQVOID pAgentBuffer,
                          PMQLONG pExitBufferLength,
                          PMQPTR pExitBufferAddr)
{
    ... Insert code here
}
```

*Figure 139. Sample source code for a channel exit on Sun Solaris*

Figure 140 shows the compiler and loader commands for channel-exit programs on Sun Solaris.

```
$ cc -c -KPIC exit.c
$ ld -G exit.o -o exit
$ cp exit /usr/xmp/lib # (or wherever you require)
```

*Figure 140. Sample compiler and loader commands for channel exits on Sun Solaris*

## MQSeries for SINIX and DC/OSx

The exit is a dynamically loaded object that must be written in C. Specify the full path name in the DEFINE CHANNEL command. Define a dummy MQStart()

routine in the exit and specify MQStart as the entry point in the module. Figure 141 shows how to set up an entry to your program:

```
#include <cmqc.h>
#include <cmqxc.h>

void MQStart() {} /* dummy entry point */
void MQENTRY ChannelExit ( PMQVOID pChannelExitParms,
                           PMQVOID pChannelDefinition,
                           PMQLONG pDataLength,
                           PMQLONG pAgentBufferLength,
                           PMQVOID pAgentBuffer,
                           PMQLONG pExitBufferLength,
                           PMQPTR pExitBufferAddr)
{
    ... Insert code here
}
```

Figure 141. Sample source code for a channel exit on SINIX and DC/OSx

Figure 142 shows the compiler and loader commands for channel-exit programs on SINIX and DC/OSx.

```
$ cc -Kpic exit.c -G -o exit -lmqm -lmqmcs
$ cp exit /opt/mqm/lib # (or wherever you require)
```

Figure 142. Sample compiler and loader commands for channel exits on SINIX and DC/OSx

For DC/OSx, version cd087 and later, append the following to the cc line:

```
-liconv -lresolv
```

For earlier versions of DC/OSx, append the following to the cc line:

```
-liconv
```

## MQSeries for Tandem NonStop Kernel

MQSeries for Tandem NonStop Kernel supports a single, statically bound channel-exit program, whose entry point is MQ\_CHANNEL\_EXIT(). The exit must be written in C. MQSeries for Tandem NonStop Kernel provides a stub function for this exit that acts as a placeholder for user-supplied exit code. In the supplied stub function, the *ExitResponse* field in MQCXP (channel exit parameter structure) is set to MQXCC\_CLOSE\_CHANNEL, which causes the MCA to close the channel. No other fields in MQCXP are modified.

You replace the supplied stub function in the MCA executable images with your own user exit code using the Tandem BIND utility BEXITE. Only the Tandem Common Runtime Environment (CRE) interface for the WIDE memory model is supported.

In MQSeries for Tandem NonStop Kernel, there is a single entry point for all channel exits. In other MQSeries Version 2 products, there are entry points specific to each channel type and function. It is possible to use channel-exit programs written for other MQSeries Version 2 products by calling those programs from MQ\_CHANNEL\_EXIT(). To determine the type of exit being called, examine the *ExitId* field of MQCXP, then extract the associated exit-program name from the *MsgExit*, *MsgRetryExit*, *ReceiveExit*, *SendExit*, or *SecurityExit* field of MQCD.

The channel attributes that define the names of user exits are:

## Channel-exit programs

- Security exit name (SCYEXIT)
- Message-retry exit name (MREXIT)
- Message exit name (MSGEXIT)
- Send exit name (SENDEXIT)
- Receive exit name (RCVEXIT)

If these channel attributes are left blank, the channel user exit is not invoked. If any of the channel attributes is nonblank, the MQ\_CHANNEL\_EXIT() user exit program is invoked for the corresponding function. Note that the text-string value of the channel attribute is not used to determine the name of the user exit program, since only a single entry point, MQ\_CHANNEL\_EXIT(), is supported in MQSeries for Tandem NonStop Kernel. However, the values of these channel attributes are passed to MQ\_CHANNEL\_EXIT() in the MQCD (channel data) structure. The function of the channel exit (that is, whether the exit corresponds to a Message, Message-retry, Receive, Security or Send Exit) is passed to MQ\_CHANNEL\_EXIT() in the *ExitId* field of the MQCXP (Channel Exit Parameters) structure.

MQSeries for Tandem NonStop Kernel does not support the following channel attributes:

- CICS Profile Name
- Sequential delivery
- Target system identifier
- Transaction identifier
- Maximum transmission size

### Building and using channel exit functions

Dynamically bound libraries are not supported by MQSeries for Tandem NSK. Channel exits (and data-conversion exits) are implemented by including statically bound stub functions in the MQSeries libraries and executables which can be replaced using the REPLACE bind option.

A channel exit function must be written in C, **must** be called CHANNELEXIT (see sample MQSVCHX), and can be bound into the chosen executable (or library) using the TACL macro BEXITE.

**Note:** This procedure modifies the target executable. Therefore, you are recommended to make a backup copy of the target executable or library before using the macro.

The function CHANNELEXIT must handle each of the possible exit calls (security, message-retry, message, send, and receive). You may write your own functions to do this.

Use the TACL macro BCHXALL to bind the data conversion exit into all required MQSeries processes. For example:

```
BCHXALL source-exit-file-or-library
```

### Sample channel exit:

```
/* **** */
/*
/* Program name: MQSVCHXE
/*
/* Description: Sample C skeleton of a Channel Exit controlling
/*              function
/*
/* Statement:    Licensed Materials - Property of IBM
/*
```

```

/*                                                    */
/*          33H2205, 5622-908                          */
/*          33H2267, 5765-623                          */
/*          29H0990, 5697-176                          */
/*          (C) Copyright IBM Corp. 1994, 1995         */
/*                                                    */
/*****/
/*                                                    */
/* Function:                                           */
/*                                                    */
/* MQSVCHXE is a sample C skeleton of a Channel Exit controlling */
/* function                                           */
/*                                                    */
/* The function controls the calls to user-defined channel exits */
/*                                                    */
/*                                                    */
/* Once complete the code should be compiled into a loadable */
/* object, the name of the object should be the name of the */
/* format to be converted. Instructions on how to do this are */
/* contained in the README file in the current directory. */
/*                                                    */
/*****/
/* MQSVFCXE takes the parameters defined for a Data Conversion */
/* exit routine in the CMQXC.H header file.           */
/*                                                    */
/*****/
#include <cmqc.h>           /* For MQI datatypes          */
#include <cmqxc.h>         /* For MQI exit-related definitions */
#include <amqsvmht.h>      /* For sample macro definitions    */

/*****/
/* Insert the function prototypes for the functions produced by */
/* the data conversion utility program.                         */
/*****/

MQDATACONVEXIT CHANNELEXIT;

/*****/
/* On some Unix systems, the name of this function is not important */
/* as it is not actually used to call the conversion exit but it */
/* must be an exported symbol or the entry point to the module. On */
/* the TANDEM NSK this function MUST be called CHANNELEXIT */
/*****/

void
MQENTRY CHANNELEXIT(
    PMQVOID pChannelExitParms, /* Channel exit parameter block */
    PMQVOID pChannelDefinition, /* Channel definition */
    PMQLONG pDataLength, /* Length of data */
    PMQLONG pAgentBufferLength, /* Length of agent buffer */
    PMQVOID pAgentBuffer, /* Agent buffer */
    PMQLONG pExitBufferLength, /* Length of exit buffer */
    PMQPTR pExitBufferAddr) /* Address of exit buffer */
{
    PMQCXP pCEP = pChannelExitParms;
    PMQCD pCD = pChannelDefinition;
    MQLONG ExitId = pCEP->ExitId;
    MQLONG ExitReason = pCEP->ExitReason;

    pCEP->ExitResponse = MQXCC_OK ;

    /* Call the handling function according to the ExitId */
    /* By default, there are no exits. If there are, then */
    /* this function will have been replaced by a bind */

    switch (ExitId)
    {

```

## Channel-exit programs

```
case MQXT_CHANNEL_SEC_EXIT:
    if (strlen(pCD->SecurityExit) == 0)
    {
        pCEP->ExitResponse = MQXCC_SUPPRESS_FUNCTION ;
    }
    else
    {
        /* Call the security exit function here */
    }
    break;
case MQXT_CHANNEL_MSG_EXIT:
    /* Call the channel message exit function here */
    if (strlen(pCD->MsgExit) == 0)
    {
        pCEP->ExitResponse = MQXCC_SUPPRESS_FUNCTION ;
    }
    else
    {
        /* Call the message exit function here */
    }
    break;
case MQXT_CHANNEL_SEND_EXIT:
    /* Call the channel send exit function here */
    if (strlen(pCD->SendExit) == 0)
    {
        pCEP->ExitResponse = MQXCC_SUPPRESS_FUNCTION ;
    }
    else
    {
        /* Call the send exit function here */
    }
    break;
case MQXT_CHANNEL_RCV_EXIT:
    /* Call the channel receive exit function here */
    if (strlen(pCD->ReceiveExit) == 0)
    {
        pCEP->ExitResponse = MQXCC_SUPPRESS_FUNCTION ;
    }
    else
    {
        /* Call the receive exit function here */
    }
    break;
case MQXT_CHANNEL_MSG_RETRY_EXIT:
    /* Call the channel retry exit function here */
    if (strlen(pCD->MsgRetryExit) == 0)
    {
        pCEP->ExitResponse = MQXCC_SUPPRESS_FUNCTION ;
    }
    else
    {
        /* Call the message retry exit function here */
    }
    break;
default:
    /* if the exit isn't recognized, stop it from being called again */
    pCEP->ExitResponse = MQXCC_SUPPRESS_EXIT ;
    break;
}
return;
}
/*****
/*
/* END OF MQSVCHXE
/*
*****/
```

## Supplied channel-exit programs using DCE security services

V5.1 of MQSeries for AIX, HP-UX, OS/2 Warp, Sun Solaris, and Windows NT supply channel-exit programs for the security exit, the message exit, and the send and receive exits. The MQSeries client for Windows 95 and Windows 98 supplies channel-exit programs for the security exit and the send and receive exits. These programs take advantage of the Distributed Computing Environment (DCE) security services and encryption facilities. Before using the supplied exit programs from an MQSeries client for Windows 95 and Windows 98, see the note under “How to use the DCE channel-exit programs” on page 540.

The programs are supplied in source and object format. You can use the objects as they stand, or can use the source as the basis for creating your own user-exit programs. You should bear in mind that whereas the objects are supplied as working programs, the source code does not include any provision for tracing or error handling. If you chose to modify and use the source code, you should add your own tracing and error-handling routines.

The object has two entry points:

### **DCE\_SEC\_SCY\_CHANNELEXIT**

For the security exit, which can be used to access authentication services.

### **DCE\_SEC\_SRM\_CHANNELEXIT**

For the send, receive, and message exits, which can be used to access data encryption services.

## What do the DCE channel-exit programs do?

The supplied channel-exit programs address the Distributed Computing Environment (DCE) considerations for security in the areas of data encryption, and of authentication of a partner system when establishing a session. For a particular channel, each exit program has an associated *DCE principal* (similar to a user ID). A connection between two exit programs is an association between the two principals.

A secure connection between two security exit programs, one for the sending MCA and one for the receiving MCA, is established after the underlying session has been established. The sequence of operations is as follows:

1. Each program is associated with a particular principal, for example due to an explicit DCE Login.
2. The program that initiates the secure connection, that is the first program to get control after the MCA session has been established, is known as the *Context Initiator*. The context initiator requests a secure connection with the named partner from the DCE security server and receives a token. The token (called token1 in Figure 143 on page 538) is sent, using the already established underlying session, to the partner program.
3. The partner program (known as the *Context Acceptor*) passes token1 to the DCE security server, which verifies that the Context Initiator is authentic. For mutual authentication, as implemented by the supplied security exit, the DCE security server also generates a second token (called token2 in Figure 143 on page 538), which the Context Acceptor returns to the Context Initiator using the underlying session.
4. The Context Initiator uses token2 to verify that the Context Acceptor is authentic.

At this stage, if both applications are satisfied with the authenticity of the partner’s token, then the secure (authenticated) connection is established.

## Channel-exit programs

- The token exchange described above establishes a *Security Context* for each security exit program. This context enables the subsequent send, receive, and message exits to encrypt and decrypt data passed on the connection.

DCE Security provides an API to 'seal' and 'unseal' data and hence to selectively protect specified elements of a datastream. The supplied message, send, and receive exits encrypt and decrypt messages using these DCE Security API calls.

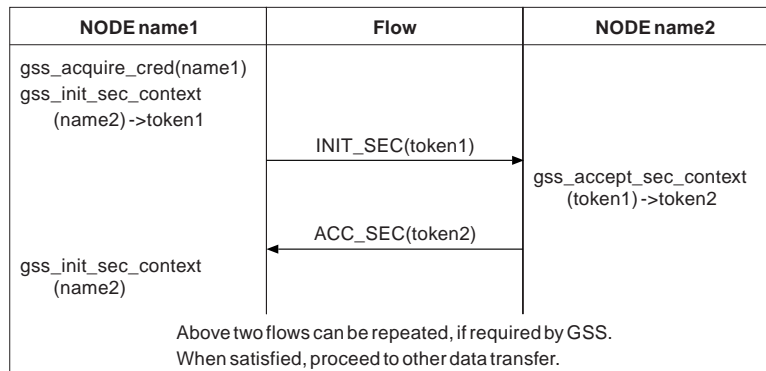

Figure 143. Security exit flows

Clearly the encryption algorithm used by the send exit must match the decryption algorithm used by the receive exit. The supplied send, receive, and message exits use the `gss_seal()` and `gss_unseal()` calls to encrypt and decrypt data. The `qop_req` parameter on the `gss_seal()` call is set to `GSS_C_QOP_DEFAULT`. The encryption provided by DCE depends on the DCE product installed. The supplied encrypting exits work correctly only when used with US-domestic DCE products supporting DES encryption. See the *MQSeries Planning Guide* for information about which DCE products are supported.

The send, receive, and message exits are all used for encryption. The difference is that the message exit encrypts only the content of the message, whereas the send and receive exits also encrypt the message headers. Therefore, the message exit offers slightly better performance but at the expense of unencrypted header data.

## How do the DCE channel-exit programs work?

The supplied code implements a security exit and message, send, and receive exits. Note that the message exit does not encrypt the MQSeries header. The security exit provides mutual (two-way) authentication. The message, send, and receive exits provide encryption facilities based on a key managed by the security context set up by the security exit. Therefore, the message, send, and receive exits will not work unless the security exit has been called previously.

The code interfaces to DCE through the DCE GSS API provided as part of OSF DCE 1.1. This API provides a superset of the standard GSS API calls as specified in Internet RFCs 1508 and 1509. Some DCE-specific GSS calls have been added to the API by OSF.

The principal of an MQSeries system that has a queue manager is the queue manager name.



An MQSeries client does not have a queue manager. The principal used for a client is as follows:

- On Sun Solaris, AIX, HP-UX, Windows NT, Windows 95, and Windows 98 clients:
  - If the login user ID of the user who started the MQSeries client application can be obtained and is defined as a principal to DCE, this user ID is used.
  - If the login user ID of the user who started the MQSeries client application cannot be obtained or is not defined to DCE, and a DCE default login context exists, the DCE default credential is used.
- Note:** When a principal logs in to DCE, a default login context is established. In this case the principal used in association with the DCE default credential is that of the principal logged in to DCE.
- If the login user ID of the user who started the MQSeries client application cannot be obtained or is not defined to DCE, and no DCE default login context exists, there is no principal name available and the security exit rejects the attempt to start the channel.
- On OS/2 clients, user IDs cannot be used as principals.
  - If a principal has logged in to DCE, the name of this logged in principal is used.
  - If a principal has not logged in to DCE, and a DCE default login context exists, the DCE default credential is used.
  - If a principal has not logged in to DCE, and no DCE default login context exists, there is no principal name available and the security exit rejects the attempt to start the channel.

It is important that queue manager names or user IDs that are to be used as DCE principals are syntactically acceptable to DCE; see your DCE documentation for information about valid DCE principal names. If the name is to be used only within the local cell directory, the only mismatch between the allowable characters in a queue manager name and the allowable characters in a principal name is that a principal name cannot contain a '/'. If there is any likelihood that the name will also need to be reflected in a global directory, you are recommended to restrict principal names to alphanumeric characters. As with any DCE principal, when you create it you must define it to the DCE security server and must also put an entry for it in the relevant keytable file. Therefore, when you delete a queue manager that is also a DCE principal you must remember to delete both its entries.

Remote queue manager names are transferred across a channel at channel initialization. When the security exit is called, if the remote MQSeries system is not a client, the remote queue manager name (which is also the remote principal) is passed to the security exit in the MQSeries MQCXP parameter list. The initiator exit uses the name provided. If the channel is being established between an MQSeries client and an MQSeries server, the client always initiates the first security flow. In all cases, the initiator exit's remote principal name is a queue manager name.

The flows shown in Figure 143 on page 538 occur to establish the security context. As a part of these flows the initiator's principal is transferred to the acceptor.

It is possible to establish multiple security contexts between the same pair of principals, and hence to allow parallel channels to use the security exit.

## Channel-exit programs

You can set up *restricted* channels. The system administrator supplies a value in the Channel Security Exit User Data when defining this end of the channel. The presence of this value causes the security exit to check the remote principal name. If this check shows a mismatch the channel is not established. Note that the remote principals (queue manager names and default DCE principals) may be longer than the 32 characters allowed in the Channel Security Exit User Data. Only the first 32 characters of the remote principal are considered significant.

If the MCA forms part of an MQSeries server system connected to a client, the security exchange will have caused the client principal to flow to the server. If the value is valid with regard to the optional restricted-channel check and the MCAUserIdentifier variable is not already defined, the client principal is copied into the server's MCAUserIdentifier variable. Note that client principals may be longer than the 12-character MCAUserIdentifier. Only the first 12 characters of such a remote principal are copied.

Thus the first 12 characters of the MQSeries client's DCE principal name can become the user identifier to be used by the server's MCA for authorization for that client to access MQSeries resources. The server system must be set up appropriately to allow this to work.

## How to use the DCE channel-exit programs

Do not run the supplied DCE message exit in combination with the supplied DCE send and receive exits on the same channel.

To use the supplied channel-exit programs you need to install DCE and define some channels. For installation information, see the *Quick Beginnings* book for your platform:

- The *MQSeries for AIX, V5.1 Quick Beginnings* book.
- The *MQSeries for HP-UX, V5.1 Quick Beginnings* book.
- The *MQSeries for Sun Solaris, V5.1 Quick Beginnings* book.
- The *MQSeries for OS/2 Warp, V5.1 Quick Beginnings* book.
- The *MQSeries for Windows NT, V5.1 Quick Beginnings* book.

**Note:** Using IBM DCE for Windows 95 V1, you cannot use the supplied DCE security exit from a Windows 95 client connected to an MQSeries for HP-UX server or an MQSeries for Sun Solaris server. Nor can you use the supplied send and receive exits from a Windows 95 client when using IBM DCE for Windows 95 V1.

### Setup for DCE

The supplied channel-exit programs are intended for use between systems operating within a single DCE cell. The setup of a DCE cell is described in the documentation provided with the DCE packages for the platforms incorporated in the cell. The exit programs operate the same way whether they are running on a system with a DCE security client installed or with a DCE security server installed.

Once the DCE cell has been configured, it is necessary to define the principals that the exit is going to use to DCE. DCE setup samples are provided on all the supported platforms. The samples are primarily intended for setting up DCE for the DCE Names installable component. They also contain comments indicating how they can be modified to set up the DCE security principals instead of, or as well as, the Names principal.

Each DCE security principal has its own keytable. On UNIX systems that support DCE security, the keytable is a file within the directory `/var/mqm/dce/keytabs`. On OS/2, Windows NT, Windows 95, and Windows 98 it is a file within the directory `\MQM\DCE\KEYTABS`, where *MQM* is the name of your work path.

When the supplied channel-exit programs are called for a particular principal, they look in a keytable file that has the same name as the principal itself. Therefore, the keytable file for a particular principal must have the same name as that principal.

The use of separate keytables for each principal is recommended in the OSF DCE literature. On systems that support file access controls (UNIX systems and Windows NT) keytable access should be limited to:

- Superuser/administrator: no restriction
- Other user IDs:
  - read only access, given only to the user IDs under which the processes that call the security exits run, and only to the relevant keytables.

In the case of queue manager MQSeries systems, the processes that interface to the security exits at the sending end of the channel are `runmqchl` (and `runmqchi` on OS/2 and Windows NT). `amqcrsta`, `amqcrs6a` or `runmqslr` interface to the security exits at the receiving end of the channel. On most systems these all run under the `mqm` user ID; in this case, non-supervisor/administrator access to the keytables relating to queue manager principals should be restricted to read access for the `mqm` user ID.

On client systems the user ID under which the security exit is called is the user ID under which the client application runs (often the login user ID of the user of the client system). Again, non-supervisor/administrator access to the relevant keytable should be restricted to read access by that user ID only.

### The supplied exit code

The supplied exit code is in two formats: object and source.

**Object:** The object is called `amqrdsc0` on UNIX systems and `amqrdsc0.DLL` on OS/2, Windows NT, Windows 95, and Windows 98. It is installed as a standard part of the MQSeries product for your platform and is loaded as a standard user exit. If you wish to run the supplied security channel exit to make use of authentication services then in your definition of the channel, specify:

```
SCYEXIT('<path>amqrdsc0(DCE_SEC_SCY_CHANNELEXIT)')
```

If you also wish to use the message exit to support data encryption, then in your definition of the channel, specify:

```
MSGEXIT('<path>amqrdsc0(DCE_SEC_SRM_CHANNELEXIT)')
```

Or you can use the send and receive exits to support data encryption by specifying the following in your definition of the channel:

```
SENDEXIT('<path>amqrdsc0(DCE_SEC_SRM_CHANNELEXIT)')  
RCVEXIT('<path>amqrdsc0(DCE_SEC_SRM_CHANNELEXIT)')
```

`<path>` is the path to the directory containing the exit.

See page 520 through page 533 for information about how to call user exits on the platform you are using.

## Channel-exit programs

**Source:** The exit source file is called `amqsdsc0.c`. It can be found in `<mqmtop>/samp` on UNIX systems and in `<bootdrive>:\mqm\tools\c\samples` on OS/2, Windows NT, Windows 95, and Windows 98. If you choose to modify the source versions, rather than running the objects as they stand, you will need to recompile the modified source. It is compiled and linked in the same way as any other channel exit for the platform concerned, except that DCE headers need to be accessed at compile time, and the DCE libraries, together with any recommended associated libraries, need to be accessed at link time. Refer to the documentation for the DCE product for the platform you are using, to find out about the DCE and associated libraries.

### OS/2

```
icc /DIBMOS2 /DINTEL80x86 /Fe amqsdsc0.dll /I \  
c:\mqclient\tools\c\include /I \  
c:\ibmcppw\include /I c:\opt\dce\local\include\dce \  
/W3 /Sa /Ge- /Gm+ amqsdsc0.c amqsdsc0.def dceos2.lib
```

Using the following definition file:

```
LIBRARY AMQSDSC0  
PROTMODE  
DESCRIPTION 'DCE Security Exit'  
CODE SHARED LOADONCALL  
DATA NONSHARED MULTIPLE  
HEAPSIZE 4096  
STACKSIZE 8192  
EXPORTS  
DCE_SEC_SCY_CHANNELEXIT  
DCE_SEC_SRM_CHANNELEXIT
```

### Sun Solaris

```
cc -I/opt/dce/share/include/dce \  
-I/opt/mqm/inc -c amqsdsc0.c
```

followed by:

```
ld -G -L/opt/dce/share/usr/lib -ldce amqsdsc0.o -o srm
```

### HP-UX

```
cc -D_HPUX_SOURCE -Dhpux -DICOL -D_REENTRANT \  
-Dsigaction=cma_sigaction +ESlit +DA1.0 -c +z \  
amqsdsc0.c -I /opt/mqm/include -I /opt/dce/include/dce \  
-Aa && ld -o amqsdsc0 amqsdsc0.o -z +b : -b +I MQStart \  
-ldce -lmqm_r -lndbm -lM -lc_r
```

### Windows 95, Windows 98, and Windows NT

```
c:\msdevstd\bin\cl /DAMQ_PC /VERBOSE /LD /MT \  
/Ic:\msdevstd\include /ID:\MQCLIENT\TOOLS\C\INCLUDE \  
/IC:\OPT\DIGITAL\DCE\INCLUDE\DCE amqsdsc0.c \  
-link /DLL /EXPORT:DCE_SEC_SCY_CHANNELEXIT \  
/EXPORT:DCE_SEC_SRM_CHANNELEXIT /STACK:8192 libdce.lib \  
advapi32.lib libcmt.lib
```

### AIX

```
x1C_r -c /usr/mqm/samp/amqsdsc0.c -I/usr/include/dce
```

```
ld -e MQStart -bnoquiet -o amqsdsc0 amqsdsc0.o \  
-L/usr/lib/dce -T512 -H512 -ldce -bE:amqsdsc0.exp \  
-lpthreads -lc_r -liconv -ls
```

## Using DCE channel exits with the `runmqslr` listener program

On MQSeries for Windows NT, the exit dll name must be `amqrdsc0.dll` or `amqsdsc0.dll`.

---

## Chapter 37. Channel-exit calls and data structures

This chapter provides reference information about the special MQSeries calls and data structures used when writing channel exit programs. This is product-sensitive programming interface information. You can write MQSeries user exits in the following programming languages:

Platform	Programming languages
MQSeries for OS/390 without CICS	Assembler and C (which must conform to the C system programming environment for system exits, described in the <i>OS/390 C/C++ Programming Guide</i> .)
MQSeries for OS/390 using CICS	Assembler, C, COBOL, and PL/I
MQSeries for AS/400	C, COBOL, and RPG II
All other MQSeries platforms	C

You cannot write MQSeries user exits in TAL.

In a number of cases, parameters are arrays or character strings whose size is not fixed. For these, a lowercase “n” is used to represent a numeric constant. When the declaration for that parameter is coded, the “n” must be replaced by the numeric value required. For further information about the conventions used in these descriptions, see the *MQSeries Application Programming Reference* book.

The calls are:

- “MQ\_CHANNEL\_EXIT - Channel exit” on page 546
- “MQ\_CHANNEL\_AUTO\_DEF\_EXIT - Channel auto-definition exit” on page 551
- “MQXWAIT - Wait” on page 553
- “MQ\_TRANSPORT\_EXIT - Transport retry exit” on page 555

The data structures are:

- “MQCD - Channel data structure” on page 556
- “MQCXP - Channel exit parameter structure” on page 591
- “MQTXP - Transport-exit data structure” on page 605
- “MQXWD - Exit wait descriptor structure” on page 609

**Note:** Channel exit programs are not supported on DOS or VSE/ESA.

### Data definition files

The data definition files supplied with the products for each programming language are:

#### Main API definition

C	CMQC
COBOL	CMQV
PL/I	CMQP
RPG	CMQR
ASM370	CMQA

#### System extensions (MQX)

C	CMQXC
COBOL	CMQXV
PL/I	CMQXP
RPG	CMQXR
ASM370	CMQXA

#### Channel data (MQCD)

COBOL	CMQCDL, CMQCDV
RPG	CMQCDR
ASM370	CMQCDA

#### Channel exit (MQCXP)

COBOL	CMQCXPL, CMQCXPV
RPG	CMQCXPR
ASM370	CMQCXPA

#### Dead-letter header (MQDLH)

COBOL	CMQDLHL, CMQDLHV
RPG	CMQDLHR
ASM370	CMQDLHA

#### Exit parameter (MQXP)

COBOL	CMQXPL, CMQXPV
RPG	CMQXPR
ASM370	CMQXPA

#### Transmission header (MQXQH)

COBOL	CMQXQHL, CMQXQHV
RPG	CMQXQHR
ASM370	CMQXQHA

Where the file for the C or PL/I language is not included in the above, it has been included in separate common files containing all C or PL/I data. For message queuing applications the file names for C and PL/I are:

C	CMQC
PL/I	CMQP

For systems programs the file names for C and PL/I are:

C	CMQXC
PL/I	CMQXP

For a list of the complete set of header files for the product, see the *MQSeries Application Programming Guide*, or, for MQSeries for Windows, see the *MQSeries for Windows User's Guide*.

### MQ\_CHANNEL\_EXIT - Channel exit

This call definition is provided solely to describe the parameters that are passed to each of the channel exits called by the Message Channel Agent. No entry point called MQ\_CHANNEL\_EXIT is actually provided by the queue manager; the name MQ\_CHANNEL\_EXIT is of no special significance since the names of the channel exits are provided in the channel definition MQCD.

This definition is part of the MQSeries Security Enabling Interface (SEI), which is one of the MQSeries framework interfaces.

There are five types of channel exit:

- Channel security exit
- Channel message exit
- Channel send exit
- Channel receive exit
- Channel message-retry exit

The parameters are similar for each type of exit, and the description given here applies to all of them, except where specifically noted.

### Syntax

MQ\_CHANNEL\_EXIT (*ChannelExitParms*, *ChannelDefinition*, *DataLength*,  
*AgentBufferLength*, *AgentBuffer*, *ExitBufferLength*, *ExitBufferAddr*)

### Parameters

*ChannelExitParms* (MQCXP) – input/output  
Channel exit parameter block.

This structure contains additional information relating to the invocation of the exit. The exit sets information in this structure to indicate how the MCA should proceed.

*ChannelDefinition* (MQCD) – input/output  
Channel definition.

This structure contains parameters set by the administrator to control the behavior of the channel.

*DataLength* (MQLONG) – input/output  
Length of data.

When the exit is invoked, this contains the length of data in the *AgentBuffer* parameter. The exit must set this to the length of the data in either the *AgentBuffer* or the *ExitBufferAddr* (as determined by the *ExitResponse2* field in the *ChannelExitParms* parameter) that is to proceed.

The data depends on the type of exit:

- For a channel security exit, when the exit is invoked this contains the length of any security message in the *AgentBuffer* field, if *ExitReason* is MQXR\_SEC\_MSG. It is zero if there is no message. The exit must set this field to the length of any security message to be sent to its partner if it sets *ExitResponse* to MQXCC\_SEND\_SEC\_MSG or MQXCC\_SEND\_AND\_REQUEST\_SEC\_MSG. The message data is in either *AgentBuffer* or *ExitBufferAddr*.



## MQ\_CHANNEL\_EXIT - Channel exit

The content of security messages is the sole responsibility of the security exits.

- For a channel message exit, when the exit is invoked this contains the length of the message (including the transmission queue header). The exit must set this field to the length of the message in either *AgentBuffer* or *ExitBufferAddr* that is to proceed.
- For a channel send or channel receive exit, when the exit is invoked this contains the length of the transmission. The exit must set this field to the length of the transmission in either *AgentBuffer* or *ExitBufferAddr* that is to proceed.

If a security exit sends a message, and there is no security exit at the other end of the channel, or the other end sets an *ExitResponse* of MQXCC\_OK, the initiating exit is re-invoked with MQXR\_SEC\_MSG and a null response (*DataLength*=0).

*AgentBufferLength* (MQLONG) – input  
Length of agent buffer.

This can be greater than *DataLength* on invocation.

For channel message, send, and receive exits, any unused space on invocation can be used by the exit to expand the data in place. If this is done, the *DataLength* parameter must be set appropriately by the exit.

In the C programming language, this parameter is passed by address.

*AgentBuffer* (MQBYTE×*AgentBufferLength*) – input/output  
Agent buffer.

The contents of this depend upon the exit type:

- For a channel security exit, on invocation of the exit it contains a security message if *ExitReason* is MQXR\_SEC\_MSG. If the exit wishes to send a security message back, it can either use this buffer or its own buffer (*ExitBufferAddr*).
- For a channel message exit, on invocation of the exit this contains:
  - The transmission queue header (MQXQH), which includes the message descriptor (which itself contains the context information for the message), immediately followed by
  - The message data

If the message is to proceed, the exit can do one of the following:

- Leave the contents of the buffer untouched
- Modify the contents in place (returning the new length of the data in *DataLength*; this must not be greater than *AgentBufferLength*)
- Copy the contents to the *ExitBufferAddr*, making any required changes

Any changes that the exit makes to the transmission queue header are not checked; however, erroneous modifications may mean that the message cannot be put at the destination.

- For a channel send or receive exit, on invocation of the exit this contains the transmission data. The exit can do one of the following:
  - Leave the contents of the buffer untouched
  - Modify the contents in place (returning the new length of the data in *DataLength*; this must not be greater than *AgentBufferLength*)
  - Copy the contents to the *ExitBufferAddr*, making any required changes

## MQ\_CHANNEL\_EXIT - Channel exit

Note that the first 8 bytes of the data must not be changed by the exit.

*ExitBufferLength* (MQLONG) – input/output  
Length of exit buffer.

On the first invocation of the exit, this is set to zero. Thereafter whatever value is passed back by the exit, on each invocation, is presented to the exit next time it is invoked. The value is not used by the MCA (except in MQSeries for OS/390 using CICS for distributed queue management, where a check is made that *DataLength* does not exceed *ExitBufferLength*, if the exit is returning data in *ExitBufferAddr*).

**Note:** This parameter should not be used by exits written in programming languages which do not support the pointer data type.

*ExitBufferAddr* (MQPTR) – input/output  
Address of exit buffer.

This is a pointer to the address of a buffer of storage managed by the exit, where it can choose to return message or transmission data (depending upon the type of exit) to the agent if the agent's buffer is or may not be large enough, or if it is more convenient for the exit to do so.

On the first invocation of the exit, the address passed to the exit is null. Thereafter whatever address is passed back by the exit, on each invocation, is presented to the exit the next time it is invoked.

**Note:** This parameter should not be used by exits written in programming languages that do not support the pointer data type.

## Usage notes

1. The function performed by the channel exit is defined by the provider of the exit. The exit, however, must conform to the rules defined here and in the associated control block, the MQCXP.
2. The *ChannelDefinition* parameter passed to the channel exit may be one of several versions. See the *Version* field in the MQCD structure for more information.
3. If the channel exit receives an MQCD structure with the *Version* field set to a value greater than MQCD\_VERSION\_1, the exit should use the *ConnectionName* field in MQCD, in preference to the *ShortConnectionName* field.
4. In general, channel exits are allowed to change the length of message data. This may arise as a result of the exit adding data to the message, or removing data from the message, or compressing or encrypting the message. However, special restrictions apply if the message is a segment that contains only part of a logical message. In particular, there must be no net change in the length of the message as a result of the actions of complementary sending and receiving exits.

For example, it is permissible for a sending exit to shorten the message by compressing it, but the complementary receiving exit must restore the original length of the message by decompressing it, so that there is no net change in the length of the message.

This restriction arises because changing the length of a segment would cause the offsets of later segments in the message to be incorrect, and this would inhibit the queue manager's ability to recognize that the segments formed a complete logical message.

## C invocation

```
exitname (&ChannelExitParms, &ChannelDefinition,
         &DataLength, &AgentBufferLength, AgentBuffer,
         &ExitBufferLength, &ExitBufferAddr);
```

Declare the parameters as follows:

```
MQCXP ChannelExitParms; /* Channel exit parameter block */
MQCD ChannelDefinition; /* Channel definition */
MQLONG DataLength; /* Length of data */
MQLONG AgentBufferLength; /* Length of agent buffer */
MQBYTE AgentBuffer[n]; /* Agent buffer */
MQLONG ExitBufferLength; /* Length of exit buffer */
MQPTR ExitBufferAddr; /* Address of exit buffer */
```

## COBOL invocation

```
CALL 'exitname' USING CHANNELEXITPARMS, CHANNELDEFINITION,
                     DATALENGTH, AGENTBUFFERLENGTH, AGENTBUFFER,
                     EXITBUFFERLENGTH, EXITBUFFERADDR.
```

Declare the parameters as follows:

```
** Channel exit parameter block
01 CHANNELEXITPARMS.
   COPY CMQCXPV.
** Channel definition
01 CHANNELDEFINITION.
   COPY CMQCDV.
** Length of data
01 DATALENGTH          PIC S9(9) BINARY.
** Length of agent buffer
01 AGENTBUFFERLENGTH    PIC S9(9) BINARY.
** Agent buffer
01 AGENTBUFFER          PIC X(n).
** Length of exit buffer
01 EXITBUFFERLENGTH     PIC S9(9) BINARY.
** Address of exit buffer
01 EXITBUFFERADDR       POINTER.
```

## PL/I invocation

```
call exitname (ChannelExitParms, ChannelDefinition, DataLength,
              AgentBufferLength, AgentBuffer, ExitBufferLength,
              ExitBufferAddr);
```

Declare the parameters as follows:

```
dc1 ChannelExitParms like MQCXP; /* Channel exit parameter
                                block */
dc1 ChannelDefinition like MQCD; /* Channel definition */
dc1 DataLength fixed bin(31); /* Length of data */
dc1 AgentBufferLength fixed bin(31); /* Length of agent buffer */
dc1 AgentBuffer char(n); /* Agent buffer */
dc1 ExitBufferLength fixed bin(31); /* Length of exit buffer */
dc1 ExitBufferAddr pointer; /* Address of exit buffer */
```

## RPG invocation (ILE)

```
C*..1.....2.....3.....4.....5.....6.....7..
C          CALLP      exitname(MQCXP : MQCD : DATLEN :
C                               ABUFL : ABUF : EBUFL :
C                               EBUF)
```

The prototype definition for the call is:

## MQ\_CHANNEL\_EXIT - Channel exit

```

D*..1.....2.....3.....4.....5.....6.....7..
Dexitname          PR          EXTPROC('exitname')
D* Channel exit parameter block
D MQCXP            156A
D* Channel definition
D MQCD            1216A
D* Length of data
D DATLEN          10I 0
D* Length of agent buffer
D ABUFL          10I 0
D* Agent buffer
D ABUF            *   VALUE
D* Length of exit buffer
D EBUFL          10I 0
D* Address of exit buffer
D EBUF            *

```

## RPG invocation (OPM)

```

C*..1.....2.....3.....4.....5.....6.....7..
C          CALL 'exitname'
C* Channel exit parameter block
C          PARM          MQCXP
C* Channel definition
C          PARM          MQCD
C* Length of data
C          PARM          DATLEN  90
C* Length of agent buffer
C          PARM          ABUFL   90
C* Agent buffer
C          PARM          ABUF    n
C* Length of exit buffer
C          PARM          EBUFL   90
C* Address of exit buffer
C          PARM          EBUF    16

```

Declare the structure parameters as follows:

```

I*..1.....2.....3.....4.....5.....6.....7..
I* Channel exit parameter block
IMQCXP          DS
I/COPY CMQCXPR
I* Channel definition
IMQCD           DS
I/COPY CMQCDR

```

## System/390<sup>®</sup> assembler invocation

```

CALL EXITNAME, (CHANNELEXITPARMS, CHANNELDEFINITION, DATALENGTH,
AGENTBUFFERLENGTH, AGENTBUFFER, EXITBUFFERLENGTH,
EXITBUFFERADDR)
X
X

```

Declare the parameters as follows:

CHANNELEXITPARMS	CMQCXPA		Channel exit parameter block
CHANNELDEFINITION	CMQCDA		Channel definition
DATALENGTH	DS	F	Length of data
AGENTBUFFERLENGTH	DS	F	Length of agent buffer
AGENTBUFFER	DS	CL(n)	Agent buffer
EXITBUFFERLENGTH	DS	F	Length of exit buffer
EXITBUFFERADDR	DS	F	Address of exit buffer

---

## MQ\_CHANNEL\_AUTO\_DEF\_EXIT - Channel auto-definition exit

This call definition is provided solely to describe the parameters that are passed to the channel auto-definition exit called by the Message Channel Agent. No entry point called MQ\_CHANNEL\_AUTO\_DEF\_EXIT is actually provided by the queue manager; the name MQ\_CHANNEL\_AUTO\_DEF\_EXIT is of no special significance because the names of the auto-definition exits are provided in the queue manager.

The MQ\_CHANNEL\_AUTO\_DEF\_EXIT call definition is part of the MQSeries Security Enabling Interface (SEI), which is one of the MQSeries framework interfaces.

This exit is supported in the following environments: AIX, HP-UX, OS/390, OS/2, OS/400, Sun Solaris, Windows NT.

### Syntax

MQ\_CHANNEL\_AUTO\_DEF\_EXIT (*ChannelExitParms*, *ChannelDefinition*)

### Parameters

*ChannelExitParms* (MQCXP) – input/output  
Channel exit parameter block.

This structure contains additional information relating to the invocation of the exit. The exit sets information in this structure to indicate how the MCA should proceed.

*ChannelDefinition* (MQCD) – input/output  
Channel definition.

This structure contains parameters set by the administrator to control the behavior of channels which are created automatically. The exit sets information in this structure to modify the default behavior set by the administrator.

The MQCD fields listed below must not be altered by the exit:

*ChannelName*  
*ChannelType*  
*StrucLength*  
*Version*

If other fields are changed, the value set by the exit must be valid. If the value is not valid, an error message is written to the error log file or displayed on the console (as appropriate to the environment).

### Usage notes

1. The function performed by the channel exit is defined by the provider of the exit. The exit, however, must conform to the rules defined here and in the associated control block, the MQCXP.
2. The *ChannelExitParms* parameter passed to the channel auto-definition exit is an MQCXP structure. The version of MQCXP passed depends on the environment in which the exit is running; see the description of the *Version* field in “MQCXP - Channel exit parameter structure” on page 591 for details.
3. The *ChannelDefinition* parameter passed to the channel auto-definition exit is an MQCD structure. The version of MQCD passed depends on the

## MQ\_CHANNEL\_AUTO\_DEF\_EXIT - Channel auto-definition exit

environment in which the exit is running; see the description of the *Version* field in “MQCD - Channel data structure” on page 556 for details.

### C invocation

```
exitname (&ChannelExitParms, &ChannelDefinition);
```

Declare the parameters as follows:

```
MQCXP ChannelExitParms; /* Channel exit parameter block */
MQCD ChannelDefinition; /* Channel definition */
```

### COBOL invocation

```
CALL 'exitname' USING CHANNELEXITPARMS, CHANNELDEFINITION.
```

Declare the parameters as follows:

```
** Channel exit parameter block
01 CHANNELEXITPARMS.
   COPY CMQCXPV.
** Channel definition
01 CHANNELDEFINITION.
   COPY CMQCDV.
```

### RPG invocation (ILE)

```
C*.1.....2.....3.....4.....5.....6.....7..
C          CALLP      exitname(MQCXP : MQCD)
```

The prototype definition for the call is:

```
D*.1.....2.....3.....4.....5.....6.....7..
Dexitname PR          EXTPROC('exitname')
D* Channel exit parameter block
D MQCXP          156A
D* Channel definition
D MQCD          1216A
```

### RPG invocation (OPM)

```
C*.1.....2.....3.....4.....5.....6.....7..
C          CALL 'exitname'
C* Channel exit parameter block
C          PARM          MQCXP
C* Channel definition
C          PARM          MQCD
```

Declare the structure parameters as follows:

```
I*.1.....2.....3.....4.....5.....6.....7..
I* Channel exit parameter block
IMQCXP DS
I/COPY CMQCXPR
I* Channel definition
IMQCD DS
I/COPY CMQCDR
```

### System/390 assembler invocation

```
CALL EXITNAME, (CHANNELEXITPARMS, CHANNELDEFINITION)
```

Declare the parameters as follows:

```
CHANNELEXITPARMS CMQCXPA          Channel exit parameter block
CHANNELDEFINITION CMQCDA          Channel definition
```

## MQXWAIT - Wait

The MQXWAIT call waits for an event to occur. It can be used only from a channel exit on OS/390 when not using CICS.

### Syntax

MQXWAIT (*Hconn*, *WaitDesc*, *CompCode*, *Reason*)

### Parameters

*Hconn* (MQHCONN) – input  
Connection handle.

This handle represents the connection to the queue manager. The value of *Hconn* was returned by a previous MQCONN call issued in the same or earlier invocation of the exit.

*WaitDesc* (MQXWD) – input/output  
Wait descriptor.

This describes the event to wait for. See “MQXWD - Exit wait descriptor structure” on page 609 for details of the fields in this structure.

*CompCode* (MQLONG) – output  
Completion code.

It is one of the following:

**MQCC\_OK**  
Successful completion.  
**MQCC\_FAILED**  
Call failed.

*Reason* (MQLONG) – output  
Reason code qualifying *CompCode*.

If *CompCode* is MQCC\_OK:  
**MQRC\_NONE**  
(0, X'000') No reason to report.

If *CompCode* is MQCC\_FAILED:  
**MQRC\_ADAPTER\_NOT\_AVAILABLE**  
(2204, X'89C') Adapter not available.  
**MQRC\_OPTIONS\_ERROR**  
(2046, X'7FE') Options not valid or not consistent.

**MQRC\_XWAIT\_CANCELED**  
(2107, X'83B') MQXWAIT call canceled.

**MQRC\_XWAIT\_ERROR**  
(2108, X'83C') Invocation of MQXWAIT call not valid.

For more information on these reason codes, see the *Application Programming Reference Manual* for your platform.

## MQXWAIT - Wait

### C invocation

```
MQXWAIT (Hconn, &WaitDesc, &CompCode, &Reason);
```

Declare the parameters as follows:

```
MQHCONN Hconn; /* Connection handle */  
MQXWD WaitDesc; /* Wait descriptor */  
MQLONG CompCode; /* Completion code */  
MQLONG Reason; /* Reason code qualifying CompCode */
```

### System/390 assembler invocation

```
CALL MQXWAIT,(HCONN,WAITDESC,COMP CODE,REASON)
```

Declare the parameters as follows:

HCONN	DS	F	Connection handle
WAITDESC	CMQXWDA		Wait descriptor
COMP CODE	DS	F	Completion code
REASON	DS	F	Reason code qualifying CompCode



## MQ\_TRANSPORT\_EXIT - Transport retry exit

This call definition is provided solely to describe the parameters that are passed to the transport retry exit called by the message channel agent (MCA). No entry point called MQ\_TRANSPORT\_EXIT is actually provided by the MCA; the name MQ\_TRANSPORT\_EXIT is of no special significance because the name of the transport retry exit is provided by the queue-manager's configuration file.

This exit is supported in the following environments: AIX and 16-bit Windows.

### Syntax

MQ\_TRANSPORT\_EXIT (*ExitParms*, *DestAddressLength*, *DestAddress*)

### Parameters

*ExitParms* (MQTXP) – input/output  
Exit parameter block.

This structure contains information relating to the invocation of the exit. The exit sets information in this structure to indicate how processing should continue.

*DestAddressLength* (MQLONG) – input  
Length in bytes of destination IP address.

This is the length of the destination IP address *DestAddress*. The value is always greater than zero.

*DestAddress* (MQCHAR×*DestAddressLength*) – input  
Destination IP address.

This is the IP address of the destination. Its length is given by the *DestAddressLength* parameter.

### Usage notes

1. The function performed by the exit is defined by the provider of the exit. The exit, however, must conform to the rules defined in the associated control block MQTXP.
2. The transport retry exit allows a channel to be paused based on criteria that are external to MQSeries.

If configured, the exit is called before each attempt to resend a failing data packet. When called, the exit can wait based on some external criterion, and not return control to the MCA until the exit decides that the resend of the data packet is likely to succeed. If the exit decides that transmission should be discontinued, the exit can instruct the MCA to close the channel.

### C invocation

```
exitname (&ExitParms, DestAddressLength, DestAddress);
```

Declare the parameters as follows:

```
MQTXP   ExitParms;           /* Exit parameter block */
MQLONG  DestAddressLength;   /* Length in bytes of destination IP
                             address */
MQCHAR  DestAddress[n];     /* Destination IP address */
```

## MQCD - Channel data structure

The following table summarizes the fields in the structure.

Table 48. Fields in MQCD

Field	Description	Page
<i>ChannelName</i>	Channel definition name	558
<i>Version</i>	Structure version number	558
<i>ChannelType</i>	Channel type	559
<i>TransportType</i>	Transport type	560
<i>Desc</i>	Channel description	560
<i>QMgrName</i>	Queue manager name	561
<i>XmitQName</i>	Transmission queue name	561
<i>ShortConnectionName</i>	First 20 bytes of connection name	561
<i>MCAName</i>	Reserved	561
<i>ModeName</i>	LU 6.2 mode name	561
<i>TpName</i>	LU 6.2 transaction program name	562
<i>BatchSize</i>	Batch size	562
<i>DiscInterval</i>	Disconnect interval	562
<i>ShortRetryCount</i>	Short retry count	562
<i>ShortRetryInterval</i>	Short retry wait interval	562
<i>LongRetryCount</i>	Long retry count	563
<i>LongRetryInterval</i>	Long retry wait interval	563
<i>SecurityExit</i>	Channel security exit name	563
<i>MsgExit</i>	Channel message exit name	563
<i>SendExit</i>	Channel send exit name	564
<i>ReceiveExit</i>	Channel receive exit name	564
<i>SeqNumberWrap</i>	Highest allowable message sequence number	564
<i>MaxMsgLength</i>	Maximum message length	565
<i>PutAuthority</i>	Put authority	565
<i>DataConversion</i>	Data conversion	565
<i>SecurityUserData</i>	Channel security exit user data	565
<i>MsgUserData</i>	Channel message exit user data	566
<i>SendUserData</i>	Channel send exit user data	566
<i>ReceiveUserData</i>	Channel receive exit user data	566
<i>UserIdentifier</i>	User identifier	566
<i>Password</i>	Password	567
<i>MCAUserIdentifier</i>	First 12 bytes of MCA user identifier	567
<i>MCAType</i>	Message channel agent type	568
<i>ConnectionName</i>	Connection name	568
<i>RemoteUserIdentifier</i>	First 12 bytes of user identifier from partner	569
<i>RemotePassword</i>	Password from partner	569
<i>MsgRetryExit</i>	Channel message retry exit name	570

Table 48. Fields in MQCD (continued)

Field	Description	Page
<i>MsgRetryUserData</i>	Channel message retry exit user data	570
<i>MsgRetryCount</i>	Number of times MCA will try to put the message after the first attempt has failed	571
<i>MsgRetryInterval</i>	Minimum interval in milliseconds after which the open or put operation will be retried	571
<i>HeartbeatInterval</i>	Time in seconds between heartbeat flows	572
<i>BatchInterval</i>	Batch duration	573
<i>NonPersistentMsgSpeed</i>	Speed at which nonpersistent messages are sent	573
<i>StrucLength</i>	Length of MQCD structure	574
<i>ExitNameLength</i>	Length of exit name	574
<i>ExitDataLength</i>	Length of exit user data	574
<i>MsgExitsDefined</i>	Number of message exits defined	574
<i>SendExitsDefined</i>	Number of send exits defined	574
<i>ReceiveExitsDefined</i>	Number of receive exits defined	575
<i>MsgExitPtr</i>	Address of first <i>MsgExit</i> field	575
<i>MsgUserDataPtr</i>	Address of first <i>MsgUserData</i> field	575
<i>SendExitPtr</i>	Address of first <i>SendExit</i> field	576
<i>SendUserDataPtr</i>	Address of first <i>SendUserData</i> field	576
<i>ReceiveExitPtr</i>	Address of first <i>ReceiveExit</i> field	576
<i>ReceiveUserDataPtr</i>	Address of first <i>ReceiveUserData</i> field	577
<i>ClusterPtr</i>	Address of first cluster record	577
<i>ClustersDefined</i>	Number of cluster records	578
<i>NetworkPriority</i>	Network priority	578
<i>LongMCAUserIdLength</i>	Length of long MCA user identifier	578
<i>LongRemoteUserIdLength</i>	Length of long remote user identifier	578
<i>LongMCAUserIdPtr</i>	Address of long MCA user identifier	578
<i>LongRemoteUserIdPtr</i>	Address of long remote user identifier	579
<i>MCASecurityId</i>	MCA security identifier	579
<i>RemoteSecurityId</i>	Remote security identifier	579

The MQCD structure contains the parameters which control execution of a channel. It is passed to each channel exit that is called from a Message Channel Agent (MCA). See MQ\_CHANNEL\_EXIT.

The meaning of the name in the *SecurityExit*, *MsgExit*, *SendExit*, *ReceiveExit*, and *MsgRetryExit* fields depends on the environment in which the MCA is running. Except where noted below, the name is left-justified within the field, with no embedded blanks; the name is padded with blanks to the length of the field. In the descriptions that follow, square brackets ( [ ] ) denote optional information:

#### Environment

##### Format of exit name

#### UNIX systems

The name of a dynamically-loadable module or library, suffixed with the

## MQCD

name of a function residing in that library. The function name must be enclosed in parentheses. The library name can optionally be prefixed with a directory path:

*[path]library(function)*

The name is limited to a maximum of 128 characters.

### **OS/390 not using CICS for distributed queuing**

The name of a load module that is valid for specification on the EP parameter of the LINK or LOAD macro. The name is limited to a maximum of 8 characters.

### **OS/390 using CICS for distributed queuing**

A 4-character transaction identifier.

### **OS/2, Windows 3.1, Windows NT, and DOS, and MQSeries for Windows**

The name of a dynamic-link library, suffixed with the name of a function residing in that library. The function name must be enclosed in parentheses. The library name can optionally be prefixed with a directory path and drive:

*[d:][path]library(function)*

The name is limited to a maximum of 128 characters.

### **OS/400**

A 10-byte program name followed by a 10-byte library name. If the names are less than 10 bytes long, each name is padded with blanks to make it 10 bytes. The library name can be \*LIBL except when calling a channel auto-definition exit, in which case a fully qualified name is required.

## Fields

*ChannelName* (MQCHAR20)

Channel definition name.

There must be a channel definition of the same name at the remote machine to be able to communicate.

The name must use only the characters:

- Uppercase A–Z
- Lowercase a–z
- Numerics 0–9
- Period (.)
- Forward slash (/)
- Underscore ( \_ )
- Percent sign (%)

and be padded to the right with blanks. Leading or embedded blanks are not allowed.

The length of this field is given by MQ\_CHANNEL\_NAME\_LENGTH.

*Version* (MQLONG)

Structure version number.

The value depends on the environment:

**MQCD\_VERSION\_1**

Version-1 channel definition structure.

The field has this value on OS/390 using CICS for distributed queuing. Note, however, that the MQCD passed to the exit is in fact a version-2 structure.

**MQCD\_VERSION\_2**

Version-2 channel definition structure.

This value is not used by any current MQSeries product.

**MQCD\_VERSION\_3**

Version-3 channel definition structure.

The field has this value in the following environments: Compaq (DIGITAL) OpenVMS, Tandem NonStop Kernel, UNIX systems not listed elsewhere, 16-bit Windows, 32-bit Windows.

**MQCD\_VERSION\_4**

Version-4 channel definition structure.

This value is not used by any current MQSeries product.

**MQCD\_VERSION\_5**

Version-5 channel definition structure.

The field has this value on OS/390 not using CICS for distributed queuing.

**MQCD\_VERSION\_6**

Version-6 channel definition structure.

The field has this value in the following environments: AIX, DOS client, HP-UX, OS/2, OS/400, Sun Solaris, Windows client, Windows NT.

Fields that exist only in the earlier versions of the structure are identified as such in the field descriptions that follow. The following constant specifies the version number of the current version:

**MQCD\_CURRENT\_VERSION**

Current version of channel definition structure.

The value of this constant depends on the environment (see above).

**Note:** When a new version of the MQCD structure is introduced, the layout of the existing part is not changed. The exit should therefore check that the version number is equal to or greater than the lowest version which contains the fields that the exit needs to use.

*ChannelType* (MQLONG)

Channel type.

It is one of the following:

**MQCHT\_SENDER**

Sender.

**MQCHT\_SERVER**

Server.

**MQCHT\_RECEIVER**

Receiver.

**MQCHT\_REQUESTER**

Requester.

**MQCHT\_CLNTCONN**

Client connection.

## MQCD

### **MQCHT\_SVRCONN**

Server-connection (for use by clients).

### **MQCHT\_CLUSSDR**

Cluster sender.

### **MQCHT\_CLUSRCVR**

Cluster receiver.

*TransportType* (MQLONG)

Transport type.

Transmission protocol to be used.

Note that the value will not have been checked if the channel was initiated from the other end.

The value is one of the following:

### **MQXPT\_LU62**

LU 6.2 transport protocol.

This value is not supported on 32-bit Windows.

### **MQXPT\_TCP**

TCP/IP transport protocol.

This is the *only* value supported on 32-bit Windows.

### **MQXPT\_NETBIOS**

NetBIOS transport protocol.

This value is supported in the following environments: OS/2, 32-bit Windows, Windows NT.

### **MQXPT\_SPX**

SPX transport protocol.

This value is supported in the following environments: OS/2, Windows NT, Windows client, DOS client.

### **MQXPT\_DECNET**

DECnet transport protocol.

This value is supported in the following environment: Compaq (DIGITAL) OpenVMS.

### **MQXPT\_UDP**

UDP transport protocol.

This value is supported in the following environments: AIX and 16-bit Windows.

*Desc* (MQCHAR64)

Channel description.

This is a field that may be used for descriptive commentary. The content of the field is of no significance to Message Channel Agents. However, it should contain only characters that can be displayed. It cannot contain any null characters; if necessary, it is padded to the right with blanks. In a DBCS installation, the field can contain DBCS characters (subject to a maximum field length of 64 bytes).

**Note:** If this field contains characters that are not in the queue manager's character set (as defined by the *CodedCharSetId* queue manager attribute), those characters may be translated incorrectly if this field is sent to another queue manager.

The length of this field is given by MQ\_CHANNEL\_DESC\_LENGTH.

*QMgrName* (MQCHAR48)

Queue-manager name.

For channels with a *ChannelType* other than MQCHT\_CLNTCONN, this is the name of the queue manager that an exit can connect to, which on OS/2, UNIX systems, and Windows NT, is always nonblank.

The length of this field is given by MQ\_Q\_MGR\_NAME\_LENGTH.

*XmitQName* (MQCHAR48)

Transmission queue name.

The name of the transmission queue from which messages are retrieved.

This field is relevant only for channels with a *ChannelType* of MQCHT\_SENDER or MQCHT\_SERVER.

The length of this field is given by MQ\_Q\_NAME\_LENGTH.

*ShortConnectionName* (MQCHAR20)

First 20 bytes of connection name.

If the *Version* field is MQCD\_VERSION\_1, *ShortConnectionName* contains the full connection name.

If the *Version* field is MQCD\_VERSION\_2 or greater, *ShortConnectionName* contains the first 20 characters of the connection name. The full connection name is given by the *ConnectionName* field; *ShortConnectionName* and the first 20 characters of *ConnectionName* are identical.

See *ConnectionName* for details of the contents of this field.

**Note:** The name of this field was changed for MQCD\_VERSION\_2 and subsequent versions of MQCD; the field was previously called *ConnectionName*.

The length of this field is given by MQ\_SHORT\_CONN\_NAME\_LENGTH.

*MCAName* (MQCHAR20)

Reserved.

This is a reserved field; its value is blank.

The length of this field is given by MQ\_MCA\_NAME\_LENGTH.

*ModeName* (MQCHAR8)

LU 6.2 Mode name.

This field is relevant only if the transmission protocol (*TransportType*) is MQXPT\_LU62, and the *ChannelType* is not MQCHT\_SVRCONN or MQCHT\_RECEIVER.

## MQCD

On OS/400, OS/390 without CICS, UNIX systems, and MQSeries for Windows, this field is always blank. The information is contained in the communications Side Object instead.

The length of this field is given by `MQ_MODE_NAME_LENGTH`.

*TpName* (MQCHAR64)

LU 6.2 transaction program name.

This field is relevant only if the transmission protocol (*TransportType*) is `MQXPT_LU62`, and the *ChannelType* is not `MQCHT_SVRCONN` or `MQCHT_RECEIVER`.

On OS/400, OS/390 without CICS, UNIX systems, and MQSeries for Windows, this field is always blank. The information is contained in the communications Side Object instead.

The length of this field is given by `MQ_TP_NAME_LENGTH`.

*BatchSize* (MQLONG)

Batch size.

The maximum number of messages that can be sent through a channel before synchronizing the channel.

This field is not relevant for channels with a *ChannelType* of `MQCHT_SVRCONN` or `MQCHT_CLNTCONN`.

*DiscInterval* (MQLONG)

Disconnect interval.

The maximum time in seconds for which the channel waits for a message to arrive on the transmission queue, before terminating the channel. A value of zero causes the MCA to wait indefinitely.

This field is relevant only for channels with a *ChannelType* of `MQCHT_SENDER`, `MQCHT_SERVER`, `MQCHT_CLUSSDR`, or `MQCHT_CLUSRCVR`.

*ShortRetryCount* (MQLONG)

Short retry count.

This is the maximum number of attempts that are made to connect to the remote machine, at intervals specified by *ShortRetryInterval*, before the (normally longer) *LongRetryCount* and *LongRetryInterval* are used.

This field is relevant only for channels with a *ChannelType* of `MQCHT_REQUESTER` (only for MQSeries for OS/390 using CICS distributed queuing), `MQCHT_SENDER`, `MQCHT_SERVER`, `MQCHT_CLUSSDR`, or `MQCHT_CLUSRCVR`.

*ShortRetryInterval* (MQLONG)

Short retry wait interval.

This is the maximum number of seconds to wait before reattempting connection to the remote machine. Note that the interval between retries may be extended if the channel has to wait to become active.



This field is relevant only for channels with a *ChannelType* of MQCHT\_REQUESTER (only for MQSeries for OS/390 using CICS distributed queuing), MQCHT\_SENDER, MQCHT\_SERVER, MQCHT\_CLUSSDR, or MQCHT\_CLUSRCVR.

*LongRetryCount* (MQLONG)

Long retry count.

This count is used after the count specified by *ShortRetryCount* has been exhausted. It specifies the maximum number of further attempts that are made to connect to the remote machine, at intervals specified by *LongRetryInterval*, before logging an error to the operator.

This field is relevant only for channels with a *ChannelType* of MQCHT\_REQUESTER (only for MQSeries for OS/390 using CICS distributed queuing), MQCHT\_SENDER, MQCHT\_SERVER, MQCHT\_CLUSSDR, or MQCHT\_CLUSRCVR.

*LongRetryInterval* (MQLONG)

Long retry wait interval.

This is the maximum number of seconds to wait before reattempting connection to the remote machine. Note that the interval between retries may be extended if the channel has to wait to become active.

This field is relevant only for channels with a *ChannelType* of MQCHT\_REQUESTER (only for MQSeries for OS/390 using CICS distributed queuing), MQCHT\_SENDER, MQCHT\_SERVER, MQCHT\_CLUSSDR, or MQCHT\_CLUSRCVR.

*SecurityExit* (MQCHARn)

Channel security exit name.

If this name is nonblank, the exit is called at the following times:

- Immediately after establishing a channel.  
Before any messages are transferred, the exit is given the opportunity to instigate security flows to validate connection authorization.
- Upon receipt of a response to a security message flow.  
Any security message flows received from the remote processor on the remote machine are given to the exit.
- At initialization and termination of the channel.

See above in the introduction to MQCD for a description of the content of this field in various environments.

The length of this field is given by MQ\_EXIT\_NAME\_LENGTH.

**Note:** The value of this constant is environment specific.

*MsgExit* (MQCHARn)

Channel message exit name.

If this name is nonblank, the exit is called at the following times:

- Immediately after a message has been retrieved from the transmission queue (sender or server), or immediately before a message is put to a destination queue (receiver or requester).

## MQCD

The exit is given the entire application message and transmission queue header for modification.

- At initialization and termination of the channel.

This field is not relevant for channels with a *ChannelType* of MQCHT\_SVRCONN or MQCHT\_CLNTCONN; a message exit is never invoked for such channels.

See above in the introduction to MQCD for a description of the content of this field in various environments.

The length of this field is given by MQ\_EXIT\_NAME\_LENGTH.

**Note:** The value of this constant is environment specific.

*SendExit* (MQCHARn)

Channel send exit name.

If this name is nonblank, the exit is called at the following times:

- Immediately before data is sent out on the network.  
The exit is given the complete transmission buffer before it is transmitted. The contents of the buffer can be modified as required.
- At initialization and termination of the channel.

See above in the introduction to MQCD for a description of the content of this field in various environments.

The length of this field is given by MQ\_EXIT\_NAME\_LENGTH.

**Note:** The value of this constant is environment specific.

*ReceiveExit* (MQCHARn)

Channel receive exit name.

If this name is nonblank, the exit is called at the following times:

- Immediately before the received network data is processed.  
The exit is given the complete transmission buffer as received. The contents of the buffer can be modified as required.
- At initialization and termination of the channel.

See above in the introduction to MQCD for a description of the content of this field in various environments.

The length of this field is given by MQ\_EXIT\_NAME\_LENGTH.

**Note:** The value of this constant is environment specific.

*SeqNumberWrap* (MQLONG)

Highest allowable message sequence number.

When this value is reached, sequence numbers wrap to start again at 1.

This value is non-negotiable and must match in both the local and remote channel definitions.

This field is not relevant for channels with a *ChannelType* of MQCHT\_SVRCONN or MQCHT\_CLNTCONN.

*MaxMsgLength* (MQLONG)

Maximum message length.

Specifies the maximum message length that can be transmitted on the channel. This is compared with the value for the remote channel and the actual maximum is the lower of the two values.

*PutAuthority* (MQLONG)

Put authority.

Specifies whether the user identifier in the context information associated with a message should be used to establish authority to put the message to the destination queue.

This field is relevant only for channels with a *ChannelType* of MQCHT\_REQUESTER, MQCHT\_RECEIVER, or MQCHT\_CLUSRCVR. and is not supported on MQSeries for Windows. It is one of the following:

**MQPA\_DEFAULT**

Default user identifier is used.

**MQPA\_CONTEXT**

Context user identifier is used.

*DataConversion* (MQLONG)

Data conversion.

This specifies whether the sending message channel agent should attempt conversion of the application message data if the receiving message channel agent is unable to perform this conversion. This applies only to messages that are not segments of logical messages; the MCA never attempts to convert messages which are segments.

*DataConversion* is not supported on MQSeries for Windows.

This field is relevant only for channels with a *ChannelType* of MQCHT\_SENDER, MQCHT\_SERVER, MQCHT\_CLUSSDR, or MQCHT\_CLUSRCVR. It is one of the following:

**MQCDC\_SENDER\_CONVERSION**

Conversion by sender.

This value is not supported on 32-bit Windows.

**MQCDC\_NO\_SENDER\_CONVERSION**

No conversion by sender.

*SecurityUserData* (MQCHAR32)

Channel security exit user data.

This is passed to the channel security exit in the *ExitData* field of the *ChannelExitParms* parameter (see MQ\_CHANNEL\_EXIT).

This field initially contains the data that was set in the channel definition. However, during the lifetime of this MCA instance, any changes made to the contents of this field by an exit of any type are preserved by the MCA, and made visible to subsequent invocations of exits (regardless of type) for this

## MQCD

MCA instance. Such changes have no effect on the channel definition used by other MCA instances. Any characters (including binary data) can be used.

The length of this field is given by `MQ_EXIT_DATA_LENGTH`.

### *MsgUserData* (MQCHAR32)

Channel message exit user data.

This is passed to the channel message exit in the *ExitData* field of the *ChannelExitParms* parameter (see `MQ_CHANNEL_EXIT`).

This field initially contains the data that was set in the channel definition. However, during the lifetime of this MCA instance, any changes made to the contents of this field by an exit of any type are preserved by the MCA, and made visible to subsequent invocations of exits (regardless of type) for this MCA instance. Such changes have no effect on the channel definition used by other MCA instances. Any characters (including binary data) can be used.

The length of this field is given by `MQ_EXIT_DATA_LENGTH`.

### *SendUserData* (MQCHAR32)

Channel send exit user data.

This is passed to the channel send exit in the *ExitData* field of the *ChannelExitParms* parameter (see `MQ_CHANNEL_EXIT`).

This field initially contains the data that was set in the channel definition. However, during the lifetime of this MCA instance, any changes made to the contents of this field by an exit of any type are preserved by the MCA, and made visible to subsequent invocations of exits (regardless of type) for this MCA instance. Such changes have no effect on the channel definition used by other MCA instances. Any characters (including binary data) can be used.

The length of this field is given by `MQ_EXIT_DATA_LENGTH`.

### *ReceiveUserData* (MQCHAR32)

Channel receive exit user data.

This is passed to the channel receive exit in the *ExitData* field of the *ChannelExitParms* parameter (see `MQ_CHANNEL_EXIT`).

This field initially contains the data that was set in the channel definition. However, during the lifetime of this MCA instance, any changes made to the contents of this field by an exit of any type are preserved by the MCA, and made visible to subsequent invocations of exits (regardless of type) for this MCA instance. Such changes have no effect on the channel definition used by other MCA instances. Any characters (including binary data) can be used.

The length of this field is given by `MQ_EXIT_DATA_LENGTH`.

The following fields in this structure are not present if *Version* is less than `MQCD_VERSION_2`.

### *UserIdentifier* (MQCHAR12)

User identifier.

This is used by the message channel agent when attempting to initiate a secure SNA session with a remote message channel agent.

This field can be nonblank only on OS/2, UNIX systems, and Windows NT, and is relevant only for channels with a *ChannelType* of MQCHT\_SENDER, MQCHT\_SERVER, MQCHT\_REQUESTER or MQCHT\_CLNTCONN. On OS/390 this field is not relevant.

The length of this field is given by MQ\_USER\_ID\_LENGTH, however only the first 10 characters are used.

This field is not present in MQSeries for Windows or when *Version* is less than MQCD\_VERSION\_2.

*Password* (MQCHAR12)

Password.

This is used by the message channel agent when attempting to initiate a secure SNA session with a remote message channel agent.

This field can be nonblank only on OS/2, UNIX systems, and Windows NT, and is relevant only for channels with a *ChannelType* of MQCHT\_SENDER, MQCHT\_SERVER, MQCHT\_REQUESTER or MQCHT\_CLNTCONN. On OS/390 this field is not relevant.

The length of this field is given by MQ\_PASSWORD\_LENGTH, however only the first 10 characters are used.

This field is not present if *Version* is less than MQCD\_VERSION\_2.

*MCAUserIdentifier* (MQCHAR12)

First 12 bytes of MCA user identifier.

There are two fields that contain the MCA user identifier:

- *MCAUserIdentifier* contains the first 12 bytes of the MCA user identifier, and is padded with blanks if the identifier is shorter than 12 bytes. *MCAUserIdentifier* can be completely blank.
- *LongMCAUserIdPtr* points to the full MCA user identifier, which can be longer than 12 bytes. Its length is given by *LongMCAUserIdLength*. The full identifier contains no trailing blanks, and is not null-terminated. If the identifier is completely blank, *LongMCAUserIdLength* is zero, and the value of *LongMCAUserIdPtr* is undefined.

**Note:** *LongMCAUserIdPtr* is not present if *Version* is less than MQCD\_VERSION\_6.

If the MCA user identifier is nonblank, it specifies the user identifier to be used by the message channel agent for authorization to access MQSeries resources, including (if *PutAuthority* is MQPA\_DEFAULT) authorization to put the message to the destination queue for receiver or requester channels.

If the MCA user identifier is blank, the message channel agent uses its default user identifier.

The MCA user identifier can be set by a security exit to indicate the user identifier that the message channel agent should use. The exit can change either *MCAUserIdentifier*, or the string pointed at by *LongMCAUserIdPtr*. If both are changed but differ from each other, the MCA uses *LongMCAUserIdPtr* in preference to *MCAUserIdentifier*. If the exit changes the length of the string

## MQCD

addressed by *LongMCAUserIdPtr*, *LongMCAUserIdLength* must be set correspondingly. If the exit wishes to increase the length of the identifier, the exit must allocate storage of the required length, set that storage to the required identifier, and place the address of that storage in *LongMCAUserIdPtr*. The exit is responsible for freeing that storage when the exit is later invoked with the MQXR\_TERM reason.

For channels with a *ChannelType* of MQCHT\_SVRCONN, if *MCAUserIdentifier* in the channel definition is blank, any user identifier transferred from the client is copied into it. This user identifier (after any modification by the security exit at the server) is the one which the client application is assumed to be running under.

The MCA user identifier is not relevant for channels with a *ChannelType* of MQCHT\_CLNTCONN.

This is an input/output field to the exit. The length of this field is given by MQ\_USER\_ID\_LENGTH. This field is not present on MQSeries for Windows or when *Version* is less than MQCD\_VERSION\_2.

*MCAType* (MQLONG)

Message channel agent type.

This is the type of the message channel agent program.

This field is relevant only for channels with a *ChannelType* of MQCHT\_SENDER, MQCHT\_SERVER, MQCHT\_REQUESTER, MQCHT\_CLUSSDR, or MQCHT\_CLUSRCVR.

The value is one of the following:

### **MQMCAT\_PROCESS**

Process.

The message channel agent runs as a separate process.

### **MQMCAT\_THREAD**

Thread (OS/2 and Windows NT only).

The message channel agent runs as a separate thread.

This value is supported in the following environments: OS/2, Windows NT.

This field is not present on MQSeries for Windows or when *Version* is less than MQCD\_VERSION\_2.

*ConnectionName* (MQCHAR264)

Connection name.

This is the full connection name of the partner. The type of name depends on the transmission protocol (*TransportType*) to be used:

- For MQXPT\_LU62, it is the fully-qualified name of the partner Logical Unit.
- For MQXPT\_NETBIOS, it is the NetBIOS name defined on the remote machine.
- For MQXPT\_TCP, it is either the host name, or the network address of the remote machine.
- For MQXPT\_SPX, it is an SPX-style address comprising a 4-byte network address, a 6-byte node address, and a 2-byte socket number.

When defining a channel, this field is not relevant for channels with a *ChannelType* of MQCHT\_SVRCONN or MQCHT\_RECEIVER. However, when the channel definition is passed to an exit, this field contains the address of the partner, whatever the channel type.

The length of this field is given by MQ\_CONN\_NAME\_LENGTH. This field is not present if *Version* is less than MQCD\_VERSION\_2.

*RemoteUserIdentifier* (MQCHAR12)

First 12 bytes of user identifier from partner.

There are two fields that contain the remote user identifier:

- *RemoteUserIdentifier* contains the first 12 bytes of the remote user identifier, and is padded with blanks if the identifier is shorter than 12 bytes. *RemoteUserIdentifier* can be completely blank.
- *LongRemoteUserIdPtr* points to the full remote user identifier, which can be longer than 12 bytes. Its length is given by *LongRemoteUserIdLength*. The full identifier contains no trailing blanks, and is not null-terminated. If the identifier is completely blank, *LongRemoteUserIdLength* is zero, and the value of *LongRemoteUserIdPtr* is undefined.

*LongRemoteUserIdPtr* is not present if *Version* is less than MQCD\_VERSION\_6.

The remote user identifier is relevant only for channels with a *ChannelType* of MQCHT\_CLNTCONN or MQCHT\_SVRCONN.

- For a security exit on an MQCHT\_CLNTCONN channel, this is a user identifier which has been obtained from the environment (from an environment variable on OS/2, Windows 3.1 and Windows NT, or from the system on UNIX platforms.) The exit can choose to send it to the security exit at the server.
- For a security exit on an MQCHT\_SVRCONN channel, this field may contain a user identifier which has been obtained from the environment at the client, if there is no client security exit. The exit may validate this user ID (possibly in conjunction with the password in *RemotePassword*) and update the value in *MCAUserIdentifier*.

If there is a security exit at the client, then this information can be obtained in a security flow from the client.

The length of this field is given by MQ\_USER\_ID\_LENGTH. This field is not present if *Version* is less than MQCD\_VERSION\_2.

*RemotePassword* (MQCHAR12)

Password from partner.

This field contains valid information only if *ChannelType* is MQCHT\_CLNTCONN or MQCHT\_SVRCONN.

- For a security exit at an MQCHT\_CLNTCONN channel, this is a password which has been obtained from the environment from an environment variable on OS/2 and Windows. The exit can choose to send it to the security exit at the server.
- For a security exit at an MQCHT\_SVRCONN channel, this field may contain a password which has been obtained from the environment at the client, if there is no client security exit. The exit may use this to validate the user identifier in *RemoteUserIdentifier*.



## MQCD

If there is a security exit at the client, then this information can be obtained in a security flow from the client.

The length of this field is given by `MQ_PASSWORD_LENGTH`. This field is not present if *Version* is less than `MQCD_VERSION_2`.

The following fields in this structure are not present if *Version* is less than `MQCD_VERSION_3`.

*MsgRetryExit* (MQCHARn)

Channel message retry exit name.

The message retry exit is an exit that is invoked by the MCA when the MCA receives a completion code of `MQCC_FAILED` from an `MQOPEN` or `MQPUT` call. The purpose of the exit is to specify a time interval for which the MCA should wait before retrying the `MQOPEN` or `MQPUT` operation. Alternatively, the exit can decide that the operation should not be retried.

The exit is invoked for all reason codes that have a completion code of `MQCC_FAILED` — it is up to the exit to decide which reason codes it wants the MCA to retry, for how many attempts, and at what time intervals.

When the exit decides that the operation should not be retried any more, the MCA performs its normal failure processing; this includes generating an exception report message (if specified by the sender), and either placing the original message on the dead-letter queue or discarding the message (according to whether the sender specified `MQRO_DEAD_LETTER_Q` or `MQRO_DISCARD_MSG`, respectively). Note that failures involving the dead-letter queue (for example, dead-letter queue full) do not cause the message-retry exit to be invoked.

If the exit name is nonblank, the exit is called at the following times:

- Immediately before performing the wait prior to retrying a message
- At initialization and termination of the channel.

See above in the introduction to MQCD for a description of the content of this field in various environments.

This field is relevant only for channels with a *ChannelType* of `MQCHT_REQUESTER`, `MQCHT_RECEIVER`, or `MQCHT_CLUSRCVR`.

The length of this field is given by `MQ_EXIT_NAME_LENGTH`.

### Notes:

1. The value of this constant is environment specific.
2. On OS/390 this field is not relevant.

This field is not present on MQSeries for Windows or when *Version* is less than `MQCD_VERSION_3`.

*MsgRetryUserData* (MQCHAR32)

Channel message retry exit user data.

This is passed to the channel message-retry exit in the *ExitData* field of the *ChannelExitParms* parameter (see `MQ_CHANNEL_EXIT`).



This field initially contains the data that was set in the channel definition. However, during the lifetime of this MCA instance, any changes made to the contents of this field by an exit of any type are preserved by the MCA, and made visible to subsequent invocations of exits (regardless of type) for this MCA instance. Such changes have no effect on the channel definition used by other MCA instances. Any characters (including binary data) can be used.

This field is relevant only for channels with a *ChannelType* of MQCHT\_REQUESTER, MQCHT\_RECEIVER, or MQCHT\_CLUSRCVR.

The length of this field is given by MQ\_EXIT\_DATA\_LENGTH. This field is not present on MQSeries for Windows or when *Version* is less than MQCD\_VERSION\_3.

On OS/390 this field is always blank.

#### *MsgRetryCount* (MQLONG)

Number of times MCA will try to put the message, after the first attempt has failed.

This indicates the number of times that the MCA will retry the open or put operation, if the first MQOPEN or MQPUT fails with completion code MQCC\_FAILED. The effect of this attribute depends on whether *MsgRetryExit* is blank or nonblank:

- If *MsgRetryExit* is blank, the *MsgRetryCount* attribute controls whether the MCA attempts retries. If the attribute value is zero, no retries are attempted. If the attribute value is greater than zero, the retries are attempted at intervals given by the *MsgRetryInterval* attribute.

Retries are attempted only for the following reason codes:

MQRC\_PAGESET\_FULL  
MQRC\_PUT\_INHIBITED  
MQRC\_Q\_FULL

For other reason codes, the MCA proceeds immediately to its normal failure processing, without retrying the failing message.

- If *MsgRetryExit* is nonblank, the *MsgRetryCount* attribute has no effect on the MCA; instead it is the message-retry exit which determines how many times the retry is attempted, and at what intervals; the exit is invoked even if the *MsgRetryCount* attribute is zero.

The *MsgRetryCount* attribute is made available to the exit in the MQCD structure, but the exit is not required to honor it — retries continue indefinitely until the exit returns MQXCC\_SUPPRESS\_FUNCTION in the *ExitResponse* field of MQCXP.

This field is relevant only for channels with a *ChannelType* of MQCHT\_REQUESTER, MQCHT\_RECEIVER, or MQCHT\_CLUSRCVR.

This field is not present on MQSeries for Windows or when *Version* is less than MQCD\_VERSION\_3.

On OS/390 this field is always zero.

#### *MsgRetryInterval* (MQLONG)

Minimum interval in milliseconds after which the open or put operation will be retried.

## MQCD

The effect of this attribute depends on whether *MsgRetryExit* is blank or nonblank:

- If *MsgRetryExit* is blank, the *MsgRetryInterval* attribute specifies the minimum period of time that the MCA will wait before retrying a message, if the first MQOPEN or MQPUT fails with completion code MQCC\_FAILED. A value of zero means that the retry will be performed as soon as possible after the previous attempt. Retries are performed only if *MsgRetryCount* is greater than zero.

This attribute is also used as the wait time if the message-retry exit returns an invalid value in the *MsgRetryInterval* field in MQCXP.

- If *MsgRetryExit* is not blank, the *MsgRetryInterval* attribute has no effect on the MCA; instead it is the message-retry exit which determines how long the MCA should wait. The *MsgRetryInterval* attribute is made available to the exit in the MQCD structure, but the exit is not required to honor it.

The value is in the range 0 through 999 999 999.

This field is relevant only for channels with a *ChannelType* of MQCHT\_REQUESTER, MQCHT\_RECEIVER, or MQCHT\_CLUSRCVR.

This field is not present on MQSeries for Windows or when *Version* is less than MQCD\_VERSION\_3.

On OS/390 this field is always zero.

The following fields in this structure are not present if *Version* is less than MQCD\_VERSION\_4.

*HeartbeatInterval* (MQLONG)

Time in seconds between heartbeat flows.

The interpretation of this field depends on the channel type, as follows:

- For a channel type of MQCHT\_SENDER, MQCHT\_SERVER, MQCHT\_RECEIVER, MQCHT\_REQUESTER, MQCHT\_CLUSSDR, or MQCHT\_CLUSRCVR, this is the time in seconds between heartbeat flows passed from the sending MCA when there are no messages on the transmission queue. This gives the receiving MCA the opportunity to quiesce the channel. To be useful, *HeartbeatInterval* should be significantly less than *DiscInterval*.

This type of heartbeat is supported in the following environments: AIX, HP-UX, OS/390, OS/2, OS/400, Sun Solaris, Windows NT.

- For a channel type of MQCHT\_CLNTCONN or MQCHT\_SVRCONN, this is the time in seconds between heartbeat flows passed from the server MCA when that MCA has issued an MQGET call with the MQGMO\_WAIT option on behalf of a client application. This allows the server MCA to handle situations where the client connection fails during an MQGET with MQGMO\_WAIT.

This type of heartbeat is supported in the following environments: AIX, HP-UX, OS/2, OS/400, Sun Solaris, Windows NT.

The value is in the range 0 through 999 999. A value of 0 means that no heartbeat exchange occurs. The value that is actually used is the larger of the values specified at the sending side and receiving side.

This is an input field to the exit. The field is not present if *Version* is less than MQCD\_VERSION\_4.

*BatchInterval* (MQLONG)

Batch duration.

This is the approximate time in milliseconds that a channel will keep a batch open, if fewer than *BatchSize* messages have been transmitted in the current batch.

If *BatchInterval* is greater than zero, the batch is terminated by whichever of the following occurs first:

- *BatchSize* messages have been sent, or
- *BatchInterval* milliseconds have elapsed since the start of the batch.

If *BatchInterval* is zero, the batch is terminated by whichever of the following occurs first:

- *BatchSize* messages have been sent, or
- the transmission queue becomes empty.

*BatchInterval* must be in the range zero through 999 999 999.

This field is relevant only for channels with a *ChannelType* of MQCHT\_SENDER, MQCHT\_SERVER, MQCHT\_CLUSSDR, or MQCHT\_CLUSRCVR.

This is an input field to the exit. The field is not present when *Version* is less than MQCD\_VERSION\_4.

*NonPersistentMsgSpeed* (MQLONG)

Speed at which nonpersistent messages are sent.

This specifies the speed at which nonpersistent messages travel through the channel.

This field is relevant only for channels with a *ChannelType* of MQCHT\_SENDER, MQCHT\_SERVER, MQCHT\_RECEIVER, MQCHT\_REQUESTER, MQCHT\_CLUSSDR, or MQCHT\_CLUSRCVR.

The value is one of the following:

**MQNPMS\_NORMAL**

Normal speed.

If a channel is defined to be MQNPMS\_NORMAL, nonpersistent messages travel through the channel at normal speed. This has the advantage that these messages will not be lost if there is a channel failure. Also, persistent and nonpersistent messages on the same transmission queue maintain their order relative to each other.

**MQNPMS\_FAST**

Fast speed.

If a channel is defined to be MQNPMS\_FAST, nonpersistent messages travel through the channel at fast speed. This improves the throughput of the channel, but means that nonpersistent messages will be lost if there is a channel failure. Also, it is possible for nonpersistent messages to jump ahead of persistent messages waiting on the same transmission queue, that is, the order of nonpersistent messages is not

## MQCD

maintained relative to persistent messages. However the order of nonpersistent messages relative to each other is maintained. Similarly, the order of persistent messages relative to each other is maintained.

*StrucLength* (MQLONG)

Length of MQCD structure.

This is the length in bytes of the MQCD structure. The length does not include any of the strings addressed by pointer fields contained within the structure. The value is one of the following:

**MQCD\_LENGTH\_4**

Length of version-4 channel definition structure.

**MQCD\_LENGTH\_5**

Length of version-5 channel definition structure.

**MQCD\_LENGTH\_6**

Length of version-6 channel definition structure.

The following constant specifies the length of the current version:

**MQCD\_CURRENT\_LENGTH**

Length of current version of channel definition structure.

**Note:** These constants have values that are environment specific. The field is not present if *Version* is less than MQCD\_VERSION\_4.

*ExitNameLength* (MQLONG)

Length of exit name.

This is the length in bytes of each of the names in the lists of exit names addressed by the *MsgExitPtr*, *SendExitPtr*, and *ReceiveExitPtr* fields. This length is not necessarily the same as MQ\_EXIT\_NAME\_LENGTH.

This is an input field to the exit. The field is not present if *Version* is less than MQCD\_VERSION\_4.

*ExitDataLength* (MQLONG)

Length of exit user data.

This is the length in bytes of each of the user data items in the lists of exit user data items addressed by the *MsgUserDataPtr*, *SendUserDataPtr*, and *ReceiveUserDataPtr* fields. This length is not necessarily the same as MQ\_EXIT\_DATA\_LENGTH.

This is an input field to the exit. The field is not present if *Version* is less than MQCD\_VERSION\_4.

*MsgExitsDefined* (MQLONG)

Number of message exits defined.

This is the number of channel message exits in the chain. On OS/390 it is always zero. On other platforms it is greater than or equal to zero.

This is an input field to the exit. The field is not present if *Version* is less than MQCD\_VERSION\_4.

*SendExitsDefined* (MQLONG)

Number of send exits defined.

This is the number of channel send exits in the chain. On OS/390 it is always zero. On other platforms it is greater than or equal to zero.

This is an input field to the exit. The field is not present if *Version* is less than MQCD\_VERSION\_4.

*ReceiveExitsDefined* (MQLONG)

Number of receive exits defined.

This is the number of channel receive exits in the chain. On OS/390 it is always zero. On other platforms it is greater than or equal to zero.

This is an input field to the exit. The field is not present if *Version* is less than MQCD\_VERSION\_4.

*MsgExitPtr* (MQPTR)

Address of first *MsgExit* field.

If *MsgExitsDefined* is greater than zero, this is the address of the list of names of each channel message exit in the chain.

Each name is in a field of length *ExitNameLength*, padded to the right with blanks. There are *MsgExitsDefined* fields adjoining one another – one for each exit.

Any changes made to these names by an exit are preserved, although the message channel exit takes no explicit action – it does not change which exits are invoked.

If *MsgExitsDefined* is zero, this field is the null pointer.

On platforms where the programming language does not support the pointer data type, this field is declared as a byte string of the appropriate length.

This is an input field to the exit. The field is not present if *Version* is less than MQCD\_VERSION\_4.

*MsgUserDataPtr* (MQPTR)

Address of first *MsgUserData* field.

If *MsgExitsDefined* is greater than zero, this is the address of the list of user data items for each channel message exit in the chain.

Each user data item is in a field of length *ExitDataLength*, padded to the right with blanks. There are *MsgExitsDefined* fields adjoining one another – one for each exit. If the number of user data items defined is less than the number of exit names, undefined user data items are set to blanks. Conversely, if the number of user data items defined is greater than the number of exit names, the excess user data items are ignored and not presented to the exit.

Any changes made to these names by an exit are preserved. This allows one exit to pass information to another exit. No validation is carried out on any changes so, for example, binary data can be written to these fields if required.

If *MsgExitsDefined* is zero, this field is the null pointer.

## MQCD

On platforms where the programming language does not support the pointer data type, this field is declared as a byte string of the appropriate length.

This is an input field to the exit. The field is not present if *Version* is less than MQCD\_VERSION\_4.

### *SendExitPtr* (MQPTR)

Address of first *SendExit* field.

If *SendExitsDefined* is greater than zero, this is the address of the list of names of each channel send exit in the chain.

Each name is in a field of length *ExitNameLength*, padded to the right with blanks. There are *SendExitsDefined* fields adjoining one another – one for each exit.

Any changes made to these names by an exit are preserved, although the message send exit takes no explicit action – it does not change which exits are invoked.

If *SendExitsDefined* is zero, this field is the null pointer.

On platforms where the programming language does not support the pointer data type, this field is declared as a byte string of the appropriate length.

This is an input field to the exit. The field is not present if *Version* is less than MQCD\_VERSION\_4.

### *SendUserDataPtr* (MQPTR)

Address of first *SendUserData* field.

If *SendExitsDefined* is greater than zero, this is the address of the list of user data items for each channel message exit in the chain.

Each user data item is in a field of length *ExitDataLength*, padded to the right with blanks. There are *MsgExitsDefined* fields adjoining one another – one for each exit. If the number of user data items defined is less than the number of exit names, undefined user data items are set to blanks. Conversely, if the number of user data items defined is greater than the number of exit names, the excess user data items are ignored and not presented to the exit.

Any changes made to these names by an exit are preserved. This allows one exit to pass information to another exit. No validation is carried out on any changes so, for example, binary data can be written to these fields if required.

If *SendExitsDefined* is zero, this field is the null pointer.

On platforms where the programming language does not support the pointer data type, this field is declared as a byte string of the appropriate length.

This is an input field to the exit. The field is not present if *Version* is less than MQCD\_VERSION\_4.

### *ReceiveExitPtr* (MQPTR)

Address of first *ReceiveExit* field.

If *ReceiveExitsDefined* is greater than zero, this is the address of the list of names of each channel receive exit in the chain.

Each name is in a field of length *ExitNameLength*, padded to the right with blanks. There are *ReceiveExitsDefined* fields adjoining one another – one for each exit.

Any changes made to these names by an exit are preserved, although the message channel exit takes no explicit action – it does not change which exits are invoked.

If *ReceiveExitsDefined* is zero, this field is the null pointer.

On platforms where the programming language does not support the pointer data type, this field is declared as a byte string of the appropriate length.

This is an input field to the exit. The field is not present if *Version* is less than MQCD\_VERSION\_4.

#### *ReceiveUserDataPtr* (MQPTR)

Address of first *ReceiveUserData* field.

If *ReceiveExitsDefined* is greater than zero, this is the address of the list of user data item for each channel receive exit in the chain.

Each user data item is in a field of length *ExitDataLength*, padded to the right with blanks. There are *ReceiveExitsDefined* fields adjoining one another – one for each exit. If the number of user data items defined is less than the number of exit names, undefined user data items are set to blanks. Conversely, if the number of user data items defined is greater than the number of exit names, the excess user data items are ignored and not presented to the exit."

Any changes made to these names by an exit are preserved. This allows one exit to pass information to another exit. No validation is carried out on any changes so, for example, binary data can be written to these fields if required.

If *ReceiveExitsDefined* is zero, this field is the null pointer.

On platforms where the programming language does not support the pointer data type, this field is declared as a byte string of the appropriate length.

This is an input field to the exit. The field is not present if *Version* is less than MQCD\_VERSION\_4.

The following fields in this structure are not present if *Version* is less than MQCD\_VERSION\_5.

#### *ClusterPtr* (MQPTR)

Address of first cluster record.

If *ClustersDefined* is greater than zero, this is the address of the first cluster record (MQWCR structure) in a chain of cluster records. Each cluster record identifies a cluster to which the channel belongs.

This field is relevant only for channels with a *ChannelType* of MQCHT\_CLUSSDR or MQCHT\_CLUSRCVR.



## MQCD

This is an input field to the exit. The field is not present if *Version* is less than MQCD\_VERSION\_5.

*ClustersDefined* (MQLONG)

Number of cluster records.

This is the number of cluster records (MQWCR structures) pointed to by *ClusterPtr*. It is zero or greater.

This field is relevant only for channels with a *ChannelType* of MQCHT\_CLUSSDR or MQCHT\_CLUSRCVR.

This is an input field to the exit. The field is not present if *Version* is less than MQCD\_VERSION\_5.

*NetworkPriority* (MQLONG)

Network priority.

This is the priority of the network connection for this channel. When multiple paths to a particular destination are available, the path with the highest priority is chosen. The value is in the range 0 through 9; 0 is the lowest priority.

This field is relevant only for channels with a *ChannelType* of MQCHT\_CLUSSDR or MQCHT\_CLUSRCVR.

This is an input field to the exit. The field is not present if *Version* is less than MQCD\_VERSION\_5.

The following fields in this structure are not present if *Version* is less than MQCD\_VERSION\_6.

*LongMCAUserIdLength* (MQLONG)

Length of long MCA user identifier.

This is the length in bytes of the full MCA user identifier pointed to by *LongMCAUserIdPtr*.

This field is not relevant for channels with a *ChannelType* of MQCHT\_CLNTCONN.

This is an input/output field to the exit. The field is not present if *Version* is less than MQCD\_VERSION\_6.

*LongRemoteUserIdLength* (MQLONG)

Length of long remote user identifier.

This is the length in bytes of the full remote user identifier pointed to by *LongRemoteUserIdPtr*.

This field is relevant only for channels with a *ChannelType* of MQCHT\_CLNTCONN or MQCHT\_SVRCONN.

This is an input field to the exit. The field is not present if *Version* is less than MQCD\_VERSION\_6.

*LongMCAUserIdPtr* (MQPTR)

Address of long MCA user identifier.



If *LongMCAUserIdLength* is greater than zero, this is the address of the full MCA user identifier. The length of the full identifier is given by *LongMCAUserIdLength*. The first 12 bytes of the MCA user identifier are also contained in the field *MCAUserIdentifier*.

See the description of the *MCAUserIdentifier* field for details of the MCA user identifier.

This field is not relevant for channels with a *ChannelType* of MQCHT\_CLNTCONN.

This is an input/output field to the exit. The field is not present if *Version* is less than MQCD\_VERSION\_6.

*LongRemoteUserIdPtr* (MQPTR)

Address of long remote user identifier.

If *LongRemoteUserIdLength* is greater than zero, this is the address of the full remote user identifier. The length of the full identifier is given by *LongRemoteUserIdLength*. The first 12 bytes of the remote user identifier are also contained in the field *RemoteUserIdentifier*.

See the description of the *RemoteUserIdentifier* field for details of the remote user identifier.

This field is relevant only for channels with a *ChannelType* of MQCHT\_CLNTCONN or MQCHT\_SVRCONN.

This is an input field to the exit. The field is not present if *Version* is less than MQCD\_VERSION\_6.

*MCASecurityId* (MQBYTE40)

MCA security identifier.

This is the security identifier for the MCA.

This field is not relevant for channels with a *ChannelType* of MQCHT\_CLNTCONN.

The following special value indicates that there is no security identifier:

**MQSID\_NONE**

No security identifier specified.

The value is binary zero for the length of the field.

For the C programming language, the constant `MQSID_NONE_ARRAY` is also defined; this has the same value as `MQSID_NONE`, but is an array of characters instead of a string.

This is an input/output field to the exit. The length of this field is given by `MQ_SECURITY_ID_LENGTH`. This field is not present if *Version* is less than MQCD\_VERSION\_6.

*RemoteSecurityId* (MQBYTE40)

Remote security identifier.

This is the security identifier for the remote user.

## MQCD

This field is relevant only for channels with a *ChannelType* of MQCHT\_CLNTCONN or MQCHT\_SVRCONN.

The following special value indicates that there is no security identifier:

### MQSID\_NONE

No security identifier specified.

The value is binary zero for the length of the field.

For the C programming language, the constant MQSID\_NONE\_ARRAY is also defined; this has the same value as MQSID\_NONE, but is an array of characters instead of a string.

This is an input field to the exit. The length of this field is given by MQ\_SECURITY\_ID\_LENGTH. This field is not present if *Version* is less than MQCD\_VERSION\_6.

## C declaration

```
typedef struct tagMQCD {
    MQCHAR    ChannelName[20];          /* Channel definition
                                         name */
    MQLONG    Version;                 /* Structure version number */
    MQLONG    ChannelType;             /* Channel type */
    MQLONG    TransportType;          /* Transport type */
    MQCHAR    Desc[64];                /* Channel
                                         description */
    MQCHAR    QMgrName[48];           /* Queue-manager
                                         name */
    MQCHAR    XmitQName[48];          /* Transmission queue
                                         name */
    MQCHAR    ShortConnectionName[20]; /* First 20 bytes of
                                         connection name */
    MQCHAR    MCAName[20];            /* Reserved */
    MQCHAR    ModeName[8];            /* LU 6.2 Mode name */
    MQCHAR    TpName[64];             /* LU 6.2 transaction
                                         program name */
    MQLONG    BatchSize;              /* Batch size */
    MQLONG    DiscInterval;           /* Disconnect interval */
    MQLONG    ShortRetryCount;        /* Short retry count */
    MQLONG    ShortRetryInterval;     /* Short retry wait interval */
    MQLONG    LongRetryCount;        /* Long retry count */
    MQLONG    LongRetryInterval;     /* Long retry wait interval */
    MQCHAR    SecurityExit[n];        /* Channel security
                                         exit name */
    MQCHAR    MsgExit[n];            /* Channel message exit
                                         name */
    MQCHAR    SendExit[n];           /* Channel send exit
                                         name */
    MQCHAR    ReceiveExit[n];        /* Channel receive exit
                                         name */
    MQLONG    SeqNumberWrap;          /* Highest allowable message
                                         sequence number */
    MQLONG    MaxMsgLength;           /* Maximum message length */
    MQLONG    PutAuthority;           /* Put authority */
    MQLONG    DataConversion;        /* Data conversion */
    MQCHAR    SecurityUserData[32];   /* Channel security
                                         exit user data */
    MQCHAR    MsgUserData[32];        /* Channel message exit
                                         user data */
    MQCHAR    SendUserData[32];      /* Channel send exit
                                         user data */
    MQCHAR    ReceiveUserData[32];   /* Channel receive exit
                                         user data */
};
```

```

MQCHAR  UserIdentifier[12];      /* User identifier */
MQCHAR  Password[12];          /* Password */
MQCHAR  MCAUserIdentifier[12]; /* First 12 bytes of
                               MCA user identifier */
MQLONG  MCAType;               /* Message channel agent type */
MQCHAR  ConnectionName[264];   /* Connection name */
MQCHAR  RemoteUserIdentifier[12]; /* First 12 bytes of
                               user identifier from
                               partner */
MQCHAR  RemotePassword[12];    /* Password from
                               partner */
MQCHAR  MsgRetryExit[n];       /* Channel message
                               retry exit name */
MQCHAR  MsgRetryUserData[32];  /* Channel message
                               retry exit user data */
MQLONG  MsgRetryCount;         /* Number of times MCA will try
                               to put the message, after the
                               first attempt has failed */
MQLONG  MsgRetryInterval;      /* Minimum interval in millisec-
                               onds after which the open or
                               put operation will be
                               retried */
MQLONG  HeartbeatInterval;     /* Time in seconds between
                               heartbeat flows */
MQLONG  BatchInterval;         /* Batch duration */
MQLONG  NonPersistentMsgSpeed; /* Speed at which nonpersistent
                               messages are sent */
MQLONG  StrucLength;           /* Length of MQCD structure */
MQLONG  ExitNameLength;        /* Length of exit name */
MQLONG  ExitDataLength;        /* Length of exit user data */
MQLONG  MsgExitsDefined;       /* Number of message exits
                               defined */
MQLONG  SendExitsDefined;      /* Number of send exits
                               defined */
MQLONG  ReceiveExitsDefined;   /* Number of receive exits
                               defined */
MQPTR   MsgExitPtr;            /* Address of first MsgExit
                               field */
MQPTR   MsgUserDataPtr;        /* Address of first MsgUserData
                               field */
MQPTR   SendExitPtr;           /* Address of first SendExit
                               field */
MQPTR   SendUserDataPtr;       /* Address of first SendUserData
                               field */
MQPTR   ReceiveExitPtr;        /* Address of first ReceiveExit
                               field */
MQPTR   ReceiveUserDataPtr;    /* Address of first
                               ReceiveUserData field */
MQPTR   ClusterPtr;            /* Address of first cluster
                               record */
MQLONG  ClustersDefined;       /* Number of cluster records */
MQLONG  NetworkPriority;        /* Network priority */
MQLONG  LongMCAUserIdLength;   /* Length of long MCA user iden-
                               tifier */
MQLONG  LongRemoteUserIdLength; /* Length of long remote user
                               identifier */
MQPTR   LongMCAUserIdPtr;      /* Address of long MCA user iden-
                               tifier */
MQPTR   LongRemoteUserIdPtr;   /* Address of long remote user
                               identifier */
MQBYTE40 MCASecurityId;        /* MCA security identifier */
MQBYTE40 RemoteSecurityId;     /* Remote security identifier */
} MQCD;

```

## COBOL declaration

```

**  MQCD structure
10 MQCD.
**  Channel definition name
15 MQCD-CHANNELNAME          PIC X(20).
**  Structure version number
15 MQCD-VERSION              PIC S9(9) BINARY.
**  Channel type
15 MQCD-CHANNELTYPE         PIC S9(9) BINARY.
**  Transport type
15 MQCD-TRANSPORTTYPE       PIC S9(9) BINARY.
**  Channel description
15 MQCD-DESC                 PIC X(64).
**  Queue-manager name
15 MQCD-QMGRNAME            PIC X(48).
**  Transmission queue name
15 MQCD-XMITQNAME           PIC X(48).
**  First 20 bytes of connection name
15 MQCD-SHORTCONNECTIONNAME PIC X(20).
**  Reserved
15 MQCD-MCANAME             PIC X(20).
**  LU 6.2 Mode name
15 MQCD-MODENAME            PIC X(8).
**  LU 6.2 transaction program name
15 MQCD-TPNAME              PIC X(64).
**  Batch size
15 MQCD-BATCHSIZE           PIC S9(9) BINARY.
**  Disconnect interval
15 MQCD-DISCINTERVAL        PIC S9(9) BINARY.
**  Short retry count
15 MQCD-SHORTRETRYCOUNT    PIC S9(9) BINARY.
**  Short retry wait interval
15 MQCD-SHORTRETRYINTERVAL  PIC S9(9) BINARY.
**  Long retry count
15 MQCD-LONGRETRYCOUNT     PIC S9(9) BINARY.
**  Long retry wait interval
15 MQCD-LONGRETRYINTERVAL   PIC S9(9) BINARY.
**  Channel security exit name
15 MQCD-SECURITYEXIT        PIC X(n).
**  Channel message exit name
15 MQCD-MSGEXIT             PIC X(n).
**  Channel send exit name
15 MQCD-SENDEXIT            PIC X(n).
**  Channel receive exit name
15 MQCD-RECEIVEEXIT         PIC X(n).
**  Highest allowable message sequence number
15 MQCD-SEQNUMBERWRAP       PIC S9(9) BINARY.
**  Maximum message length
15 MQCD-MAXMSGLENGTH        PIC S9(9) BINARY.
**  Put authority
15 MQCD-PUTAUTHORITY        PIC S9(9) BINARY.
**  Data conversion
15 MQCD-DATACONVERSION      PIC S9(9) BINARY.
**  Channel security exit user data
15 MQCD-SECURITYUSERDATA    PIC X(32).
**  Channel message exit user data
15 MQCD-MSGUSERDATA         PIC X(32).
**  Channel send exit user data
15 MQCD-SENDUSERDATA        PIC X(32).
**  Channel receive exit user data
15 MQCD-RECEIVEUSERDATA     PIC X(32).
**  User identifier
15 MQCD-USERIDENTIFIER      PIC X(12).
**  Password
15 MQCD-PASSWORD            PIC X(12).
**  First 12 bytes of MCA user identifier

```

```

15 MQCD-MCAUSERIDENTIFIER      PIC X(12).
** Message channel agent type
15 MQCD-MCATYPE                 PIC S9(9) BINARY.
** Connection name
15 MQCD-CONNECTIONNAME         PIC X(264).
** First 12 bytes of user identifier from partner
15 MQCD-REMOTEUSERIDENTIFIER   PIC X(12).
** Password from partner
15 MQCD-REMOTEPASSWORD         PIC X(12).
** Channel message retry exit name
15 MQCD-MSGRETRYEXIT          PIC X(n).
** Channel message retry exit user data
15 MQCD-MSGRETRYUSERDATA       PIC X(32).
** Number of times MCA will try to put the message, after the
** first attempt has failed
15 MQCD-MSGRETRYCOUNT        PIC S9(9) BINARY.
** Minimum interval in milliseconds after which the open or put
** operation will be retried
15 MQCD-MSGRETRYINTERVAL       PIC S9(9) BINARY.
** Time in seconds between heartbeat flows
15 MQCD-HEARTBEATINTERVAL      PIC S9(9) BINARY.
** Batch duration
15 MQCD-BATCHINTERVAL          PIC S9(9) BINARY.
** Speed at which nonpersistent messages are sent
15 MQCD-NONPERSISTENTMSGSPD    PIC S9(9) BINARY.
** Length of MQCD structure
15 MQCD-STRUCLength           PIC S9(9) BINARY.
** Length of exit name
15 MQCD-EXITNAMELENGTH         PIC S9(9) BINARY.
** Length of exit user data
15 MQCD-EXITDATALENGTH         PIC S9(9) BINARY.
** Number of message exits defined
15 MQCD-MSGEXITSDEFINED        PIC S9(9) BINARY.
** Number of send exits defined
15 MQCD-SENDEXITSDEFINED       PIC S9(9) BINARY.
** Number of receive exits defined
15 MQCD-RECEIVEEXITSDEFINED    PIC S9(9) BINARY.
** Address of first MsgExit field
15 MQCD-MSGEXITPTR             POINTER.
** Address of first MsgUserData field
15 MQCD-MSGUSERDATAPTR         POINTER.
** Address of first SendExit field
15 MQCD-SENDEXITPTR            POINTER.
** Address of first SendUserData field
15 MQCD-SENDUSERDATAPTR        POINTER.
** Address of first ReceiveExit field
15 MQCD-RECEIVEEXITPTR         POINTER.
** Address of first ReceiveUserData field
15 MQCD-RECEIVEUSERDATAPTR     POINTER.
** Address of first cluster record
15 MQCD-CLUSTERPTR             POINTER.
** Number of cluster records
15 MQCD-CLUSTERSDEFINED        PIC S9(9) BINARY.
** Network priority
15 MQCD-NETWORKPRIORITY        PIC S9(9) BINARY.
** Length of long MCA user identifier
15 MQCD-LONGMCAUSERIDLENGTH    PIC S9(9) BINARY.
** Length of long remote user identifier
15 MQCD-LONGREMOTEUSERIDLENGTH PIC S9(9) BINARY.
** Address of long MCA user identifier
15 MQCD-LONGMCAUSERIDPTR       POINTER.
** Address of long remote user identifier
15 MQCD-LONGREMOTEUSERIDPTR    POINTER.
** MCA security identifier
15 MQCD-MCASECURITYID          PIC X(40).
** Remote security identifier
15 MQCD-REMOTESECURITYID       PIC X(40).

```

## PL/I declaration

```

dc1
  1 MQCD based,
    3 ChannelName          char(20),      /* Channel definition name */
    3 Version              fixed bin(31), /* Structure version number */
    3 ChannelType          fixed bin(31), /* Channel type */
    3 TransportType        fixed bin(31), /* Transport type */
    3 Desc                 char(64),      /* Channel description */
    3 QMgrName             char(48),      /* Queue-manager name */
    3 XmitQName            char(48),      /* Transmission queue name */
    3 ShortConnectionName char(20),      /* First 20 bytes of connection
                                     name */
    3 MCAName              char(20),      /* Reserved */
    3 ModeName             char(8),       /* LU 6.2 Mode name */
    3 TpName               char(64),      /* LU 6.2 transaction program
                                     name */
    3 BatchSize            fixed bin(31), /* Batch size */
    3 DiscInterval         fixed bin(31), /* Disconnect interval */
    3 ShortRetryCount      fixed bin(31), /* Short retry count */
    3 ShortRetryInterval   fixed bin(31), /* Short retry wait interval */
    3 LongRetryCount       fixed bin(31), /* Long retry count */
    3 LongRetryInterval    fixed bin(31), /* Long retry wait interval */
    3 SecurityExit         char(n),       /* Channel security exit
                                     name */
    3 MsgExit              char(n),       /* Channel message exit name */
    3 SendExit             char(n),       /* Channel send exit name */
    3 ReceiveExit         char(n),       /* Channel receive exit name */
    3 SeqNumberWrap        fixed bin(31), /* Highest allowable message
                                     sequence number */
    3 MaxMsgLength         fixed bin(31), /* Maximum message length */
    3 PutAuthority         fixed bin(31), /* Put authority */
    3 DataConversion       fixed bin(31), /* Data conversion */
    3 SecurityUserData     char(32),      /* Channel security exit user
                                     data */
    3 MsgUserData          char(32),      /* Channel message exit user
                                     data */
    3 SendUserData         char(32),      /* Channel send exit user
                                     data */
    3 ReceiveUserData      char(32),      /* Channel receive exit user
                                     data */
    3 UserIdentifier       char(12),      /* User identifier */
    3 Password             char(12),      /* Password */
    3 MCAUserIdentifier    char(12),      /* First 12 bytes of MCA user
                                     identifier */
    3 MCAType              fixed bin(31), /* Message channel agent
                                     type */
    3 ConnectionName       char(264),     /* Connection name */
    3 RemoteUserIdentifier char(12),      /* First 12 bytes of user iden-
                                     tifier from partner */
    3 RemotePassword       char(12),      /* Password from partner */
    3 MsgRetryExit         char(n),       /* Channel message retry exit
                                     name */
    3 MsgRetryUserData     char(32),      /* Channel message retry exit
                                     user data */
    3 MsgRetryCount        fixed bin(31), /* Number of times MCA will try
                                     to put the message, after
                                     the first attempt has
                                     failed */
    3 MsgRetryInterval     fixed bin(31), /* Minimum interval in milli-
                                     seconds after which the open
                                     or put operation will be
                                     retried */
    3 HeartbeatInterval    fixed bin(31), /* Time in seconds between
                                     heartbeat flows */
    3 BatchInterval        fixed bin(31), /* Batch duration */
    3 NonPersistentMsgSpeed fixed bin(31), /* Speed at which nonpersistent

```

```

3 StrucLength      fixed bin(31), /* Length of MQCD structure */
3 ExitNameLength   fixed bin(31), /* Length of exit name */
3 ExitDataLength   fixed bin(31), /* Length of exit user data */
3 MsgExitsDefined  fixed bin(31), /* Number of message exits
                        defined */
3 SendExitsDefined fixed bin(31), /* Number of send exits
                        defined */
3 ReceiveExitsDefined fixed bin(31), /* Number of receive exits
                        defined */
3 MsgExitPtr       pointer, /* Address of first MsgExit
                        field */
3 MsgUserDataPtr   pointer, /* Address of first MsgUserData
                        field */
3 SendExitPtr      pointer, /* Address of first SendExit
                        field */
3 SendUserDataPtr  pointer, /* Address of first
                        SendUserData field */
3 ReceiveExitPtr   pointer, /* Address of first ReceiveExit
                        field */
3 ReceiveUserDataPtr pointer, /* Address of first
                        ReceiveUserData field */
3 ClusterPtr       pointer, /* Address of first cluster
                        record */
3 ClustersDefined  fixed bin(31), /* Number of cluster records */
3 NetworkPriority   fixed bin(31); /* Network priority */

```

## ILE RPG declaration

```

D*..1.....2.....3.....4.....5.....6.....7..
D* MQCD Structure
D*
D* Channel definition name
D CDCHN          1      20
D* Structure version number
D CDVER          21     24I 0
D* Channel type
D CDCHT          25     28I 0
D* Transport type
D CDTRT          29     32I 0
D* Channel description
D CDDDES         33     96
D* Queue-manager name
D CDQM           97     144
D* Transmission queue name
D CDXQ          145     192
D* First 20 bytes of connection name
D CDSCN         193     212
D* Reserved
D CDMCA         213     232
D* LU 6.2 Mode name
D CDMOD         233     240
D* LU 6.2 transaction program name
D CDTP          241     304
D* Batch size
D CDBS          305     308I 0
D* Disconnect interval
D CDDI          309     312I 0
D* Short retry count
D CDSRC         313     316I 0
D* Short retry wait interval
D CDSRI         317     320I 0
D* Long retry count
D CDLRC         321     324I 0
D* Long retry wait interval
D CDLRI         325     328I 0
D* Channel security exit name

```

## MQCD

D	CDSCX	329	348
D*	Channel message exit name		
D	CDMSX	349	368
D*	Channel send exit name		
D	CDSNX	369	388
D*	Channel receive exit name		
D	CDRCX	389	408
D*	Highest allowable message sequence number		
D	CDSNW	409	412I 0
D*	Maximum message length		
D	CDMML	413	416I 0
D*	Put authority		
D	CDPA	417	420I 0
D*	Data conversion		
D	CDDC	421	424I 0
D*	Channel security exit user data		
D	CDSCD	425	456
D*	Channel message exit user data		
D	CDMSD	457	488
D*	Channel send exit user data		
D	CDSND	489	520
D*	Channel receive exit user data		
D	CDRCD	521	552
D*	User identifier		
D	CDUID	553	564
D*	Password		
D	CDPW	565	576
D*	First 12 bytes of MCA user identifier		
D	CDAUI	577	588
D*	Message channel agent type		
D	CDCAT	589	592I 0
D*	Connection name (characters 1 through 256)		
D	CDCON	593	848
D*	Connection name (characters 257 through 264)		
D	CDCN2	849	856
D*	First 12 bytes of user identifier from partner		
D	CDRUI	857	868
D*	Password from partner		
D	CDRPW	869	880
D*	Channel message retry exit name		
D	CDMRX	881	900
D*	Channel message retry exit user data		
D	CDMRD	901	932
D*	Number of times MCA will try to put the message, after the first attempt has failed		
D	CDMRC	933	936I 0
D*	Minimum interval in milliseconds after which the open or put operation will be retried		
D	CDMRI	937	940I 0
D*	Time in seconds between heartbeat flows		
D	CDHBI	941	944I 0
D*	Batch duration		
D	CDBI	945	948I 0
D*	Speed at which nonpersistent messages are sent		
D	CDNPM	949	952I 0
D*	Length of MQCD structure		
D	CDLEN	953	956I 0
D*	Length of exit name		
D	CDXNL	957	960I 0
D*	Length of exit user data		
D	CDXDL	961	964I 0
D*	Number of message exits defined		
D	CDMXD	965	968I 0
D*	Number of send exits defined		
D	CDSXD	969	972I 0
D*	Number of receive exits defined		
D	CDRXD	973	976I 0



```

D* Address of first MsgExit field
D CDMXP          977  992*
D* Address of first MsgUserData field
D CDMUP          993 1008*
D* Address of first SendExit field
D CDSXP         1009 1024*
D* Address of first SendUserData field
D CDSUP         1025 1040*
D* Address of first ReceiveExit field
D CDRXP         1041 1056*
D* Address of first ReceiveUserData field
D CDRUP         1057 1072*
D* Address of first cluster record
D CDCLP         1073 1088*
D* Number of cluster records
D CDCLD         1089 1092I 0
D* Network priority
D CDNP          1093 1096I 0
D* Length of long MCA user identifier
D CDLML         1097 1100I 0
D* Length of long remote user identifier
D CDLRL         1101 1104I 0
D* Address of long MCA user identifier
D CDLMP         1105 1120*
D* Address of long remote user identifier
D CDLRP         1121 1136*
D* MCA security identifier
D CDMSI         1137 1176
D* Remote security identifier
D CDRSI         1177 1216

```

## OPM RPG declaration

```

I*..1.....2.....3.....4.....5.....6.....7..
I* MQCD Structure
I*
I* Channel definition name
I          1  20 CDCHN
I* Structure version number
I          B  21  240CDVER
I* Channel type
I          B  25  280CDCHT
I* Transport type
I          B  29  320CDTRT
I* Channel description
I          33  96 CDDES
I* Queue-manager name
I          97 144 CDQM
I* Transmission queue name
I          145 192 CDXQ
I* First 20 bytes of connection name
I          193 212 CDSCN
I* Reserved
I          213 232 CDMCA
I* LU 6.2 Mode name
I          233 240 CDMOD
I* LU 6.2 transaction program name
I          241 304 CDTP
I* Batch size
I          B 305 3080CDBS
I* Disconnect interval
I          B 309 3120CDDI
I* Short retry count
I          B 313 3160CDSRC
I* Short retry wait interval
I          B 317 3200CDSRI
I* Long retry count

```

## MQCD

I		B 321 324	CDLRC
I*	Long retry wait interval		
I		B 325 328	CDLRI
I*	Channel security exit name		
I		329 348	CDSCX
I*	Channel message exit name		
I		349 368	CDMSX
I*	Channel send exit name		
I		369 388	CDSNX
I*	Channel receive exit name		
I		389 408	CDRCX
I*	Highest allowable message sequence number		
I		B 409 412	CDSNW
I*	Maximum message length		
I		B 413 416	CDMML
I*	Put authority		
I		B 417 420	CDPA
I*	Data conversion		
I		B 421 424	CDDC
I*	Channel security exit user data		
I		425 456	CDSCD
I*	Channel message exit user data		
I		457 488	CDMSD
I*	Channel send exit user data		
I		489 520	CDSND
I*	Channel receive exit user data		
I		521 552	CDRCD
I*	User identifier		
I		553 564	CDUID
I*	Password		
I		565 576	CDPW
I*	First 12 bytes of MCA user identifier		
I		577 588	CDAUI
I*	Message channel agent type		
I		B 589 592	CDCAT
I*	Connection name (characters 1 through 256)		
I		593 848	CDCON
I*	Connection name (characters 257 through 264)		
I		849 856	CDCN2
I*	First 12 bytes of user identifier from partner		
I		857 868	CDRUI
I*	Password from partner		
I		869 880	CDRPW
I*	Channel message retry exit name		
I		881 900	CDMRX
I*	Channel message retry exit user data		
I		901 932	CDMRD
I*	Number of times MCA will try to put the message, after the first attempt has failed		
I		B 933 936	CDMRC
I*	Minimum interval in milliseconds after which the open or put operation will be retried		
I		B 937 940	CDMRI
I*	Time in seconds between heartbeat flows		
I		B 941 944	CDHBI
I*	Batch duration		
I		B 945 948	CDDBI
I*	Speed at which nonpersistent messages are sent		
I		B 949 952	CDNPM
I*	Length of MQCD structure		
I		B 953 956	CDLEN
I*	Length of exit name		
I		B 957 960	CDXNL
I*	Length of exit user data		
I		B 961 964	CDXDL
I*	Number of message exits defined		
I		B 965 968	CDMXD

```

I* Number of send exits defined
I                                     B 969 9720CDSXD
I* Number of receive exits defined
I                                     B 973 9760CDRXD
I* Address of first MsgExit field
I                                     977 992 CDMXP
I* Address of first MsgUserData field
I                                     9931008 CDMUP
I* Address of first SendExit field
I                                     10091024 CDSXP
I* Address of first SendUserData field
I                                     10251040 CDSUP
I* Address of first ReceiveExit field
I                                     10411056 CDRXP
I* Address of first ReceiveUserData field
I                                     10571072 CDRUP
I* Address of first cluster record
I                                     10731088 CDCLP
I* Number of cluster records
I                                     B108910920CDCLD
I* Network priority
I                                     B109310960CDNP
I* Length of long MCA user identifier
I                                     B109711000CDLML
I* Length of long remote user identifier
I                                     B110111040CDLRL
I* Address of long MCA user identifier
I                                     11051120 CDLMP
I* Address of long remote user identifier
I                                     11211136 CDLRP
I* MCA security identifier
I                                     11371176 CDMSI
I* Remote security identifier
I                                     11771216 CDRSI

```

## System/390 assembler declaration

MQCD	DSECT		
MQCD_CHANNELNAME	DS CL20		Channel definition name
MQCD_VERSION	DS F		Structure version number
MQCD_CHANNELTYPE	DS F		Channel type
MQCD_TRANSPORTTYPE	DS F		Transport type
MQCD_DESC	DS CL64		Channel description
MQCD_QMGRNAME	DS CL48		Queue-manager name
MQCD_XMITQNAME	DS CL48		Transmission queue name
MQCD_SHORTCONNECTIONNAME	DS CL20		First 20 bytes of connection name
*			
MQCD_MCANAME	DS CL20		Reserved
MQCD_MODENAME	DS CL8		LU 6.2 Mode name
MQCD_TPNAME	DS CL64		LU 6.2 transaction program name
*			
MQCD_BATCHSIZE	DS F		Batch size
MQCD_DISCINTERVAL	DS F		Disconnect interval
MQCD_SHORTRETRYCOUNT	DS F		Short retry count
MQCD_SHORTRETRYINTERVAL	DS F		Short retry wait interval
MQCD_LONGRETRYCOUNT	DS F		Long retry count
MQCD_LONGRETRYINTERVAL	DS F		Long retry wait interval
MQCD_SECURITYEXIT	DS CLn		Channel security exit name
MQCD_MSGEXIT	DS CLn		Channel message exit name
MQCD_SENDEXIT	DS CLn		Channel send exit name
MQCD_RECEIVEEXIT	DS CLn		Channel receive exit name
MQCD_SEQNUMBERWRAP	DS F		Highest allowable message sequence number
*			
MQCD_MAXMSGLENGTH	DS F		Maximum message length
MQCD_PUTAUTHORITY	DS F		Put authority
MQCD_DATACONVERSION	DS F		Data conversion
MQCD_SECURITYUSERDATA	DS CL32		Channel security exit user

## MQCD

*				data
MQCD_MSGUSERDATA	DS	CL32		Channel message exit user data
*				data
MQCD_SENDUSERDATA	DS	CL32		Channel send exit user data
MQCD_RECEIVEUSERDATA	DS	CL32		Channel receive exit user data
*				data
MQCD_USERIDENTIFIER	DS	CL12		User identifier
MQCD_PASSWORD	DS	CL12		Password
MQCD_MCAUSERIDENTIFIER	DS	CL12		First 12 bytes of MCA user identifier
*				
MQCD_MCATYPE	DS	F		Message channel agent type
MQCD_CONNECTIONNAME	DS	CL264		Connection name
MQCD_REMOTEUSERIDENTIFIER	DS	CL12		First 12 bytes of user identifier from partner
*				
MQCD_REMOTEPASSWORD	DS	CL12		Password from partner
MQCD_MSGRETRYEXIT	DS	CLn		Channel message retry exit name
*				
MQCD_MSGRETRYUSERDATA	DS	CL32		Channel message retry exit user data
*				
MQCD_MSGRETRYCOUNT	DS	F		Number of times MCA will try to put the message, after the first attempt has failed
*				
MQCD_MSGRETRYINTERVAL	DS	F		Minimum interval in milliseconds after which the open or put operation will be retried
*				
MQCD_HEARTBEATINTERVAL	DS	F		Time in seconds between heartbeat flows
*				
MQCD_BATCHINTERVAL	DS	F		Batch duration
MQCD_NONPERSISTENTMSGSPPEED	DS	F		Speed at which nonpersistent messages are sent
*				
MQCD_STRUCLNGTH	DS	F		Length of MQCD structure
MQCD_EXITNAMELENGTH	DS	F		Length of exit name
MQCD_EXITDATALENGTH	DS	F		Length of exit user data
MQCD_MSGEXITSDEFINED	DS	F		Number of message exits defined
*				
MQCD_SENDEXITSDEFINED	DS	F		Number of send exits defined
MQCD_RECEIVEEXITSDEFINED	DS	F		Number of receive exits defined
*				
MQCD_MSGEXITPTR	DS	F		Address of first MsgExit field
*				
MQCD_MSGUSERDATAPTR	DS	F		Address of first MsgUserData field
*				
MQCD_SENDEXITPTR	DS	F		Address of first SendExit field
*				
MQCD_SENDUSERDATAPTR	DS	F		Address of first SendUserData field
*				
MQCD_RECEIVEEXITPTR	DS	F		Address of first ReceiveExit field
*				
MQCD_RECEIVEUSERDATAPTR	DS	F		Address of first ReceiveUserData field
*				
MQCD_CLUSTERPTR	DS	F		Address of first cluster record
*				
MQCD_CLUSTERSDEFINED	DS	F		Number of cluster records
MQCD_NETWORKPRIORITY	DS	F		Network priority
MQCD_LENGTH	EQU	*-MQCD		Length of structure
	ORG	MQCD		
MQCD_AREA	DS	CL(MQCD_LENGTH)		

## MQCXP - Channel exit parameter structure

The following table summarizes the fields in the structure.

Table 49. Fields in MQCXP

Field	Description	Page
<i>StrucId</i>	Structure identifier	591
<i>Version</i>	Structure version number	592
<i>ExitId</i>	Type of exit	592
<i>ExitReason</i>	Reason for invoking exit	593
<i>ExitResponse</i>	Response from exit	595
<i>ExitResponse2</i>	Secondary response from exit	596
<i>Feedback</i>	Feedback code	598
<i>MaxSegmentLength</i>	Maximum segment length	598
<i>ExitUserArea</i>	Exit user area	598
<i>ExitData</i>	Exit data	599
<i>MsgRetryCount</i>	Number of times the message has been retried	599
<i>MsgRetryInterval</i>	Minimum interval in milliseconds after which the put operation should be retried	599
<i>MsgRetryReason</i>	Reason code from previous attempt to put the message	600
<i>HeaderLength</i>	Length of header	600
<i>PartnerName</i>	Partner name	600
<i>FAPLevel</i>	Negotiated Formats and Protocols level	600
<i>CapabilityFlags</i>	Capability flags	601
<i>ExitNumber</i>	Exit number	601

The MQCXP structure is passed to each type of exit called by a Message Channel Agent (MCA). See MQ\_CHANNEL\_EXIT.

The fields described as “input to the exit” in the descriptions that follow are ignored by the MCA when the exit returns control to the MCA. The exit should not expect that any input fields that it changes in the channel exit parameter block will be preserved for its next invocation. Changes made to input/output fields (for example, the *ExitUserArea* field), are preserved for invocations of that instance of the exit only. Such changes cannot be used to pass data between different exits defined on the same channel, or between the same exit defined on different channels.

### Fields

*StrucId* (MQCHAR4)  
Structure identifier.

The value must be:

**MQCXP\_STRUC\_ID**  
Identifier for channel exit parameter structure.

## MQCXP

For the C programming language, the constant MQCXP\_STRUC\_ID\_ARRAY is also defined; this has the same value as MQCXP\_STRUC\_ID, but is an array of characters instead of a string.

This is an input field to the exit.

*Version* (MQLONG)

Structure version number.

The value depends on the environment:

### **MQCXP\_VERSION\_1**

Version-1 channel exit parameter structure.

The field has this value on OS/390 using CICS for distributed queuing.

### **MQCXP\_VERSION\_2**

Version-2 channel exit parameter structure.

The field has this value in the following environments: Compaq (DIGITAL) OpenVMS, Tandem NonStop Kernel, 16-bit Windows.

### **MQCXP\_VERSION\_3**

Version-3 channel exit parameter structure.

The field has this value in the following environments: UNIX systems not listed elsewhere, 32-bit Windows.

### **MQCXP\_VERSION\_4**

Version-4 channel exit parameter structure.

The field has this value in the following environments: AIX, HP-UX, OS/390 not using CICS for distributed queuing, OS/2, OS/400, Sun Solaris, Windows NT.

Fields that exist only in the earlier versions of the structure are identified as such in the field descriptions that follow. The following constant specifies the version number of the current version:

### **MQCXP\_CURRENT\_VERSION**

Current version of channel exit parameter structure.

The value of this constant depends on the environment (see above).

**Note:** When a new version of the MQCXP structure is introduced, the layout of the existing part is not changed. The exit should therefore check that the version number is equal to or greater than the lowest version which contains the fields that the exit needs to use.

This is an input field to the exit.

*ExitId* (MQLONG)

Type of exit.

This indicates the type of exit being called, and is set on entry to the exit routine. Possible values are:

### **MQXT\_CHANNEL\_SEC\_EXIT**

Channel security exit.

### **MQXT\_CHANNEL\_MSG\_EXIT**

Channel message exit.

**MQXT\_CHANNEL\_SEND\_EXIT**

Channel send exit.

**MQXT\_CHANNEL\_RCV\_EXIT**

Channel receive exit.

**MQXT\_CHANNEL\_MSG\_RETRY\_EXIT**

Channel message-retry exit.

This type of exit is not supported on OS/390, 16-bit Windows, and 32-bit Windows.

**MQXT\_CHANNEL\_AUTO\_DEF\_EXIT**

Channel auto-definition exit.

On OS/390, this type of exit is supported only for channels of type MQCHT\_CLUSSDR and MQCHT\_CLUSRCVR.

On 16-bit Windows and 32-bit Windows, this type of exit is not supported.

This is an input field to the exit.

*ExitReason* (MQLONG)

Reason for invoking exit.

This indicates the reason why the exit is being called, and is set on entry to the exit routine. It is not used by the auto-definition exit. Possible values are:

**MQXR\_INIT**

Exit initialization.

This indicates that the exit is being invoked for the first time. It allows the exit to acquire and initialize any resources that it may need (for example: main storage).

**MQXR\_TERM**

Exit termination.

This indicates that the exit is about to be terminated. The exit should free any resources that it may have acquired since it was initialized (for example: main storage).

**MQXR\_MSG**

Process a message.

This indicates that the exit is being invoked to process a message. This occurs for channel message exits only.

**MQXR\_XMIT**

Process a transmission.

This occurs for channel send and receive exits only.

**MQXR\_SEC\_MSG**

Security message received.

This occurs for channel security exits only.

**MQXR\_INIT\_SEC**

Initiate security exchange.

This occurs for channel security exits only.

The receiver's security exit is always invoked with this reason immediately after being invoked with MQXR\_INIT, to give it the

## MQCXP

opportunity to initiate a security exchange. If it declines the opportunity (by returning MQXCC\_OK instead of MQXCC\_SEND\_SEC\_MSG or MQXCC\_SEND\_AND\_REQUEST\_SEC\_MSG), the sender's security exit is invoked with MQXR\_INIT\_SEC.

If the receiver's security exit does initiate a security exchange (by returning MQXCC\_SEND\_SEC\_MSG or MQXCC\_SEND\_AND\_REQUEST\_SEC\_MSG), the sender's security exit is never invoked with MQXR\_INIT\_SEC; instead it is invoked with MQXR\_SEC\_MSG to process the receiver's message. (In either case it is first invoked with MQXR\_INIT.)

Unless one of the security exits requests termination of the channel (by setting *ExitResponse* to MQXCC\_SUPPRESS\_FUNCTION or MQXCC\_CLOSE\_CHANNEL), the security exchange must complete at the side that initiated the exchange. Therefore, if a security exit is invoked with MQXR\_INIT\_SEC and it does initiate an exchange, the next time the exit is invoked it will be with MQXR\_SEC\_MSG. This happens whether or not there is a security message for the exit to process. There will be a security message if the partner returns MQXCC\_SEND\_SEC\_MSG or MQXCC\_SEND\_AND\_REQUEST\_SEC\_MSG, but not if the partner returns MQXCC\_OK or there is no security exit at the partner. If there is no security message to process, the security exit at the initiating end is re-invoked with a *DataLength* of zero.

### **MQXR\_RETRY**

Retry a message.

This occurs for message-retry exits only.

On OS/390, this is not supported.

### **MQXR\_AUTO\_CLUSSDR**

Automatic definition of a cluster-sender channel.

This occurs for channel auto-definition exits only.

### **MQXR\_AUTO\_RECEIVER**

Automatic definition of a receiver channel.

This occurs for channel auto-definition exits only.

### **MQXR\_AUTO\_SVRCONN**

Automatic definition of a server-connection channel.

This occurs for channel auto-definition exits only.

### **MQXR\_AUTO\_CLUSRCVR**

Automatic definition of a cluster-receiver channel.

This occurs for channel auto-definition exits only.

### **Notes:**

1. If you have more than one exit defined for a channel, they will each be invoked with MQXR\_INIT when the MCA is initialized, and will each be invoked with MQXR\_TERM when the MCA is terminated.
2. For the channel auto-definition exit, *ExitReason* is not set if *Version* is less than MQCXP\_VERSION\_4. The value MQXR\_AUTO\_SVRCONN is implied in this case.



This is an input field to the exit.

*ExitResponse* (MQLONG)

Response from exit.

This is set by the exit to communicate with the MCA. It must be one of the following:

#### **MQXCC\_OK**

Continue normally.

- For the channel security exit, this indicates that message transfer should now proceed normally.
- For the channel message retry exit, this indicates that the MCA should wait for the time interval returned by the exit in the *MsgRetryInterval* field in MQCXP, and then retry the message.

The *ExitResponse2* field may contain additional information.

#### **MQXCC\_SUPPRESS\_FUNCTION**

Suppress function.

- For the channel security exit, this indicates that the channel should be terminated.
- For the channel message exit, this indicates that the message is not to proceed any further towards its destination. Instead the MCA generates an exception report message (if one was requested by the sender of the original message), and places the original message on the dead-letter queue (if the sender specified MQRO\_DEAD\_LETTER\_Q), or discards it (if the sender specified MQRO\_DISCARD\_MSG).

If the sender specified MQRO\_DEAD\_LETTER\_Q, but the put to the dead-letter queue fails, or there is no dead-letter queue, the original message is left on the transmission queue and the report message is not generated. The original message is also left on the transmission queue if the report message cannot be generated successfully.

The *Feedback* field in the MQDLH structure at the start of the message on the dead-letter queue indicates why the message was put on the dead-letter queue; this feedback code is also used in the message descriptor of the exception report message (if one was requested by the sender).

- For the channel message retry exit, this indicates that the MCA should not wait and retry the message; instead, the MCA continues immediately with its normal failure processing (the message is placed on the dead-letter queue or discarded, as specified by the sender of the message).
- For the channel auto-definition exit, either MQXCC\_OK or MQXCC\_SUPPRESS\_FUNCTION must be specified. If neither of these is specified, MQXCC\_SUPPRESS\_FUNCTION is assumed by default and the auto-definition is abandoned.

This response is not supported for the channel send and receive exits.

#### **MQXCC\_SEND\_SEC\_MSG**

Send security message.

This value can be set only by a channel security exit. It indicates that the exit has provided a security message which should be transmitted to the partner.

**MQXCC\_SEND\_AND\_REQUEST\_SEC\_MSG**

Send security message that requires a reply.

This value can be set only by a channel security exit. It indicates

- that the exit has provided a security message which should be transmitted to the partner, and
- that the exit requires a response from the partner. If no response is received, the channel must be terminated, because the exit has not yet decided whether communications can proceed.

This is not valid on OS/390 if you are using CICS for distributed queuing.

**MQXCC\_SUPPRESS\_EXIT**

Suppress exit.

- This value can be set by all types of channel exit other than a security exit or an auto-definition exit. It suppresses any further invocation of that exit (as if its name had been blank in the channel definition), until termination of the MCA, when the exit is again invoked with an *ExitReason* of MQXR\_TERM.
- If a message retry exit returns this value, message retries for subsequent messages are controlled by the *MsgRetryCount* and *MsgRetryInterval* channel attributes as normal. For the current message, the MCA performs the number of outstanding retries, at intervals given by the *MsgRetryInterval* channel attribute, but only if the reason code is one that the MCA would normally retry (see the *MsgRetryCount* field described in “MQCD - Channel data structure” on page 556). The number of outstanding retries is the value of the *MsgRetryCount* attribute, less the number of times the exit returned MQXCC\_OK for the current message; if this number is negative, no further retries are performed by the MCA for the current message.

This is not valid on OS/390 if you are using CICS for distributed queuing.

**MQXCC\_CLOSE\_CHANNEL**

Close channel.

This value can be set by any type of channel exit except an auto-definition exit. It causes the message channel agent (MCA) to close the channel.

This is not valid on OS/390 if you are using CICS for distributed queuing.

This is an input/output field from the exit.

*ExitResponse2* (MQLONG)

Secondary response from exit.

This is set to zero on entry to the exit routine. It can be set by the exit to provide further information to the MCA. It is not used by the auto-definition exit.

The exit can set one or more of the following. If more than one is required, the values are added together. Combinations that are not valid are noted; other combinations are allowed.

**MQXR2\_PUT\_WITH\_DEF\_ACTION**

Put with default action.

This is set by the receiver's channel message exit. It indicates that the message is to be put with the MCA's default action, that is either the MCA's default user ID, or the context *UserIdentifier* in the MQMD (message descriptor) of the message.

The value of this constant is zero, which corresponds to the initial value set when the exit is invoked. The constant is provided for documentation purposes.

**MQXR2\_PUT\_WITH\_DEF\_USERID**

Put with default user identifier.

This can only be set by the receiver's channel message exit. It indicates that the message is to be put with the MCA's default user identifier.

**MQXR2\_PUT\_WITH\_MSG\_USERID**

Put with message's user identifier.

This can only be set by the receiver's channel message exit. It indicates that the message is to be put with the context *UserIdentifier* in the MQMD (message descriptor) of the message (this may have been modified by the exit).

Only one of MQXR2\_PUT\_WITH\_DEF\_ACTION, MQXR2\_PUT\_WITH\_DEF\_USERID, and MQXR2\_PUT\_WITH\_MSG\_USERID should be set.

**MQXR2\_USE\_AGENT\_BUFFER**

Use agent buffer.

This indicates that any data to be passed on is in *AgentBuffer*, not *ExitBufferAddr*.

The value of this constant is zero, which corresponds to the initial value set when the exit is invoked. The constant is provided for documentation purposes.

**MQXR2\_USE\_EXIT\_BUFFER**

Use exit buffer.

This indicates that any data to be passed on is in *ExitBufferAddr*, not *AgentBuffer*.

Only one of MQXR2\_USE\_AGENT\_BUFFER and MQXR2\_USE\_EXIT\_BUFFER should be set.

**MQXR2\_DEFAULT\_CONTINUATION**

Exit continuation criteria.

Continuation with the next exit in the chain depends on the response from the last exit invoked:

- If MQXCC\_SUPPRESS\_FUNCTION or MQXCC\_CLOSE\_CHANNEL are returned, no further exits in the chain are called.
- Otherwise, the next exit in the chain is invoked.

On OS/390, this is not supported.

**MQXR2\_CONTINUE\_CHAIN**

Continue with the next exit.

## MQCXP

On OS/390, this is not supported.

### **MQXR2\_SUPPRESS\_CHAIN**

No further exits are invoked.

On OS/390, this is not supported.

This is an input/output field from the exit.

*Feedback* (MQLONG)

Feedback code.

This is set to zero on entry to the exit routine.

If a channel message exit sets the *ExitResponse* field to MQXCC\_SUPPRESS\_FUNCTION, the *Feedback* field specifies the feedback code that identifies why the message was put on the dead-letter (undelivered-message) queue, and is also used to send an exception report if one has been requested. If the *Feedback* field is zero in this case, the following feedback code is used:

### **MQFB\_STOPPED\_BY\_MSG\_EXIT**

Message stopped by channel message exit.

The value returned in this field by channel security, send, receive, and message-retry exits is not used by the MCA.

The value returned in this field by auto-definition exits is not used if *ExitResponse* is MQXCC\_OK, but otherwise is used for the *AuxErrorDataInt1* parameter in the event message.

This is an input/output field from the exit.

*MaxSegmentLength* (MQLONG)

Maximum segment length.

This is the maximum length in bytes that can be sent in a single transmission. It is not used by the auto-definition exit. It is of interest to a channel send exit, because this exit must ensure that it does not increase the size of a transmission segment to a value greater than *MaxSegmentLength*. The length includes the initial 8 bytes that the exit must not change. The value is negotiated between the message channel agents when the channel is initiated. See “Writing and compiling channel-exit programs” on page 518 for more information about segment lengths.

The value in this field is not meaningful if *ExitReason* is MQXR\_INIT.

This is an input field to the exit.

*ExitUserArea* (MQBYTE16)

Exit user area.

This is a field that is available for the exit to use. (It is not used by the auto-definition exit.) It is initialized to binary zero before the first invocation of the exit (which has an *ExitReason* set to MQXR\_INIT), and thereafter any changes made to this field by the exit are preserved across invocations of the exit.

The following value is defined:

**MQXUA\_NONE**

No user information.

The value is binary zero for the length of the field.

For the C programming language, the constant `MQXUA_NONE_ARRAY` is also defined; this has the same value as `MQXUA_NONE`, but is an array of characters instead of a string.

The length of this field is given by `MQ_EXIT_USER_AREA_LENGTH`. This is an input/output field to the exit.

*ExitData* (MQCHAR32)

Exit data.

This is set on entry to the exit routine to information that the MCA took from the channel definition. If no such information is available, this field is all blanks.

The length of this field is given by `MQ_EXIT_DATA_LENGTH`.

This is an input field to the exit.

The following fields in this structure are not present if *Version* is less than `MQCXP_VERSION_2`.

*MsgRetryCount* (MQLONG)

Number of times the message has been retried.

The first time the exit is invoked for a particular message, this field has the value zero (no retries yet attempted). On each subsequent invocation of the exit for that message, the value is incremented by one by the MCA. On OS/390, the value is always zero.

This is an input field to the exit. The value in this field is not meaningful if *ExitReason* is `MQXR_INIT`. The field is not present if *Version* is less than `MQCXP_VERSION_2`.

*MsgRetryInterval* (MQLONG)

Minimum interval in milliseconds after which the put operation should be retried.

The first time the exit is invoked for a particular message, this field contains the value of the *MsgRetryInterval* channel attribute. The exit can leave the value unchanged, or modify it to specify a different time interval in milliseconds. If the exit returns `MQXCC_OK` in *ExitResponse*, the MCA will wait for at least this time interval before retrying the `MQOPEN` or `MQPUT` operation. The time interval specified must be zero or greater.

The second and subsequent times the exit is invoked for that message, this field contains the value returned by the previous invocation of the exit.

If the value returned in the *MsgRetryInterval* field is less than zero or greater than 999 999 999, and *ExitResponse* is `MQXCC_OK`, the MCA ignores the *MsgRetryInterval* field in `MQCXP` and waits instead for the interval specified by the *MsgRetryInterval* channel attribute. On OS/390, the value of this field is always zero.

## MQCXP

This is an input/output field to the exit. The value in this field is not meaningful if *ExitReason* is MQXR\_INIT. The field is not present if *Version* is less than MQCXP\_VERSION\_2.

*MsgRetryReason* (MQLONG)

Reason code from previous attempt to put the message.

This is the reason code from the previous attempt to put the message; it is one of the MQRC\_\* values. On OS/390 the value of this field is always zero.

This is an input field to the exit. The value in this field is not meaningful if *ExitReason* is MQXR\_INIT. The field is not present if *Version* is less than MQCXP\_VERSION\_2.

The following fields in this structure are not present if *Version* is less than MQCXP\_VERSION\_3.

*HeaderLength* (MQLONG)

Length of header information.

This field is relevant only for a message exit. The value is the length of the routing header structures at the start of the message data; these are the MQXQH structure, and (for a distribution-list message) the MQDH structure and arrays of MQOR and MQPMR records that follow the MQXQH structure.

The message exit can examine this header information, and modify it if necessary, but the data that the exit returns must still be in the correct format. The exit must not, for example, encrypt or compress the header data at the sending end, even if the message exit at the receiving end makes compensating changes.

If the message exit modifies the header information in such a way as to change its length (for example, by adding another destination to a distribution-list message), it must change the value of *HeaderLength* correspondingly before returning.

This is an input/output field to the exit. The value in this field is not meaningful if *ExitReason* is MQXR\_INIT. The field is not present if *Version* is less than MQCXP\_VERSION\_3.

*PartnerName* (MQCHAR48)

Partner Name.

The name of the partner, as follows:

- For SVRCONN channels, it is the logged-on user ID at the client.
- For all other types of channel, it is the queue-manager name of the partner.

When the exit is initialized this field is blank because the queue manager does not know the name of the partner until after initial negotiation has taken place.

This is an input field to the exit. The field is not present if *Version* is less than MQCXP\_VERSION\_3.

*FAPLevel* (MQLONG)

Negotiated Formats and Protocols level.

This is an input field to the exit. The field is not present if *Version* is less than MQCXP\_VERSION\_3.

*CapabilityFlags* (MQLONG)  
Capability flags.

The following are defined:

**MQCF\_NONE**  
No flags.

**MQCF\_DIST\_LISTS**  
Distribution lists supported.

This is an input field to the exit. The field is not present if *Version* is less than MQCXP\_VERSION\_3.

*ExitNumber* (MQLONG)  
Exit number.

The ordinal number of the exit, within the type defined in *ExitId*. For example, if the exit being invoked is the third message exit defined, this field contains the value 3. If the exit type is one for which a list of exits cannot be defined (for example, a security exit), this field has the value 1.

This is an input field to the exit. The field is not present if *Version* is less than MQCXP\_VERSION\_3.

## C declaration

```
typedef struct tagMQCXP {
    MQCHAR4   StrucId;           /* Structure identifier */
    MQLONG    Version;          /* Structure version number */
    MQLONG    ExitId;           /* Type of exit */
    MQLONG    ExitReason;       /* Reason for invoking exit */
    MQLONG    ExitResponse;     /* Response from exit */
    MQLONG    ExitResponse2;    /* Secondary response from exit */
    MQLONG    Feedback;         /* Feedback code */
    MQLONG    MaxSegmentLength; /* Maximum segment length */
    MQBYTE16  ExitUserArea;     /* Exit user area */
    MQCHAR32  ExitData;         /* Exit data */
    MQLONG    MsgRetryCount;    /* Number of times the message has been
                                retried */
    MQLONG    MsgRetryInterval; /* Minimum interval in milliseconds after
                                which the put operation should be
                                retried */
    MQLONG    MsgRetryReason;   /* Reason code from previous attempt to
                                put the message */
    MQLONG    HeaderLength;     /* Length of header information */
    MQCHAR48  PartnerName;     /* Partner Name */
    MQLONG    FAPLevel;         /* Negotiated Formats and Protocols
                                level */
    MQLONG    CapabilityFlags;  /* Capability flags */
    MQLONG    ExitNumber;       /* Exit number */
} MQCXP;
```

## COBOL declaration

```
** MQCXP structure
10 MQCXP.
** Structure identifier
15 MQCXP-STRUCID          PIC X(4).
** Structure version number
15 MQCXP-VERSION         PIC S9(9) BINARY.
```

## MQCXP

```
**   Type of exit
15  MQCXP-EXITID          PIC S9(9) BINARY.
**   Reason for invoking exit
15  MQCXP-EXITREASON     PIC S9(9) BINARY.
**   Response from exit
15  MQCXP-EXITRESPONSE   PIC S9(9) BINARY.
**   Secondary response from exit
15  MQCXP-EXITRESPONSE2 PIC S9(9) BINARY.
**   Feedback code
15  MQCXP-FEEDBACK       PIC S9(9) BINARY.
**   Maximum segment length
15  MQCXP-MAXSEGMENTLENGTH PIC S9(9) BINARY.
**   Exit user area
15  MQCXP-EXITUSERAREA   PIC X(16).
**   Exit data
15  MQCXP-EXITDATA       PIC X(32).
**   Number of times the message has been retried
15  MQCXP-MSGRETRYCOUNT PIC S9(9) BINARY.
**   Minimum interval in milliseconds after which the put
**   operation should be retried
15  MQCXP-MSGRETRYINTERVAL PIC S9(9) BINARY.
**   Reason code from previous attempt to put the message
15  MQCXP-MSGRETRYREASON PIC S9(9) BINARY.
**   Length of header information
15  MQCXP-HEADERLENGTH   PIC S9(9) BINARY.
**   Partner Name
15  MQCXP-PARTNERNAME    PIC X(48).
**   Negotiated Formats and Protocols level
15  MQCXP-FAPLEVEL       PIC S9(9) BINARY.
**   Capability flags
15  MQCXP-CAPABILITYFLAGS PIC S9(9) BINARY.
**   Exit number
15  MQCXP-EXITNUMBER     PIC S9(9) BINARY.
```

## PL/I declaration

```
dc1
1 MQCXP based,
3 StrucId          char(4),          /* Structure identifier */
3 Version          fixed bin(31),    /* Structure version number */
3 ExitId           fixed bin(31),    /* Type of exit */
3 ExitReason       fixed bin(31),    /* Reason for invoking exit */
3 ExitResponse     fixed bin(31),    /* Response from exit */
3 ExitResponse2    fixed bin(31),    /* Secondary response from exit */
3 Feedback         fixed bin(31),    /* Feedback code */
3 MaxSegmentLength fixed bin(31),    /* Maximum segment length */
3 ExitUserArea     char(16),         /* Exit user area */
3 ExitData         char(32),         /* Exit data */
3 MsgRetryCount    fixed bin(31),    /* Number of times the message has
                                     been retried */
3 MsgRetryInterval fixed bin(31),    /* Minimum interval in milliseconds
                                     after which the put operation
                                     should be retried */
3 MsgRetryReason   fixed bin(31),    /* Reason code from previous attempt
                                     to put the message */
3 HeaderLength     fixed bin(31),    /* Length of header information */
3 PartnerName      char(48),         /* Partner Name */
3 FAPLevel         fixed bin(31),    /* Negotiated Formats and Protocols
                                     level */
3 CapabilityFlags   fixed bin(31),    /* Capability flags */
3 ExitNumber       fixed bin(31);    /* Exit number */
```

## ILE RPG declaration

```
D*..1.....2.....3.....4.....5.....6.....7..
D* MQCXP Structure
D*
```



```

D* Structure identifier
D CXSID          1      4
D* Structure version number
D CXVER         5      8I 0
D* Type of exit
D CXXID         9      12I 0
D* Reason for invoking exit
D CXREA        13      16I 0
D* Response from exit
D CXRES        17      20I 0
D* Secondary response from exit
D CXRE2        21      24I 0
D* Feedback code
D CXFB         25      28I 0
D* Maximum segment length
D CXMSL        29      32I 0
D* Exit user area
D CXUA         33      48
D* Exit data
D CXDAT        49      80
D* Number of times the message has been retried
D CXMRC        81      84I 0
D* Minimum interval in milliseconds after which the put operation
D* should be retried
D CXMRI        85      88I 0
D* Reason code from previous attempt to put the message
D CXMRR        89      92I 0
D* Length of header information
D CXHDL        93      96I 0
D* Partner Name
D CXPNM        97      144
D* Negotiated Formats and Protocols level
D CXFAP       145      148I 0
D* Capability flags
D CXCAP       149      152I 0
D* Exit number
D CXEXN       153      156I 0

```

## OPM RPG declaration

```

I*..1.....2.....3.....4.....5.....6.....7..
I* MQCXP Structure
I*
I* Structure identifier
I          1      4 CXSID
I* Structure version number
I          B 5    80CXVER
I* Type of exit
I          B 9    120CXXID
I* Reason for invoking exit
I          B 13   160CXREA
I* Response from exit
I          B 17   200CXRES
I* Secondary response from exit
I          B 21   240CXRE2
I* Feedback code
I          B 25   280CXFB
I* Maximum segment length
I          B 29   320CXMSL
I* Exit user area
I          33    48 CXUA
I* Exit data
I          49    80 CXDAT
I* Number of times the message has been retried
I          B 81   840CXMRC
I* Minimum interval in milliseconds after which the put operation
I* should be retried

```

## MQCXP

```

I                                     B 85 880CXMRI
I* Reason code from previous attempt to put the message
I                                     B 89 920CXMRR
I* Length of header information
I                                     B 93 960CXHDL
I* Partner Name
I                                     97 144 CXPNM
I* Negotiated Formats and Protocols level
I                                     B 145 1480CXFAP
I* Capability flags
I                                     B 149 1520CXCAP
I* Exit number
I                                     B 153 1560CXEXN

```

## System/390 assembler declaration

```

MQCXP                                DSECT
MQCXP_STRUCID                        DS CL4      Structure identifier
MQCXP_VERSION                        DS F       Structure version number
MQCXP_EXITID                         DS F       Type of exit
MQCXP_EXITREASON                     DS F       Reason for invoking exit
MQCXP_EXITRESPONSE                   DS F       Response from exit
MQCXP_EXITRESPONSE2                  DS F       Secondary response from exit
MQCXP_FEEDBACK                       DS F       Feedback code
MQCXP_MAXSEGMENTLENGTH               DS F       Maximum segment length
MQCXP_EXITUSERAREA                   DS XL16    Exit user area
MQCXP_EXITDATA                       DS CL32    Exit data
MQCXP_MSGRETRYCOUNT                 DS F       Number of times the message
*                                     has been retried
MQCXP_MSGRETRYINTERVAL               DS F       Minimum interval in
*                                     milliseconds after which the
*                                     put operation should be
*                                     retried
MQCXP_MSGRETRYREASON                 DS F       Reason code from previous
*                                     attempt to put the message
MQCXP_HEADERLENGTH                   DS F       Length of header information
MQCXP_PARTNERNAME                     DS CL48    Partner Name
MQCXP_FAPLEVEL                       DS F       Negotiated Formats and
*                                     Protocols level
MQCXP_CAPABILITYFLAGS                 DS F       Capability flags
MQCXP_EXITNUMBER                      DS F       Exit number
MQCXP_LENGTH                          EQU *-MQCXP Length of structure
ORG MQCXP
MQCXP_AREA                            DS CL(MQCXP_LENGTH)

```

## MQTXP - Transport-exit data structure

The following table summarizes the fields in the structure.

Table 50. Fields in MQTXP

Field	Description	Page
<i>StrucId</i>	Structure identifier	605
<i>Version</i>	Structure version number	605
<i>ExitReason</i>	Reason for invoking exit	606
<i>ExitUserArea</i>	Exit user area	606
<i>TransportType</i>	Transport type	606
<i>RetryCount</i>	Number of times data has been retried	607
<i>DataLength</i>	Length of data to be sent	607
<i>SessionId</i>	Session identifier	607
<i>GroupId</i>	Group identifier	607
<i>DataId</i>	Data identifier	607
<i>ExitResponse</i>	Response from exit	607

The MQTXP structure describes the information that is passed to the transport retry exit.

This structure is supported in the following environments: AIX and 16-bit Windows.

### Fields

*StrucId* (MQCHAR4)  
Structure identifier.

The value is:

**MQTXP\_STRUC\_ID**

Identifier for transport retry exit parameter structure.

For the C programming language, the constant MQTXP\_STRUC\_ID\_ARRAY is also defined; this has the same value as MQTXP\_STRUC\_ID, but is an array of characters instead of a string.

This is an input field to the exit.

*Version* (MQLONG)  
Structure version number.

The value is:

**MQTXP\_VERSION\_1**

Version-1 transport retry exit parameter structure.

The following constant specifies the version number of the current version:

**MQTXP\_CURRENT\_VERSION**

Current version of transport retry exit parameter structure.

This is an input field to the exit.

## MQTXP

*Reserved* (MQLONG)

Reserved.

This is a reserved field. The value is zero.

*ExitReason* (MQLONG)

Reason for invoking exit.

This indicates the reason why the exit is being called. Possible values are:

### **MQXR\_INIT**

Exit initialization.

This indicates that the exit is being invoked for the first time. It allows the exit to acquire and initialize any resources that it may need (for example: main storage).

### **MQXR\_TERM**

Exit termination.

This indicates that the exit is about to be terminated. The exit should free any resources that it may have acquired since it was initialized (for example: main storage).

### **MQXR\_RETRY**

Retry a message.

### **MQXR\_END\_BATCH**

Called from MCA when batch completed.

### **MQXR\_ACK\_RECEIVED**

Called from MCA when an acknowledgement has been received.

This is an input field to the exit.

*ExitUserArea* (MQBYTE16)

Exit user area.

This is a field that is available for the exit to use. It is initialized to MQXUA\_NONE (binary zero) before the first invocation of the exit, and thereafter any changes made to this field by the exit are preserved across invocations of the exit. The first invocation of the exit has *ExitReason* set to MQXR\_INIT.

The following value is defined:

### **MQXUA\_NONE**

No user information.

The value is binary zero for the length of the field.

For the C programming language, the constant MQXUA\_NONE\_ARRAY is also defined; this has the same value as MQXUA\_NONE, but is an array of characters instead of a string.

The length of this field is given by MQ\_EXIT\_USER\_AREA\_LENGTH. This is an input/output field to the exit.

*TransportType* (MQLONG)

Transport type.

This is the type of transport being used. The value is:

**MQXPT\_UDP**

UDP transport protocol.

This is an input field to the exit.

*RetryCount* (MQLONG)

Number of times data has been retried.

This is the number of previous attempts that have been made to send the current data. It is zero on first invocation of the exit for the current data.

This is an input field to the exit.

*DataLength* (MQLONG)

Length of data to be sent.

This is always greater than zero. For MQXPT\_UDP, it is one complete encoded datagram.

This is an input field to the exit.

*SessionId* (MQLONG)

Session identifier.

This is the identifier of the session of channel. For MQXPT\_UDP, it is the `UdpHandle`.

This is an input field to the exit.

*GroupId* (MQLONG)

Group identifier.

This is the identifier of the group, bunch, or message to which the data belongs. For MQXPT\_UDP, it identifies the bunch.

This is an input field to the exit.

*DataId* (MQLONG)

Data identifier.

For MQXPT\_UDP, this is the datagram identifier.

This is an input field to the exit.

*ExitResponse* (MQLONG)

Response from exit.

This is set by the exit to indicate how processing should continue. It must be one of the following:

**MQXCC\_OK**

Continue normally.

This indicates that processing should continue normally.

**MQXCC\_REQUEST\_ACK**

Request acknowledgement.

This indicates that processing should continue normally, but that the datagram about to be sent should request that an acknowledgement be returned by the receiver of the datagram.

## MQTXP

### MQXCC\_CLOSE\_CHANNEL

Close channel.

This indicates that processing should be discontinued and the channel closed.

If any other value is returned by the exit, processing continues as if MQXCC\_CLOSE\_CHANNEL had been specified.

This is an output field from the exit.

*Feedback* (MQLONG)

Reserved.

This is a reserved field. The value is zero.

## C declaration

```
typedef struct tagMQTXP {
    MQCHAR4   StrucId;        /* Structure identifier */
    MQLONG    Version;       /* Structure version number */
    MQLONG    Reserved;     /* Reserved */
    MQLONG    ExitReason;    /* Reason for invoking exit */
    MQBYTE16  ExitUserArea;  /* Exit user area */
    MQLONG    TransportType; /* Transport type */
    MQLONG    RetryCount;    /* Number of times data has been retried */
    MQLONG    DataLength;    /* Length of data to be sent */
    MQLONG    SessionId;     /* Session identifier */
    MQLONG    GroupId;       /* Group identifier */
    MQLONG    DataId;        /* Data identifier */
    MQLONG    ExitResponse;  /* Response from exit */
    MQLONG    Feedback;     /* Reserved */
} MQTXP;
```

## MQXWD - Exit wait descriptor structure

The following table summarizes the fields in the structure.

Table 51. Fields in MQXWD

Field	Description	Page
<i>StrucId</i>	Structure identifier	609
<i>Version</i>	Structure version number	609
<i>ECB</i>	Event control block to wait on	610

The MQXWD structure is an input/output parameter on the MQXWAIT call.

This structure is supported only on OS/390.

### Fields

*StrucId* (MQCHAR4)  
Structure identifier.

The value must be:

#### **MQXWD\_STRUC\_ID**

Identifier for exit wait descriptor structure.

For the C programming language, the constant MQXWD\_STRUC\_ID\_ARRAY is also defined; this has the same value as MQXWD\_STRUC\_ID, but is an array of characters instead of a string.

The initial value of this field is MQXWD\_STRUC\_ID.

*Version* (MQLONG)  
Structure version number.

The value must be:

#### **MQXWD\_VERSION\_1**

Version number for exit wait descriptor structure.

The initial value of this field is MQXWD\_VERSION\_1.

*Reserved1* (MQLONG)  
Reserved.

This is a reserved field; its value must be zero.

This is an input field.

*Reserved2* (MQLONG)  
Reserved.

This is a reserved field; its value must be zero.

This is an input field.

*Reserved3* (MQLONG)  
Reserved.

## MQXWD

This is a reserved field; its value must be zero.

This is an input field.

*ECB (MQLONG)*

Event control block to wait on.

This is the event control block (ECB) to wait on. It should be set to zero before the MQXWAIT call is issued; on successful completion it will contain the post code.

This is an input/output field.

## C declaration

```
typedef struct tagMQXWD {
    MQCHAR4  StrucId;    /* Structure identifier */
    MQLONG   Version;   /* Structure version number */
    MQLONG   Reserved1; /* Reserved */
    MQLONG   Reserved2; /* Reserved */
    MQLONG   Reserved3; /* Reserved */
    MQLONG   ECB;       /* Event control block to wait on */
} MQXWD;
```

## System/390 assembler declaration

MQXWD	DSECT	
MQXWD_STRUCID	DS CL4	Structure identifier
MQXWD_VERSION	DS F	Structure version number
MQXWD_RESERVED1	DS F	Reserved
MQXWD_RESERVED2	DS F	Reserved
MQXWD_RESERVED3	DS F	Reserved
MQXWD_ECB	DS F	Event control block to wait on
*		
MQXWD_LENGTH	EQU *-MQXWD	Length of structure
	ORG MQXWD	
MQXWD_AREA	DS CL(MQXWD_LENGTH)	



---

## Chapter 38. Problem determination in DQM

This chapter explains the various aspects of problem determination and suggests methods of resolving problems. Some of the problems mentioned in this chapter are platform and installation specific. Where this is the case, it is made clear in the text.

Problem determination for the following scenarios is discussed:

- “Error message from channel control”
- “Ping”
- “Dead-letter queue considerations” on page 612
- “Validation checks” on page 612
- “In-doubt relationship” on page 613
- “Channel startup negotiation errors” on page 613
- “When a channel refuses to run” on page 613
- “Retrying the link” on page 615
- “Data structures” on page 616
- “User exit problems” on page 616
- “Disaster recovery” on page 616
- “Channel switching” on page 617
- “Connection switching” on page 617
- “Client problems” on page 617
- “Error logs” on page 618

---

### Error message from channel control

Problems found during normal operation of the channels are reported to the system console and to the system log. In MQSeries for OS/390 using CICS, they are reported to the CICS *Transient Data Queue* CKMQ, if that is defined and available. In MQSeries for Windows they are reported to the channel log. Problem diagnosis starts with the collection of all relevant information from the log, and analysis of this information to identify the problem.

However, this could be difficult in a network where the problem may arise at an intermediate system that is staging some of your messages. An error situation, such as transmission queue full, followed by the dead-letter queue filling up, would result in your channel to that site closing down.

In this example, the error message you receive in your error log will indicate a problem originating from the remote site, but may not be able to tell you any details about the error at that site.

You need to contact your counterpart at the remote site to obtain details of the problem, and to receive notification of that channel becoming available again.

---

### Ping

Ping, which is not supported on MQSeries for Windows, is useful in determining whether the communication link and the two message channel agents that make up a message channel are functioning across all interfaces.

Ping makes no use of transmission queues, but it does invoke some user exit programs. If any error conditions are encountered, error messages are issued.

## Ping

To use ping, you can issue the MQSC command PING CHANNEL (you cannot do this if you are using CICS for distributed queuing on OS/390). On OS/390 and OS/400, you can also use the panel interface to select this option.

On UNIX platforms, OS/2, Windows NT, and OS/400, you can also use the MQSC command PING QMGR to test whether the queue manager is responsive to commands. See the *MQSeries Command Reference* book for more information about this.

---

## Dead-letter queue considerations

In some MQSeries products the dead-letter queue is referred to as an *undelivered-message queue*. There are no dead-letter queues in MQSeries for Windows.

If a channel ceases to run for any reason, applications will probably continue to place messages on transmission queues, creating a potential overflow situation. Applications can monitor transmission queues to find the number of messages waiting to be sent, but this would not be a normal function for them to carry out.

When this occurs in a message-originating node, and the local transmission queue is full, the application's PUT fails.

When this occurs in a staging or destination node, there are three ways that the MCA copes with the situation:

1. By calling the message-retry exit, if one is defined.
2. By directing all overflow messages to a *dead-letter queue* (DLQ), returning an exception report to applications that requested these reports.

**Note:** In distributed-queuing management, if the message is too big for the DLQ, the DLQ is full, or the DLQ is not available, the channel stops and the message remains on the transmission queue. Ensure your DLQ is defined, available, and sized for the largest messages you handle.

3. By closing down the channel, if neither of the previous options succeeded.
4. By returning the undelivered messages back to the sending end and returning a full report to the reply-to queue (MQRC\_EXCEPTION\_WITH\_FULL\_DATA and MQRO\_DISCARD\_MSG).

If an MCA is unable to put a message on the DLQ:

- The channel stops
- Appropriate error messages are issued at the system consoles at both ends of the message channel
- The unit of work is backed out, and the messages reappear on the transmission queue at the sending channel end of the channel
- Triggering is disabled for the transmission queue

---

## Validation checks

A number of validation checks are made when creating, altering, and deleting channels, and where appropriate, an error message returned.

Errors may occur when:

- A duplicate channel name is chosen when creating a channel
- Unacceptable data is entered in the channel parameter fields

- The channel to be altered is in doubt, or does not exist

---

## In-doubt relationship

If a channel is in doubt, it is usually resolved automatically on restart, so the system operator does not need to resolve a channel manually in normal circumstances. See “In-doubt channels” on page 69 for information about this.

---

## Channel startup negotiation errors

During channel startup, the starting end has to state its position and agree channel running parameters with the corresponding channel. It may happen that the two ends cannot agree on the parameters, in which case the channel closes down with error messages being issued to the appropriate error logs.

---

## When a channel refuses to run

If a channel refuses to run:

- Check that DQM and the channels have been set up correctly. This is a likely problem source if the channel has never run. Reasons could be:
  - A mismatch of names between sending and receiving channels (remember that uppercase and lowercase letters are significant)
  - Incorrect channel types specified
  - The sequence number queue (if applicable) is not available, or is damaged
  - The dead-letter queue is not available
  - The sequence number wrap value is different on the two channel definitions
  - A queue manager, CICS system, or communication link is not available
  - Following a restart, the wrong queue manager may have been attached to CICS
  - A receiver channel might be in STOPPED state
  - The connection might not be defined correctly
  - There might be a problem with the communications software (for example, is TCP running?)
  - In OS/390 using CICS, check that the DFHSIT SYSIDNT name of the target CICS system matches the connection name that you have specified for that system
- It is possible that an in-doubt situation exists, if the automatic synchronization on startup has failed for some reason. This is indicated by messages on the system console, and the status panel may be used to show channels that are in doubt.

The possible responses to this situation are:

- Issue a Resolve channel request with Backout or Commit.

You need to check with your remote link supervisor to establish the number of the last message or unit of work committed. Check this against the last number at your end of the link. If the remote end has committed a number, and that number is not yet committed at your end of the link, then issue a RESOLVE COMMIT command.

In all other cases, issue a RESOLVE BACKOUT command.

The effect of these commands is that backed out messages reappear on the transmission queue and are sent again, while committed messages are discarded.

## Channel refuses to run

If in doubt yourself, perhaps backing out with the probability of duplicating a sent message would be the safer decision.

- Issue a RESET command.

This command is for use when sequential numbering is in effect, and should be used with care. Its purpose is to reset the sequence number of messages and you should use it only after using the RESOLVE command to resolve any in-doubt situations.

- On MQSeries for AS/400, OS/2, Windows NT, UNIX systems, and OS/390 without CICS, there is no need for the administrator to choose a particular sequence number to ensure that the sequence numbers are put back in step. When a sender channel starts up after being reset, it informs the receiver that it has been reset and supplies the new sequence number that is to be used by both the sender and receiver.

**Note:** If the sender is MQSeries for OS/390 using CICS, the sequence number should be reset to the same number as any receiving queue managers.

- If the status of a receiver end of the channel is STOPPED, it can be reset by starting the receiver end.

**Note:** This does not start the channel, it merely resets the status. The channel must still be started from the sender end.

## Triggered channels

If a triggered channel refuses to run, the possibility of in-doubt messages should be investigated as described above.

Another possibility is that the trigger control parameter on the transmission queue has been set to NOTTRIGGER by the channel. This happens when:

- There is a channel error
- The channel was stopped because of a request from the receiver
- The channel was stopped because of a problem on the sender that requires manual intervention

After diagnosing and fixing the problem, you must reset the trigger control parameter to TRIGGER.

An example of a situation where a triggered channel fails to start is as follows:

1. A transmission queue is defined with a trigger type of FIRST.
2. A message arrives on the transmission queue, and a trigger message is produced.
3. The channel is started, but stops immediately because the communications to the remote system are not available.
4. The remote system is made available.
5. Another message arrives on the transmission queue.
6. The second message does not increase the queue depth from zero to one, so no trigger message is produced (unless the channel is in RETRY state). If this happens, the channel must be started manually.

On MQSeries for OS/390, if the queue manager is stopped using MODE(FORCE) during channel initiator shutdown, it may be necessary to manually restart some channels after channel initiator restart.

Because the second message does not cause the queue depth to go from zero to one, no trigger message is produced (unless the channel is in RETRY state). If this happens, the channel must be started manually.

### Conversion failure

Another reason for the channel refusing to run could be that neither end is able to carry out necessary conversion of message descriptor data between ASCII and EBCDIC, and integer formats. In this instance, communication is not possible.

### Network problems

When using LU 6.2, make sure that your definitions are consistent throughout the network. For example, if you have increased the RU sizes in your CICS Transaction Server for OS/390 or Communications Manager definitions, but you have a controller with a small MAXDATA value in its definition, the session may fail if you attempt to send large messages across the network. A symptom of this may be that channel negotiation takes place successfully, but the link fails when message transfer occurs.

When using TCP, if your channels are unreliable and your connections breaking, use the SO\_KEEPALIVE option, as discussed in “Checking that the other end of the channel is still available” on page 66.

### Dial-up problems

MQSeries supports connection over dial-up lines but you should be aware that with TCP, some protocol providers assign a new IP address each time you dial in. This can cause channel synchronization problems because the channel cannot recognize the new IP addresses and so cannot ensure the authenticity of the partner. If you encounter this problem, you need to use a security exit program to override the connection name for the session.

This problem does not occur when a V5.1 of MQSeries for AIX, AS/400, HP-UX, OS/2 Warp, Sun Solaris, and Windows NT product is communicating with another product at the same level, because the queue manager name is used for synchronization instead of the IP address.

---

## Retrying the link

An error scenario may occur that is difficult to recognize. For example, the link and channel may be functioning perfectly, but some occurrence at the receiving end causes the receiver to stop. Another unforeseen situation could be that the receiver system has run out of storage and is unable to complete a transaction.

You need to be aware that such situations can arise, often characterized by a system that appears to be busy but is not actually moving messages. You need to work with your counterpart at the far end of the link to help detect the problem and correct it.

### Retry considerations

If a link failure occurs during normal operation, a sender or server channel program will itself start another instance, provided that:

1. Initial data negotiation and security exchanges are complete
2. The retry count in the channel definition is greater than zero

## Retrying the link

**Note:** For OS/2, OS/400, UNIX systems, and Windows NT, to attempt a retry a channel initiator must be running. In platforms other than V5.1 of MQSeries for AIX, AS/400, HP-UX, OS/2 Warp, Sun Solaris, and Windows NT, this channel initiator must be monitoring the initiation queue specified in the transmission queue that the channel is using. There is no channel initiator in MQSeries for Windows.

---

## Data structures

Data structures are needed for reference when checking logs and trace entries during problem diagnosis. Details can be found in “Chapter 37. Channel-exit calls and data structures” on page 543 and in the *MQSeries Application Programming Reference* book.

---

## User exit problems

The interaction between the channel programs and the user-exit programs has some error-checking routines, but this facility can only work successfully when the user exits obey the rules described in “Part 7. Further intercommunication considerations” on page 503. When errors occur, the most likely outcome will be that the channel stops and the channel program issues an error message, together with any return codes from the user exit. Any errors detected on the user exit side of the interface can be determined by scanning the messages created by the user exit itself.

You might need to use a trace facility of your host system to identify the problem.

---

## Disaster recovery

Disaster recovery planning is the responsibility of individual installations, and the functions performed may include the provision of regular system ‘snapshot’ dumps that are stored safely off-site. These dumps would be available for regenerating the system, should some disaster overtake it. If this occurs, you need to know what to expect of the messages, and the following description is intended to start you thinking about it.

First a recap on system restart. If a system fails for any reason, it may have a system log that allows the applications running at the time of failure to be regenerated by replaying the system software from a syncpoint forward to the instant of failure. If this occurs without error, the worst that can happen is that message channel syncpoints to the adjacent system may fail on startup, and that the last batches of messages for the various channels will be sent again. Persistent messages will be recovered and sent again, nonpersistent messages may be lost.

If the system has no system log for recovery, or if the system recovery fails, or where the disaster recovery procedure is invoked, the channels and transmission queues may be recovered to an earlier state, and the messages held on local queues at the sending and receiving end of channels may be inconsistent.

Messages may have been lost that were put on local queues. The consequence of this happening depends on the particular MQSeries implementation, and the channel attributes. For example, where strict message sequencing is in force, the receiving channel detects a sequence number gap, and the channel closes down for manual intervention. Recovery then depends upon application design, as in the worst case the sending application may need to restart from an earlier message sequence number.

---

## Channel switching

A possible solution to the problem of a channel ceasing to run would be to have two message channels defined for the same transmission queue, but with different communication links. One message channel would be preferred, the other would be a replacement for use when the preferred channel is unavailable.

If triggering is required for these message channels, the associated process definitions must exist for each sender channel end.

To switch message channels:

- If the channel is triggered, set the transmission queue attribute NOTRIGGER.
- Ensure the current channel is inactive.
- Resolve any in-doubt messages on the current channel.
- If the channel is triggered, change the process attribute in the transmission queue to name the process associated with the replacement channel.

In this context, some implementations allow a channel to have a blank process object definition, in which case you may omit this step as the queue manager will find and start the appropriate process object.

- Restart the channel, or if the channel was triggered, set the transmission queue attribute TRIGGER.

---

## Connection switching

Another solution would be to switch communication connections from the transmission queues.

To do this:

- If the sender channel is triggered, set the transmission queue attribute NOTRIGGER.
- Ensure the channel is inactive.
- Resolve any in-doubt messages on the channel.
- Change the connection and profile fields to connect to the replacement communication link.
- Ensure that the corresponding channel at the remote end has been defined.
- Restart the channel, or if the sender channel was triggered, set the transmission queue attribute TRIGGER.

---

## Client problems

A client application may receive an unexpected error return code, for example:

- Queue manager not available
- Queue manager name error
- Connection broken

Look in the client error log for a message explaining the cause of the failure. There may also be errors logged at the server, depending on the nature of the failure.

## Terminating clients

Even though a client has terminated, it is still possible for its surrogate process to be holding its queues open. Normally this will only be for a short time until the communications layer notifies that the partner has gone.



### Error logs

MQSeries error messages are placed in different error logs depending on the platform. There are error logs for:

- OS/2 and Windows NT
- UNIX systems
- VSE/ESA
- DOS, Windows 3.1, Windows 95, and Windows 98 clients
- OS/390
- MQSeries for Windows
- MQSeries for Tandem NSK

### Error logs for OS/2 and Windows NT

MQSeries for OS/2 Warp and Windows NT use a number of error logs to capture messages concerning the operation of MQSeries itself, any queue managers that you start, and error data coming from the channels that are in use.

The location the error logs are stored in depends on whether the queue manager name is known and whether the error is associated with a client.

- If the queue manager name is known and the queue manager is available:  
C:\MQM\QMGRS\QMgrName\ERRORS\AMQERR01.LOG
- If the queue manager is not available:  
C:\MQM\QMGRS\@SYSTEM\ERRORS\AMQERR01.LOG
- If an error has occurred with a client application:  
C:\MQM\ERRORS\AMQERR01.LOG

**Note:** The above examples assume that you have installed MQSeries on the C: drive and in the MQM directory. On Windows NT, the default data path is C:\WINNT\Profiles\All Users\Application Data\MQSeries\.

On Windows NT, you should also examine the Windows NT application event log for relevant messages.

### Error logs on UNIX systems

MQSeries on UNIX systems uses a number of error logs to capture messages concerning the operation of MQSeries itself, any queue managers that you start, and error data coming from the channels that are in use. The location the error logs are stored in depends on whether the queue manager name is known and whether the error is associated with a client.

- If the queue manager name is known and the queue manager is available:  
/var/mqm/qmgrs/QMgrName/errors/AMQERR01.LOG
- If the queue manager is not available:  
/var/mqm/qmgrs/@SYSTEM/errors/AMQERR01.LOG
- If an error has occurred with a client application:  
/var/mqm/errors/AMQERR01.LOG

### Error logs on DOS, Windows 3.1, and Windows 95 and Windows 98 clients

MQSeries clients use two error logs, stored in a location set by the environment variable MQDATA (the default is the root drive of the client).

- Error messages:



AMQERR01.LOG

- FFDC messages:

AMQERR01.FDC

These files are not readable. See the *MQSeries Clients* book for information about formatting the information.

### Error logs on OS/390

If you are not using CICS, error messages are written to:

- The OS/390 system console
- The channel-initiator job log

If you are using the OS/390 message processing facility to suppress messages, the console messages may be suppressed. See the *MQSeries for OS/390 System Management Guide* for more information.

If you are using CICS, error messages are written to the OS/390 system console or the CKMQ extrapartition transient data queue. See the *MQSeries for OS/390 System Management Guide* for more information.

### Error logs on MQSeries for Windows

Error logs are written to a file called channel.log in the directory of the running queue manager. You can view the log using the **Channel Logs** sub-tab of the **Services** tab of the MQSeries for Windows properties dialog.

### Error logs on MQSeries for VSE/ESA

All MQSeries-generated error messages are written to SYSTEM.LOG.

### Error logs on MQSeries for Tandem NSK

For information about this, see “Queue manager configuration file” on page 74.

## Further intercommunication considerations

---

## Part 8. Appendixes



---

## Appendix A. Channel planning form

The form shown in Table 52 on page 625 is supplied for you to create and maintain a list of all message channels for each queue manager in your system. Do not fill in the form in this book. Instead, photocopy it as many times as required to hold the definitions of all the channels in your system. The filled-in form, see Table 53 on page 626, is included to illustrate how the two examples in “Chapter 28. Message channel planning example for OS/390 using CICS” on page 387 and “Chapter 34. Message channel planning example for OS/400” on page 477 could be shown.

---

### How to use the form

The channel planning form allows you to keep an overview of the channels and associated objects in your system. It will help to prevent you from making errors when changing your channel configuration.

One of the more obvious errors is to allocate items more than once:

**Communications connections identifiers**

Allocate only once. It may be possible to share connections between channels when using LU 6.2.

**Channel names**

Allocate only once.

**Transmission queues**

Allocate to only one channel. It is possible to allocate to more than one channel for standby purposes, but ensure that only one is active, unless the host environment is MQSeries for OS/390, and there is no sequential delivery of messages selected.

**Remote queue definition**

The name must be unique.

**Queue manager alias name**

The name must be unique.

**Reply-to queue name**

The name must be unique.

**Reply-to queue alias name**

The name must be unique.

**Adjacent channel system name**

The name must be unique.

## Channel planning form

One method of completing the form would be to allocate, systematically, in this order:

- Channels to adjacent systems
- Transmission queues to channels
- Remote queue definitions to queue names and queue manager names, and to transmission queues
- Reply-to queue aliases to reply-to queue names and route names
- Queue manager aliases to remote queue managers and transmission queues

Proceed as follows:

1. Start with one adjacent system, define the first outward channel to that system, and give it a name.
2. Fill in the channel name on the form with the channel type, transmission queue name, adjacent system name, and remote queue manager name.
3. For each class-of-service, logically-named connection, fill in the logical queue manager name to list the queue manager name resolutions using this channel.
4. Allocate a communication connection and fill in the name and profile, where applicable.
5. Record the names of all the queues that your applications are going to use on this channel, using the columns provided on the form. This is necessary where remote queue definitions are used, so that the name resolutions are listed.
6. Do not forget to include the reply-to alias queue names in this list.
7. Move to the next channel and continue until all outward channels have been completed for this adjacent system.
8. When this has been completed, repeat from the beginning for incoming channels from this adjacent system.
9. Move on to the next adjacent system, and repeat.
10. Check the complete list for unwanted multiple assignments of names, objects and connections.

When the list is complete and checked out, use it as an aid in creating the objects, and defining the channels listed.

Table 52. Channel planning form. System name: Queue manager name: Page no:

Channel name	Channel type	CICS system ID (where needed)	Transmission queue name	Connection name	Profile, or mode, name	Adjacent system name	Logical queue manager name	Logical queue name	Physical queue manager name	Physical queue name

Table 53. Channel planning form. System name: QM2 Queue manager name: QM2 Page no: 1

Channel name	Channel type	CICS system ID (where needed)	Transmission queue name	Connection name	Profile, or mode, name	Adjacent system name	Logical queue manager name	Logical queue name	Physical queue manager name	Physical queue name
QM1.T.QM2.CHANNEL	SENDER	(default)	QM2	QM2C	(none)	QM2	QM2	Payrollr	QM2	Payroll
QM1.to.QM2	SENDER	(none)	QM2	QM2D	(none)	QM2	QM2	Payroll	QM2	Payroll
QM2.to.QM1	RECEIVER	(none)	(none)	(none)	(none)	QM2	(none)	(none)	(none)	(none)



---

## Appendix B. Constants for channels and exits

This appendix specifies the values of the named constants that apply to channels and exits in the Message Queue Interface.

The constants are grouped according to the parameter or field to which they relate. All of the names of the constants in a group begin with a common prefix of the form “MQxxxx\_”, where xxxx represents a string of 0 through 4 characters that indicates the parameter or field to which the values relate. The constants are ordered alphabetically by this prefix.

### Notes:

1. For constants with numeric values, the values are shown in both decimal and hexadecimal forms.
2. Hexadecimal values are represented using the notation X'hhhh', where each “h” denotes a single hexadecimal digit.
3. Character values are shown delimited by single quotation marks; the quotation marks are not part of the value.
4. Blanks in character values are represented by one or more occurrences of the symbol “b”.
5. If the value is shown as “(variable)”, it indicates that the value of the constant depends on the environment in which the application is running.

---

### List of constants

The following sections list all of the named constants mentioned in this book, and show their values.

#### MQ\_\* (Lengths of character string and byte fields)

MQ_CHANNEL_DESC_LENGTH	64	X'00000040'
MQ_CHANNEL_NAME_LENGTH	20	X'00000014'
MQ_CONN_NAME_LENGTH	264	X'00000108'
MQ_EXIT_DATA_LENGTH	32	X'00000020'
MQ_EXIT_NAME_LENGTH	(variable)	
MQ_EXIT_USER_AREA_LENGTH	16	X'00000010'
MQ_MAX_EXIT_NAME_LENGTH	128	X'00000080'
MQ_MAX_MCA_USER_ID_LENGTH	64	X'00000040'
MQ_MCA_NAME_LENGTH	20	X'00000014'
MQ_MCA_USER_ID_LENGTH	(variable)	
MQ_MODE_NAME_LENGTH	8	X'00000008'
MQ_PASSWORD_LENGTH	12	X'0000000C'
MQ_Q_MGR_NAME_LENGTH	48	X'00000030'
MQ_Q_NAME_LENGTH	48	X'00000030'
MQ_SHORT_CONN_NAME_LENGTH	20	X'00000014'
MQ_TOTAL_EXIT_DATA_LENGTH	999	X'000003E7'
MQ_TOTAL_EXIT_NAME_LENGTH	999	X'000003E7'
MQ_TP_NAME_LENGTH	64	X'00000040'
MQ_USER_ID_LENGTH	12	X'0000000C'

## Constants

### MQCD\_\* (Channel definition structure length)

See the *StrucLength* field described in “MQCD - Channel data structure” on page 556.

MQCD_LENGTH_4	(variable)
MQCD_LENGTH_5	(variable)
MQCD_LENGTH_6	(variable)
MQCD_CURRENT_LENGTH	(variable)

### MQCD\_\* (Channel definition structure version)

See the *Version* field described in “MQCD - Channel data structure” on page 556.

MQCD_VERSION_1	1	X'00000001'
MQCD_VERSION_2	2	X'00000002'
MQCD_VERSION_3	3	X'00000003'
MQCD_VERSION_4	4	X'00000004'
MQCD_VERSION_5	5	X'00000005'
MQCD_VERSION_6	6	X'00000006'
MQCD_CURRENT_VERSION	(variable)	

### MQCDC\_\* (Channel data conversion)

See the *DataConversion* field described in “MQCD - Channel data structure” on page 556.

MQCDC_NO_SENDER_CONVERSION	0	X'00000000'
MQCDC_SENDER_CONVERSION	1	X'00000001'

### MQCF\_\* (Channel capability flags)

See the *CapabilityFlags* field described in “MQCXP - Channel exit parameter structure” on page 591.

MQCF_NONE	0	X'00000000'
MQCF_DIST_LISTS	1	X'00000001'

### MQCHT\_\* (Channel type)

See the *ChannelType* field described in “MQCD - Channel data structure” on page 556.

MQCHT_SENDER	1	X'00000001'
MQCHT_SERVER	2	X'00000002'
MQCHT_RECEIVER	3	X'00000003'
MQCHT_REQUESTER	4	X'00000004'
MQCHT_CLNTCONN	6	X'00000006'
MQCHT_SVRCONN	7	X'00000007'
MQCHT_CLUSRCVR	8	X'00000008'
MQCHT_CLUSSDR	9	X'00000009'

### MQCXP\_\* (Channel-exit parameter structure identifier)

See the *StrucId* field described in “MQCXP - Channel exit parameter structure” on page 591.

MQCXP\_STRUC\_ID 'CXPb'

For the C programming language, the following array version is also defined:

MQCXP\_STRUC\_ID\_ARRAY 'C','X','P','b'

### MQCXP\_\* (Channel-exit parameter structure version)

See the *Version* field described in “MQCXP - Channel exit parameter structure” on page 591.

MQCXP_VERSION_1	1	X'00000001'
MQCXP_VERSION_2	2	X'00000002'
MQCXP_VERSION_3	3	X'00000003'
MQCXP_VERSION_4	4	X'00000004'
MQCXP_CURRENT_VERSION	(variable)	

### MQMCAT\_\* (MCA type)

See the *MCAType* field described in “MQCD - Channel data structure” on page 556.

MQMCAT_PROCESS	1	X'00000001'
MQMCAT_THREAD	2	X'00000002'

### MQNPMS\_\* (Nonpersistent message speed)

See the *NonPersistentMsgSpeed* field described in “MQCD - Channel data structure” on page 556.

MQNPMS_NORMAL	1	X'00000001'
MQNPMS_FAST	2	X'00000002'

### MQPA\_\* (Put authority)

See the *PutAuthority* field described in “MQCD - Channel data structure” on page 556.

MQPA_DEFAULT	1	X'00000001'
MQPA_CONTEXT	2	X'00000002'

### MQSID\_\* (Security identifier)

See the *MCASecurityId* and *RemoteSecurityId* fields described in “MQCD - Channel data structure” on page 556.

MQSID\_NONE X'00...00' (40 nulls)

For the C programming language, the following array version is also defined:

MQSID\_NONE\_ARRAY '\0','\0',...'\0','\0'

## Constants

### MQSIDT\_\* (Security identifier type)

See the *MCASecurityId* and *RemoteSecurityId* fields described in “MQCD - Channel data structure” on page 556.

MQSIDT_NONE	X'00'
MQSIDT_NT_SECURITY_ID	X'01'

### MQTXP\_\* (Transport retry exit structure identifier)

See the *StrucId* field described in “MQTXP - Transport-exit data structure” on page 605.

MQTXP_STRUC_ID	'TXPb'
----------------	--------

For the C programming language, the following array version is also defined:

MQTXP_STRUC_ID_ARRAY	'T','X','P','b'
----------------------	-----------------

### MQTXP\_\* (Transport retry exit version)

See the *Version* field described in “MQTXP - Transport-exit data structure” on page 605.

MQTXP_VERSION_1	1	X'00000001'
MQTXP_CURRENT_VERSION	1	X'00000001'

### MQXCC\_\* (Exit response)

See the *ExitResponse* field described in “MQCXP - Channel exit parameter structure” on page 591.

### MQXPT\_\* (Transmission protocol type)

See the *TransportType* field described in “MQCD - Channel data structure” on page 556.

### MQXR\_\* (Exit reason)

See the *ExitReason* field described in “MQCXP - Channel exit parameter structure” on page 591.

### MQXR2\_\* (Secondary exit response)

See the *ExitResponse2* field described in “MQCXP - Channel exit parameter structure” on page 591.

MQXR2_PUT_WITH_DEF_ACTION	0	X'00000000'
MQXR2_USE_AGENT_BUFFER	0	X'00000000'
MQXR2_DEFAULT_CONTINUATION	0	X'00000000'
MQXR2_PUT_WITH_DEF_USERID	1	X'00000001'
MQXR2_PUT_WITH_MSG_USERID	2	X'00000002'
MQXR2_USE_EXIT_BUFFER	4	X'00000004'
MQXR2_CONTINUE_CHAIN	8	X'00000008'
MQXR2_SUPPRESS_CHAIN	16	X'00000010'



## Constants

## Appendix C. Queue name resolution

This appendix describes queue name resolution as performed by queue managers at both sending and receiving ends of a channel.

In larger networks, the use of queue managers has a number of advantages over other forms of communication. These advantages derive from the name resolution function in DQM and the main benefits are:

- Applications do not need to make routing decisions
- Applications do not need to know the network structure
- Network links are created by systems administrators
- Network structure is controlled by network planners
- Multiple channels can be used between nodes to partition traffic

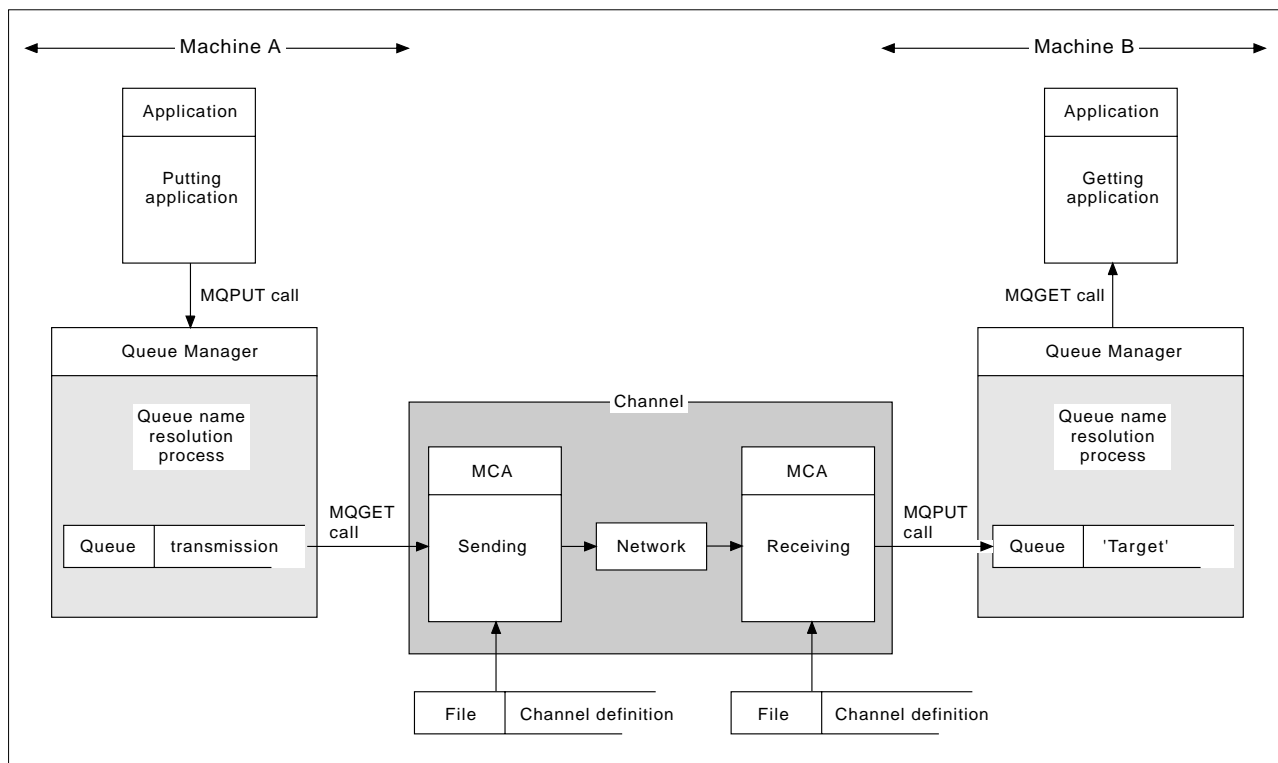

Figure 144. Name resolution

Referring to Figure 144, the basic mechanism for putting messages on a remote queue, as far as the application is concerned, is the same as for putting messages on a local queue:

- The application putting the message issues MQOPEN and MQPUT calls to put messages on the target queue.
- The application getting the messages issues MQOPEN and MQGET calls to get the messages from the target queue.

## Queue name resolution

If both applications are connected to the same queue manager then no inter-queue manager communication is required, and the target queue is described as *local* to both applications.

However, if the applications are connected to different queue managers, two MCAs and their associated network connection are involved in the transfer, as shown in the figure. In this case, the target queue is considered to be a *remote queue* to the putting application.

The sequence of events is as follows:

1. The putting application issues MQOPEN and MQPUT calls to put messages to the target queue.
2. During the MQOPEN call, the *name resolution* function detects that the target queue is not local, and decides which transmission queue is appropriate. Thereafter, on the MQPUT calls associated with the MQOPEN call, all messages are placed on this transmission queue.
3. The sending MCA gets the messages from the transmission queue and passes them to the receiving MCA at the remote computer.
4. The receiving MCA puts the messages on the target queue, or queues.
5. The getting application issues MQOPEN and MQGET calls to get the messages from the target queue.

**Note:** Only step 1 and step 5 involve application code; steps 2 through 4 are performed by the local queue managers and the MCA programs. The putting application is unaware of the location of the target queue, which could be in the same processor, or in another processor on another continent.

The combination of sending MCA, the network connection, and the receiving MCA, is called a *message channel*, and is inherently a unidirectional device. Normally, it is necessary to move messages in both directions, and two channels are set up for this, one in each direction.



---

## What is queue name resolution?

Queue name resolution is vital to DQM. It removes the need for applications to be concerned with the physical location of queues, and insulates them against the details of networks. A systems administrator can move queues from one queue manager to another, and change the routing between queue managers without applications needing to know anything about it.

In order to uncouple from the application design the exact path over which the data travels, it is necessary to introduce a level of indirection between the name used by the application when it refers to the target queue, and the naming of the channel over which the flow occurs. This indirection is achieved using the queue name resolution mechanism.

In essence, when an application refers to a queue name, the name is mapped by the resolution mechanism either to a transmission queue or to a local queue that is not a transmission queue. In the case of mapping to a transmission queue, a second name resolution is needed at the destination, and the received message is placed on the target queue as intended by the application designer. The application remains unaware of the transmission queue and channel used for moving the message.

**Note:** The definition of the queue and channel is a system management responsibility and can be changed by an operator or a system management utility, without the need to change applications.

An important requirement for the system management of message flows is that alternative paths should be provided between queue managers. For example, business requirements might dictate that different *classes of service* should be sent over different channels to the same destination. This is a system management decision and the queue name resolution mechanism provides a very flexible way to achieve it. The next section describes in detail how this is done, but the basic idea is to use queue name resolution at the sending queue manager to map the queue name supplied by the application to the appropriate transmission queue for the type of traffic involved. Similarly at the receiving end, queue name resolution maps the name in the message descriptor to a local (not a transmission) queue or again to an appropriate transmission queue.

Not only is it possible for the forward path from one queue manager to another to be partitioned into different types of traffic, but the return message that is sent to the reply-to queue definition in the outbound message can also use the same traffic partitioning. Queue name resolution satisfies this requirement and the application designer need not be involved in these traffic partitioning decisions.

The point that the mapping is carried out at both the sending and receiving queue managers is an important aspect of the way name resolution works. This allows the queue name supplied by the putting application to be mapped to a local queue or a transmission queue at the sending queue manager, and again remapped to a local queue or a transmission queue at the receiving queue manager.

Reply messages from receiving applications or MCAs have the name resolution carried out in exactly the same way, allowing return routing over specific paths by means of queue definitions at all the queue managers on route.

## Queue name resolution

### How queue name resolution works

The *MQSeries Application Programming Guide* provides the rules for queue name resolution.

---

## Appendix D. Configuration file stanzas for distributed queuing

This appendix shows the stanzas in the queue manager configuration file that relate to distributed queuing. It applies to:

- The queue manager configuration file for MQSeries for OS/2 Warp, called `qm.ini`
- The queue manager configuration file for MQSeries on UNIX systems, called `qm.ini`
- The queue manager initialization file for MQSeries for AS/400, called `qm.ini`, in `/QIBM/UserData/mqm/qmgrs/QMNAME/`

### Notes:

1. The stanzas in the QMINI file for Tandem NSK are different and are described in the *MQSeries for Tandem NonStop Kernel System Management Guide*.
2. MQSeries for Windows NT, V5.1 uses the registry. Use the MQSeries Services snap-in within the Microsoft Management Console (MMC) to make equivalent changes to the configuration information.

The stanzas that relate to distributed queuing are:

- CHANNELS
- TCP
- LU62
- NETBIOS
- SPX
- EXITPATH

Figure 145 on page 638 shows the values that you can set using these stanzas. When you are defining one of these stanzas, you do not need to start each item on a new line. You can use either a semicolon (;) or a hash character (#) to indicate a comment.

## Configuration file stanzas

```
CHANNELS:
  MAXCHANNELS=n          ; Maximum number of channels allowed, the
                        ; default value is 100
  MAXACTIVECHANNELS=n   ; Maximum number of channels allowed to be active at
                        ; any time, the default is the value of MaxChannels
  MAXINITIATORS=n       ; Maximum number of initiators allowed, the
                        ; default value is 3 (see note 1)
  MQIBINDTYPE=type      ; Whether the binding for applications is to be
                        ; "fastpath" or "standard".
                        ; The default is "standard". (see note 2)
  ADOPTNEWMCA=chltype   ; Stops previous process if channel fails to start.
                        ; The default is "NO".
  ADOPTNEWMCATIMEOUT=n  ; Specifies the amount of time that the new
                        ; process should wait for the old process to end.
                        ; The default is 60.
  ADOPTNEWMCACHECHECK= ; Specifies the type checking required.
  typecheck              ; For FAP1, FAP2, and FAP3, "NAME" and
                        ; "ADDRESS" is the default.
                        ; For FAP4 and later, "NAME",
                        ; "ADDRESS", and "QM" is the
                        ; default.

TCP:
  PORT=n                 ; TCP entries
                        ; Port number, the default is 1414
  LIBRARY1=DLLName1     ; Name of TCP Sockets DLL (OS/2 only)
  LIBRARY2=DLLName2     ; Same as above if code is in two libraries (OS/2 only)
  KEEPALIVE=Yes         ; Switch TCP/IP KeepAlive on

LU62:
  TPNAME=name           ; LU 6.2 entries (OS/2 only)
                        ; TP Name to start on remote side
  LIBRARY1=DLLName1     ; Name of APPC DLL (see note 3)
  LIBRARY2=DLLName2     ; Same as above if code is in two libraries (see note 3)
  LOCALLU=name          ; LU to use on local system (OS/2 only)

NETBIOS:
  LOCALNAME=name        ; NetBIOS entries (OS/2 only)
                        ; The name this machine will be known as on the LAN
  ADAPTERNUM=n          ; LAN adapter number, the default is adapter 0
  NUMSESS=n             ; Number of sessions to allocate, the default is 1
  NUMCMDS=n             ; Number of commands to allocate, the default is 1
  NUMNAMES=n            ; Number of names to allocate, the default is 1
  LIBRARY1=DLLName1     ; Name of NetBIOS DLL
  LIBRARY2=DLLName2     ; Same as above if code is in two libraries (OS/2 only)

SPX:
  SOCKET=n              ; SPX entries (OS/2 only)
                        ; The socket number, the default is 5E86
  BOARDNUM=0            ; LAN adapter number, the default is adapter 0 (OS/2 only)
  KEEPALIVE=Yes         ; Switch on "watchdog" to monitor sessions (OS/2 only)
  LIBRARY1=DLLName1     ; Name of SPX DLL
  LIBRARY2=DLLName2     ; Same as above if code is in two libraries (OS/2 only)

EXITPATH:
  EXITPATHS=            ; Location of user exits (MQSeries for AIX,
                        ; HP-UX, OS/2 Warp, and Sun Solaris only)
                        ; String of directory paths

QUEUEMANAGERSTARTUP:
  CHINIT=Yes            ; Start the CHINIT"
```

Figure 145. *qm.ini* stanzas for distributed queuing

### Notes:

1. MAXINITIATORS applies only to MQSeries for AIX, MQSeries for AS/400, MQSeries for HP-UX, MQSeries for OS/2 Warp, and MQSeries for Sun Solaris.

## Configuration file stanzas

2. MQIBINDTYPE applies only to MQSeries for AIX, MQSeries for AS/400, MQSeries for HP-UX, MQSeries for OS/2 Warp, and MQSeries for Sun Solaris.
3. The default values for LIBRARY1 and LIBRARY2 are as follows:
  - TCP** SO32DLL and TCP32DLL (OS/2)
  - LU 6.2** APPC and ACSSVC (OS/2)
  - NetBIOS**
    - ACSNETB (OS/2)
  - SPX** IPXCALLS.DLL and SPXCALLS.DLL (OS/2)

For more information about the qm.ini file and the other stanzas in it, refer to the *MQSeries System Administration* book for V5.1 of MQSeries for AIX, HP-UX, OS/2 Warp, Sun Solaris, and Windows NT, and to the *MQSeries for AS/400 V5.1 System Administration* book for MQSeries for AS/400.

## Further intercommunication considerations

---

## Appendix E. Notices

This information was developed for products and services offered in the United States. IBM may not offer the products, services, or features discussed in this information in other countries. Consult your local IBM representative for information on the products and services currently available in your area. Any reference to an IBM product, program, or service is not intended to state or imply that only that IBM product, program, or service may be used. Any functionally equivalent product, program, or service that does not infringe any IBM intellectual property right may be used instead. However, it is the user's responsibility to evaluate and verify the operation of any non-IBM product, program, or service.

IBM may have patents or pending patent applications covering subject matter described in this information. The furnishing of this information does not give you any license to these patents. You can send license inquiries, in writing, to:

IBM Director of Licensing  
IBM Corporation  
North Castle Drive  
Armonk, NY 10504-1785  
U.S.A.

For license inquiries regarding double-byte (DBCS) information, contact the IBM Intellectual Property Department in your country or send inquiries, in writing, to:

IBM World Trade Asia Corporation  
Licensing  
2-31 Roppongi 3-chome, Minato-ku  
Tokyo 106, Japan

**The following paragraph does not apply to the United Kingdom or any other country where such provisions are inconsistent with local law:**

INTERNATIONAL BUSINESS MACHINES CORPORATION PROVIDES THIS PUBLICATION "AS IS" WITHOUT WARRANTY OF ANY KIND, EITHER EXPRESS OR IMPLIED, INCLUDING, BUT NOT LIMITED TO, THE IMPLIED WARRANTIES OF NON-INFRINGEMENT, MERCHANTABILITY, OR FITNESS FOR A PARTICULAR PURPOSE. Some states do not allow disclaimer of express or implied warranties in certain transactions, therefore this statement may not apply to you.

This information could include technical inaccuracies or typographical errors. Changes are periodically made to the information herein; these changes will be incorporated in new editions of the information. IBM may make improvements and/or changes in the product(s) and/or the program(s) described in this information at any time without notice.

Any references in this information to non-IBM Web sites are provided for convenience only and do not in any manner serve as an endorsement of those Web sites. The materials at those Web sites are not part of the materials for this IBM product and use of those Web sites is at your own risk.

IBM may use or distribute any of the information you supply in any way it believes appropriate without incurring any obligation to you.

## Notices

Licensees of this program who wish to have information about it for the purpose of enabling: (i) the exchange of information between independently created programs and other programs (including this one) and (ii) the mutual use of the information which has been exchanged, should contact:

IBM United Kingdom Laboratories,  
Mail Point 151,  
Hursley Park,  
Winchester,  
Hampshire,  
England  
SO21 2JN.

Such information may be available, subject to appropriate terms and conditions, including in some cases, payment of a fee.

The licensed program described in this information and all licensed material available for it are provided by IBM under terms of the IBM Customer Agreement, IBM International Programming License Agreement, or any equivalent agreement between us.

Information concerning non-IBM products was obtained from the suppliers of those products, their published announcements or other publicly available sources. IBM has not tested those products and cannot confirm the accuracy of performance, compatibility or any other claims related to non-IBM products. Questions on the capabilities of non-IBM products should be addressed to the suppliers of those products.

### COPYRIGHT LICENSE:

This information contains sample application programs in source language, which illustrate programming techniques on various operating platforms. You may copy, modify, and distribute these sample programs in any form without payment to IBM, for the purposes of developing, using, marketing or distributing application programs conforming to the application programming interface for the operating platform for which the sample programs are written. These examples have not been thoroughly tested under all conditions. IBM, therefore, cannot guarantee or imply reliability, serviceability, or function of these programs. You may copy, modify, and distribute these sample programs in any form without payment to IBM for the purposes of developing, using, marketing, or distributing application programs conforming to IBM's application programming interfaces.

---

## Programming interface information

This book is intended to help you set up and control message channels between queue managers.

This book also documents General-use Programming Interface and Associated Guidance Information and Product-sensitive Programming Interface and Associated Guidance Information provided by:

MQSeries for AIX, V5.1,  
MQSeries for AS/400 V5.1,  
MQSeries for AT&T GIS UNIX V2.2,  
MQSeries for Compaq (DIGITAL) OpenVMS, V2.2.1.1,  
MQSeries for DIGITAL UNIX (Compaq Tru64 UNIX), V2.2.1  
MQSeries for HP-UX, V5.1,  
MQSeries for OS/390, V2.1,



MQSeries for OS/2 Warp, V5.1,  
 MQSeries for SINIX and DC/OSx, V2.2,  
 MQSeries for Sun Solaris, V5.1,  
 MQSeries for Tandem NonStop Kernel, V2.2,  
 MQSeries for VSE/ESA V2.1,  
 MQSeries for Windows V2.0,  
 MQSeries for Windows V2.1,  
 MQSeries for Tandem NonStop Kernel, V2.2.0.1.

General-use programming interfaces allow the customer to write programs that obtain the services of these products.

General-use Programming Interface and Associated Guidance Information is identified where it occurs, by an introductory statement to a chapter or section.

Product-sensitive programming interfaces allow the customer installation to perform tasks such as diagnosing, modifying, monitoring, repairing, tailoring, or tuning of these products. Use of such interfaces creates dependencies on the detailed design or implementation of the IBM software product. Product-sensitive programming interfaces should be used only for these specialized purposes. Because of their dependencies on detailed design and implementation, it is to be expected that programs written to such interfaces may need to be changed in order to run with new product releases or versions, or as a result of service.

Product-sensitive Programming Interface and Associated Guidance Information is identified where it occurs, by an introductory statement to a chapter or section.

---

## Trademarks

The following terms are trademarks of International Business Machines Corporation in the United States, or other countries, or both:

Advanced Peer-to-Peer Networking	ACF/VTAM	AIX
APPN	AS/400	BookManager
CICS	CICS/ESA	CICS/VSE
CICS/400	C/400	FFST
First Failure Support Technology	IBM	IMS
Integrated Language Environment	MQSeries	MVS/ESA
OpenEdition	OS/2	OS/390
OS/400	RACF	RS/6000
System/390	S/390	VSE/ESA
VTAM		

Lotus and LotusScript are trademarks of Lotus Development Corporation in the United States, or other countries, or both.

Java and all Java-based trademarks and logos are trademarks or registered trademarks of Sun Microsystems, Inc. in the United States and/or other countries.

Microsoft, Windows, Windows NT, and the Windows logo are trademarks of Microsoft Corporation in the United States and/or other countries.

## Notices

UNIX is a registered trademark in the United States and/or other countries licensed exclusively through X/Open Company Limited.

Other company, product, and service names may be trademarks or service marks of others.

---

## Glossary of terms and abbreviations

This glossary defines MQSeries terms and abbreviations used in this book. If you do not find the term you are looking for, see the Index or the *IBM Dictionary of Computing*, New York: McGraw-Hill, 1994.

This glossary includes terms and definitions from the *American National Dictionary for Information Systems*, ANSI X3.172-1990, copyright 1990 by the American National Standards Institute (ANSI). Copies may be purchased from the American National Standards Institute, 11 West 42 Street, New York, New York 10036. Definitions are identified by the symbol (A) after the definition.

### A

**abend reason code.** A 4-byte hexadecimal code that uniquely identifies a problem with MQSeries for OS/390. A complete list of MQSeries for OS/390 abend reason codes and their explanations is contained in the *MQSeries for OS/390 Messages and Codes* manual.

**active log.** See *recovery log*.

**adapter.** An interface between MQSeries for OS/390 and TSO, IMS™, CICS, or batch address spaces. An adapter is an attachment facility that enables applications to access MQSeries services.

**address space.** The area of virtual storage available for a particular job.

**address space identifier (ASID).** A unique, system-assigned identifier for an address space.

**administrator commands.** MQSeries commands used to manage MQSeries objects, such as queues, processes, and namelists.

**Advanced Program-to-Program Communication (APPC).** The general facility characterizing the LU 6.2 architecture and its various implementations in products.

**alert.** A message sent to a management services focal point in a network to identify a problem or an impending problem.

**alert monitor.** In MQSeries for OS/390, a component of the CICS adapter that handles unscheduled events occurring as a result of connection requests to MQSeries for OS/390.

**alias queue object.** An MQSeries object, the name of which is an alias for a base queue defined to the local

queue manager. When an application or a queue manager uses an alias queue, the alias name is resolved and the requested operation is performed on the associated base queue.

**allied address space.** See *ally*.

**ally.** An OS/390 address space that is connected to MQSeries for OS/390.

**alternate user security.** A security feature in which the authority of one user ID can be used by another user ID; for example, to open an MQSeries object.

**APAR.** Authorized program analysis report.

**APC.** Advanced Program Communication.

**APPC.** Advanced Program-to-Program Communication.

**application environment.** The software facilities that are accessible by an application program. On the OS/390 platform, CICS and IMS are examples of application environments.

**application log.** In Windows NT, a log that records significant application events.

**application queue.** A queue used by an application.

**archive log.** See *recovery log*.

**ARM.** Automatic Restart Management

**ASID.** Address space identifier.

**asynchronous messaging.** A method of communication between programs in which programs place messages on message queues. With asynchronous messaging, the sending program proceeds with its own processing without waiting for a reply to its message. Contrast with *synchronous messaging*.

**attribute.** One of a set of properties that defines the characteristics of an MQSeries object.

**authorization checks.** Security checks that are performed when a user tries to issue administration commands against an object, for example to open a queue or connect to a queue manager.

**authorization file.** In MQSeries on UNIX systems, a file that provides security definitions for an object, a class of objects, or all classes of objects.

**authorization service.** In MQSeries on UNIX systems, MQSeries for OS/2 Warp, and MQSeries for Windows NT, a service that provides authority checking of

commands and MQI calls for the user identifier associated with the command or call.

**authorized program analysis report (APAR).** A report of a problem caused by a suspected defect in a current, unaltered release of a program.

**Automatic Restart Management (ARM).** An OS/390 recovery function that can improve the availability of specific batch jobs or started tasks, and therefore result in faster resumption of productive work.

## B

**backout.** An operation that reverses all the changes made during the current unit of recovery or unit of work. After the operation is complete, a new unit of recovery or unit of work begins. Contrast with *commit*.

**basic mapping support (BMS).** An interface between CICS and application programs that formats input and output display data and routes multiple-page output messages without regard for control characters used by various terminals.

**BMS.** Basic mapping support.

**bootstrap data set (BSDS).** A VSAM data set that contains:

- An inventory of all active and archived log data sets known to MQSeries for OS/390
- A wrap-around inventory of all recent MQSeries for OS/390 activity

The BSDS is required if the MQSeries for OS/390 subsystem has to be restarted.

**browse.** In message queuing, to use the MQGET call to copy a message without removing it from the queue. See also *get*.

**browse cursor.** In message queuing, an indicator used when browsing a queue to identify the message that is next in sequence.

**BSDS.** Bootstrap data set.

**buffer pool.** An area of main storage used for MQSeries for OS/390 queues, messages, and object definitions. See also *page set*.

## C

**call back.** In MQSeries, a requester message channel initiates a transfer from a sender channel by first calling the sender, then closing down and awaiting a call back.

**CCF.** Channel control function.

**CCSID.** Coded character set identifier.

**CDF.** Channel definition file.

**channel.** See *message channel*.

**channel control function (CCF).** In MQSeries, a program to move messages from a transmission queue to a communication link, and from a communication link to a local queue, together with an operator panel interface to allow the setup and control of channels.

**channel definition file (CDF).** In MQSeries, a file containing communication channel definitions that associate transmission queues with communication links.

**channel event.** An event indicating that a channel instance has become available or unavailable. Channel events are generated on the queue managers at both ends of the channel.

**channel exit program.** A user-written program that can be entered from one of a defined number of places during channel operation.

**channel initiator.** A component of MQSeries distributed queuing, which monitors the initiation queue to see when triggering criteria have been met and then starts the sender channel.

**channel listener.** A component of MQSeries distributed queuing, which monitors the network for a startup request and then starts the receiving channel.

**checkpoint.** A time when significant information is written on the log. Contrast with *syncpoint*. In MQSeries on UNIX systems, the point in time when a data record described in the log is the same as the data record in the queue. Checkpoints are generated automatically and are used during the system restart process.

**CI.** Control interval.

**circular logging.** In MQSeries on UNIX systems, MQSeries for OS/2 Warp, and MQSeries for Windows NT, the process of keeping all restart data in a ring of log files. Logging fills the first file in the ring and then moves on to the next, until all the files are full. At this point, logging goes back to the first file in the ring and starts again, if the space has been freed or is no longer needed. Circular logging is used during restart recovery, using the log to roll back transactions that were in progress when the system stopped. Contrast with *linear logging*.

**CL.** Control Language.

**client.** A run-time component that provides access to queuing services on a server for local user applications. The queues used by the applications reside on the server. See also *MQSeries client*.

**client application.** An application, running on a workstation and linked to a client, that gives the application access to queuing services on a server.

**client connection channel type.** The type of MQI channel definition associated with an MQSeries client. See also *server connection channel type*.

**CLUSRCVR.** Cluster-receiver channel definition.

**CLUSSDR.** Cluster-sender channel definition.

**cluster.** A network of queue managers that are logically associated in some way.

**cluster-receiver channel (CLUSRCVR).** A channel on which a cluster queue manager can receive messages from other queue managers in the cluster and cluster information from the repository queue managers.

**cluster-sender channel (CLUSSDR).** A channel on which a cluster queue manager can send messages to other queue managers in the cluster and cluster information to the repository queue managers.

**cluster transmission queue.** A transmission queue that transmits all messages from a queue manager to any other queue manager that is in the same cluster. The queue is called SYSTEM.CLUSTER.TRANSMIT.QUEUE.

**coded character set identifier (CCSID).** The name of a coded set of characters and their code point assignments.

**command.** In MQSeries, an administration instruction that can be carried out by the queue manager.

**command prefix (CPF).** In MQSeries for OS/390, a character string that identifies the queue manager to which MQSeries for OS/390 commands are directed, and from which MQSeries for OS/390 operator messages are received.

**command processor.** The MQSeries component that processes commands.

**command server.** The MQSeries component that reads commands from the system-command input queue, verifies them, and passes valid commands to the command processor.

**commit.** An operation that applies all the changes made during the current unit of recovery or unit of work. After the operation is complete, a new unit of recovery or unit of work begins. Contrast with *backout*.

**Common Run-Time Environment (CRE).** A set of services that enable system and application programmers to write mixed-language programs. These shared, run-time services can be used by C, COBOL85, FORTRAN, Pascal, and TAL programs.

**completion code.** A return code indicating how an MQI call has ended.

**configuration file.** In MQSeries on UNIX systems, MQSeries for OS/2 Warp, and MQSeries for Windows

NT, a file that contains configuration information related to, for example, logs, communications, or installable services. Synonymous with *.ini file*. See also *stanza*.

**connect.** To provide a queue manager connection handle, which an application uses on subsequent MQI calls. The connection is made either by the MQCONN call, or automatically by the MQOPEN call.

**connection handle.** The identifier or token by which a program accesses the queue manager to which it is connected.

**context.** Information about the origin of a message.

**context security.** In MQSeries, a method of allowing security to be handled such that messages are obliged to carry details of their origins in the message descriptor.

**control command.** In MQSeries on UNIX systems, MQSeries for OS/2 Warp, and MQSeries for Windows NT, a command that can be entered interactively from the operating system command line. Such a command requires only that the MQSeries product be installed; it does not require a special utility or program to run it.

**control interval (CI).** A fixed-length area of direct access storage in which VSAM stores records and creates distributed free spaces. The control interval is the unit of information that VSAM transmits to or from direct access storage.

**Control Language (CL).** In MQSeries for AS/400, a language that can be used to issue commands, either at the command line or by writing a CL program.

**controlled shutdown.** See *quiesced shutdown*.

**CPF.** Command prefix.

**CRE.** Common Run-Time Environment.

## D

**DAE.** Dump analysis and elimination.

**daemon.** In UNIX systems, a program that runs unattended to perform a standard service. Some daemons are triggered automatically to perform their tasks; others operate periodically.

**data conversion interface (DCI).** The MQSeries interface to which customer- or vendor-written programs that convert application data between different machine encodings and CCSIDs must conform. A part of the MQSeries Framework.

**datagram.** The simplest message that MQSeries supports. This type of message does not require a reply.

**DCE.** Distributed Computing Environment.

**DCE principal.** A user ID that uses the distributed computing environment.

**DCI.** Data conversion interface.

**dead-letter queue (DLQ).** A queue to which a queue manager or application sends messages that it cannot deliver to their correct destination.

**dead-letter queue handler.** An MQSeries-supplied utility that monitors a dead-letter queue (DLQ) and processes messages on the queue in accordance with a user-written rules table.

**default object.** A definition of an object (for example, a queue) with all attributes defined. If a user defines an object but does not specify all possible attributes for that object, the queue manager uses default attributes in place of any that were not specified.

**deferred connection.** A pending event that is activated when a CICS subsystem tries to connect to MQSeries for OS/390 before MQSeries for OS/390 has been started.

**distributed application.** In message queuing, a set of application programs that can each be connected to a different queue manager, but that collectively constitute a single application.

**Distributed Computing Environment (DCE).** Middleware that provides some basic services, making the development of distributed applications easier. DCE is defined by the Open Software Foundation (OSF).

**distributed queue management (DQM).** In message queuing, the setup and control of message channels to queue managers on other systems.

**DLQ.** Dead-letter queue.

**DQM.** Distributed queue management.

**dual logging.** A method of recording MQSeries for OS/390 activity, where each change is recorded on two data sets, so that if a restart is necessary and one data set is unreadable, the other can be used. Contrast with *single logging*.

**dual mode.** See *dual logging*.

**dump analysis and elimination (DAE).** An OS/390 service that enables an installation to suppress SVC dumps and ABEND SYSUDUMP dumps that are not needed because they duplicate previously written dumps.

**dynamic queue.** A local queue created when a program opens a model queue object. See also *permanent dynamic queue* and *temporary dynamic queue*.

## E

**environment.** See *application environment*.

**ESM.** External security manager.

**ESTAE.** Extended specify task abnormal exit.

**event.** See *channel event*, *instrumentation event*, *performance event*, and *queue manager event*.

**event data.** In an event message, the part of the message data that contains information about the event (such as the queue manager name, and the application that gave rise to the event). See also *event header*.

**event header.** In an event message, the part of the message data that identifies the event type of the reason code for the event.

**event log.** See *application log*.

**event message.** Contains information (such as the category of event, the name of the application that caused the event, and queue manager statistics) relating to the origin of an instrumentation event in a network of MQSeries systems.

**event queue.** The queue onto which the queue manager puts an event message after it detects an event. Each category of event (queue manager, performance, or channel event) has its own event queue.

**Event Viewer.** A tool provided by Windows NT to examine and manage log files.

**extended specify task abnormal exit (ESTAE).** An OS/390 macro that provides recovery capability and gives control to the specified exit routine for processing, diagnosing an abend, or specifying a retry address.

**external security manager (ESM).** A security product that is invoked by the OS/390 System Authorization Facility. RACF is an example of an ESM.

## F

**FAP.** Formats and Protocols.

**FFST™.** First Failure Support Technology™.

**FIFO.** First-in-first-out.

**First Failure Support Technology (FFST).** Used by MQSeries on UNIX systems, MQSeries for OS/2 Warp, MQSeries for Windows NT, and MQSeries for AS/400 to detect and report software problems.

**first-in-first-out (FIFO).** A queuing technique in which the next item to be retrieved is the item that has been in the queue for the longest time. (A)



**forced shutdown.** A type of shutdown of the CICS adapter where the adapter immediately disconnects from MQSeries for OS/390, regardless of the state of any currently active tasks. Contrast with *quiesced shutdown*.

**Formats and Protocols (FAP).** The MQSeries FAPs define how queue managers communicate with one another, and also how MQSeries clients communicate with server queue managers.

**Framework.** In MQSeries, a collection of programming interfaces that allow customers or vendors to write programs that extend or replace certain functions provided in MQSeries products. The interfaces are:

- MQSeries data conversion interface (DCI)
- MQSeries message channel interface (MCI)
- MQSeries name service interface (NSI)
- MQSeries security enabling interface (SEI)
- MQSeries trigger monitor interface (TMI)

**FRR.** Functional recovery routine.

**functional recovery routine (FRR).** An OS/390 recovery/termination manager facility that enables a recovery routine to gain control in the event of a program interrupt.

## G

**GCPC.** Generalized command preprocessor.

**generalized command preprocessor (GCPC).** An MQSeries for OS/390 component that processes MQSeries commands and runs them.

**Generalized Trace Facility (GTF).** An OS/390 service program that records significant system events, such as supervisor calls and start I/O operations, for the purpose of problem determination.

**get.** In message queuing, to use the MQGET call to remove a message from a queue. See also *browse*.

**global trace.** An MQSeries for OS/390 trace option where the trace data comes from the entire MQSeries for OS/390 subsystem.

**GTF.** Generalized Trace Facility.

## H

**handle.** See *connection handle* and *object handle*.

**hardened message.** A message that is written to auxiliary (disk) storage so that the message will not be lost in the event of a system failure. See also *persistent message*.

**heartbeat flow.** A pulse that is passed from a sending MCA to a receiving MCA when there are no messages

to send. The pulse unblocks the receiving MCA, which otherwise, would remain in a wait state until a message arrived or the disconnect interval expired.

**heartbeat interval.** The time, in seconds, that is to elapse between heartbeat flows.

## I

**ICE.** Intersystem Communications Environment is a family of Tandem-based software products that enables you to access a variety of applications on Tandem computers.

**ILE.** Integrated Language Environment®.

**immediate shutdown.** In MQSeries, a shutdown of a queue manager that does not wait for applications to disconnect. Current MQI calls are allowed to complete, but new MQI calls fail after an immediate shutdown has been requested. Contrast with *quiesced shutdown* and *preemptive shutdown*.

**in-doubt unit of recovery.** In MQSeries, the status of a unit of recovery for which a syncpoint has been requested but not yet confirmed.

**Integrated Language Environment (ILE).** The AS/400 Integrated Language Environment. This replaces the AS/400 Original Program Model (OPM).

**.ini file.** See *configuration file*.

**initialization file.** In MQSeries for AS/400, a file that contains two parameters; the TCP/IP listener port number and the maximum number of channels that can be current at a time. The file is called qm.ini.

**initialization input data sets.** Data sets used by MQSeries for OS/390 when it starts up.

**initiation queue.** A local queue on which the queue manager puts trigger messages.

**input/output parameter.** A parameter of an MQI call in which you supply information when you make the call, and in which the queue manager changes the information when the call completes or fails.

**input parameter.** A parameter of an MQI call in which you supply information when you make the call.

**installable services.** In MQSeries on UNIX systems, MQSeries for OS/2 Warp, and MQSeries for Windows NT, additional functionality provided as independent components. The installation of each component is optional: in-house or third-party components can be used instead. See also *authorization service*, *name service*, and *user identifier service*.

**instrumentation event.** A facility that can be used to monitor the operation of queue managers in a network of MQSeries systems. MQSeries provides

instrumentation events for monitoring queue manager resource definitions, performance conditions, and channel conditions. Instrumentation events can be used by a user-written reporting mechanism in an administration application that displays the events to a system operator. They also allow applications acting as agents for other administration networks to monitor reports and create the appropriate alerts.

**Interactive Problem Control System (IPCS).** A component of OS/390 that permits online problem management, interactive problem diagnosis, online debugging for disk-resident abend dumps, problem tracking, and problem reporting.

**Interactive System Productivity Facility (ISPF).** An IBM licensed program that serves as a full-screen editor and dialog manager. It is used for writing application programs, and provides a means of generating standard screen panels and interactive dialogues between the application programmer and terminal user.

**Internet Protocol (IP).** A protocol used to route data from its source to its destination in an Internet environment. This is the base layer, on which other protocol layers, such as TCP and UDP are built.

**Intersystem communication.** In CICS, communication between separate systems by means of SNA networking facilities or by means of the application-to-application facilities of an SNA access method.

**IP.** Internet Protocol.

**IPCS.** Interactive Problem Control System.

**ISC.** Intersystem communication.

**ISPF.** Interactive System Productivity Facility.

## L

**linear logging.** In MQSeries on UNIX systems, MQSeries for OS/2 Warp, and MQSeries for Windows NT, the process of keeping restart data in a sequence of files. New files are added to the sequence as necessary. The space in which the data is written is not reused until the queue manager is restarted. Contrast with *circular logging*.

**listener.** In MQSeries distributed queuing, a program that monitors for incoming network connections.

**local definition.** An MQSeries object belonging to a local queue manager.

**local definition of a remote queue.** An MQSeries object belonging to a local queue manager. This object defines the attributes of a queue that is owned by another queue manager. In addition, it is used for queue-manager aliasing and reply-to-queue aliasing.

**locale.** On UNIX systems, a subset of a user's environment that defines conventions for a specific culture (such as time, numeric, or monetary formatting and character classification, collation, or conversion). The queue manager CCSID is derived from the locale of the user ID that created the queue manager.

**local queue.** A queue that belongs to the local queue manager. A local queue can contain a list of messages waiting to be processed. Contrast with *remote queue*.

**local queue manager.** The queue manager to which a program is connected and that provides message queuing services to the program. Queue managers to which a program is not connected are called *remote queue managers*, even if they are running on the same system as the program.

**log.** In MQSeries, a file recording the work done by queue managers while they receive, transmit, and deliver messages, to enable them to recover in the event of failure.

**log control file.** In MQSeries on UNIX systems, MQSeries for OS/2 Warp, and MQSeries for Windows NT, the file containing information needed to monitor the use of log files (for example, their size and location, and the name of the next available file).

**log file.** In MQSeries on UNIX systems, MQSeries for OS/2 Warp, and MQSeries for Windows NT, a file in which all significant changes to the data controlled by a queue manager are recorded. If the primary log files become full, MQSeries allocates secondary log files.

**logical unit of work (LUW).** See *unit of work*.

**luname.** The name of the logical unit on your workstation, that is the name of the software that interfaces between your applications and the network.

**LUWID.** Logical unit of work identifier.

**LU 6.2.** A type of logical unit (LU) that supports general communication between programs in a distributed processing environment.

## M

**machine check interrupt.** An interruption that occurs as a result of an equipment malfunction or error. A machine check interrupt can be either hardware recoverable, software recoverable, or nonrecoverable.

**MCA.** Message channel agent.

**MCI.** Message channel interface.

**media image.** In MQSeries on UNIX systems, MQSeries for OS/2 Warp, and MQSeries for Windows NT, the sequence of log records that contain an image of an object. The object can be recreated from this image.



**message.** In message queuing applications, a communication sent between programs. See also *persistent message* and *nonpersistent message*. In system programming, information intended for the terminal operator or system administrator.

**message channel.** In distributed message queuing, a mechanism for moving messages from one queue manager to another. A message channel comprises two message channel agents (a sender at one end and a receiver at the other end) and a communication link. Contrast with *MQI channel*.

**message channel agent (MCA).** A program that transmits prepared messages from a transmission queue to a communication link, or from a communication link to a destination queue. See also *message queue interface*.

**message channel interface (MCI).** The MQSeries interface to which customer- or vendor-written programs that transmit messages between an MQSeries queue manager and another messaging system must conform. A part of the MQSeries Framework.

**message descriptor.** Control information describing the message format and presentation that is carried as part of an MQSeries message. The format of the message descriptor is defined by the MQMD structure.

**message flow control.** A distributed queue management task that involves setting up and maintaining message routes between queue managers.

**message priority.** In MQSeries, an attribute of a message that can affect the order in which messages on a queue are retrieved, and whether a trigger event is generated.

**message queue.** Synonym for *queue*.

**message queue interface (MQI).** The programming interface provided by the MQSeries queue managers. This programming interface allows application programs to access message queuing services.

**message queue management.** The Message Queue Management (MQM) facility in MQSeries for Tandem NSK V2.2 uses PCF command formats and control commands. MQM runs as a PATHWAY SCOBOL requester under the Terminal Control Process (TCP) and uses an MQM SERVERCLASS server, which invokes the C language API to perform PCF commands. There is a separate instance of MQM for each queue manager configured on a system, since each queue manager is controlled under its own PATHWAY configuration. Consequently, an MQM is limited to the management of the queue manager to which it belongs.

**message queuing.** A programming technique in which each program within an application communicates with the other programs by putting messages on queues.

**message-retry.** An option available to an MCA that is unable to deliver a message. The MCA can wait for a predefined amount of time and then try to send the message again.

**message sequence numbering.** A programming technique in which messages are given unique numbers during transmission over a communication link. This enables the receiving process to check whether all messages are received, to place them in a queue in the original order, and to discard duplicate messages.

**messaging.** See *synchronous messaging* and *asynchronous messaging*.

**model queue object.** A set of queue attributes that act as a template when a program creates a dynamic queue.

**MQAI.** MQSeries Administration Interface.

**MQI.** Message queue interface.

**MQI channel.** Connects an MQSeries client to a queue manager on a server system, and transfers only MQI calls and responses in a bidirectional manner. Contrast with *message channel*.

**MQSC.** MQSeries commands.

**MQSeries.** A family of IBM licensed programs that provides message queuing services.

**MQSeries Administration Interface (MQAI).** A programming interface to MQSeries.

**MQSeries client.** Part of an MQSeries product that can be installed on a system without installing the full queue manager. The MQSeries client accepts MQI calls from applications and communicates with a queue manager on a server system.

**MQSeries commands (MQSC).** Human readable commands, uniform across all platforms, that are used to manipulate MQSeries objects. Contrast with *programmable command format (PCF)*.

**MQSeries server.** An MQSeries server is a queue manager that provides queuing services to one or more clients. All the MQSeries objects, for example queues, exist only on the queue manager system, that is, on the MQI server machine. A server can support normal local MQI applications as well.

**multi-hop.** To pass through one or more intermediate queue managers when there is no direct communication link between a source queue manager and the target queue manager.

## N

**namelist.** An MQSeries object that contains a list of names, for example, queue names.

**name service.** In MQSeries on UNIX systems, MQSeries for OS/2 Warp, and MQSeries for Windows NT, the facility that determines which queue manager owns a specified queue.

**name service interface (NSI).** The MQSeries interface to which customer- or vendor-written programs that resolve queue-name ownership must conform. A part of the MQSeries Framework.

**name transformation.** In MQSeries on UNIX systems, MQSeries for OS/2 Warp, and MQSeries for Windows NT, an internal process that changes a queue manager name so that it is unique and valid for the system being used. Externally, the queue manager name remains unchanged.

**NetBIOS.** Network Basic Input/Output System. An operating system interface for application programs used on IBM personal computers that are attached to the IBM Token-Ring Network.

**New Technology File System (NTFS).** A Windows NT recoverable file system that provides security for files.

**nonpersistent message.** A message that does not survive a restart of the queue manager. Contrast with *persistent message*.

**NSI.** Name service interface.

**NTFS.** New Technology File System.

**null character.** The character that is represented by X'00'.

## O

**OAM.** Object authority manager.

**object.** In MQSeries, an object is a queue manager, a queue, a process definition, a channel, a namelist, or a storage class (OS/390 only).

**object authority manager (OAM).** In MQSeries on UNIX systems, MQSeries for AS/400, and MQSeries for Windows NT, the default authorization service for command and object management. The OAM can be replaced by, or run in combination with, a customer-supplied security service.

**object descriptor.** A data structure that identifies a particular MQSeries object. Included in the descriptor are the name of the object and the object type.

**object handle.** The identifier or token by which a program accesses the MQSeries object with which it is working.

**off-loading.** In MQSeries for OS/390, an automatic process whereby a queue manager's active log is transferred to its archive log.

**OPM.** Original Program Model.

**Original Program Model (OPM).** The AS/400 Original Program Model. This is no longer supported on MQSeries. It is replaced by the Integrated Language Environment (ILE).

**OTMA.** Open Transaction Manager Access.

**output log-buffer.** In MQSeries for OS/390, a buffer that holds recovery log records before they are written to the archive log.

**output parameter.** A parameter of an MQI call in which the queue manager returns information when the call completes or fails.

## P

**page set.** A VSAM data set used when MQSeries for OS/390 moves data (for example, queues and messages) from buffers in main storage to permanent backing storage (DASD).

**PCF.** Programmable command format.

**PCF command.** See *programmable command format*.

**pending event.** An unscheduled event that occurs as a result of a connect request from a CICS adapter.

**percolation.** In error recovery, the passing along a preestablished path of control from a recovery routine to a higher-level recovery routine.

**performance event.** A category of event indicating that a limit condition has occurred.

**performance trace.** An MQSeries trace option where the trace data is to be used for performance analysis and tuning.

**permanent dynamic queue.** A dynamic queue that is deleted when it is closed only if deletion is explicitly requested. Permanent dynamic queues are recovered if the queue manager fails, so they can contain persistent messages. Contrast with *temporary dynamic queue*.

**persistent message.** A message that survives a restart of the queue manager. Contrast with *nonpersistent message*.

**ping.** In distributed queuing, a diagnostic aid that uses the exchange of a test message to confirm that a message channel or a TCP/IP connection is functioning.

**platform.** In MQSeries, the operating system under which a queue manager is running.

**point of recovery.** In MQSeries for OS/390, the term used to describe a set of backup copies of MQSeries for OS/390 page sets and the corresponding log data sets

required to recover these page sets. These backup copies provide a potential restart point in the event of page set loss (for example, page set I/O error).

**preemptive shutdown.** In MQSeries, a shutdown of a queue manager that does not wait for connected applications to disconnect, nor for current MQI calls to complete. Contrast with *immediate shutdown* and *quiesced shutdown*.

**principal.** In MQSeries on UNIX systems, MQSeries for OS/2 Warp, and MQSeries for Windows NT, a term used for a user identifier. Used by the object authority manager for checking authorizations to system resources.

**process definition object.** An MQSeries object that contains the definition of an MQSeries application. For example, a queue manager uses the definition when it works with trigger messages.

**programmable command format (PCF).** A type of MQSeries message used by:

- User administration applications, to put PCF commands onto the system command input queue of a specified queue manager
- User administration applications, to get the results of a PCF command from a specified queue manager
- A queue manager, as a notification that an event has occurred

Contrast with *MQSC*.

**program temporary fix (PTF).** A solution or by-pass of a problem diagnosed by IBM field engineering as the result of a defect in a current, unaltered release of a program.

**PTF.** Program temporary fix.

## Q

**queue.** An MQSeries object. Message queuing applications can put messages on, and get messages from, a queue. A queue is owned and maintained by a queue manager. Local queues can contain a list of messages waiting to be processed. Queues of other types cannot contain messages—they point to other queues, or can be used as models for dynamic queues.

**queue manager.** A system program that provides queuing services to applications. It provides an application programming interface so that programs can access messages on the queues that the queue manager owns. See also *local queue manager* and *remote queue manager*. An MQSeries object that defines the attributes of a particular queue manager.

**queue manager event.** An event that indicates:

- An error condition has occurred in relation to the resources used by a queue manager. For example, a queue is unavailable.
- A significant change has occurred in the queue manager. For example, a queue manager has stopped or started.

**queuing.** See *message queuing*.

**quiesced shutdown.** In MQSeries, a shutdown of a queue manager that allows all connected applications to disconnect. Contrast with *immediate shutdown* and *preemptive shutdown*. A type of shutdown of the CICS adapter where the adapter disconnects from MQSeries, but only after all the currently active tasks have been completed. Contrast with *forced shutdown*.

**quiescing.** In MQSeries, the state of a queue manager prior to it being stopped. In this state, programs are allowed to finish processing, but no new programs are allowed to start.

## R

**RBA.** Relative byte address.

**reason code.** A return code that describes the reason for the failure or partial success of an MQI call.

**receiver channel.** In message queuing, a channel that responds to a sender channel, takes messages from a communication link, and puts them on a local queue.

**recovery log.** In MQSeries for OS/390, data sets containing information needed to recover messages, queues, and the MQSeries subsystem. MQSeries for OS/390 writes each record to a data set called the *active log*. When the active log is full, its contents are off-loaded to a DASD or tape data set called the *archive log*. Synonymous with *log*.

**recovery termination manager (RTM).** A program that handles all normal and abnormal termination of tasks by passing control to a recovery routine associated with the terminating function.

**Registry.** In Windows NT, a secure database that provides a single source for system and application configuration data.

**Registry Editor.** In Windows NT, the program item that allows the user to edit the Registry.

**Registry Hive.** In Windows NT, the structure of the data stored in the Registry.

**relative byte address (RBA).** The displacement in bytes of a stored record or control interval from the beginning of the storage space allocated to the data set to which it belongs.

**remote queue.** A queue belonging to a remote queue manager. Programs can put messages on remote queues, but they cannot get messages from remote queues. Contrast with *local queue*.

**remote queue manager.** To a program, a queue manager that is not the one to which the program is connected.

**remote queue object.** See *local definition of a remote queue*.

**remote queuing.** In message queuing, the provision of services to enable applications to put messages on queues belonging to other queue managers.

**reply message.** A type of message used for replies to request messages. Contrast with *request message* and *report message*.

**reply-to queue.** The name of a queue to which the program that issued an MQPUT call wants a reply message or report message sent.

**report message.** A type of message that gives information about another message. A report message can indicate that a message has been delivered, has arrived at its destination, has expired, or could not be processed for some reason. Contrast with *reply message* and *request message*.

**requester channel.** In message queuing, a channel that may be started remotely by a sender channel. The requester channel accepts messages from the sender channel over a communication link and puts the messages on the local queue designated in the message. See also *server channel*.

**request message.** A type of message used to request a reply from another program. Contrast with *reply message* and *report message*.

**RESLEVEL.** In MQSeries for OS/390, an option that controls the number of CICS user IDs checked for API-resource security in MQSeries for OS/390.

**resolution path.** The set of queues that are opened when an application specifies an alias or a remote queue on input to an MQOPEN call.

**resource.** Any facility of the computing system or operating system required by a job or task. In MQSeries for OS/390, examples of resources are buffer pools, page sets, log data sets, queues, and messages.

**resource manager.** An application, program, or transaction that manages and controls access to shared resources such as memory buffers and data sets. MQSeries, CICS, and IMS are resource managers.

**responder.** In distributed queuing, a program that replies to network connection requests from another system.

**resynch.** In MQSeries, an option to direct a channel to start up and resolve any in-doubt status messages, but without restarting message transfer.

**return codes.** The collective name for completion codes and reason codes.

**return-to-sender.** An option available to an MCA that is unable to deliver a message. The MCA can send the message back to the originator.

**rollback.** Synonym for *back out*.

**RTM.** Recovery termination manager.

**rules table.** A control file containing one or more rules that the dead-letter queue handler applies to messages on the DLQ.

## S

**SAF.** System Authorization Facility.

**SDWA.** System diagnostic work area.

**security enabling interface (SEI).** The MQSeries interface to which customer- or vendor-written programs that check authorization, supply a user identifier, or perform authentication must conform. A part of the MQSeries Framework.

**SEI.** Security enabling interface.

**sender channel.** In message queuing, a channel that initiates transfers, removes messages from a transmission queue, and moves them over a communication link to a receiver or requester channel.

**sequential delivery.** In MQSeries, a method of transmitting messages with a sequence number so that the receiving channel can reestablish the message sequence when storing the messages. This is required where messages must be delivered only once, and in the correct order.

**sequential number wrap value.** In MQSeries, a method of ensuring that both ends of a communication link reset their current message sequence numbers at the same time. Transmitting messages with a sequence number ensures that the receiving channel can reestablish the message sequence when storing the messages.

**server.** (1) In MQSeries, a queue manager that provides queue services to client applications running on a remote workstation. (2) The program that responds to requests for information in the particular two-program, information-flow model of client/server. See also *client*.

**server channel.** In message queuing, a channel that responds to a requester channel, removes messages



from a transmission queue, and moves them over a communication link to the requester channel.

**server connection channel type.** The type of MQI channel definition associated with the server that runs a queue manager. See also *client connection channel type*.

**service interval.** A time interval, against which the elapsed time between a put or a get and a subsequent get is compared by the queue manager in deciding whether the conditions for a service interval event have been met. The service interval for a queue is specified by a queue attribute.

**service interval event.** An event related to the service interval.

**session ID.** In MQSeries for OS/390, the CICS-unique identifier that defines the communication link to be used by a message channel agent when moving messages from a transmission queue to a link.

**shutdown.** See *immediate shutdown*, *preemptive shutdown*, and *quiesced shutdown*.

**signaling.** In MQSeries for OS/390 and MQSeries for Windows 2.1, a feature that allows the operating system to notify a program when an expected message arrives on a queue.

**single logging.** A method of recording MQSeries for OS/390 activity where each change is recorded on one data set only. Contrast with *dual logging*.

**single-phase backout.** A method in which an action in progress must not be allowed to finish, and all changes that are part of that action must be undone.

**single-phase commit.** A method in which a program can commit updates to a queue without coordinating those updates with updates the program has made to resources controlled by another resource manager. Contrast with *two-phase commit*.

**SIT.** System initialization table.

**SNA.** Systems Network Architecture.

**source queue manager.** See *local queue manager*.

**SPX.** Sequenced Packet Exchange transmission protocol.

**stanza.** A group of lines in a configuration file that assigns a value to a parameter modifying the behavior of a queue manager, client, or channel. In MQSeries on UNIX systems, MQSeries for OS/2 Warp, and MQSeries for Windows NT, a configuration (.ini) file may contain a number of stanzas.

**star-connected communications network.** A network in which all nodes are connected to a central node.

**storage class.** In MQSeries for OS/390, a storage class defines the page set that is to hold the messages for a particular queue. The storage class is specified when the queue is defined.

**store and forward.** The temporary storing of packets, messages, or frames in a data network before they are retransmitted toward their destination.

**subsystem.** In OS/390, a group of modules that provides function that is dependent on OS/390. For example, MQSeries for OS/390 is an OS/390 subsystem.

**supervisor call (SVC).** An OS/390 instruction that interrupts a running program and passes control to the supervisor so that it can perform the specific service indicated by the instruction.

**SVC.** Supervisor call.

**switch profile.** In MQSeries for OS/390, a RACF profile used when MQSeries starts up or when a refresh security command is issued. Each switch profile that MQSeries detects turns off checking for the specified resource.

**symptom string.** Diagnostic information displayed in a structured format designed for searching the IBM software support database.

**synchronous messaging.** A method of communication between programs in which programs place messages on message queues. With synchronous messaging, the sending program waits for a reply to its message before resuming its own processing. Contrast with *asynchronous messaging*.

**syncpoint.** An intermediate or end point during processing of a transaction at which the transaction's protected resources are consistent. At a syncpoint, changes to the resources can safely be committed, or they can be backed out to the previous syncpoint.

**System Authorization Facility (SAF).** An OS/390 facility through which MQSeries for OS/390 communicates with an external security manager such as RACF.

**system.command.input queue.** A local queue on which application programs can put MQSeries commands. The commands are retrieved from the queue by the command server, which validates them and passes them to the command processor to be run.

**system control commands.** Commands used to manipulate platform-specific entities such as buffer pools, storage classes, and page sets.

**system diagnostic work area (SDWA).** Data recorded in a SYS1.LOGREC entry, which describes a program or hardware error.

**system initialization table (SIT).** A table containing parameters used by CICS on start up.

**Systems Network Architecture (SNA).** The description of the logical structure, formats, protocols, and operational sequences for transmitting information units through, and controlling the configuration and operation of, networks.

**SYS1.LOGREC.** A service aid containing information about program and hardware errors.

## T

**TACL.** Tandem Advanced Command Language.

**target library high-level qualifier (thlqual).** High-level qualifier for OS/390 target data set names.

**target queue manager.** See *remote queue manager*.

**task control block (TCB).** An OS/390 control block used to communicate information about tasks within an address space that are connected to an OS/390 subsystem such as MQSeries for OS/390 or CICS.

**task switching.** The overlapping of I/O operations and processing between several tasks. In MQSeries for OS/390, the task switcher optimizes performance by allowing some MQI calls to be executed under subtasks rather than under the main CICS TCB.

**TCB.** Task control block.

**TCP.** Transmission Control Protocol.

**TCP/IP.** Transmission Control Protocol/Internet Protocol.

**temporary dynamic queue.** A dynamic queue that is deleted when it is closed. Temporary dynamic queues are not recovered if the queue manager fails, so they can contain nonpersistent messages only. Contrast with *permanent dynamic queue*.

**teraspace.** In MQSeries for AS/400, a form of shared memory introduced in OS/400 V4R4.

**termination notification.** A pending event that is activated when a CICS subsystem successfully connects to MQSeries for OS/390.

**thlqual.** Target library high-level qualifier.

**thread.** In MQSeries, the lowest level of parallel execution available on an operating system platform.

**time-independent messaging.** See *asynchronous messaging*.

**TMI.** Trigger monitor interface.

**trace.** In MQSeries, a facility for recording MQSeries activity. The destinations for trace entries can include

GTF and the system management facility (SMF). See also *global trace* and *performance trace*.

**tranid.** See *transaction identifier*.

**transaction identifier.** In CICS, a name that is specified when the transaction is defined, and that is used to invoke the transaction.

**Transmission Control Protocol (TCP).** Part of the TCP/IP protocol suite. A host-to-host protocol between hosts in packet-switched communications networks. TCP provides connection-oriented data stream delivery. Delivery is reliable and orderly.

**Transmission Control Protocol/Internet Protocol (TCP/IP).** A suite of communication protocols that support peer-to-peer connectivity functions for both local and wide area networks.

**transmission program.** See *message channel agent*.

**transmission queue.** A local queue on which prepared messages destined for a remote queue manager are temporarily stored.

**trigger event.** An event (such as a message arriving on a queue) that causes a queue manager to create a trigger message on an initiation queue.

**triggering.** In MQSeries, a facility allowing a queue manager to start an application automatically when predetermined conditions on a queue are satisfied.

**trigger message.** A message containing information about the program that a trigger monitor is to start.

**trigger monitor.** A continuously-running application serving one or more initiation queues. When a trigger message arrives on an initiation queue, the trigger monitor retrieves the message. It uses the information in the trigger message to start a process that serves the queue on which a trigger event occurred.

**trigger monitor interface (TMI).** The MQSeries interface to which customer- or vendor-written trigger monitor programs must conform. A part of the MQSeries Framework.

**two-phase commit.** A protocol for the coordination of changes to recoverable resources when more than one resource manager is used by a single transaction. Contrast with *single-phase commit*.

## U

**UDP.** User Datagram Protocol.

**UIS.** User identifier service.

**undelivered-message queue.** See *dead-letter queue*.

**undo/redo record.** A log record used in recovery. The redo part of the record describes a change to be made to an MQSeries object. The undo part describes how to back out the change if the work is not committed.

**unit of recovery.** A recoverable sequence of operations within a single resource manager. Contrast with *unit of work*.

**unit of work.** A recoverable sequence of operations performed by an application between two points of consistency. A unit of work begins when a transaction starts or after a user-requested syncpoint. It ends either at a user-requested syncpoint or at the end of a transaction. Contrast with *unit of recovery*.

**User Datagram Protocol (UDP).** Part of the TCP/IP protocol suite. A packet-level protocol built directly on the Internet Protocol layer. UDP is a connectionless and less reliable alternative to TCP. It is used for application-to-application programs between TCP/IP host systems.

**user identifier service (UIS).** In MQSeries for OS/2 Warp, the facility that allows MQI applications to associate a user ID, other than the default user ID, with MQSeries messages.

**utility.** In MQSeries, a supplied set of programs that provide the system operator or system administrator with facilities in addition to those provided by the MQSeries commands. Some utilities invoke more than one function.





---

## Bibliography

This section describes the documentation available for all current MQSeries products.

---

### MQSeries cross-platform publications

Most of these publications, which are sometimes referred to as the MQSeries “family” books, apply to all MQSeries Level 2 products. The latest MQSeries Level 2 products are:

- MQSeries for AIX, V5.1
- MQSeries for AS/400, V5.1
- MQSeries for AT&T GIS UNIX V2.2
- MQSeries for Compaq (DIGITAL) OpenVMS, V2.2.1.1
- MQSeries for DIGITAL UNIX (Compaq Tru64 UNIX), V2.2.1
- MQSeries for HP-UX, V5.1
- MQSeries for OS/2 Warp, V5.1
- MQSeries for OS/390, V2.1
- MQSeries for SINIX and DC/OSx, V2.2
- MQSeries for Sun Solaris, V5.1
- MQSeries for Tandem NonStop Kernel, V2.2.0.1
- MQSeries for VSE/ESA V2.1
- MQSeries for Windows V2.0
- MQSeries for Windows V2.1
- MQSeries for Windows NT, V5.1

Any exceptions to this general rule are indicated.

#### MQSeries Brochure

The *MQSeries Brochure*, G511-1908, gives a brief introduction to the benefits of MQSeries. It is intended to support the purchasing decision, and describes some authentic customer use of MQSeries.

#### MQSeries: An Introduction to Messaging and Queuing

*An Introduction to Messaging and Queuing*, GC33-0805, describes briefly what MQSeries is, how it works, and how it can solve some classic interoperability problems. This book is intended for a more technical audience than the *MQSeries Brochure*.

#### MQSeries Planning Guide

The *MQSeries Planning Guide*, GC33-1349, describes some key MQSeries concepts, identifies items that need to be considered before MQSeries is installed, including

storage requirements, backup and recovery, security, and migration from earlier releases, and specifies hardware and software requirements for every MQSeries platform.

#### MQSeries Intercommunication

The *MQSeries Intercommunication* book, SC33-1872, defines the concepts of distributed queuing and explains how to set up a distributed queuing network in a variety of MQSeries environments. In particular, it demonstrates how to (1) configure communications to and from a representative sample of MQSeries products, (2) create required MQSeries objects, and (3) create and configure MQSeries channels. The use of channel exits is also described.

#### MQSeries Queue Manager Clusters

*MQSeries Queue Manager Clusters*, SC34-5349, describes MQSeries clustering. It explains the concepts and terminology and shows how you can benefit by taking advantage of clustering. It details changes to the MQI, and summarizes the syntax of new and changed MQSeries commands. It shows a number of examples of tasks you can perform to set up and maintain clusters of queue managers.

This book applies to the following MQSeries products only:

- MQSeries for AIX V5.1
- MQSeries for AS/400 V5.1
- MQSeries for HP-UX V5.1
- MQSeries for OS/2 Warp V5.1
- MQSeries for OS/390 V2.1
- MQSeries for Sun Solaris V5.1
- MQSeries for Windows NT V5.1

#### MQSeries Clients

The *MQSeries Clients* book, GC33-1632, describes how to install, configure, use, and manage MQSeries client systems.

#### MQSeries System Administration

The *MQSeries System Administration* book, SC33-1873, supports day-to-day management of local and remote MQSeries objects. It includes topics such as security, recovery and restart, transactional support, problem

determination, and the dead-letter queue handler. It also includes the syntax of the MQSeries control commands.

This book applies to the following MQSeries products only:

- MQSeries for AIX, V5.1
- MQSeries for HP-UX, V5.1
- MQSeries for OS/2 Warp, V5.1
- MQSeries for Sun Solaris, V5.1
- MQSeries for Windows NT, V5.1

### **MQSeries Command Reference**

The *MQSeries Command Reference*, SC33-1369, contains the syntax of the MQSC commands, which are used by MQSeries system operators and administrators to manage MQSeries objects.

### **MQSeries Programmable System Management**

The *MQSeries Programmable System Management* book, SC33-1482, provides both reference and guidance information for users of MQSeries events, Programmable Command Format (PCF) messages, and installable services.

### **MQSeries Administration Interface Programming Guide and Reference**

The *MQSeries Administration Interface Programming Guide and Reference*, SC34-5390, provides information for users of the MQAI. The MQAI is a programming interface that simplifies the way in which applications manipulate Programmable Command Format (PCF) messages and their associated data structures.

This book applies to the following MQSeries products only:

- MQSeries for AIX V5.1
- MQSeries for AS/400 V5.1
- MQSeries for HP-UX V5.1
- MQSeries for OS/2 Warp V5.1
- MQSeries for Sun Solaris V5.1
- MQSeries for Windows NT V5.1

### **MQSeries Messages**

The *MQSeries Messages* book, GC33-1876, which describes “AMQ” messages issued by MQSeries, applies to these MQSeries products only:

- MQSeries for AIX, V5.1
- MQSeries for HP-UX, V5.1
- MQSeries for OS/2 Warp, V5.1
- MQSeries for Sun Solaris, V5.1
- MQSeries for Windows NT, V5.1

- MQSeries for Windows V2.0
- MQSeries for Windows V2.1

This book is available in softcopy only.

For other MQSeries platforms, the messages are supplied with the system. They do not appear in softcopy manual form.

### **MQSeries Application Programming Guide**

The *MQSeries Application Programming Guide*, SC33-0807, provides guidance information for users of the message queue interface (MQI). It describes how to design, write, and build an MQSeries application. It also includes full descriptions of the sample programs supplied with MQSeries.

### **MQSeries Application Programming Reference**

The *MQSeries Application Programming Reference*, SC33-1673, provides comprehensive reference information for users of the MQI. It includes: data-type descriptions; MQI call syntax; attributes of MQSeries objects; return codes; constants; and code-page conversion tables.

### **MQSeries Application Programming Reference Summary**

The *MQSeries Application Programming Reference Summary*, SX33-6095, summarizes the information in the *MQSeries Application Programming Reference* manual.

### **MQSeries Using C++**

*MQSeries Using C++*, SC33-1877, provides both guidance and reference information for users of the MQSeries C++ programming-language binding to the MQI. MQSeries C++ is supported by these MQSeries products:

- MQSeries for AIX, V5.1
- MQSeries for HP-UX, V5.1
- MQSeries for OS/2 Warp, V5.1
- MQSeries for AS/400, V5.1
- MQSeries for OS/390, V2.1
- MQSeries for Sun Solaris, V5.1
- MQSeries for Windows NT, V5.1

MQSeries C++ is also supported by MQSeries clients supplied with these products and installed in the following environments:

- AIX
- HP-UX

- OS/2
- Sun Solaris
- Windows NT
- Windows 3.1
- Windows 95 and Windows 98

### **MQSeries Using Java**

*MQSeries Using Java*, SC34-5456, provides both guidance and reference information for users of the MQSeries Bindings for Java and the MQSeries Client for Java. MQSeries classes for Java are supported by these MQSeries products:

- MQSeries for AIX, V5.1
- MQSeries for AS/400, V5.1
- MQSeries for HP-UX, V5.1
- MQSeries for MVS/ESA V1.2
- MQSeries for OS/2 Warp, V5.1
- MQSeries for Sun Solaris, V5.1
- MQSeries for Windows NT, V5.1

This book is available in softcopy only.

---

## **MQSeries platform-specific publications**

Each MQSeries product is documented in at least one platform-specific publication, in addition to the MQSeries family books.

### **MQSeries for AIX**

*MQSeries for AIX, V5.1 Quick Beginnings*, GC33-1867

### **MQSeries for AS/400**

*MQSeries for AS/400 V5.1 Quick Beginnings*, GC34-5557

*MQSeries for AS/400 V5.1 System Administration*, SC34-5558

*MQSeries for AS/400 V5.1 Application Programming Reference (ILE RPG)*, SC34-5559

### **MQSeries for AT&T GIS UNIX**

*MQSeries for AT&T GIS UNIX System Management Guide*, SC33-1642

### **MQSeries for Compaq (DIGITAL) OpenVMS**

*MQSeries for Digital OpenVMS System Management Guide*, GC33-1791

### **MQSeries for Digital UNIX (Compaq Tru64 UNIX)**

*MQSeries for Digital UNIX System Management Guide*, GC34-5483

### **MQSeries for HP-UX**

*MQSeries for HP-UX, V5.1 Quick Beginnings*, GC33-1869

### **MQSeries for OS/2 Warp**

*MQSeries for OS/2 Warp, V5.1 Quick Beginnings*, GC33-1868

### **MQSeries for OS/390**

*MQSeries for OS/390 Version 2 Release 1 Licensed Program Specifications*, GC34-5377

*MQSeries for OS/390 Version 2 Release 1 Program Directory*

*MQSeries for OS/390 System Management Guide*, SC34-5374

*MQSeries for OS/390 Messages and Codes*, GC34-5375

*MQSeries for OS/390 Problem Determination Guide*, GC34-5376

### **MQSeries link for R/3**

*MQSeries link for R/3 Version 1.2 User's Guide*, GC33-1934

### **MQSeries for SINIX and DC/OSx**

*MQSeries for SINIX and DC/OSx System Management Guide*, GC33-1768

### **MQSeries for Sun Solaris**

*MQSeries for Sun Solaris, V5.1 Quick Beginnings*, GC33-1870

### **MQSeries for Tandem NonStop Kernel**

*MQSeries for Tandem NonStop Kernel System Management Guide*, GC33-1893

### **MQSeries for VSE/ESA**

*MQSeries for VSE/ESA Version 2 Release 1 Licensed Program Specifications*, GC34-5365

*MQSeries for VSE/ESA System Management Guide*, GC34-5364

### **MQSeries for Windows**

*MQSeries for Windows V2.0 User's Guide*, GC33-1822

*MQSeries for Windows V2.1 User's Guide*, GC33-1965

### **MQSeries for Windows NT**

*MQSeries for Windows NT, V5.1 Quick Beginnings*, GC34-5389

*MQSeries for Windows NT Using the Component Object Model Interface*, SC34-5387

## Softcopy books

Most of the MQSeries books are supplied in both hardcopy and softcopy formats.

## BookManager format

The MQSeries library is supplied in IBM BookManager<sup>®</sup> format on a variety of online library collection kits, including the *Transaction Processing and Data* collection kit, SK2T-0730. You can view the softcopy books in IBM BookManager format using the following IBM licensed programs:

- BookManager READ/2
- BookManager READ/6000
- BookManager READ/DOS
- BookManager READ/MVS
- BookManager READ/VM
- BookManager READ for Windows

## HTML format

Relevant MQSeries documentation is provided in HTML format with these MQSeries products:

- MQSeries for AIX, V5.1
- MQSeries for AS/400, V5.1
- MQSeries for HP-UX, V5.1
- MQSeries for OS/2 Warp, V5.1
- MQSeries for Sun Solaris, V5.1
- MQSeries for Windows NT, V5.1 (compiled HTML)
- MQSeries link for R/3 V1.2

The MQSeries books are also available in HTML format from the MQSeries product family Web site at:

<http://www.ibm.com/software/ts/mqseries/>

## Portable Document Format (PDF)

PDF files can be viewed and printed using the Adobe Acrobat Reader.

If you need to obtain the Adobe Acrobat Reader, or would like up-to-date information about the platforms on which the Acrobat Reader is supported, visit the Adobe Systems Inc. Web site at:

<http://www.adobe.com/>

PDF versions of relevant MQSeries books are supplied with these MQSeries products:

- MQSeries for AIX, V5.1
- MQSeries for AS/400, V5.1

- MQSeries for HP-UX, V5.1
- MQSeries for OS/2 Warp, V5.1
- MQSeries for Sun Solaris, V5.1
- MQSeries for Windows NT, V5.1
- MQSeries link for R/3 V1.2

PDF versions of all current MQSeries books are also available from the MQSeries product family Web site at:

<http://www.ibm.com/software/ts/mqseries/>

## PostScript format

The MQSeries library is provided in PostScript (.PS) format with many MQSeries Version 2 products. Books in PostScript format can be printed on a PostScript printer or viewed with a suitable viewer.

## Windows Help format

The *MQSeries for Windows User's Guide* is provided in Windows Help format with MQSeries for Windows Version 2.0 and MQSeries for Windows Version 2.1.

---

## MQSeries information available on the Internet

The MQSeries product family Web site is at:

<http://www.ibm.com/software/ts/mqseries/>

By following links from this Web site you can:

- Obtain latest information about the MQSeries product family.
- Access the MQSeries books in HTML and PDF formats.
- Download MQSeries SupportPacs.

---

## Related publications

This section describes the documentation available for related products.

### Programming

*OS/390 C/C++ Programming Guide*, SC09-2362

### OS/390

*OS/390 OpenEdition Planning*, SC28-1890

### CICS

*CICS Family: Interproduct Communication*, SC33-0824

*CICS/400 Intercommunication*, SC33-1388

*CICS Intercommunication Guide, SC33-1695*  
*CICS Resource Definition Guide, SC33-1684*

## **OS/400**

*OS/400 Communication Configuration, SC41-3401*  
*OS/400 Communication Management, SC41-3406*  
*OS/400 Work Management, SC41-3306*  
*OS/400 APPC Communications Programming,*  
*SC41-3443*

## **Digital**

*Digital DECnet SNA Gateway Guide to IBM*  
*Parameters*  
*Digital DECnet for OpenVMS Networking*  
*Manual*

## **SNA**

*Microsoft SNA Server APPC Programmers Guide*  
*Microsoft SNA Server CPI-C Programmers Guide*  
*OpenNet LU 6.2, System Administrator's Guide*  
*OpenNet SNA Engine, System Administrator's*  
*Guide*

## **SINIX**

*Transit SINIX Version 3.2 Administration of*  
*Transit*

You may also find the following International  
Technical Support Organization "Red Books"  
useful:

*APPC Security: MVS/ESA, CICS/ESA, and OS/2,*  
*GG24-3960*

*Examples of Using MQSeries on S/390, RS/6000,*  
*AS/400, and PS/2, GG24-4326*

*Multiplatform APPC Configuration Guide,*  
*GG24-4485*

You can find a list of all the red books available at  
URL <http://www.almaden.ibm.com/redbooks/> > >

Request these books through your IBM  
representative.

## Related publications



---

# Index

## A

active channels, maximum number 64  
add routing entry 455  
addressing information 25  
addrtrge 455  
administration, channel 60  
AgentBuffer parameter 547  
AgentBufferLength parameter 547  
aliases 25  
ALTDATA attribute 78  
alter channel  
    OS/390 325  
    OS/390 using CICS 356  
Alter option 370  
alternate channels 15  
ALTTIME attribute 78  
AMQCRCTA channel program 445  
AMQCRS6A channel program 119  
AMQCRSTA channel program 119, 445  
AMQRMCLA channel program 445  
APC pathway definition, example 295  
APPC/MVS, defining a connection 342  
applications, trusted 12, 121  
ARM (Automatic Restart Management) 344  
assured delivery 22  
AT&T GIS SNA Server 246  
Attachmate PathWay 280  
attributes  
    ALTDATA 78  
    alter date 78  
    alter time 78  
    ALTTIME 78  
    auto start 78  
    AUTOSTART 78  
    batch interval 79  
    batch size 79  
    BATCHINT 79  
    BATCHSZ 79  
    CHANNEL 80  
    channel description 84  
    channel name 80  
    channel type 81  
    CHLTYPE 81  
    CLUSNL 82  
    CLUSTER 81  
    cluster name 81  
    cluster namelist 82  
    communication connection  
        identifier 82  
    CONNNAME 82  
    connection name 82  
    CONVERT 83  
    convert message 83  
    DESCR 84  
    DISCINT 84  
    disconnect interval 84  
    HBINT 85  
    heartbeat interval 85  
    long retry count 85  
    long retry interval 85

attributes (*continued*)  
    LONGRTY 85  
    LONGTMR 85  
    LU 6.2 mode name 86  
    LU 6.2 TP name 86  
    maximum message length 87  
    maximum transmission size 87  
    MAXMSGL 87  
    MCA name 87  
    MCA type 88  
    MCA user 88  
    MCANAME 87  
    MCATYPE 88  
    MCAUSER 88  
    message exit name 88  
    message exit user data 89  
    message retry count 89  
    message-retry exit name 89  
    message-retry exit user data 89  
    message retry interval 89  
    mode name 86  
    MODENAME 86  
    MRDATA 89  
    MREXIT 89  
    MRRTY 89  
    MRTMR 89  
    MSGDATA 89  
    MSGEXIT 88  
    NETPRTY 90  
    network-connection priority 90  
    nonpersistent message speed 90  
    NPMSPEED 90  
    password 90  
    profile name, CICS 81  
    PUT authority 90  
    PUTAUT 90  
    QMNAME 91  
    queue manager name 91  
    RCVDATA 92  
    RCVEXIT 91  
    receive exit name 91  
    receive exit user data 92  
    SCYDATA 93  
    SCYEXIT 92  
    security exit name 92  
    security exit user data 93  
    send exit name 93  
    send exit user data 93  
    SENDDATA 93  
    SENDEXIT 93  
    sequence number wrap 93  
    sequential delivery 93  
    SEQWRAP 93  
    short retry count 93  
    short retry interval 94  
    SHORTRTY 93  
    SHORTTMR 94  
    target system identifier 94  
    TPNAME 86  
    transaction identifier 94  
    transmission protocol 95

attributes (*continued*)  
    transmission queue name 94  
    transport type 95  
    TRPTYPE 95  
    user ID 95  
    USERID 95  
    XMITQ 94  
authority, PUT 90  
auto-definition exit program 516  
auto-definition of channels 60  
automatic channel reconnect for  
    TCP/IP 344  
Automatic Restart Management  
    (ARM) 344  
AUTOSTART attribute 78

## B

back out in-doubt messages  
    Digital OpenVMS 116  
    OS/2 116  
    OS/400 439  
    Tandem NSK 116  
    UNIX systems 116  
    Windows NT 116  
batch interval 79  
batch size 79  
BATCHINT attribute 79  
BatchInterval field 573  
BatchSize field 562  
BATCHSZ attribute 79  
bibliography 659  
bind type 121  
binding, fastpath 121  
BINDING channel state 62  
BookManager 662  
browsing a channel 356, 430

## C

caller  
    MCA 9  
caller, responder 9  
caller MCA 9  
calls  
    MQ\_CHANNEL\_AUTO\_DEF\_EXIT 551  
    MQ\_CHANNEL\_EXIT 546  
    MQ\_TRANSPORT\_EXIT 555  
    MQXWAIT 553  
CapabilityFlags field 601  
CEDA CICS transaction 383  
change definition, channel 113, 436  
Change option 436  
channel  
    administration 60  
    alter  
        OS/390 325  
        OS/390 using CICS 370  
    altering 356  
    attributes 111  
    auto-definition 60

- channel (*continued*)
  - auto-definition exit program 516
  - browsing 356, 430
  - change definition 113, 436
  - channel control function
    - Digital OpenVMS 105
    - OS/2 105
    - OS/400 423
    - Tandem NSK 105
    - UNIX systems 105
    - Windows NT 105
  - characteristics
    - Digital OpenVMS 119
    - OS/2 119
    - OS/390 using CICS 351
    - OS/400 445
    - Tandem NSK 119
    - UNIX systems 119
    - Windows NT 119
  - client-connection 7
  - cluster-receiver 9
  - cluster-sender 8
  - command queue
    - OS/390 343
  - configuration 490
  - constants 627
  - control commands 60
  - copy definition 367, 436
  - create definition
    - Digital OpenVMS 113
    - OS/2 113
    - OS/390 using CICS 368
    - OS/400 435
    - Tandem NSK 113
    - UNIX Systems 113
    - Windows NT 113
  - creating 109, 356, 426
  - creating your own defaults 369, 435
  - default values supplied by MQSeries for AS/400 435
  - default values supplied by OS/390 using CICS 369, 372
  - define
    - OS/390 324
    - OS/390 using CICS 372
  - definition, what is it? 57
  - definition file
    - Digital OpenVMS 106
    - OS/2 106
    - OS/390 using CICS 351
    - OS/400 423
    - Tandem NSK 106
    - UNIX systems 106
    - Windows NT 106
  - delete 113, 437
    - OS/390 326
    - OS/390 using CICS 370
  - description 84
  - display
    - Digital OpenVMS 113
    - OS/2 113
    - OS/400 437
    - Tandem NSK 113
    - UNIX systems 113
    - Windows NT 113
  - display, OS/390 325

- channel (*continued*)
  - display settings
    - OS/390 using CICS 365
  - display status
    - Digital OpenVMS 113
    - OS/2 113
    - OS/390 using CICS 364
    - OS/400 437
    - Tandem NSK 113
    - UNIX systems 113
    - Windows NT 113
  - displaying 110, 437
  - displaying settings
    - Digital OpenVMS 113
    - OS/2 113
    - OS/390 using CICS 364
    - OS/400 437
    - Tandem NSK 113
    - UNIX Systems 113
    - Windows NT 113
  - displaying status 437
    - Digital OpenVMS 113
    - OS/2 113
    - OS/390 using CICS 364
    - OS/400 437
    - Tandem NSK 113
    - UNIX Systems 113
    - Windows NT 113
  - enabling 61
  - end 438
  - error 65
    - restarting after 69
  - exit current function 366
  - fastpath binding 121
  - find 370
  - in doubt 69
  - in-doubt channels 69
  - initial data negotiation 61
  - initiator
    - AIX, OS/2, HP-UX, Sun Solaris, and Windows NT 118
    - OS/390 327
    - overview 10
    - starting 118
    - stopping 118
  - listener
    - overview 10
    - start, OS/390 329
    - start, OS/400 437
    - stop, OS/390 329
    - STRMQMLSR command 437
    - trusted 12
  - menu-bar choice 373
  - monitoring 60
  - MQI 7
  - OS/400
    - resolve 439
  - ping
    - Digital OpenVMS 113
    - OS/2 113
    - OS/390 331
    - OS/390 using CICS 366
    - OS/400 437
    - Tandem NSK 113
    - UNIX systems 113
    - Windows NT 113
  - planning form 623

- channel (*continued*)
  - preparing 60
  - program types
    - Digital OpenVMS 119
    - MQSeries for AS/400 445
    - OS/2 119
    - Tandem NSK 119
    - UNIX systems 119
    - Windows NT 119
  - programs 445
    - AMQCCLA 445
    - AMQCRCTA 445
    - AMQCRS6A 119, 445
    - AMQCRSTA 119
    - AMQRMCLA 445
    - OS/390 using CICS 351
  - pull-down menu 373
  - quiescing 67
  - receiver 7
  - receiving parameters 59
  - refuses to run 613
  - renaming
    - Digital OpenVMS 111
    - OS/2 111
    - OS/390 using CICS 357
    - OS/400 432
    - Tandem NSK 111
    - UNIX Systems 111
    - Windows NT 111
  - requester 7
  - requester-sender 9
  - requester-server 9
  - reset
    - OS/390 332
    - OS/390 using CICS 362
  - Reset
    - Digital OpenVMS 116
    - OS/2 116
    - OS/400 439
    - Tandem NSK 116
    - UNIX systems 116
    - Windows NT 116
  - resolving
    - Digital OpenVMS 116
    - OS/2 116
    - OS/390 333
    - OS/390 using CICS 363
    - OS/400 439
    - Tandem NSK 116
    - UNIX Systems 116
    - Windows NT 116
  - restart 61
  - restarting when stopped 69
  - resync, OS/390 using CICS 361
  - run 110, 429
  - segregating messages 15
  - selecting 430
  - selecting OS/390 using CICS 354
  - sender-receiver 8
  - sequence numbers 59
  - server-connection 7
  - server-receiver 8
  - sharing 14
  - start 61
    - Digital OpenVMS 110, 114
    - OS/2 110, 114
    - OS/390 330



- channel (*continued*)
    - OS/390 using CICS 357
    - OS/400 429, 437
    - Tandem NSK 110, 114
    - UNIX systems 114
    - UNIX Systems 110
    - Windows NT 110, 114
  - startup, data negotiation 61, 506, 507
  - startup negotiation errors 613
  - state 62
  - status 59
  - stopping 67, 438
    - Digital OpenVMS 115
    - OS/2 115
    - OS/390 334
    - OS/390 using CICS 359, 385
    - OS/400 438
    - Tandem NSK 115
    - UNIX systems 115
    - Windows NT 115
  - switching 617
  - synchronizing 361, 506
  - test, OS/390 331
  - transport-retry exit program 517
  - triggering 20, 358
    - OS/2 117
    - OS/390 342
    - OS/390 using CICS 358
    - Tandem NSK 117
    - UNIX systems 117
    - Windows NT 117
  - trusted 121
  - types 81, 111, 119, 352
  - using alternate channels 15
  - working with OS/390 using CICS 354
- CHANNEL attribute 80
- channel attributes 533
- channel auto-definition exit, introduction 12
- channel configuration
  - MQSeries for AIX 210
  - MQSeries for AS/400 471
  - MQSeries for AT&T GIS UNIX 252
  - MQSeries for DIGITAL UNIX (Compaq Tru64 UNIX) 216
  - MQSeries for HP-UX 238
  - MQSeries for OS/2 Warp 163
  - MQSeries for OS/390 405
  - MQSeries for Sun Solaris 272
  - MQSeries for Windows NT 185
- channel control error messages 611
- channel control function 59
  - Digital OpenVMS 105
  - OS/2 105
  - OS/390 321
  - OS/390 using CICS 351
  - OS/400 423
  - Tandem NSK 105
  - UNIX systems 105
  - Windows NT 105
- channel definition file
  - Digital OpenVMS 106
  - OS/2 106
  - OS/390 using CICS 351
  - OS/400 423
  - Tandem NSK 106
- channel definition file (*continued*)
  - UNIX systems 106
  - Windows NT 106
- channel description 84
- channel exit
  - MQCXP structure 591
  - MQTXP structure 605
  - MQXWD structure 609
- channel-exit programs 505, 542
  - channel definition structure, MQCD 518
  - channel-exit programs 529
  - data buffer 518
  - introduction 12
  - MQSeries for AIX 526
  - MQSeries for AS/400 521
  - MQSeries for AT&T GIS UNIX 531
  - MQSeries for Compaq (DIGITAL) OpenVMS 528
  - MQSeries for DIGITAL UNIX (Compaq Tru64 UNIX) 529
  - MQSeries for HP-UX 530
  - MQSeries for OS/2 Warp 522
  - MQSeries for OS/390 using CICS 521
  - MQSeries for OS/390 without CICS 520
  - MQSeries for SINIX and DC/OSx 532
  - MQSeries for Sun Solaris 532
  - MQSeries for Tandem NonStop Kernel 533
  - MQSeries for Windows 526
  - MQSeries for Windows NT 524
- parameter structure, MQCXP 518
- supplied programs, DCE 537
- Windows 3.1 client 524
- Windows 95 and Windows 98 client 524
- Windows NT client 524
- writing and compiling 518
- channel exits
  - auto-definition 516
  - message 514
  - message-retry 516
  - receive 512
  - security 507
  - send 512
  - transport-retry 517
- channel functions
  - Digital OpenVMS 112
  - OS/2 112
  - Tandem NSK 112
  - UNIX systems 112
  - Windows NT 112
- channel initiator
  - display, OS/390 326
  - overview 10
  - retries 65, 85
  - runmqchi command, MQSeries for OS/2 Warp 114
  - runmqchi command, MQSeries for Windows NT 114
  - runmqchi command, MQSeries on UNIX systems 114
  - runmqchi command, Tandem NSK 114
- channel initiator (*continued*)
  - running the MCA as a thread 88
  - start, OS/2, Windows NT, Digital OpenVMS, Tandem NSK, and UNIX systems 118
  - start, OS/390 327
  - start, OS/400 438
  - stop, OS/2, Windows NT, Digital OpenVMS, Tandem NSK, and UNIX systems 118
  - stop, OS/390 328
  - STRMQMCHLI command 438
- channel listener
  - overview 10
  - start, OS/390 329
  - start, OS/400 438
  - stop, OS/390 329
  - STRMQMLSR command 438
  - trusted 12
- channel name attribute 80
- channel planning example
  - Digital OpenVMS 305
  - OS/2 305
  - OS/390 345
  - OS/400 477
  - UNIX systems 305
  - Windows NT 305
- channel planning form, how to use 623
- channel programs
  - Digital OpenVMS 119
  - MQSeries for AS/400 445
  - OS/2 119
  - OS/390 using CICS 351
  - Tandem NSK 119
  - UNIX systems 119
  - Windows NT 119
- channel refuses to run 613
- channel settings panel, OS/390 using CICS 374
- channel startup negotiation errors 613
- channel states
  - BINDING 62
  - INACTIVE 65
  - OS/400 446
- channel status
  - display, Digital OpenVMS 113
  - display, OS/2 113
  - display, OS/390 335
  - display, OS/390 using CICS 364
  - display, OS/400 437
  - display, Tandem NSK 113
  - display, UNIX systems 113
  - display, Windows NT 113
- channel type attribute 81
- ChannelDefinition parameter
  - MQ\_CHANNEL\_AUTO\_DEF\_EXIT call 551
  - MQ\_CHANNEL\_EXIT call 546
- ChannelExitParms parameter
  - MQ\_CHANNEL\_AUTO\_DEF\_EXIT call 551
  - MQ\_CHANNEL\_EXIT call 546
- ChannelName field 558
- channels, alternate to 15
- CHANNELS stanza 637
- ChannelType field 559
- CHLTYPE attribute 81

- CICS
  - CEDA INSTALL command 383
  - installing communication connection 383
  - profile name 81
  - regions 352
  - transaction
    - CEDA 383
    - CKMC 352
    - CKSG 384
- Cisco MultiNet for Digital OpenVMS 279
- CKMC CICS transaction 352
- CKSG CICS transaction 384
- class of routing entry 457
- class of service 47
- client-connection channel 7
- clients, problem determination 617
- CLUSNL attribute 82
- CLUSTER attribute 81
- cluster channels, OS/390 337
- cluster components 6
- cluster name attribute 81
- cluster namelist attribute 82
- cluster-receiver 9
- cluster-receiver channel 7
- cluster-sender 8
- cluster-sender channel 7
- ClusterPtr field 577
- clusters
  - choosing transmission queue 39
  - components 6
  - concentrating messages 44
  - distribution lists 46
  - message flow 35
  - networking considerations 52
  - passing messages 41
  - putting messages 38
  - reply-to queue 47
  - return routing 53
  - separating message flows 42
  - using 16
- ClustersDefined field 578
- command queue channel, OS/390 343
- command validation 71
- commit in-doubt messages
  - Digital OpenVMS 116
  - OS/2 116
  - OS/400 439
  - Tandem NSK 116
  - UNIX systems 116
  - Windows NT 116
- committed messages
  - Digital OpenVMS 116
  - OS/2 116
  - OS/400 439
  - Tandem NSK 116
  - UNIX systems 116
  - Windows NT 116
- communication
  - between CICS systems attached to one queue manager 383
  - between queue managers 381
  - intersystem (ISC) 382
- communications examples
  - ICE 299
  - SNAX 292
- communications examples (continued)
  - TCP/IP 303
- communications Manager/2 128
- Communications Manager/2 127
- Communications Server for AIX V5 202
- Communications Server for Windows NT 174
- communications setup, Tandem NSK 292
- communications side object
  - OS/390 342
  - OS/400 451, 452
- CompCode parameter 553
- components, cluster 6
- components of distributed-queuing environment 13
  - channel initiator 10
  - channel listener 10
  - message channel 7
  - message channel agent 9
  - transmission queue 10
- compression of data 512
- concentrating messages 44
- concentrators 31
- concepts of intercommunication 3, 16, 22
- configuration
  - MQSeries for AIX 209
  - MQSeries for AS/400 471
  - MQSeries for AT&T GIS UNIX 251
  - MQSeries for DIGITAL UNIX (Compaq Tru64 UNIX) 215
  - MQSeries for HP-UX 238
  - MQSeries for OS/2 Warp 162
  - MQSeries for OS/390 405
  - MQSeries for Sun Solaris 271
  - MQSeries for VSE/ESA 490
  - MQSeries for Windows NT 184
- configuration file 73
  - Digital OpenVMS 73
  - OS/2 73
  - SINIX and DC/OSx 311
  - Tandem NSK 73
  - UNIX systems 73
- configuration worksheet 485
- configuring the UDP transport-retry exit 518
- CONNNAME attribute 82
- connection
  - APPC/MVS, OS/390 339
  - deciding upon
    - OS/390 339
    - OS/400 449
  - DECnet Phase IV 285
  - DECnet Phase V 286
  - defining APPC/MVS (LU 6.2) 342
  - defining LU 6.2
    - Digital OpenVMS 281
    - OS/2 126
    - OS/400 451
    - UNIX systems 194
    - Windows NT 126
  - installing 383
  - LU 6.2
    - Digital OpenVMS 277
    - OS/2 123
    - OS/390 339
- connection (continued)
  - LU 6.2 (continued)
    - OS/390 using CICS 382
    - OS/400 449
    - Tandem NSK 289
    - UNIX systems 191
    - Windows NT 123
  - NetBIOS
    - OS/2 123
    - Windows NT 123
  - SPX
    - OS/2 123
    - Windows NT 123
  - switching 617
  - TCP
    - Digital OpenVMS 277
    - OS/2 123
    - OS/390 339
    - OS/400 449
    - Tandem NSK 289
    - UNIX systems 191
    - Windows NT 123
  - UDP
    - UNIX systems 191
- connection name 82
  - for function shipping 383
- ConnectionName field 568
- constants 627
- constants, values of 627
  - channel capability flags (MQCF\_\*) 628
  - channel data conversion (MQCDC\_\*) 628
  - channel definition structure length (MQCD\_\*) 628
  - channel definition structure version (MQCD\_\*) 628
  - channel-exit parameter structure identifier (MQCXP\_\*) 628
  - channel-exit parameter structure version (MQCXP\_\*) 629
  - channel type (MQCHT\_\*) 628
  - exit identifier (MQXT\_\*) 631
  - exit reason (MQXR\_\*) 630
  - exit response (MQXCC\_\*) 630
  - exit user area (MQXUA\_\*) 631
  - exit wait descriptor structure identifier (MQXWD\_\*) 631
  - exit wait descriptor version (MQXWD\_\*) 631
  - lengths of character string and byte fields (MQ\_\*) 627
  - MCA type (MQMCAT\_\*) 629
  - nonpersistent message speed (MQNPMS\_\*) 629
  - put authority (MQPA\_\*) 629
  - secondary exit response (MQXR2\_\*) 630
  - security identifier (MQSID\_\*) 629
  - security identifier type (MQSIDT\_\*) 630
  - transmission protocol type (MQXPT\_\*) 630
  - transport retry exit structure identifier (MQTXP\_\*) 630
  - transport retry exit version (MQTXP\_\*) 630

- context security 91
- control commands, channel 60
- conversion failure, problem determination 615
- conversion of data 59
- CONVERT attribute 83
- convert message 83
- coordination with adjacent systems 44
- Copy option 367, 436
- Create option 368, 435
- creating
  - channel
    - Digital OpenVMS 109
    - OS/2 109
    - OS/390 using CICS 356
    - OS/400 426
    - Tandem NSK 109
    - UNIX systems 109
    - Windows NT 109
  - defaults 369, 435
  - objects
    - Digital OpenVMS 108
    - OS/2 108
    - OS/400 426
    - Tandem NSK 108
    - UNIX systems 108
    - Windows NT 108
  - queues 117, 441
  - transmission queue 117, 441
- CRTCSI command 452
- CRTMQM command 109
- current channels
  - specifying maximum number 64

## D

- data
  - compression 512
  - conversion 514
  - decompression 512
  - encryption 514
  - negotiation 20, 60
- data conversion 75
- data types, detailed description
  - MQCD 556
  - MQCXP 591
  - MQTXP 605
  - MQXWD 609
- DataConversion field 565
- DataId field 607
- DataLength field 607
- DataLength parameter 546
- DCE
  - supplied exit programs 537
- dead-letter queue 52
- Digital OpenVMS 119
- MQSeries for AS/400 447
- OS/2 119
- overview 13
- problem determination 612
- processing 612
- Tandem NSK 119
- UNIX systems 119
- Windows NT 119
- DECnet Phase IV 277
- DECnet Phase IV connection 285
- DECnet phase V connection 286

- decompression of data 512
- default channel values
  - OS/390 using CICS 369, 372
  - OS/400 435
- default object creation 108
- define channel
  - OS/390 324
- defining
  - an LU 6.2 connection
    - Digital OpenVMS 281
    - OS/2 126
    - OS/400 451
    - UNIX systems 194
    - Windows NT 126
  - APPC/MVS (LU 6.2) connection
    - OS/390 342
  - objects 384
    - OS/390 342
  - OS/390 324
  - OS/390 using CICS 372
  - queues 384
    - OS/390 342
- definition file
  - data 544
  - Digital OpenVMS 106
  - OS/2 106
  - OS/390 using CICS 351
  - OS/400 423
  - Tandem NSK 106
  - UNIX systems 106
  - Windows NT 106
- delete channel
  - distributed platforms 113
  - OS/390 326
  - OS/390 using CICS 370
  - OS/400 437
- delivery, messages 22
- Desc field 560
- DESCR attribute 84
- description, channel 84
- DestAddress parameter 555
- DestAddressLength parameter 555
- destination queue 42
- dial-up support 615
- Digital TCP/IP services for OpenVMS 278
- disabled receiver channels 114, 437
- disaster recovery 616
- DISCINT attribute 84
- DiscInterval field 562
- disconnect interval 84
- display
  - option 437
  - OS/390, DQM 326
  - settings 365
  - status 364
- display channel
  - Digital OpenVMS 110
  - OS/2 110
  - OS/390 325
  - OS/400 437
  - Tandem NSK 110
  - UNIX systems 110
  - Windows NT 110
- display channel initiator
  - OS/390 326

- display channel status
  - OS/390 335
- Display channel status
  - Digital OpenVMS 110
  - OS/2 110
  - Tandem NSK 110
  - UNIX systems 110
  - Windows NT 110
- display DQM 326
- display settings 365
- display status 364
- distributed queuing
  - components 7, 13
  - functions 57
- distributed queuing in OS/390 using CICS 381
- distributed-queuing management in MQSeries for AS/400 441
- distribution lists 46, 59
- diverting message flows 45
- DQM
  - display, OS/390 326
- DQM panels
  - OS/390 using CICS 352

## E

- ECB field 610
- edit
  - alter, OS/390 using CICS 370
  - change
    - Digital OpenVMS 113
    - OS/2 113
    - OS/400 436
    - Tandem NSK 113
    - UNIX systems 113
    - Windows NT 113
  - copy
    - OS/390 using CICS 367
    - OS/400 436
  - create
    - Digital OpenVMS 113
    - OS/2 113
    - OS/390 using CICS 368
    - OS/400 435
    - Tandem NSK 113
    - UNIX systems 113
    - Windows NT 113
  - delete
    - Digital OpenVMS 113
    - OS/2 113
    - OS/390 using CICS 370
    - OS/400 437
    - Tandem NSK 113
    - UNIX systems 113
    - Windows NT 113
  - find
    - OS/390 using CICS 370
  - menu-bar choice
    - OS/390 using CICS 367
  - pull-down menu 367
  - enabling a channel to transmit messages 61
  - encryption of messages 505
  - end 115
  - End option 438
  - ending a channel 115, 438

- ending SNA Listener process 284
- ENDMQLSR command 119
- error
  - at remote sites 611
  - channel 65
  - logs 115, 618
  - message from channel control 611
  - recovery 611
- example
  - channel planning
    - Digital OpenVMS 305
    - OS/2 305
    - OS/390 345
    - OS/400 477
    - UNIX systems 305
    - Windows NT 305
  - communications setup
    - Tandem NSK 292
  - configuration file, SINIX and DC/OSx 311
  - configurations 97, 98
  - flow control 35
  - local queue definition
    - Digital OpenVMS 308
    - OS/2 308
    - OS/390 348
    - OS/400 480
    - Tandem NSK 308
    - UNIX systems 308
    - Windows NT 308
  - process definition
    - Digital OpenVMS 307, 309
    - OS/2 307, 309
    - OS/390 347, 348
    - OS/400 479, 481
    - Tandem NSK 307, 309
    - UNIX systems 307, 309
    - Windows NT 307, 309
  - receiver channel definition
    - Digital OpenVMS 308, 309
    - OS/2 308, 309
    - OS/390 347, 348
    - OS/400 480, 481
    - Tandem NSK 308, 309
    - UNIX systems 308, 309
    - Windows NT 308, 309
  - remote queue definition
    - Digital OpenVMS 307
    - OS/2 307
    - OS/390 346
    - OS/400 478
    - Tandem NSK 307
    - UNIX systems 307
    - Windows NT 307
  - reply-to queue definition
    - Digital OpenVMS 308
    - OS/2 308
    - OS/390 347
    - OS/400 480
    - Tandem NSK 308
    - UNIX systems 308
    - Windows NT 308
  - running
    - Digital OpenVMS 309
    - OS/2 309
    - OS/390 349
    - OS/400 482
- example (*continued*)
  - running (*continued*)
    - Tandem NSK 309
    - UNIX systems 309
    - Windows NT 309
  - sender channel definition
    - Digital OpenVMS 308, 309
    - OS/2 308, 309
    - OS/390 347, 348
    - OS/400 479, 481
    - Tandem NSK 308, 309
    - UNIX systems 308, 309
    - Windows NT 308, 309
  - transmission queue definition
    - Digital OpenVMS 307, 308
    - OS/2 307, 308
    - OS/390 347, 348
    - OS/400 479, 481
    - Tandem NSK 307, 308
    - UNIX systems 307, 308
    - Windows NT 307, 308
- example configurations
  - MQSeries for AIX 197, 214
  - MQSeries for AS/400 459, 476
  - MQSeries for AT&T GIS UNIX 243, 257
  - MQSeries for Digital OpenVMS 277, 289
  - MQSeries for DIGITAL UNIX (Compaq Tru64 UNIX) 215, 219
  - MQSeries for HP-UX 219, 243
  - MQSeries for OS/2 Warp 137, 168
  - MQSeries for OS/390 395, 419
  - MQSeries for Sun Solaris 257, 277
  - MQSeries for Windows NT 169, 189
- examples
  - alias walk-through 51
  - channel initiators 10
  - channel listeners 10
  - channel names 30
  - channel planning
    - for distributed platforms 305
    - for OS/390 345
    - for OS/390 using CICS 387
    - for OS/400 477
  - choosing the transmission queue 39
  - cluster of queue managers 6
  - communication in MQSeries for AS/400, TCP connection 449
  - concentrating messages 44
  - configuration file on bight 312
  - configuration file on forties 313
  - configuration files
    - for Pyramid DC/OSx 313
    - SINIX and DC/OSx 311
  - create channel 109
  - creating reply-to aliases 36
  - defining channels 18
  - defining queues 19
  - defining remote queue definitions 36
  - display channel 110
  - display channel status 110
  - diverting message flows 45
  - message channels
    - cluster-receiver 9
    - cluster-sender 8
    - requester-sender 9
- examples (*continued*)
  - message channels (*continued*)
    - requester-server 9
    - sender-receiver 8
  - MQSeries for AIX configuration 197
  - MQSeries for AS/400
    - configuration 459
  - MQSeries for AT&T GIS UNIX
    - configuration 243
  - MQSeries for HP-UX
    - configuration 219
  - MQSeries for OS/2 Warp
    - configuration 137
  - MQSeries for OS/390
    - configuration 395
  - MQSeries for Sun Solaris
    - configuration 257
  - MQSeries for VSE/ESA
    - configuration 485
  - MQSeries for Windows NT
    - configuration 169
  - multi-hopping 14
  - passing messages through system 41
  - passing through intermediate queue managers 14
  - putting messages on remote queues 38
  - QM-concentrators 31
  - queue name resolution 54
  - receiving messages 40
  - renaming a channel 111
  - reply-to queue 47, 48
  - reply-to-queue alias 28
  - sending messages 5, 17
  - sending messages in both directions 5
  - separating message flows 42
  - setting up communication for OS/2 and Windows NT
    - defining a NetBIOS connection 128
    - defining a TCP connection 124
    - defining an LU 6.2 connection 126
    - defining an SPX connection 131
  - setting up communication in Digital OpenVMS
    - defining a DECnet Phase IV connection 285
    - defining a DECnet Phase V connection 286
    - defining an LU 6.2 connection 281
  - setting up communication in MQSeries for OS/390
    - LU 6.2 connection 342
    - TCP connection 339
  - setting up communication in Tandem NSK
    - SNA channels 289
    - TCP channels 291
  - setting up communication in UNIX systems
    - defining a TCP connection 191
    - defining an LU 6.2 connection 194



- examples (*continued*)
  - setting up communications in Digital OpenVMS
    - defining a TCP connection 278
    - sharing a transmission queue 14
  - SINIX and DC/OSx configuration files 311
  - starting a channel 110, 429
  - triggering 21, 118
  - using multiple channels 15
  - using the remote queue definition object 37
- exit 366
- exit wait descriptor structure 609
- ExitBufferAddr parameter 548
- ExitBufferLength parameter 548
- ExitData field 599
- ExitDataLength field 574
- ExitId field 592
- ExitNameLength field 574
- ExitNumber field 601
- ExitParms parameter 555
- EXITPATH
  - stanza of qm.ini file 637
- ExitReason field
  - MQCXP structure 593
  - MQTXP structure 606
- ExitResponse field
  - MQCXP structure 595
  - MQTXP structure 607
- ExitResponse2 field 596
- exits
  - constants 627
- ExitUserArea field
  - MQCXP structure 598
  - MQTXP structure 606

## F

- FAPLevel field 601
- fast, nonpersistent messages 22
  - sequence of retrieval 56
  - specifying 90
- Feedback field
  - MQCXP structure 598
  - MQTXP structure 608
- fields
  - BatchInterval 573
  - BatchSize 562
  - CapabilityFlags 601
  - ChannelName 558
  - ChannelType 559
  - ClusterPtr 577
  - ClustersDefined 578
  - ConnectionName 568
  - DataConversion 565
  - DataId 607
  - DataLength 607
  - Desc 560
  - details of receiver channel panel 377
  - details of requester channel settings panel 379
  - details of sender channel settings 376
  - details of server channel settings panel 378
  - DiscInterval 562
  - ECB 610

- fields (*continued*)
  - ExitData 599
  - ExitDataLength 574
  - ExitId 592
  - ExitNameLength 574
  - ExitNumber 601
  - ExitReason
    - MQCXP structure 593
    - MQTXP structure 606
  - ExitResponse
    - MQCXP structure 595
    - MQTXP structure 607
  - ExitResponse2 596
  - ExitUserArea
    - MQCXP structure 598
    - MQTXP structure 606
  - FAPLevel 601
  - Feedback
    - MQCXP structure 598
    - MQTXP structure 608
  - GroupId 607
  - HeaderLength 600
  - HeartbeatInterval 572
  - LongMCAUserIdLength 578
  - LongMCAUserIdPtr 579
  - LongRemoteUserIdLength 578
  - LongRemoteUserIdPtr 579
  - LongRetryCount 563
  - LongRetryInterval 563
  - MaxMsgLength 565
  - MaxSegmentLength 598
  - MCAName 561
  - MCASecurityId 579
  - MCAType 568
  - MCAUserIdentifier 567
  - ModeName 561
  - MsgExit 563
  - MsgExitPtr 575
  - MsgExitsDefined 574
  - MsgRetryCount
    - MQCD structure 571
    - MQCXP structure 599
  - MsgRetryExit 570
  - MsgRetryInterval
    - MQCD structure 572
    - MQCXP structure 599
  - MsgRetryReason 600
  - MsgRetryUserData 570
  - MsgUserData 566
  - MsgUserDataPtr 575
  - NetworkPriority 578
  - NonPersistentMsgSpeed 573
  - PartnerName 600
  - Password 567
  - PutAuthority 565
  - QMgrName 561
  - ReceiveExit 564
  - ReceiveExitPtr 577
  - ReceiveExitsDefined 575
  - ReceiveUserData 566
  - ReceiveUserDataPtr 577
  - RemotePassword 569
  - RemoteSecurityId 579
  - RemoteUserIdentifier 569
  - Reserved 606
  - Reserved1 609
  - Reserved2 609

- fields (*continued*)
  - Reserved3 610
  - RetryCount 607
  - SecurityExit 563
  - SecurityUserData 565
  - SendExit 564
  - SendExitPtr 576
  - SendExitsDefined 575
  - SendUserData 566
  - SendUserDataPtr 576
  - SeqNumberWrap 564
  - SessionId 607
  - ShortConnectionName 561
  - ShortRetryCount 562
  - ShortRetryInterval 562
  - StrucId
    - MQCXP structure 591
    - MQTXP structure 605
    - MQXWD structure 609
  - StrucLength 574
  - TpName 562
  - TransportType
    - MQCD structure 560
    - MQTXP structure 606
  - UserIdentifier 566
  - Version
    - MQCD structure 558
    - MQCXP structure 592
    - MQTXP structure 605
    - MQXWD structure 609
  - XmitQName 561
- find option 370
- flow control 35
- function keys
  - OS/390 using CICS 353
- function shipping 383
- functions available
  - Digital OpenVMS 106
  - OS/2 106
  - Tandem NSK 106
  - UNIX systems 106
  - Windows NT 106

## G

- glossary 645
- GroupId field 607

## H

- HBINT attribute 85
- Hconn parameter 553
- HeaderLength field 600
- heartbeat interval 85
- HeartbeatInterval field 572
- help
  - OS/390 using CICS 372
  - pull-down menus 372, 373
- help menu-bar choice 372, 373
- how to use
  - channel planning form 623
- HTML (Hypertext Markup Language) 662
- Hypertext Markup Language (HTML) 662

## I

- IBM Communications Server for Windows NT 174
- ICE communications example 299
- in-doubt 80
- in-doubt channels, manual resynchronization 69
- in-doubt message on channel, resolve on OS/390 333
- in-doubt messages, commit or back out
  - Digital OpenVMS 116
  - OS/2 116
  - OS/400 439
  - Tandem NSK 116
  - UNIX systems 116
  - Windows NT 116
- INACTIVE channel state 62, 65
- ini file 73
- initial data negotiation 20, 61
- initialization data set, OS/390 without CICS 73
- initialization file 73
- initiator for channel
  - AIX, OS/2, HP-UX, Sun Solaris, and Windows NT 118
  - OS/390 327
- installing
  - CICS communication connection 383
- integrity of delivery 22
- intercommunication
  - concepts 3, 16, 22
  - example 485
  - example configuration 97
- intercommunication example 485, 503
- intercommunication examples
  - MQSeries for AIX 197
  - MQSeries for AS/400 459
  - MQSeries for AT&T GIS UNIX 243
  - MQSeries for DIGITAL UNIX (Compaq Tru64 UNIX) 215
  - MQSeries for HP-UX 219
  - MQSeries for OS/2 Warp 137
  - MQSeries for OS/390 395
  - MQSeries for Sun Solaris 257
  - MQSeries for VSE/ESA 485
  - MQSeries for Windows NT 169
- interfaces
  - Interlink SNSTCPAccess 344
  - IUCV 344
- Interlink SNSTCPAccess interface 344
- intersystem communication (ISC) 381
- ISC (intersystem communication) 381
- IUCV interface 344

## J

- journaling 514

## K

- KEEPALIVE 66
  - OS/2 132, 162
- keyboard functions
  - function keys
    - OS/390 using CICS 353
    - OS/390 using CICS clear key 354

- keyboard functions *(continued)*

- OS/390 using CICS *(continued)*

- enter key 354
- unassigned keys and unavailable choices 354

## L

- links, wide-band 31
- list cluster channels, OS/390 337
- listener, trusted 10, 12, 121
- listening on LU 6.2
  - OS/2 127
  - OS/390 342
  - UNIX systems 195
  - Windows NT 127
- listening on NetBIOS
  - OS/2 131
  - Windows NT 131
- listening on SPX
  - OS/2 132, 162
  - Windows NT 132, 183
- listening on TCP
  - Digital OpenVMS 278
  - OS/2 124
  - OS/390 340
  - OS/400 450
  - UNIX systems 192
  - Windows NT 124
- local queue definition
  - example
    - Digital OpenVMS 308
    - OS/2 308
    - OS/390 348
    - OS/400 480
    - Tandem NSK 308
    - UNIX systems 308
    - Windows NT 308
- local queue manager 3
- location name 42
- log
  - error 115, 618
  - file, @SYSTEM 618
  - logs for errors 115
  - long retry count attribute 85
  - long retry interval attribute 85
  - LongMCAUserIdLength field 578
  - LongMCAUserIdPtr field 579
  - LongRemoteUserIdLength field 578
  - LongRemoteUserIdPtr field 579
  - LongRetryCount field 563
  - LongRetryInterval field 563
  - LONGRTY attribute 85
  - LONGTMR attribute 85
  - loopback testing 56
- LU 6.2
  - mode name 86
  - responder processes 291
  - settings
    - OS/2 126
    - OS/400 451
    - UNIX systems 194
    - Windows NT 126
  - TP name 86
- LU 6.2 connection
  - MQSeries for AIX 197
  - MQSeries for AS/400 459

- LU 6.2 connection *(continued)*

- MQSeries for AT&T GIS UNIX 243
- MQSeries for Digital OpenVMS 277
- MQSeries for HP-UX 219
- MQSeries for OS/2 Warp 137
- MQSeries for OS/390 395
- MQSeries for OS/390 with CICS 381, 402
- MQSeries for OS/390 without CICS 400
- MQSeries for Sun Solaris 257
- MQSeries for Tandem NSK 289
- MQSeries for VSE/ESA 485
- MQSeries for Windows NT 169

- setting up
  - OS/2 123
  - OS/390 342
  - OS/390 using CICS 382
  - OS/400 449
  - UNIX systems 191
  - Windows NT 123

- LU62

- stanza of qm.ini file 637

## M

- maximum
  - active channels 64
  - current channels 64
  - message length 87
  - transmission size 87
- MAXMSGL attribute 87
- MaxMsgLength field 565
- MaxSegmentLength field 598
- MCA
  - caller 9
  - name 87
  - responder 9
  - type 88
  - user 88
  - user-written 75
- MCANAME attribute 87
- MCANAME field 561
- MCASecurityId field 579
- MCAATYPE attribute 88
- MCAType field 568
- MCAUSER attribute 88
- MCAUserIdentifier field 567
- message
  - committed
    - Digital OpenVMS 116
    - OS/2 116
    - OS/400 439
    - Tandem NSK 116
    - UNIX systems 116
    - Windows NT 116
  - concentrating 44
  - converting 83
  - diverting flows 45
  - encryption 505
  - error 611
  - for distribution list 46
  - passing through system 41
  - putting on remote queue 37
  - queue name translations 53
  - receiving 40
  - return routing 53

- message (*continued*)
  - return to sender 72
  - routing 39
  - sending and receiving 58
  - separating flows 42
  - sequence numbering 54
  - sequential retrieval 55
  - splitting 59
  - undeliverable 71
- message channel
  - cluster-receiver 7, 9
  - cluster-sender 7, 8
  - receiver 7
  - requester 7
  - requester-sender 9
  - requester-server 9
  - sender 7
  - sender-receiver 8
  - server 7
  - server-receiver 8
- message channel agent
  - caller 9
  - initiation 507, 512
  - responder 9
  - security 91
  - termination 507, 512
  - user-written 75
- message channel agent (MCA) 9, 57
- message channels
  - list panel
    - OS/390 using CICS 353
- message exit 12
- message exit name 88
- message exit program 514
  - overview 506
- message exit user data 89
- message flow control 35
  - networking considerations 52
- message retry 72
- message-retry exit
  - introduction 12
  - name 89
  - retry count 89
  - retry interval 89
  - user data 89
- message-retry exit program 516
- messages
  - assured delivery 22
  - back out in-doubt messages
    - OS/400 439
  - commit in-doubt messages
    - OS/400 439
  - resolve in-doubt messages
    - OS/400 439
  - sending 17
- Messages
  - back out in-doubt messages 116
  - commit in-doubt messages 116
  - resolve in-doubt messages 116
- messages and codes 71
- mode name 86
- MODENAME attribute 86
- ModeName field 561
- monitoring and controlling channels
  - Digital OpenVMS systems 105
  - OS/2 105
  - OS/390 321
- monitoring and controlling channels (*continued*)
  - OS/390 using CICS 351
  - OS/400 423
  - Tandem NSK 105
  - UNIX systems 105
  - Windows NT 105
- monitoring channels 60
- moving service component 4
- MQ\_\* values 627
- MQ\_CHANNEL\_AUTO\_DEF\_EXIT call 551
- MQ\_CHANNEL\_EXIT call 546
- MQ\_TRANSPORT\_EXIT call 555
- MQCD, channel definition structure 518
- MQCD structure 556
- MQCXP\_\* values 591
- MQCXP, channel exit parameter structure 518
- MQCXP structure 591
- MQFB\_\* values 598
- MQI channels 7
- MQIBindType 121
- MQRMH, reference-message header 515
- mqs.ini 74
- MQSeries for AIX
  - channel configuration 210
  - channel-exit programs 526
  - configuration 209
  - intercommunication example 197, 214
  - LU 6.2 connection 197
  - TCP connection 209
  - UDP connection 209
- MQSeries for AS/400
  - channel configuration 471
  - channel-exit programs 521
  - configuration 471
  - intercommunication example 459, 476
  - LU 6.2 connection 459
  - TCP connection 469
- MQSeries for AT&T GIS UNIX
  - channel configuration 252
  - channel-exit programs 531
  - configuration 251
  - intercommunication example 243, 257
  - LU 6.2 connection 243
  - TCP connection 251
- MQSeries for Digital OpenVMS
  - channel-exit programs 528
  - problem solving 285
  - setting up communication 277
  - SNA configuration 281
- MQSeries for DIGITAL UNIX (Compaq Tru64 UNIX)
  - channel configuration 216
  - configuration 215
  - intercommunication example 215
  - TCP connection 215
- MQSeries for HP-UX
  - channel configuration 238
  - channel-exit programs 530
  - configuration 238
  - intercommunication example 219, 243
- MQSeries for HP-UX (*continued*)
  - LU 6.2 connection 219
  - TCP connection 237
- MQSeries for OS/2 Warp
  - channel configuration 163
  - channel-exit programs 522
  - configuration 162
  - intercommunication example 137, 168
  - LU 6.2 connection 137
  - NetBIOS connection 160
  - SPX connection 160
  - TCP connection 158
- MQSeries for OS/390
  - channel configuration 405
  - configuration 405
  - intercommunication example 395, 419
  - LU 6.2 connection 395
  - reset channel sequence numbers 332
  - resolving in-doubt message on channel 333
  - TCP connection 404
- MQSeries for OS/390 using CICS
  - channel-exit programs 521
- MQSeries for OS/390 without CICS
  - channel-exit programs 520
- MQSeries for SINIX and DC/OSx
  - channel-exit programs 532
- MQSeries for Sun Solaris
  - channel configuration 272
  - channel-exit programs 532
  - configuration 271
  - intercommunication example 257, 277
  - LU 6.2 connection 257
  - TCP connection 271
- MQSeries for Tandem NonStop Kernel
  - channel-exit programs 533
  - setting up communication 289
- MQSeries for VSE/ESA
  - channel configuration 490
  - configuration worksheet 485
  - LU 6.2 connection 485
- MQSeries for Windows 104
  - channel-exit programs 526
- MQSeries for Windows NT
  - channel configuration 185
  - channel-exit programs 524
  - configuration 184
  - intercommunication example 169, 189
  - LU 6.2 connection 169
  - NetBIOS connection 181
  - SPX connection 182
  - TCP connection 181
- MQSeries publications 659
- MQSINI 74
- MQTXP\_\* values 605
- MQTXP structure 605
- MQXCC\_\* values
  - MQCXP structure 595
  - MQTXP structure 607
- MQXQH, transmission header 515, 516
- MQXR\_\* values
  - MQCXP structure 593

- MQXR\_\* values (*continued*)
  - MQTXP structure 606
- MQXR2\_\* values 596
- MQXT\_\* values 592
- MQXUA\_\* values
  - MQCXP structure 606
  - MQTXP structure 598
- MQXWAIT call 553
- MQXWD\_\* values 609
- MQXWD structure 609
- MRDATA attribute 89
- MREXIT attribute 89
- MRO (multiregion operation) 381
- MRRTY attribute 89
- MRTMR attribute 89
- MSGDATA attribute 89
- MSGEXIT attribute 88
- MsgExit field 563
- MsgExitPtr field 575
- MsgExitsDefined field 574
- MsgRetryCount field
  - MQCD structure 571
  - MQCXP structure 599
- MsgRetryExit field 570
- MsgRetryInterval field
  - MQCD structure 572
  - MQCXP structure 599
- MsgRetryReason field 600
- MsgRetryUserData field 570
- MsgUserData field 566
- MsgUserDataPtr field 575
- multi-hopping 14
- multiple message channels per transmission queue
  - Digital OpenVMS 120
  - OS/2 120
  - OS/390 using CICS 384
  - OS/400 447
  - Tandem NSK 120
  - UNIX systems 120
  - Windows NT 120
- multiple queue managers 127
- multiregion operation (MRO) 381

## N

- name resolution
  - conflicts 53
  - convention 52
  - description 633
  - introduction 26
  - location 42
  - queue name translations 53
  - restriction 48
- NDF file configuration 128
- negotiations on startup 61, 613
- NetBIOS 4, 128
- NETBIOS
  - stanza of qm.ini file 637
- NetBIOS, example configurations 98
- NetBIOS connection
  - MQSeries for OS/2 Warp 160
  - MQSeries for Windows NT 181
  - OS/2 123
  - Windows NT 123
- NetBIOS products, in example configurations 98
- network-connection priority 90

- network infrastructure, example configurations 98
- network planner 31
- networking 41
- networking considerations 52
- NetworkPriority field 578
- networks 29
- node centric 36
- nonpersistent message speed 90
- NonPersistentMsgSpeed field 573

## O

- objects
  - creating
    - default 108
    - Digital OpenVMS 108
    - OS/2 108
    - OS/400 426
    - Tandem NSK 108
    - UNIX systems 108
    - Windows NT 108
  - defining 384
    - OS/390 342
  - security 120, 447
- operator commands
  - OS/400 424
- options
  - alter 370
  - change 436
  - copy 367, 436
  - create 368, 435
  - display 437
  - display settings 365
  - display status 364, 437
  - end 438
  - exit 366, 373
  - find 370
  - ping 366, 437
  - reset 362, 439
  - resolve 116, 363
    - OS/400 439
  - resync 361
  - save 373
  - start 357, 437
  - stop
    - OS/390 using CICS 359
- OS/390 connections
  - connecting systems 381
  - LU 6.2 381

## P

- panel data, validation 71
- panels
  - browsing a channel
    - OS/400 430
  - channel start
    - OS/400 437
  - creating a channel
    - OS/400 426
  - display
    - channel status 364
    - OS/400 437
  - display channel status 437
  - display settings
    - message channel list 365

- panels (*continued*)
  - display status
    - message channel list 364
  - edit menu-bar options
    - message channel list 367
  - ending channel
    - OS/400 438
  - exit
    - message channel list 366
  - exit from 373
  - help menu-bar choice, message channel list 372
  - OS/390 using CICS, message channel list 354
  - OS/400
    - resolve 439
    - work with status 437
  - ping
    - message channel list 366
    - OS/400 437
  - receiver channel settings 377
  - reset
    - message channel list 362
    - OS/400 439
  - resolve
    - message channel list 363
  - resync
    - message channel list 361
  - selecting a channel
    - OS/400 430
  - starting channel
    - message channel list 357
  - stopping channel
    - message channel list 359
  - using, OS/390 322
  - view menu-bar choice
    - message channel list 371
  - work-with-channel choices
    - OS/400 434
  - Work with channel status
    - OS/400 432
- parameters
  - AgentBuffer 547
  - AgentBufferLength 547
  - ChannelDefinition
    - MQ\_CHANNEL\_AUTO\_DEF\_EXIT call 551
    - MQ\_CHANNEL\_EXIT call 546
  - ChannelExitParms
    - MQ\_CHANNEL\_AUTO\_DEF\_EXIT call 551
    - MQ\_CHANNEL\_EXIT call 546
  - CompCode 553
  - DataLength 546
  - DestAddress 555
  - DestAddressLength 555
  - ExitBufferAddr 548
  - ExitBufferLength 548
  - ExitParms 555
  - Hconn 553
  - Reason 553
  - WaitDesc 553
- parameters, receiving 59
- PartnerName field 600
- password 90
- Password field 567
- PAUSED channel state 62, 66



- PDF (Portable Document Format) 662
  - ping 366, 437
    - Digital OpenVMS 113
    - OS/2 113
    - problem determination 611
    - Tandem NSK 113
    - UNIX systems 113
    - Windows NT 113
  - ping channel
    - OS/390 331
  - ping with LU 6.2 114, 437
  - planning
    - message channel planning example
      - OS/390 using CICS 387
  - planning form 623
  - port
    - in qm.ini file 637
  - MQSeries for AIX 203
  - MQSeries for Digital OpenVMS 278
  - MQSeries for HP-UX 225
  - MQSeries for OS/2 124
  - MQSeries for OS/390 327, 405
  - MQSeries for VSE/ESA 500
  - MQSeries for Windows NT 124
  - Tandem NSK 303
  - Portable Document Format (PDF) 662
  - PostScript format 662
  - preparation
    - getting started
      - Digital OpenVMS 108
      - OS/2 108
      - OS/400 426
      - Tandem NSK 108
      - UNIX systems 108
      - Windows NT 108
  - preparing channels 60
  - preparing MQSeries for AS/400 441
  - problem determination 611
    - channel refuses to run 613
    - channel startup negotiation
      - errors 613
    - channel switching 617
    - clients 617
    - connection switching 617
    - conversion failure 615
    - data structures 616
    - dead-letter queue 612
    - error messages 611
    - retrying the link 615
    - scenarios 611
    - transmission queue overflow 612
    - triggered channels 614
    - undelivered-message queue 612
    - user-exit programs 616
    - using the PING command 611
    - validation checks 612
  - process definition
    - example
      - Digital OpenVMS 309
      - OS/2 309
      - OS/390 348
      - OS/400 481
      - Tandem NSK 309
      - UNIX systems 309
      - Windows NT 309
  - process definition example (continued)
    - OS/2 307
    - OS/390 347
    - OS/400 479
    - Tandem NSK 307
    - UNIX systems 307
    - Windows NT 307
  - process definition for triggering
    - Digital OpenVMS 117
    - OS/2 117
    - OS/390 343
    - OS/390 using CICS 358, 384
    - OS/400 443
    - Tandem NSK 117
    - UNIX systems 117
    - Windows NT 117
  - process security 91
  - processing problems 71
  - profile name, CICS 81
  - programs
    - AMQCRCTA 445
    - AMQCRS6A 119
    - AMQCRSTA 119, 445
    - AMQRMCLA 445
    - RUNMQCHI 119
    - RUNMQCHL 119
    - RUNMQLSR 119
  - publications
    - MQSeries 659
    - related 662
  - pull-down menus
    - channel 373
    - edit 367
    - help (channel definition panels) 373
    - help (message channel list panel) 372
    - selected 357
    - view 371
  - PUT authority 90
  - PUTAUT attribute 90
  - PutAuthority field 565
  - putting messages 37
    - on remote queues 37
    - to distribution lists 46
- ## Q
- qm.ini 74
    - stanzas used for distributed queuing 637
  - QMgrName field 561
  - QMINI 74
  - QMINI file
    - stanzas used for distributed queuing 637
  - QMNAME attribute 91
  - queue
    - destination 42
    - reply-to 47
  - queue manager
    - alias 25, 36
      - receiving 40
    - interconnection procedure
      - example 387
    - multiple 124
    - name 91
      - alias 42
    - types 3
  - queue manager alias 25, 36
    - introduction 26
    - receiving 40
  - queue name
    - resolution 633
      - how it works 636
      - what is it? 635
    - translations 53
  - queues
    - create a transmission queue 117, 441
    - defining 384
      - OS/390 342
  - quiescing channels 67
- ## R
- RCVDATA attribute 92
  - RCVEXIT attribute 91
  - Reason parameter 553
  - receive exit 12
    - name 91
    - program 512
    - user data 92
  - ReceiveExit field 564
  - ReceiveExitPtr field 577
  - ReceiveExitsDefined field 575
  - receiver
    - channel 7
      - channel definition example
        - Digital OpenVMS 308
        - OS/2 308
        - OS/390 347
        - OS/400 480
        - Tandem NSK 308
        - UNIX systems 308
        - Windows NT 308
      - channel panel
        - details 377
      - panel settings
        - OS/390 using CICS 377
    - receiver channel definition
      - example
        - Digital OpenVMS 309
        - OS/2 309
        - OS/390 348
        - OS/400 481
        - Tandem NSK 309
        - UNIX systems 309
        - Windows NT 309
      - overview 5
    - ReceiveUserData field 566
    - ReceiveUserDataPtr field 577
    - receiving
      - messages 40, 58
      - on DECnet Phase IV 286
      - on LU 6.2
        - OS/2 127
        - OS/390 342
        - Tandem NSK 291
        - UNIX systems 195
        - Windows NT 127
      - on SPX
        - OS/2 132, 162
        - Windows NT 132, 183
      - on TCP
        - Digital OpenVMS 278
        - OS/2 124
        - OS/390 340

- receiving (*continued*)
  - OS/400 450
  - Tandem NSK 304
  - UNIX systems 192
  - Windows NT 124
- receiving messages 40, 58
- receiving on DECnet Phase IV 286
- receiving on LU 6.2
  - OS/2 127
  - OS/390 342
  - Tandem NSK 291
  - UNIX systems 195
  - Windows NT 127
- receiving on SPX
  - OS/2 132, 162
  - Windows NT 132, 183
- receiving on TCP
  - Digital OpenVMS 278
  - OS/2 124
  - OS/390 340
  - OS/400 450
  - Tandem NSK 304
  - UNIX systems 192
  - Windows NT 124
- reference-message header
  - message exit program 515
- registry 73, 74, 126, 129, 135, 182, 524
- remote queue definition 36
  - example
    - Digital OpenVMS 307
    - OS/2 307
    - OS/390 346
    - OS/400 478
    - Tandem NSK 307
    - UNIX systems 307
    - Windows NT 307
  - introduction 15, 25
  - what it is 14
- remote queue manager 3
- RemotePassword field 569
- RemoteSecurityId field 579
- RemoteUserIdentifier field 569
- renaming a channel
  - Digital OpenVMS 111
  - OS/2 111
  - OS/390 using CICS 357
  - OS/400 432
  - Tandem NSK 111
  - UNIX systems 111
  - Windows NT 111
- reply-to alias 36
- reply-to queue 47
  - alias definition 28
  - alias example 48
  - aliases 25
  - preparing for 29
  - specifying 28
- reply-to queue definition
  - example
    - Digital OpenVMS 308
    - OS/2 308
    - OS/390 347
    - OS/400 480
    - Tandem NSK 308
    - UNIX systems 308
    - Windows NT 308
- requester channel 7
  - requester channel settings panel, details 379
  - REQUESTING channel state 62
  - Reserved field 606
  - Reserved1 field 609
  - Reserved2 field 609
  - Reserved3 field 610
  - reset 116, 362, 439
  - RESET CHANNEL command 614
  - reset channel sequence numbers, OS/390 332
  - resolve 363
  - RESOLVE CHANNEL command 613
  - resolve in-doubt message on channel, OS/390 333
  - resolve in-doubt messages 116
    - OS/400 439
  - resolve option 116
    - OS/400 439
  - responder
    - LU6.2 78, 114, 291
    - MCA 9
  - responder MCA 9
  - responder process 78, 114, 291
  - restarting
    - channels 61
  - restarting stopped channels 69
  - resync 361
  - RETRY channel state 62, 65
  - retry considerations 615
  - RetryCount field 607
  - retrying the link, problem determination 615
  - return routing 53
  - return to sender 72
  - reusing exit programs 533
  - routing entry
    - add 456
    - class 457
  - routing entry class 457
  - routing messages 39
  - run channel 110, 429
  - run channel initiator 118
  - runmqchi command
    - AIX, OS/2, HP-UX, Sun Solaris, and Windows NT 118
  - RUNMQCHI command 119
  - RUNMQCHL command 119
  - RUNMQLSR command 119
- S**
- save option 373
- scenarios, problem determination 611
- SCF configuration file, example 292
- SCYDATA attribute 93
- SCYEXIT attribute 92
- security
  - context 91
  - exit 12
  - exit name 92
  - exit program 507
  - exit program, overview 506
  - exit user data 93
  - levels for exit programs 121
  - message channel agent 91
  - objects
    - Digital OpenVMS 120
- security (*continued*)
  - objects (*continued*)
    - MQSeries for AS/400 447
    - OS/2 120
    - Tandem NSK 120
    - UNIX systems 120
    - Windows NT 120
  - process 91
  - SecurityExit field 563
  - SecurityUserData field 565
  - segregating messages 15
  - selected menu-bar choice 357
  - selecting a channel 430
    - OS/390 using CICS 354
  - send
    - exit 12
    - exit name 93
    - exit program 512
    - message 57
  - send exit user data 93
  - SENDDATA attribute 93
  - sender channel 7
  - sender channel definition
    - example
      - Digital OpenVMS 308, 309
      - OS/2 308, 309
      - OS/390 347, 348
      - OS/400 479, 481
      - Tandem NSK 308, 309
      - UNIX systems 308, 309
      - Windows NT 308, 309
    - overview 5
  - sender channel settings
    - details 376
  - SENDEXIT attribute 93
  - SendExit field 564
  - SendExitPtr field 576
  - SendExitsDefined field 575
  - sending
    - messages 17, 58
    - on DECnet Phase IV 286
    - on SPX
      - OS/2 131
      - Windows NT 131
    - on TCP
      - Digital OpenVMS 278
      - OS/2 124
      - Windows NT 124
  - sending on TCP 191
  - SendUserData field 566
  - SendUserDataPtr field 576
  - SeqNumberWrap field 564
  - sequence number wrap 93
  - sequence numbering 54
  - sequence numbers 59
    - reset, OS/390 332
  - sequential delivery 93
  - sequential retrieval of messages 55
  - SEQWRAP attribute 93
  - server
    - AT&T GIS SNA 246
    - channel 7
    - channel settings panel, detail 378
  - server-connection channel 7
  - service, class of 47
  - SessionId field 607

- setting up
  - CICS communication for OS/390 381
- communication
  - Digital OpenVMS systems 277
  - OS/2 123
  - OS/400 449
  - Tandem NSK 289
  - UNIX systems 191
  - Windows NT 123
- sharing channels 14
- short retry
  - count 93
  - interval 94
- ShortConnectionName field 561
- ShortRetryCount field 562
- ShortRetryInterval field 562
- SHORTRTY attribute 93
- SHORTTMR attribute 94
- side object
  - OS/400 452
- SINIX and DC/OSx configuration files 311
- SNA 4
  - configuration, Digital OpenVMS 281
  - listener process, ending 284
  - products, in example configurations 98
  - Server 127
- SNAPLUS2 223
- SNAX communications examples 292
- SO\_KEEPALIVE
  - Digital OpenVMS 279
  - OS/2 126
  - OS/400 450
  - UNIX systems 194, 279
  - Windows NT 126
- softcopy books 662
- source queue manager 3
- splitting messages 59
- SPX 4
  - connection
    - MQSeries for OS/2 Warp 160
    - MQSeries for Windows NT 182
    - OS/2 123
  - example configurations 98
  - KEEPALIVE, OS/2 132, 162
  - products, in example configurations 98
  - stanza of qm.ini file 637
  - Windows NT 123
- stanza file 73
- start
  - channel 61
    - Digital OpenVMS 110
    - OS/2 110
    - OS/390 330
    - Tandem NSK 110
    - UNIX systems 110
    - Windows NT 110
  - channel initiator, OS/390 327
  - channel listener, OS/390 329
  - DQM panels, OS/390 using CICS 352
  - option 357, 437
- STARTING channel state 62
- startup dialog 506
- state, channel 62

- status
  - display channel 110
  - work with channel 432
- status, channel 59
- status panels 364, 437
- stop
  - channel 67, 115, 359
  - channel, OS/390 334
  - channel, OS/390 using CICS 385
  - channel initiator, OS/390 328
  - channel listener, OS/390 329
  - controlled 439
  - immediate 439
  - option 359
  - quiesce 115, 361
- stop channel initiator 118
- stop force 116
- stop immediate 360
- STOPPED channel state 62, 65
- stopped channels, restarting 69
- STOPPING channel state 62
- STRMQM command 109
- StrucId field
  - MQCXP structure 591
  - MQTXP structure 605
  - MQXWD structure 609
- StrucLength field 574
- structures
  - MQCD 556
  - MQCXP 591
  - MQTXP 605
  - MQXWD 609
- SunLink Version 9.1 261
- switching channels 617
- synchronization queue, OS/390 343
- synchronizing channels 361, 506
- syncpoint introduction 80
- SYSTEM.CHANNEL.INITQ queue
  - Digital OpenVMS 305
  - OS/2 305
  - OS/390 321, 343
  - OS/400 477
  - UNIX systems 305
  - Windows NT 305
- SYSTEM.CHANNEL.REPLY.INFO queue 321, 343
- SYSTEM.CHANNEL.SYNCQ 343
- system extension 121, 448
- system extensions
  - user-exit programs
    - Digital OpenVMS 121
    - MQSeries for AS/400 448
    - OS/2 121
    - Tandem NSK 121
    - UNIX systems 121
    - Windows NT 121
- system identifier, target 94

**T**

- target queue manager 3
- target system identifier 94
- TCP
  - channels, Tandem NSK 291
  - connection
    - listener backlog 125, 132, 193, 340, 450
    - MQSeries for AIX 209

- TCP (*continued*)
  - connection (*continued*)
    - MQSeries for AS/400 469
    - MQSeries for AT&T GIS UNIX 251
    - MQSeries for Digital OpenVMS 277
    - MQSeries for DIGITAL UNIX (Compaq Tru64 UNIX) 215
    - MQSeries for HP-UX 237
    - MQSeries for OS/2 Warp 158
    - MQSeries for OS/390 404
    - MQSeries for Sun Solaris 271
    - MQSeries for Tandem NSK 289
    - MQSeries for VSE/ESA 490
    - MQSeries for Windows NT 181
  - example configurations 98
  - listener backlog option 125, 132, 193, 340, 450
  - OpenEdition MVS sockets 344
  - products, in example configurations 98
  - stanza of qm.ini file 637
  - stanza of QMIni file 637
- TCP connection
  - setting up
    - OS/2 123
    - OS/390 339
    - UNIX systems 191
    - Windows NT 123
- TCP/IP 4
- TCP/IP communications example 303
- TCP/IP KEEPALIVE 66
  - Digital OpenVMS 279
  - UNIX systems 279
- TCP KEEPALIVE
  - OS/2 126
  - OS/400 450
  - UNIX systems 194
  - Windows NT 126
- TCPware 280
- terminology used in this book 645
- test channel, OS/390 331
- testing connections, lookback testing 56
- time-out 84
- TPNAME and TPPATH
  - OS/2 126
  - OS/400 451
  - UNIX systems 194
  - Windows NT 126
- TPNAME attribute 86
- TpName field 562
- transaction
  - identifier, CICS 94
  - program name 86
- transactions
  - CEDA 383
  - CKMC 352
  - CKSG 384
- transmission header
  - alias
    - definition 26
    - message exit program 515
    - message-retry exit program 516
    - queue name 36
- transmission protocol 95

- transmission queue
  - definition of 10
  - example definition
    - Digital OpenVMS 307
    - OS/2 307
    - OS/390 347
    - OS/400 479
    - Tandem NSK 307
    - UNIX systems 307
    - Windows NT 307
  - multiple message channels
    - Digital OpenVMS 120
    - MQSeries for AS/400 447
    - OS/2 120
    - OS/390 using CICS 384
    - Tandem NSK 120
    - UNIX systems 120
    - Windows NT 120
  - overflow 612
  - selecting 42
  - sharing 14
- transmission queue definition
  - example
    - Digital OpenVMS 308
    - OS/2 308
    - OS/390 348
    - OS/400 481
    - Tandem NSK 308
    - UNIX systems 308
    - Windows NT 308
- transmission queue name 94
- transport-retry exit
  - introduction 12
- transport-retry exit program 517
- transport type 95
  - supported 4
- TransportType field
  - MQCD structure 560
  - MQTXP structure 606
- triggered channels, problem
  - determination 614
- triggering
  - channels 20
    - Digital OpenVMS 117
    - MQSeries for AS/400 443
    - OS/2 117
    - OS/390 343
    - OS/390 using CICS 358
    - Tandem NSK 117
    - UNIX systems 117
    - Windows NT 117
  - MCAs
    - OS/390 using CICS 384
- TRPTYPE attribute 95
- trusted applications 12, 121
- type, bind 121
- types of channel 81

## U

- UCD products, in example
  - configurations 98
- UDP
  - example configurations 98
- UDP connection
  - MQSeries for AIX 209
  - setting up
    - UNIX systems 191

- UDP transport-retry exit,
  - configuring 517
- undeliverable message 71
- user exit
  - data definition files 544
  - MQCXP structure 591
  - MQTXP structure 605
  - MQXWD structure 609
- user-exit
  - programs 616
- user-exit programs 505, 542
  - problem determination 616
  - security levels 121
  - system extension
    - Digital OpenVMS 121
    - OS/2 121
    - OS/400 448
    - Tandem NSK 121
    - UNIX systems 121
    - Windows NT 121
  - writing and compiling 518
- user ID 95, 121
- user identifier service 121
- user-written MCAs 75
- USERDATA parameter 358, 384, 443
  - OS/390 343
- USERID attribute 95
- UserIdentifier field 566

## V

- validation
  - checks 612
  - command 71
  - of user IDs 514
  - panel data 71
- values supplied by MQSeries for
  - AS/400 435
- values supplied by OS/390 using
  - CICS 369, 372
- Version field
  - MQCD structure 558
  - MQCXP structure 592
  - MQTXP structure 605
  - MQXWD structure 609
- view
  - activities
    - OS/390 using CICS 371
  - menu-bar choice 371
- VSAM 351

## W

- WaitDesc parameter 553
- WAITING channel state 62
- wide-band links 31
- Windows 3.1 client, channel-exit
  - programs 524
- Windows 95 and Windows 98 client,
  - channel-exit programs 524
- Windows Help 662
- work-with-channel choices 434
- work with channel status 432
- work with status 437
- worksheet
  - MQSeries for AIX configuration 197

worksheet (*continued*)

- MQSeries for AS/400
  - configuration 459
- MQSeries for AT&T GIS UNIX
  - configuration 243
- MQSeries for HP-UX
  - configuration 219
- MQSeries for OS/2 Warp
  - configuration 137
- MQSeries for OS/390
  - configuration 396
- MQSeries for Sun Solaris
  - configuration 257
- MQSeries for Windows NT
  - configuration 170
- writing your own message channel
  - agents 75
  - WRKCLS command 457
  - WRKSBSD command 455

## X

- XMITQ attribute 94
- XmitQName field 561

---

## Sending your comments to IBM

If you especially like or dislike anything about this book, please use one of the methods listed below to send your comments to IBM.

Feel free to comment on what you regard as specific errors or omissions, and on the accuracy, organization, subject matter, or completeness of this book.

Please limit your comments to the information in this book and the way in which the information is presented.

To request additional publications, or to ask questions or make comments about the functions of IBM products or systems, you should talk to your IBM representative or to your IBM authorized remarketer.

When you send comments to IBM, you grant IBM a nonexclusive right to use or distribute your comments in any way it believes appropriate, without incurring any obligation to you.

You can send your comments to IBM in any of the following ways:

- By mail, to this address:

Information Development Department (MP095)  
IBM United Kingdom Laboratories  
Hursley Park  
WINCHESTER,  
Hampshire  
United Kingdom

- By fax:
  - From outside the U.K., after your international access code use 44-1962-870229
  - From within the U.K., use 01962-870229
- Electronically, use the appropriate network ID:
  - IBM Mail Exchange: GBIBM2Q9 at IBMMAIL
  - IBMLink™ : HURSLEY(IDRCF)
  - Internet: idrcf@hursley.ibm.com

Whichever you use, ensure that you include:

- The publication number and title
- The topic to which your comment applies
- Your name and address/telephone number/fax number/network ID.



Printed in the United States of America  
on recycled paper containing 10%  
recovered post-consumer fiber.

SC33-1872-03



Spine information:



MQSeries®

MQSeries Intercommunication